

EMC TEST REPORT

No. 2104108STO-113

Electromagnetic disturbances

EQUIPMENT UNDER TEST

Equipment: Radio Unit
Type/Model: RRUS 32A B66A
Product number: KRC 161 601/1
Product configuration: ESS
Manufacturer: Ericsson AB
Tested by request of: Ericsson AB

SUMMARY

Referring to the emission limit, and the operating mode during the tests specified in this report, the equipment complies with the radiated spurious emission requirements according to the following standards:

47 CFR Part 2, subpart J
47 CFR Part 27 Subpart C
RSS-GEN Issue 5 Amendment 1 + 2
RSS-139 Issue 3

For details, see clause 2 – 4.

Date of issue: August 31, 2021

Issued by:

Martin Erwe



Per Larsson

Approved by:

Matti Virkki

This report is for the exclusive use of Intertek's Client and is provided pursuant to the agreement between Intertek and its Client. Intertek's responsibility and liability are limited to the terms and conditions of the agreement. Intertek assumes no liability to any party, other than to the Client in accordance with the agreement, for any loss, expense or damage occasioned by the use of this report. Only the Client is authorized to permit copying or distribution of this report and then only in its entirety. Any use of the Intertek name or one of its marks for the sale or advertisement of the tested material, product or service must first be approved in writing by Intertek. The observations and test results in this report are relevant only to the sample tested. This report by itself does not imply that the material, product, or service is or has ever been under an Intertek certification program.

Revision History

Test report number	Date	Description	Changes
2104108STO-113	August 31, 2021	First release	

CONTENTS

	Page
1. Client Information	4
2. Equipment under test (EUT).....	4
2.1 Identification of the EUT	4
2.2 Description of the EUT	5
2.3 Test setup- block diagram.....	5
2.4 External cables connected to the EUT.....	5
2.5 Auxiliary equipment (AE).....	6
2.6 Decision rule	6
3. Test Specifications	7
3.1 Standards	7
3.2 Additions, deviations and exclusions from standards and accreditation	7
3.3 Test site.....	7
3.4 Mode of operation during the test	8
3.5 Compliance	8
4. Test Summary	9
5. Radiated rf Emission in the frequency-range 30 MHz – 1 – 18 – 26.5 GHz	10
5.1 Test set-up and test procedure	10
5.2 Measurement uncertainty.....	10
5.3 Test results, 30 – 1000 MHz, Configuration 1.....	12
5.4 Test results, 30 – 1000 MHz, Configuration 2.....	13
5.5 Test results, 30 – 1000 MHz, Configuration 3.....	14
5.6 Test results, 30 – 1000 MHz, Configuration 4.....	15
5.7 Test results, 1 – 18 GHz Configuration 1.....	16
5.8 Test results, 1 – 18 GHz Configuration 2.....	17
5.9 Test results, 1 – 18 GHz Configuration 3.....	18
5.10 Test results, 1 – 18 GHz Configuration 4.....	19
5.11 Test results, 18 – 26.5 GHz, Configuration 1.....	20
5.12 Test results, 18 – 26.5 GHz, Configuration 2.....	21
5.13 Test results, 18 – 26.5 GHz, Configuration 3.....	22
5.14 Test results, 18 – 26.5 GHz, Configuration 4.....	23
5.16 Test equipment	24
7. EUT Software	25
8. EUT Hardware list	25

1. CLIENT INFORMATION

The EUT has been tested by request of

Company: Ericsson AB
 164 80 Stockholm
 Sweden

Name of contact: Tomas Sjökvist
 BNEW DNEW RA RPSE1 IVC
 Phone +46709862008

Client observer: Per Sjöberg & Tomas Johansson

2. EQUIPMENT UNDER TEST (EUT)

2.1 Identification of the EUT

Equipment	Radio Unit
Type/Model	RRUS 32A B66A
Product number:	KRC 161 601/1
Product configuration:	ESS
Brand name	Ericsson
Manufacturer	Ericsson
Rating	-48VDC max 20A
Class	III

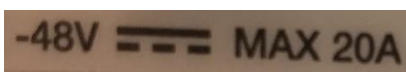
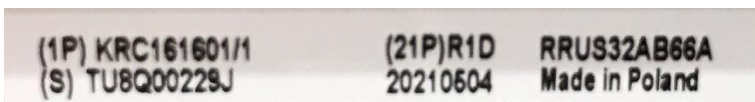

EUT with markings

2.2 Description of the EUT

The test object is a RRUS 32A B66A and it is a part of a Radio Base station supporting GSM, WCDMA, LTE, NR, ESS and NB IoT technologies. It is designed to provide mobile users with a connection to a mobile network.

In this case, the RRUS 32A B66A has been hosted in an AIR 32 B2A B66aA. It has been tested in an ESS; Ericsson Shared Spectrum, configuration.

2.3 Test setup- block diagram

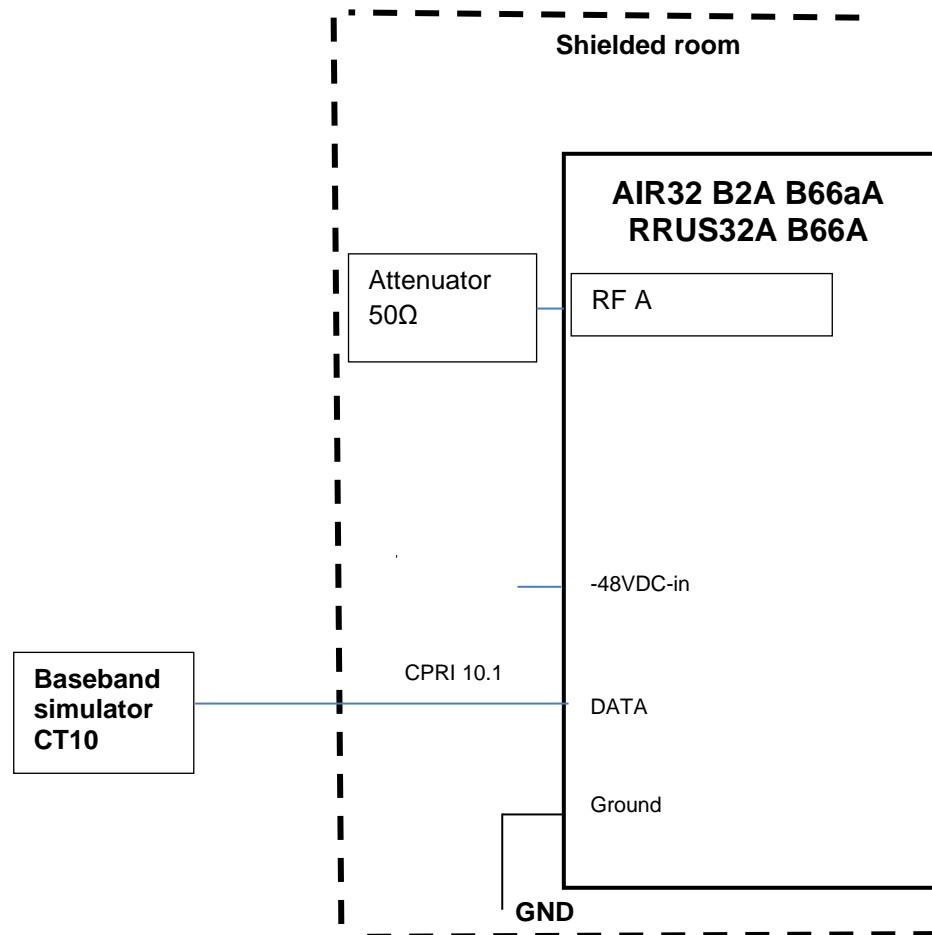

Block diagram of EUT during the tests

2.4 External cables connected to the EUT

Port	Type	Length [m]	Specifications
DC in	DC power	3.0	Two-core
Earth	Ground	3.0	Single wire, 35mm ²
Data	RPM2531610/20M	20.0	Optical fibre cable
Antenna A	RF cable	3.0	Coaxial

2.5 Auxiliary equipment (AE)

Auxiliary equipment is equipment needed for correct operation of the EUT, but not included as part of the testing and evaluation of the EUT.

Equipment	Type / Model	Manufacturer	Serial no.
Computer	EliteBook	HP	BAMS-1001233323
Baseband simulator CT10	LPC 102 487/1	Ericsson	BAMS-10014666801
SFP module	RDH 102 65/31	Delta	1836091A0500880
Power supply (for EUT)	SGA 60/250	Sorensen	BAMS-1000234866

2.6 Decision rule

The statements of conformity are reported as:

Passed – When the measured values are within the specified limits.

Failed – When one or more measures values are outside the specified limits.

3. TEST SPECIFICATIONS

3.1 Standards

Requirements:

- FCC 47 CFR Part 2 Subpart J (2019)
- FCC 47 CFR Part 27 Subpart C (2019)
- RSS-GEN Issue 5 Amendment 1 + 2 (2021)
- RSS-139 Issue 3 (2015)

Test methods:

- KDB971168 D01 Power Meas License Digital Systems v03r01
- ANSI C63.26: 2015: American National Standard for Compliance Testing of Transmitters Used in Licensed Radio Services

3.2 Additions, deviations and exclusions from standards and accreditation

The following deviation from standards and accreditation was made: only the radiated spurious emission performed according to manufacturer’s request.

3.3 Test site

Measurements were performed at:

Intertek Semko AB.
 Torshamnsgatan 43,
 P.O. Box 1103
 SE-164 22 Kista

Intertek Semko AB is a FCC listed test site with site registration number 90913
 Intertek Semko AB is a FCC accredited conformity assessment body with designation number SE0002
 Intertek Semko AB is an Industry Canada listed test facility with IC assigned code 2042G
 Intertek Semko AB is an Innovation, Science and Economic Development Canada recognized wireless device testing laboratory with CAB identifier SE0003

Measurement chambers

Measurement Chamber	Type of chamber	IC Site filing #
5 m SAC chamber	Semi-anechoic 5 m	2042G-3

3.4 Mode of operation during the test

The EUT was tested with -53 V DC, 8 A.

Radio Configuration

Transmission band B66A: Downlink (DL): 2110-2180 MHz

ESS

The test object was transmitting test model ESS, Ericsson Shared Spectrum, where the carrier is NR and LTE combined.

One configuration with NR performed according to FR1-TM1.1 as defined in ETSI TS 138 141/ 3GPP TS 38.141-1.

The following configurations were tested:

1. 40% NR and 60% LTE, middle channel
2. 10% NR and 90% LTE, middle channel
3. 90% NR and 10% LTE, middle channel
4. NR 3GPP test model, middle channel

1 carrier in all configurations

The radio was activated for maximum transmit power of 30 W. See below table for detailed radio configurations of the radio unit.

Configura- tion No.	Carrier No.	Channel BW (MHz)	RF power (W/MHz)	Test Model	Carrier Frequency (DL)	
1	1	10	30	ESS 40/60	2145	429000
2	1	10	30	ESS 10/90	2145	429000
3	1	10	30	ESS 90/10	2145	429000
4	1	10	30	NR-FR1-TM1.1	2145	429000

3.5 Compliance

The EUT shall comply with the emission limit as listed below

Field strength of spurious emissions

CFR47 §2.1053 and §27.53(l)(1)

RSS-GEN 4.6.1

RSS-139 6.6

The power of any emission outside the licensee's authorized bandwidth shall not exceed -13 dBm/MHz

4. TEST SUMMARY

The results in this report apply only to sample tested:

Standard	Description	Result
	Emission	
CFR47 §27.53(l)(1) RSS-139 6.6	Field strength of spurious radiation	PASS
	The EUT complies with the limit.	

5. RADIATED RF EMISSION IN THE FREQUENCY-RANGE 30 MHZ – 1 – 18 – 26.5 GHZ

Date of test	Temperature [°C]	Relative Humidity [%]
July 1, 2021	23	48
July 2, 2021	23	47
July 5, 2021	23	63
July 6, 2021	23	66

5.1 Test set-up and test procedure

The test method is in accordance with ANSI C63.26 clause 5.5.

The EUT was set up to emit maximum disturbances.

30 – 1000 MHz: The EUT was placed on a pole 0.8 m above the turntable which is part of the reference ground plane.

> 1000 MHz: The EUT was placed on a pole 1.5 m above the turntable which is part of the reference ground plane. Absorbers were placed on the floor between the EUT and measurement antenna.

Overview sweeps were performed with the measurement receiver in max-hold mode and the peak and average detectors activated in the frequency-range.

The EUT is continuously rotated 360°.

Test set-up:	30 MHz – 26.5 GHz	
Test receiver set-up:		
Preview test:	Peak	RBW 1 MHz, VBW 3 MHz
	Average	RBW 1 MHz, VBW 3 MHz
Final test:	RMS,	RBW 1 MHz, VBW 3 MHz
Measuring distance:	3 m	
Measuring angle:	0 – 359°	
EUT height above ground plane:	0.8 m	1.5 m
Antenna	30 – 1000 MHz	1 – 26.5 GHz
Type:	Bilog	Horn
Antenna tilt:	Not Activated	Activated
Height above ground plane:	1 – 4 m	
Polarisation:	Vertical and Horizontal	

$$E[\text{dB}\mu\text{V}/\text{m}] = \text{Analyser reading} [\text{dB}\mu\text{V}] + \text{Antenna factor} [1/\text{m}] - \text{Amplifier gain} [\text{dB}] + \text{Cable loss} [\text{dB}]$$

$$\text{EIRP} [\text{dBm}] = E[\text{dB}\mu\text{V}/\text{m}] + 20\log[3] - 104.8$$

5.2 Measurement uncertainty

Measurement uncertainty for radiated disturbance

Uncertainty for the frequency range 30 to 1000 MHz at 3 m	± 5.1 dB
Uncertainty for the frequency range 1.0 to 18 GHz at 3 m	± 4.5 dB
Uncertainty for the frequency range 18 to 26 GHz at 3 m	± 4.8 dB

Measurement uncertainty is calculated in accordance with CISPR 16-4-2: 2011.

The measurement uncertainty is given with a confidence of 95 %.



30 – 1000 MHz

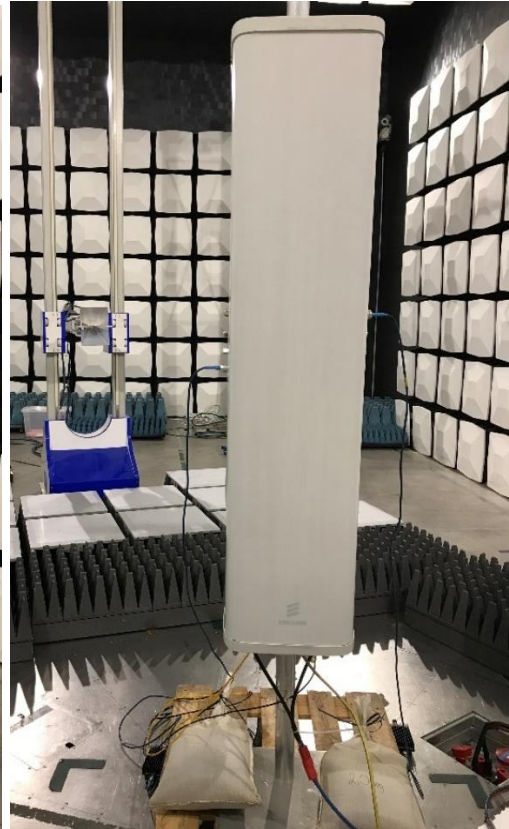

1 – 18 GHz

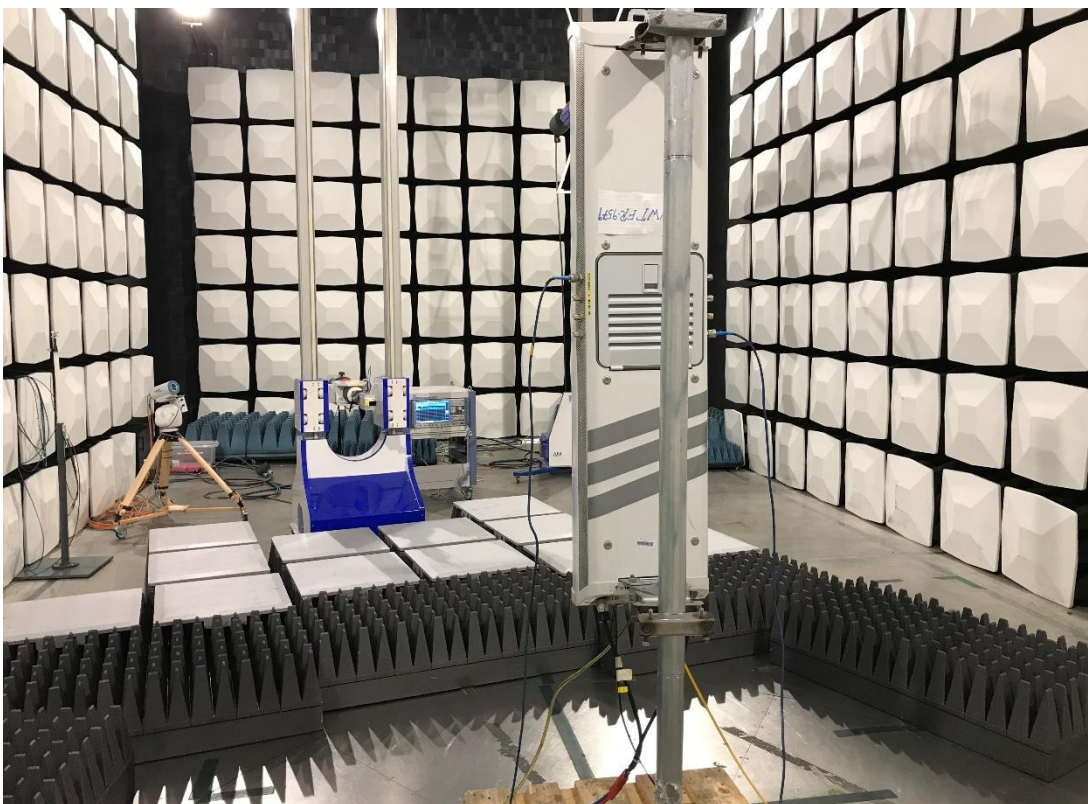

18 – 26,5 GHz

Photos of the test set up

5.3 Test results, 30 – 1000 MHz, Configuration 1

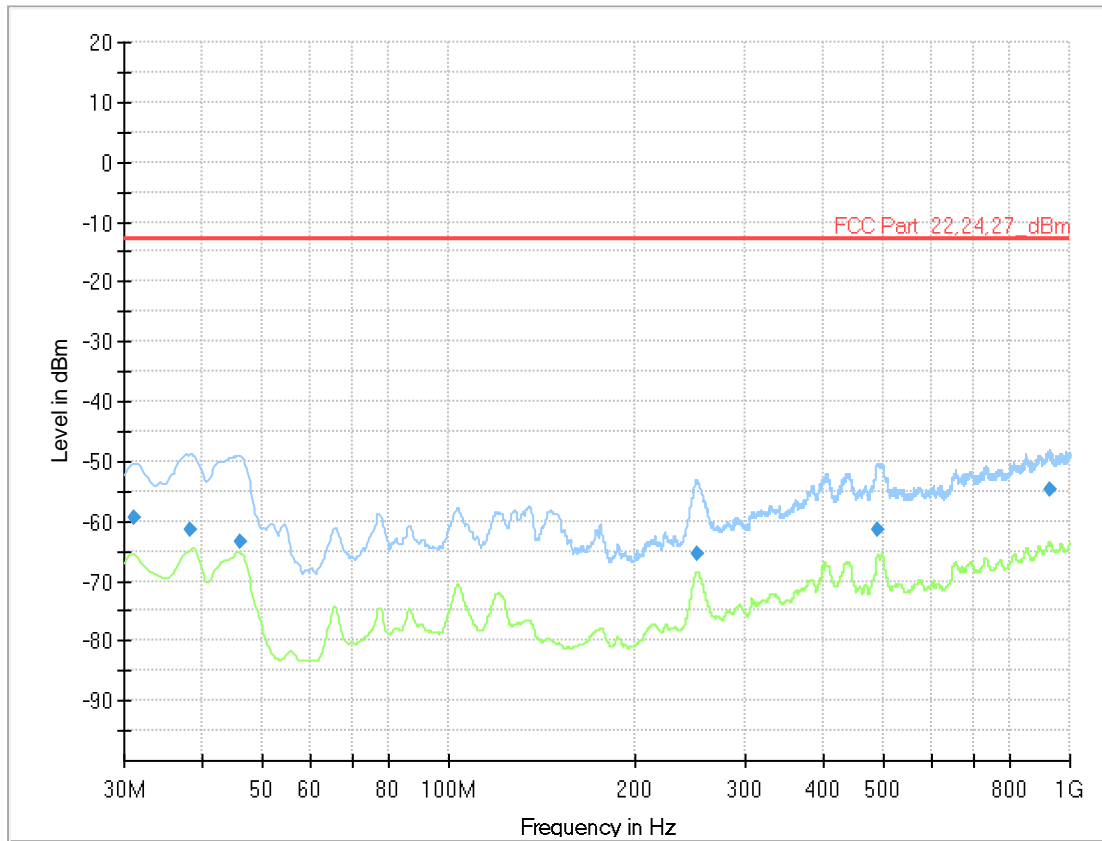

Diagram, Peak overview sweep, 30 – 1000 MHz at 3 m distance.

Limit line also valid for RSS-GEN Issue 5 Amendment 1 + 2 and RSS-139 Issue 3.

Measurement results

All measured disturbances have a margin of more than 20 dB to the limit.

5.4 Test results, 30 – 1000 MHz, Configuration 2

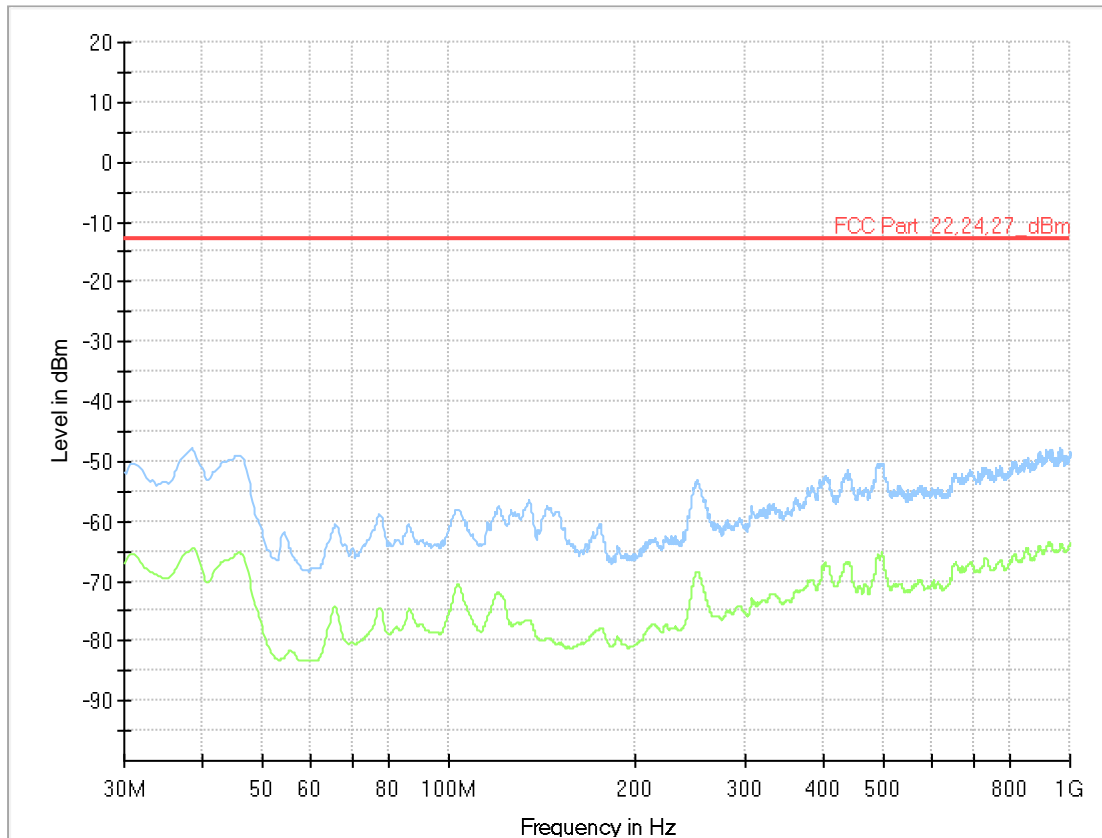

Diagram, Peak overview sweep, 30 – 1000 MHz at 3 m distance

Limit line also valid for RSS-GEN Issue 5 Amendment 1 + 2 and RSS-139 Issue 3.

Measurement results

All measured disturbances have a margin of more than 20 dB to the limit.

5.5 Test results, 30 – 1000 MHz, Configuration 3

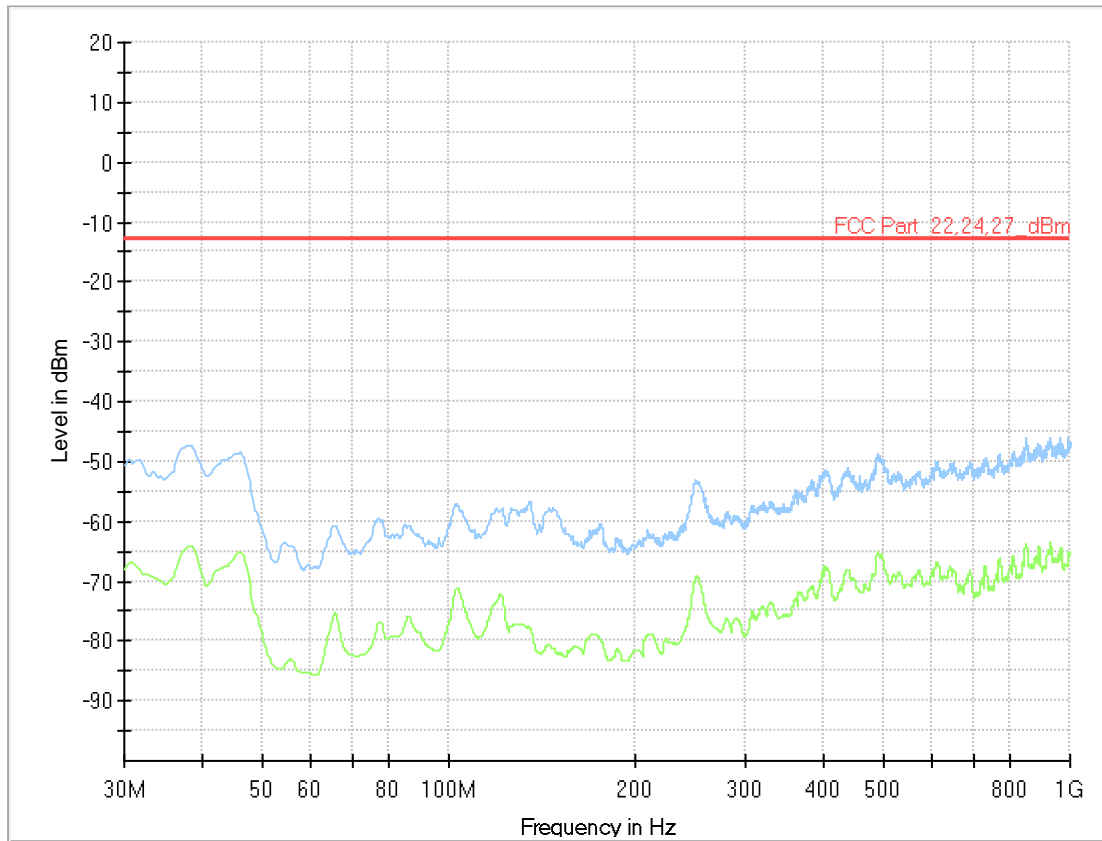

Diagram, Peak overview sweep, 30 – 1000 MHz at 3 m distance

Limit line also valid for RSS-GEN Issue 5 Amendment 1 + 2 and RSS-139 Issue 3.

Measurement results

All measured disturbances have a margin of more than 20 dB to the limit.

5.6 Test results, 30 – 1000 MHz, Configuration 4

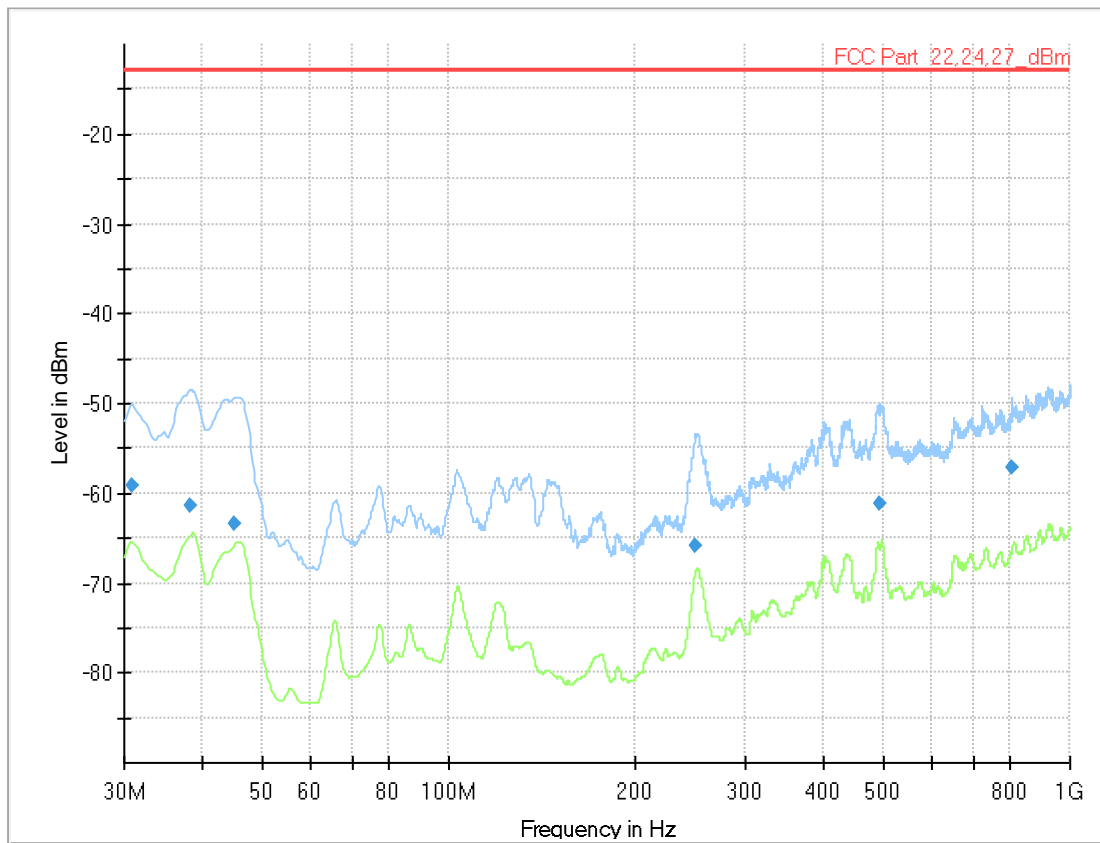

Diagram, Peak overview sweep, 30 – 1000 MHz at 3 m distance

Limit line also valid for RSS-GEN Issue 5 Amendment 1 + 2 and RSS-139 Issue 3.

Measurement results

All measured disturbances have a margin of more than 20 dB to the limit.

5.7 Test results, 1 – 18 GHz Configuration 1

Diagram, Peak and average overview sweep, 1 – 18 GHz at 3 m distance.

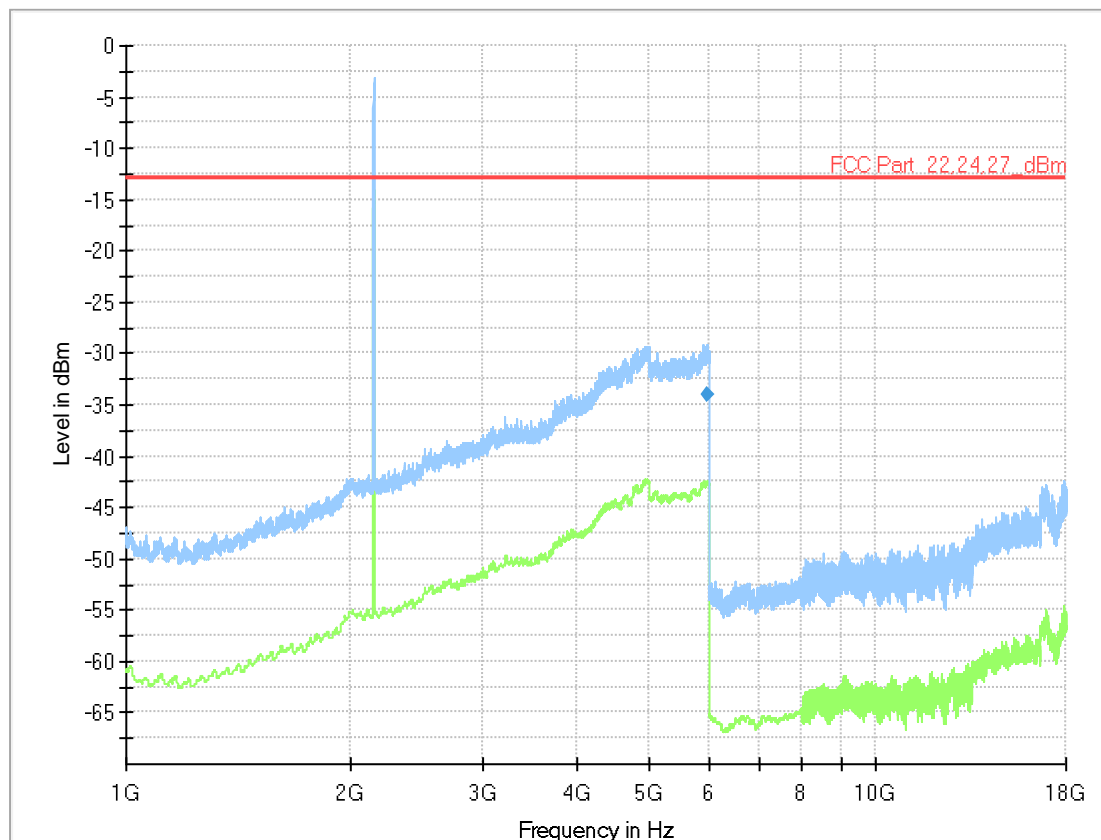

Measurement results, RMS

Limit line also valid for RSS-GEN Issue 5 Amendment 1 + 2 and RSS-139 Issue 3.

All measured disturbances have a margin of more than 20 dB to the limit.

No disturbances outside the transmission band B66A Downlink: 2110-2180 MHz.

5.8 Test results, 1 – 18 GHz Configuration 2

Diagram, Peak and average overview sweep, 1 – 18 GHz at 3 m distance.

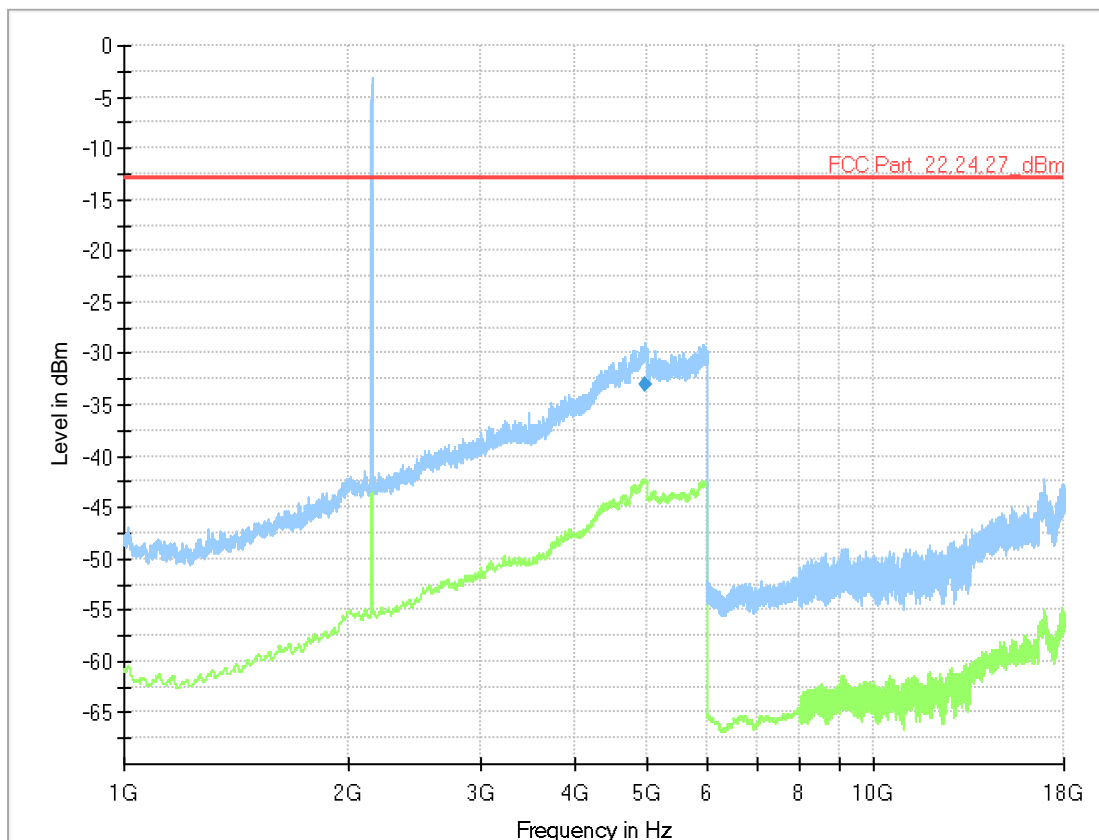

Measurement results, RMS

Limit line also valid for RSS-GEN Issue 5 Amendment 1 + 2 and RSS-139 Issue 3.

All measured disturbances have a margin of more than 20 dB to the limit.

No disturbances outside the transmission band B66A Downlink: 2110-2180 MHz.

5.9 Test results, 1 – 18 GHz Configuration 3

Diagram, Peak and average overview sweep, 1 – 18 GHz at 3 m distance.

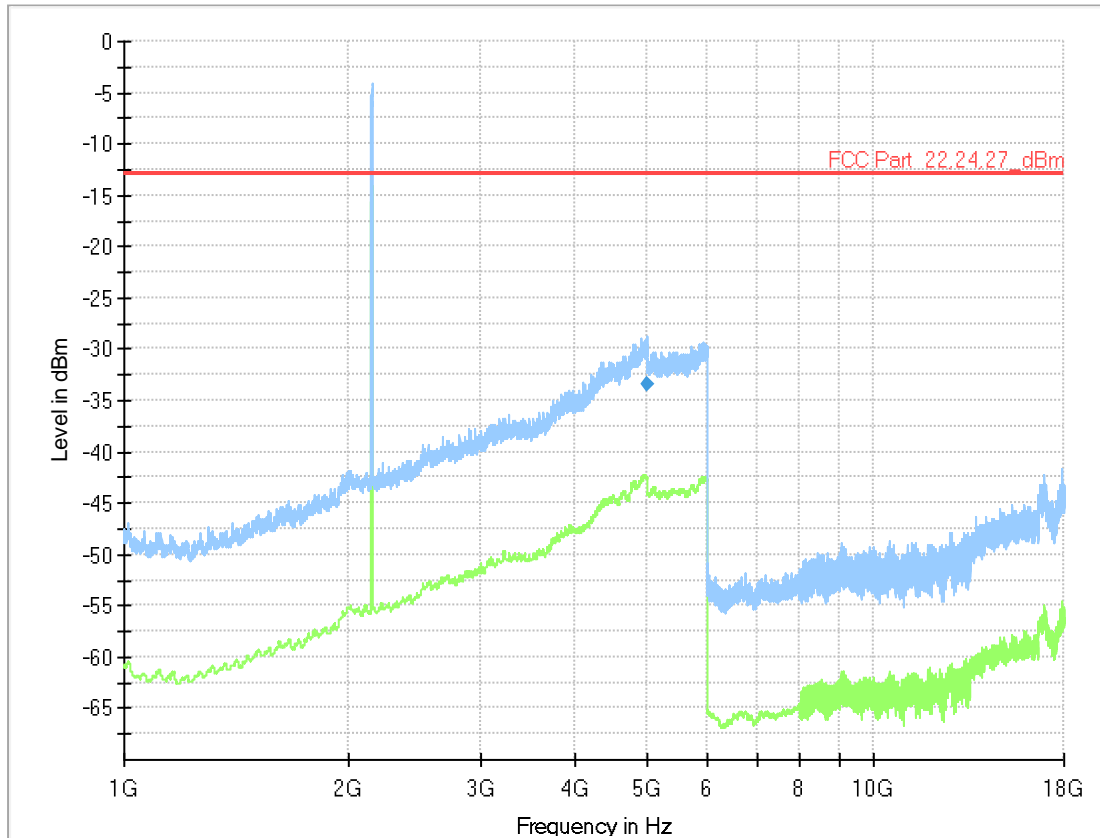

Measurement results, RMS

Limit line also valid for RSS-GEN Issue 5 Amendment 1 + 2 and RSS-139 Issue 3.

All measured disturbances have a margin of more than 20 dB to the limit.

No disturbances outside the transmission band B66A Downlink: 2110-2180 MHz.

5.10 Test results, 1 – 18 GHz Configuration 4

Diagram, Peak and average overview sweep, 1 – 18 GHz at 3 m distance.

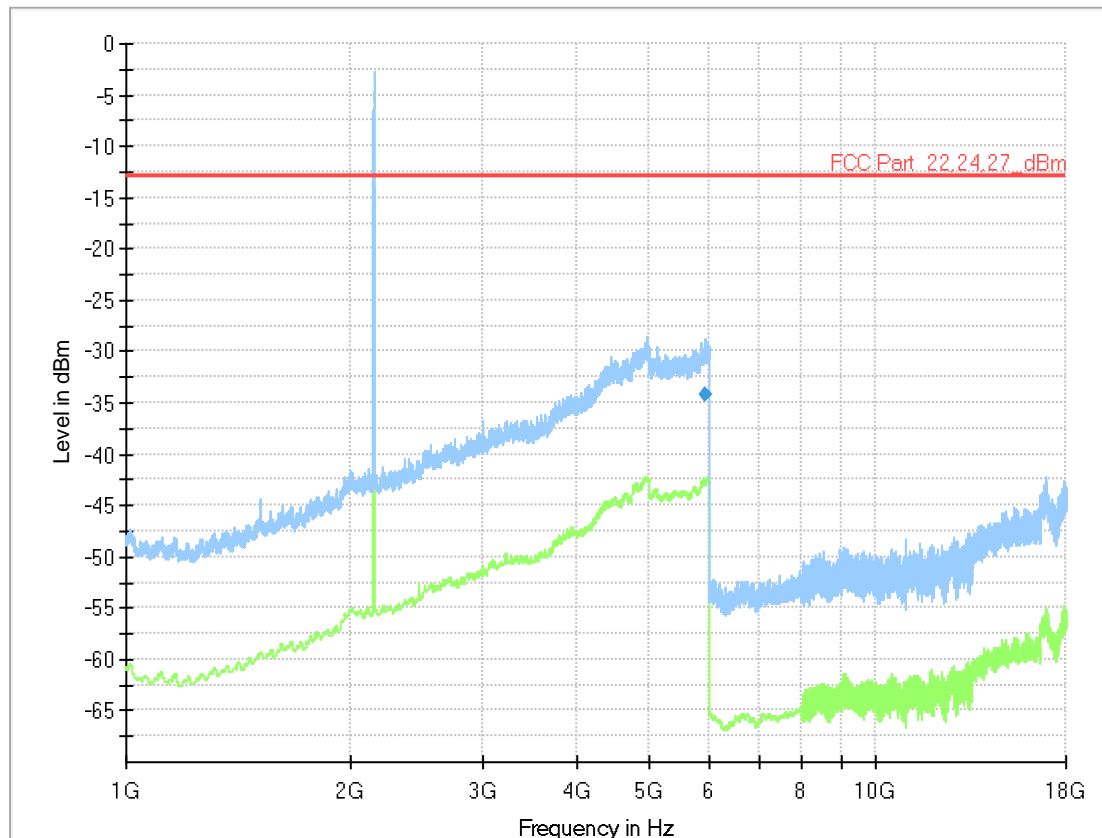

Middle channel

Measurement results, RMS

Limit line also valid for RSS-GEN Issue 5 Amendment 1 + 2 and RSS-139 Issue 3.

All measured disturbances have a margin of more than 20 dB to the limit.

No disturbances outside the transmission band B66A Downlink: 2110-2180 MHz.

5.11 Test results, 18 – 26.5 GHz, Configuration 1

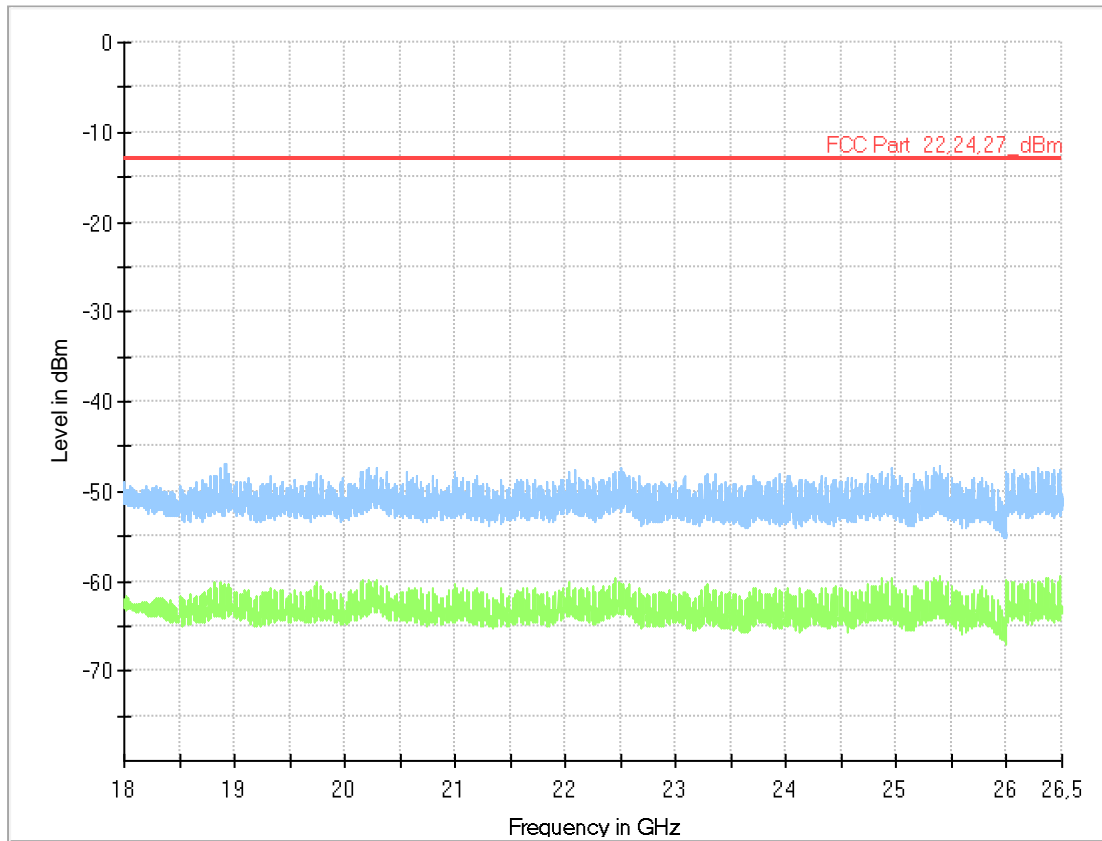

Diagram, Peak and average overview sweep, 18 – 26.5 GHz at 3 m distance.

Measurement results, RMS

Limit line also valid for RSS-GEN Issue 5 Amendment 1 + 2 and RSS-139 Issue 3.

All measured disturbances have a margin of more than 20 dB to the limit.

5.12 Test results, 18 – 26.5 GHz, Configuration 2

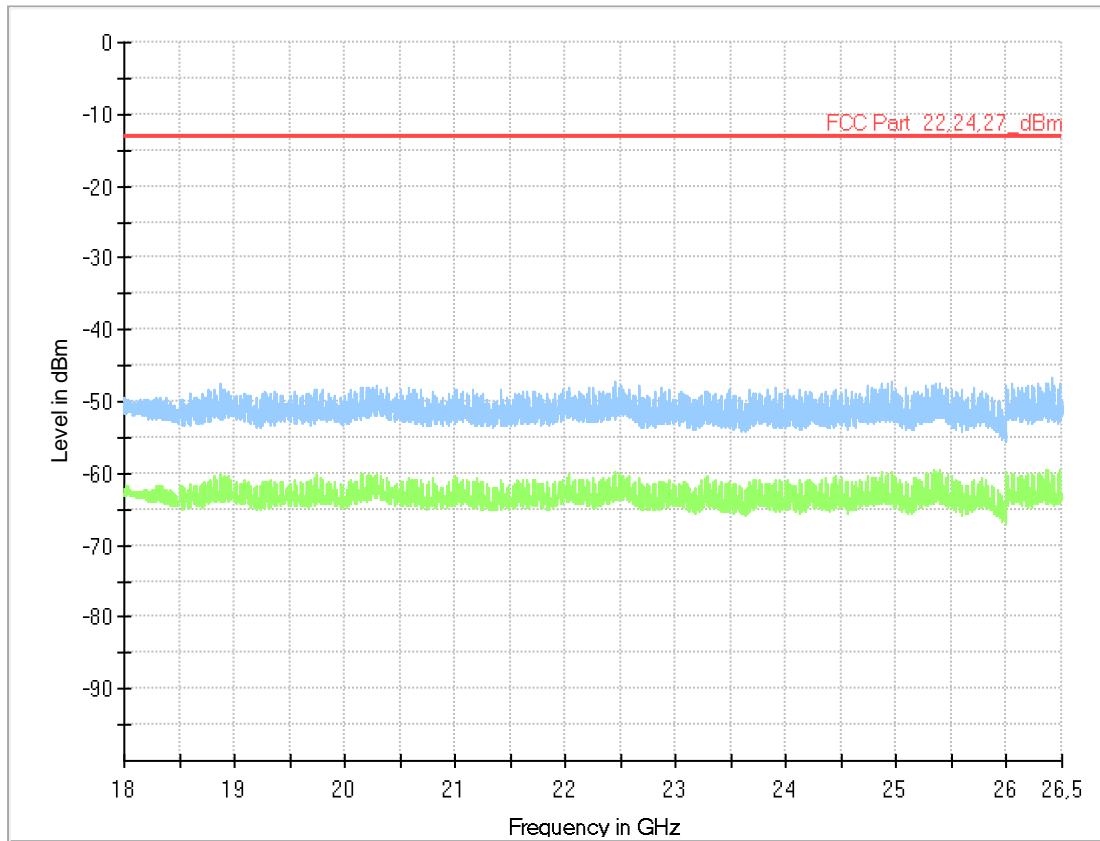

Diagram, Peak and average overview sweep, 18 – 26.5 GHz at 3 m distance.

Measurement results, RMS

Limit line also valid for RSS-GEN Issue 5 Amendment 1 + 2 and RSS-139 Issue 3.

All measured disturbances have a margin of more than 20 dB to the limit.

5.13 Test results, 18 – 26.5 GHz, Configuration 3

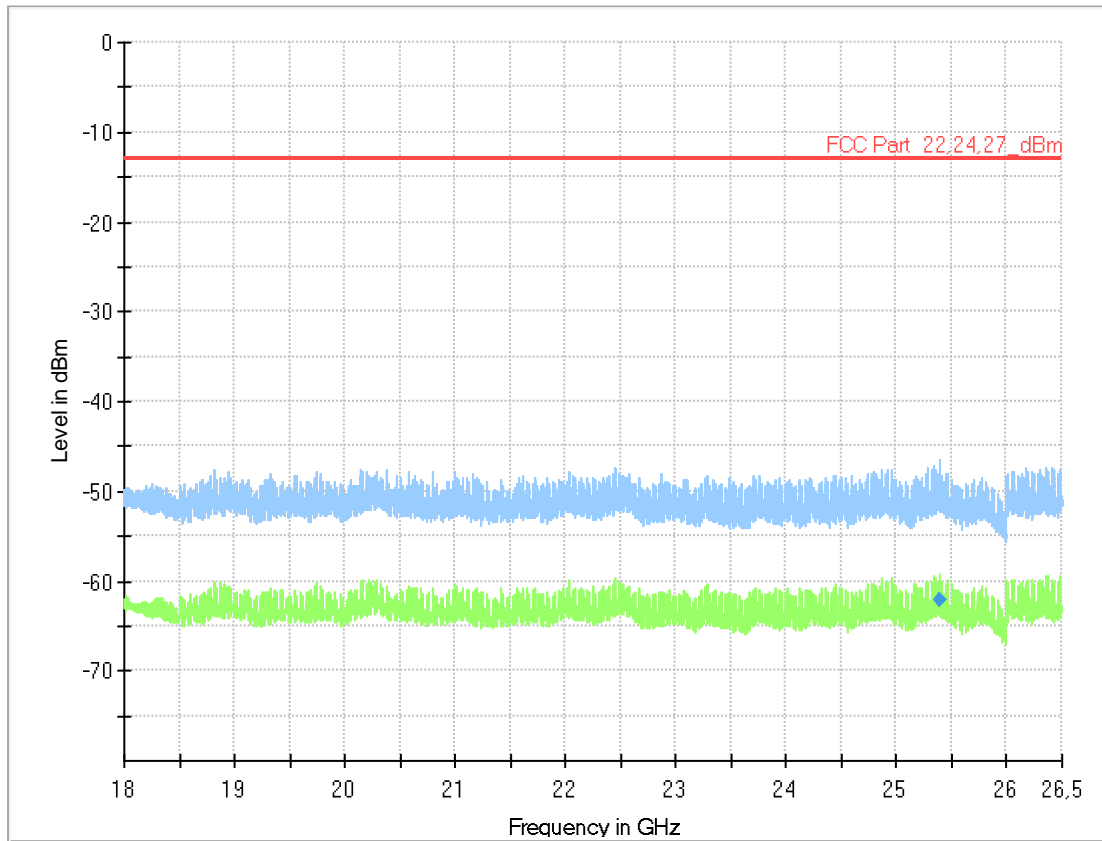

Diagram, Peak and average overview sweep, 18 – 26.5 GHz at 3 m distance

Measurement results, RMS

Limit line also valid for RSS-GEN Issue 5 Amendment 1 + 2 and RSS-139 Issue 3.

All measured disturbances have a margin of more than 20 dB to the limit.

5.14 Test results, 18 – 26.5 GHz, Configuration 4

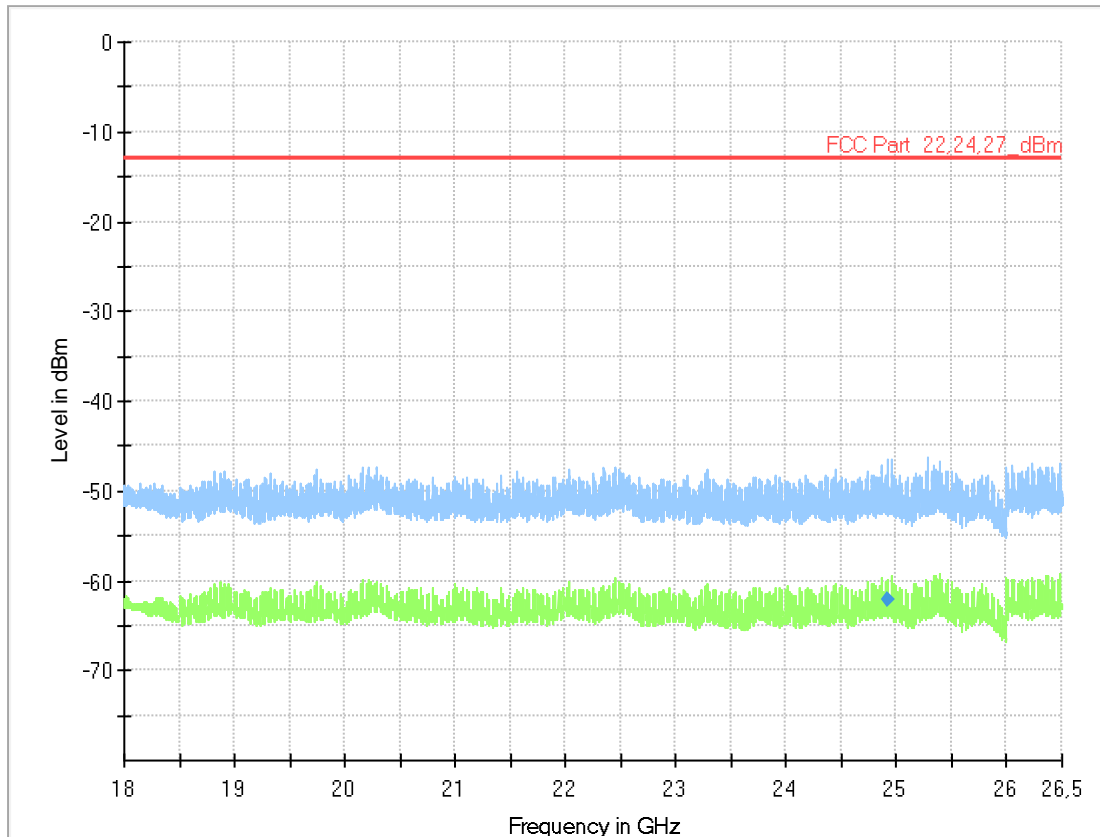

Diagram, Peak and average overview sweep, 18 – 26.5 GHz at 3 m distance.

Measurement results, RMS

Limit line also valid for RSS-GEN Issue 5 Amendment 1 + 2 and RSS-139 Issue 3.

All measured disturbances have a margin of more than 20 dB to the limit.

5.16 Test equipment

Equipment type	Manufacturer	Model	Inv. No.	Last Cal. date	Next Cal. date
Measurement software	Rohde & Schwarz	EMC32 – 10.50.40	--	--	--
Measurement Receiver	Rohde & Schwarz	ESW44	33950	2020-07-02	1 year
Measurement Receiver	Rohde & Schwarz	ESW44	34389	2021-05-08	1 year
Antenna	Rohde & Schwarz	HL562	32310	2019-05-06	3 years
Measurement cable	Schuner	SUCOFLEX 104	39003	2020-09-22	1 year
Preamplifier	Rohde & Schwarz	TS-PRE1	39150	2020-09-22	1 year
Measurement cable	Rosenberger	JFB293C	39141 & 39142	2020-12-15	1 year
Horn antenna	Rohde & Schwarz	HF907	32296	2019-04-01	3 years
Horn antenna with Preamplifier	Bonn	BLMA 1826-5A	31247	2020-08-26	3 years
Horn antenna with Preamplifier	Bonn	BLMA 2640-5A	31248	2020-08-27	3 years
Measurement cable	Megaphase	GC12-K1K1-315	39128	2020-08-06	1 year

7. EUT SOFTWARE

Software Radio: CXP 901 3268/12 R82CM

8. EUT HARDWARE LIST

Product	Product No	R-State	Manufacturer	Serial Number
AIR32 B2A B66aA	KRD 901 146/1	R1A	Ericsson	D240248394
RRUS32A B66A	KRC 161 601/1	R1D	Ericsson	TU8Q00229J
SFP module	RDH 102 65/3	-	Delta	164309M08184