



Product Service

Choose certainty.
Add value.



Report On

FCC Testing of the
Ericsson Remote Radio Unit LTE KRC 161 592/1 and KRC 161 592/2
Radio 2217 B26D (859-880 MHz) Base Station configuration in
accordance with FCC CFR 47 Part 2, FCC CFR 47 Part 22, and
FCC CFR 47 Part 90

COMMERCIAL-IN-CONFIDENCE

FCC ID: TA8AKRC161592

PREPARED BY

Maggie Whiting
Key Account Manager

APPROVED BY

Matthew Russell
Authorised Signatory

DATED

29 September 2017

Document 75939974 Report 03 Issue 1

September 2017



CONTENTS

Section		Page No
1	REPORT INFORMATION	2
1.1	Report Details	3
1.2	Brief Summary of Results	4
1.3	Configuration Description	5
1.4	Declaration of Build Status	6
1.5	Product Information	7
1.6	Test Setup	8
1.7	Test Conditions	9
1.8	Deviation From The Standard	9
1.9	Modification Record	9
1.10	Test Location	9
2	TEST DETAILS	10
2.1	Maximum Peak Output Power and Peak to Average Ratio - Conducted	11
2.2	Occupied Bandwidth	15
2.3	Band Edge	18
2.4	Transmitter Spurious Emissions	22
3	TEST EQUIPMENT USED	26
3.1	Test Equipment Used	27
3.2	Measurement Uncertainty	29
4	ACCREDITATION, DISCLAIMERS AND COPYRIGHT	30
4.1	Accreditation, Disclaimers and Copyright	31
ANNEX A	Module Lists	A.2



Product Service

SECTION 1

REPORT INFORMATION



Product Service

1.1 REPORT DETAILS

The information contained in this report is intended to show verification of the Ericsson Radio 2217 B26D KRC 161 592/1 and KRC 161 592/2 to the requirements of FCC CFR 47 Parts 22 and 90.

Testing was carried out in support of an application for Grant of Radio 2217 B26D KRC 161 592/1 and KRC 161 592/2 in LTE mode.

Manufacturer	Ericsson AB
Address	Isafjordsgatan 10 SE-164 80 Stockholm 16480 Sweden
Product Name	Radio 2217 B26D
Product Number	KRC 161 592/1
Serial Number(s)	SD825975510
Software Version	CXP 901 7316/2 R67GK
Hardware Version	R1E
Non-Test Variant	KRC 161 592/2
Test Specification/Issue/Date	FCC CFR 47 Part 2: 2016 FCC CFR 47 Part 22: 2016 FCC CFR 47 Part 90: 2016
Start of Test	26 September 2017
Finish of Test	28 September 2017
Name of Engineer(s)	Mohamed Toubella
Related Document(s)	KDB 971168 D01 v02r02 KDB 662911 D01 v02r01



Product Service

1.2 BRIEF SUMMARY OF RESULTS

A brief summary of results for each configuration, in accordance with FCC CFR 47 Part 2, FCC CFR 47 Part 22 and FCC 47 CFR Part 90 is shown below.

Section	Specification Clause			Test Description	Result
	FCC CFR 47 Part 2	FCC CFR 47 Part 22	FCC CFR 47 Part 90		
2.1	2.1046	22.913 (a)	90.635	Maximum Peak Output Power and Peak to Average Ratio - Conducted	Pass
2.2	2.1049	22.917 (b)	-	Occupied Bandwidth	Pass
2.3	2.1051	22.905 / 22.917	90.691	Band Edge	Pass
2.4	2.1051	22.917	90.691	Transmitter Spurious Emissions	Pass

NOTE: Only a limited subset of testing was performed to cover 15 MHz bandwidth where the channel is configured to overlap between the 859 MHz to 869 MHz and 869 MHz to 880 MHz bands. Further test results can be found in test reports 75939974 Report 01 and 75939974 Report 02.



1.3 CONFIGURATION DESCRIPTION

Test Configuration	Configuration Code	Carrier(s)	Configuration Description
Config A	L-MIMO-SC	1C	LTE MIMO, Single Carrier
Config B	L-MIMO-MC	2C	LTE MIMO, Multi Carrier x2
Config C	L-MIMO-MC1	3C	LTE MIMO, Multi Carrier x3

The Radio 2217 B26D KRC 161 592/1 and KRC 161 592/2 supports Test Models E-TM1.1, E-TM3.2 and E-TM3.1 at 800 MHz defined in 3GPP TS 36.141. Test Model E-TM1.1 is used to represent QPSK modulation only, and Test Model E-TM3.2 is used to represent 16QAM modulation, and Test Model E-TM3.1 is used to represent 64QAM modulation. The product also supports ETM3.1a for 256QAM.

The settings below were deemed representative for all traffic scenarios when settings with different modulations, channel bandwidths, number of carriers and RF configurations have been tested to find the worst case setting. The setting below were used for all measurements if not otherwise noted:

LTE:

MIMO mode single carrier: E-TM1.1

MIMO mode multi carrier (x2): E-TM1.1

MIMO mode multi carrier (x3): E-TM1.1

The Maximum Output Power was tested on both TX/RX output connector RF A and RF B, all other TX measurements were performed on the combined TX/RX output connector RF A of the EUT as the representative ports.

The complete testing was performed with the EUT transmitting at maximum RF power Unless otherwise stated.



Product Service

1.4 DECLARATION OF BUILD STATUS

Manufacturing Description	Remote Radio Unit		
Manufacturer	Ericsson AB		
Product Name	Radio 2217 B26D		
Product Number	KRC 161 592/1 KRC 161 592/2		
RU Name	Radio 2217 B26D		
RU Number	KRC 161 592/1 KRC 161 592/2		
DU Name	NA		
DU Number	NA		
Band Number	B26D		
RAT	LTE		
Number of carriers	Maximum 3 carriers per port		
Base station class	Wide Area		
Maximum rated output power(s)	Maximum 46.0dBm (40W) per port for all modes except maximum 43.0dBm (20W) per carrier per port for LTE 1.4MHz		
Duplex Mode	FDD		
Frequency Band	B26D (800MHz)		
Modulation type(s)	LTE: QPSK, 16QAM, 64QAM, 256QAM		
Channel Bandwidth(s)	LTE: 1.4MHz, 3MHz, 5MHz, 10MHz, 15MHz		
Transmit diversity	Each transmitter path is declared to be equivalent		
Receive diversity	Each receiver path is declared to be equivalent		
MIMO	Each transmitter path is declared to be equivalent Each receiver path is declared to be equivalent		
ITU designation or class of emission	LTE: 1M40F9W, 3M00F9W, 5M00F9W, 10M0F9W, 15M0F9W		
Hardware Version	R1E		
Software Version	CXP 901 7316/2 R67GK		
FCC ID	TA8AKRC161592		
ISED Model Name			
Highest Internally Generated Frequency	1030.1 MHz		
Environment temperature range(s)	Minimum -40 °C	Nominal	Maximum +55 °C
AC Power source	Voltage Range(s)		
	Minimum VAC	Nominal VAC	Maximum VAC
DC Power source	Yes		
	Voltage Range(s)		
	Minimum VDC	Nominal VDC	Maximum VDC
	-36.0	-48 V	-58.5 V
Options	Type	Model	

Signature

Date

D of B S Serial No

No responsibility will be accepted by TÜV SÜD Product Service UK Limited as to the accuracy of the information declared in this document by the manufacturer.

1.5 PRODUCT INFORMATION

1.5.1 Technical Description

The Equipment Under Test (EUT) Radio 2217 B26D KRC 161 592/1 and KRC 161 592/2 is an Ericsson Remote Radio Unit working in the public mobile service 800 MHz band which provides communication connections to 800 MHz network. The Radio 2217 B26D KRC 161 592/1 and KRC 161 592/2 operates from a -48V DC supply.

The Equipment Under Test (EUT) is shown in the photograph below. A full technical description can be found in the Manufacturer's documentation.

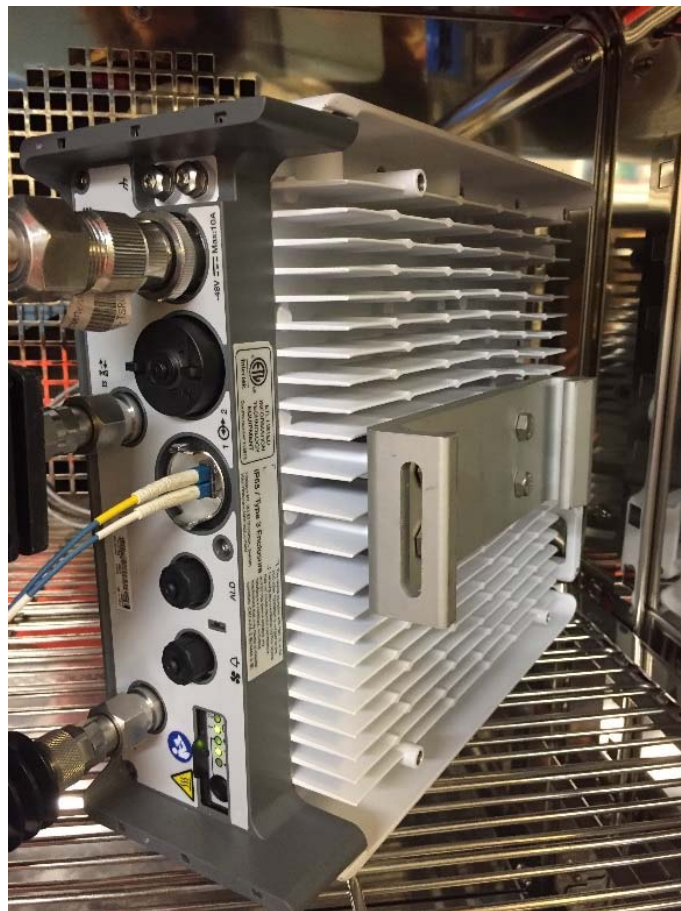

Equipment Under Test

1.6 TEST SETUP

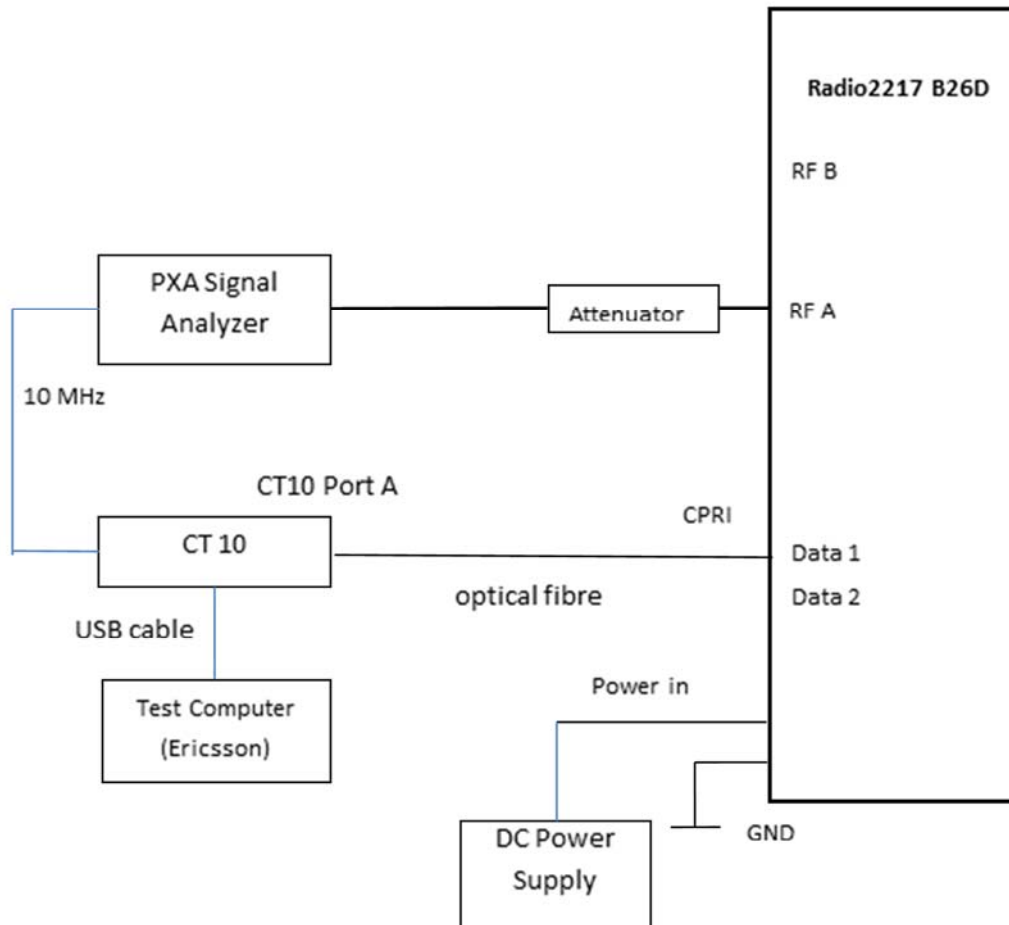

Block diagram of Radio 2217 B26D with cables and auxiliary equipment for Conducted measurements.



Product Service

1.7 TEST CONDITIONS

For all tests the EUT was set up in accordance with the relevant test standard and to represent typical operating conditions. Tests were applied with the EUT situated in a shielded enclosure, test laboratories or a chamber as appropriate.

The EUT was powered from a -48V DC supply.

FCC Measurement Facility Registration Number
90987 Octagon House, Fareham Test Laboratory

1.8 DEVIATION FROM THE STANDARD

No deviations from the applicable test standards or test plan were made during testing.

1.9 MODIFICATION RECORD

No modifications were made to the EUT during testing.

1.10 TEST LOCATION

TÜV SÜD Product Service conducted the following tests at our Fareham Test Laboratory.

Test Name	Name of Engineer(s)
Maximum Peak Output Power and Peak to Average Ratio - Conducted	Mohamed Toubella
Occupied Bandwidth	Mohamed Toubella
Band Edge	Mohamed Toubella
Transmitter Spurious Emissions	Mohamed Toubella



Product Service

SECTION 2

TEST DETAILS



Product Service

2.1 MAXIMUM PEAK OUTPUT POWER AND PEAK TO AVERAGE RATIO - CONDUCTED

2.1.1 Specification Reference

FCC CFR 47 Part 2, Clause 2.1046
FCC CFR 47 Part 22, Clause 22.913 (a)
FCC CFR 47 Part 90, Clause 90.635

2.1.2 Date of Test and Modification State

28 September 2017 - Modification State 0

2.1.3 Test Equipment Used

The major items of test equipment used for the above tests are identified in Section 3.1.

2.1.4 Environmental Conditions

Ambient Temperature	21.9°C
Relative Humidity	55.3%

2.1.5 Test Method

All measurements were made in accordance with FCC KDB 971168 D01, clause 5.2.1 and summed in accordance with FCC KDB 662911 D01. Peak to Average measurements were performed in accordance with FCC KDB 971168 D01, clause 5.7.1.

Measurements were performed with a Spectrum Analyser using the Band Power measurement function. The detector was set to RMS with an RBW of at least 1 % of the carrier bandwidth and a VBW of at least 3 times the RBW. The integration bandwidth was configured to cover only the portion of the band being tested - 859 - 869 MHz for Part 90 and 869 - 880 MHz for Part 22. Using a sweep time of auto, measurements were performed over 200 samples, with the average measurement recorded. By summing the power in the 859 – 869 MHz and 869 – 880 MHz, the declared maximum power is achieved.

Due to Average measurements being recorded, an additional Peak to Average measurement was made in all single carrier configurations. This was achieved using the CCDF function of the Spectrum Analyser with the RBW being set to a value wider than the largest signal being measured – in this case – 15 MHz.

For PSD, measurements were performed in both parts of the bands - 859 - 869 MHz and 869 - 880 MHz. The maximum of the two average PSD's was recorded and also a measurement of the total 15 MHz power. The results are recorded in the tables below.



Product Service

2.1.6 Test Results

Configuration A

Maximum Output Power 46 dBm

Antenna	LTE Modulation	LTE Carrier Bandwidth	Peak to Average Ratio (PAR) / Output Power		
			Channel Position B		
			PAR (dB)	Total Average Power (15 MHz BW)	
dBm	dBm/MHz				
A	QPSK	15.0 MHz	7.28	46.23	35.87

Antenna	LTE Modulation	LTE Carrier Bandwidth	Peak to Average Ratio (PAR) / Output Power		
			Channel Position B		
			PAR (dB)	859 – 869 MHz Band Average Power	
dBm	dBm/MHz				
A	QPSK	15.0 MHz	-	44.68	35.76

Antenna	LTE Modulation	LTE Carrier Bandwidth	Peak to Average Ratio (PAR) / Output Power		
			Channel Position B		
			PAR (dB)	869 – 880 MHz Band Average Power	
dBm	dBm/MHz				
A	QPSK	15.0 MHz	-	40.32	35.78

Antenna A - LTE Modulation QPSK - LTE Carrier Bandwidth 15.0 MHz - Channel Position B

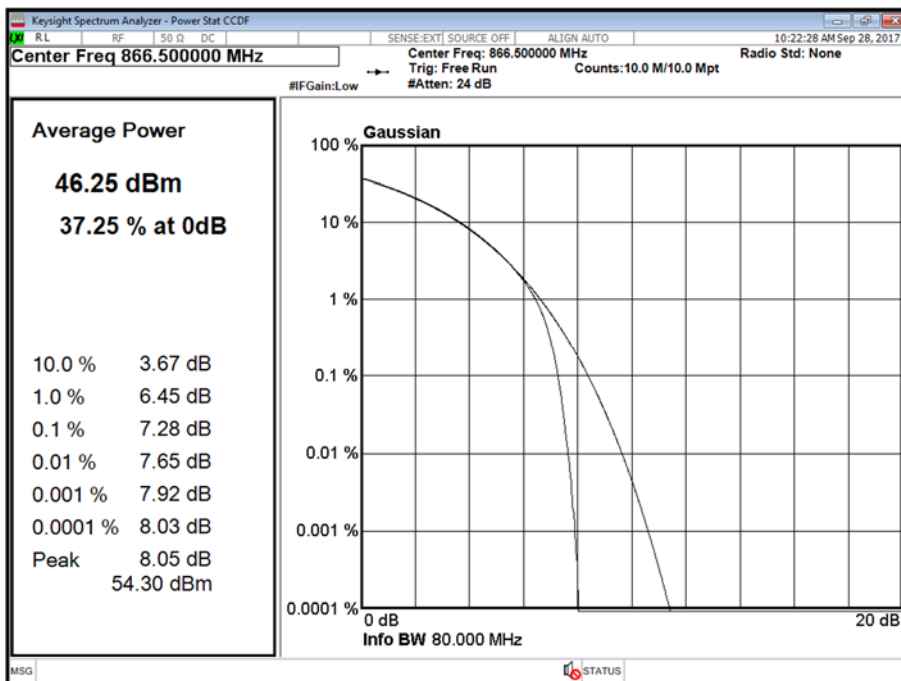



Product Service

Configuration A

Maximum Output Power 46 dBm

Antenna	LTE Modulation	LTE Carrier Bandwidth	Peak to Average Ratio (PAR) / Output Power		
			Channel Position T		
			PAR (dB)	Average Power (15 MHz BW)	
dBm	dBm/MHz				
A	QPSK	15.0 MHz	7.20	46.20	35.70

Antenna	LTE Modulation	LTE Carrier Bandwidth	Peak to Average Ratio (PAR) / Output Power		
			Channel Position T		
			PAR (dB)	859 – 869 MHz Band Average Power	
dBm	dBm/MHz				
A	QPSK	15.0 MHz	-	40.20	35.56

Antenna	LTE Modulation	LTE Carrier Bandwidth	Peak to Average Ratio (PAR) / Output Power		
			Channel Position T		
			PAR (dB)	869 – 880 MHz Band Average Power	
dBm	dBm/MHz				
A	QPSK	15.0 MHz	-	45.18	46.48

Antenna A - LTE Modulation QPSK - LTE Carrier Bandwidth 15.0 MHz - Channel Position T

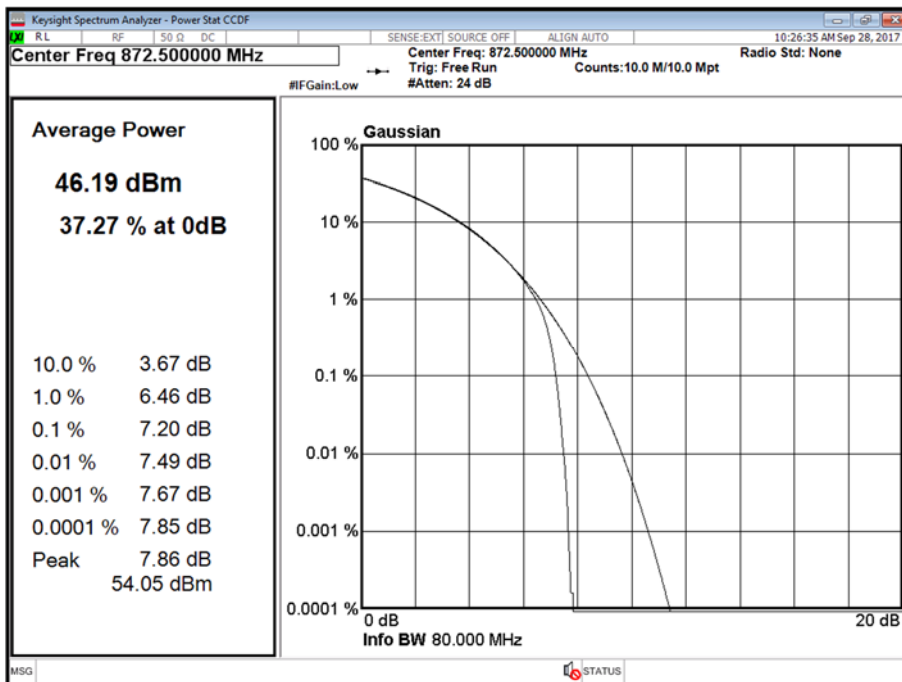



Product Service

Limit	
Peak Power	Part 22: ≤ 500 W or $\leq +57$ dBm Part 90: ≤ 65 W* or 48.13 dBm
Peak to Average Ratio	13 dB

*Note: Part 90 test limit is based on the worst case antenna height of 1,372m. A review of the measurement results should be undertaken by the installer to determine the maximum antenna gain and height which is usable.



2.2 OCCUPIED BANDWIDTH

2.2.1 Specification Reference

FCC CFR 47 Part 2, Clause 2.1049
 FCC CFR 47 Part 22, Clause 22.917 (b)

2.2.2 Date of Test and Modification State

26 September 2017 - Modification State 0

2.2.3 Test Equipment Used

The major items of test equipment used for the above tests are identified in Section 3.1.

2.2.4 Environmental Conditions

Ambient Temperature 22.5°C
 Relative Humidity 55.2%

2.2.5 Test Method

All measurements were made in accordance with FCC KDB 971168 D01 Clause 4.2.

The Spectrum Analyser RBW was configured to be at least 1% of the channel bandwidth of the carrier to be measured.

For 26dB Bandwidth, in accordance with KDB 971168 D01, a peak detector and a trace setting of Max Hold were used. The trace was allowed to stabilise. Using the Spectrum Analyser function, the 26 dB measurement result was obtained.

2.2.6 Test Results

Configuration A

Maximum Output Power 46 dBm

Antenna	LTE Modulation	LTE Carrier Bandwidth	Result (kHz)					
			Channel Position B		Channel Position M		Channel Position T	
			Occupied Bandwidth	-26 dB Bandwidth	Occupied Bandwidth	-26 dB Bandwidth	Occupied Bandwidth	-26 dB Bandwidth
A	QPSK	15.0 MHz	13412.86	14296.95	13397.05	14394.88	13439.30	14378.11



Product Service

Antenna A - LTE Modulation QPSK - LTE Carrier Bandwidth 15.0 MHz - Channel Position B

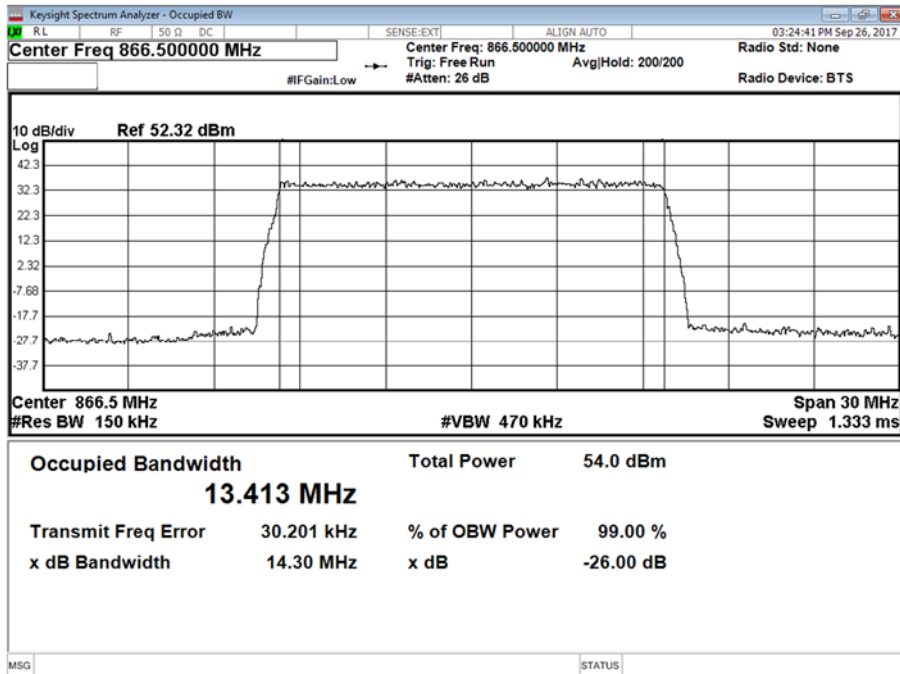

Antenna A - LTE Modulation QPSK - LTE Carrier Bandwidth 15.0 MHz - Channel Position M

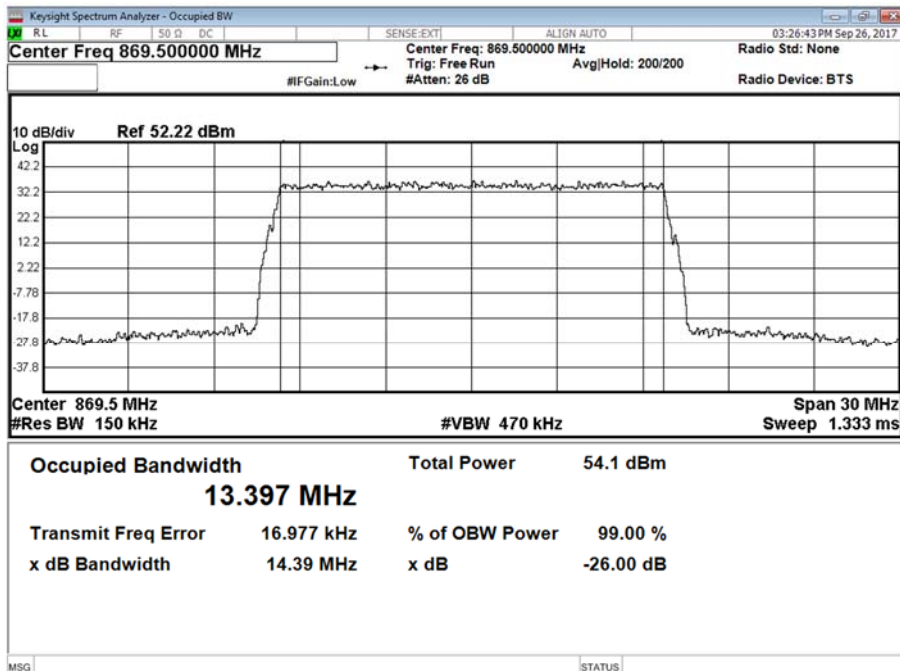



Product Service

Antenna A - LTE Modulation QPSK - LTE Carrier Bandwidth 15.0 MHz - Channel Position T

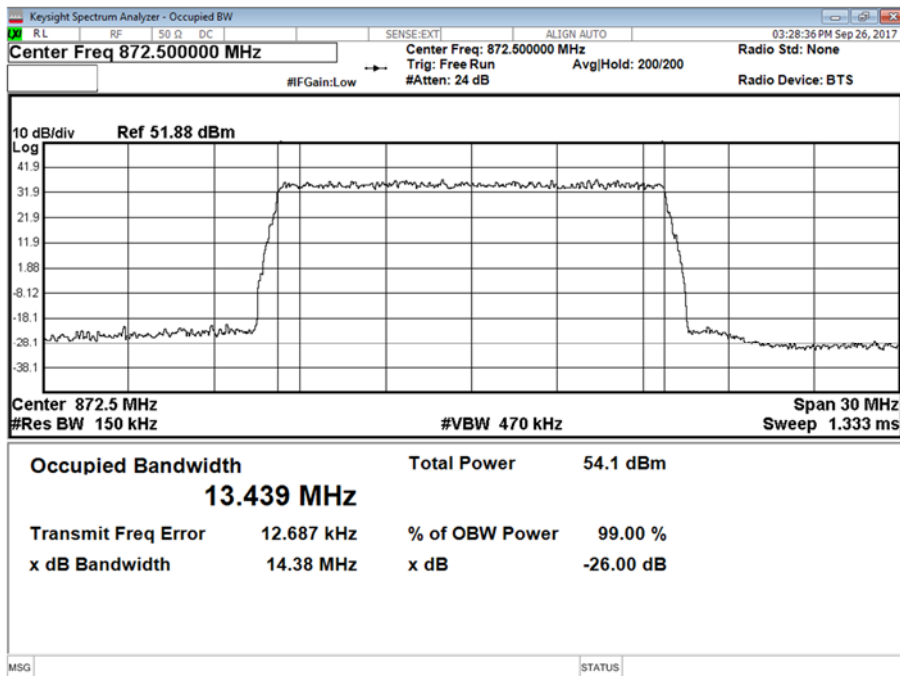



Product Service

2.3 BAND EDGE

2.3.1 Specification Reference

FCC CFR 47 Part 2, Clause 2.1051
FCC CFR 47 Part 22, Clause 22.905
FCC CFR 47 Part 90, Clause 90.691

2.3.2 Date of Test and Modification State

26 September 2017 - Modification State 0

2.3.3 Test Equipment Used

The major items of test equipment used for the above tests are identified in Section 3.1.

2.3.4 Environmental Conditions

Ambient Temperature	22.5°C
Relative Humidity	55.2%

2.3.5 Test Method

All measurements were made in accordance with FCC KDB 971168 D01 Clause 6.

The EUT was connected to a Spectrum Analyser via 40 dB of attenuation. The path loss between the EUT and the Spectrum Analyser was measured using a Network Analyser. The measured path loss was entered as a Reference Level Offset in the Spectrum Analyser. All measurements were made using a RBW of <1 % of the 26 dB Bandwidth in conjunction with the Band Power function of the Spectrum Analyser. The Band Power span was configured to be at least 1 % of the 26 dB Bandwidth and was positioned in the 1 MHz region above/below the band edge which gave the worst case result. The result was an integration of the power giving the result as a value which was at least 1 % of the 26 dB Bandwidth. The display line was set to the worst case accounting for 2 Port MIMO operation in accordance with KDB 662911 D01 . This equated to $43 + 10\log(P) - 10\log(2) = -16\text{dBm}$.

For measurements up to 37.5 kHz, (96.691(a)(1), from the band edge, measurement results were verified against the least stringent value of $50 + 10\log(P) - 10\log(2) = -23\text{ dBm}$ and were established as being compliant.

Additional plots were shown for measurements from 1 to 5 MHz away from the Band Edge. A RBW of 51 kHz was used with the limit line corrected by $10\log(100\text{ kHz} / 51\text{ kHz}) = 3\text{ dB}$. Therefore the limit line, accounting for MIMO and the reduced RBW, was set at -19 dBm.



Product Service

2.3.6 Test Results

Configuration A

Maximum Output Power 46 dBm

Antenna	LTE Modulation	LTE Carrier Bandwidth	Band Edge (MHz)	
			Channel Position B	Channel Position T
A	QPSK	15.0 MHz	866.5	872.5

Antenna A - LTE Modulation QPSK - LTE Carrier Bandwidth 15.0 MHz - Channel Position B

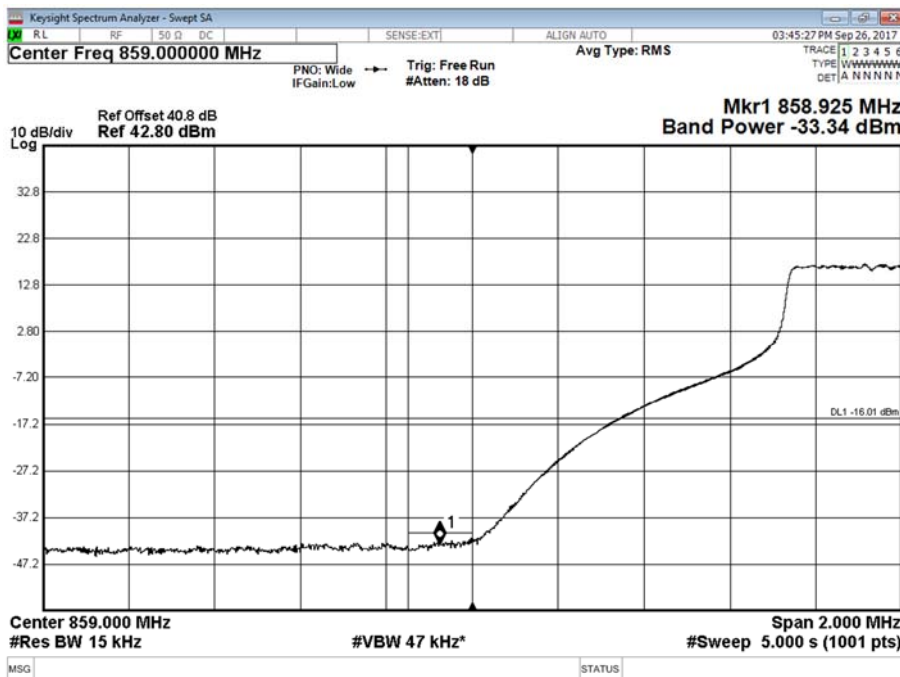



Product Service

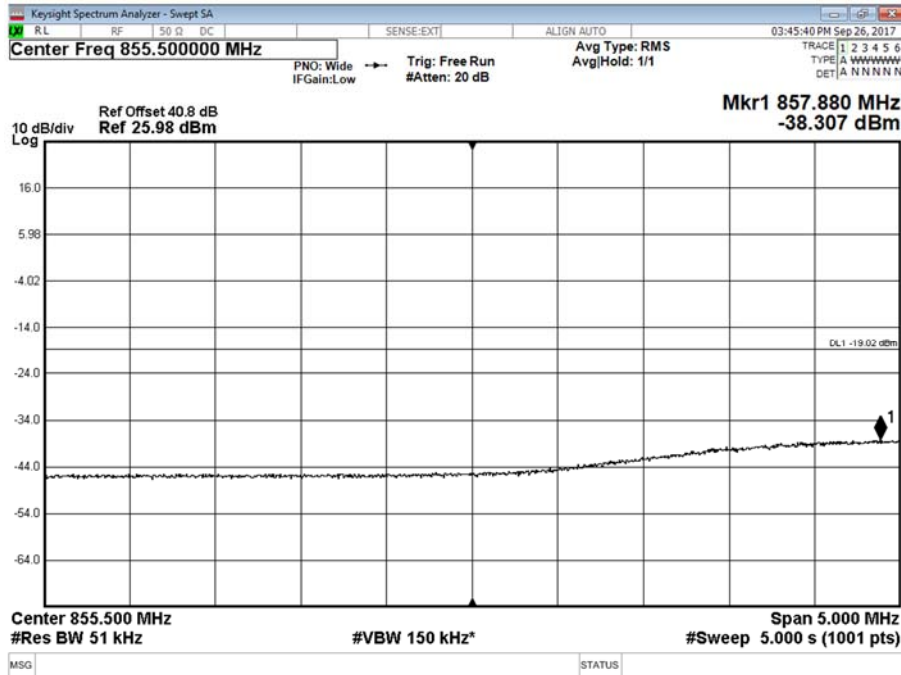

Antenna A - LTE Modulation QPSK - LTE Carrier Bandwidth 15.0 MHz - Channel Position T

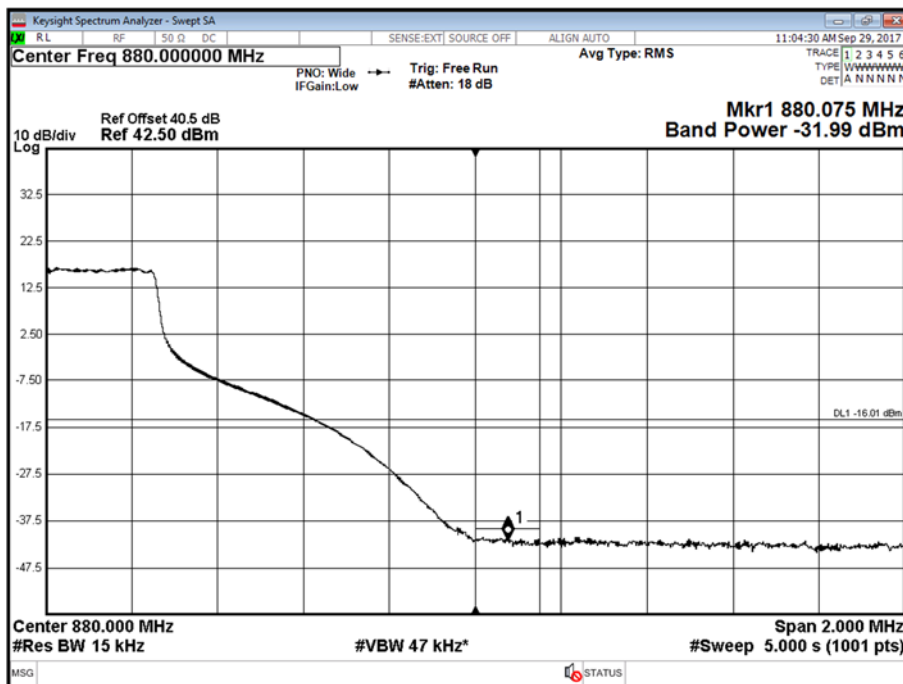



Product Service

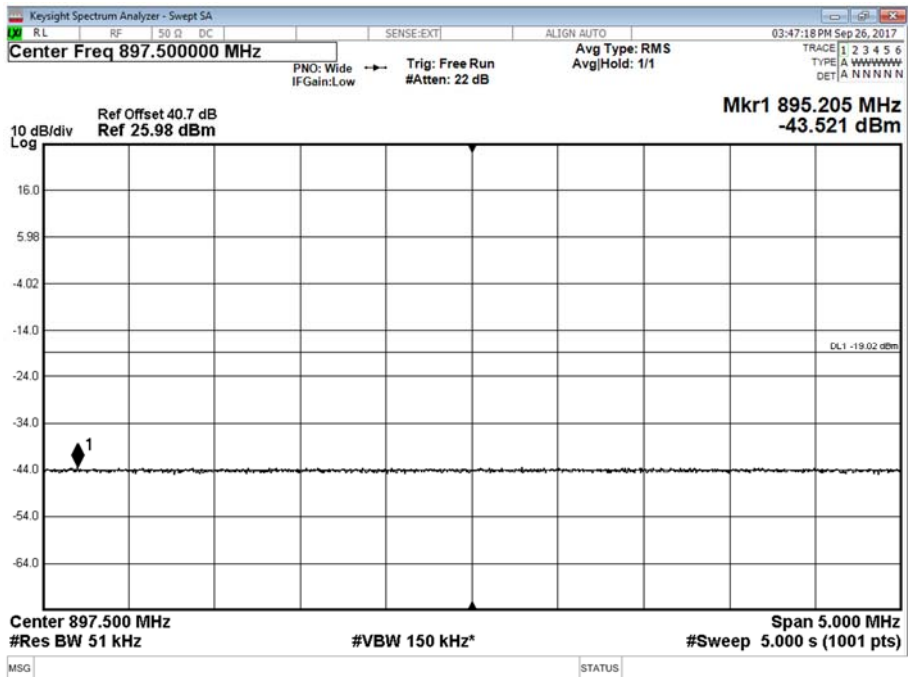

Limit	<p>< 37.5 kHz from Band Edge: -23 dBm</p> <p>> 37.5 kHz from Band Edge: -16 dBm</p> <p>Values include correction for MIMO with 2 ports, (10log(2))</p>
-------	--



Product Service

2.4 TRANSMITTER SPURIOUS EMISSIONS

2.4.1 Specification Reference

FCC CFR 47 Part 2, Clause 2.1051
FCC CFR 47 Part 22, Clause 22.905
FCC CFR 47 Part 90, Clause 90.691

2.4.2 Date of Test and Modification State

26 September 2017 - Modification State 0

2.4.3 Test Equipment Used

The major items of test equipment used for the above tests are identified in Section 3.1.

2.4.4 Environmental Conditions

Ambient Temperature	22.5°C
Relative Humidity	55.2%

2.4.5 Test Method

All measurements were made in accordance with FCC KDB 971168 D01 Clause 6.

The EUT was connected to a Spectrum Analyser via 40 dB of attenuation for measurements below 1.5 GHz and up to 9 GHz using 30 dB of attenuation and a high pass filter. Prior to testing, a Network Analyser was used to calibrate the path loss between the EUT and the Spectrum Analyser. The worst case path loss in the measured ranges was entered as a reference level offset. Over the measured ranges, the RBW was set to 1 MHz with a VBW of 3 MHz. All measurement results are specified as average with an RMS detector being used in conjunction with a trace setting of Max Hold. Measurements were performed in configurations of the EUT as reported below.

The EUT can transmit with 1 or 2 ports simultaneously. Testing was performed on all ports with the test limits being reduced from the specification limit of $43+10\log(P)$ by a factor of $10\log(2)$ in accordance with KDB 662911 D01 v02r01 to cover all MIMO configurations. This equated to a limit of -16 dBm, (worst case).

2.4.6 Test Results

Configuration A

Maximum Output Power 46 dBm



Product Service

Antenna A - LTE Modulation QPSK - LTE Carrier Bandwidth 15.0 MHz - Channel Position B - Band 1 - Range 0.009 to 1500 MHz

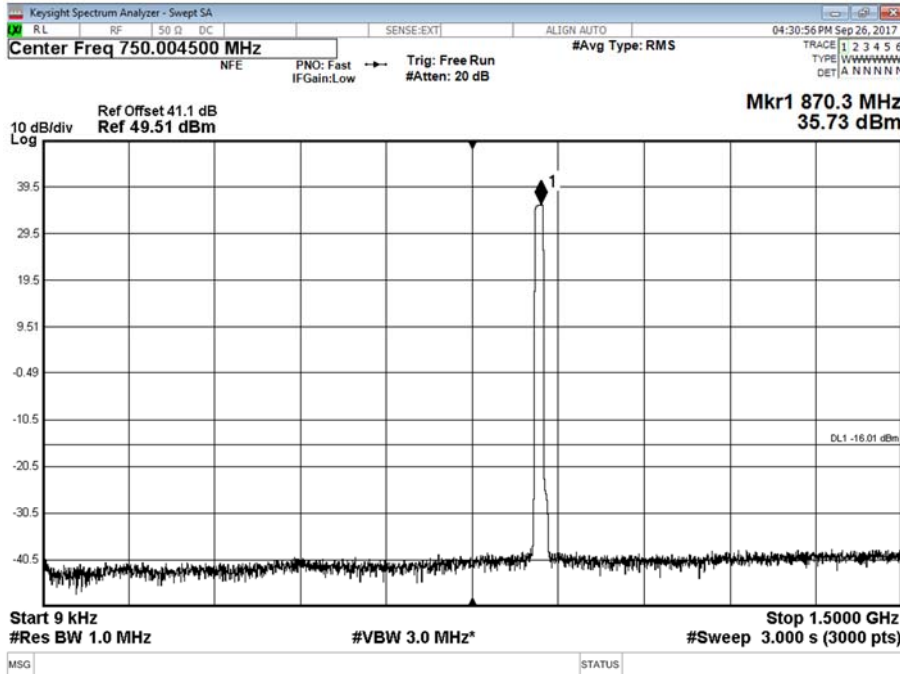

Antenna A - LTE Modulation QPSK - LTE Carrier Bandwidth 15.0 MHz - Channel Position B - Band 2 - Range 1500 to 9000 MHz

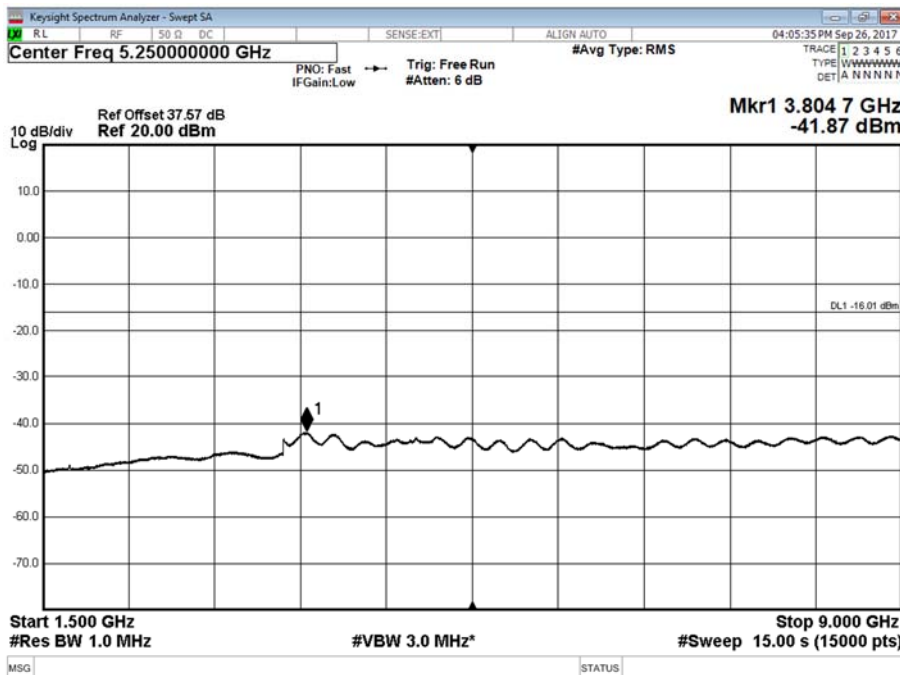



Product Service

Antenna A - LTE Modulation QPSK - LTE Carrier Bandwidth 15.0 MHz - Channel Position M - Band 1 - Range 0.009 to 1500 MHz

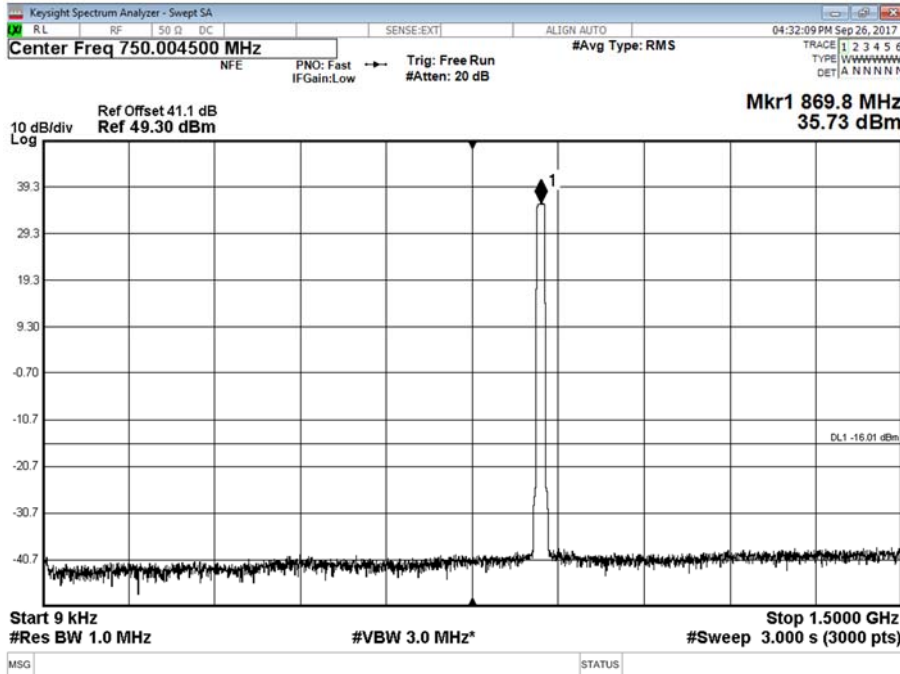

Antenna A - LTE Modulation QPSK - LTE Carrier Bandwidth 15.0 MHz - Channel Position M - Band 2 - Range 1500 to 9000 MHz

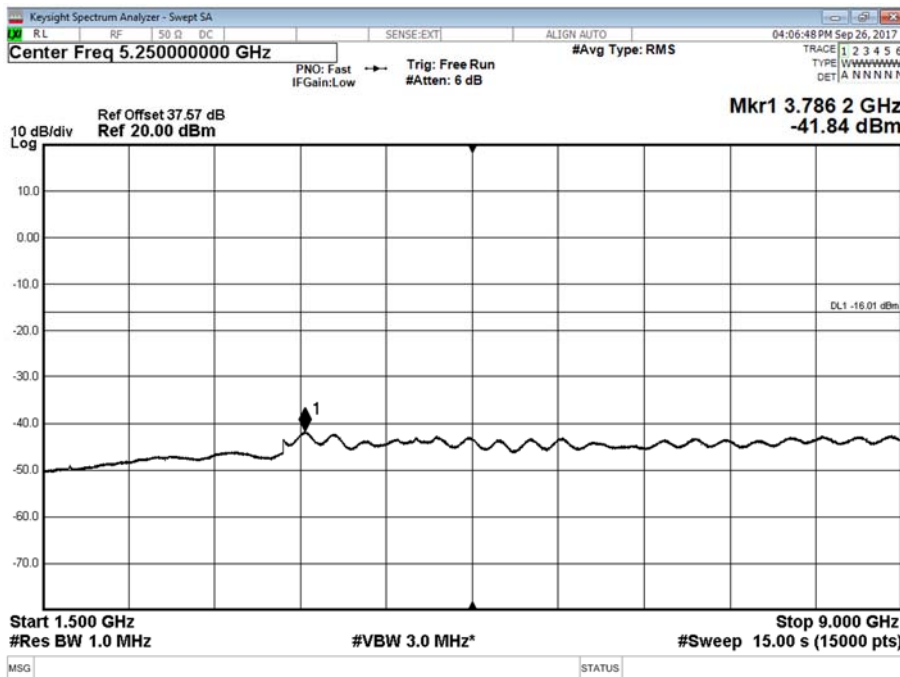



Product Service

Antenna A - LTE Modulation QPSK - LTE Carrier Bandwidth 15.0 MHz - Channel Position T - Band 1 - Range 0.009 to 1500 MHz

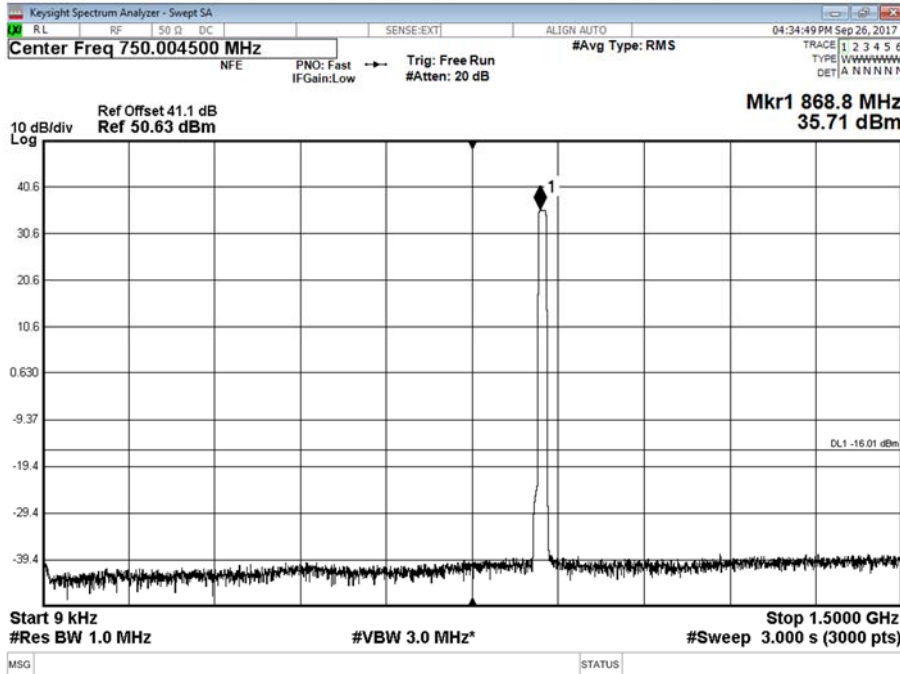

Antenna A - LTE Modulation QPSK - LTE Carrier Bandwidth 15.0 MHz - Channel Position T - Band 2 - Range 1500 to 9000 MHz

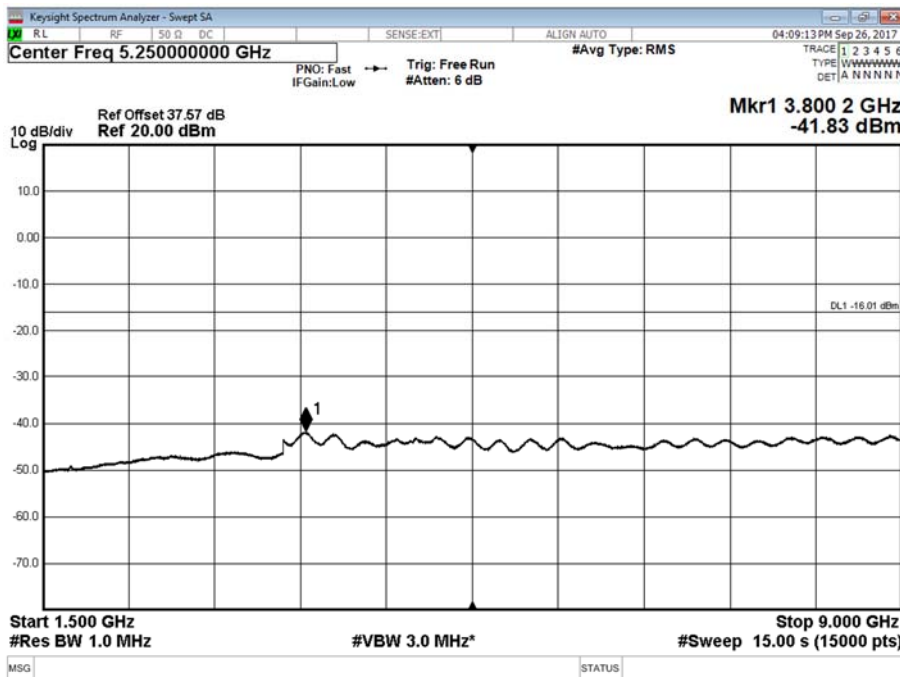

Limit	-16 dBm Value includes correction for MIMO with 2 ports, (10log(2))
-------	--



Product Service

SECTION 3

TEST EQUIPMENT USED



3.1 TEST EQUIPMENT USED

List of absolute measuring and other principal items of test equipment.

Instrument	Manufacturer	Type No.	TE No.	Calibration Period (months)	Calibration Due
Maximum Peak Output Power and Peak to Average Ratio – Conducted					
Power Meter	Agilent	N1911A	3981	12	29-Sep-2017
Spectrum Analyser	Keysight	N9030A	4654	12	06-Oct-2017
40 dB Attenuator	Unknown	TSG150R-4-450N11	15093066	-	O/P MON
40 dB Attenuator	Unknown	DTS100G-40dB-18G	Unknown	-	O/P MON
30 dB Attenuator	Weinschel	CH9182	4863	12	03/05/2018
DC Power Supply	Farnell	H 60/50	1095	-	O/P MON
Digital Multi-meter	FLUKE	79 Series III	498	12	20-Dec-2017
Thermo-hygrometer	AZ Instruments	8705	3220	12	20-Aug-2018
Calibration Kit	Hewlett Packard	85054A	1309	12	29-Mar-2018
Analyser	Hewlett Packard	8753D	1149	12	05-Sep-2018
Calibration Kit	Hewlett Packard	85032B	1282	12	23-May-2018
Precision 'N' Termination	Maury	2510A6	0487	12	21-Oct-2017
Precision 'N' Termination (Load)	Maury	2510B6	0488	12	21-Oct-2017
Network Analyser	Hewlett Packard	8510A	1151	12	12-May-2018
S' Parameter Test Box	Hewlett Packard	8514A	1152	12	12-May-2018
Signal Generator	Hewlett Packard	8340A	1159	12	13-May-2018
Occupied Bandwidth					
Power Meter	Agilent	N1911A	3981	12	29-Sep-2017
Spectrum Analyser	Keysight	N9030A	4654	12	06-Oct-2017
40 dB Attenuator	Unknown	TSG150R-4-450N11	15093066	-	O/P MON
40 dB Attenuator	Unknown	DTS100G-40dB-18G	Unknown	-	O/P MON
30 dB Attenuator	Weinschel	CH9182	4863	12	03/05/2018
DC Power Supply	Farnell	H 60/50	1095	-	O/P MON
Digital Multi-meter	FLUKE	79 Series III	498	12	20-Dec-2017
Thermo-hygrometer	AZ Instruments	8705	3220	12	20-Aug-2018
Calibration Kit	Hewlett Packard	85054A	1309	12	29-Mar-2018
Analyser	Hewlett Packard	8753D	1149	12	05-Sep-2018
Calibration Kit	Hewlett Packard	85032B	1282	12	23-May-2018
Precision 'N' Termination	Maury	2510A6	0487	12	21-Oct-2017
Precision 'N' Termination (Load)	Maury	2510B6	0488	12	21-Oct-2017
Network Analyser	Hewlett Packard	8510A	1151	12	12-May-2018
S' Parameter Test Box	Hewlett Packard	8514A	1152	12	12-May-2018
Signal Generator	Hewlett Packard	8340A	1159	12	13-May-2018
Band Edge					
Power Meter	Agilent	N1911A	3981	12	29-Sep-2017
Spectrum Analyser	Keysight	N9030A	4654	12	06-Oct-2017
40dB Attenuator	Unknown	TSG150R-4-450N11	15093066	-	O/P MON
40dB Attenuator	Unknown	DTS100G-40dB-18G	Unknown	-	O/P MON
30dB Attenuator	Weinschel	CH9182	4863	12	03/05/2018
DC Power Supply	Farnell	H 60/50	1095	-	O/P MON
Digital Multi-meter	FLUKE	79 Series III	498	12	20-Dec-2017
Thermo-hygrometer	AZ Instruments	8705	3220	12	20-Aug-2018



Product Service

Instrument	Manufacturer	Type No.	TE No.	Calibration Period (months)	Calibration Due
Calibration Kit	Hewlett Packard	85054A	1309		29-Mar-2018
Analyser	Hewlett Packard	8753D	1149	12	05-Sep-2018
Calibration Kit	Hewlett Packard	85032B	1282	12	23-May-2018
Precision 'N' Termination	Maury	2510A6	0487	12	21-Oct-2017
Precision 'N' Termination (Load)	Maury	2510B6	0488	12	21-Oct-2017
Network Analyser	Hewlett Packard	8510A	1151	12	12-May-2018
S' Parameter Test Box	Hewlett Packard	8514A	1152	12	12-May-2018
Signal Generator	Hewlett Packard	8340A	1159	12	13-May-2018
Transmitter Spurious Emissions					
Power Meter	Agilent	N1911A	3981	12	29-Sep-2017
Spectrum Analyser	Keysight	N9030A	4654	12	06-Oct-2017
40dB Attenuator	Unknown	TSG150R-4-450N11	15093066	-	O/P MON
40dB Attenuator	Unknown	DTS100G-40dB-18G	Unknown	-	O/P MON
30dB Attenuator	Weinschel	CH9182	4863	12	03/05/2018
DC Power Supply	Farnell	H 60/50	1095	-	O/P MON
Digital Multi-meter	FLUKE	79 Series III	498	12	20-Dec-2017
Thermo-hygrometer	AZ Instruments	8705	3220	12	20-Aug-2018
Calibration Kit	Hewlett Packard	85054A	1309		29-Mar-2018
Analyser	Hewlett Packard	8753D	1149	12	05-Sep-2018
Calibration Kit	Hewlett Packard	85032B	1282	12	23-May-2018
Precision 'N' Termination	Maury	2510A6	0487	12	21-Oct-2017
Precision 'N' Termination (Load)	Maury	2510B6	0488	12	21-Oct-2017
Network Analyser	Hewlett Packard	8510A	1151	12	12-May-2018
S' Parameter Test Box	Hewlett Packard	8514A	1152	12	12-May-2018
Signal Generator	Hewlett Packard	8340A	1159	12	13-May-2018

N/A – Not Applicable

O/P Mon – Output Monitored with Calibrated Equipment



Product Service

3.2 MEASUREMENT UNCERTAINTY

For a 95% confidence level, the measurement uncertainties for defined systems are:-

Test Discipline	Frequency / Parameter	MU
Conducted Maximum Peak Output Power	30 MHz to 20 GHz Amplitude	± 0.1 dB
Conducted Emissions	30 MHz to 20 GHz Amplitude	± 2.3 dB
Frequency Stability	30 MHz to 2 GHz	± 5.0 Hz
Occupied Bandwidth	Up to 20 MHz Bandwidth	± 1.1 Hz
Band Edge	30 MHz to 20 GHz Amplitude	± 2.3 dB



Product Service

SECTION 5

ACCREDITATION, DISCLAIMERS AND COPYRIGHT



Product Service

4.1 ACCREDITATION, DISCLAIMERS AND COPYRIGHT



This report relates only to the actual item/items tested.

Our UKAS Accreditation does not cover opinions and interpretations and any expressed are outside the scope of our UKAS Accreditation.

Results of tests not covered by our UKAS Accreditation Schedule are marked NUA (Not UKAS Accredited).

© 2017 TÜV SÜD Product Service



Product Service

ANNEX A

MODULE LIST



Product Service

Configurations A, B & C			
Product	Product No	R-State	Serial No
Radio 2217 B26D	KRC 161 592/1	R1E	SD825975510
Software Version:	CXP 901 7316/2	Revision:	R67GK