



Sverige



Accred. no. 10363  
Testing  
ISO/IEC 17025

# Report On

FCC and ISED Testing of the Ericsson RRUS 32 B66A LTE and NR (ESS), KRD 901 1583/1 (2110-2180 MHz) Base Station in accordance with FCC CFR 47 Part 2, FCC CFR 47 Part 27, ISED RSS-GEN and Industry Canada RSS-139

COMMERCIAL-IN-CONFIDENCE

FCC: TA8FKRC161583-1

IC: 287AB-AS1615831

PREPARED BY

APPROVED BY

DATED

Maggie Whiting  
Key Account Manager

Steve Scarfe  
Authorised Signatory

22 September 2021

Document 75952703 Report 03 Issue 2

September 2021



## CONTENTS

Section	Page No
<b>1</b>	<b>REPORT INFORMATION ..... 2</b>
1.1	Report Details ..... 3
1.2	Test Rationale..... 5
1.3	Configuration Description ..... 6
1.4	Declaration of Build Status ..... 7
1.5	Product Information ..... 8
1.6	Test Setup ..... 9
1.7	Test Conditions..... 10
1.8	Deviation From The Standard ..... 10
1.9	Modification Record ..... 10
1.10	Additional Information ..... 10
<b>2</b>	<b>TEST DETAILS ..... 11</b>
2.1	Maximum Peak Output Power and Peak to Average Ratio - Conducted..... 12
2.2	Occupied Bandwidth..... 30
2.3	Band Edge ..... 49
2.4	Transmitter Spurious Emissions ..... 64
<b>3</b>	<b>TEST EQUIPMENT USED ..... 145</b>
3.1	Test Equipment Used ..... 146
3.2	Measurement Uncertainty ..... 149
<b>4</b>	<b>ACCREDITATION, DISCLAIMERS AND COPYRIGHT ..... 150</b>
4.1	Accreditation, Disclaimers and Copyright..... 151
<b>ANNEX A</b>	<b>Module Lists.....A.2</b>



## **SECTION 1**

### **REPORT INFORMATION**



## 1.1 REPORT DETAILS

Manufacturer	Ericsson
Address	Torshamnsgatan 23 Kista SE-16480 Stockholm Sweden
Product Name & Product Number	RRUS 32 B66A & KRC 161 583/1
Serial Number(s)	E553071497
Software Version	CXP9013268/12 Rev R82CM
Hardware Version	R1F
Test Specification/Issue/Date	FCC CFR 47 Part 2: 2020 FCC CFR 47 Part 27: 2020 ISED RSS-GEN: Issue 5: March 2019 Amendment 1, 2021 Amendment 2 Industry Canada RSS-139: Issue 3: 2015
Test Plan	Q1 FCC_IC test plan for MR7602-1 ESS V 1.2 Reduced Scope
Start of Test	30 June 2021
Finish of Test	05 July 2021
Name of Engineer(s)	Ashok Kumar Hector Eric Moreno Trujillo
Related Document(s)	KDB 971168 D01 v02r02 KDB 662911 D01 v02r01 KDB 716230 ICES-003:Issue 7 (2020-10) ANSI C63.26-2015

---

**This report has been up issued to issue 2 and should be read in place of Issue 1 to correct OBW results in Configuration 1.**

### ENGINEERING STATEMENT

The measurements shown in this report were made in accordance with the procedures described on test pages. All reported testing was carried out on a sample equipment to demonstrate compliance with and FCC CFR 47 Part 2: 2020, FCC CFR 47 Part 27: 2020, ISED RSS-GEN: Issue 5: March 2019 Amendment 1, 2021 Amendment 2, Industry Canada RSS-139: Issue 3: 2015. The sample tested was found to comply with the requirements defined in the applied rules.

Test Engineer(s);

Ashok Kumar

Hector Eric Moreno Trujillo



## Brief Summary of Results

A brief summary of results for each configuration, in accordance with FCC CFR 47 Part 2, FCC CFR 47 Part 27, ISED RSS-GEN and Industry Canada RSS-139 is shown below.

Section	Specification Clause				Test Description	Result
	FCC CFR 47 Part 2	FCC CFR 47 Part 27	RSS-GEN	RSS-139		
2.1	2.1046	27.50	-	6.5	Maximum Peak Output Power and Peak to Average Ratio - Conducted	Pass
2.2	2.1049	27.53	6.6	-	Occupied Bandwidth	Pass
2.3	2.1051	27.53	-	6.5	Band Edge	Pass
2.4	2.1051	27.53	-	6.6	Transmitter Spurious Emissions	Pass



## 1.2 TEST RATIONALE

The tests that have been selected are detailed in the customer Test Plan as defined in section 1.1 of this report. The Test Plan is based on the TÜV SÜD FCC Test Plan Rationale, available on request.



### 1.3 CONFIGURATION DESCRIPTION

Configuration	RAT	No. Of carriers	Pout (W)	Carrier Bandwidth	Carrier Frequency Configuration (MHz)		
					Bottom	Middle	Top
1	ESS, NR/LTE	1	40	10 MHz- SCS 15kHz	2115	2145	2175
				20 MHz- SCS 15kHz	2120	2145	2170
2		3	40	10 MHz- SCS 15kHz	2115+2125+2135	N/A	2175+2165+2155
3	NR in NR/ESS Setup	1	40	10 MHz- SCS 15kHz	2115	2145	2175
				20 MHz- SCS 15kHz	2120	2145	2170
4		3	40	10 MHz- SCS 15kHz	2115+2125+2135	N/A	2175+2165+2155

Testing for Radiated Spurious Emissions are recording in the following report:  
2104108STO-102 RRUS32B66A IoT FCC27

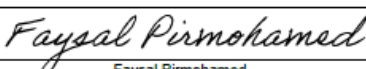

1.4 DECLARATION OF BUILD STATUS

<b>Equipment Description</b>						
Technical Description: (Please provide a brief description of the intended use of the equipment including the technologies the product supports)		Multi-standard remote radio unit				
Manufacturer:		Ericsson AB				
Model:		RRUS 32 B66A				
Part Number:		KRC 161 583/1				
Hardware Version:		R1F				
Software Version:		CXP 901 3268/12 R82CM				
FCC ID of the product under test		TA8AKRC161583-1				
IC ID of the product under test		287AB-AS1615831				
<b>Intentional Radiators</b>						
FDD, TDD		FDD				
Frequency Range (MHz to MHz)		2110 MHz - 2180MHz DL 1710MHz - 1780MHz UL				
FDD / TDD		FDD				
Conducted Declared Output Power (dBm)		40W per antenna connector (NB IoT SA carrier max 20W)				
RAT		WCDMA	NB IoT SA	LTE (incl. NB IoT IB, GB)	NR (incl NB IoT IB)	MRO
Supported Bandwidth(s) (MHz)				5, 10, 15, 20MHz	5,10,15,20MHz 15kHz sss	
Modulation Scheme(s) DL		QPSK, 16QAM, 64QAM	QPSK	64QAM, 256QAM	QPSK, 16QAM, 64QAM, 256QAM	
ITU Emission Designator		5M00F9W	209KW7D	5M00F9W, 10M0F9W, 15M0F9W, M0F9W	4M47W7D, 9M28W7D, 14M1W7D, 18M9W7D, 37M8W7D, 9M43W7D, 14M4W7D, 19M2W7D	
IBW		45MHz	40MHz	70 MHz	70MHz	
Maximum number of carriers			2		3	3
<b>Unintentional Radiators</b>						
Highest frequency generated or used in the device or on which the device operates or tunes		9,8 Gbit/s				
Lowest frequency generated or used in the device or on which the device operates or tunes if <30MHz						
Class A Digital Device (Use in commercial, industrial or business environment) or Class B Digital Device (Use in residential environment)		Class B				
<b>DC Power Supply (Delete if Not Applicable)</b>						
Nominal voltage:		-48V				
Extreme upper voltage:		-39V				
Extreme lower voltage:		-58.5V				
Max current:		26A				
<b>Temperature</b>						
Minimum temperature:		-40°C				
Maximum temperature:		55°C				
I hereby declare that I am entitled to sign on behalf of the manufacturer and that the information supplied is correct and complete.						
 Faysal Pirmohamed Regulatory Engineer						
Name:		Faysal Pirmohamed				
Position held:		Regulatory Engineer				
Date:		2021-09-01				

No responsibility will be accepted by TÜV SÜD as to the accuracy of the information declared in this document by the manufacturer.



## 1.5 PRODUCT INFORMATION

### 1.5.1 Technical Description

The Equipment Under Test (EUT) RRUS 32 B66A – KRC 161 583/1 is an Ericsson AB Radio Unit working in the public mobile service 2110-2180 MHz band which provides communication connections to 2100-2180 MHz network. The EUT operates from a -48V DC supply.

The Equipment Under Test (EUT) is shown in the photograph below. A full technical description can be found in the Manufacturer's documentation.



Equipment Under Test



## 1.6 TEST SETUP

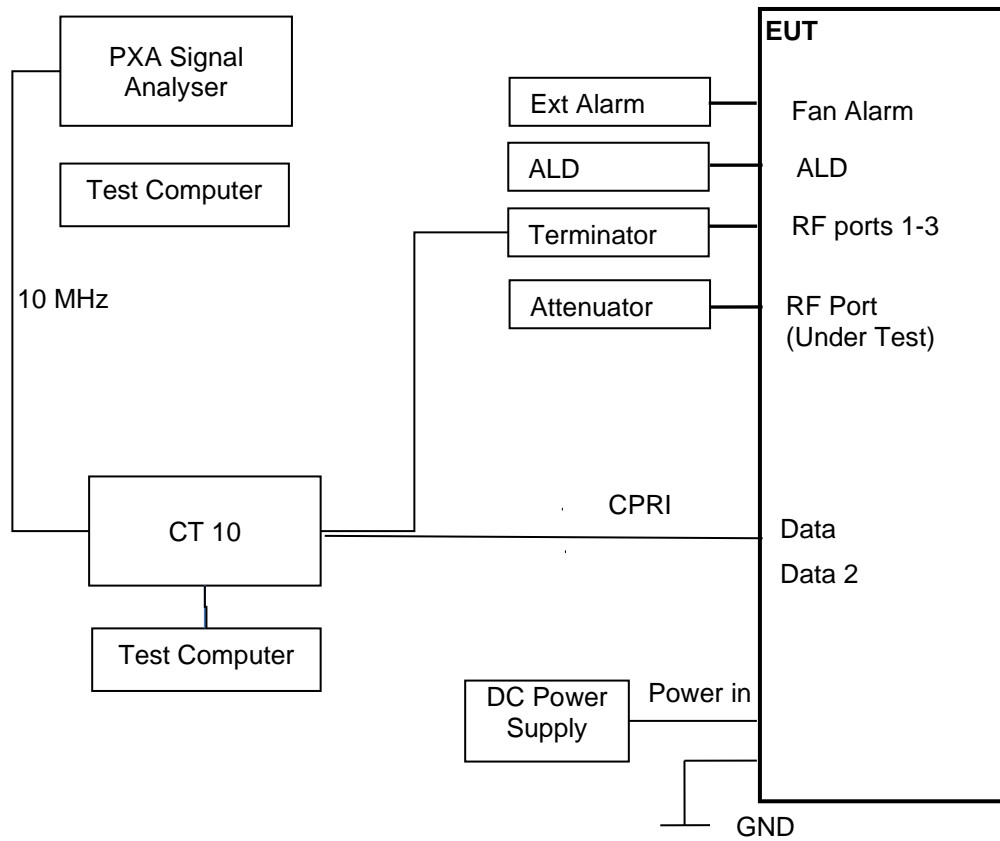



## 1.7 TEST CONDITIONS

For all tests the EUT was set up in accordance with the relevant test standard and to represent typical operating conditions. Tests were applied with the EUT situated as described in the Test Method for each Test.

The EUT was powered from a -48V DC supply.

FCC Measurement Facility Registration Number  
563983 Ericsson Test Laboratory, Kista  
Postal Address: Ericsson AB, Isafjordsgatan 10, Stockholm, SE-16 440, Sweden

ISED Accreditation  
IC#26170 Ericsson Test Laboratory, Kista  
Postal Address: Ericsson AB, Isafjordsgatan 10, Stockholm, SE-164 40, Sweden

Test Name	Name of Engineer(s)
Maximum Peak Output Power and Peak to Average Ratio - Conducted	Ashok Kumar, Hector Eric Moreno Trujillo
Occupied Bandwidth	Ashok Kumar, Hector Eric Moreno Trujillo
Band Edge	Ashok Kumar, Hector Eric Moreno Trujillo
Transmitter Spurious Emissions	Ashok Kumar, Hector Eric Moreno Trujillo

## 1.8 DEVIATION FROM THE STANDARD

No deviations from the applicable test standards or test plan were made during testing.

## 1.9 MODIFICATION RECORD

No modifications were made to the EUT during testing.

## 1.10 ADDITIONAL INFORMATION

Ericsson will limit this product through the software from operating across the whole of Band 66, it will be limited to 2110-2180 MHz.

This filing is for a Class 2 Permissive change to add ESS, NR in ESS and LTE in ESS modulations to a previously certified Radio for use in the USA and Canada under the following ID's:

FCC ID: TA8AKRC161583-1  
IC: 287AB-AS1615831

This device is electrically identical as originally certified as no hardware changes have been made  
Frequency Stability has been verified at time of original certification.

The Test Plan is based on the TUV SUD Document FCC and ISED Test Plan Rationale for Base Station Equipment.

This TX and RX share the same port and therefore Rx Spurious Emissions have not been performed.



## **SECTION 2**

### **TEST DETAILS**



**2.1 MAXIMUM PEAK OUTPUT POWER AND PEAK TO AVERAGE RATIO - CONDUCTED**

**2.1.1 Specification Reference**

FCC CFR 47 Part 27, Clause 27.50  
 FCC CFR 47 Part 2, Clause 2.1046  
 Industry Canada RSS-139, Clause 6.5

**2.1.2 Date of Test and Modification State**

29 and 30 June 2021 - Modification State 0

**2.1.3 Test Equipment Used**

The major items of test equipment used for the above tests are identified in Section 3.1.

**2.1.4 Environmental Conditions**

Ambient Temperature 23.4 - 25.2°C  
 Relative Humidity 37.2 - 40.8%

**2.1.5 Test Method**

All measurements were made in accordance with FCC KDB 971168 D01, clause 5.2.1 and summed in accordance with FCC KDB 662911 D01.

Calculations

Total Power = Measured PSD (Total Power Port A) + 10log (N<sub>ANT</sub>), where N<sub>ANT</sub> =4

Maximum Total Power (EIRP) = Total Power (as above) + Declared Antenna Gain

**2.1.6 Test Results**

Configuration 1

Maximum Output Power 46.00 dBm

Antenna	LTE / NR Modulation	LTE / NR Carrier Bandwidth	Peak to Average Ratio (PAR) / Output Power / PSD					
			Channel Position B					
			PAR (dB)	Average Power/PSD		Total Power Port A+B+C+D		
dBm	dBm/MHz	dBm		dBm/MHz				
A	QPSK	ESS 40/60 10.0 MHz 15 kHz SCS	7.25	45.77	37.05	51.79	43.07	
A	QPSK	ESS 40/60 20.0 MHz 15 kHz SCS	7.33	45.66	33.92	51.68	39.94	
A	QPSK	ESS 10/90 10.0 MHz 15 kHz SCS	7.20	45.80	37.17	51.82	43.19	
A	QPSK	ESS 10/90 20.0 MHz 15 kHz SCS	7.29	45.71	33.96	51.73	39.98	
A	QPSK	ESS 90/10 10.0 MHz 15 kHz SCS	7.30	45.69	36.90	51.71	42.92	
A	QPSK	ESS 90/10 20.0 MHz 15 kHz SCS	7.35	45.65	33.72	51.67	39.74	



LTE/NR Carrier Bandwidth	Total Power PSD	Maximum Antenna gain	Maximum Total EIRP	EIRP Limit	EIRP Limit
	(dBm/MHz)	(dBi)	(dBm/MHz)	(W/MHz)	(dBm/MHz)
ESS 10/90 10.0 MHz 15 kHz SCS	43.07			1640	62.15
ESS 10/90 20.0 MHz 15 kHz SCS	39.94			1640	62.15
ESS 40/60 10.0 MHz 15 kHz SCS	43.19			1640	62.15
ESS 40/60 20.0 MHz 15 kHz SCS	39.98			1640	62.15
ESS 90/10 10.0 MHz 15 kHz SCS	42.92			1640	62.15
ESS 90/10 20.0 MHz 15 kHz SCS	39.74			1640	62.15

Antenna A - LTE / NR Modulation QPSK - LTE / NR Carrier Bandwidth ESS 40/60 10.0 MHz 15 kHz SCS - Channel Position B

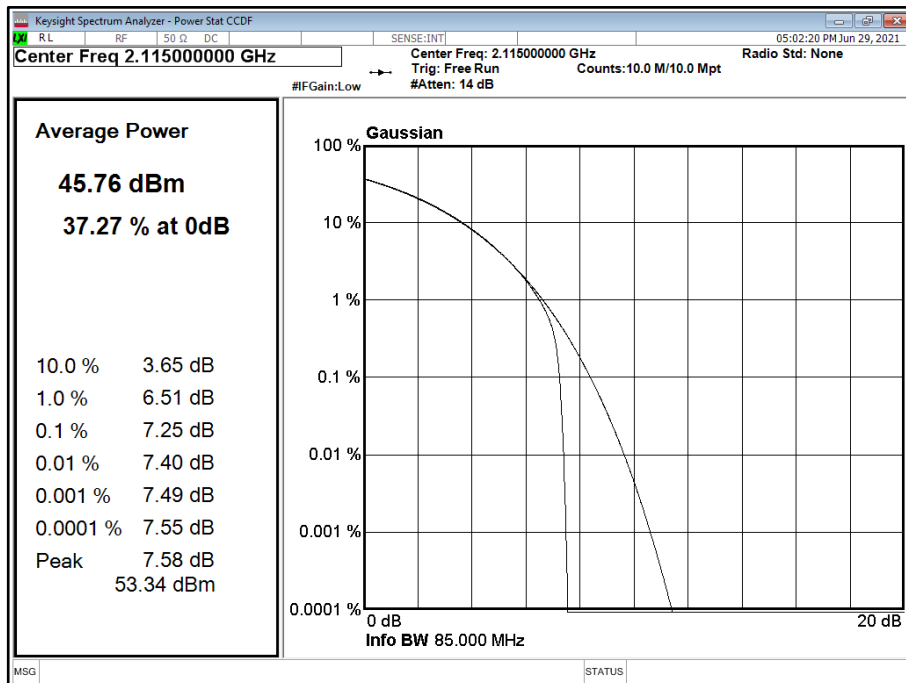



Antenna A - LTE / NR Modulation QPSK - LTE / NR Carrier Bandwidth ESS 40/60 20.0 MHz 15 kHz SCS - Channel Position B

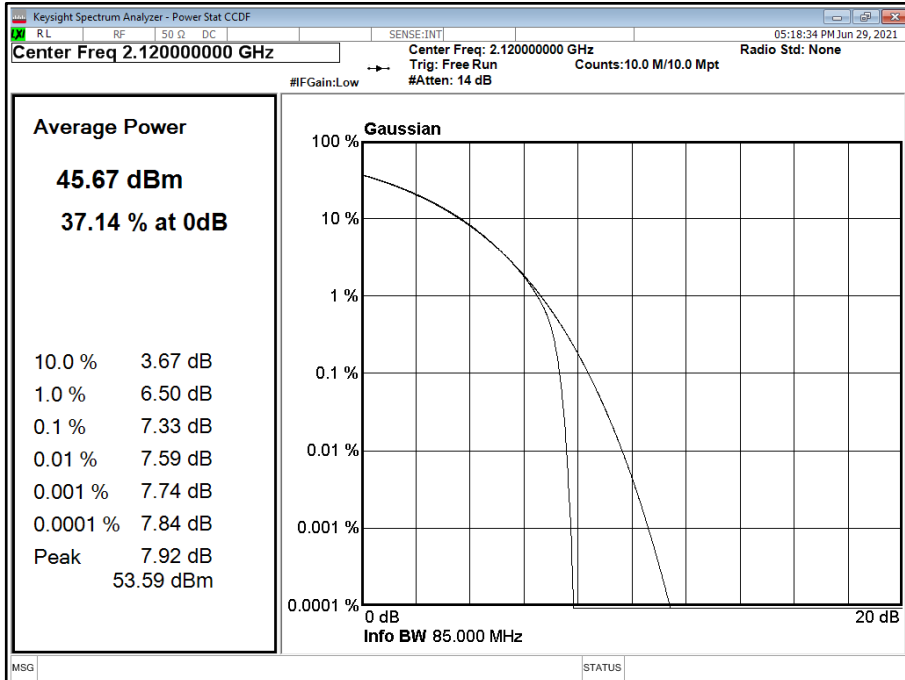

Antenna A - LTE / NR Modulation QPSK - LTE / NR Carrier Bandwidth ESS 10/90 10.0 MHz 15 kHz SCS - Channel Position B

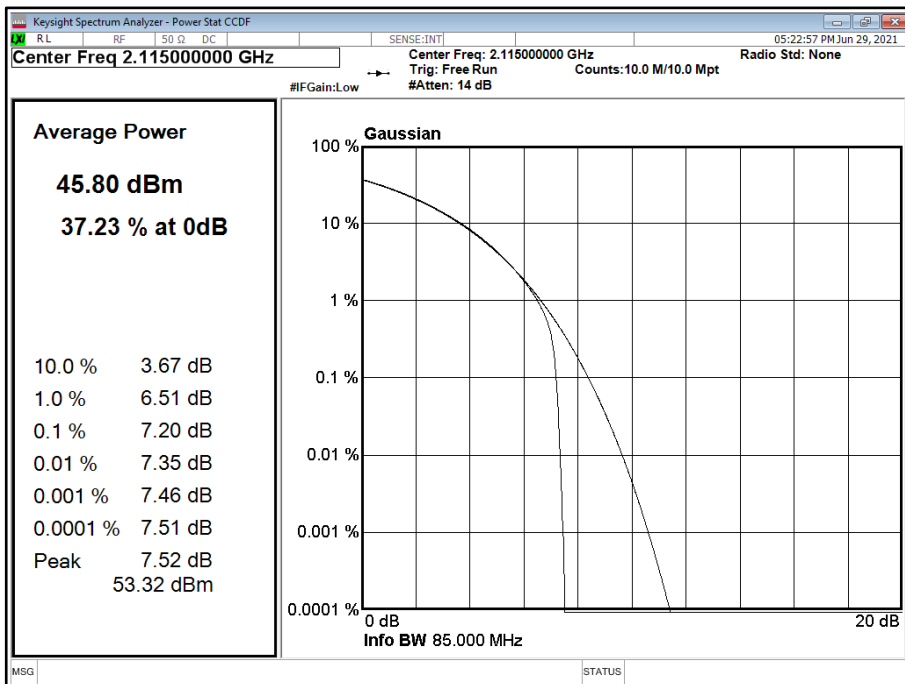



Antenna A - LTE / NR Modulation QPSK - LTE / NR Carrier Bandwidth ESS 10/90 20.0 MHz 15 kHz SCS - Channel Position B

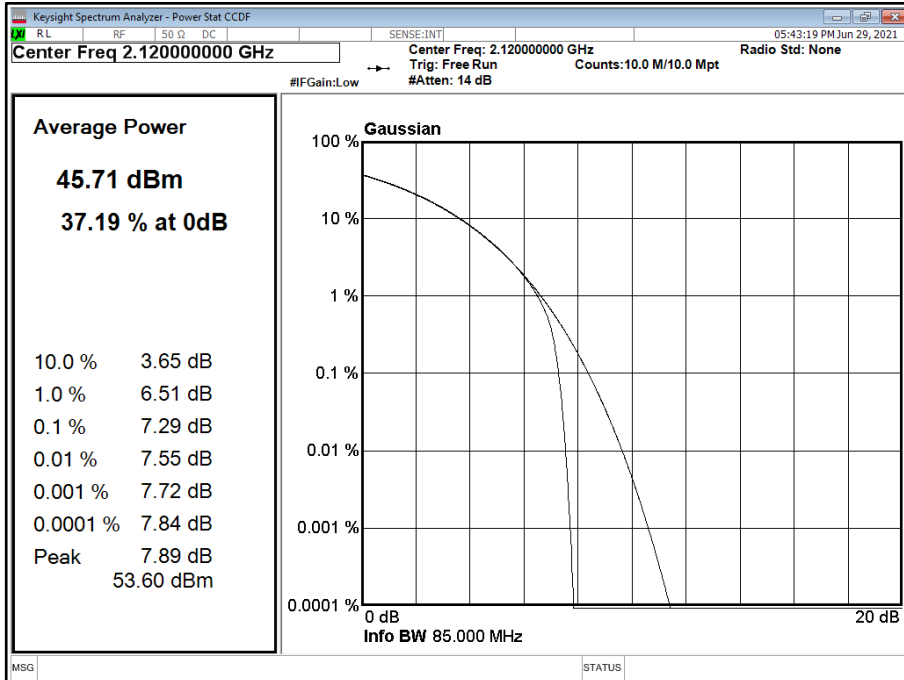

Antenna A - LTE / NR Modulation QPSK - LTE / NR Carrier Bandwidth ESS 90/10 10.0 MHz 15 kHz SCS - Channel Position B

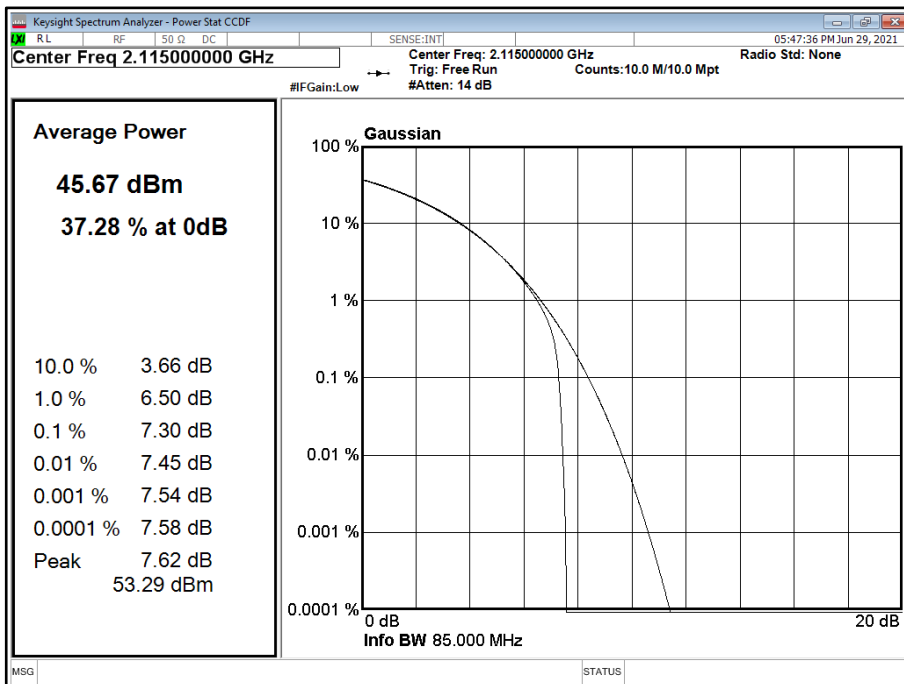





Antenna A - LTE / NR Modulation QPSK - LTE / NR Carrier Bandwidth ESS 90/10 20.0 MHz 15 kHz SCS - Channel Position B

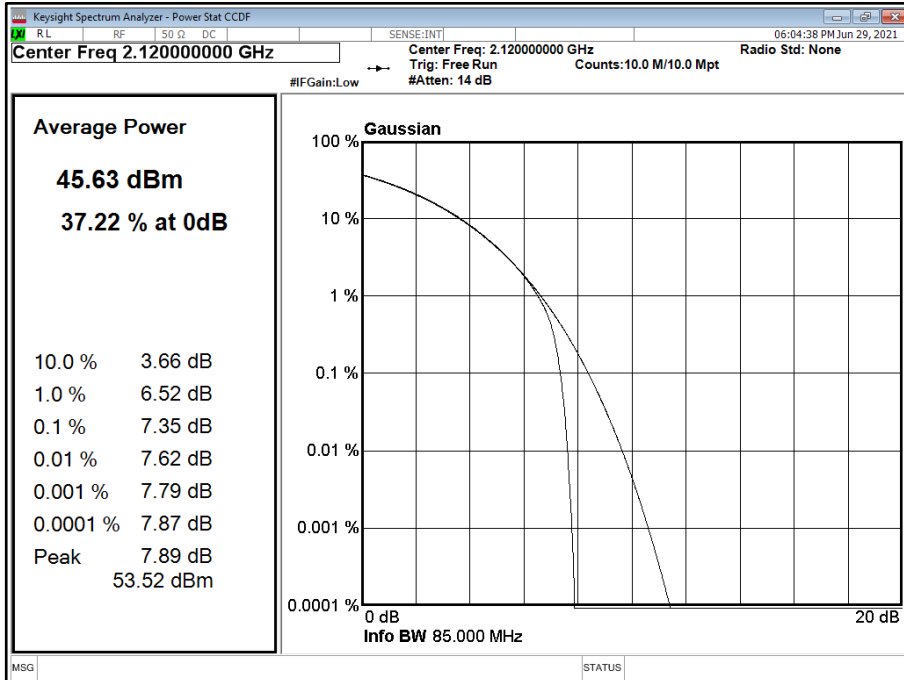

Configuration 1

Maximum Output Power 46.00 dBm

Antenna	LTE / NR Modulation	LTE / NR Carrier Bandwidth	Peak to Average Ratio (PAR) / Output Power / PSD				
			Channel Position M				
			PAR (dB)	Average Power/PSD		Total Power Port A+B+C+D	
			dBm	dBm/MHz	dBm	dBm/MHz	
A	QPSK	ESS 40/60 10.0 MHz 15 kHz SCS	7.24	45.74	36.91	51.76	42.93
A	QPSK	ESS 40/60 20.0 MHz 15 kHz SCS	7.27	45.71	34.06	51.73	40.08
A	QPSK	ESS 10/90 10.0 MHz 15 kHz SCS	7.19	45.79	36.92	51.81	42.94
A	QPSK	ESS 10/90 20.0 MHz 15 kHz SCS	7.24	45.71	33.95	51.73	39.97
A	QPSK	ESS 90/10 10.0 MHz 15 kHz SCS	7.29	45.66	36.87	51.68	42.89
A	QPSK	ESS 90/10 20.0 MHz 15 kHz SCS	7.30	45.63	33.92	51.65	39.94

LTE/NR Carrier Bandwidth	Total Power PSD (dBm/MHz)	Maximum Antenna gain (dBi)	Maximum Total EIRP (dBm/MHz)	EIRP Limit (W/MHz)	EIRP Limit (dBm/MHz)
ESS 10/90 10.0 MHz 15 kHz SCS	42.93			1640	62.15
ESS 10/90 20.0 MHz 15 kHz SCS	40.08			1640	62.15
ESS 40/60 10.0 MHz 15 kHz SCS	42.94			1640	62.15
ESS 40/60 20.0 MHz 15 kHz SCS	39.97			1640	62.15
ESS 90/10 10.0 MHz 15 kHz SCS	42.89			1640	62.15
ESS 90/10 20.0 MHz 15 kHz SCS	39.94			1640	62.15



Antenna A - LTE / NR Modulation QPSK - LTE / NR Carrier Bandwidth ESS 40/60 10.0 MHz 15 kHz SCS - Channel Position M

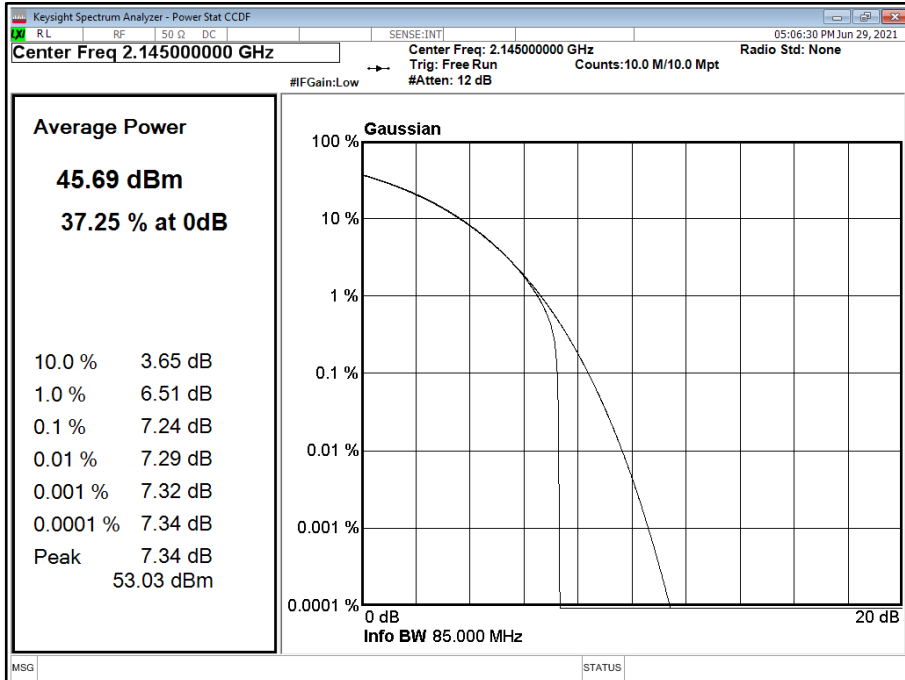

Antenna A - LTE / NR Modulation QPSK - LTE / NR Carrier Bandwidth ESS 40/60 20.0 MHz 15 kHz SCS - Channel Position M

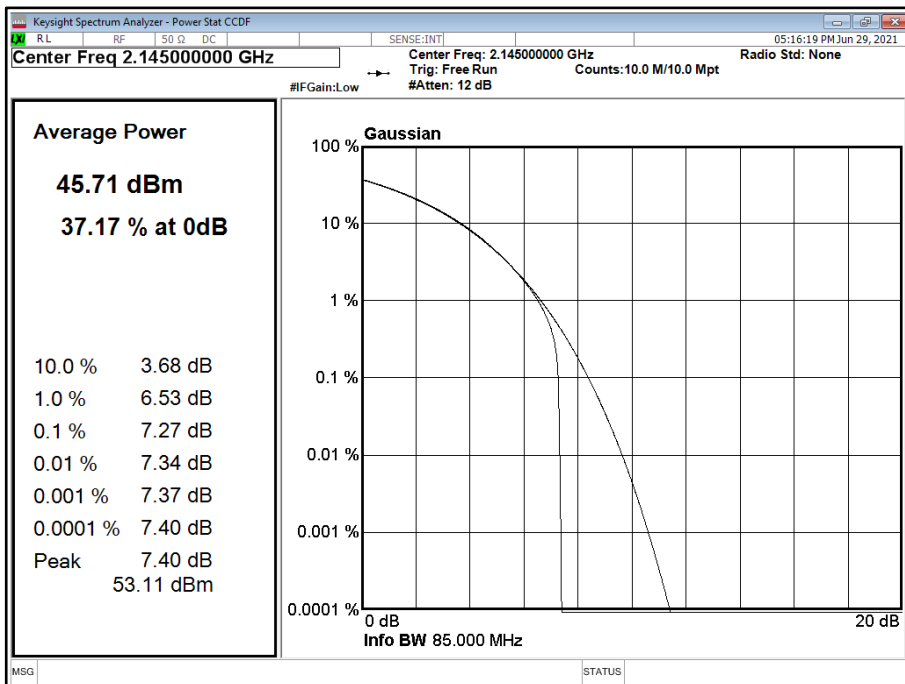



Antenna A - LTE / NR Modulation QPSK - LTE / NR Carrier Bandwidth ESS 10/90 10.0 MHz 15 kHz SCS - Channel Position M

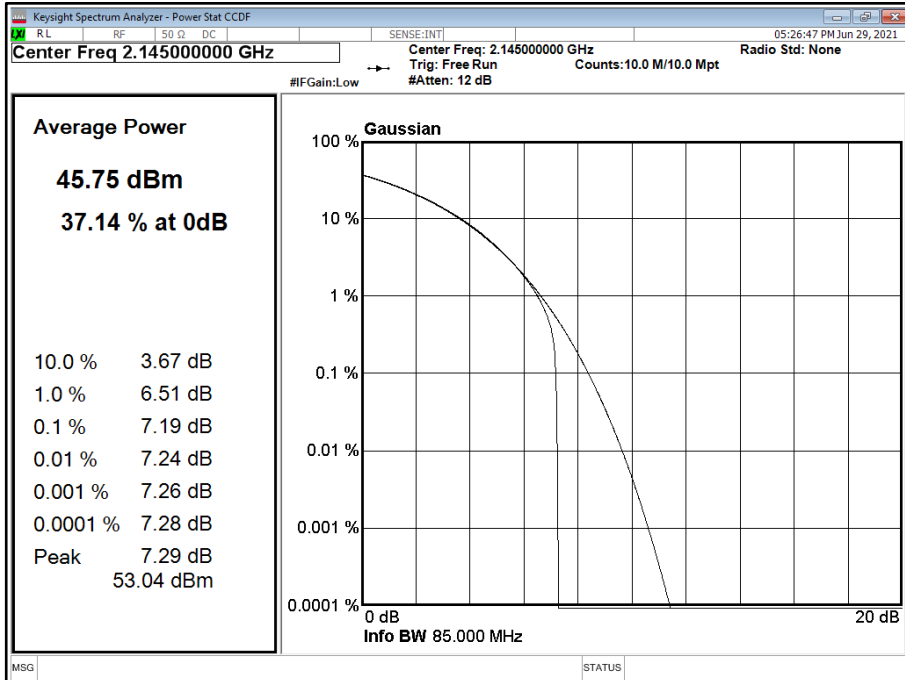

Antenna A - LTE / NR Modulation QPSK - LTE / NR Carrier Bandwidth ESS 10/90 20.0 MHz 15 kHz SCS - Channel Position M

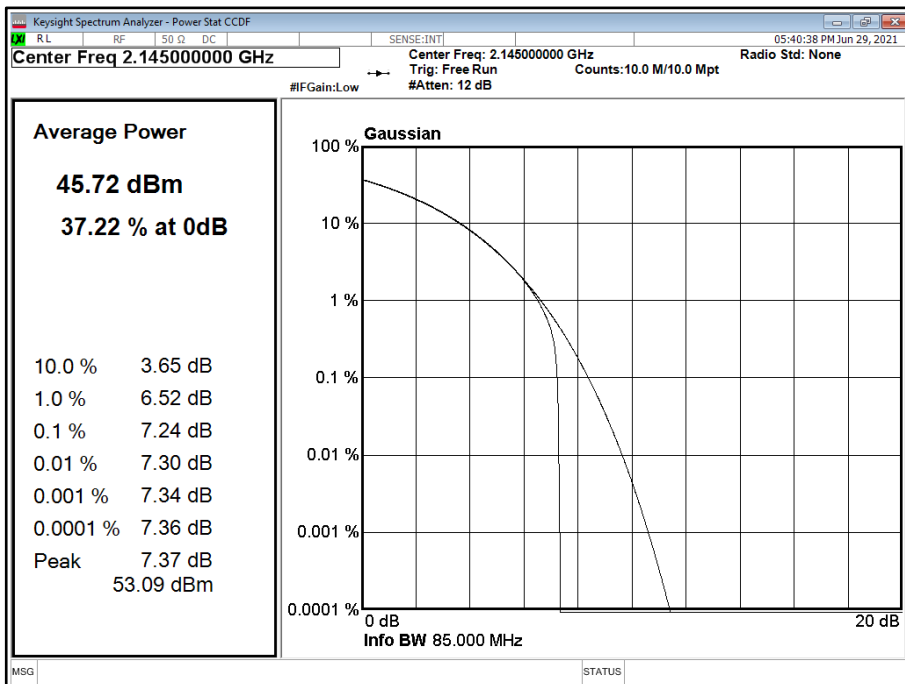



Antenna A - LTE / NR Modulation QPSK - LTE / NR Carrier Bandwidth ESS 90/10 10.0 MHz 15 kHz SCS - Channel Position M

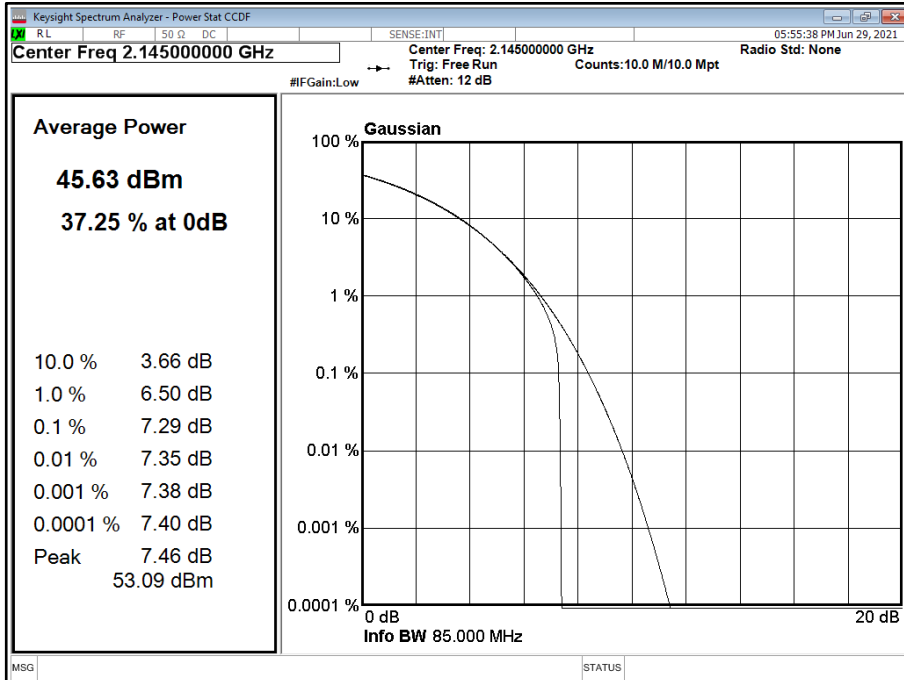

Antenna A - LTE / NR Modulation QPSK - LTE / NR Carrier Bandwidth ESS 90/10 20.0 MHz 15 kHz SCS - Channel Position M

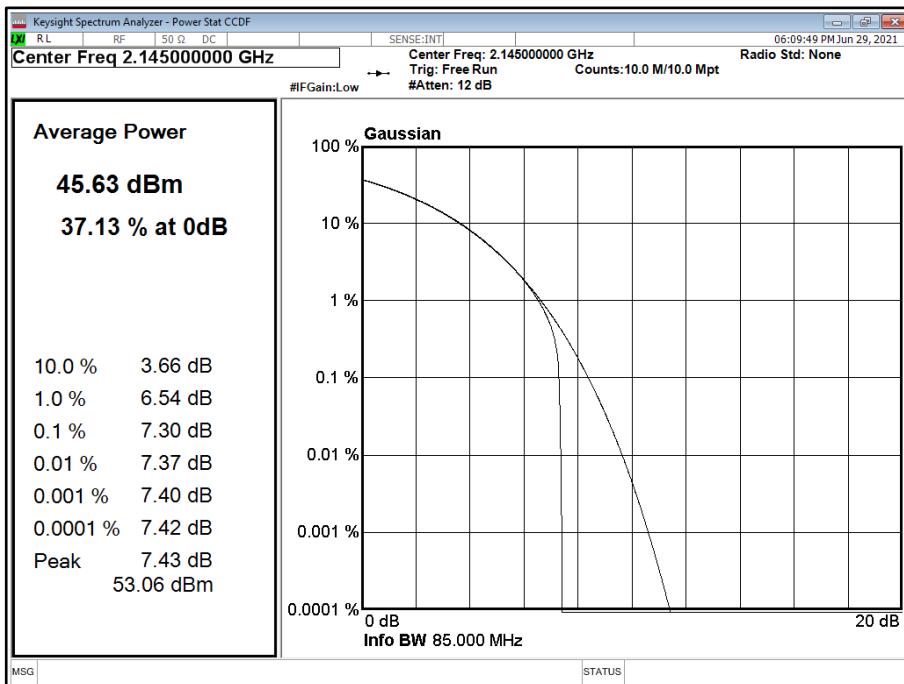



Configuration 1

Maximum Output Power 46.00 dBm

Antenna	LTE / NR Modulation	LTE / NR Carrier Bandwidth	Peak to Average Ratio (PAR) / Output Power / PSD					
			Channel Position T					
			PAR (dB)	Average Power/PSD		Total Power Port A+B+C+D		
dBm	dBm/MHz	dBm		dBm/MHz				
A	QPSK	ESS 40/60 10.0 MHz 15 kHz SCS	7.24	45.53	36.72	51.55	42.74	
A	QPSK	ESS 40/60 20.0 MHz 15 kHz SCS	7.32	45.68	33.94	51.70	39.96	
A	QPSK	ESS 10/90 10.0 MHz 15 kHz SCS	7.20	45.58	36.99	51.60	43.01	
A	QPSK	ESS 10/90 20.0 MHz 15 kHz SCS	7.30	45.70	34.04	51.72	40.06	
A	QPSK	ESS 90/10 10.0 MHz 15 kHz SCS	7.30	45.48	36.72	51.50	42.74	
A	QPSK	ESS 90/10 20.0 MHz 15 kHz SCS	7.37	45.61	33.84	51.63	39.86	

LTE/NR Carrier Bandwidth	Total Power PSD (dBm/MHz)	Maximum Antenna gain (dBi)	Maximum Total EIRP (dBm/MHz)	EIRP Limit (W/MHz)	EIRP Limit (dBm/MHz)
ESS 10/90 10.0 MHz 15 kHz SCS	42.74			1640	62.15
ESS 10/90 20.0 MHz 15 kHz SCS	39.96			1640	62.15
ESS 40/60 10.0 MHz 15 kHz SCS	43.01			1640	62.15
ESS 40/60 20.0 MHz 15 kHz SCS	40.06			1640	62.15
ESS 90/10 10.0 MHz 15 kHz SCS	42.74			1640	62.15
ESS 90/10 20.0 MHz 15 kHz SCS	39.86			1640	62.15

Antenna A - LTE / NR Modulation QPSK - LTE / NR Carrier Bandwidth ESS 40/60 10.0 MHz 15 kHz SCS - Channel Position T

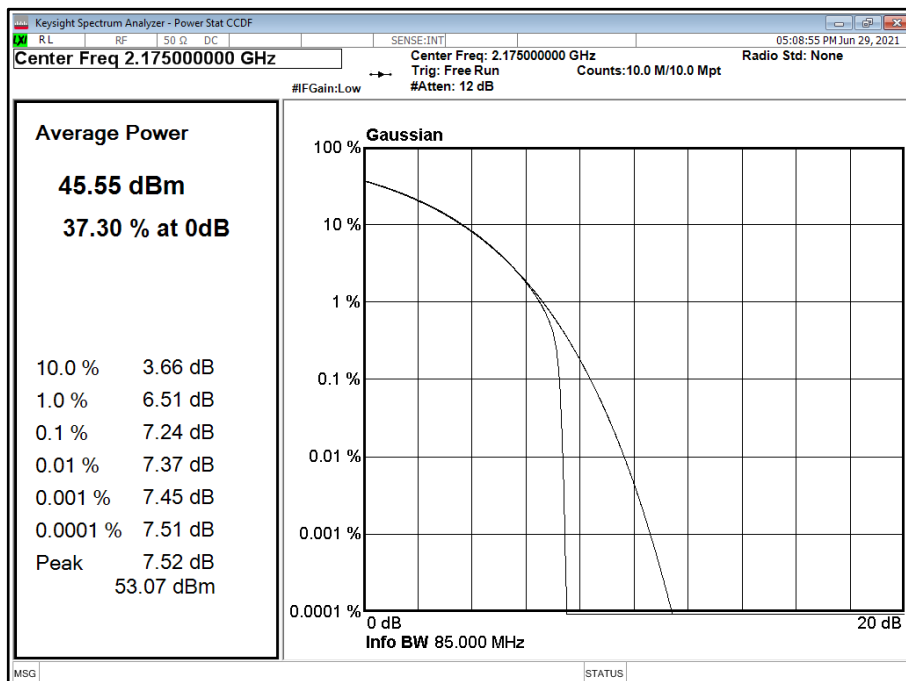



Antenna A - LTE / NR Modulation QPSK - LTE / NR Carrier Bandwidth ESS 40/60 20.0 MHz 15 kHz SCS - Channel Position T

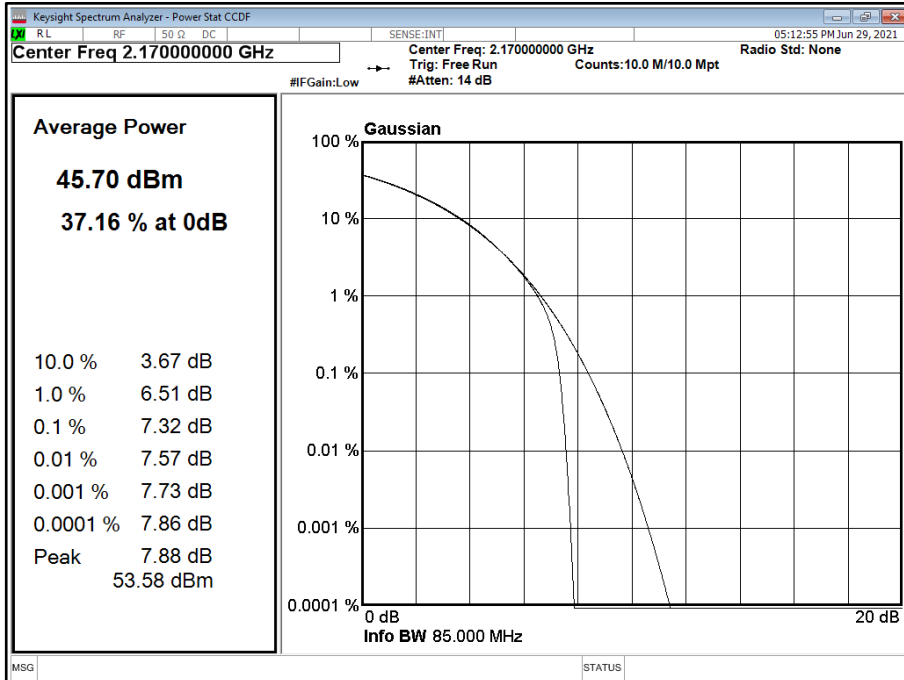

Antenna A - LTE / NR Modulation QPSK - LTE / NR Carrier Bandwidth ESS 10/90 10.0 MHz 15 kHz SCS - Channel Position T

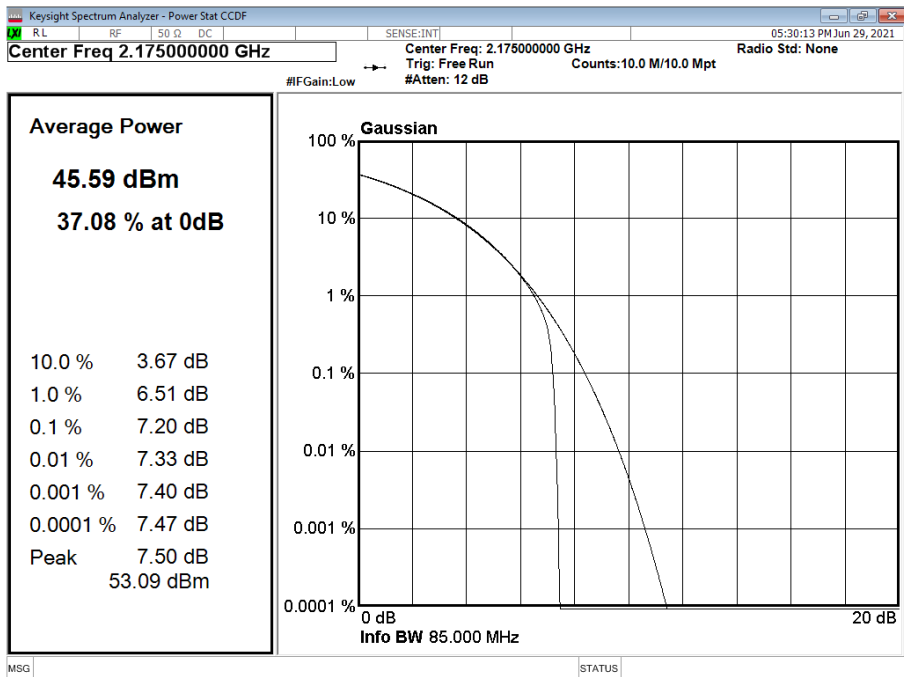



Antenna A - LTE / NR Modulation QPSK - LTE / NR Carrier Bandwidth ESS 10/90 20.0 MHz 15 kHz SCS - Channel Position T

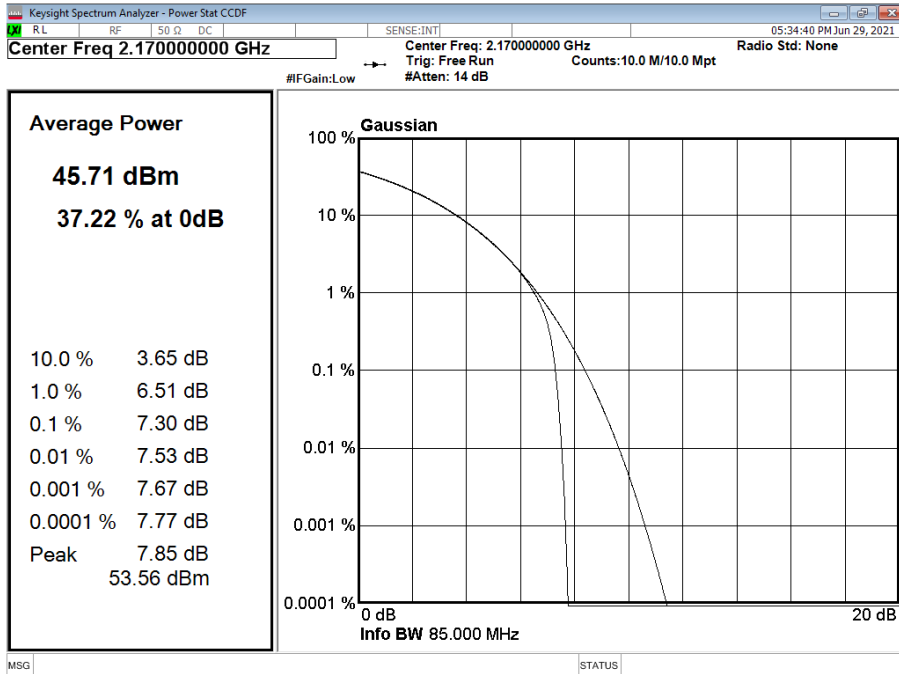

Antenna A - LTE / NR Modulation QPSK - LTE / NR Carrier Bandwidth ESS 90/10 10.0 MHz 15 kHz SCS - Channel Position T

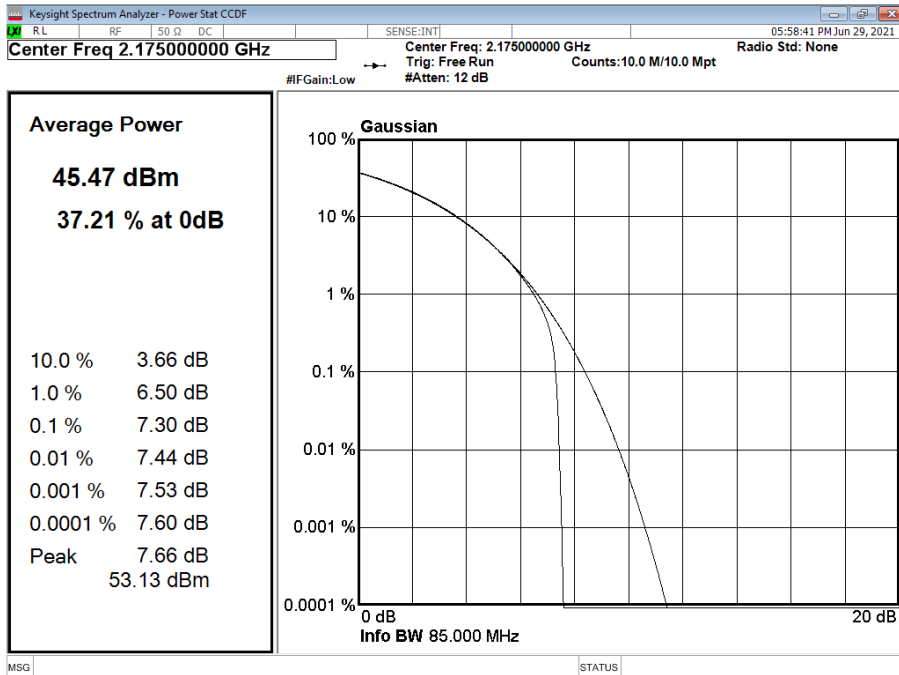



**Antenna A - LTE / NR Modulation QPSK - LTE / NR Carrier Bandwidth ESS 90/10 20.0 MHz 15 kHz SCS - Channel Position T**

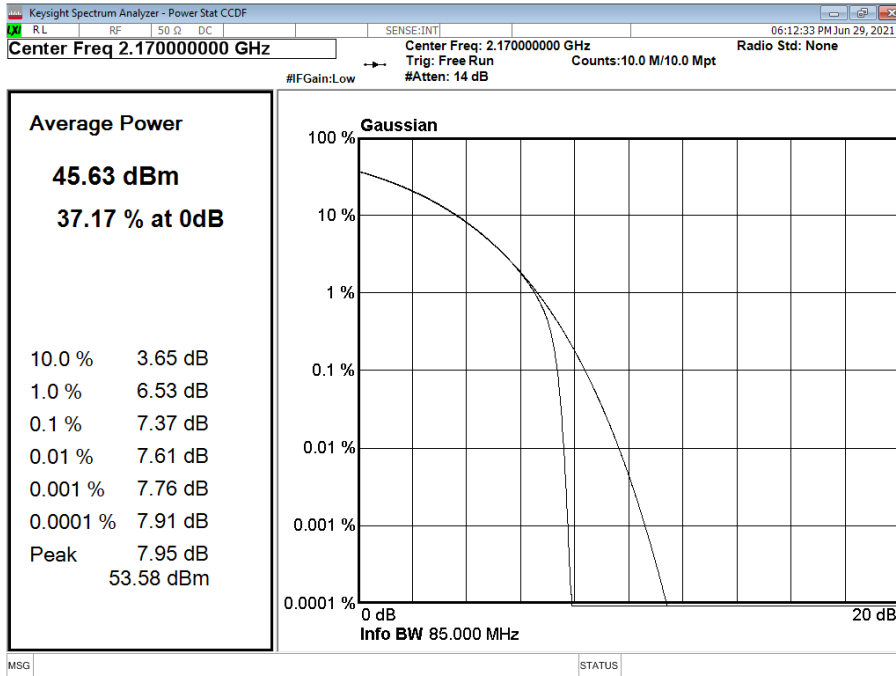

**Configuration 2**

Maximum Output Power 46.00 dBm

Antenna	LTE / NR Modulation	LTE / NR Carrier Bandwidth	Peak to Average Ratio (PAR) / Output Power / PSD				
			Channel Position B				
			PAR (dB)	Average Power/PSD		Total Power Port A+B+C+D	
			dBm	dBm/MHz	dBm	dBm/MHz	
A	QPSK	ESS 40/60 10.0 MHz 15 kHz SCS	-	45.61	32.46	51.63	38.48
A	QPSK	ESS 10/90 10.0 MHz 15 kHz SCS	-	45.67	32.45	51.69	38.47
A	QPSK	ESS 90/10 10.0 MHz 15 kHz SCS	-	45.55	32.20	51.57	38.22

**Configuration 2**

Maximum Output Power 46.00 dBm

Antenna	LTE / NR Modulation	LTE / NR Carrier Bandwidth	Peak to Average Ratio (PAR) / Output Power / PSD				
			Channel Position T				
			PAR (dB)	Average Power/PSD		Total Power Port A+B+C+D	
			dBm	dBm/MHz	dBm	dBm/MHz	
A	QPSK	ESS 40/60 10.0 MHz 15 kHz SCS	-	45.57	32.35	51.59	38.37
A	QPSK	ESS 10/90 10.0 MHz 15 kHz SCS	-	45.63	32.52	51.65	38.54
A	QPSK	ESS 90/10 10.0 MHz 15 kHz SCS	-	45.52	32.58	51.54	38.60





Configuration 3

Maximum Output Power 46.00 dBm

Antenna	NR Modulation	NR Carrier Bandwidth	Peak to Average Ratio (PAR) / Output Power / PSD				
			Channel Position B				
			PAR (dB)	Average Power/PSD		Total Power Port A+B+C+D	
dBm	dBm/MHz	dBm		dBm/MHz			
A	QPSK	10.0 MHz 15 kHz SCS	7.16	45.89	37.11	51.91	43.13
A	QPSK	20.0 MHz 15 kHz SCS	7.22	45.86	33.83	51.88	39.85

NR Carrier Bandwidth	Total Power PSD	Maximum Antenna gain	Maximum Total EIRP	EIRP Limit	EIRP Limit
	(dBm/MHz)	(dBi)	(dBm/MHz)	(W/MHz)	(dBm/MHz)
10.0 MHz 15 kHz SCS	43.13			1640	62.15
20.0 MHz 15 kHz SCS	39.85			1640	62.15

Antenna A - NR Modulation QPSK - NR Carrier Bandwidth 10.0 MHz 15 kHz SCS - Channel Position B

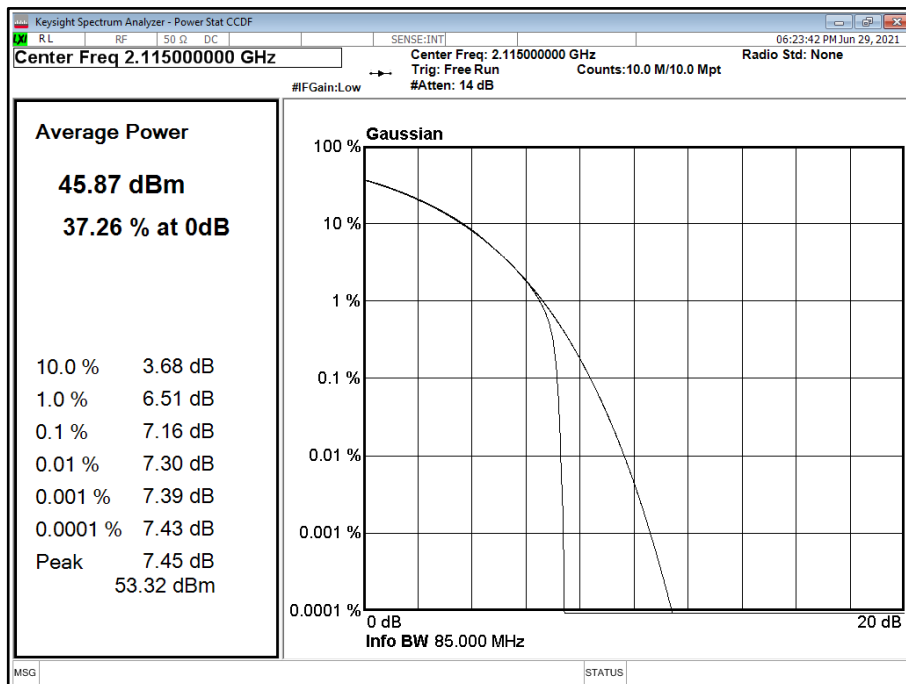



**Antenna A - NR Modulation QPSK - NR Carrier Bandwidth 20.0 MHz 15 kHz SCS - Channel Position B**

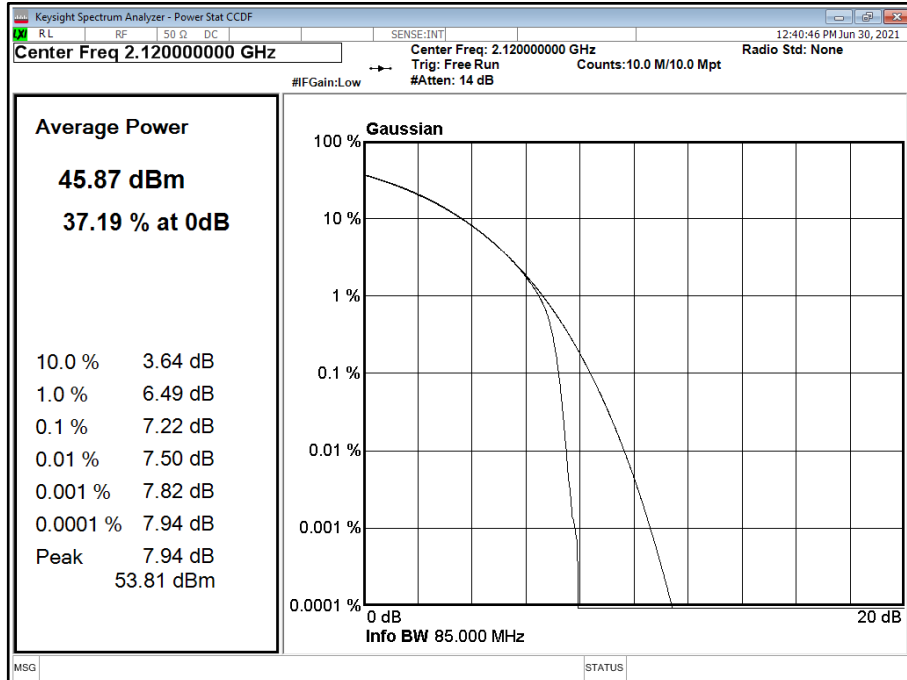

**Configuration 3**

Maximum Output Power 46.00 dBm

Antenna	NR Modulation	NR Carrier Bandwidth	Peak to Average Ratio (PAR) / Output Power / PSD				
			Channel Position M				
			PAR (dB)	Average Power/PSD		Total Power Port A+B+C+D	
			dBm	dBm/MHz	dBm	dBm/MHz	
A	QPSK	10.0 MHz 15 kHz SCS	7.12	45.88	36.96	51.90	42.98
A	QPSK	20.0 MHz 15 kHz SCS	7.13	45.94	33.82	51.96	39.84

NR Carrier Bandwidth	Total Power PSD (dBm/MHz)	Maximum Antenna gain (dBi)	Maximum Total EIRP (dBm/MHz)	EIRP Limit (W/MHz)	EIRP Limit (dBm/MHz)
10.0 MHz 15 kHz SCS	43.51			1640	62.15
20.0 MHz 15 kHz SCS	40.33			1640	62.15



Antenna A - NR Modulation QPSK - NR Carrier Bandwidth 10.0 MHz 15 kHz SCS - Channel Position M

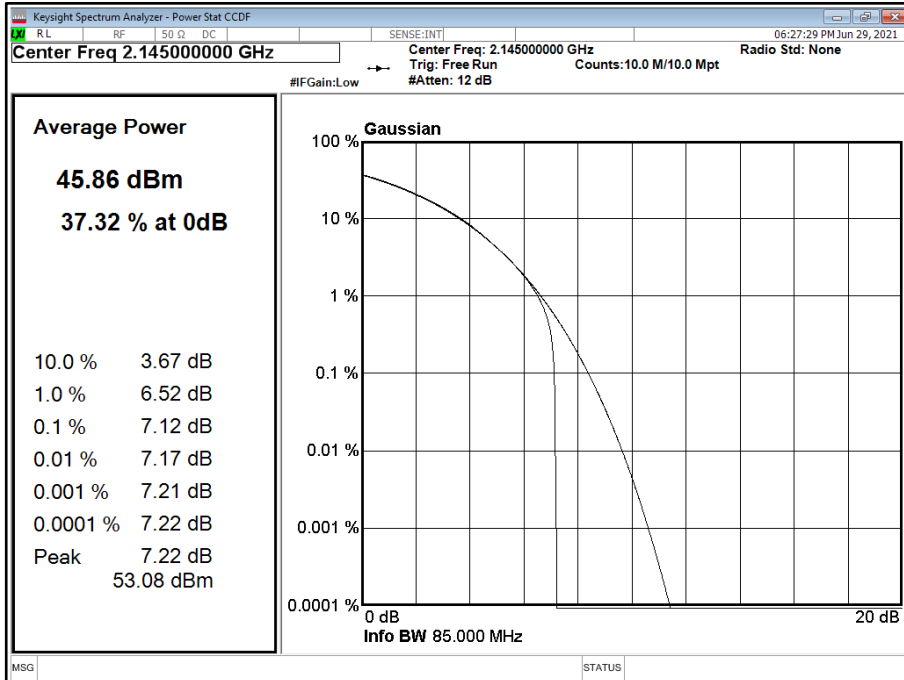

Antenna A - NR Modulation QPSK - NR Carrier Bandwidth 20.0 MHz 15 kHz SCS - Channel Position M

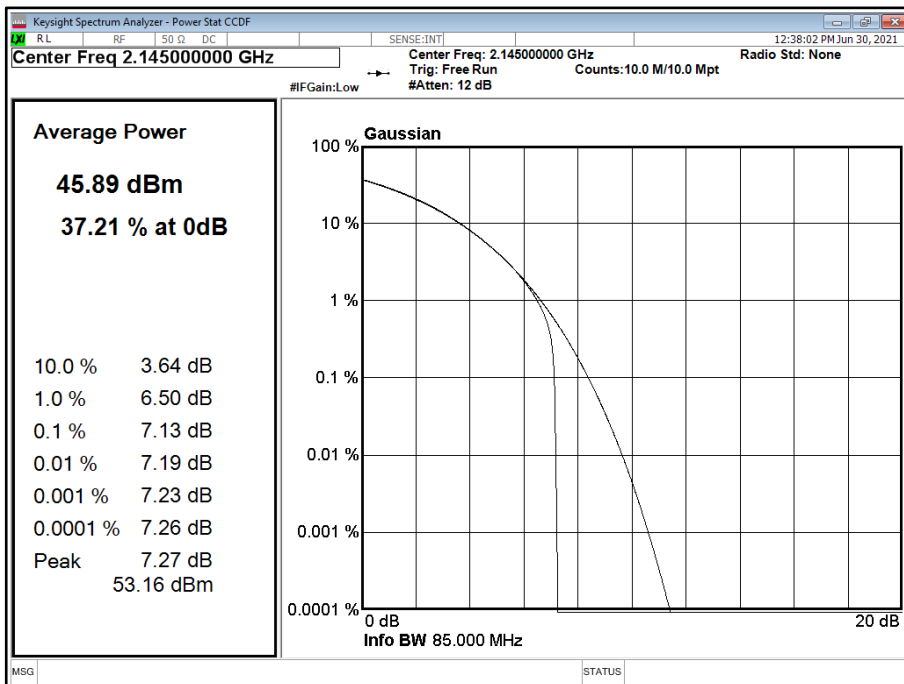



Configuration 3

Maximum Output Power 46.00 dBm

Antenna	NR Modulation	NR Carrier Bandwidth	Peak to Average Ratio (PAR) / Output Power / PSD				
			Channel Position T				
			PAR (dB)	Average Power/PSD		Total Power Port A+B+C+D	
dBm	dBm/MHz	dBm		dBm/MHz			
A	QPSK	10.0 MHz 15 kHz SCS	7.12	45.66	36.88	51.68	42.90
A	QPSK	20.0 MHz 15 kHz SCS	7.23	45.88	34.18	51.90	40.20

NR Carrier Bandwidth	Total Power PSD	Maximum Antenna gain	Maximum Total EIRP	EIRP Limit	EIRP Limit
	(dBm/MHz)	(dBi)	(dBm/MHz)	(W/MHz)	(dBm/MHz)
10.0 MHz 15 kHz SCS	42.90			1640	62.15
20.0 MHz 15 kHz SCS	40.20			1640	62.15

Antenna A - NR Modulation QPSK - NR Carrier Bandwidth 10.0 MHz 15 kHz SCS - Channel Position T

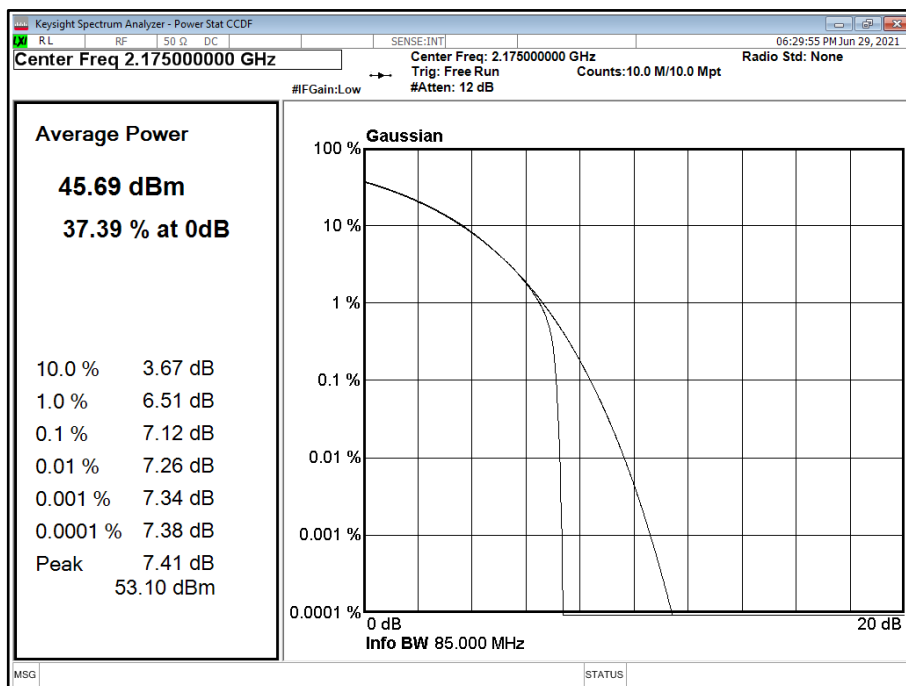



**Antenna A - NR Modulation QPSK - NR Carrier Bandwidth 20.0 MHz 15 kHz SCS - Channel Position T**

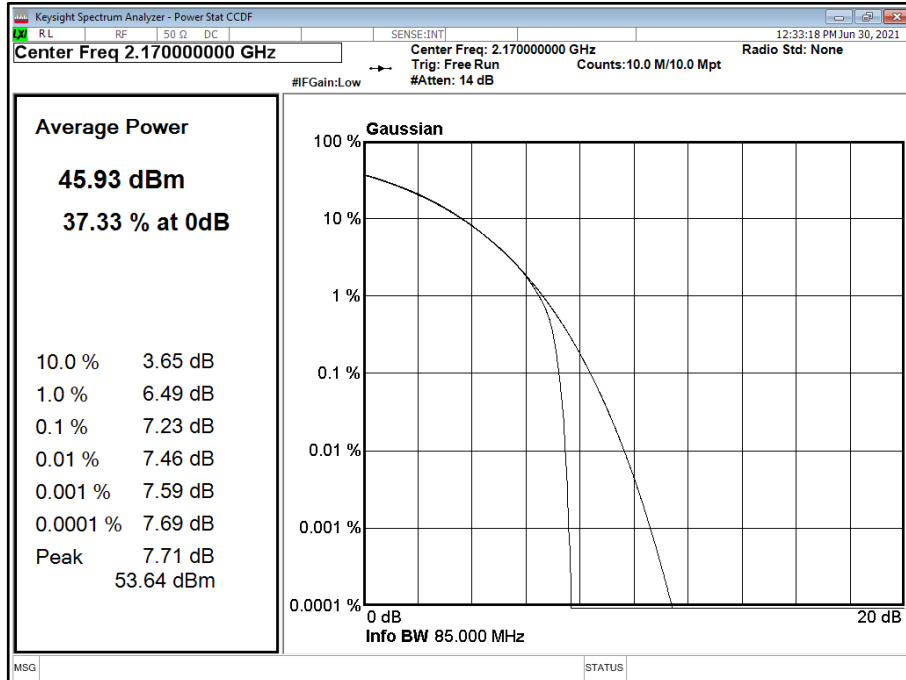

**Configuration 4**

Maximum Output Power 46.00 dBm

Antenna	NR Modulation	NR Carrier Bandwidth	Peak to Average Ratio (PAR) / Output Power / PSD				
			Channel Position B				
			PAR (dB)	Average Power/PSD		Total Power Port A+B+C+D	
			dBm	dBm/MHz	dBm	dBm/MHz	
A	QPSK	10.0 MHz 15 kHz SCS	-	45.79	32.57	51.81	38.59

**Configuration 4**

Maximum Output Power 46.00 dBm

Antenna	NR Modulation	NR Carrier Bandwidth	Peak to Average Ratio (PAR) / Output Power / PSD				
			Channel Position T				
			PAR (dB)	Average Power/PSD		Total Power Port A+B+C+D	
			dBm	dBm/MHz	dBm	dBm/MHz	
A	QPSK	10.0 MHz 15 kHz SCS	-	45.72	32.26	51.74	38.28



Limit	
Maximum rated output power (Non-Rural)	$\leq 1640$ W/MHz or $\leq +62.15$ dBm/MHz
Maximum rated output power (Rural)	$\leq 3280$ W/MHz or $\leq +65.15$ dBm/MHz
Peak to Average Ratio	13 dB

The radio unit was tested with maximum output power and without an antenna. ERP/EIRP compliance is addressed at the time of licensing, as required by the responsible FCC/ISED Bureau(s). Licensees are required to take into account maximum allowed antenna gain used in combination with the applicable power settings to prevent the radiated output power exceeding the limits.



## **2.2 OCCUPIED BANDWIDTH**

### **2.2.1 Specification Reference**

FCC CFR 47 Part 27, Clause 27.53  
ISED RSS-GEN, Clause 6.6  
FCC CFR 47 Part 2, Clause 2.1049

### **2.2.2 Date of Test and Modification State**

29 and 30 June 2021 - Modification State 0

### **2.2.3 Test Equipment Used**

The major items of test equipment used for the above tests are identified in Section 3.1.

### **2.2.4 Environmental Conditions**

Ambient Temperature	23.4 - 25.2°C
Relative Humidity	37.2 - 40.8%

### **2.2.5 Test Method**

All measurements were made in accordance with FCC KDB 971168 D01, Clause 4.3. The Spectrum Analyser RBW was configured to be at least 1% of the channel bandwidth of the carrier to be measured.

For 26 dB Bandwidth, in accordance with KDB 971168 D01, a peak detector and a trace setting of Max Hold were used. The trace was allowed to stabilise. Using the Spectrum Analyser function, the 26dB measurement result was obtained.

4.3 Occupied bandwidth – power bandwidth (99 %) measurement procedure  
Subclause 5.4.4 of ANSI C63.26-2015 is applicable (wherein the recommendation is to use the 99 % power bandwidth function of a spectrum analyser).

### **2.2.6 Test Results**

Configuration 1

Maximum Output Power 46.00 dBm



Antenna	LTE / NR Modulation	LTE / NR Carrier Bandwidth	Result (kHz)					
			Channel Position B		Channel Position M		Channel Position T	
			Occupied Bandwidth	-26 dB Bandwidth	Occupied Bandwidth	-26 dB Bandwidth	Occupied Bandwidth	-26 dB Bandwidth
A	QPSK	ESS 40/60 10.0 MHz 15 kHz SCS	9134.17	9728.04	9114.06	9713.60	9125.40	9739.00
A	QPSK	ESS 40/60 20.0 MHz 15 kHz SCS	18438.00	19570.00	18396.00	19550.00	18380.00	19600.00
A	QPSK	ESS 10/90 10.0 MHz 15 kHz SCS	9140.89	9731.45	9135.21	9703.83	9125.39	9738.13
A	QPSK	ESS 10/90 20.0 MHz 15 kHz SCS	18387.19	19642.26	18391.02	19571.14	18399.80	19470.69
A	QPSK	ESS 90/10 10.0 MHz 15 kHz SCS	9129.81	9784.63	9127.44	9769.10	9127.22	9721.95
A	QPSK	ESS 90/10 20.0 MHz 15 kHz SCS	18397.74	19703.08	18406.37	19603.13	18445.54	19508.58

Antenna A - LTE / NR Modulation QPSK - LTE / NR Carrier Bandwidth ESS 40/60 10.0 MHz 15 kHz SCS - Channel Position B

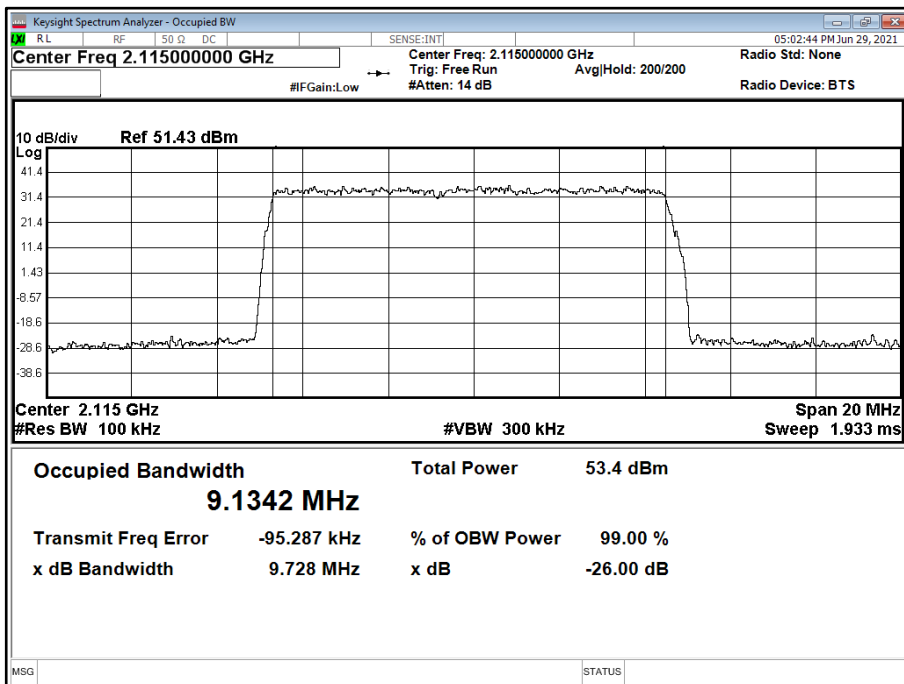





Antenna A - LTE / NR Modulation QPSK - LTE / NR Carrier Bandwidth ESS 40/60 10.0 MHz 15 kHz SCS - Channel Position M

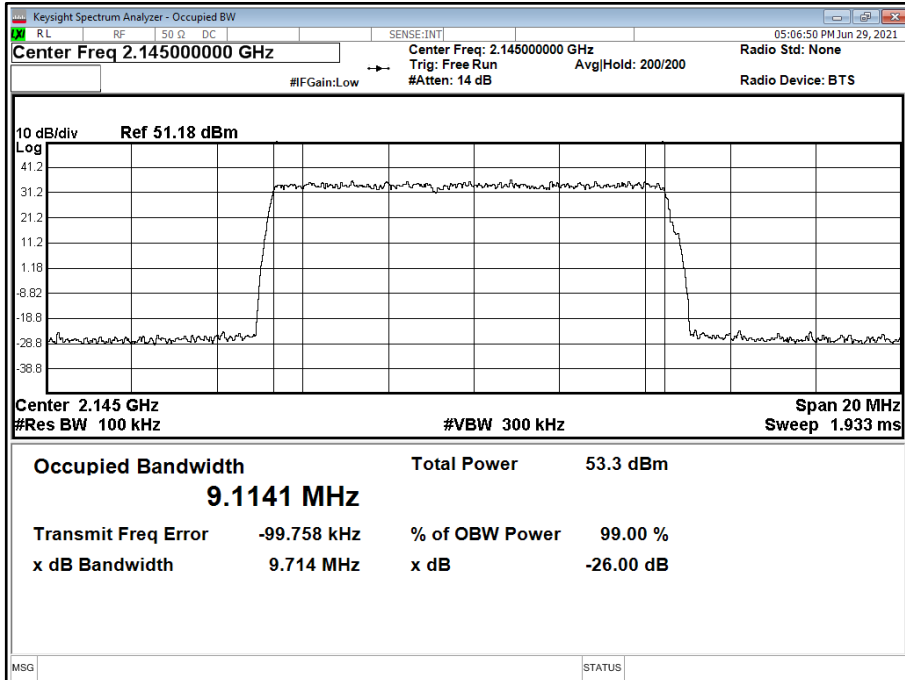

Antenna A - LTE / NR Modulation QPSK - LTE / NR Carrier Bandwidth ESS 40/60 10.0 MHz 15 kHz SCS - Channel Position T

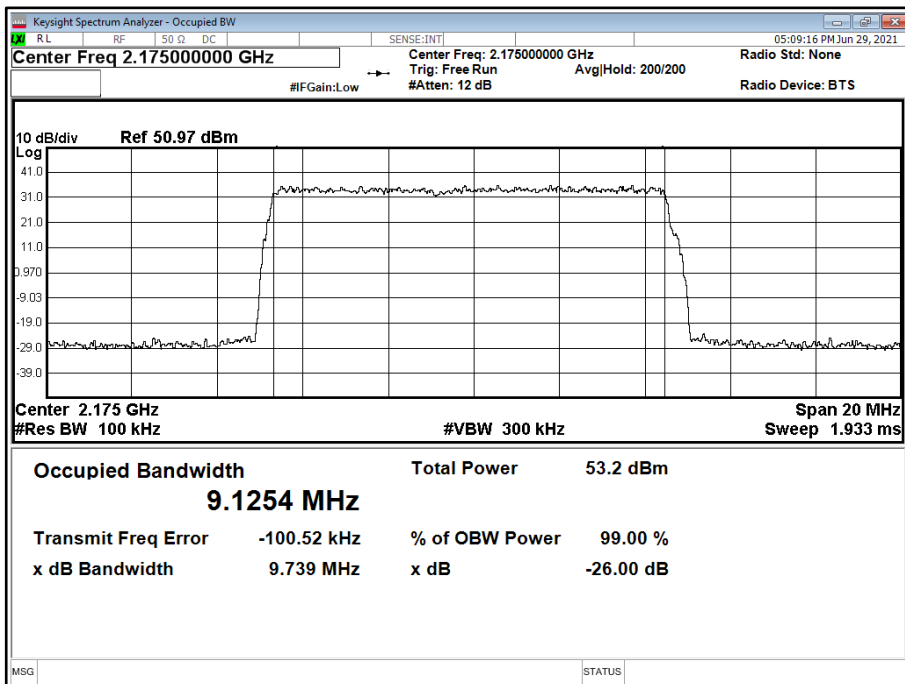



Antenna A - LTE / NR Modulation QPSK - LTE / NR Carrier Bandwidth ESS 40/60 20.0 MHz 15 kHz SCS - Channel Position B

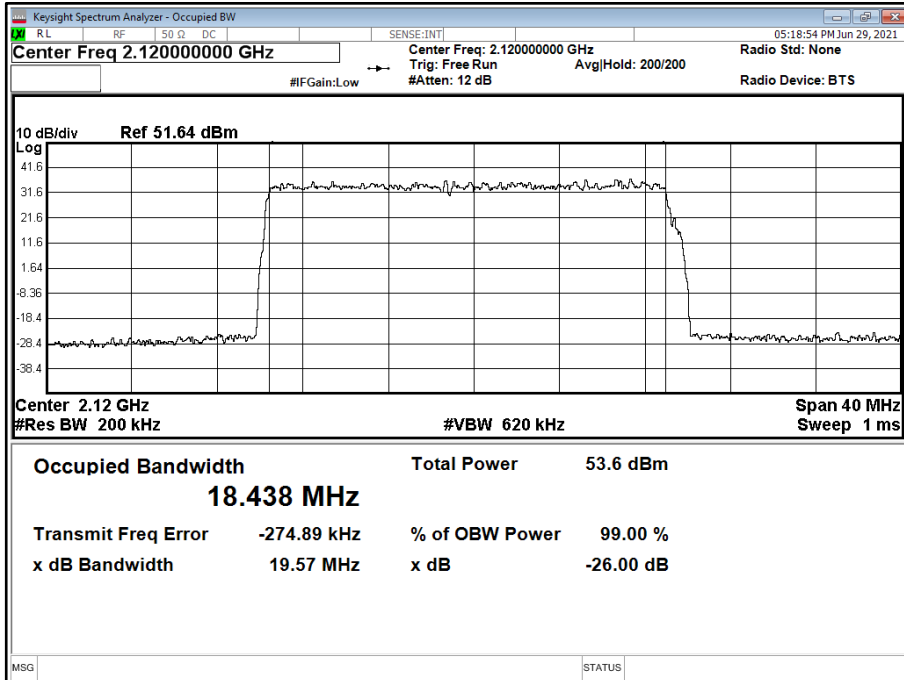

Antenna A - LTE / NR Modulation QPSK - LTE / NR Carrier Bandwidth ESS 40/60 20.0 MHz 15 kHz SCS - Channel Position M

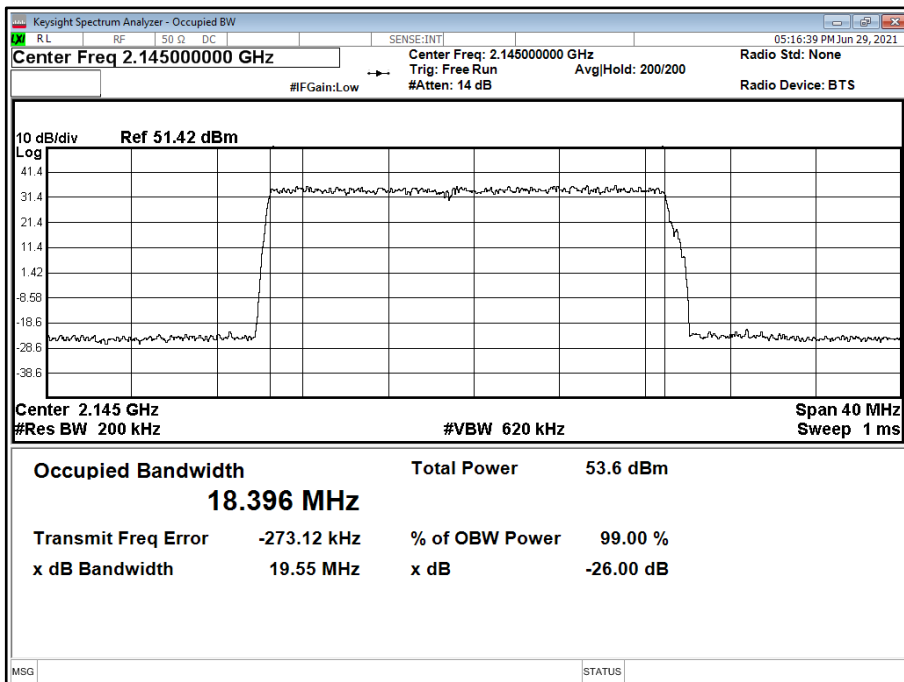



Antenna A - LTE / NR Modulation QPSK - LTE / NR Carrier Bandwidth ESS 40/60 20.0 MHz 15 kHz SCS - Channel Position T

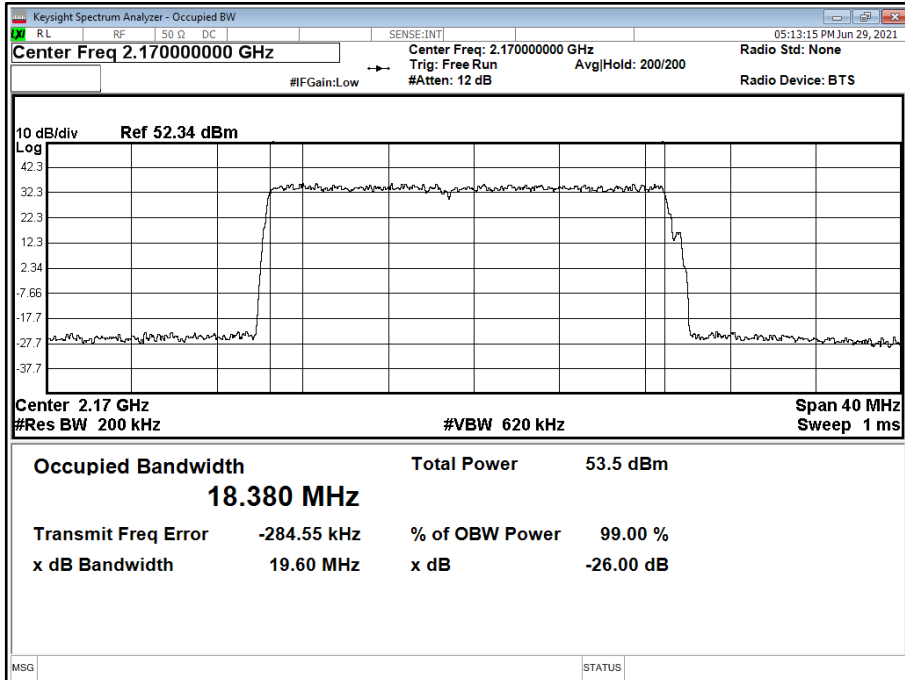

Antenna A - LTE / NR Modulation QPSK - LTE / NR Carrier Bandwidth ESS 10/90 10.0 MHz 15 kHz SCS - Channel Position B

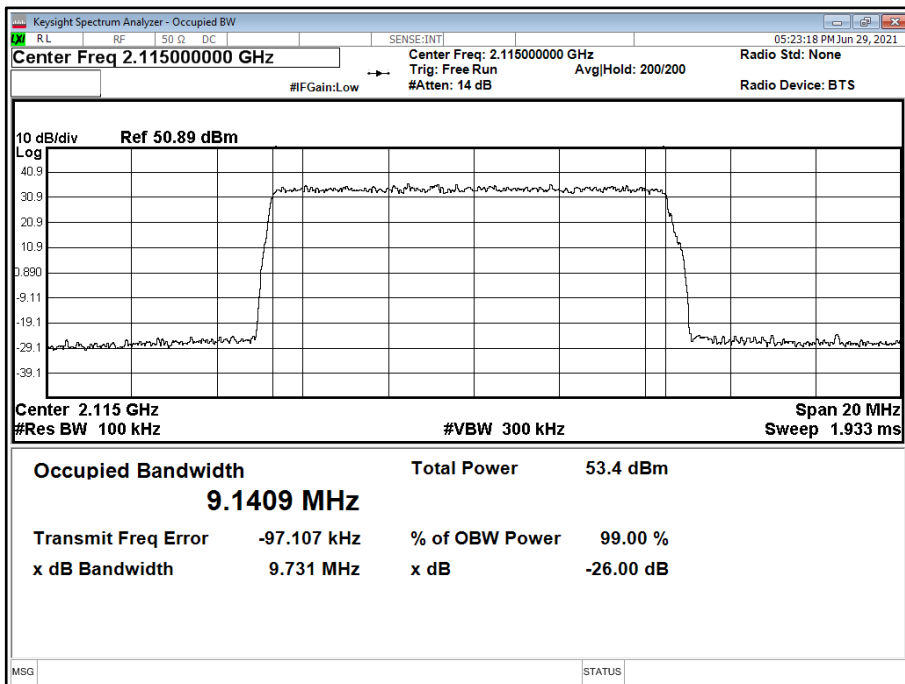



Antenna A - LTE / NR Modulation QPSK - LTE / NR Carrier Bandwidth ESS 10/90 10.0 MHz 15 kHz SCS - Channel Position M

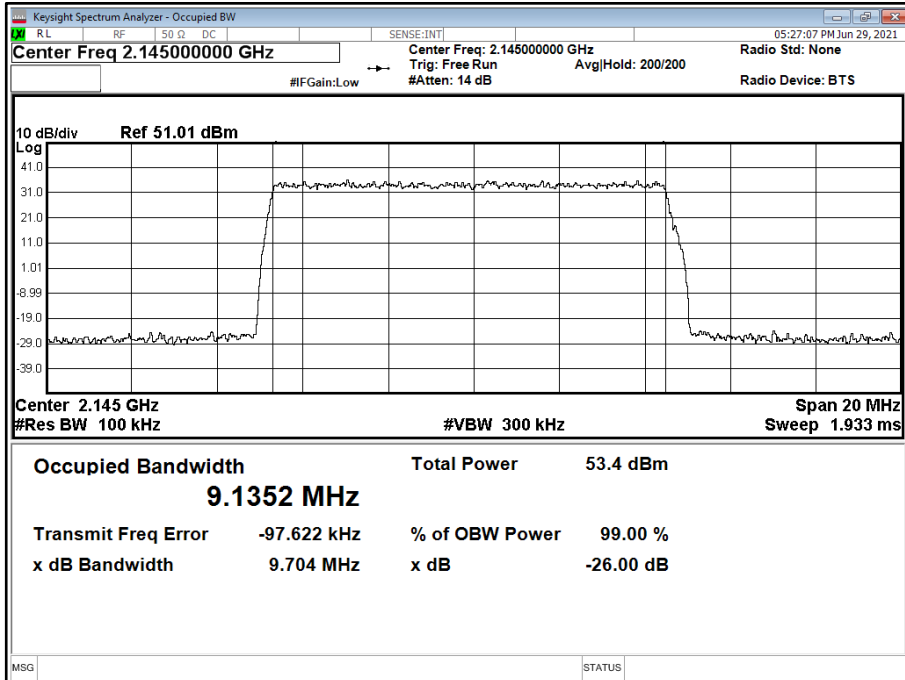

Antenna A - LTE / NR Modulation QPSK - LTE / NR Carrier Bandwidth ESS 10/90 10.0 MHz 15 kHz SCS - Channel Position T

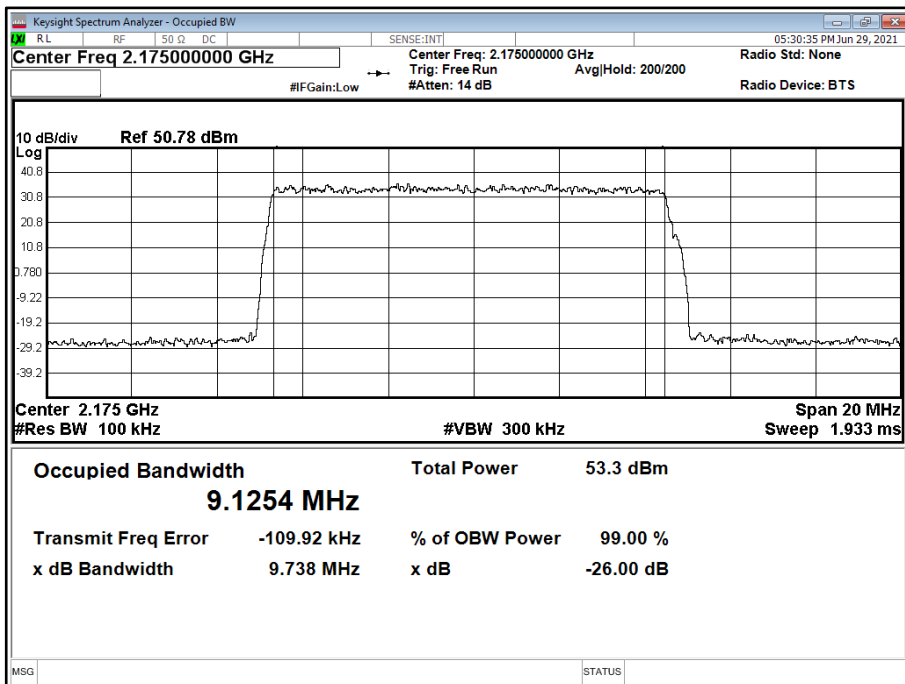



Antenna A - LTE / NR Modulation QPSK - LTE / NR Carrier Bandwidth ESS 10/90 20.0 MHz 15 kHz SCS - Channel Position B

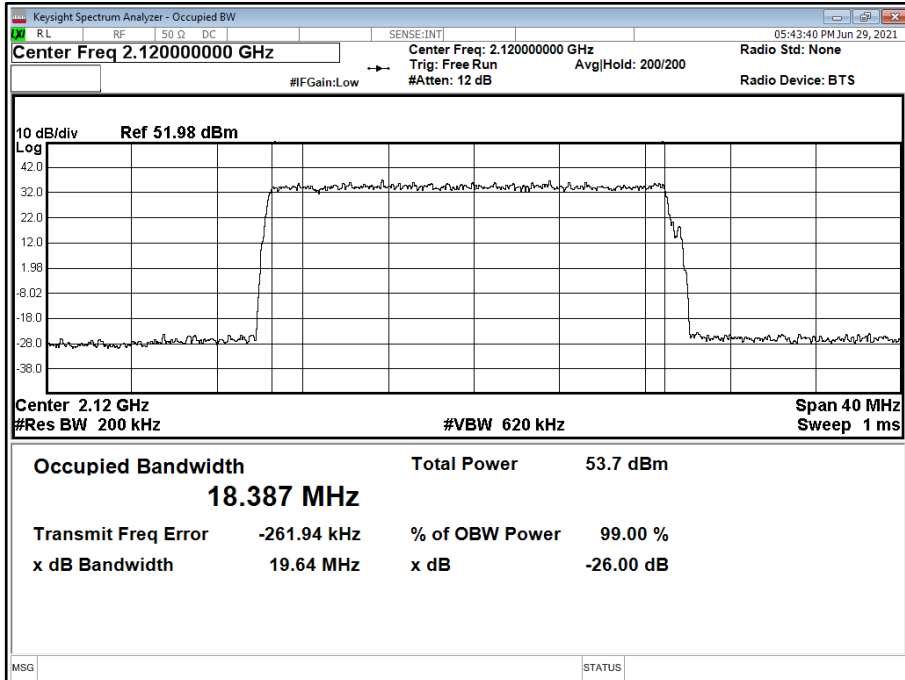

Antenna A - LTE / NR Modulation QPSK - LTE / NR Carrier Bandwidth ESS 10/90 20.0 MHz 15 kHz SCS - Channel Position M

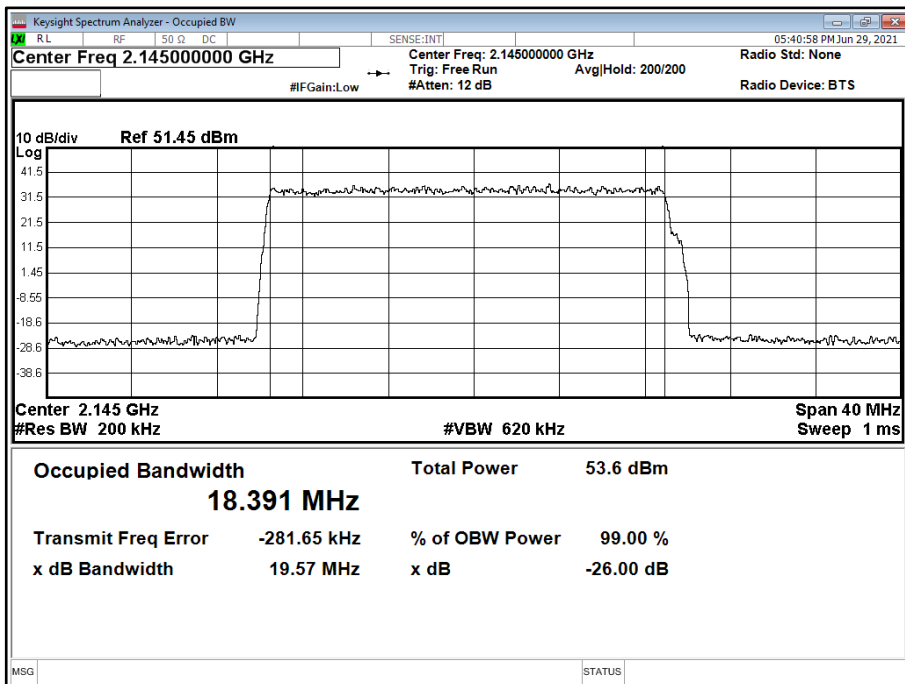



Antenna A - LTE / NR Modulation QPSK - LTE / NR Carrier Bandwidth ESS 10/90 20.0 MHz 15 kHz SCS - Channel Position T

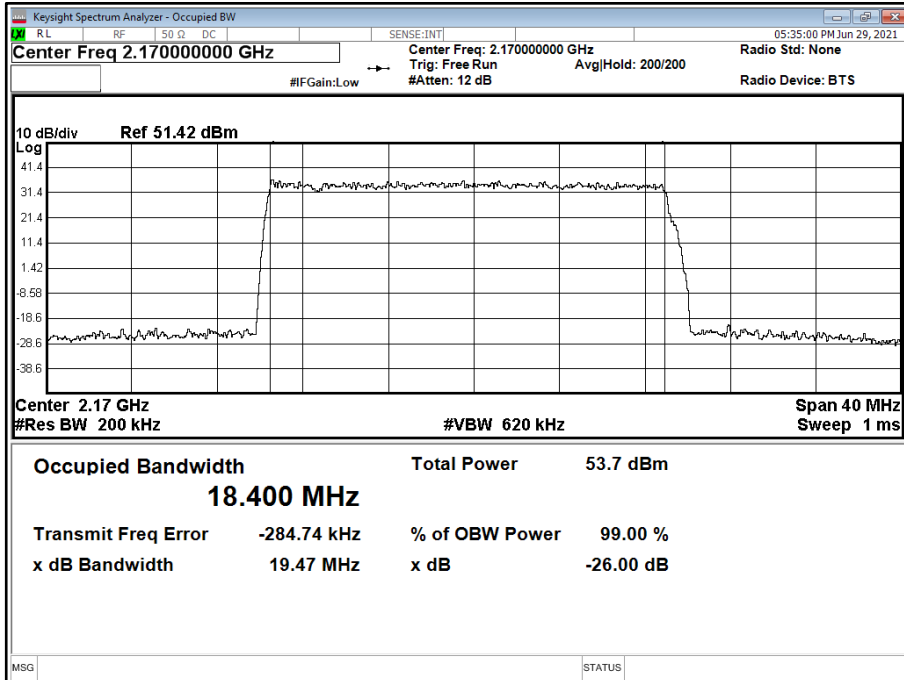

Antenna A - LTE / NR Modulation QPSK - LTE / NR Carrier Bandwidth ESS 90/10 10.0 MHz 15 kHz SCS - Channel Position B

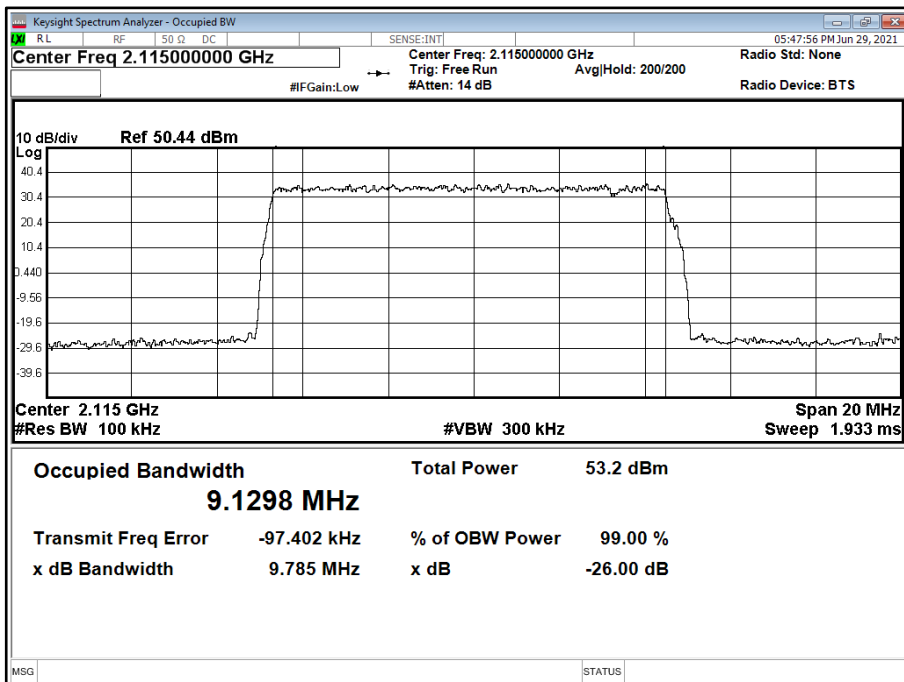



Antenna A - LTE / NR Modulation QPSK - LTE / NR Carrier Bandwidth ESS 90/10 10.0 MHz 15 kHz SCS - Channel Position M

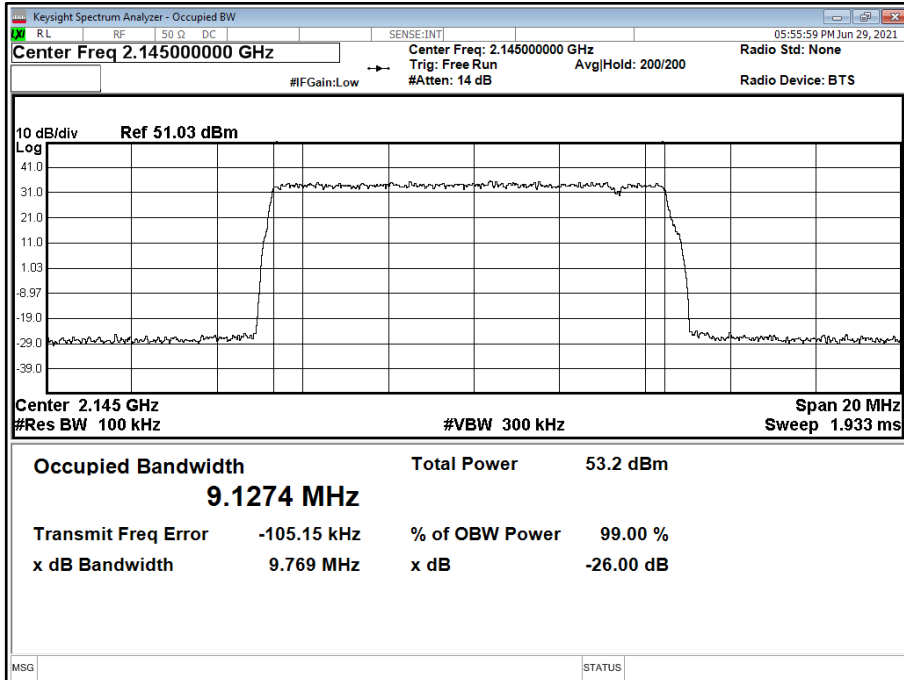

Antenna A - LTE / NR Modulation QPSK - LTE / NR Carrier Bandwidth ESS 90/10 10.0 MHz 15 kHz SCS - Channel Position T

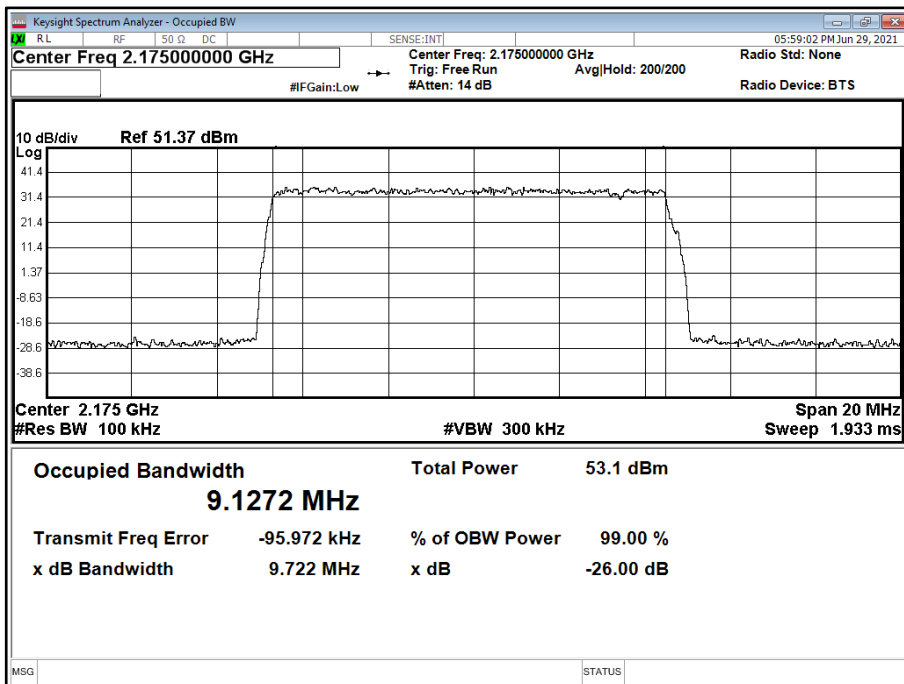



Antenna A - LTE / NR Modulation QPSK - LTE / NR Carrier Bandwidth ESS 90/10 20.0 MHz 15 kHz SCS - Channel Position B

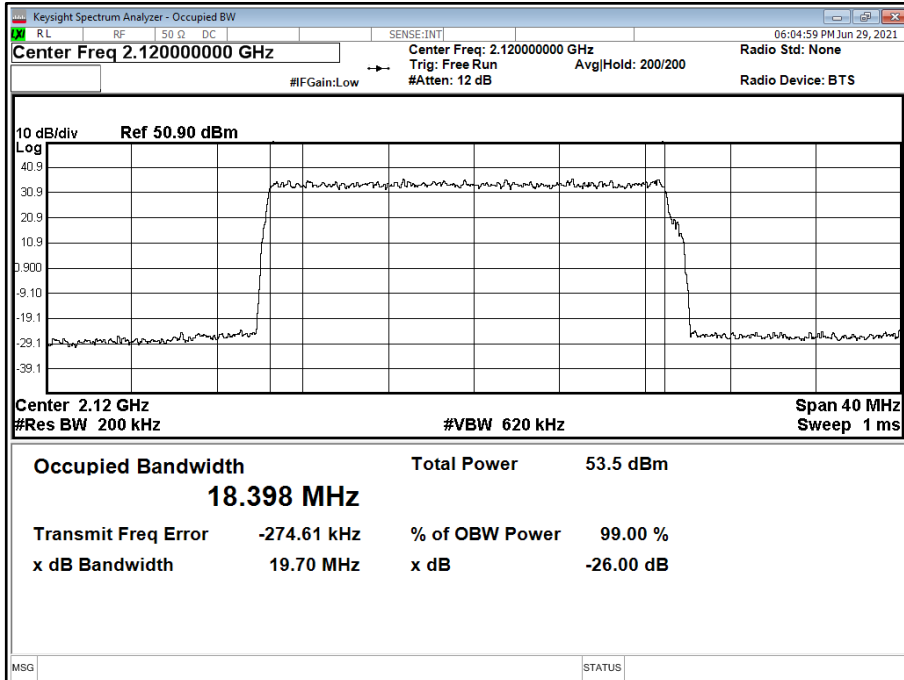

Antenna A - LTE / NR Modulation QPSK - LTE / NR Carrier Bandwidth ESS 90/10 20.0 MHz 15 kHz SCS - Channel Position M

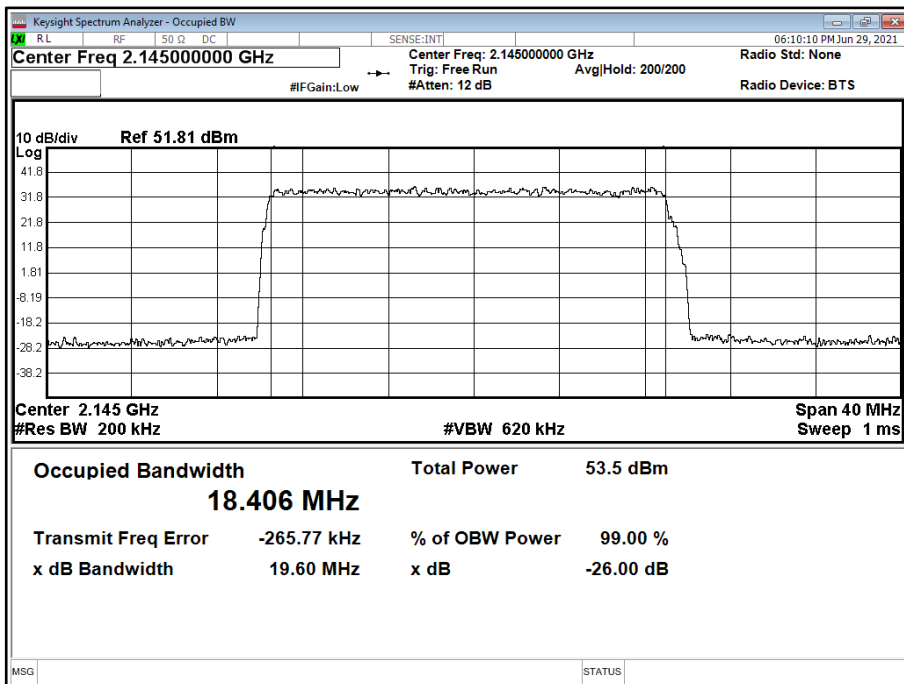





Antenna A - LTE / NR Modulation QPSK - LTE / NR Carrier Bandwidth ESS 90/10 20.0 MHz 15 kHz SCS - Channel Position T

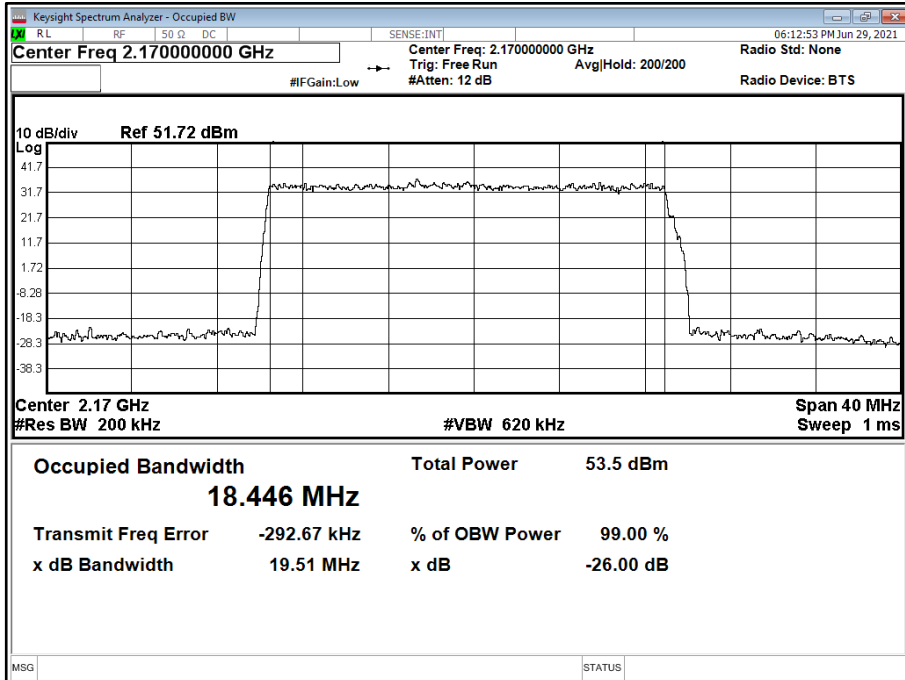

Configuration 2

Maximum Output Power 46.00 dBm

Antenna	LTE / NR Modulation	LTE / NR Carrier Bandwidth	Result (kHz)					
			Channel Position B		Channel Position M		Channel Position T	
			Occupied Bandwidth	-26 dB Bandwidth	Occupied Bandwidth	-26 dB Bandwidth	Occupied Bandwidth	-26 dB Bandwidth
A	QPSK	ESS 40/60 10.0 MHz 15 kHz SCS	29040.54	29916.68	-	-	29042.57	29944.76
A	QPSK	ESS 10/90 10.0 MHz 15 kHz SCS	29002.59	29899.96	-	-	29014.87	29966.64
A	QPSK	ESS 90/10 10.0 MHz 15 kHz SCS	29000.53	29972.83	-	-	28997.67	29973.99



Antenna A - LTE / NR Modulation QPSK - LTE / NR Carrier Bandwidth ESS 40/60 10.0 MHz 15 kHz SCS - Channel Position B

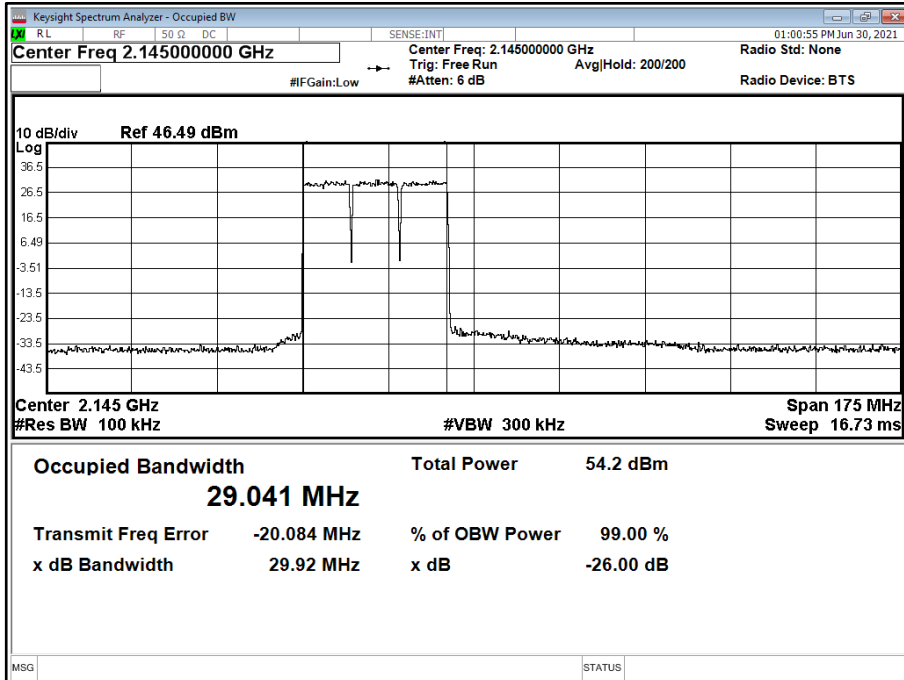

Antenna A - LTE / NR Modulation QPSK - LTE / NR Carrier Bandwidth ESS 40/60 10.0 MHz 15 kHz SCS - Channel Position T

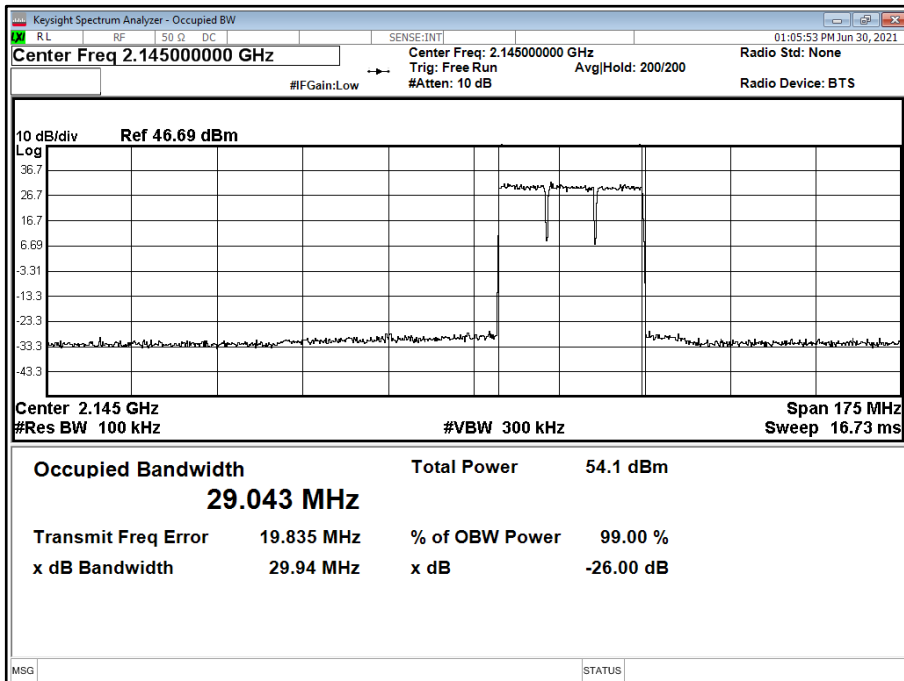



Antenna A - LTE / NR Modulation QPSK - LTE / NR Carrier Bandwidth ESS 10/90 10.0 MHz 15 kHz SCS - Channel Position B

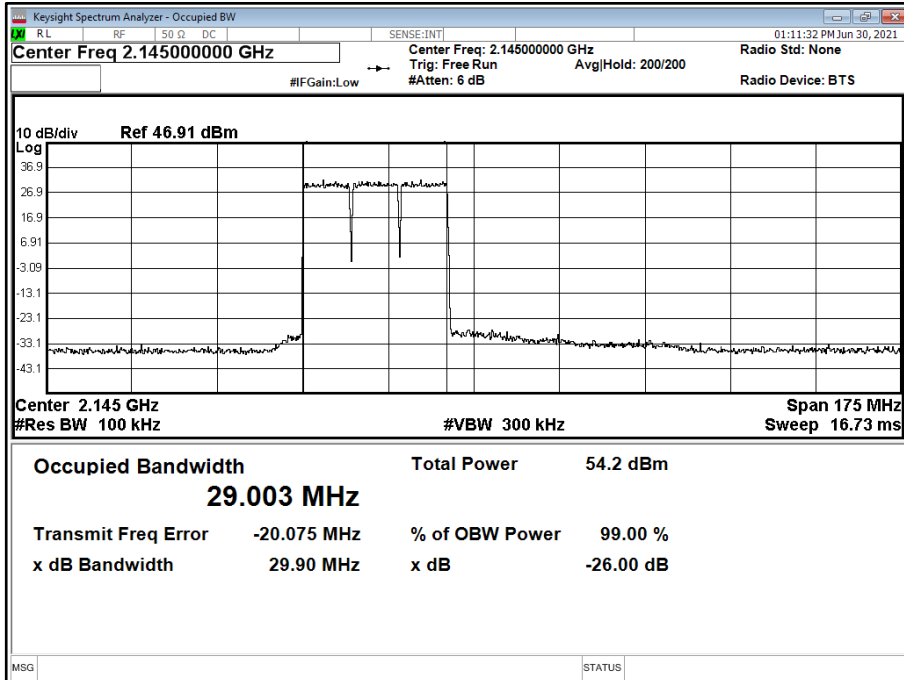

Antenna A - LTE / NR Modulation QPSK - LTE / NR Carrier Bandwidth ESS 10/90 10.0 MHz 15 kHz SCS - Channel Position T

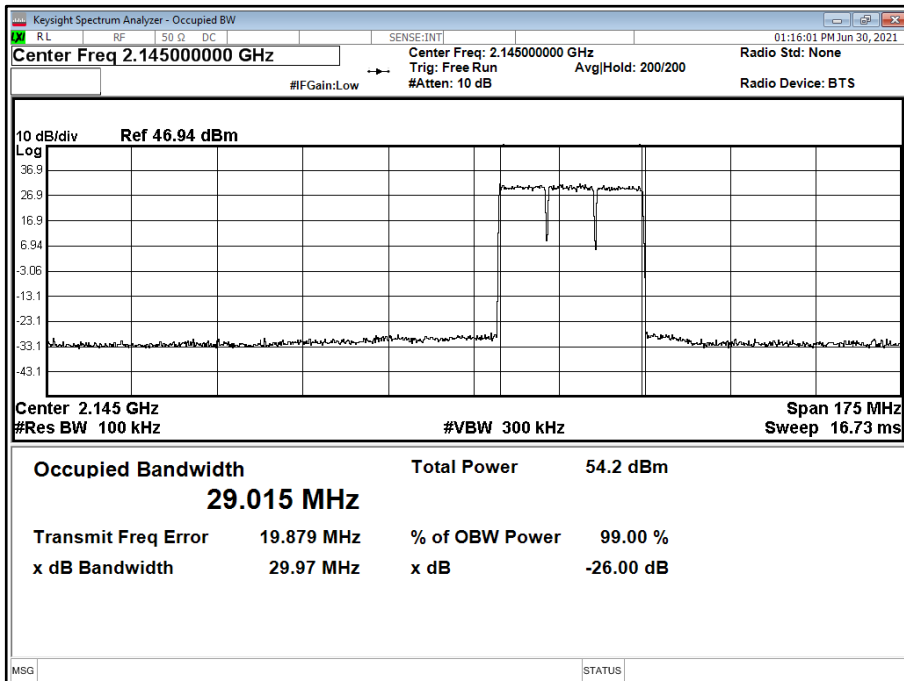



Antenna A - LTE / NR Modulation QPSK - LTE / NR Carrier Bandwidth ESS 90/10 10.0 MHz 15 kHz SCS - Channel Position B

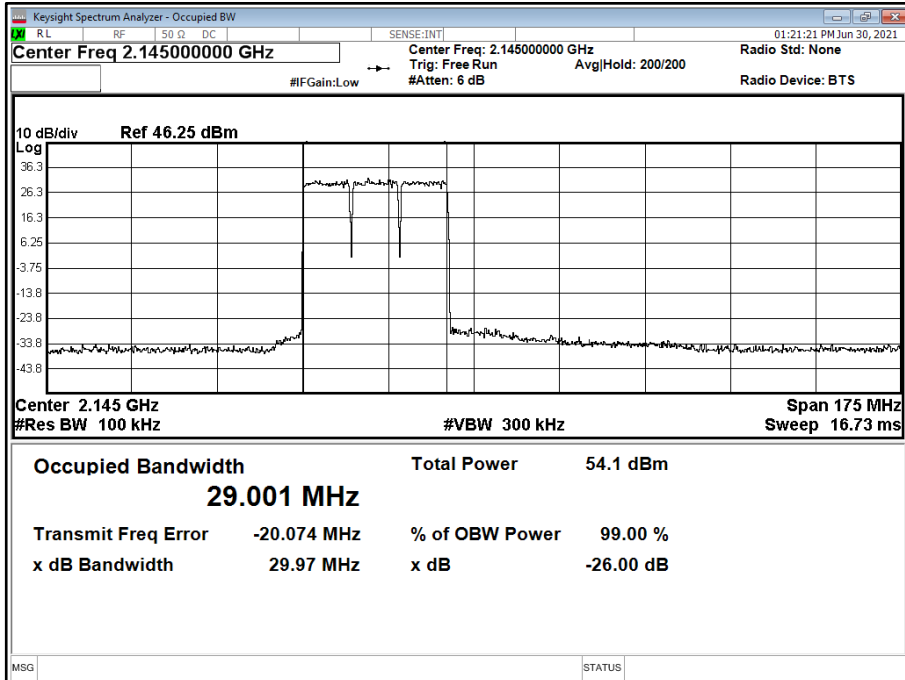

Antenna A - LTE / NR Modulation QPSK - LTE / NR Carrier Bandwidth ESS 90/10 10.0 MHz 15 kHz SCS - Channel Position T

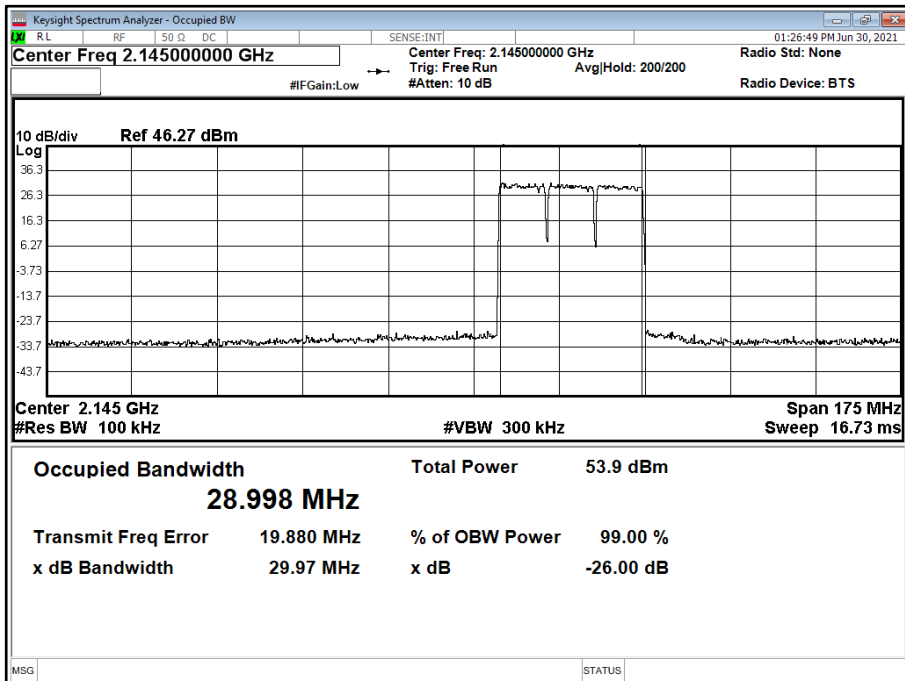



Configuration 3

Maximum Output Power 46.00 dBm

Antenna	NR Modulation	NR Carrier Bandwidth	Result (kHz)					
			Channel Position B		Channel Position M		Channel Position T	
			Occupied Bandwidth	-26 dB Bandwidth	Occupied Bandwidth	-26 dB Bandwidth	Occupied Bandwidth	-26 dB Bandwidth
A	QPSK	10.0 MHz 15 kHz SCS	9281.98	9756.34	9289.02	9741.19	9281.28	9758.59
A	QPSK	20.0 MHz 15 kHz SCS	18930.95	19746.25	18898.29	19679.65	18914.57	19660.18

Antenna A - NR Modulation QPSK - NR Carrier Bandwidth 10.0 MHz 15 kHz SCS - Channel Position B

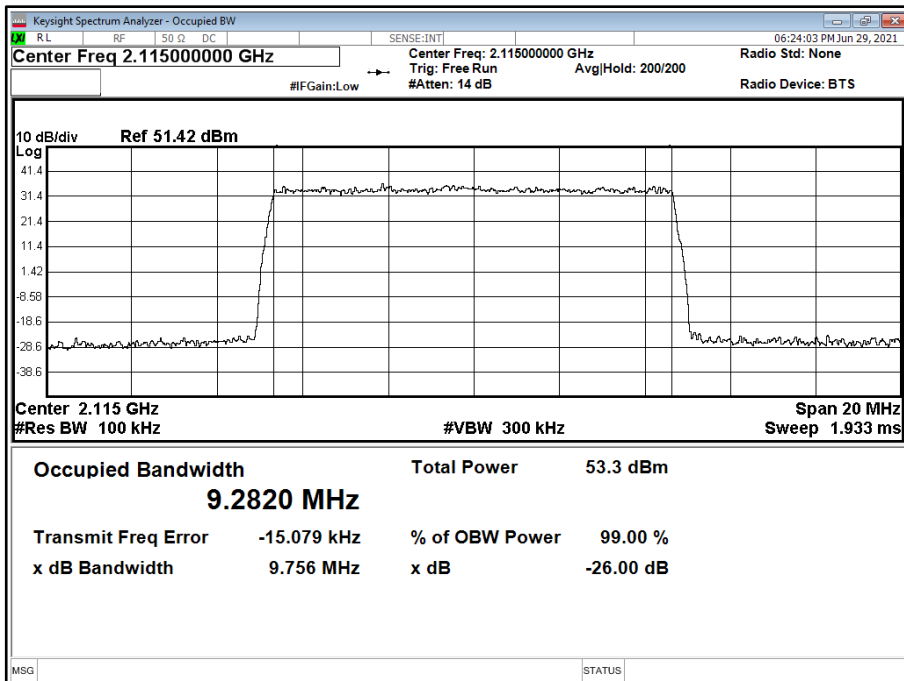



Antenna A - NR Modulation QPSK - NR Carrier Bandwidth 10.0 MHz 15 kHz SCS - Channel Position M

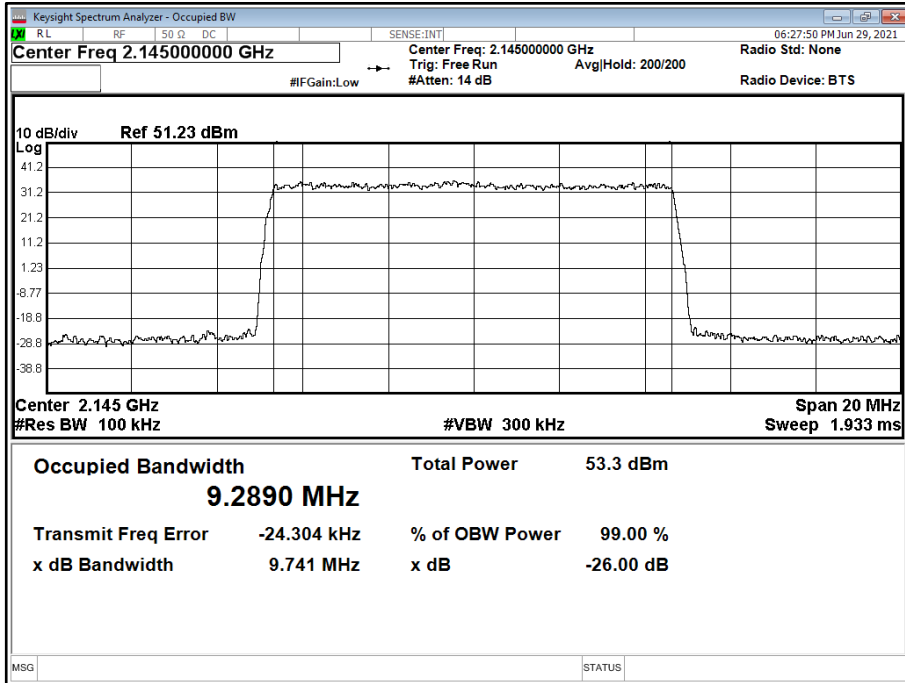

Antenna A - NR Modulation QPSK - NR Carrier Bandwidth 10.0 MHz 15 kHz SCS - Channel Position T

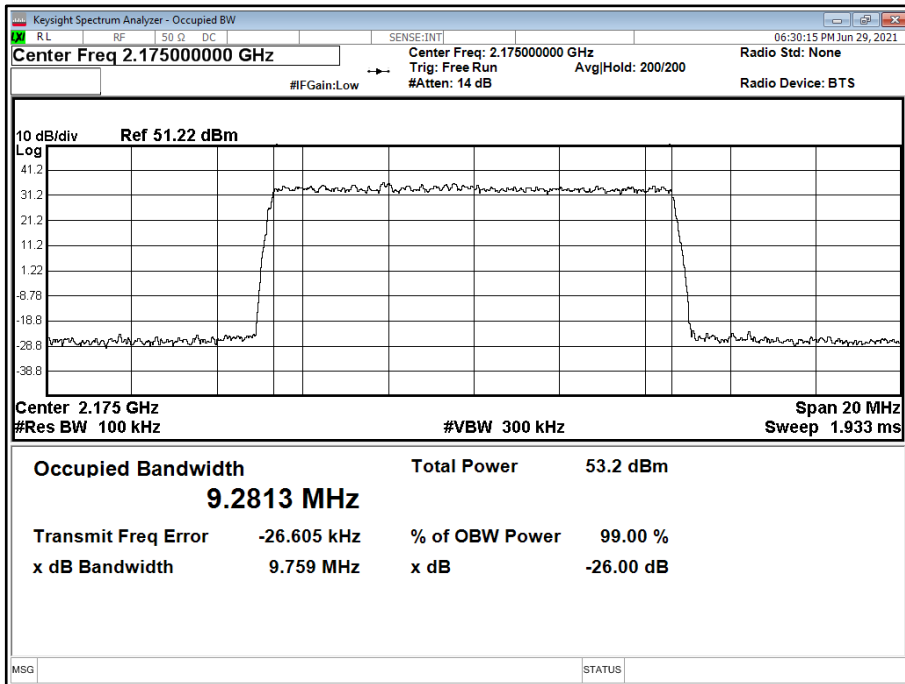



Antenna A - NR Modulation QPSK - NR Carrier Bandwidth 20.0 MHz 15 kHz SCS - Channel Position B

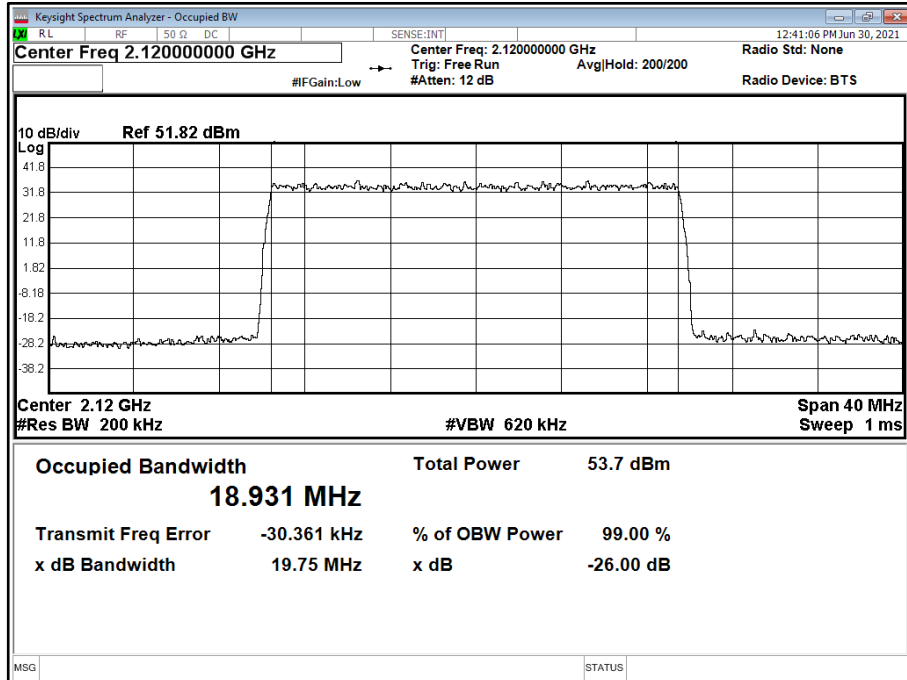

Antenna A - NR Modulation QPSK - NR Carrier Bandwidth 20.0 MHz 15 kHz SCS - Channel Position M

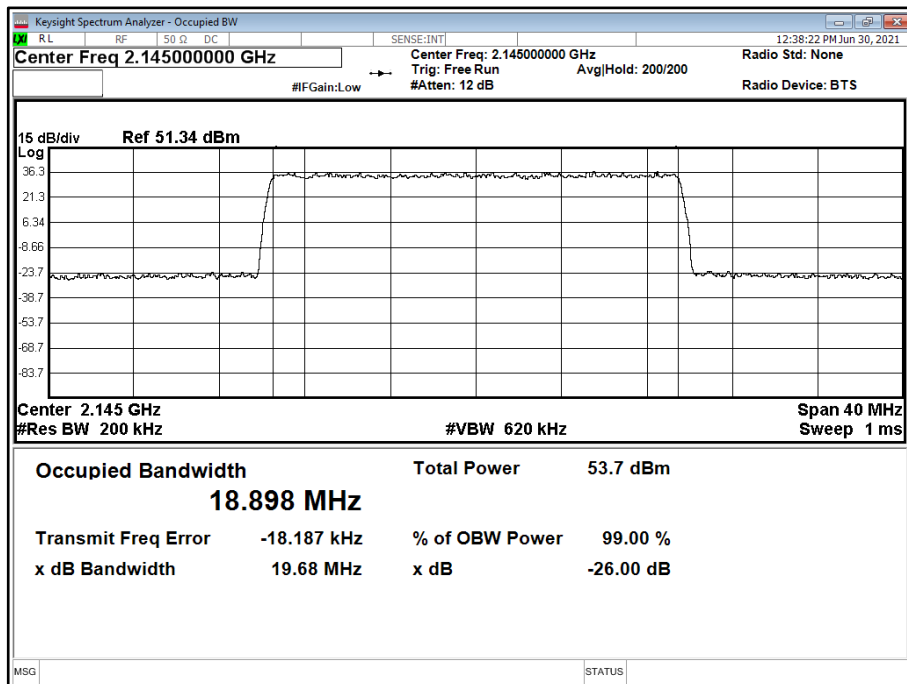



Antenna A - NR Modulation QPSK - NR Carrier Bandwidth 20.0 MHz 15 kHz SCS - Channel Position T

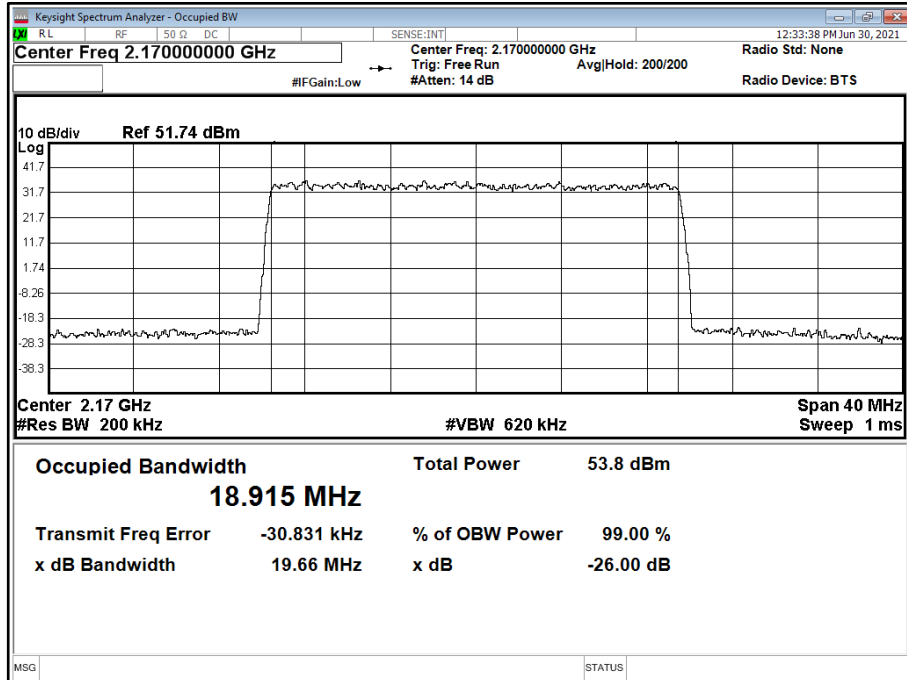

Configuration 4

Maximum Output Power 46.00 dBm

Antenna	NR Modulation	NR Carrier Bandwidth	Result (kHz)					
			Channel Position B		Channel Position M		Channel Position T	
			Occupied Bandwidth	-26 dB Bandwidth	Occupied Bandwidth	-26 dB Bandwidth	Occupied Bandwidth	-26 dB Bandwidth
A	QPSK	10.0 MHz 15 kHz SCS	29212.57	30035.04	-	-	29166.74	29991.63





Antenna A - NR Modulation QPSK - NR Carrier Bandwidth 10.0 MHz 15 kHz SCS - Channel Position B

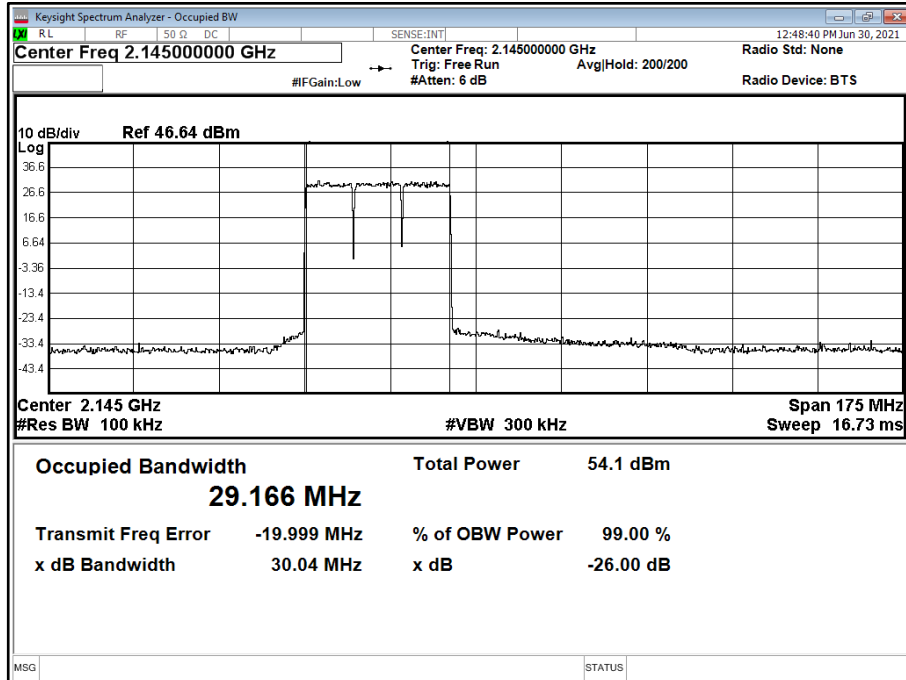

Antenna A - NR Modulation QPSK - NR Carrier Bandwidth 10.0 MHz 15 kHz SCS - Channel Position T

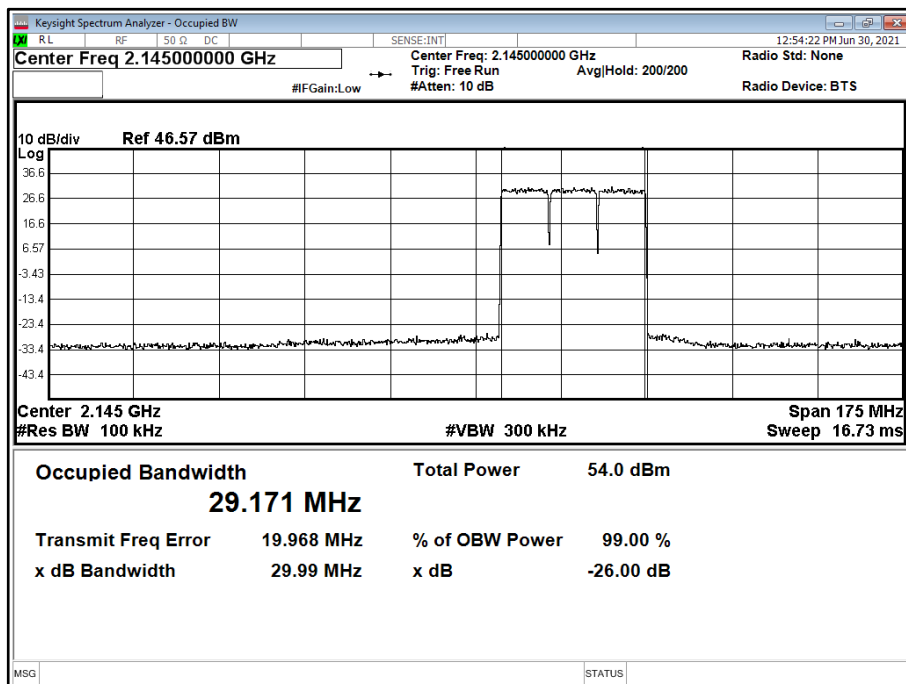



## 2.3 BAND EDGE

### 2.3.1 Specification Reference

FCC CFR 47 Part 27, Clause 27.53  
 Industry Canada RSS-139, Clause 6.5  
 FCC CFR 47 Part 2, Clause 2.1051

### 2.3.2 Date of Test and Modification State

29 and 30 June 2021 - Modification State 0

### 2.3.3 Test Equipment Used

The major items of test equipment used for the above tests are identified in Section 3.1.

### 2.3.4 Environmental Conditions

Ambient Temperature 23.4 - 25.2°C  
 Relative Humidity 37.2 - 40.8%

### 2.3.5 Test Method

All measurements were made in accordance with FCC KDB 971168 D01, Clause 6.0.

Band Edge measurements were used an Integration Bandwidth of at least 1% of the measured 26dB Bandwidth.

Each antenna port has been declared as being equivalent, therefore measurements were made on one antenna port only. To account for this, the limit was tightened by  $10 * \text{Log}(N)$ , where N is equal to the number of MIMO antenna ports.

For 4 ports, the limit was calculated as being  $-13 \text{ dBm} - 10 * \text{Log}(4) = -19 \text{ dBm}$ .

### 2.3.6 Test Results

Configuration 1

Maximum Output Power 46.00 dBm

Antenna	LTE / NR Modulation	LTE / NR Carrier Bandwidth	Band Edge (MHz)	
			Channel Position B	Channel Position T
A	QPSK	ESS 40/60 10.0 MHz 15 kHz SCS	2,115.0	2,175.0
A	QPSK	ESS 40/60 20.0 MHz 15 kHz SCS	2,120.0	2,170.0
A	QPSK	ESS 10/90 10.0 MHz 15 kHz SCS	2,115.0	2,175.0
A	QPSK	ESS 10/90 20.0 MHz 15 kHz SCS	2,120.0	2,170.0
A	QPSK	ESS 90/10 10.0 MHz 15 kHz SCS	2,115.0	2,175.0
A	QPSK	ESS 90/10 20.0 MHz 15 kHz SCS	2,120.0	2,170.0



Antenna A - LTE / NR Modulation QPSK - LTE / NR Carrier Bandwidth ESS 40/60 10.0 MHz 15 kHz SCS - Channel Position B

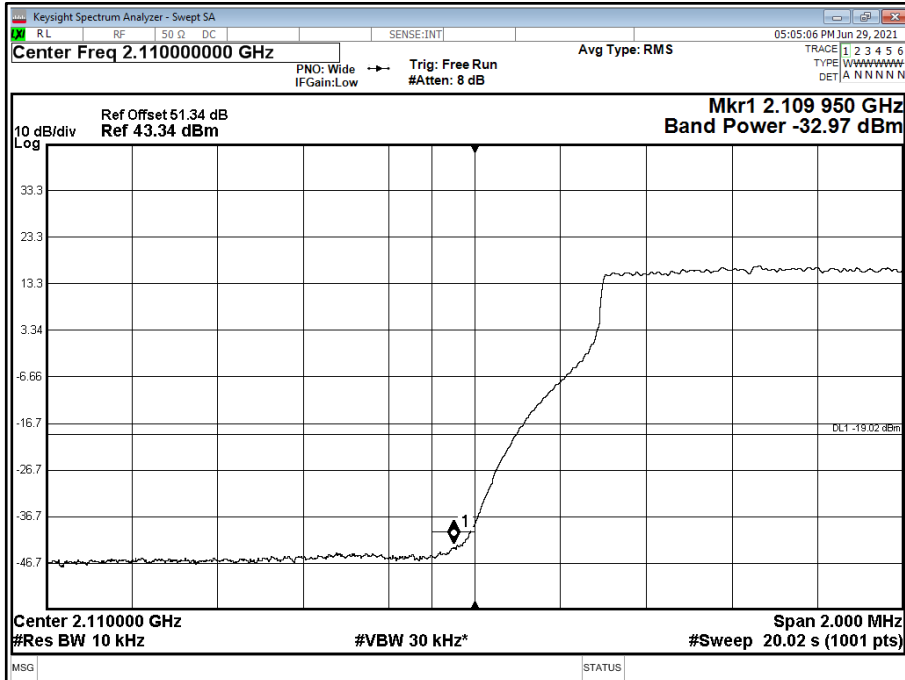

Antenna A - LTE / NR Modulation QPSK - LTE / NR Carrier Bandwidth ESS 40/60 10.0 MHz 15 kHz SCS - Channel Position T

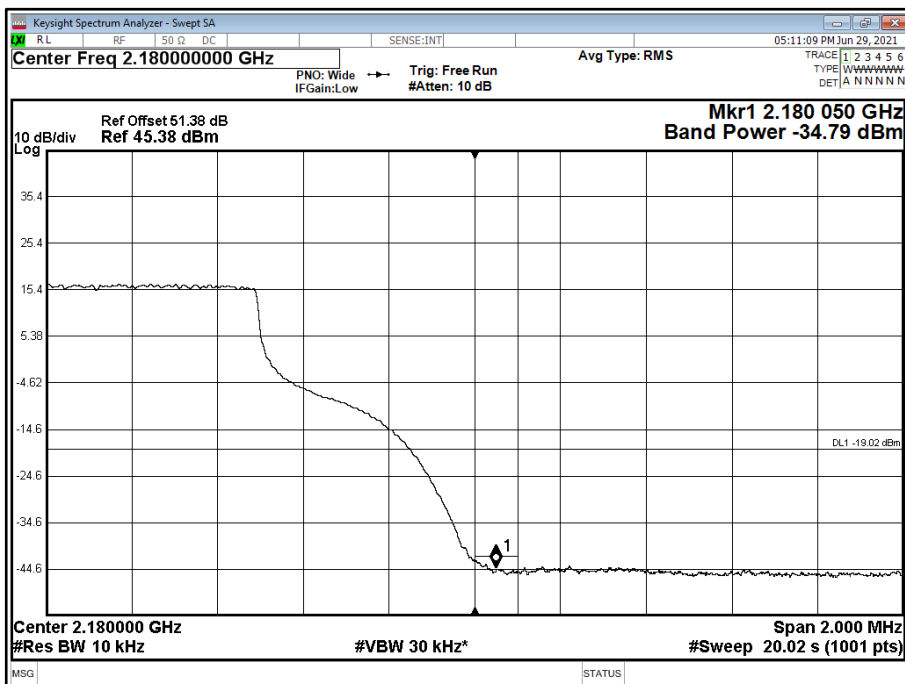



Antenna A - LTE / NR Modulation QPSK - LTE / NR Carrier Bandwidth ESS 40/60 20.0 MHz 15 kHz SCS - Channel Position B

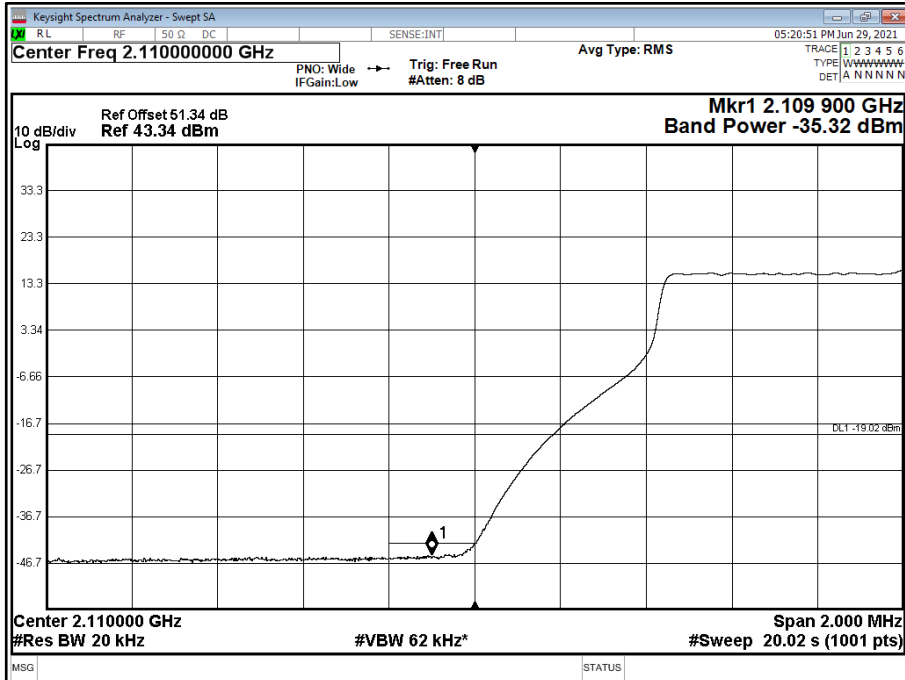

Antenna A - LTE / NR Modulation QPSK - LTE / NR Carrier Bandwidth ESS 40/60 20.0 MHz 15 kHz SCS - Channel Position T

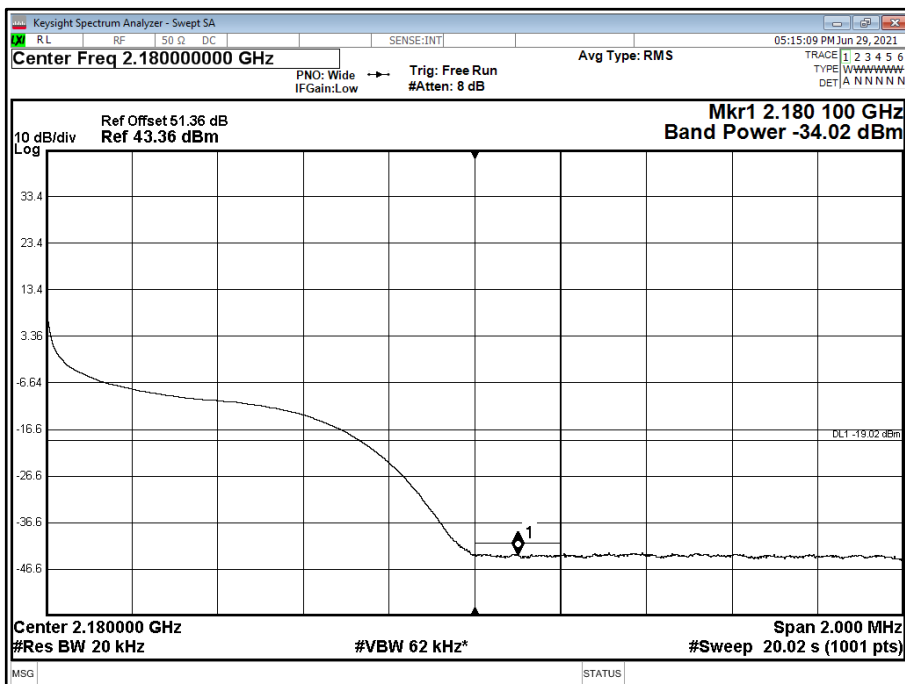



Antenna A - LTE / NR Modulation QPSK - LTE / NR Carrier Bandwidth ESS 10/90 10.0 MHz 15 kHz SCS - Channel Position B

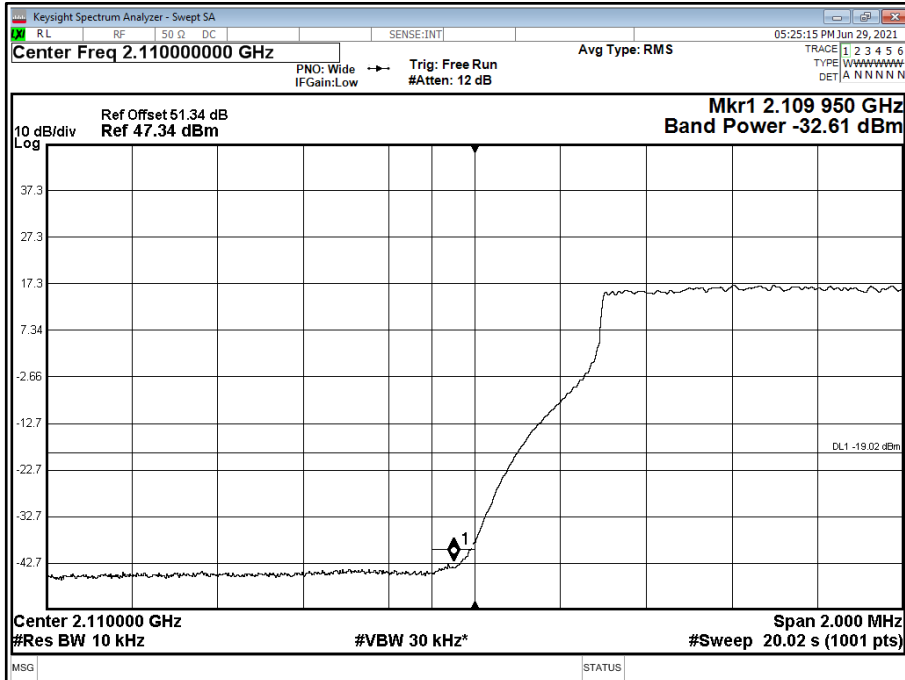

Antenna A - LTE / NR Modulation QPSK - LTE / NR Carrier Bandwidth ESS 10/90 10.0 MHz 15 kHz SCS - Channel Position T

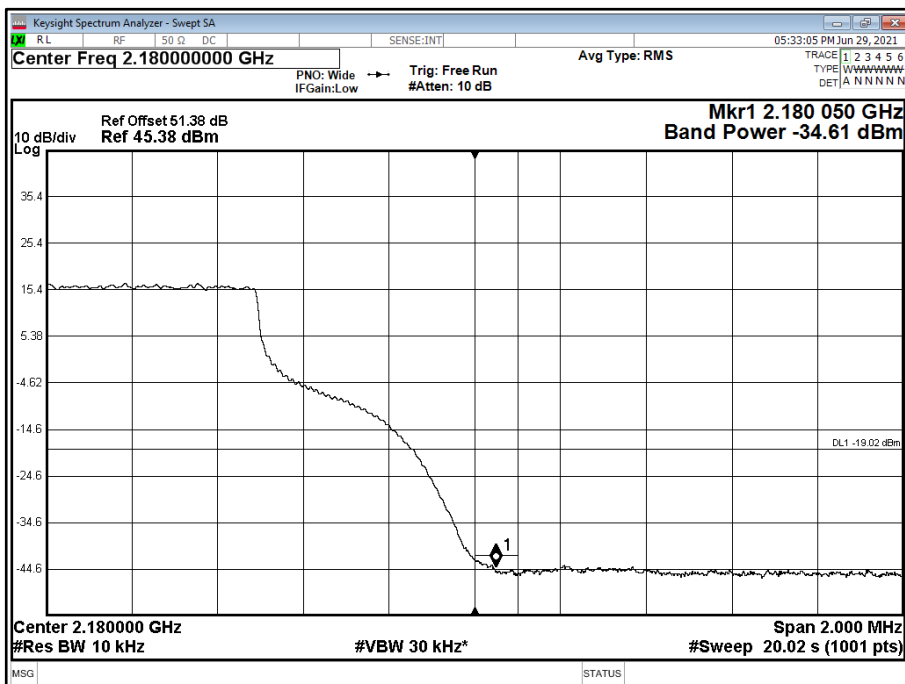



Antenna A - LTE / NR Modulation QPSK - LTE / NR Carrier Bandwidth ESS 10/90 20.0 MHz 15 kHz SCS - Channel Position B

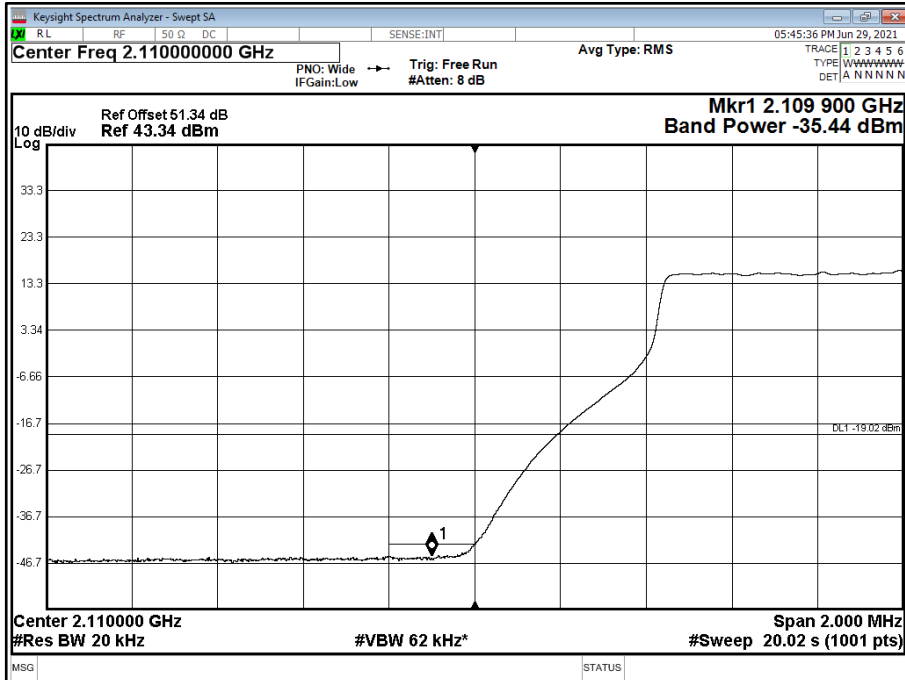

Antenna A - LTE / NR Modulation QPSK - LTE / NR Carrier Bandwidth ESS 10/90 20.0 MHz 15 kHz SCS - Channel Position T

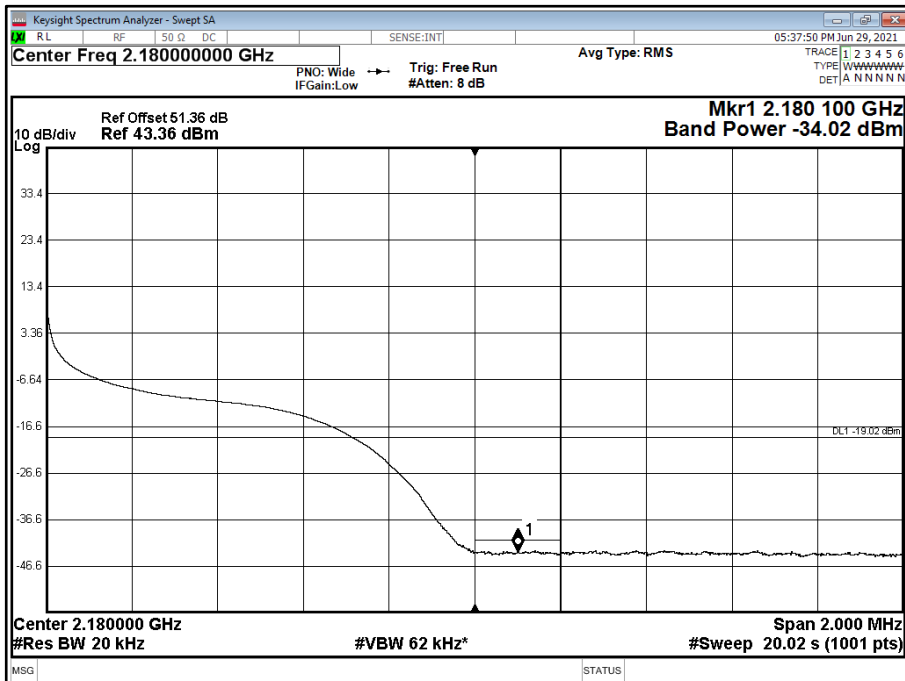



Antenna A - LTE / NR Modulation QPSK - LTE / NR Carrier Bandwidth ESS 90/10 10.0 MHz 15 kHz SCS - Channel Position B

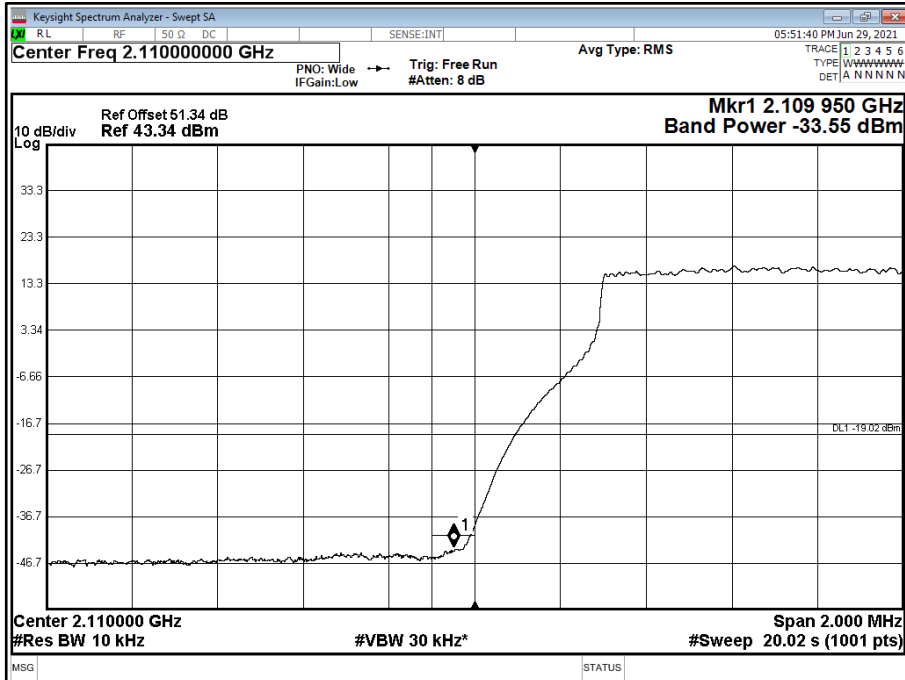

Antenna A - LTE / NR Modulation QPSK - LTE / NR Carrier Bandwidth ESS 90/10 10.0 MHz 15 kHz SCS - Channel Position T

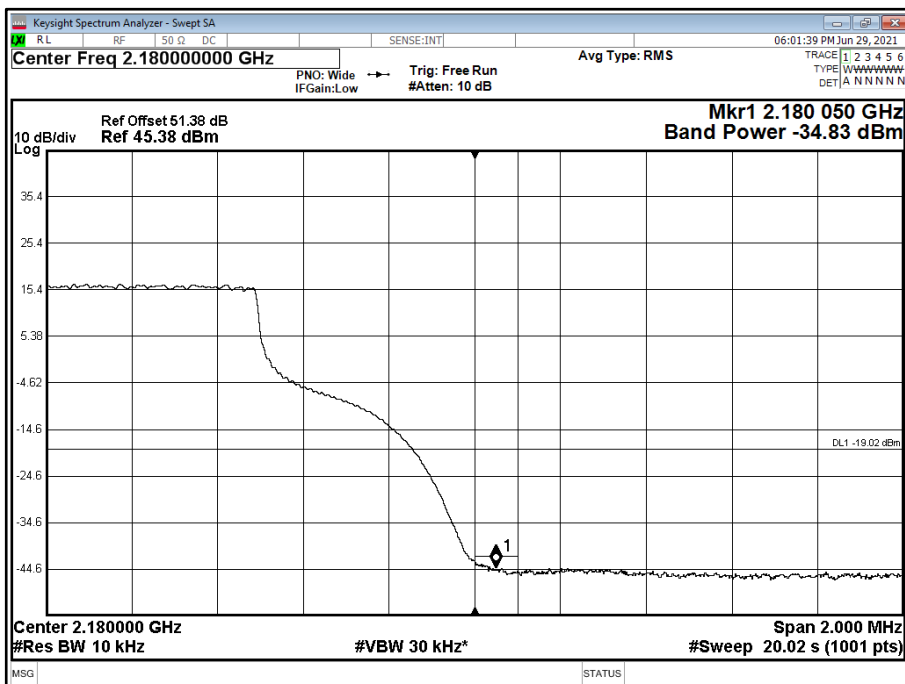



Antenna A - LTE / NR Modulation QPSK - LTE / NR Carrier Bandwidth ESS 90/10 20.0 MHz 15 kHz SCS - Channel Position B

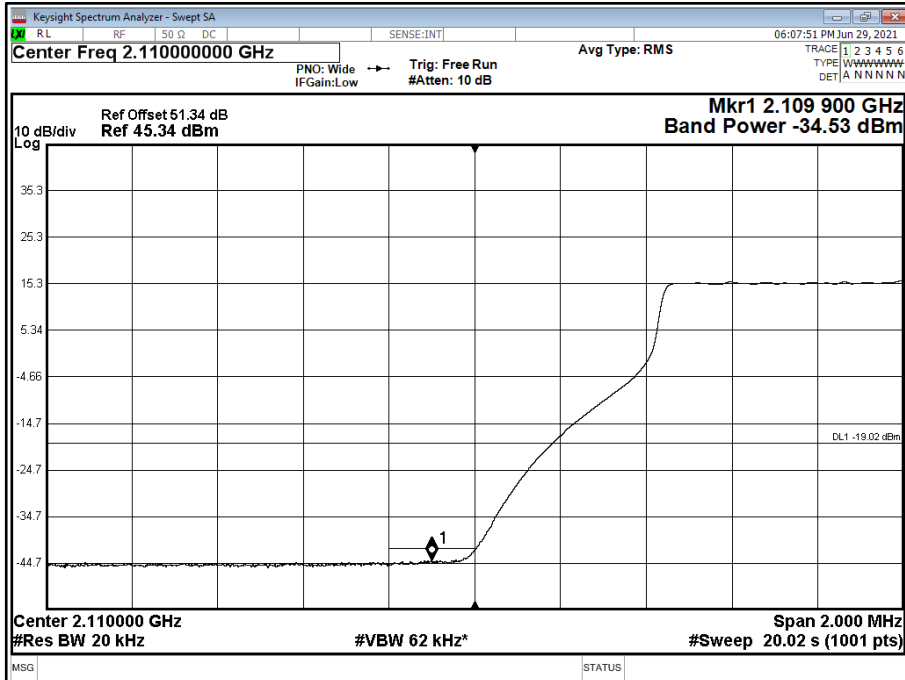

Antenna A - LTE / NR Modulation QPSK - LTE / NR Carrier Bandwidth ESS 90/10 20.0 MHz 15 kHz SCS - Channel Position T

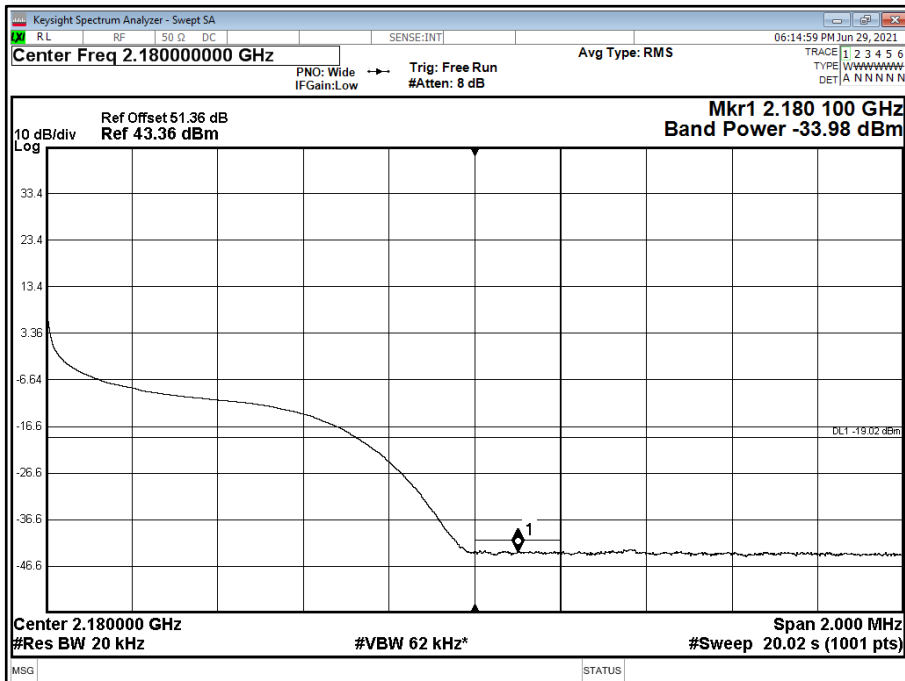





Configuration 2

Maximum Output Power 46.00 dBm

Antenna	LTE / NR Modulation	LTE / NR Carrier Bandwidth	Band Edge (MHz)	
			Channel Position B	Channel Position T
A	QPSK	ESS 40/60 10.0 MHz 15 kHz SCS	2115 + 2125 + 2175	2115 + 2125 + 2175
A	QPSK	ESS 10/90 10.0 MHz 15 kHz SCS	2115 + 2125 + 2175	2115 + 2125 + 2175
A	QPSK	ESS 90/10 10.0 MHz 15 kHz SCS	2115 + 2125 + 2175	2115 + 2125 + 2175

Antenna A - LTE / NR Modulation QPSK - LTE / NR Carrier Bandwidth ESS 40/60 10.0 MHz 15 kHz SCS - Channel Position B

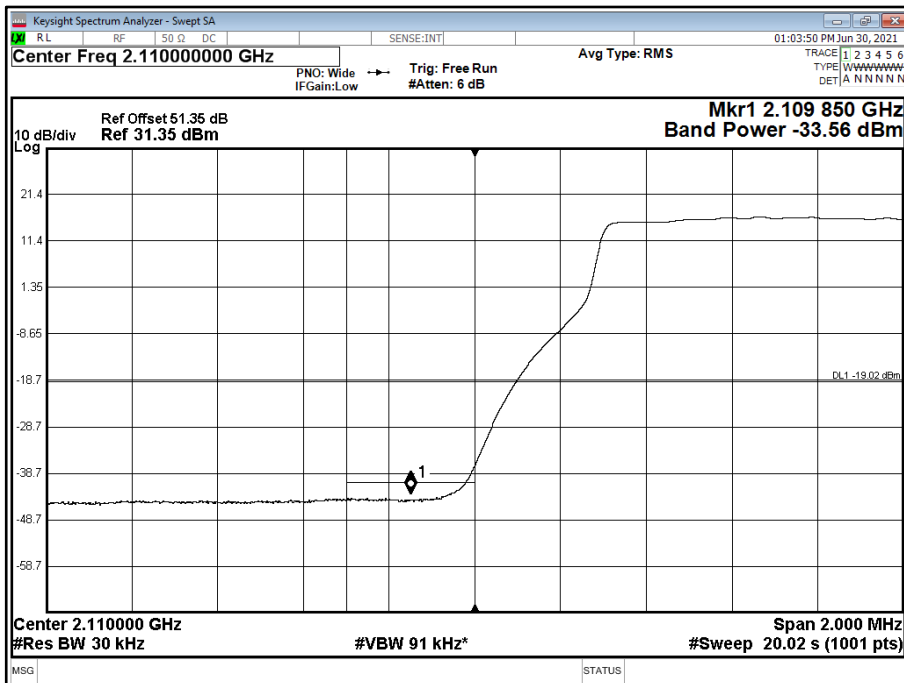



Antenna A - LTE / NR Modulation QPSK - LTE / NR Carrier Bandwidth ESS 40/60 10.0 MHz 15 kHz SCS - Channel Position T

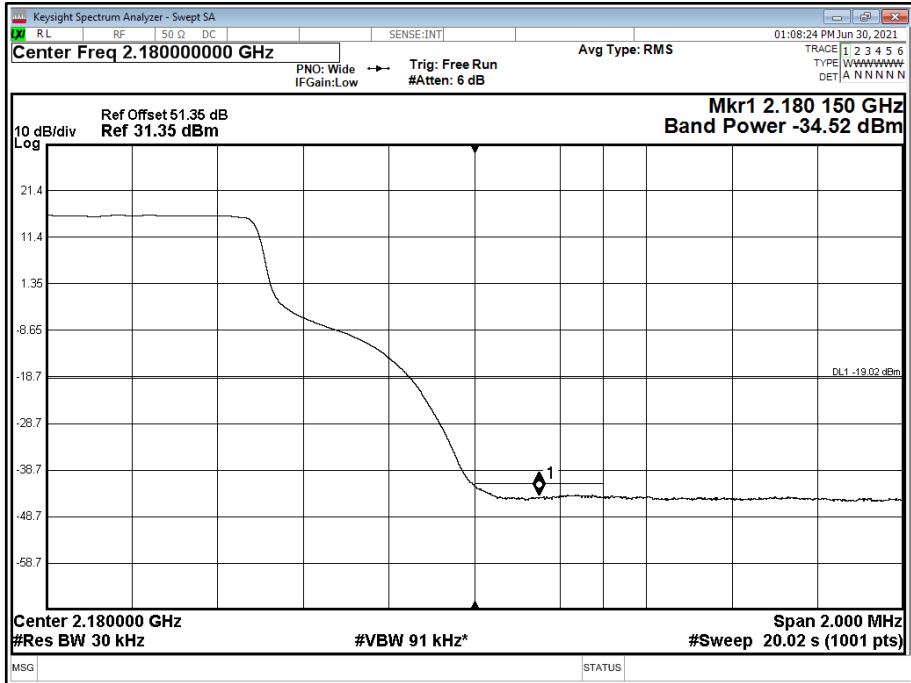

Antenna A - LTE / NR Modulation QPSK - LTE / NR Carrier Bandwidth ESS 10/90 10.0 MHz 15 kHz SCS - Channel Position B

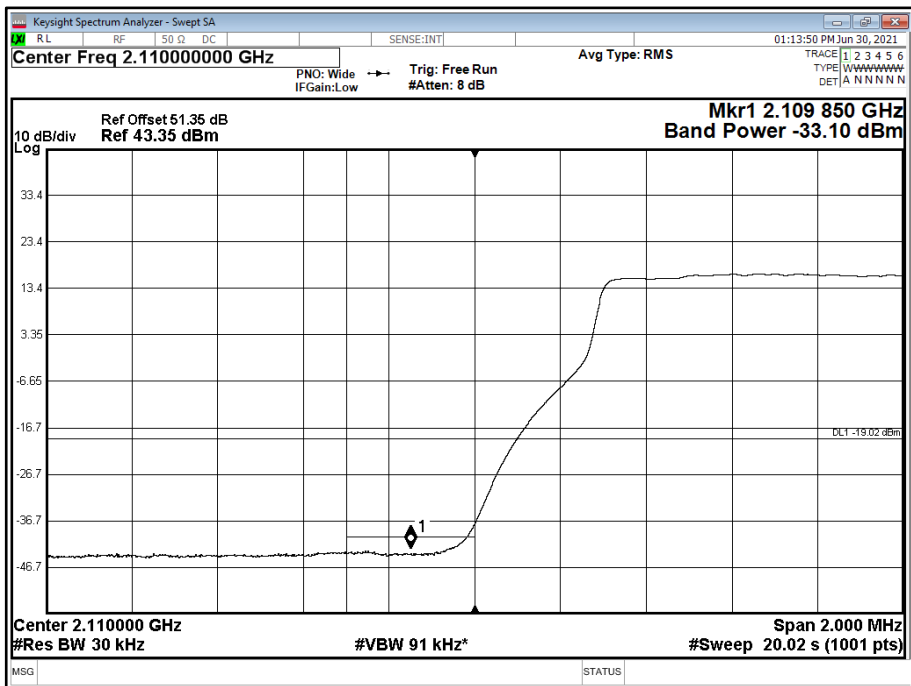



Antenna A - LTE / NR Modulation QPSK - LTE / NR Carrier Bandwidth ESS 10/90 10.0 MHz 15 kHz SCS - Channel Position T

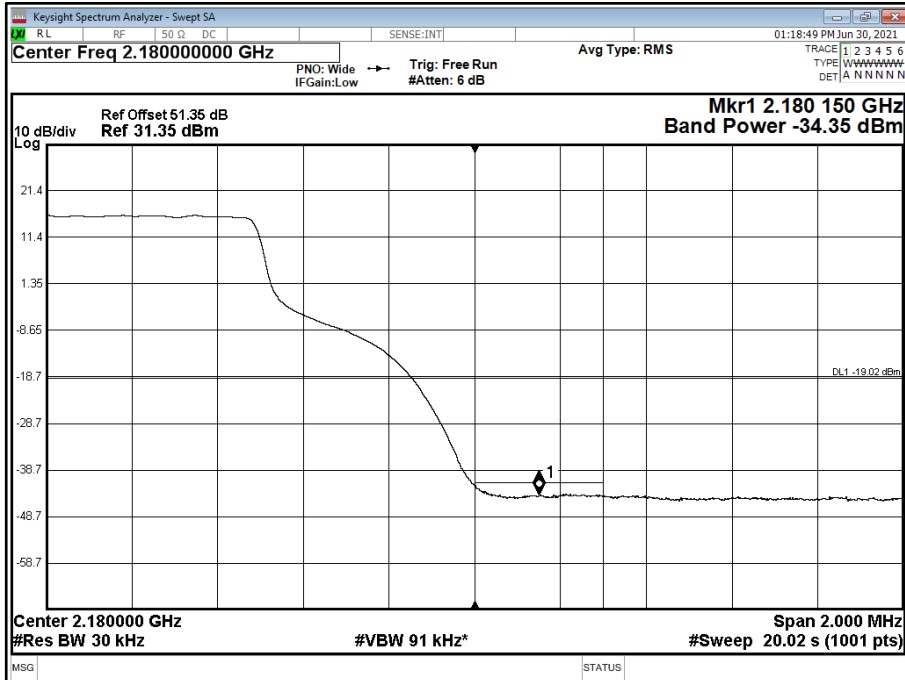

Antenna A - LTE / NR Modulation QPSK - LTE / NR Carrier Bandwidth ESS 90/10 10.0 MHz 15 kHz SCS - Channel Position B

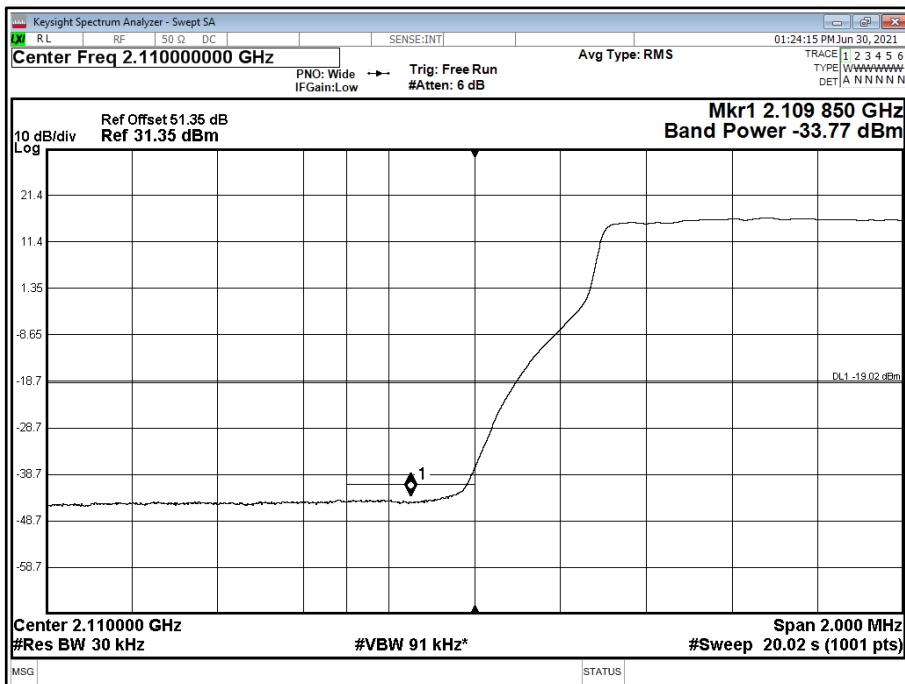



Antenna A - LTE / NR Modulation QPSK - LTE / NR Carrier Bandwidth ESS 90/10 10.0 MHz 15 kHz SCS - Channel Position T

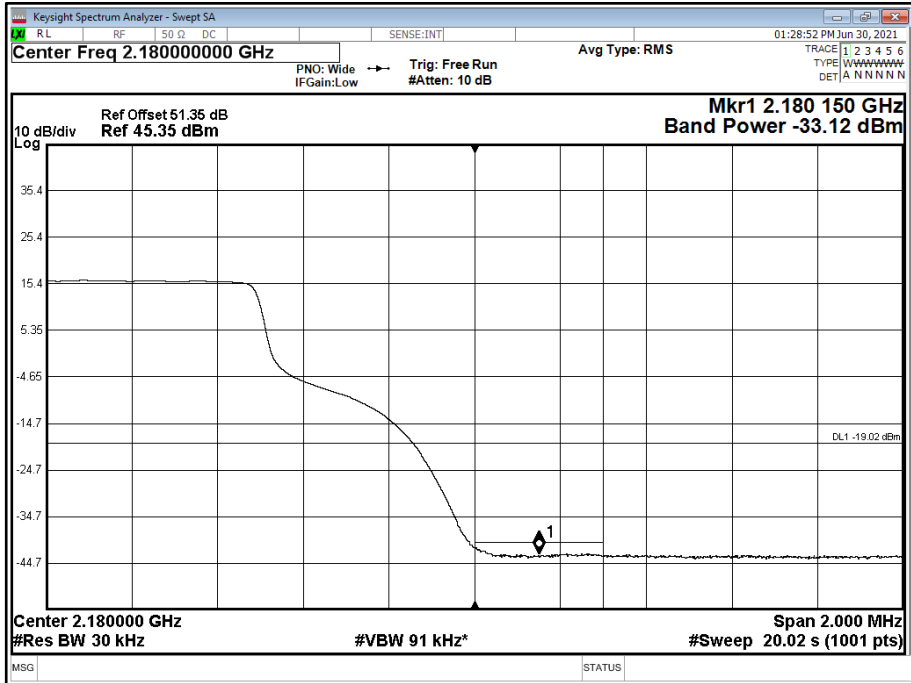

Configuration 3

Maximum Output Power 46.00 dBm

Antenna	NR Modulation	NR Carrier Bandwidth	Band Edge (MHz)	
			Channel Position B	Channel Position T
A	QPSK	10.0 MHz 15 kHz SCS	2,115.0	2,175.0
A	QPSK	20.0 MHz 15 kHz SCS	2,120.0	2,170.0



Antenna A - NR Modulation QPSK - NR Carrier Bandwidth 10.0 MHz 15 kHz SCS - Channel Position B

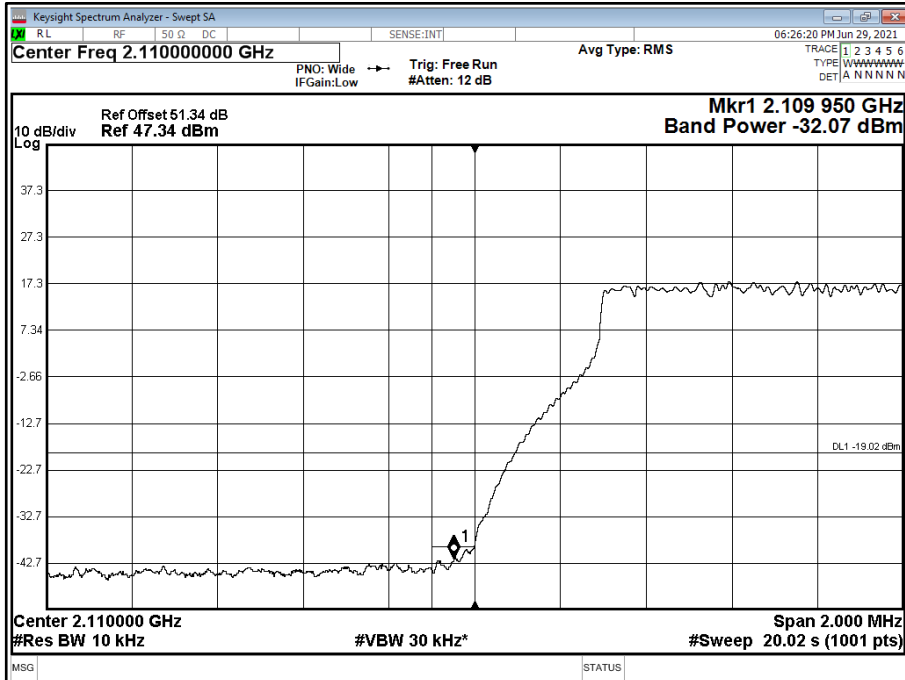

Antenna A - NR Modulation QPSK - NR Carrier Bandwidth 10.0 MHz 15 kHz SCS - Channel Position T

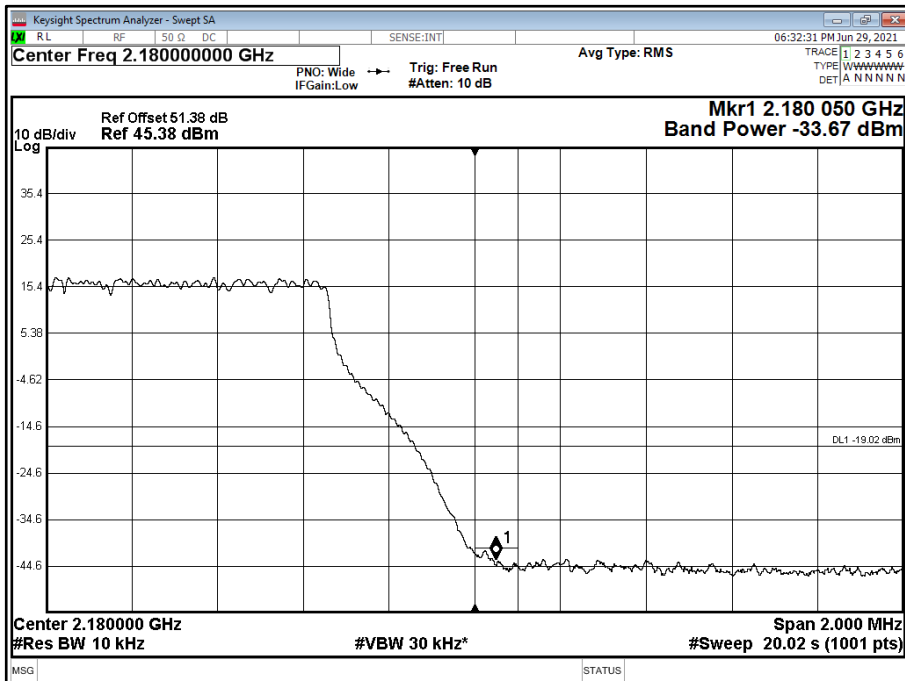



Antenna A - NR Modulation QPSK - NR Carrier Bandwidth 20.0 MHz 15 kHz SCS - Channel Position B

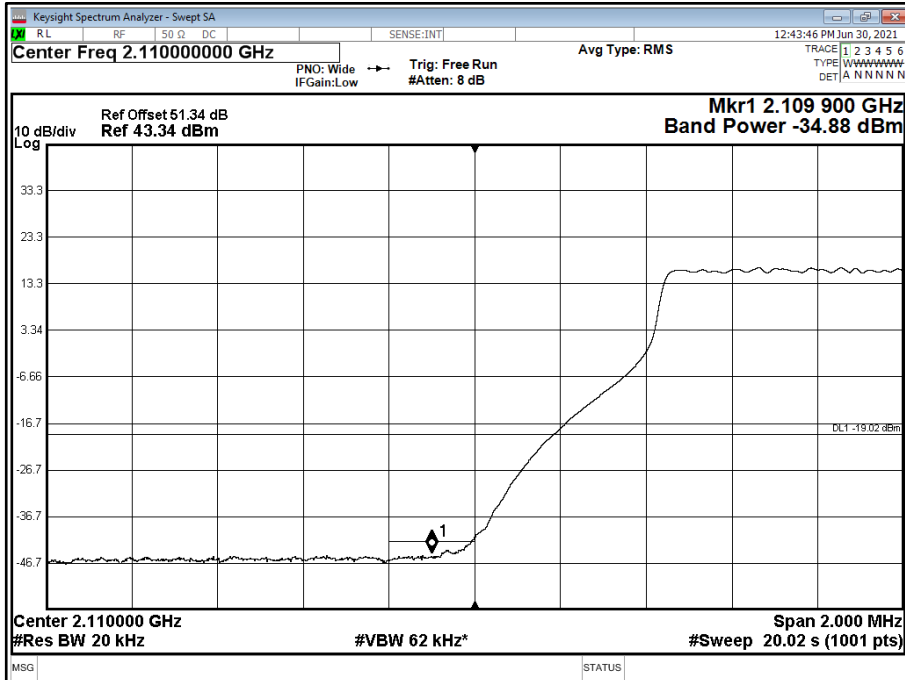

Antenna A - NR Modulation QPSK - NR Carrier Bandwidth 20.0 MHz 15 kHz SCS - Channel Position T

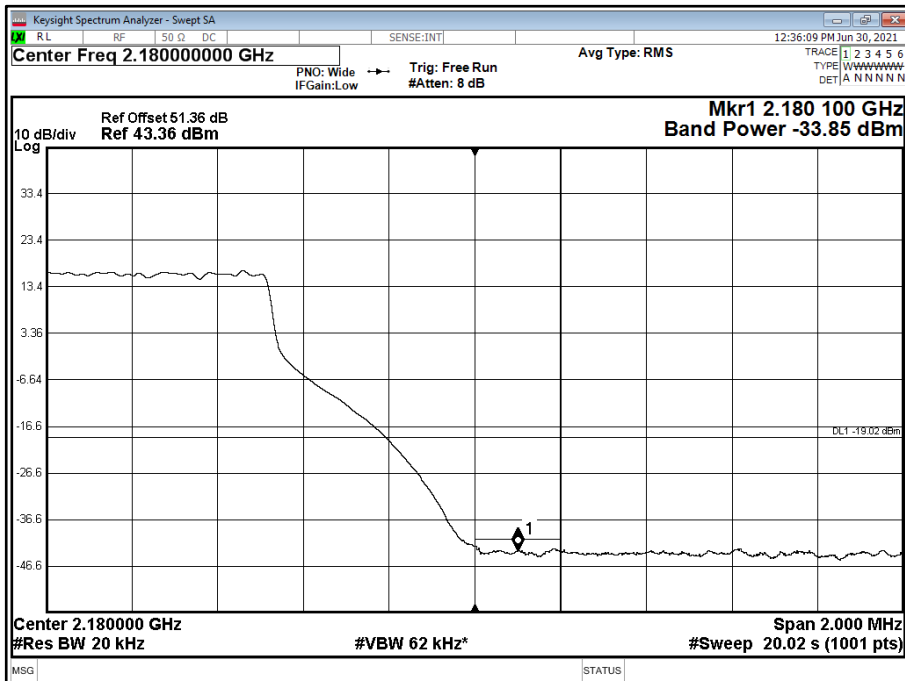



Configuration 4

Maximum Output Power 46.00 dBm

Antenna	NR Modulation	NR Carrier Bandwidth	Band Edge (MHz)	
			Channel Position B	Channel Position T
A	QPSK	10.0 MHz 15 kHz SCS	2115 + 2125 + 2175	2115 + 2125 + 2175

Antenna A - NR Modulation QPSK - NR Carrier Bandwidth 10.0 MHz 15 kHz SCS - Channel Position B

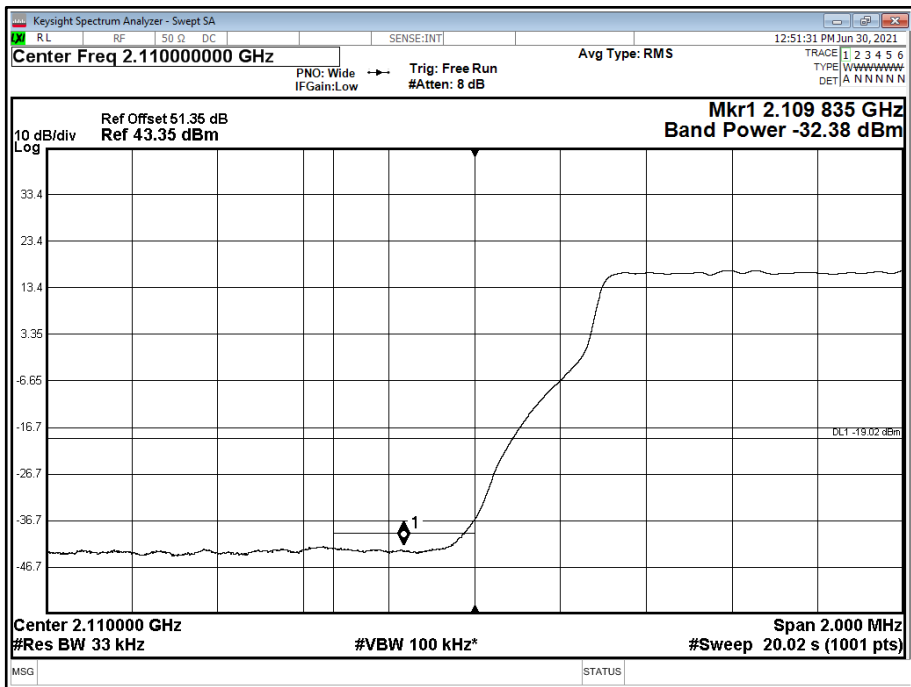



Antenna A - NR Modulation QPSK - NR Carrier Bandwidth 10.0 MHz 15 kHz SCS - Channel Position T

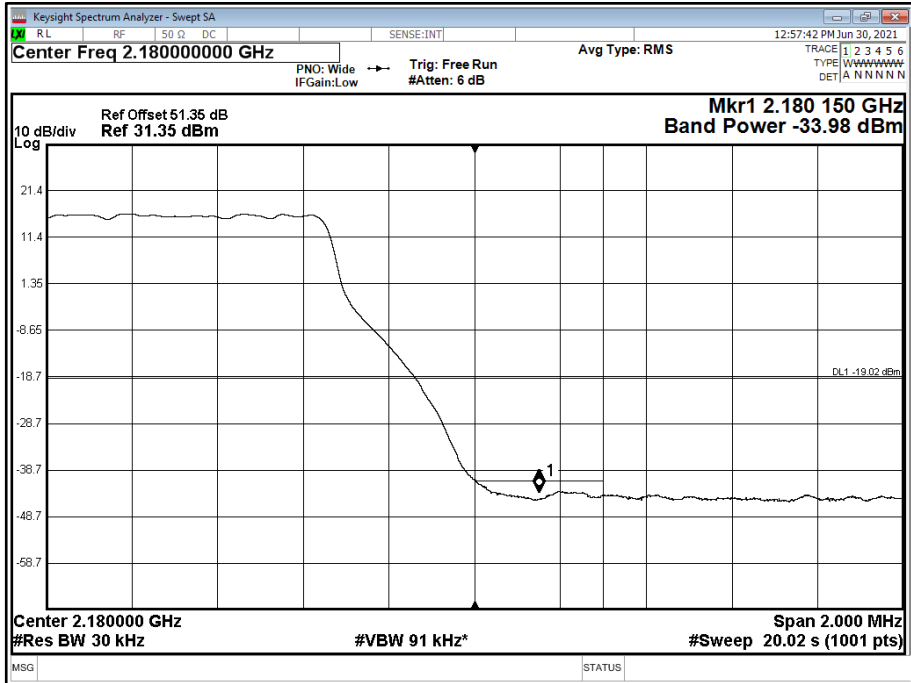

FCC Part 27.50 Clauses (d)

Base and Fixed Stations in the following Bands	Description	EIRP (watts/MHz)
995-2000 MHz, 2110-2155 MHz, 2155-2180 MHz or 2180-2200 MHz	Non-Urban	3280
	Urban	1640

Limit	-19 dBm
-------	---------





## **2.4 TRANSMITTER SPURIOUS EMISSIONS**

### **2.4.1 Specification Reference**

FCC CFR 47 Part 27, Clause 27.53  
Industry Canada RSS-139, Clause 6.6  
FCC CFR 47 Part 2, Clause 2.1051

### **2.4.2 Date of Test and Modification State**

30 June and 01 July 2021 - Modification State 0

### **2.4.3 Test Equipment Used**

The major items of test equipment used for the above tests are identified in Section 3.1.

### **2.4.4 Environmental Conditions**

Ambient Temperature	25.2°C
Relative Humidity	40.8%

### **2.4.5 Test Method**

All measurements were made in accordance with FCC KDB 971168 D01, Clause 6.1.

Each antenna port has been declared as being equivalent, therefore measurements were made on one antenna port only. To account for this, the limit was tightened by  $10 * \text{Log}(N)$ , where N is equal to the number of MIMO antenna ports.

For 4 ports, the limit was calculated as being  $-13 \text{ dBm} - 10 * \text{Log}(4) = -19 \text{ dBm}$ .

### **2.4.6 Test Results**

Configuration 1

Maximum Output Power 46.00 dBm



Antenna A - LTE / NR Modulation QPSK - LTE / NR Carrier Bandwidth ESS 40/60 10.0 MHz 15 kHz SCS - Channel Position B - Band 1 - Range 0.009 to 3500 MHz

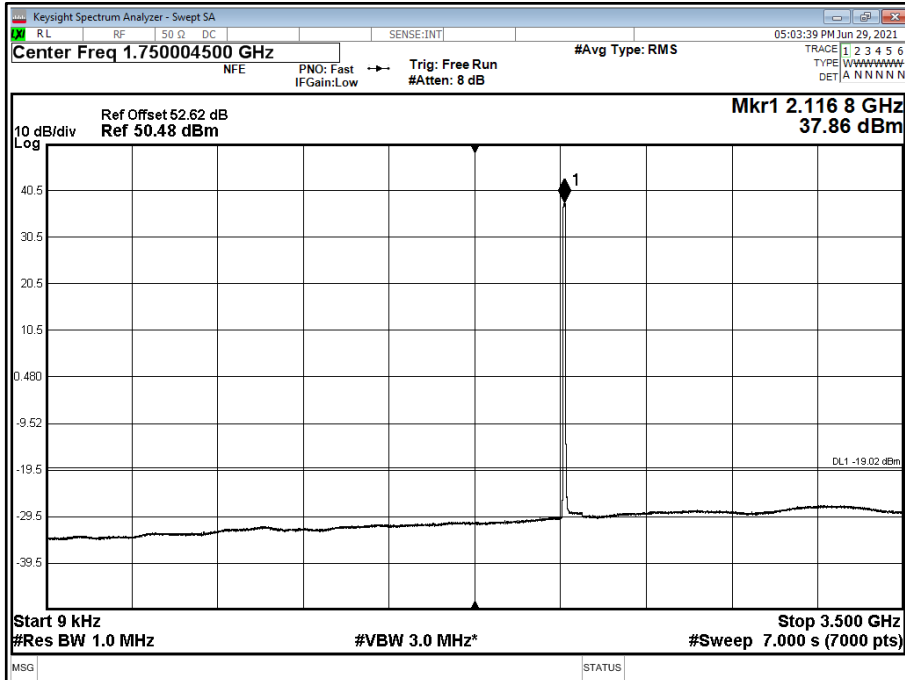

Antenna A - LTE / NR Modulation QPSK - LTE / NR Carrier Bandwidth ESS 40/60 10.0 MHz 15 kHz SCS - Channel Position M - Band 1 - Range 0.009 to 3500 MHz

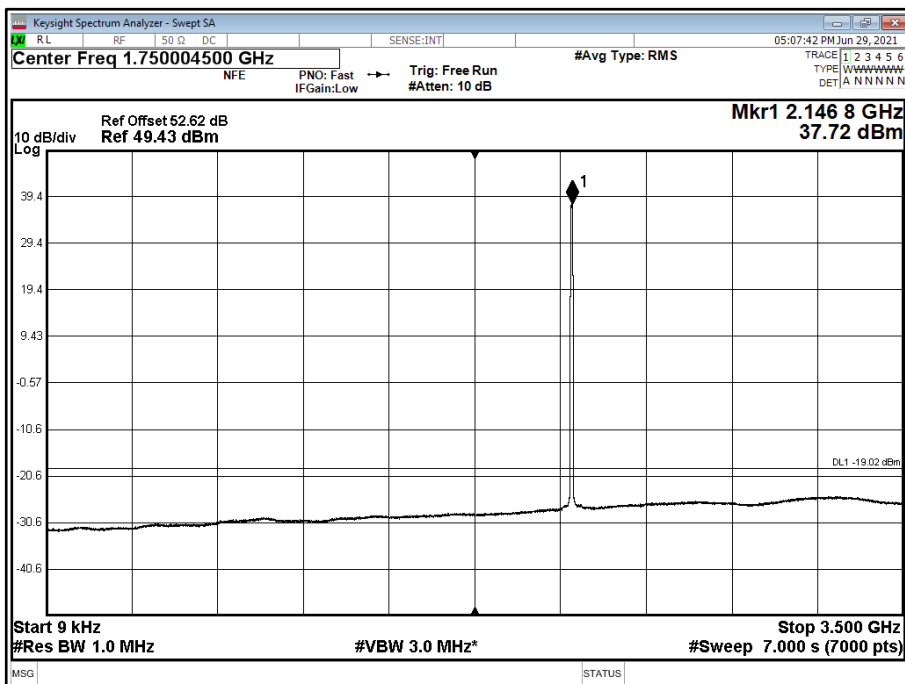



Antenna A - LTE / NR Modulation QPSK - LTE / NR Carrier Bandwidth ESS 40/60 10.0 MHz 15 kHz SCS - Channel Position T - Band 1 - Range 0.009 to 3500 MHz

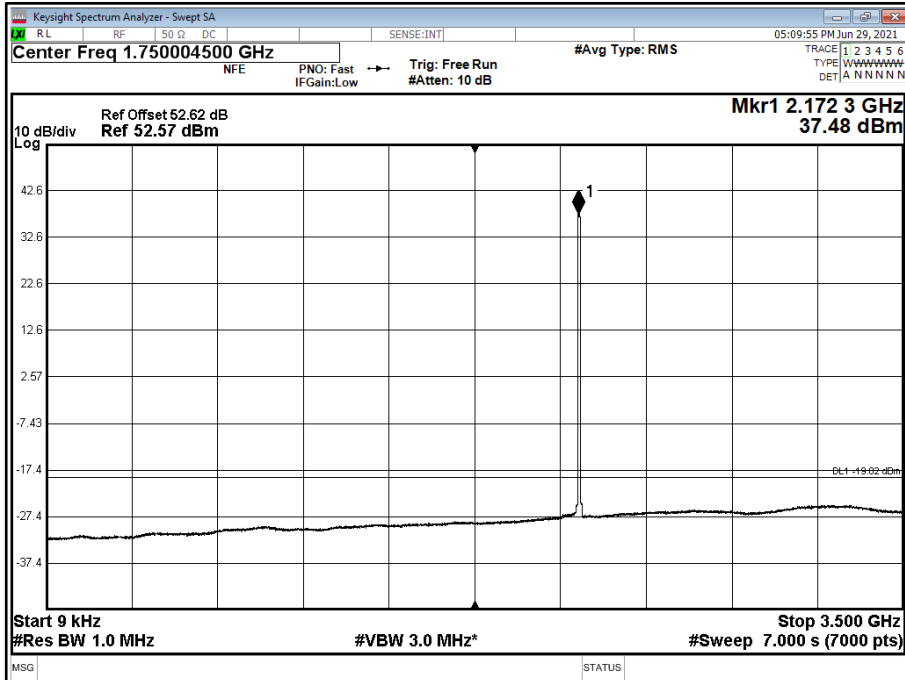

Antenna A - LTE / NR Modulation QPSK - LTE / NR Carrier Bandwidth ESS 40/60 20.0 MHz 15 kHz SCS - Channel Position B - Band 1 - Range 0.009 to 3500 MHz

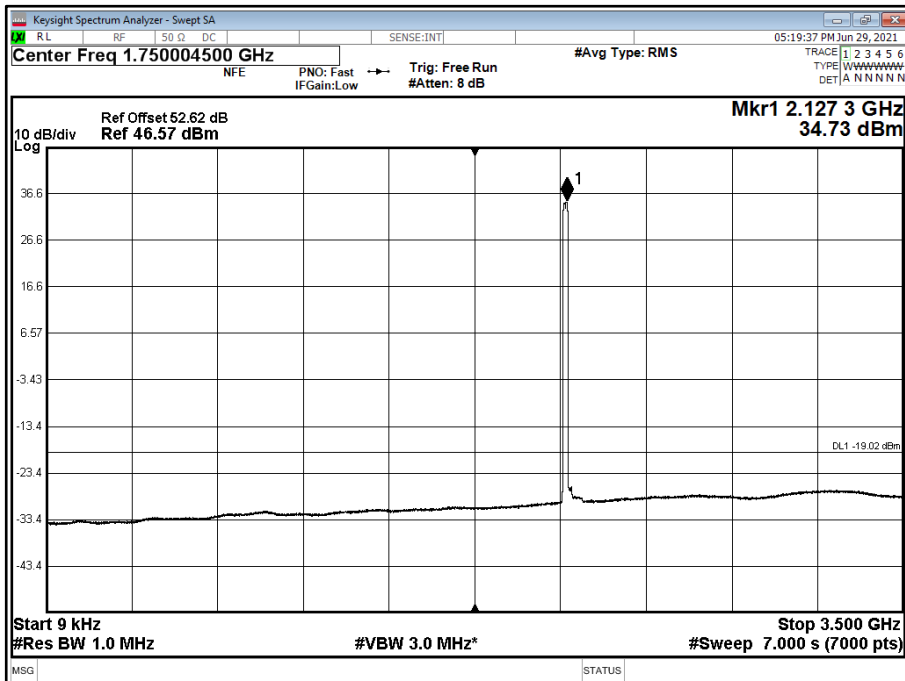



Antenna A - LTE / NR Modulation QPSK - LTE / NR Carrier Bandwidth ESS 40/60 20.0 MHz 15 kHz SCS - Channel Position M - Band 1 - Range 0.009 to 3500 MHz

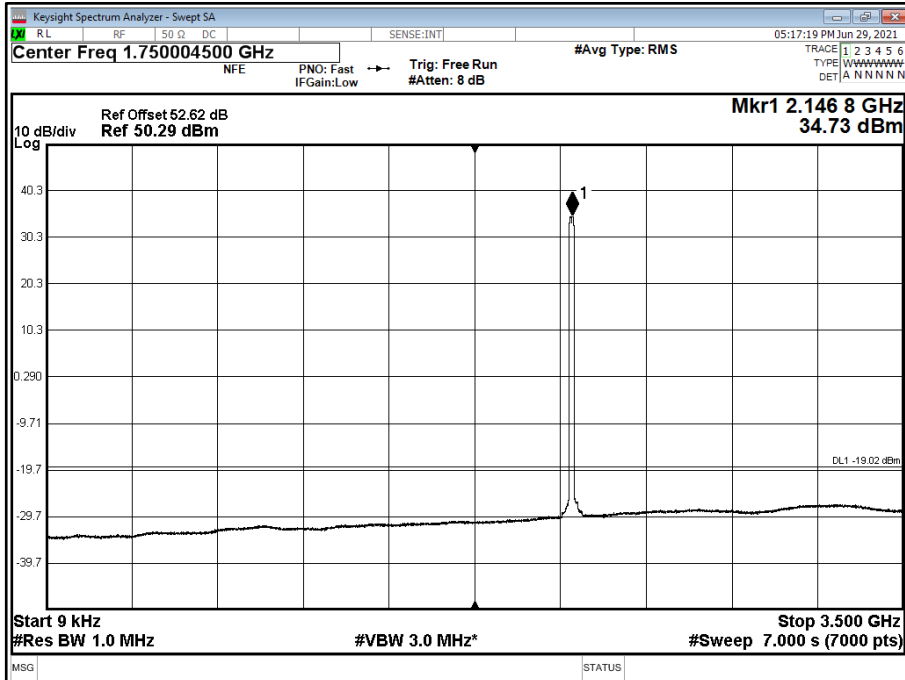

Antenna A - LTE / NR Modulation QPSK - LTE / NR Carrier Bandwidth ESS 40/60 20.0 MHz 15 kHz SCS - Channel Position T - Band 1 - Range 0.009 to 3500 MHz

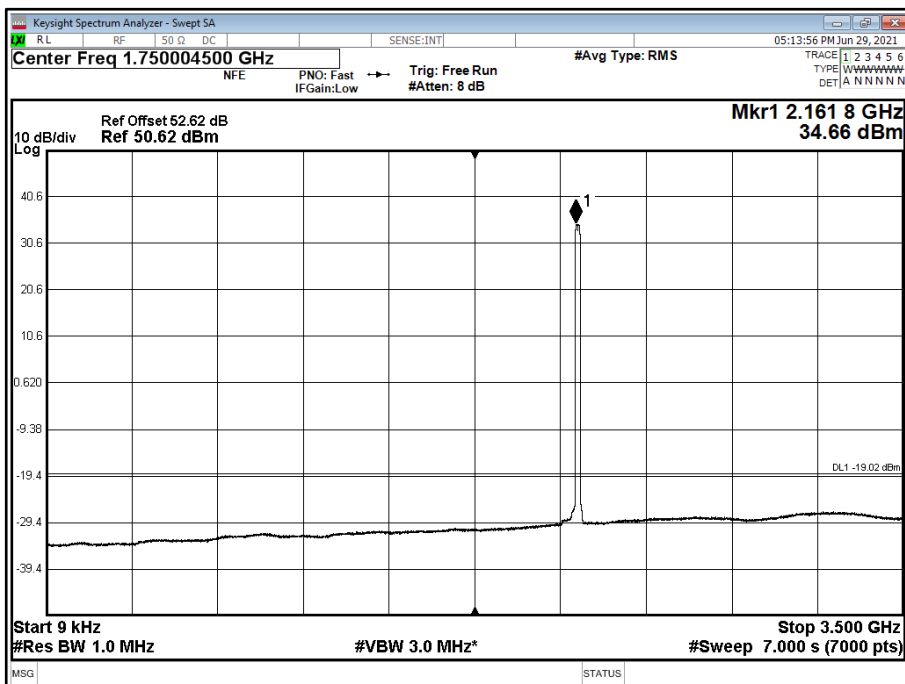



Antenna A - LTE / NR Modulation QPSK - LTE / NR Carrier Bandwidth ESS 10/90 10.0 MHz 15 kHz SCS - Channel Position B - Band 1 - Range 0.009 to 3500 MHz

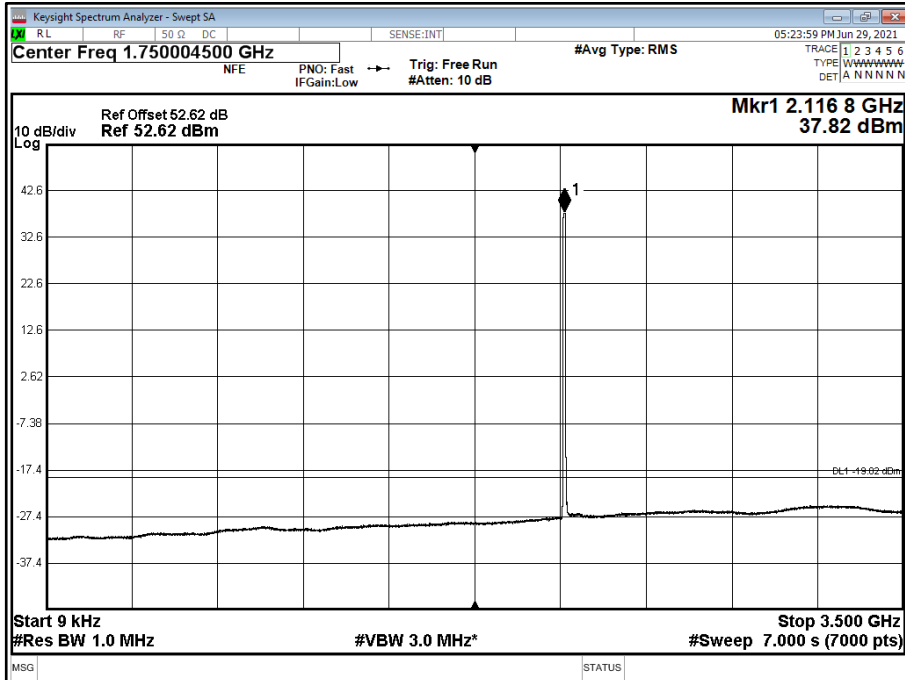

Antenna A - LTE / NR Modulation QPSK - LTE / NR Carrier Bandwidth ESS 10/90 10.0 MHz 15 kHz SCS - Channel Position M - Band 1 - Range 0.009 to 3500 MHz

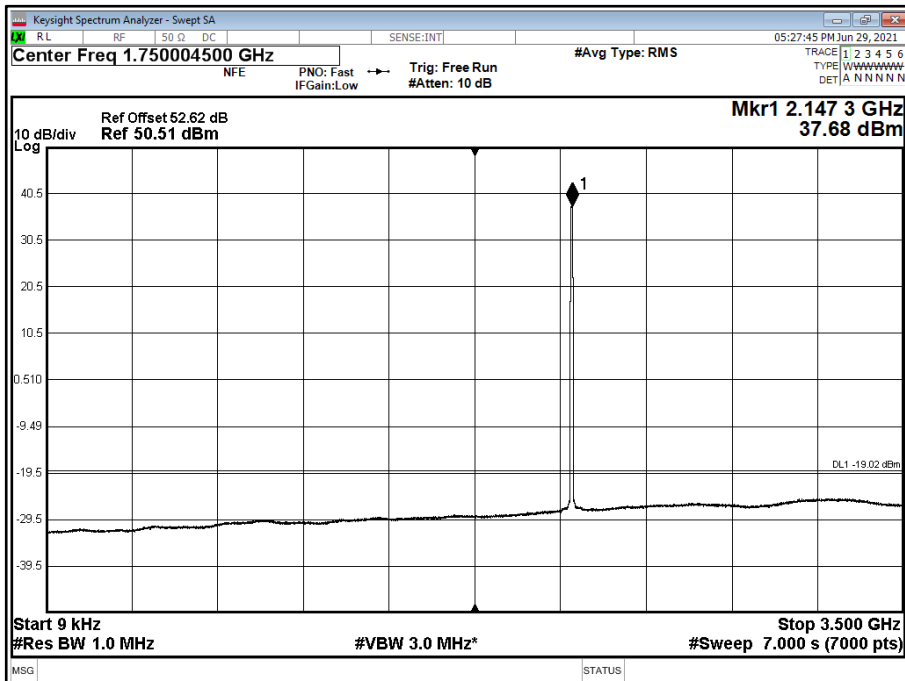



Antenna A - LTE / NR Modulation QPSK - LTE / NR Carrier Bandwidth ESS 10/90 10.0 MHz 15 kHz SCS - Channel Position T - Band 1 - Range 0.009 to 3500 MHz

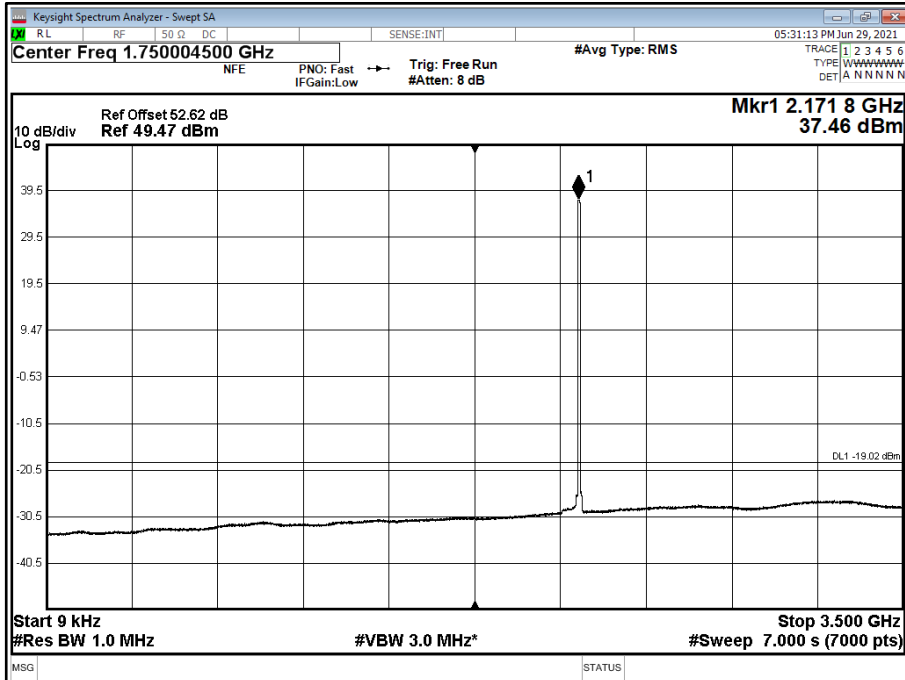

Antenna A - LTE / NR Modulation QPSK - LTE / NR Carrier Bandwidth ESS 10/90 20.0 MHz 15 kHz SCS - Channel Position B - Band 1 - Range 0.009 to 3500 MHz

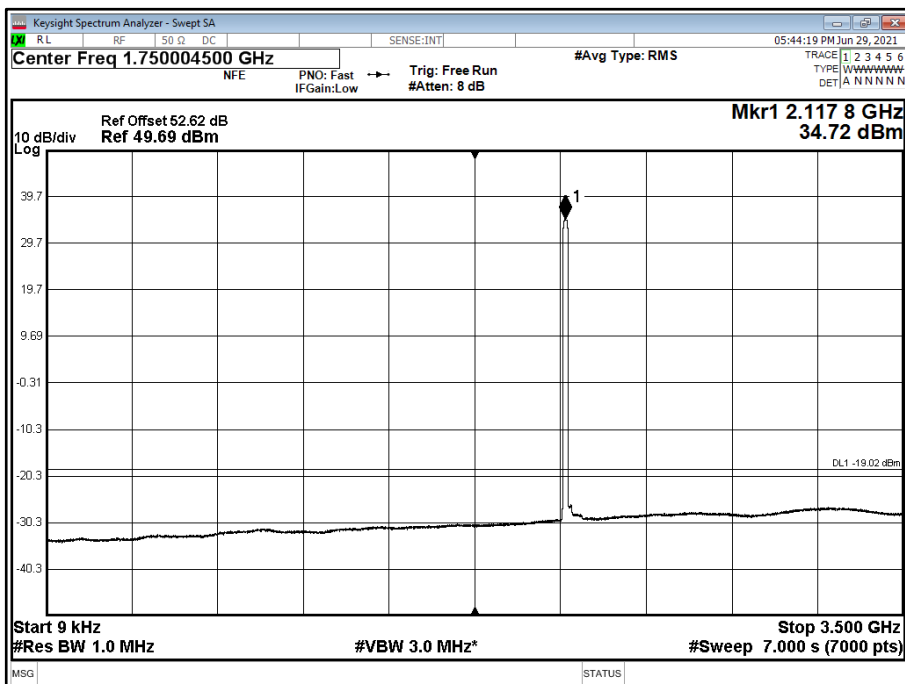



Antenna A - LTE / NR Modulation QPSK - LTE / NR Carrier Bandwidth ESS 10/90 20.0 MHz 15 kHz SCS - Channel Position M - Band 1 - Range 0.009 to 3500 MHz

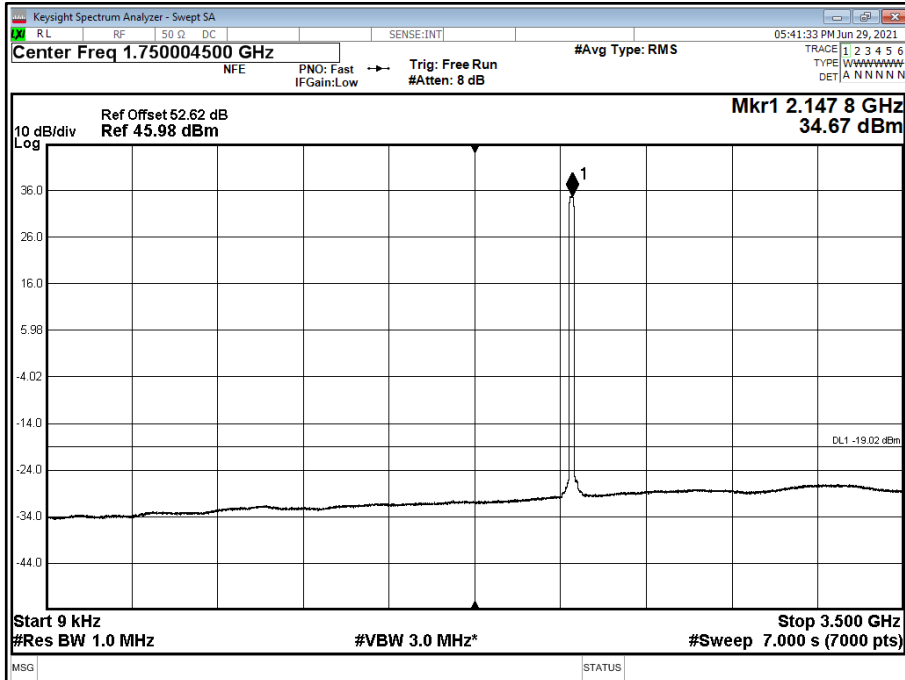

Antenna A - LTE / NR Modulation QPSK - LTE / NR Carrier Bandwidth ESS 10/90 20.0 MHz 15 kHz SCS - Channel Position T - Band 1 - Range 0.009 to 3500 MHz

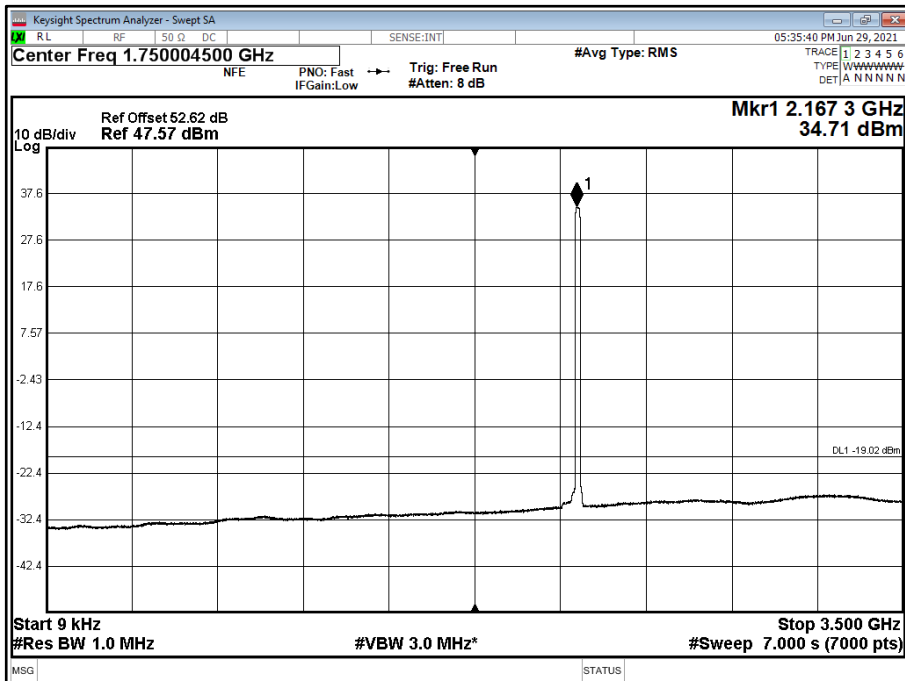



Antenna A - LTE / NR Modulation QPSK - LTE / NR Carrier Bandwidth ESS 90/10 10.0 MHz 15 kHz SCS - Channel Position B - Band 1 - Range 0.009 to 3500 MHz

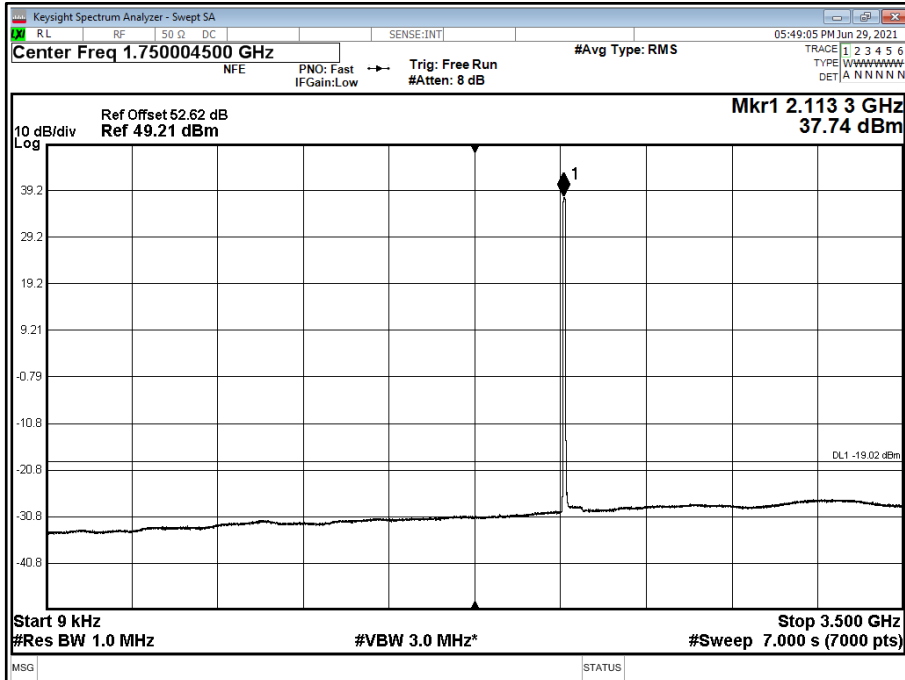

Antenna A - LTE / NR Modulation QPSK - LTE / NR Carrier Bandwidth ESS 90/10 10.0 MHz 15 kHz SCS - Channel Position M - Band 1 - Range 0.009 to 3500 MHz

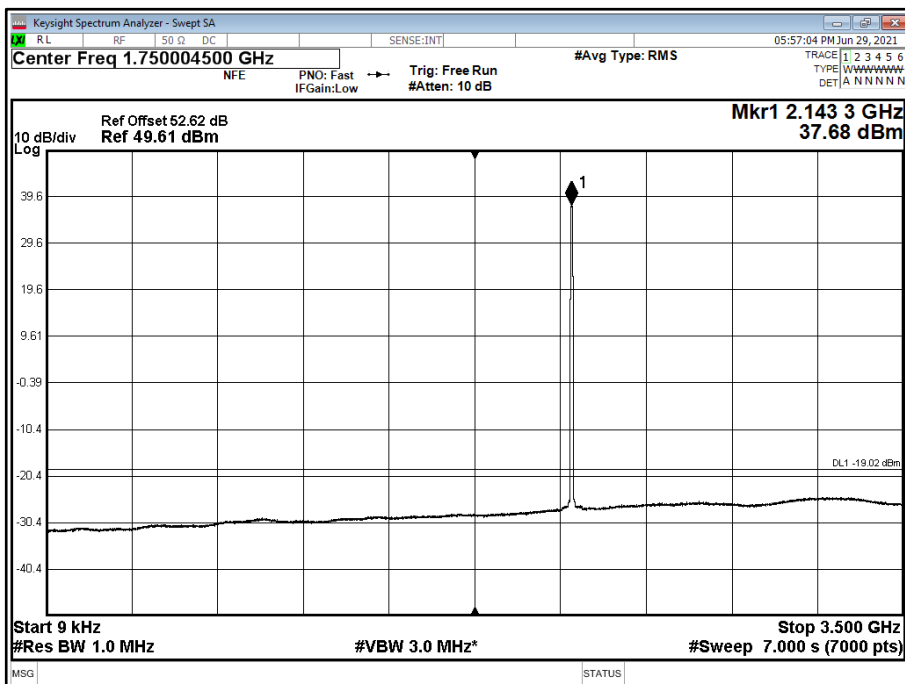





Antenna A - LTE / NR Modulation QPSK - LTE / NR Carrier Bandwidth ESS 90/10 10.0 MHz 15 kHz SCS - Channel Position T - Band 1 - Range 0.009 to 3500 MHz

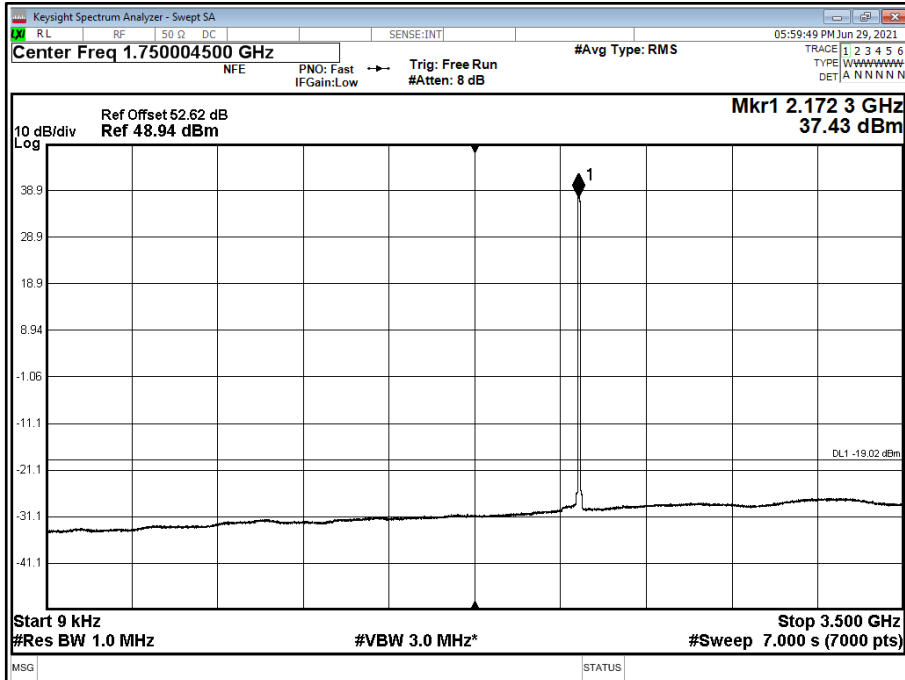

Antenna A - LTE / NR Modulation QPSK - LTE / NR Carrier Bandwidth ESS 90/10 20.0 MHz 15 kHz SCS - Channel Position B - Band 1 - Range 0.009 to 3500 MHz

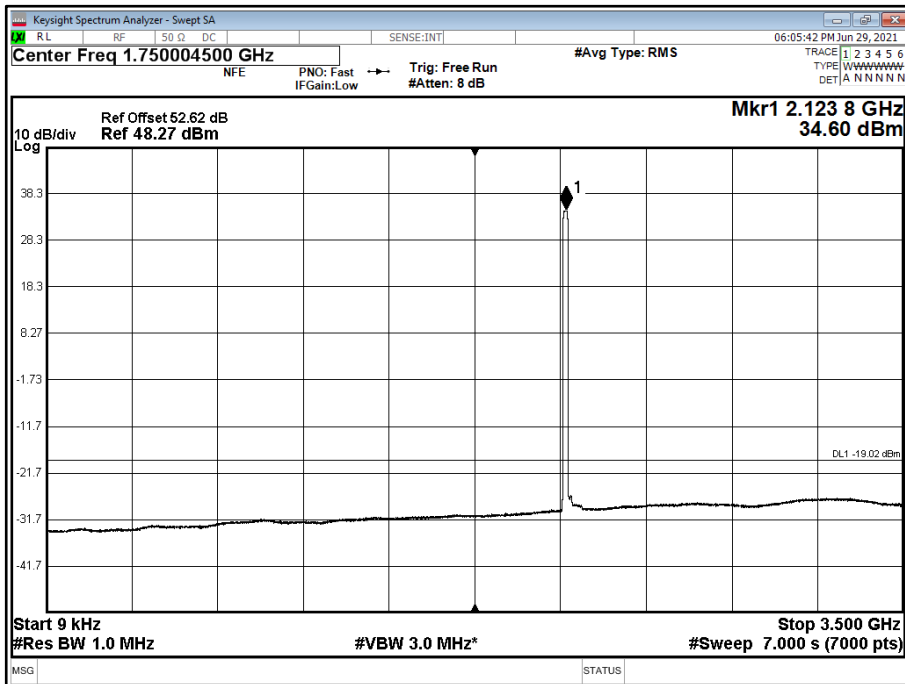



Antenna A - LTE / NR Modulation QPSK - LTE / NR Carrier Bandwidth ESS 90/10 20.0 MHz 15 kHz SCS - Channel Position M - Band 1 - Range 0.009 to 3500 MHz

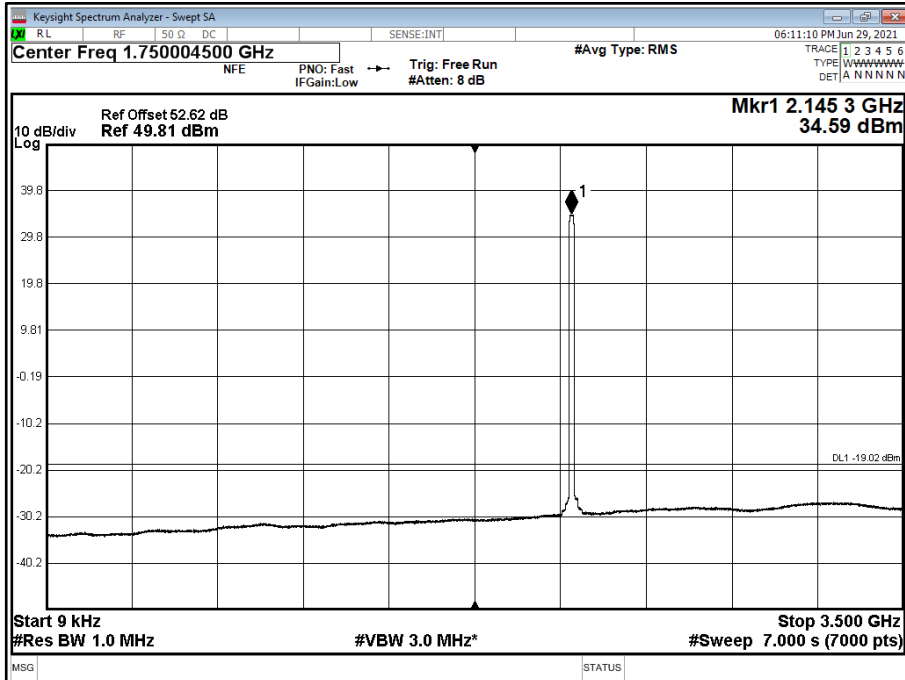

Antenna A - LTE / NR Modulation QPSK - LTE / NR Carrier Bandwidth ESS 90/10 20.0 MHz 15 kHz SCS - Channel Position T - Band 1 - Range 0.009 to 3500 MHz

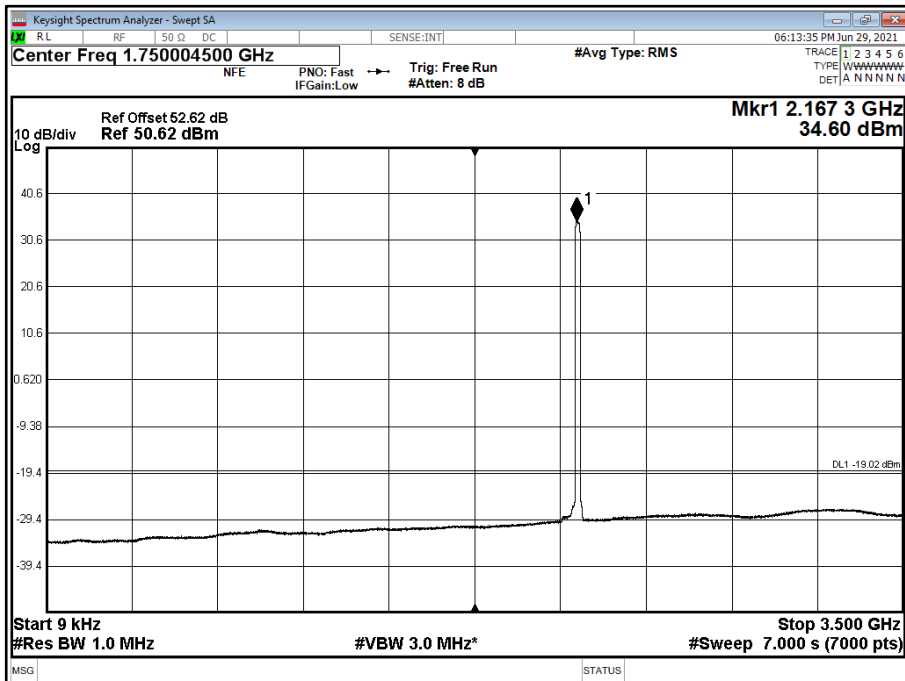



Antenna A - LTE / NR Modulation QPSK - LTE / NR Carrier Bandwidth ESS 40/60 10.0 MHz 15 kHz SCS - Channel Position B - Band 2 - Range 3500 to 8000 MHz

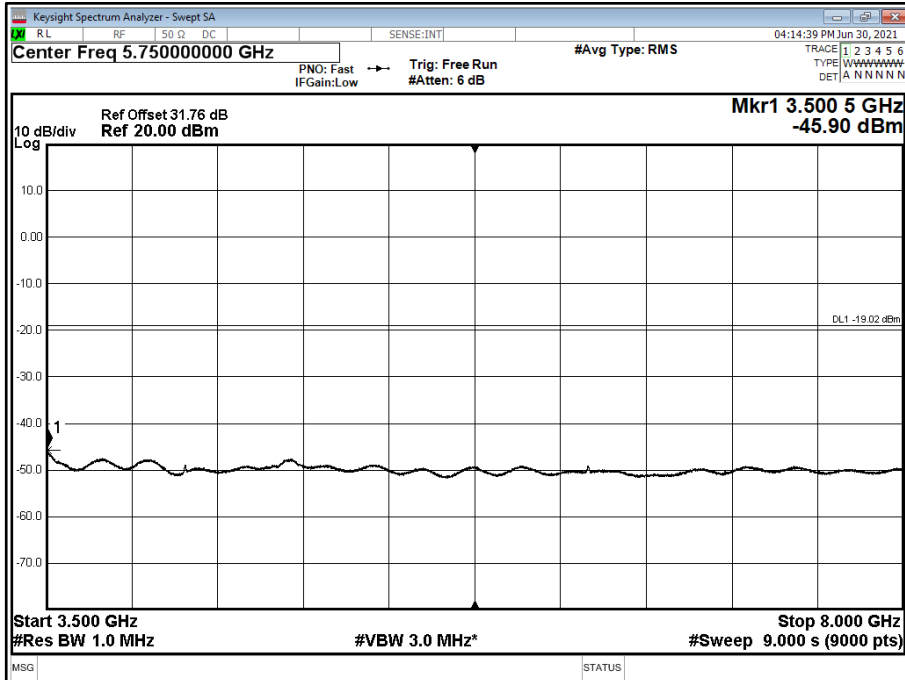

Antenna A - LTE / NR Modulation QPSK - LTE / NR Carrier Bandwidth ESS 40/60 10.0 MHz 15 kHz SCS - Channel Position M - Band 2 - Range 3500 to 8000 MHz

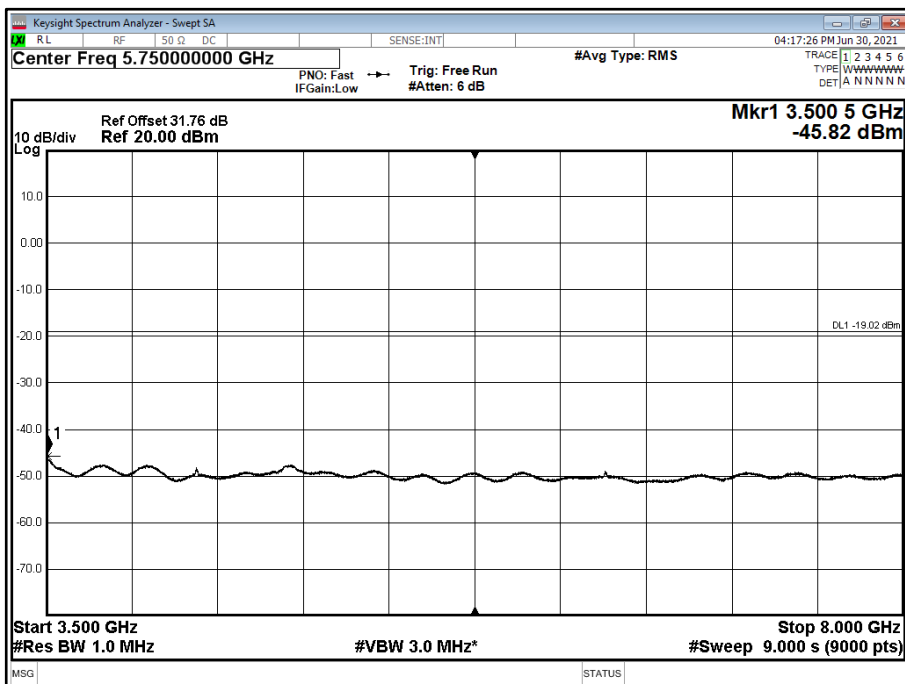



Antenna A - LTE / NR Modulation QPSK - LTE / NR Carrier Bandwidth ESS 40/60 10.0 MHz 15 kHz SCS - Channel Position T - Band 2 - Range 3500 to 8000 MHz

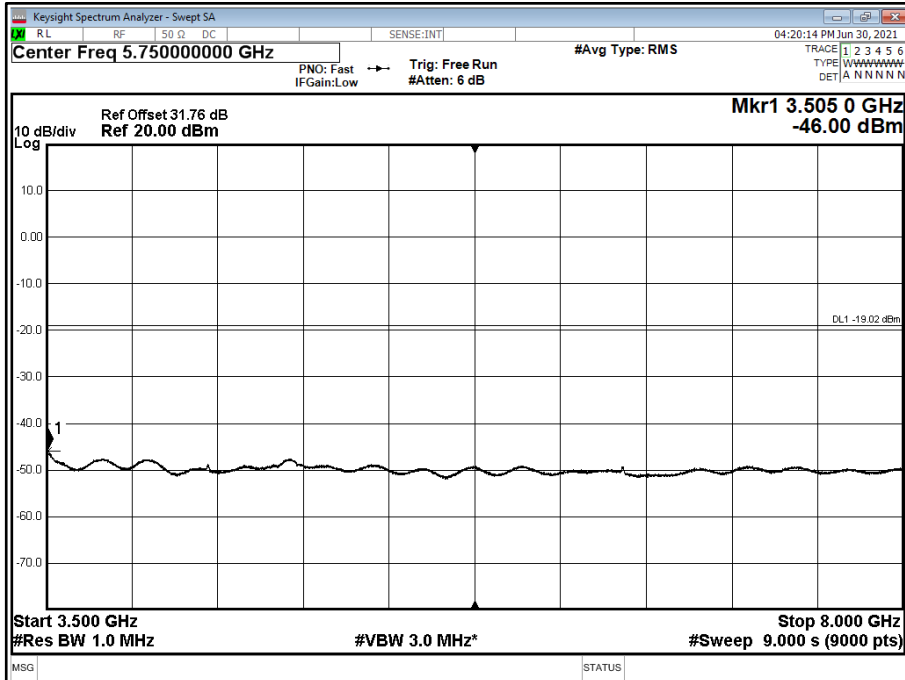

Antenna A - LTE / NR Modulation QPSK - LTE / NR Carrier Bandwidth ESS 40/60 20.0 MHz 15 kHz SCS - Channel Position B - Band 2 - Range 3500 to 8000 MHz

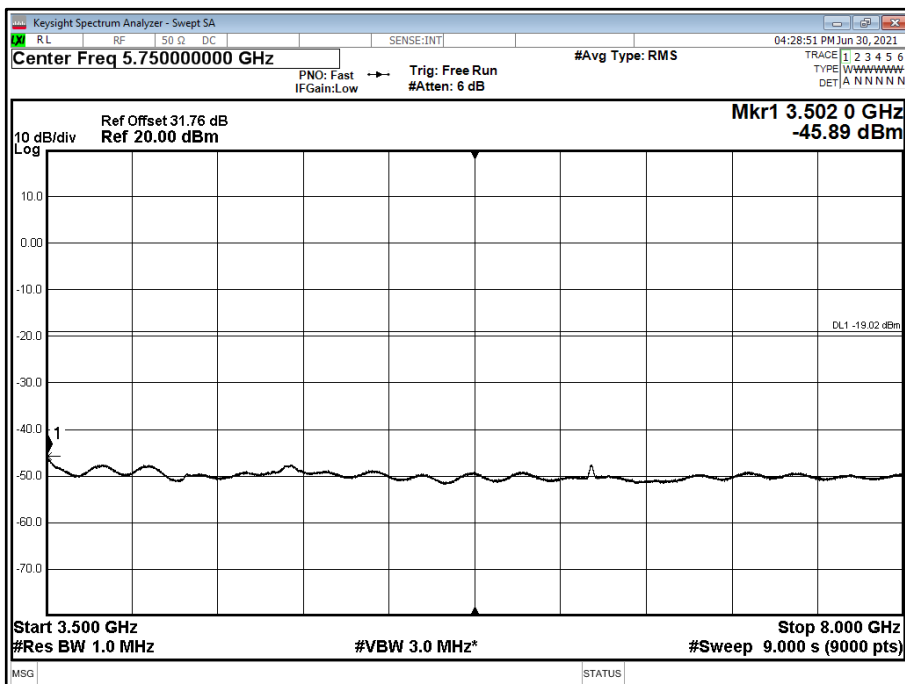



Antenna A - LTE / NR Modulation QPSK - LTE / NR Carrier Bandwidth ESS 40/60 20.0 MHz 15 kHz SCS - Channel Position M - Band 2 - Range 3500 to 8000 MHz

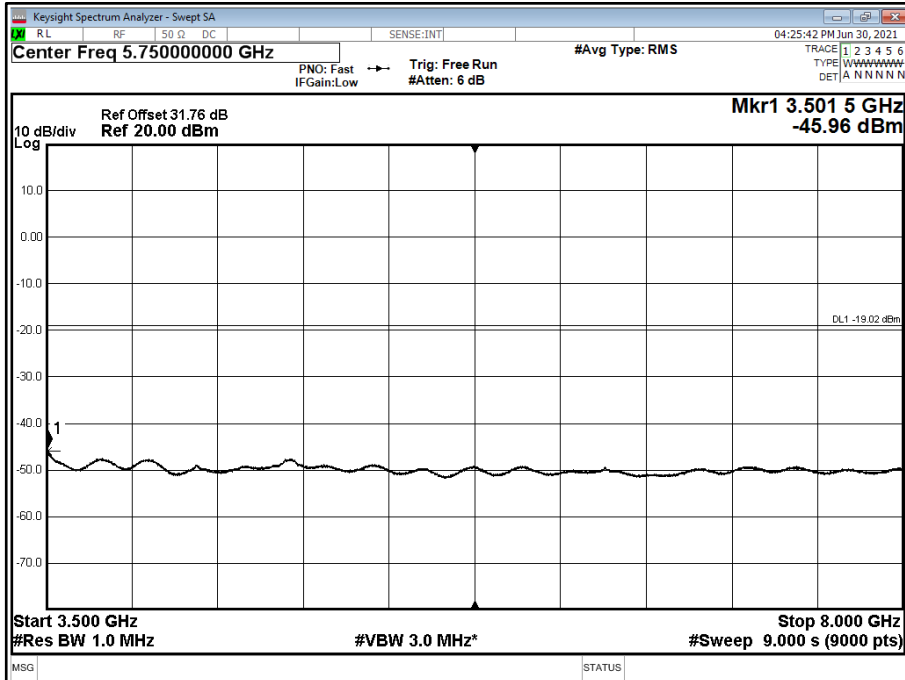

Antenna A - LTE / NR Modulation QPSK - LTE / NR Carrier Bandwidth ESS 40/60 20.0 MHz 15 kHz SCS - Channel Position T - Band 2 - Range 3500 to 8000 MHz

