



Add value.  
Inspire trust.



# Report

FCC and IC Testing of the  
Ericsson NR KRC 161 583/1 RRUS 32 B66A (2100 MHz) Base Station  
in accordance with FCC CFR 47 Part 2, FCC CFR 47 Part 27, Industry  
Canada RSS-GEN, RSS-139

COMMERCIAL-IN-CONFIDENCE

FCC ID: TA8AKRC161583-1

IC ID: 287AB-AS1615831

PREPARED BY

Handwritten signature of Daria Fiedorowicz in black ink.

Daria Fiedorowicz  
Senior Administrator  
(Technical)

APPROVED BY

Handwritten signature of Steve Scarfe in black ink.

Steve Scarfe  
Authorised Signatory

DATED

04 December 2019

Document 75947298 Report 05 Issue 1

December 2019



## CONTENTS

Section	Page No
<b>1</b>	<b>REPORT INFORMATION ..... 2</b>
1.1	Report Details ..... 3
1.2	Brief Summary of Results ..... 4
1.3	Configuration Description ..... 5
1.4	Declaration of Build Status ..... 6
1.5	Product Information ..... 7
1.6	Test Setup ..... 8
1.7	Test Conditions ..... 9
1.8	Deviation From The Standard ..... 9
1.9	Modification Record ..... 9
1.10	Alternative Test Site ..... 9
<b>2</b>	<b>TEST DETAILS ..... 10</b>
2.1	Maximum Peak Output Power and Peak to Average Ratio - Conducted ..... 11
2.2	Occupied Bandwidth ..... 14
2.3	Band Edge ..... 22
2.4	Transmitter Spurious Emissions ..... 29
<b>3</b>	<b>TEST EQUIPMENT USED ..... 34</b>
3.1	Test Equipment Used ..... 35
3.2	Measurement Uncertainty ..... 37
<b>4</b>	<b>ACCREDITATION, DISCLAIMERS AND COPYRIGHT ..... 38</b>
4.1	Accreditation, Disclaimers and Copyright ..... 39
<b>ANNEX A</b>	<b>Module Lists ..... A.2</b>



## **SECTION 1**

### **REPORT INFORMATION**



## 1.1 REPORT DETAILS

Manufacturer	Ericsson
Address	Torshamnsgatan 23 Kista SE-16480 Stockholm Sweden
Product Name & Product Number	RRUS 32 B66A & KRC 161 583/1
IC Model Name	AS1615831
Serial Number(s)	E553071497
Software Version	CXP9013268/12 Rev.R77UV
Hardware Version	R1F
Test Specification/Issue/Date	FCC CFR 47 Part 2: 2018 FCC CFR 47 Part 27: 2018 Industry Canada RSS-GEN: Issue 5 Amdt 1: 2019 Industry Canada RSS-139: Issue 3: 2015
Start of Test	01 November 2019
Finish of Test	07 November 2019
Name of Engineer(s)	Daniel Bishop
Related Document(s)	KDB 971168 D01 v02r02 KDB 662911 D01 v02r01

---

### ENGINEERING STATEMENT

The measurements shown in this report were made in accordance with the procedures described on test pages. All reported testing was carried out on a sample equipment to demonstrate compliance with FCC CFR 47 Part 27. The sample tested was found to comply with the requirements defined in the applied rules.

Test Engineer(s);

A handwritten signature in black ink that reads 'D. Bishop'.

---

Daniel Bishop



## 1.2 BRIEF SUMMARY OF RESULTS

A brief summary of results for each configuration, in accordance with FCC CFR 47 Part 2, FCC CFR 47 Part 27, Industry Canada RSS-GEN and Industry Canada RSS-139 is shown below.

Section	Specification Clause				Test Description	Result
	FCC CFR 47 Part 2	FCC CFR 47 Part 27	RSS-GEN	RSS-139		
2.1	2.1046	27.50	-	6.4	Maximum Peak Output Power and Peak to Average Ratio - Conducted	Pass
2.2	2.1049	27.53	6.6	-	Occupied Bandwidth	Pass
2.3	2.1051	27.53 (h)	-	6.5	Band Edge	Pass
2.4	2.1051	27.53 (h)	-	6.5	Transmitter Spurious Emissions	Pass

### Measurement Uncertainty Decision Statement

Determination of conformity with the specification limits is based on the results of the compliance measurement and does not take into account measurement instrumentation uncertainty as defined in ANSI C63.26:2015 Clause 1.3.



### 1.3 CONFIGURATION DESCRIPTION

Configuration	RAT	No. Of carriers	Carrier Bandwidth	Carrier Frequency Configuration (MHz)		
				Bottom	Middle	Top
A	NR	1	5 MHz – SCS 15kHz	2112.5	-	2177.5
	NR	1	10 MHz – SCS 15kHz	2115.0	-	2175.0
	NR	1	15 MHz – SCS 15kHz	2117.5	-	2172.5
	NR	1	20 MHz – SCS 15kHz	2120.0	-	2170.0
	NR	1	20 MHz – SCS 60kHz	2120.0	-	2170.0
B	NR	2	20 MHz + 20 MHz SCS 15kHz	-	2120.0+2170.0	-



## 1.4 DECLARATION OF BUILD STATUS

### DECLARATION OF BUILD STATUS

<b>MAIN EUT</b>	
<b>MANUFACTURING DESCRIPTION</b>	Radio Unit
<b>MANUFACTURER</b>	Ericsson AB
<b>PRODUCT NAME</b>	RRUS 32 B66A
<b>PART NUMBER</b>	KRC161583/1
<b>IC Model Name</b>	AS1615831
<b>SERIAL NUMBER</b>	E553071497
<b>HARDWARE VERSION</b>	R1F
<b>SOFTWARE VERSION</b>	CXP9013268/12 - R77UV
<b>TRANSMITTER OPERATING RANGE</b>	B66A: 2110 - 2180 MHz
<b>MODULATIONS</b>	WCDMA: QPSK, 16QAM, 64QAM LTE & NR: QPSK, 16QAM, 64QAM, 256QAM
<b>ITU DESIGNATION OF EMISSION</b>	NB-IoT SA channel: 209KW7D
	WCDMA 5 MHz BW channel: 5M00F9W
	LTE 5 MHz BW channel: 5M00F9W
	LTE 10 MHz BW channel: 10M0F9W
	LTE 15 MHz BW channel: 15M0F9W
	LTE 20 MHz BW channel: 20M0F9W
	NR 5 MHz BW channel: 4M47W7D
	NR 10 MHz BW channel: 9M28W7D
	NR 15 MHz BW channel: 14M1W7D
	NR 20 MHz BW channel: 18M9W7D
NR 20+20 MHz BW channel CA: 37M8W7D	
<b>OUTPUT POWER (RMS) (W or dBm)</b>	4 ports, 40W per port
	NB-IoT SA 1 x 20W per port
<b>FCC ID</b>	TA8AKRC161583-1
<b>IC ID</b>	287AB-AS1615831
<b>TECHNICAL DESCRIPTION (a brief description of the intended use and operation)</b>	Base station radio

Supports NB IoT for LTE (IB, GB, SA)

Signature Audun B Helle  
Audun Helle

Date 2019-11-28

No responsibility will be accepted by TÜV SÜD Product Service UK Limited as to the accuracy of the information declared in this document by the manufacturer.

## 1.5 PRODUCT INFORMATION

### 1.5.1 Technical Description

The Equipment Under Test (EUT) RRUS 32 B66A is an Ericsson AB Radio Unit working in the public mobile service 2100 MHz band which provides communication connections to 2100 MHz network. The RRUS 32 B66A operates from a -48V DC supply.

The Equipment Under Test (EUT) is shown in the photograph below. A full technical description can be found in the Manufacturer's documentation.



Equipment Under Test





## 1.6 TEST SETUP

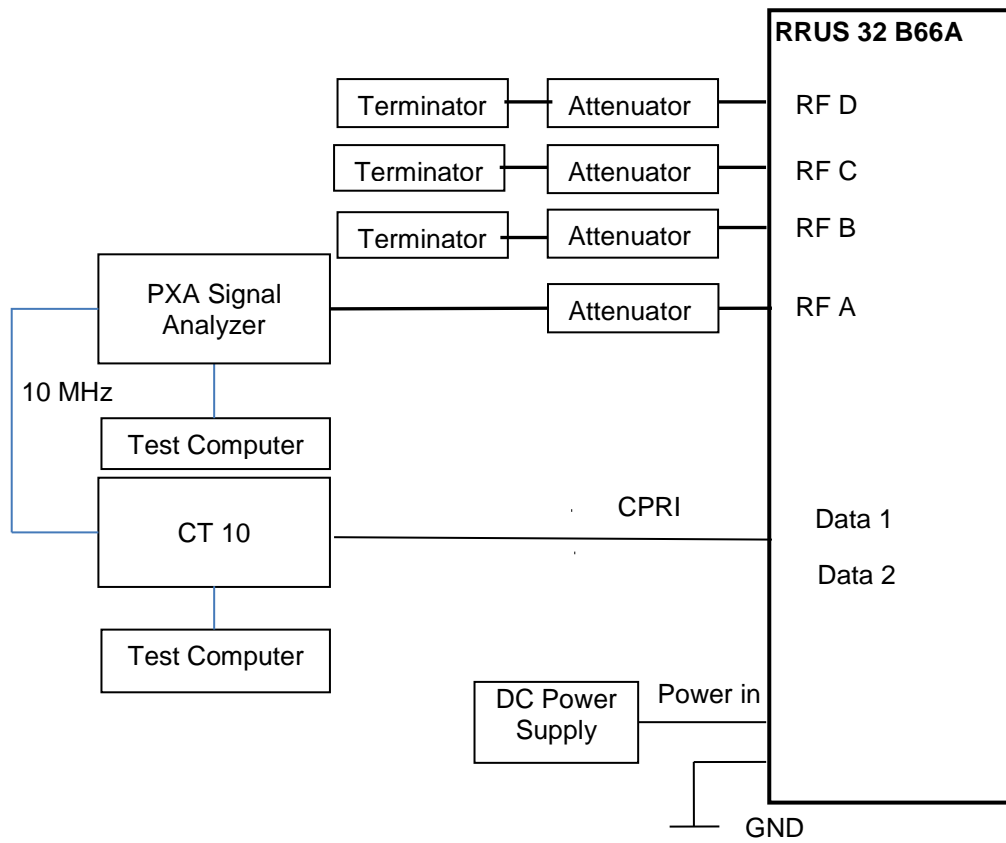



## 1.7 TEST CONDITIONS

For all tests the EUT was set up in accordance with the relevant test standard and to represent typical operating conditions. Tests were applied with the EUT situated in a shielded enclosure, test laboratories or a chamber as appropriate.

The EUT was powered from a -48V DC supply.

FCC Measurement Facility Registration Number  
90987 Octagon House, Fareham Test Laboratory

Industry Canada Accreditation  
IC2932B-1 Octagon House, Fareham Test Laboratory

## 1.8 DEVIATION FROM THE STANDARD

No deviations from the applicable test standards or test plan were made during testing.

## 1.9 MODIFICATION RECORD

No modifications were made to the EUT during testing.

## 1.10 ALTERNATIVE TEST SITE

Under our group UKAS Accreditation, TÜV SÜD conducted the following tests at Ericsson in Fareham, UK.

Test Name	Name of Engineer(s)
Maximum Peak Output Power and Peak to Average Ratio - Conducted	Daniel Bishop
Occupied Bandwidth	Daniel Bishop
Band Edge	Daniel Bishop
Transmitter Spurious Emissions	Daniel Bishop



## **SECTION 2**

### **TEST DETAILS**



**2.1 MAXIMUM PEAK OUTPUT POWER AND PEAK TO AVERAGE RATIO - CONDUCTED**

**2.1.1 Specification Reference**

FCC CFR 47 Part 2, Clause 2.1046  
 FCC CFR 47 Part 27, Clause 27.50  
 Industry Canada RSS-139, Clause 6.4

**2.1.2 Date of Test and Modification State**

01 November and 07 November 2019 - Modification State 0

**2.1.3 Test Equipment Used**

The major items of test equipment used for the above tests are identified in Section 3.1.

**2.1.4 Environmental Conditions**

Ambient Temperature 22.6°C  
 Relative Humidity 51.2%

**2.1.5 Test Method**

All measurements were made in accordance with FCC KDB 971168 D01, clause 5.2.1 and summed in accordance with FCC KDB 662911 D01.

**2.1.6 Test Results**

Configuration A

Maximum Output Power 46 dBm

Antenna	NR Modulation	NR Carrier Bandwidth	Peak to Average Ratio (PAR) / Output Power		
			PAR (dB)	Channel Position B	
				Average Power	
			dBm	dBm/MHz	
A	QPSK	5.0 MHz 15 kHz SCS	7.26	45.32	39.41
A	QPSK	10.0 MHz 15 kHz SCS	-	45.51	-
A	QPSK	15.0 MHz 15 kHz SCS	-	45.50	-
A	QPSK	20.0 MHz 15 kHz SCS	-	45.52	-
A	QPSK	20.0 MHz 60 kHz SCS	-	45.66	-



Antenna A - NR Modulation QPSK - NR Carrier Bandwidth 5.0 MHz 15 kHz SCS - Channel Position B

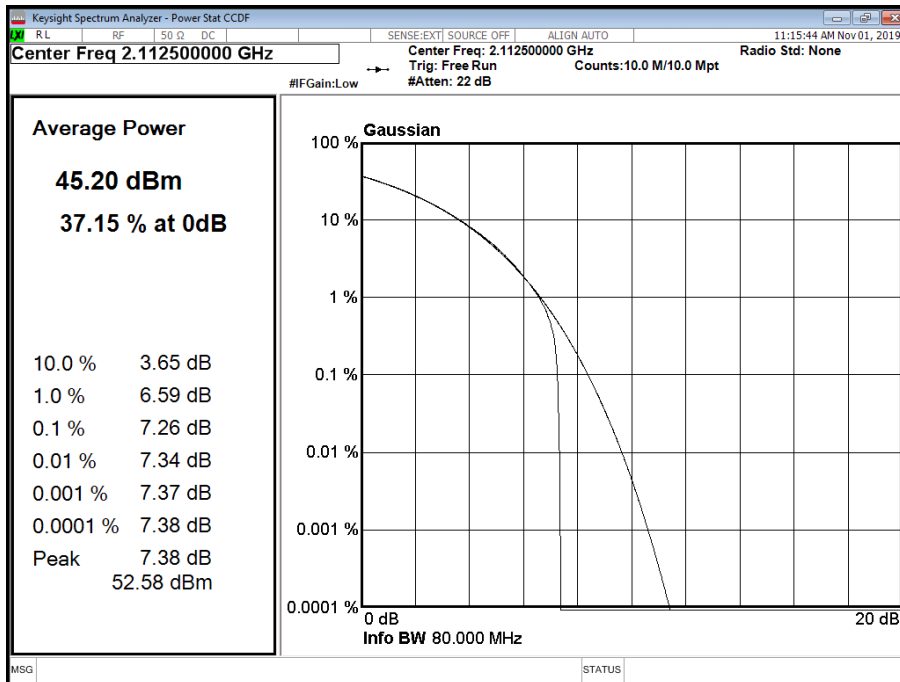

Configuration A

Maximum Output Power 46 dBm

Antenna	NR Modulation	NR Carrier Bandwidth	Peak to Average Ratio (PAR) / Output Power		
			Channel Position T		
			PAR (dB)	Average Power	
dBm	dBm/MHz				
A	QPSK	5.0 MHz 15 kHz SCS	7.26	45.12	39.30
A	QPSK	10.0 MHz 15 kHz SCS	-	45.46	-
A	QPSK	15.0 MHz 15 kHz SCS	-	45.61	-
A	QPSK	20.0 MHz 15 kHz SCS	-	45.66	-
A	QPSK	20.0 MHz 60 kHz SCS	-	45.81	-



Antenna A - NR Modulation QPSK - NR Carrier Bandwidth 5.0 MHz 15 kHz SCS - Channel Position T

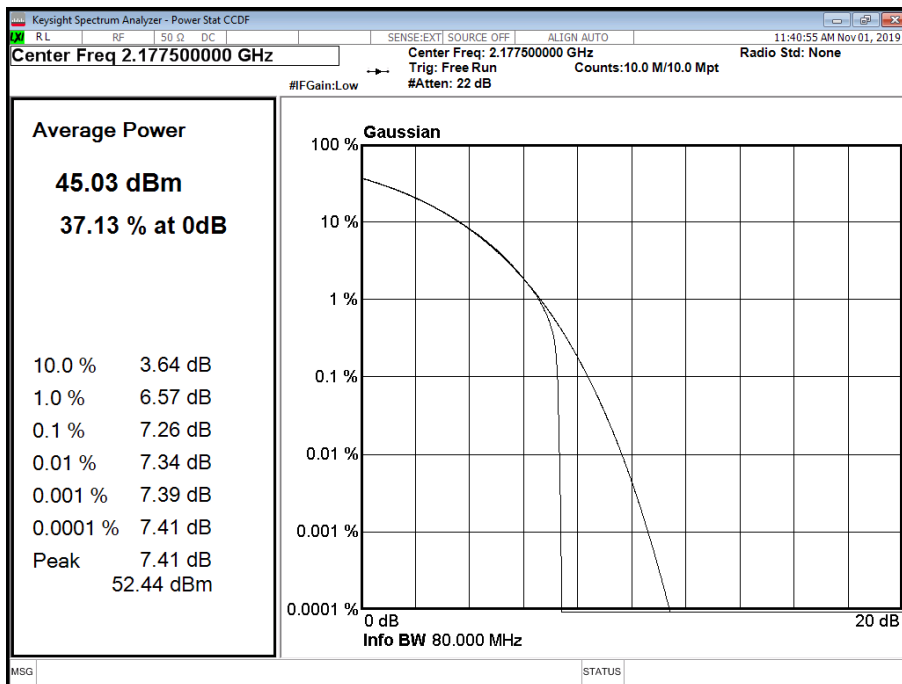

Configuration B

Maximum Output Power 46 dBm

Antenna	NR Modulation	NR Carrier Bandwidth	Peak to Average Ratio (PAR) / Output Power		
			Channel Position M		
			PAR (dB)	Average Power	
dBm	dBm/MHz				
A	QPSK	20.0 +20.0 MHz 15 kHz SCS	-	45.61	-

Limit	
Peak Power	≤500 W or ≤+57 dBm
Peak to Average Ratio	13 dB



## 2.2 OCCUPIED BANDWIDTH

### 2.2.1 Specification Reference

FCC CFR 47 Part 2, Clause 2.1049  
 FCC CFR 47 Part 27, Clause 27.53  
 Industry Canada RSS-GEN, Clause 6.6

### 2.2.2 Date of Test and Modification State

01 November 2019 - Modification State 0

### 2.2.3 Test Equipment Used

The major items of test equipment used for the above tests are identified in Section 3.1.

### 2.2.4 Environmental Conditions

Ambient Temperature 22.6°C  
 Relative Humidity 51.2%

### 2.2.5 Test Method

All measurements were made in accordance with FCC KDB 971168 D01.

### 2.2.6 Test Results

Configuration A

Maximum Output Power 46 dBm

Antenna	NR Modulation	NR Carrier Bandwidth	Result (KHz)			
			Channel Position B		Channel Position T	
			Occupied Bandwidth	-26 dB Bandwidth	Occupied Bandwidth	-26 dB Bandwidth
A	QPSK	5.0 MHz 15 kHz SCS	4,470.25	4,831.68	4,469.70	4,828.88
A	QPSK	10.0 MHz 15 kHz SCS	9,281.90	9,768.01	9,268.79	9,775.93
A	QPSK	15.0 MHz 15 kHz SCS	14,103.72	14,779.93	14,090.12	14,713.15
A	QPSK	20.0 MHz 15 kHz SCS	18,931.42	19,747.16	18,922.20	19,731.35
A	QPSK	20.0 MHz 60 kHz SCS	17,206.62	19,470.87	17,224.49	19,533.34



Antenna A - NR Modulation QPSK - NR Carrier Bandwidth 5.0 MHz 15 kHz SCS - Channel Position B

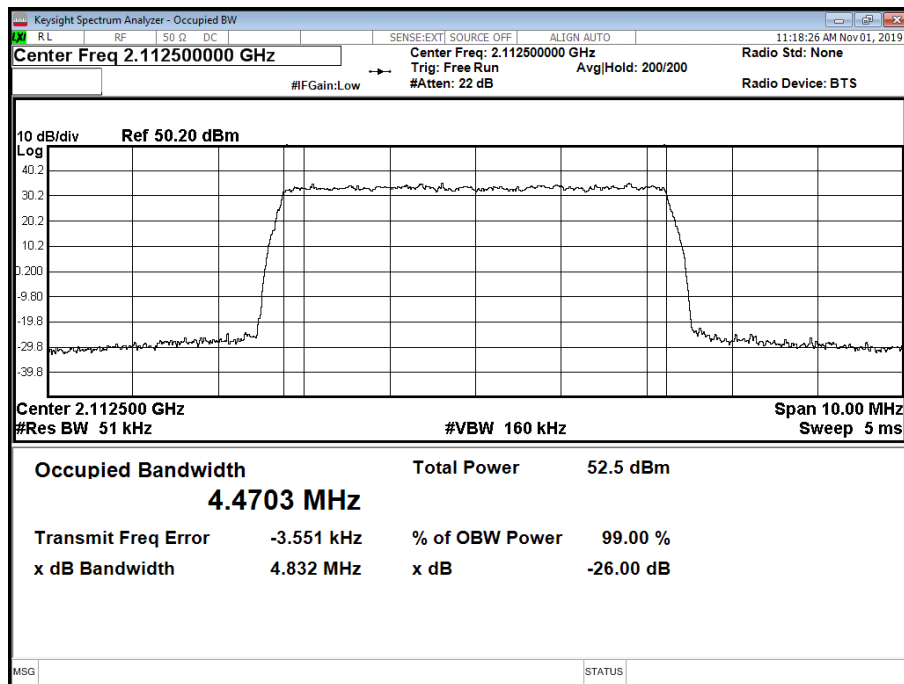

Antenna A - NR Modulation QPSK - NR Carrier Bandwidth 5.0 MHz 15 kHz SCS - Channel Position T

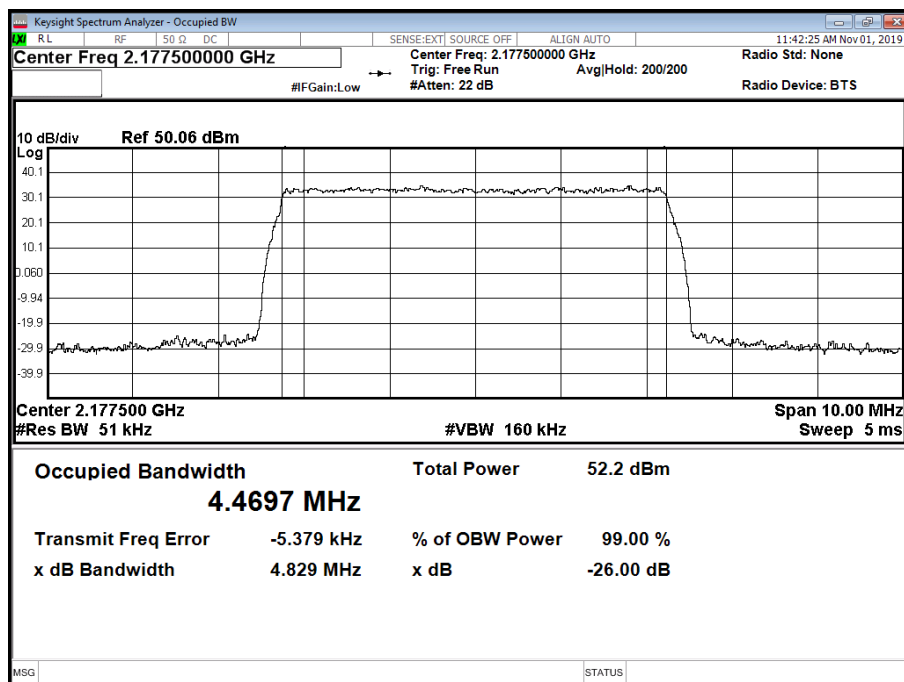





Antenna A - NR Modulation QPSK - NR Carrier Bandwidth 10.0 MHz 15 kHz SCS - Channel Position B

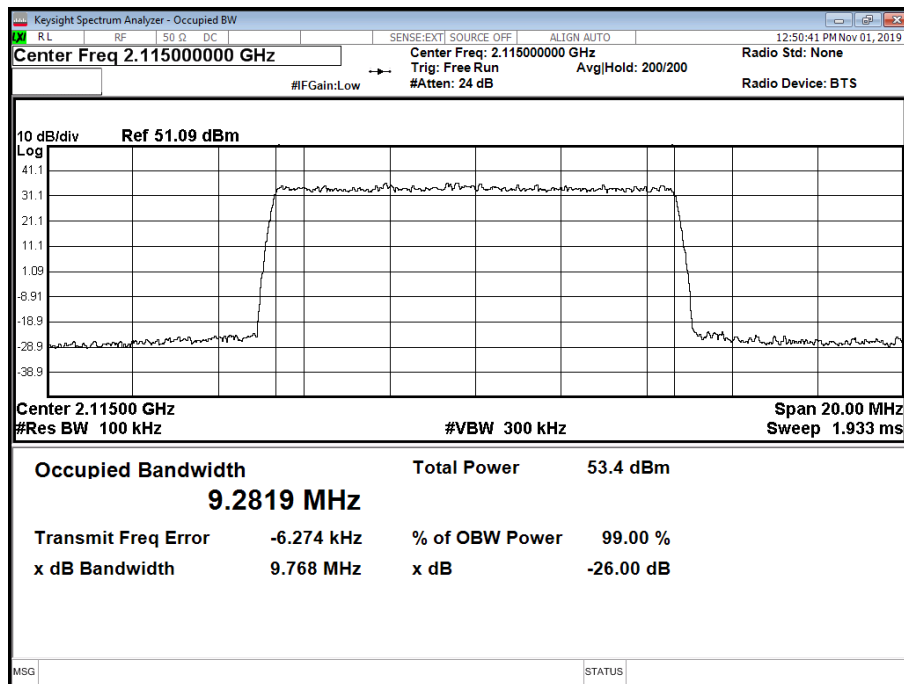

Antenna A - NR Modulation QPSK - NR Carrier Bandwidth 10.0 MHz 15 kHz SCS - Channel Position T

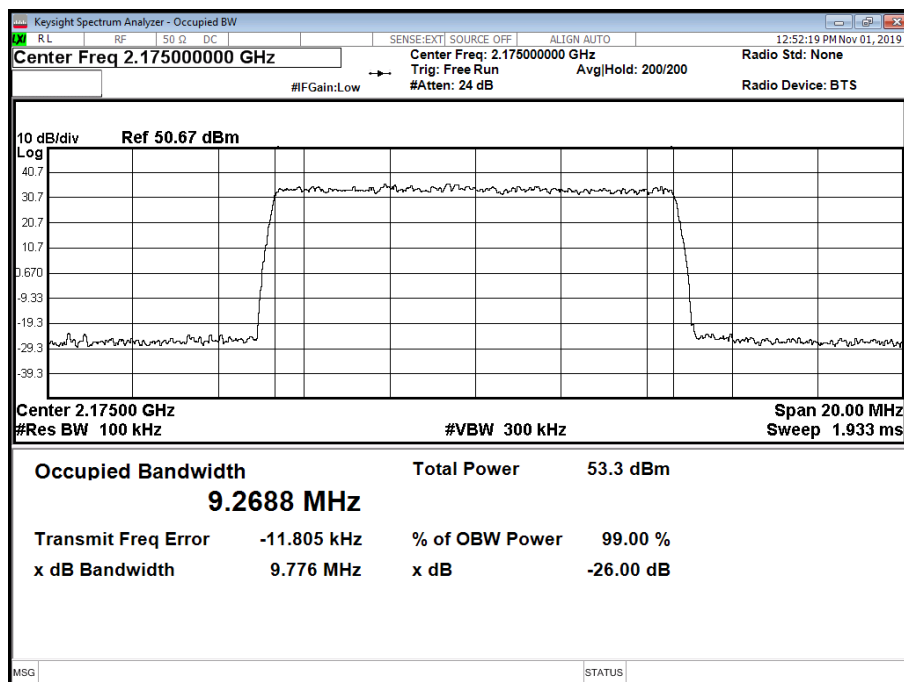



Antenna A - NR Modulation QPSK - NR Carrier Bandwidth 15.0 MHz 15 kHz SCS - Channel Position B

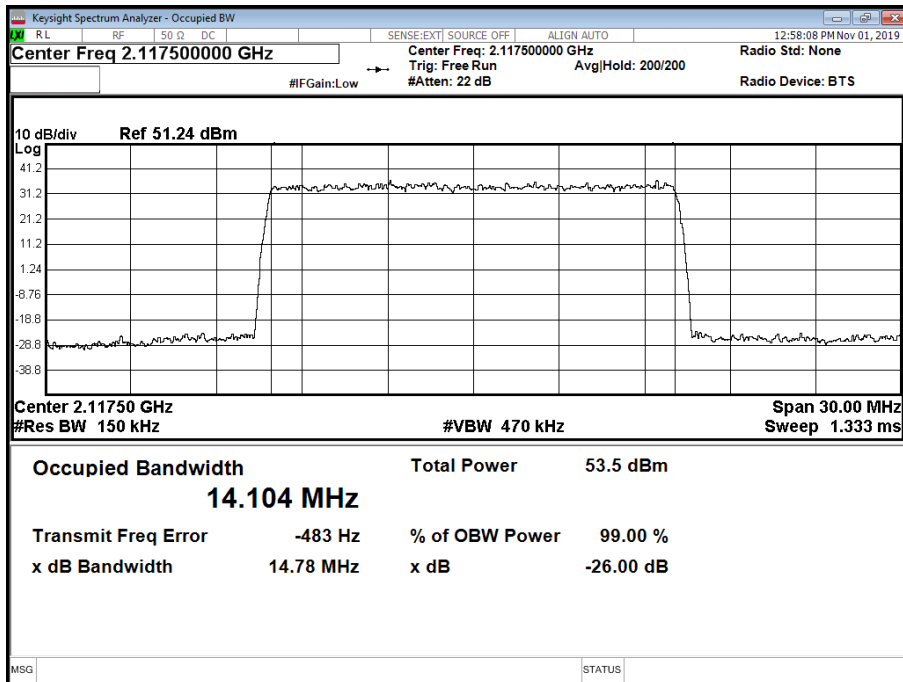

Antenna A - NR Modulation QPSK - NR Carrier Bandwidth 15.0 MHz 15 kHz SCS - Channel Position T

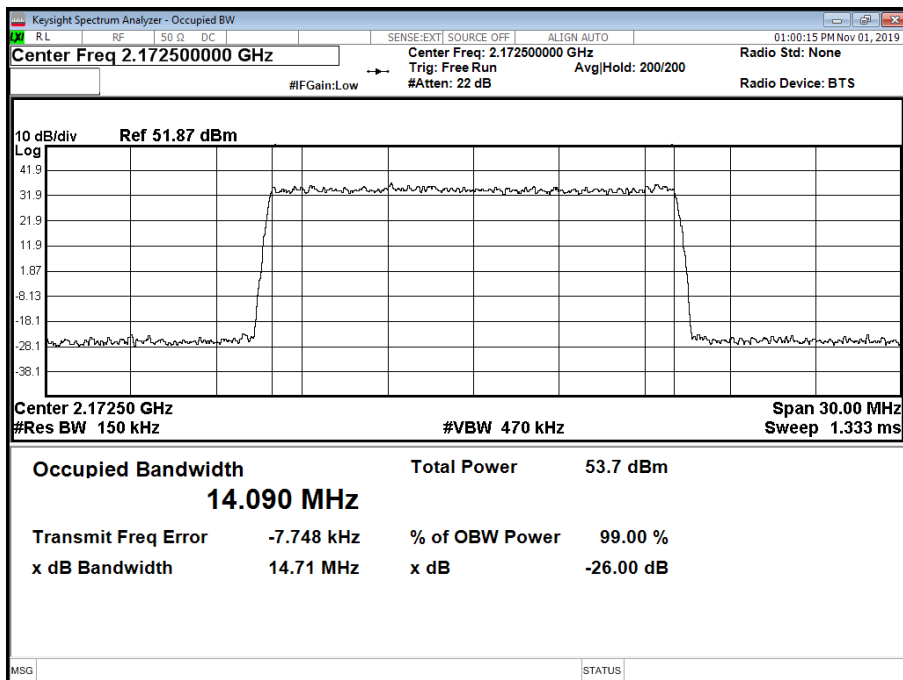



Antenna A - NR Modulation QPSK - NR Carrier Bandwidth 20.0 MHz 15 kHz SCS - Channel Position B

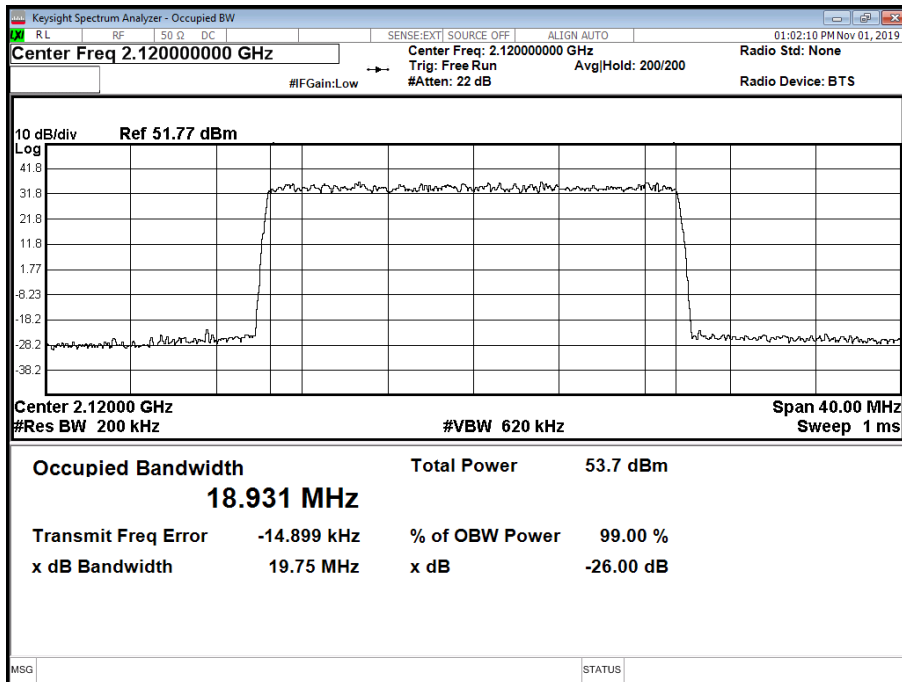

Antenna A - NR Modulation QPSK - NR Carrier Bandwidth 20.0 MHz 15 kHz SCS - Channel Position T

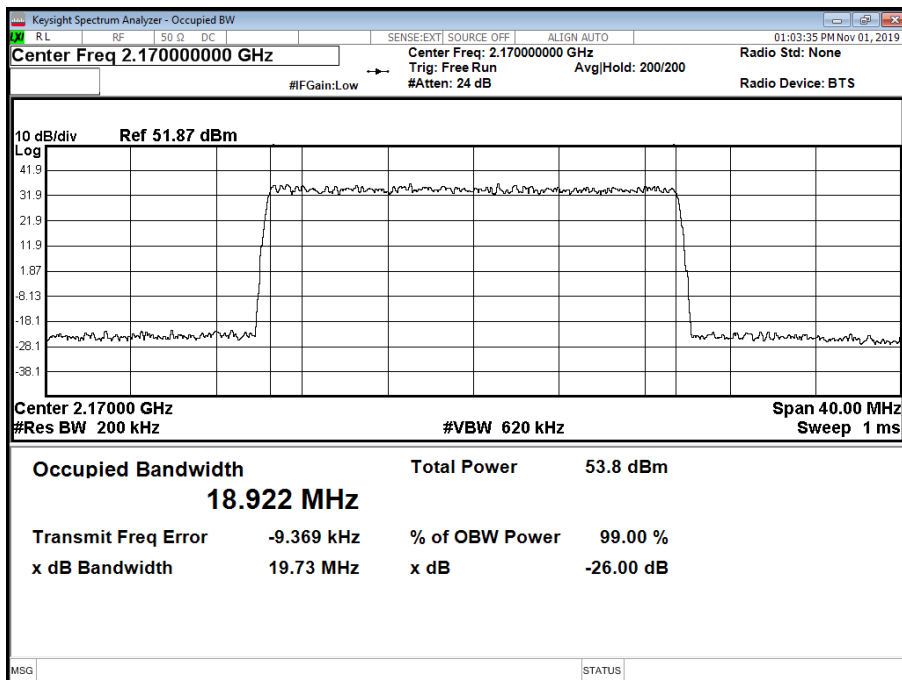



Antenna A - NR Modulation QPSK - NR Carrier Bandwidth 20.0 MHz 60 kHz SCS - Channel Position B

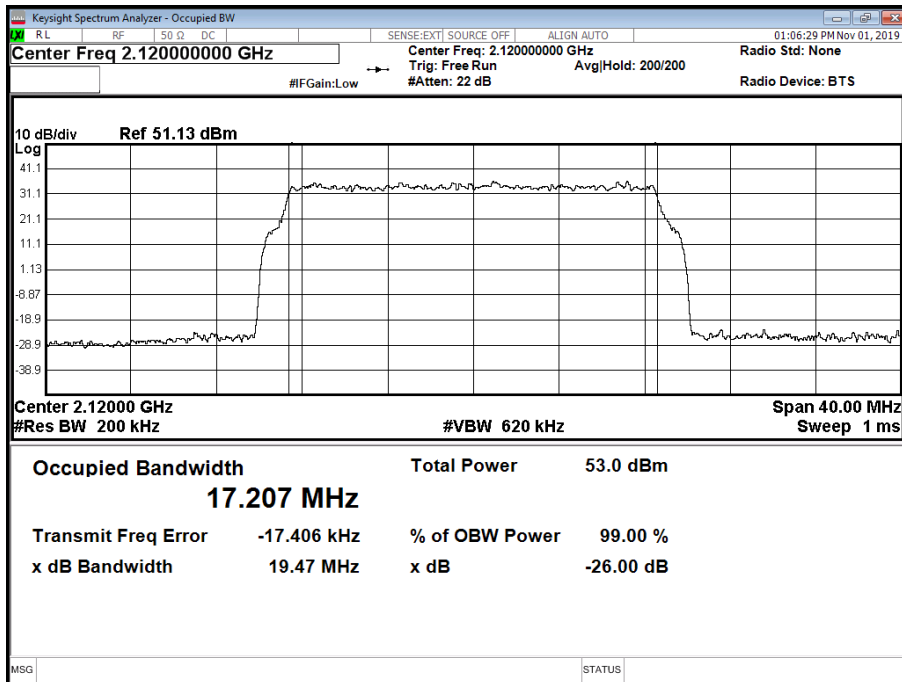

Antenna A - NR Modulation QPSK - NR Carrier Bandwidth 20.0 MHz 60 kHz SCS - Channel Position T

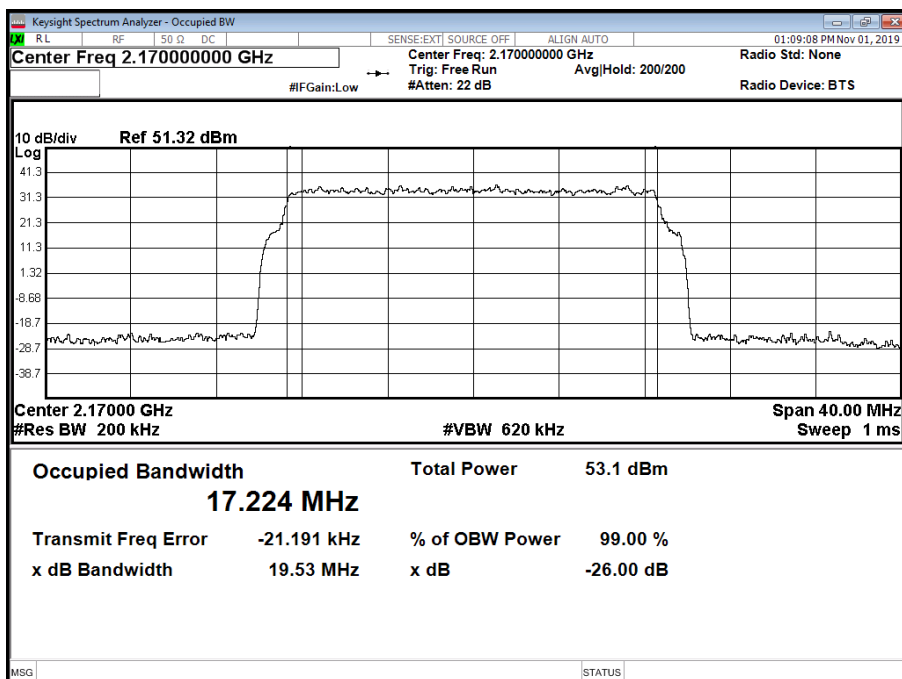



Configuration B

Maximum Output Power 46 dBm

Antenna	NR Modulation	NR Carrier Bandwidth	Result (KHz)					
			Channel Position B		Channel Position T		Sum	
			Occupied Bandwidth	-26 dB Bandwidth	Occupied Bandwidth	-26 dB Bandwidth	Occupied Bandwidth	-26 dB Bandwidth
A	QPSK	20.0 +20.0 MHz 15 kHz SCS	18.92	19.71	18.90	19.72	37.82	-

Antenna A - NR Modulation QPSK - NR Carrier Bandwidth 20.0 +20.0 MHz 15 kHz SCS - Channel Position B

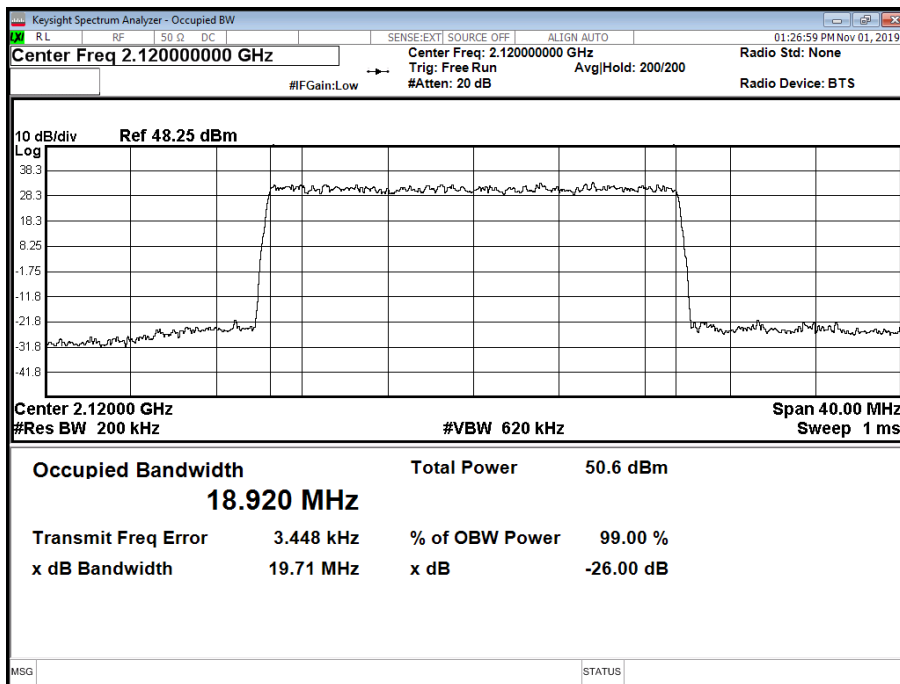



Antenna A - NR Modulation QPSK - NR Carrier Bandwidth 20.0 +20.0 MHz 15 kHz SCS - Channel Position T

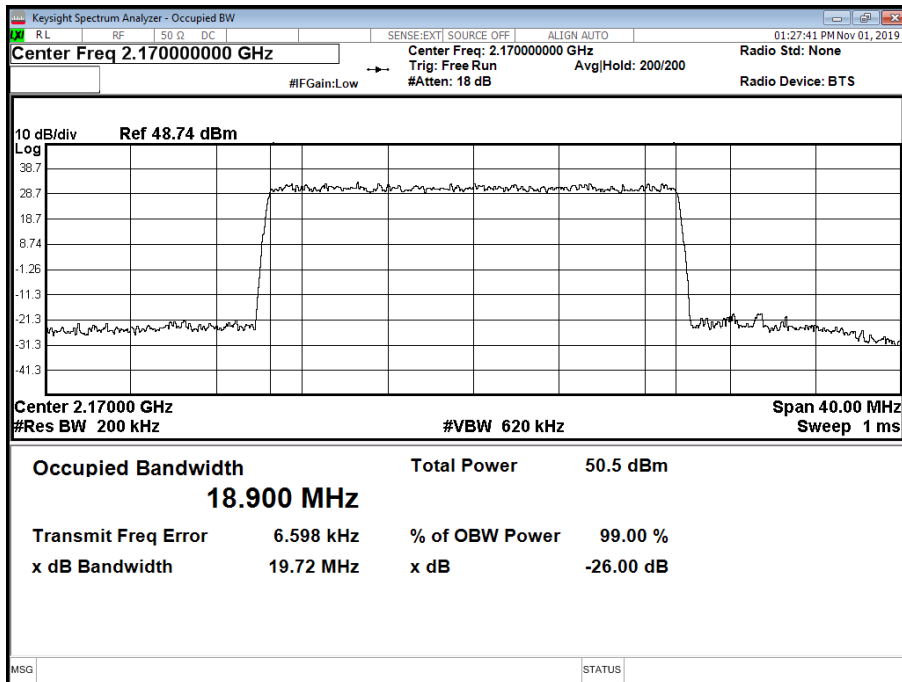



## 2.3 BAND EDGE

### 2.3.1 Specification Reference

FCC CFR 47 Part 2, Clause 2.1051  
 FCC CFR 47 Part 27, Clause 27.53 (h)  
 Industry Canada RSS-139, Clause 6.5

### 2.3.2 Date of Test and Modification State

01 November 2019 - Modification State 0

### 2.3.3 Test Equipment Used

The major items of test equipment used for the above tests are identified in Section 3.1.

### 2.3.4 Environmental Conditions

Ambient Temperature 22.6°C  
 Relative Humidity 51.2%

### 2.3.5 Test Method

All measurements were made in accordance with FCC KDB 971168 D01.

Each antenna port has been declared as being equivalent, therefore measurements were made on one antenna port only. To account for this, the limit was tightened by  $10 * \text{Log}(N)$ , where N is equal to the number of MIMO antenna ports.

For four ports, the limit was calculated as being  $-13 \text{ dBm} - 10 * \text{Log}(4) = -19 \text{ dBm}$ .

For dual ports, the limit was calculated as being  $-13 \text{ dBm} - 10 * \text{Log}(2) = -16 \text{ dBm}$ .

### 2.3.6 Test Results

Configuration A

Maximum Output Power 46 dBm

Antenna	NR Modulation	NR Carrier Bandwidth	Band Edge (MHz)	
			Channel Position B	Channel Position T
A	QPSK	5.0 MHz 15 kHz SCS	2,112.5	2,177.5
A	QPSK	10.0 MHz 15 kHz SCS	2,115.0	2,175.0
A	QPSK	15.0 MHz 15 kHz SCS	2,117.5	2,172.5
A	QPSK	20.0 MHz 15 kHz SCS	2,120.0	2,170.0
A	QPSK	20.0 MHz 60 kHz SCS	2,120.0	2,170.0



Antenna A - NR Modulation QPSK - NR Carrier Bandwidth 5.0 MHz 15 kHz SCS - Channel Position B

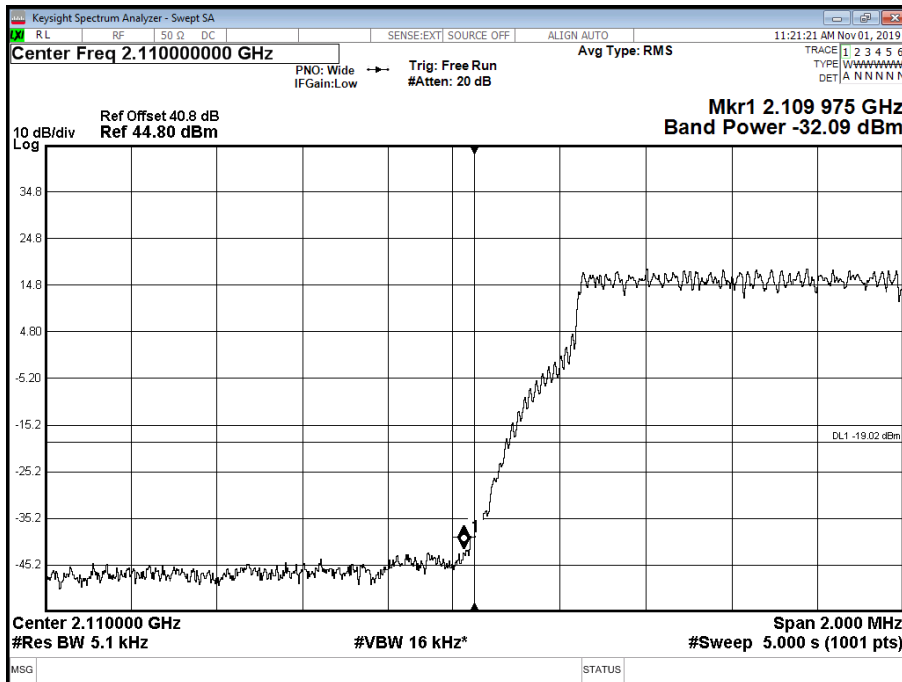

Antenna A - NR Modulation QPSK - NR Carrier Bandwidth 5.0 MHz 15 kHz SCS - Channel Position T

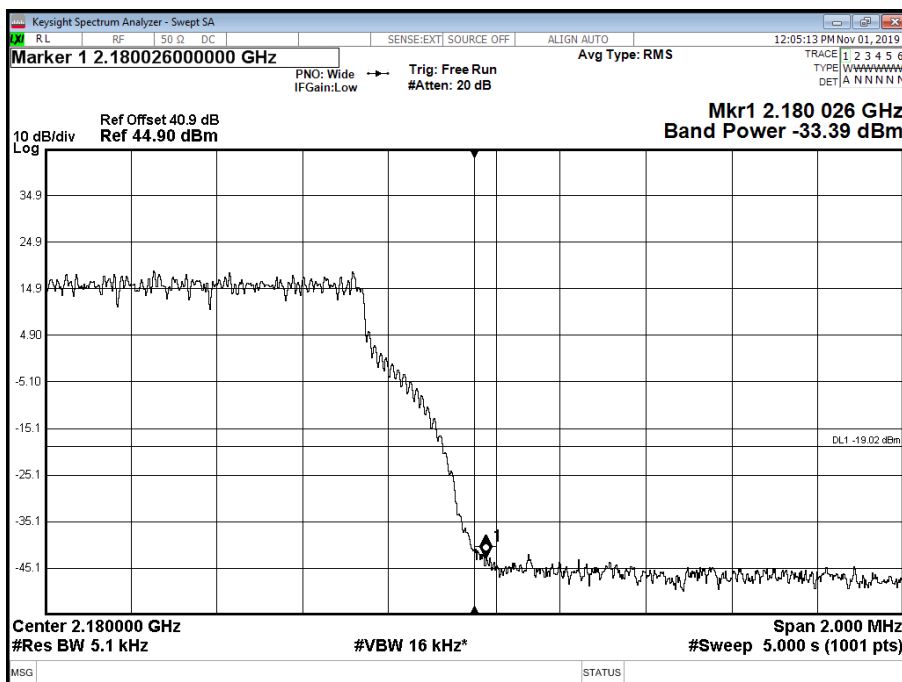





Antenna A - NR Modulation QPSK - NR Carrier Bandwidth 10.0 MHz 15 kHz SCS - Channel Position B

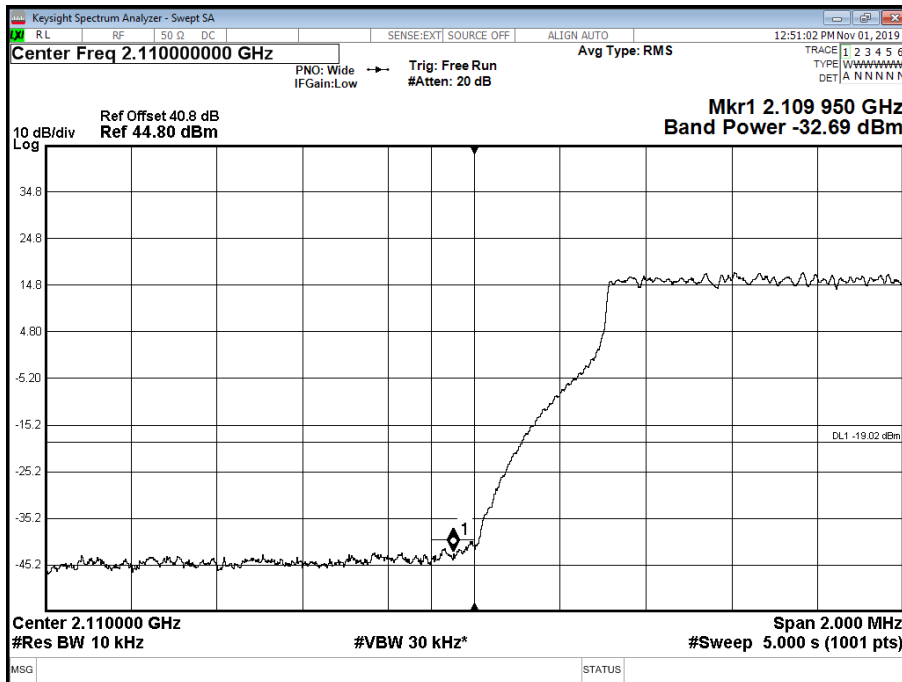

Antenna A - NR Modulation QPSK - NR Carrier Bandwidth 10.0 MHz 15 kHz SCS - Channel Position T

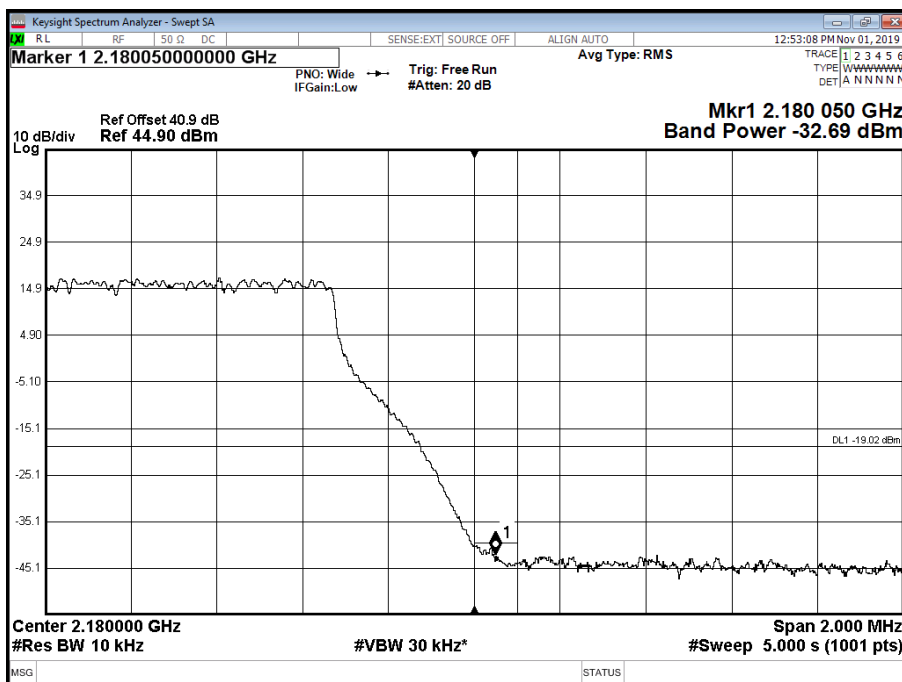



Antenna A - NR Modulation QPSK - NR Carrier Bandwidth 15.0 MHz 15 kHz SCS - Channel Position B

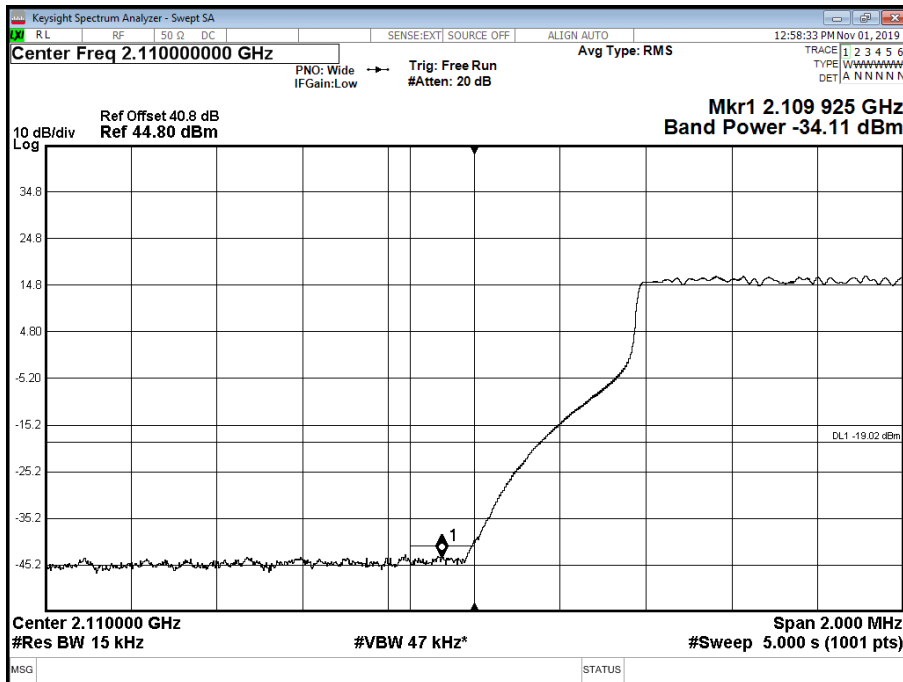

Antenna A - NR Modulation QPSK - NR Carrier Bandwidth 15.0 MHz 15 kHz SCS - Channel Position T

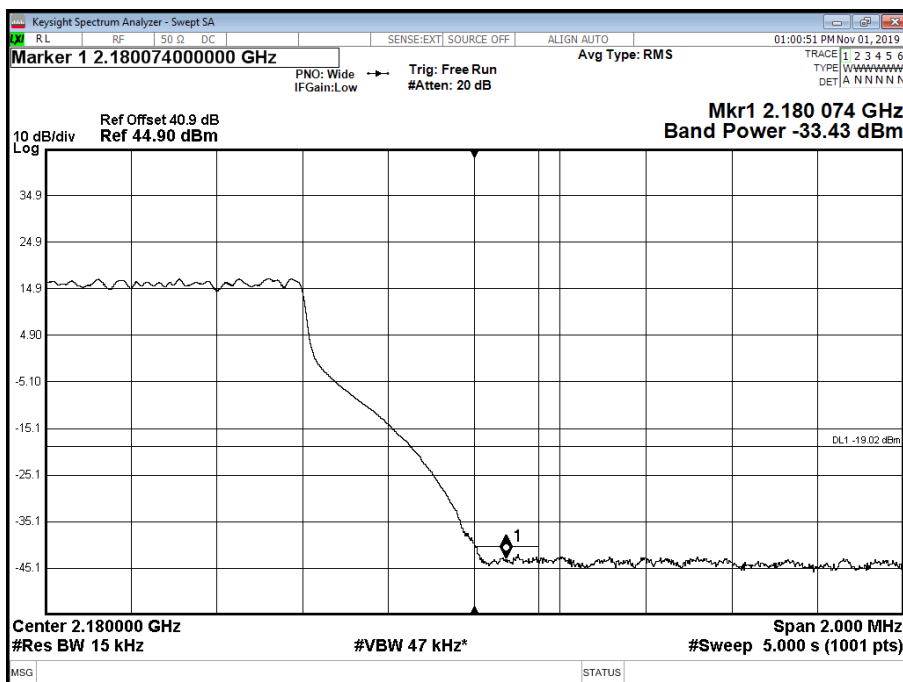



Antenna A - NR Modulation QPSK - NR Carrier Bandwidth 20.0 MHz 15 kHz SCS - Channel Position B

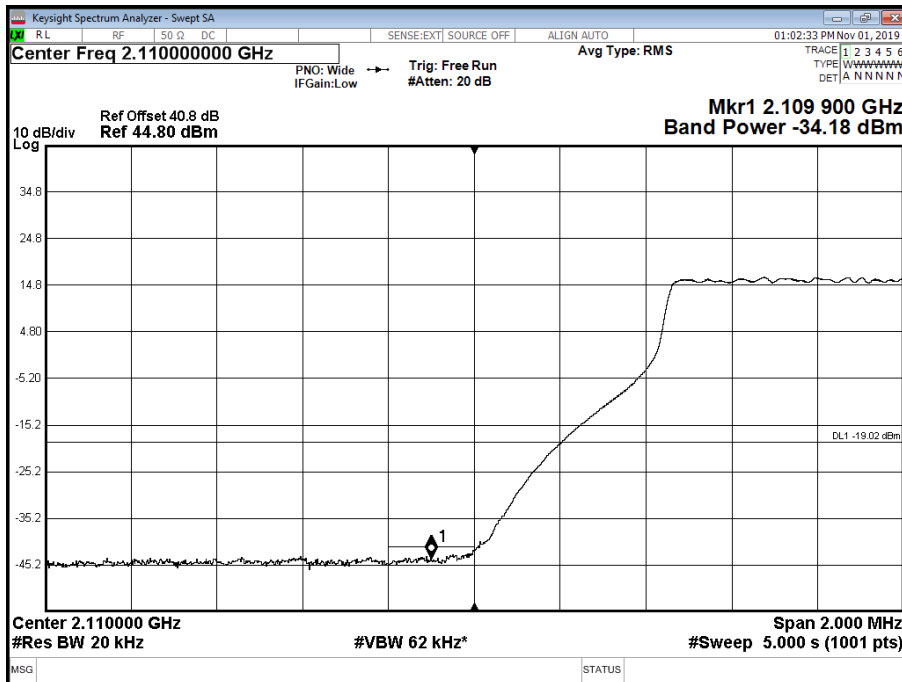

Antenna A - NR Modulation QPSK - NR Carrier Bandwidth 20.0 MHz 15 kHz SCS - Channel Position T

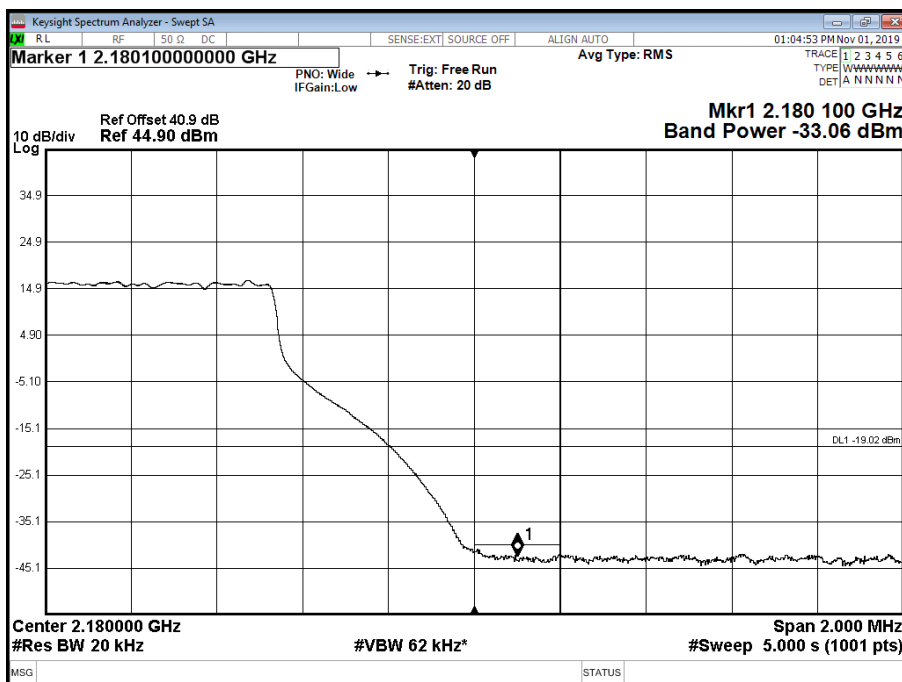



Antenna A - NR Modulation QPSK - NR Carrier Bandwidth 20.0 MHz 60 kHz SCS - Channel Position B

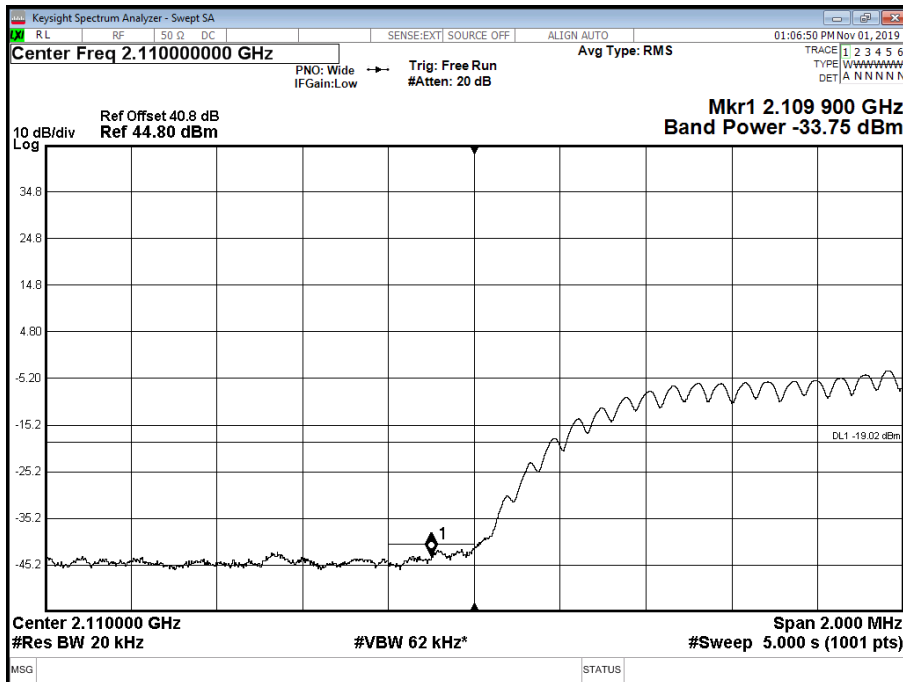

Antenna A - NR Modulation QPSK - NR Carrier Bandwidth 20.0 MHz 60 kHz SCS - Channel Position T

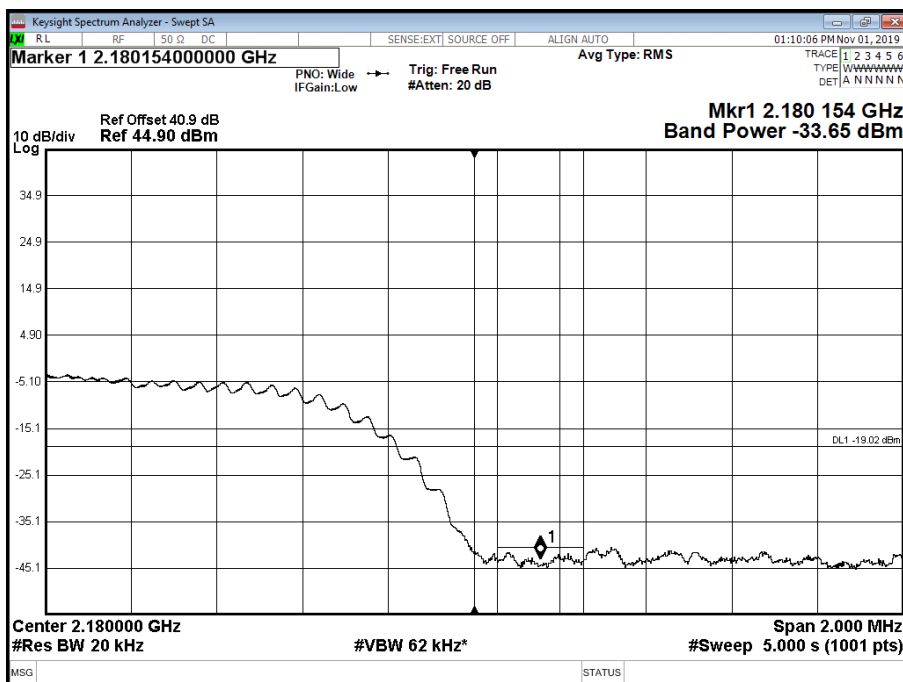



Limit	-19 dBm
-------	---------



## **2.4 TRANSMITTER SPURIOUS EMISSIONS**

### **2.4.1 Specification Reference**

FCC CFR 47 Part 2, Clause 2.1051  
FCC CFR 47 Part 27, Clause 27.53 (h)  
Industry Canada RSS-139, Clause 6.5

### **2.4.2 Date of Test and Modification State**

01 November 2019 - Modification State 0

### **2.4.3 Test Equipment Used**

The major items of test equipment used for the above tests are identified in Section 3.1.

### **2.4.4 Environmental Conditions**

Ambient Temperature	22.6°C
Relative Humidity	51.2%

### **2.4.5 Test Method**

All measurements were made in accordance with FCC KDB 971168 D01.

Each antenna port has been declared as being equivalent, therefore measurements were made on one antenna port only. To account for this, the limit was tightened by  $10 * \text{Log}(N)$ , where N is equal to the number of MIMO antenna ports.

For four ports, the limit was calculated as being  $-13 \text{ dBm} - 10 * \text{Log}(4) = -19 \text{ dBm}$ .

For dual ports, the limit was calculated as being  $-13 \text{ dBm} - 10 * \text{Log}(2) = -16 \text{ dBm}$ .

### **2.4.6 Test Results**

Configuration A

Maximum Output Power 46 dBm



Antenna A - NR Modulation QPSK - NR Carrier Bandwidth 5.0 MHz 15 kHz SCS - Channel Position B - Band 1 - Range 0.009 to 3500 MHz

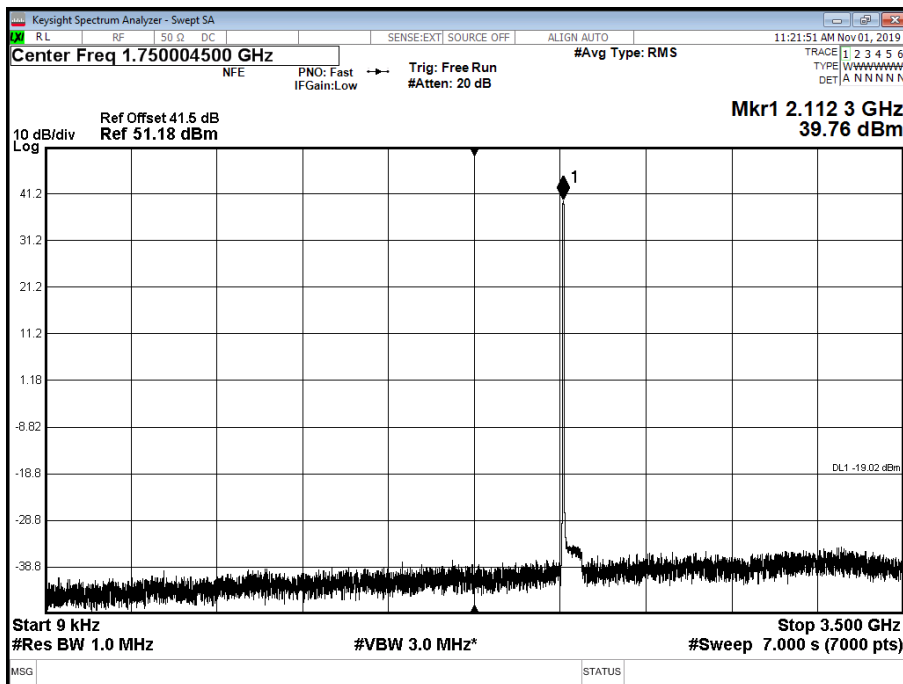

Antenna A - NR Modulation QPSK - NR Carrier Bandwidth 5.0 MHz 15 kHz SCS - Channel Position T - Band 1 - Range 0.009 to 3500 MHz

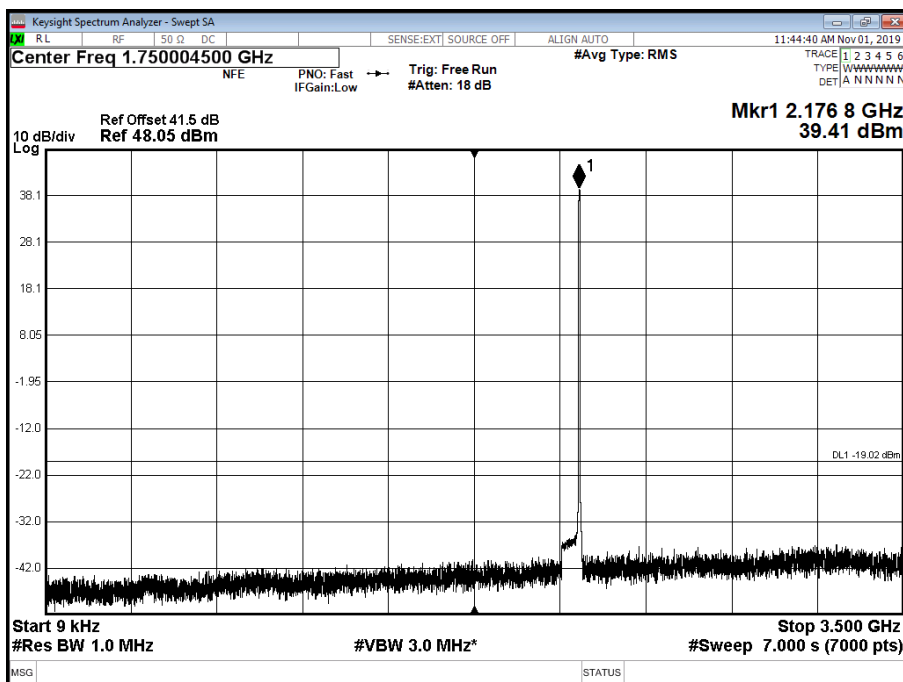



Antenna A - NR Modulation QPSK - NR Carrier Bandwidth 5.0 MHz 15 kHz SCS - Channel Position B - Band 2 - Range 3500 to 12000 MHz

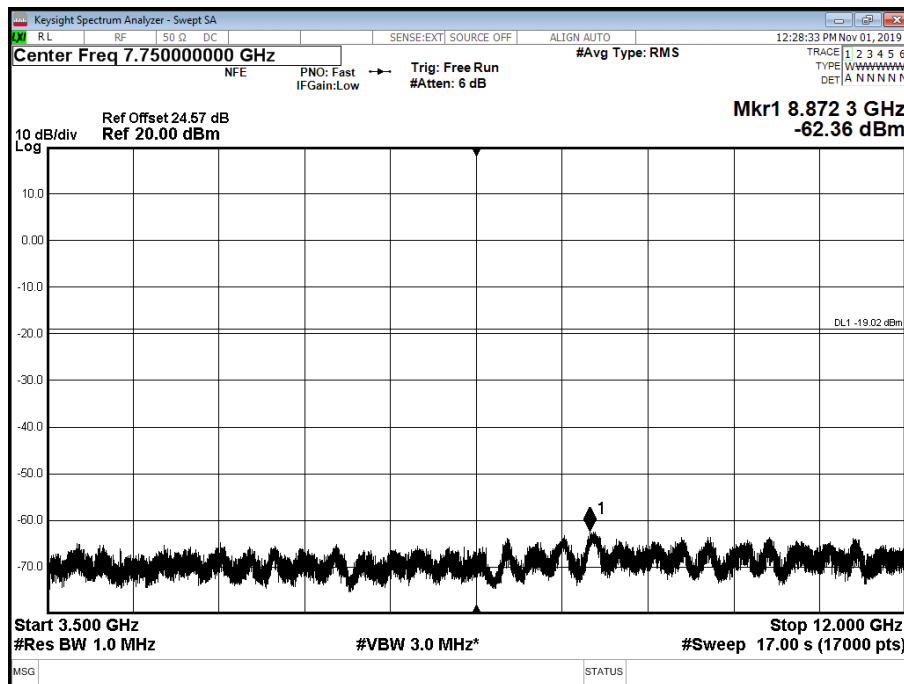

Antenna A - NR Modulation QPSK - NR Carrier Bandwidth 5.0 MHz 15 kHz SCS - Channel Position T - Band 2 - Range 3500 to 12000 MHz

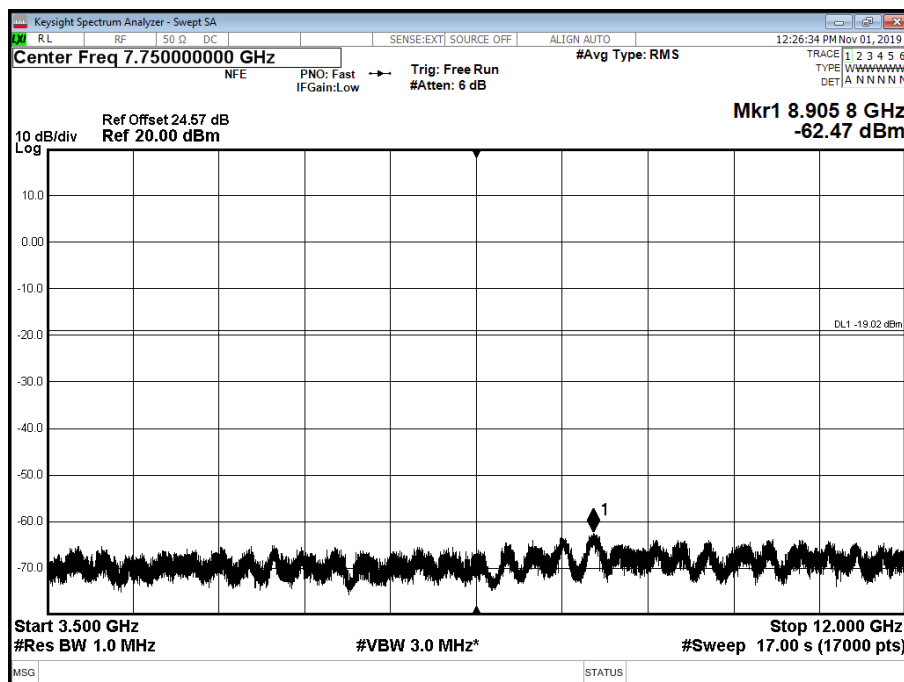





Antenna A - NR Modulation QPSK - NR Carrier Bandwidth 5.0 MHz 15 kHz SCS - Channel Position B - Band 3 - Range 12000 to 18000 MHz

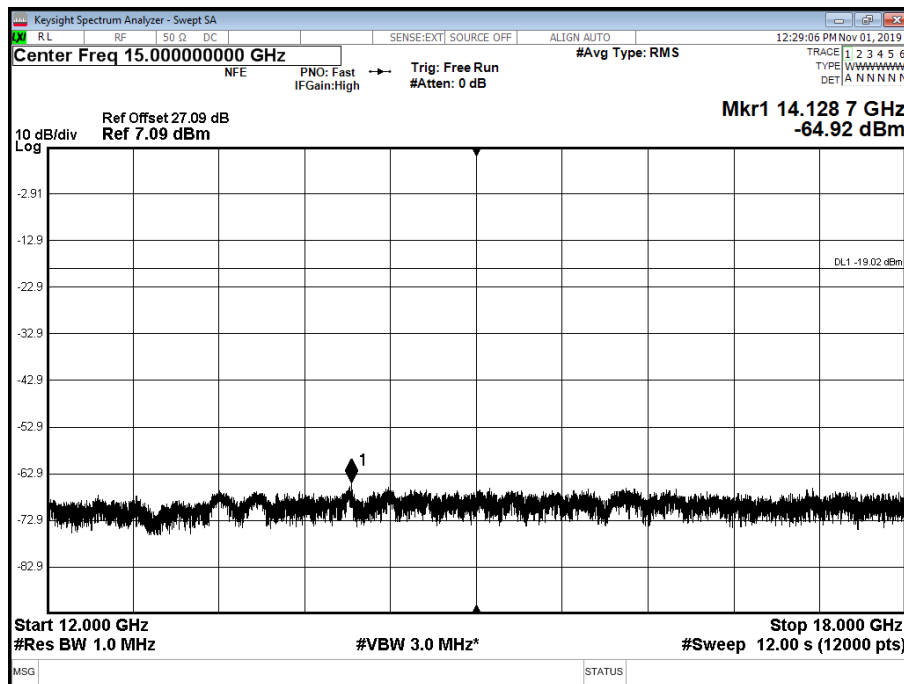

Antenna A - NR Modulation QPSK - NR Carrier Bandwidth 5.0 MHz 15 kHz SCS - Channel Position T - Band 3 - Range 12000 to 18000 MHz

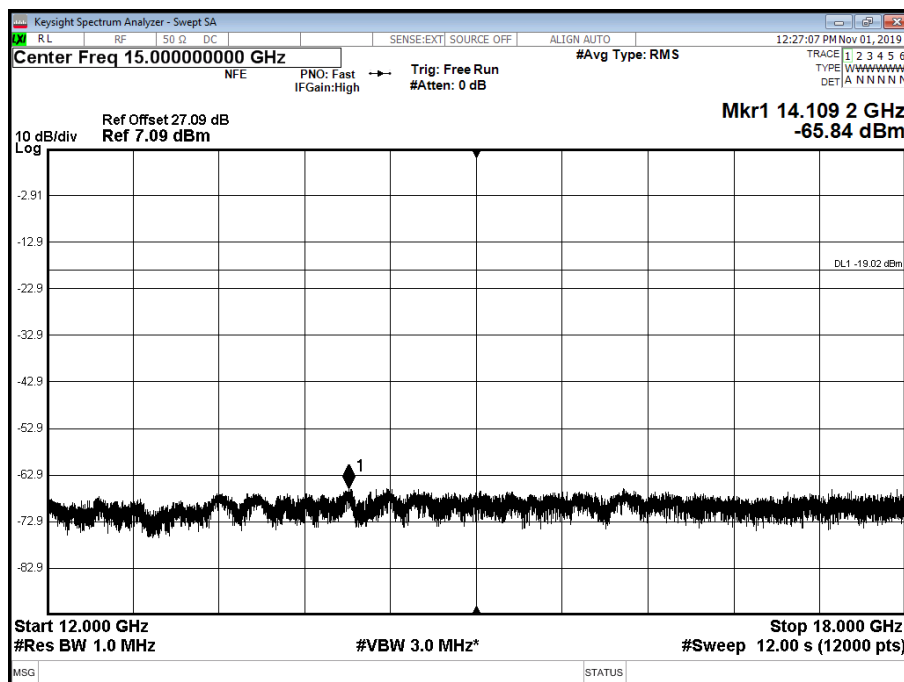



Antenna A - NR Modulation QPSK - NR Carrier Bandwidth 5.0 MHz 15 kHz SCS - Channel Position B - Band 4 - Range 18000 to 26000 MHz

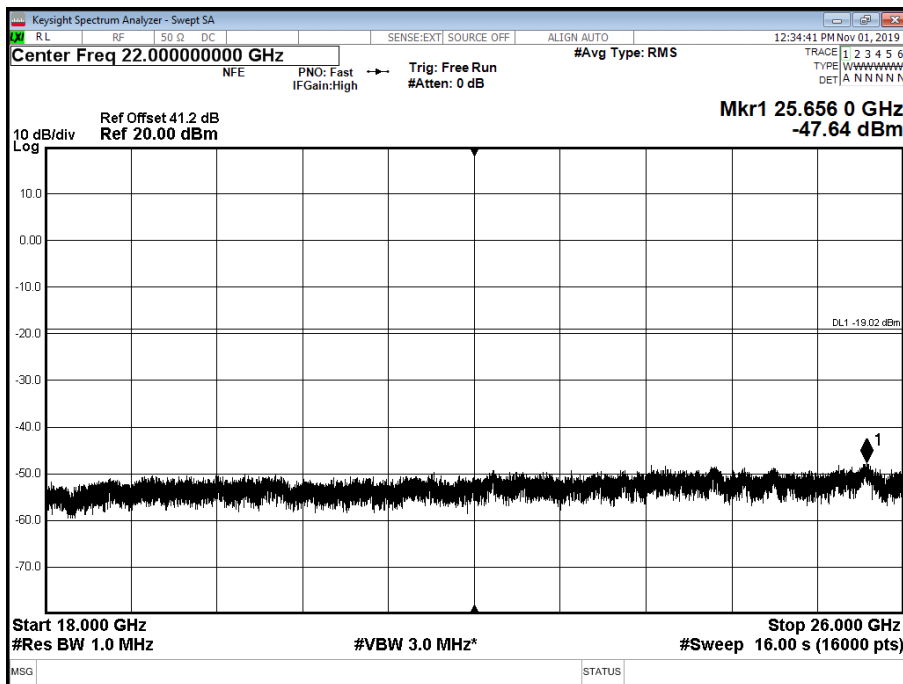

Antenna A - NR Modulation QPSK - NR Carrier Bandwidth 5.0 MHz 15 kHz SCS - Channel Position T - Band 4 - Range 18000 to 26000 MHz

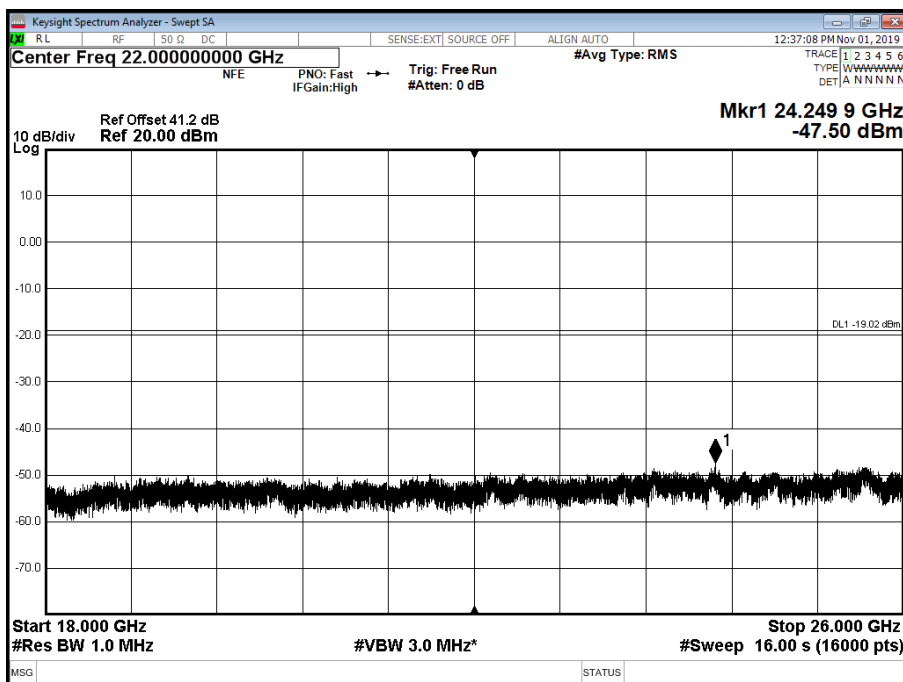

Limit	-19dBm
-------	--------



### **SECTION 3**

#### **TEST EQUIPMENT USED**



### 3.1 TEST EQUIPMENT USED

List of absolute measuring and other principal items of test equipment.

Instrument	Manufacturer	Type No.	TE No.	Calibration Period (months)	Calibration Due
<b>Maximum Peak Output Power and Peak to Average Ratio - Conducted</b>					
Spectrum Analyser	Keysight Technologies	N9030A	4653	12 months	06-Feb-2020
Frequency Standard	Spectracom	SecureSync 1200-0408-0601	4393	6 months	16-Apr-2020
Rubidium Standard	Rohde & Schwarz	XSRM	1316	6 months	16-Apr-2020
Hygromer	Rotronic	Hygropalm	2404	12 months	02-May-2020
Power Supply	Farnell	H60-25	1092	-	O/P Mon
Multimeter	Iso-tech	IDM101	2424	12 months	12-Dec-2019
Attenuator 40 dB 100 W	Weinschel	48-40-43-LIM	5134	-	O/P Mon
N-Type Cable	Rhophase	NPS-1803-1000-NPS	3701	-	O/P Mon
Network Analyser	Keysight Technologies	N5235B	5361	12 months	10-May-2020
ECAL Module	Keysight Technologies	N4693A	5362	12 months	22-Feb-2020
N-Type Cable	Rhophase	D5975	4233	-	O/P Mon
<b>Occupied Bandwidth</b>					
Spectrum Analyser	Keysight Technologies	N9030A	4653	12 months	06-Feb-2020
Frequency Standard	Spectracom	SecureSync 1200-0408-0601	4393	6 months	16-Apr-2020
Rubidium Standard	Rohde & Schwarz	XSRM	1316	6 months	16-Apr-2020
Hygromer	Rotronic	Hygropalm	2404	12 months	02-May-2020
Power Supply	Farnell	H60-25	1092	-	O/P Mon
Multimeter	Iso-tech	IDM101	2424	12 months	12-Dec-2019
Attenuator 40 dB 100 W	Weinschel	48-40-43-LIM	5134	-	O/P Mon
N-Type Cable	Rhophase	NPS-1803-1000-NPS	3701	-	O/P Mon
Network Analyser	Keysight Technologies	N5235B	5361	12 months	10-May-2020
ECAL Module	Keysight Technologies	N4693A	5362	12 months	22-Feb-2020
N-Type Cable	Rhophase	D5975	4233	-	O/P Mon
<b>Band Edge</b>					
Spectrum Analyser	Keysight Technologies	N9030A	4653	12 months	06-Feb-2020
Frequency Standard	Spectracom	SecureSync 1200-0408-0601	4393	6 months	16-Apr-2020
Rubidium Standard	Rohde & Schwarz	XSRM	1316	6 months	16-Apr-2020
Hygromer	Rotronic	Hygropalm	2404	12 months	02-May-2020
Power Supply	Farnell	H60-25	1092	-	O/P Mon
Multimeter	Iso-tech	IDM101	2424	12 months	12-Dec-2019
Attenuator 40 dB 100 W	Weinschel	48-40-43-LIM	5134	-	O/P Mon
N-Type Cable	Rhophase	NPS-1803-1000-NPS	3701	-	O/P Mon
Network Analyser	Keysight Technologies	N5235B	5361	12 months	10-May-2020
ECAL Module	Keysight Technologies	N4693A	5362	12 months	22-Feb-2020
N-Type Cable	Rhophase	D5975	4233	-	O/P Mon
<b>Transmitter Spurious Emissions</b>					



Instrument	Manufacturer	Type No.	TE No.	Calibration Period (months)	Calibration Due
Spectrum Analyser	Keysight Technologies	N9030A	4653	12 months	06-Feb-2020
Frequency Standard	Spectracom	SecureSync 1200-0408-0601	4393	6 months	16-Apr-2020
Rubidium Standard	Rohde & Schwarz	XSRM	1316	6 months	16-Apr-2020
Hygromer	Rotronic	Hygropalm	2404	12 months	02-May-2020
Power Supply	Farnell	H60-25	1092	-	O/P Mon
Multimeter	Iso-tech	IDM101	2424	12 months	12-Dec-2019
Attenuator 40 dB 100 W	Weinschel	48-40-43-LIM	5134	-	O/P Mon
N-Type Cable	Rhophase	NPS-1803-1000-NPS	3701	-	O/P Mon
N-Type Cable	Rhophase	D5975	4233	-	O/P Mon
Attenuator 20 dB 100 W	Weinschel	48-20-43-LIM	5133	12 months	07-Nov-2019
3 GHz High Pass Filter	Wainwright	WHKX12-2580-3000-18000-80SS	5220	-	O/P Mon
Cable Attenuator	Aralab	CSF6767C-C2S6500	5175	-	O/P Mon
K-Type Cable (40 GHz)	Rosenberger	LU1-001-500	5021	-	O/P Mon
N5235B	Keysight Technologies	N5235B	5361	12 months	10-May-2020
N4693A	Keysight Technologies	N4693A	5362	12 months	22-Feb-2020
18 - 25 GHz Wave Guide	F.M.I. UK	-	-	-	O/P Mon

N/A – Not Applicable

O/P Mon – Output Monitored with Calibrated Equipment



### 3.2 MEASUREMENT UNCERTAINTY

For a 95% confidence level, the measurement uncertainties for defined systems are:-

Test Discipline	Frequency / Parameter	MU	
Conducted Maximum Peak Output Power	30 MHz to 20 GHz Amplitude	± 0.7 dB	
Conducted Emissions	30 MHz to 20 GHz Amplitude	± 0.8 dB	
Occupied Bandwidth	Up to 20 MHz Bandwidth	5 MHz Bandwidth	± 11547 Hz
		10 MHz Bandwidth	± 23094 Hz
		15 MHz Bandwidth	± 34641 Hz
		20 MHz Bandwidth	± 46188 Hz
Band Edge	30 MHz to 20 GHz Amplitude	±0.8 dB	



## **SECTION 4**

### **ACCREDITATION, DISCLAIMERS AND COPYRIGHT**



#### 4.1 ACCREDITATION, DISCLAIMERS AND COPYRIGHT



This report relates only to the actual item/items tested.

Our UKAS Accreditation does not cover opinions and interpretations and any expressed are outside the scope of our UKAS Accreditation.

Results of tests not covered by our UKAS Accreditation Schedule are marked NUA (Not UKAS Accredited).

© 2019 TÜV SÜD





## **ANNEX A**

### **MODULE LIST**



Configuration A & B			
Product	Product No	R-State	Serial No
RRUS 32 B66A	KRC161583/1	R1F	E553071497
Software Version:	CXP9013268/12	Revision:	R77UV