



REPORT

issued by an FCC listed Laboratory Reg. no. 93866.
The test site complies with RSS-Gen, IC file no: 3482A-1

Contact person
Tomas Isbring
Electronics
+46 10 516 59 16
tomas.isbring@sp.se

Date 2015-10-27 Reference 5P06893-F27 L+W Page 1 (2)



Ericsson AB
Niklas Warnström
PDU HW
Torshamnsgatan 21
164 83 Stockholm

Radio measurements on RRUS32 B66A 1700/2100 MHz radio equipment with FCC ID: TA8AKRC161583-1 and IC: 287AB-AS1615831

(5 appendices)

Test object

Product name: RRUS 32 B66A.
Product number: KRC 161 583/1.

Summary

Standard	Compliant	Appendix
FCC CFR 47 part 2 and 27 / IC RSS-139 Issue 3		
2.1046 / RSS-139 6.5 RF power output	Yes	2
2.1051 / RSS-139 6.6 Spurious emission at antenna terminals	Yes	3
2.1053 / RSS-139 6.6 Field strength of spurious radiation	Yes	4

SP Technical Research Institute of Sweden

Electronics - EMC

Performed by

Examined by

Jörgen Wassholm

Anders Nordlöf

SP Technical Research Institute of Sweden

Postal address

SP
Box 857
SE-501 15 BORÅS
Sweden

Office location

Västeråsen
Brinellgatan 4
SE-504 62 BORÅS

Phone / Fax / E-mail

+46 10 516 50 00
+46 33 13 55 02
info@sp.se

Laboratories are accredited by the Swedish Board for Accreditation and Conformity Assessment (SWEDAC) under the terms of Swedish legislation. This report may not be reproduced other than in full, except with the prior written approval of the issuing laboratory.

Table of contents

Description of the test object	Appendix 1
Operation mode during measurements	Appendix 1
Test setups	Appendix 1
Purpose of test	Appendix 1
RF power output	Appendix 2
Spurious emission at antenna terminals	Appendix 3
Field strength of spurious radiation	Appendix 4
External photos	Appendix 5

Appendix 1

Description of the test object

Equipment:	Product name: RRUS 32 B66A Product number: KRC 161 583/1
FCC ID:	TA8AKRC161583-1
IC ID:	287AB-AS1615831
HVIN:	AS1615831
Hardware revision state:	R1A
FVIN:	CXP 901 7316/5 rev. R62AM
Tested configuration:	Multi standard radio (MSR) WCDMA+LTE
Frequency bands:	TX: 2110 – 2180 MHz RX: 1710 – 1780 MHz Note: WCDMA carriers limited to : 2110-2155/ 1710-1755 MHz. LTE no limitation.
IBW WCDMA:	45 MHz, Valid for all power classes in both contiguous and non-contiguous operation.
IBW LTE:	70 MHz, Valid for all power classes in both contiguous and non-contiguous operation.
Antenna ports:	4 TX/RX ports, (internally connected to integrated Cross-Polarized antenna elements)
RF configuration:	WCDMA+LTE MIMO: LTE: 1-4 carriers (5, 10 MHz BW), 1-3 carriers (15-20 MHz) WCDMA: 1-2 carriers Total numbers of carriers: 4
RF power tolerance	+ 0.6 / - 2.0 dB
Nominal output power per antenna port:	2 x 43 dBm (40W) 3 x 41.25 dBm (40W) 4 x 40 dBm (40W)
Frequency stability tolerance:	±0.05 PPM
Antenna type:	No dedicated antenna, handled during licensing

Appendix 1

Channel bandwidths LTE:	5 MHz, 10 MHz, 15 MHz and 20 MHz
Channel bandwidths WCDMA:	4.2 to 5 MHz (configurable in steps of 100/200 kHz)
Channel spacing WCDMA:	4.4 to 5 MHz (configurable in steps of 100/200 kHz)
Emission Designators WCDMA:	5M00F9W
Emission Designators LTE:	5M00F9W, 10M0F9W, 15M0F9W, 20M0F9W
Nominal supply voltage:	-48VDC

Appendix 1

Operation mode during measurements

MSR, WCDMA + LTE

WCDMA measurements were performed with the test object transmitting test models as defined in 3GPP TS 37.141. Test model 1 (TM1) was used to represent QPSK. Test model 5 (TM5) to represent 16QAM modulation and Test model 6 (TM6) to represent 64QAM modulation.

LTE measurements were performed with the test object transmitting test models as defined in 3GPP TS 37.141. Test model E-TM1.1 was used to represent QPSK, test model E-TM3.2 to represent 16QAM and test model E-TM3.1 to represent 64QAM modulation.

The settings below were deemed representative for all traffic scenarios when settings with different modulations, channel bandwidths, number of carriers and RF configurations has been tested to find the worst case setting. The settings below were used for all measurements if not otherwise noted.

MIMO mode one WCDMA carrier
TM1: 64 DPCH:s at 30 ksps (SF=128)

MIMO mode, two WCDMA carriers
TM1: 32 DPCH:s at 30 ksps (SF=128)

Channel bandwidth 5 MHz

LTE MIMO mode
E-TM1.1
Channel bandwidth 5 MHz.

Measurements were performed with the test object configured for the maximum transmit power applicable for the tested configuration.

Conducted measurements

The test object was supplied with -48 VDC by an external power supply if not noted otherwise. Additional connections are documented in the setup drawings below. Complete measurements were made on the RF port representing worst case for each measurement.

Radiated measurements

The test object was supplied with -48 VDC by an external power supply. Additional connections are documented in the test setup drawings.

Appendix 1

Purpose of test

The purpose of the tests is to verify compliance to the performance characteristics specified in applicable items of FCC CFR 47 and Industry Canada RSS-139 and RSS-Gen.

References

Measurements were done according to relevant parts of the following standards:

ANSI 63.4-2009
ANSI/TIA/EIA-603-C-2004
3GPP TS 37.141, version 11.9.0
CFR 47 part 2, October 1st, 2014
CFR 47 part 27, October 1st, 2014
RSS-Gen Issue 4
RSS-139 Issue 3
KDB 662911 Multiple transmitter output v02r01
KDB 971168 D01 Power Meas Licens, v02r02

Uncertainties

Measurement and test instrument uncertainties are described in the quality assurance documentation "SP-QD 10885". The uncertainties are calculated with a coverage factor $k=2$ (95% level of confidence).

Compliance evaluation is based on a shared risk principle with respect to the measurement uncertainty.

Reservation

The test results in this report apply only to the particular test object as declared in the report.

Delivery of test object

The test object was delivered 2015-10-07.

Manufacturer's representative

Lars Wallin, Ericsson AB.

Test engineers

Tomas Lennhager, Patric Augustsson, Tomas Isbring, Senad Pasalic and Jörgen Wassholm, SP.

Test participant

None.

Appendix 1

Measurement equipment

	Calibration Due	SP number
Test site Tesla	2017-01	503 881
R&S ESU 40	2016-07	901 385
R&S FSW 43	2016-07	902 073
R&S ESI 26	2016-07	503 292
R&S FSQ 40	2016-07	504 143
Control computer with R&S software EMC32 version 9.15.0	-	503 899
High pass filter	2016-07	504 200
RF attenuator	2016-10	902 282
Directional coupler	2016-10	901 496
Chase Bilog Antenna CBL 6111A	2017-10	503 182
EMCO Horn Antenna 3115	2016-09	502 175
µComp Nordic, Low Noise Amplifier	2016-01	901 545
Flann STD Gain Horn Antenna 20240-20	-	503 674
Flann STD Gain Horn Antenna 22240-20		503 674
Miteq, Low Noise Amplifier	2016-08	503 278
Schwarzbeck preamplifier BBV 9742	2015-12	504 085
Temperature and humidity meter, Testo 635	2016-04	504 203
Temperature Chamber	-	503 360
Multimeter Fluke 87	2016-08	502 190

Appendix 1

Test configurations during conducted measurements

2W1L5M:

	WCDMA	LTE
	(2x10W)	(1x20W)
Downlink	1537 (2112.4 MHz)	67111 (2177.5 MHz)
Downlink	1562 (2117.4 MHz)	-
Test model	TM1	E-TM1.1
Bandwidth	5 MHz	5 MHz

2W2L5M:

	WCDMA	LTE
	(2x10W)	(2x10W)
Downlink	1537 (2112.4 MHz)	67061 (2172.5 MHz)
Downlink	1562 (2117.4 MHz)	67111 (2177.5 MHz)
Test model	TM1	E-TM1.1
Bandwidth	5 MHz	5 MHz

Appendix 1

1W1L5M:

	WCDMA	LTE
	(1x20W)	(1x20W)
Downlink	1636 (2132.6 MHz)	66786 (2145.0 MHz)
Test model	TM1	E-TM1.1
Bandwidth	5 MHz	5 MHz

All RX frequencies were configured 400 MHz below the corresponding TX frequency according the applicable duplex offset for the operating band.

Test configurations during radiated measurements

2W1L5M-Rspr:

	WCDMA	LTE
	(2x10W)	(1x20W)
Downlink	1537 (2112.4 MHz)	67111 (2177.5 MHz)
Downlink	1562 (2117.4 MHz)	-
Downlink	1587 (2122.4 MHz)	-
Downlink	1612 (2127.4 MHz)	-
Test model	TM1	E-TM1.1
Bandwidth	5 MHz	5 MHz

Appendix 1

2W2L5M-Rspr:

	WCDMA	LTE
	(2x10W)	(2x10W)
Downlink	1537 (2112.4 MHz)	67061 (2172.5 MHz)
Downlink	1562 (2117.4 MHz)	67111 (2177.5 MHz)
Downlink	1587 (2122.4 MHz)	-
Downlink	1612 (2127.4 MHz)	-
Test model	TM1	E-TM1.1
Bandwidth	5 MHz	5 MHz

1W1L5M-Rspr:

	WCDMA	LTE
	(1x20W)	(1x20W)
Downlink	1636 (2132.6 MHz)	67061 (2172.5 MHz)
Downlink	1661 (2137.6 MHz)	-
Test model	TM1	E-TM1.1
Bandwidth	5 MHz	5 MHz

All RX frequencies were configured 400 MHz below the corresponding TX frequency according the applicable duplex offset for the operating band.

Appendix 1

Test set-up conducted measurements

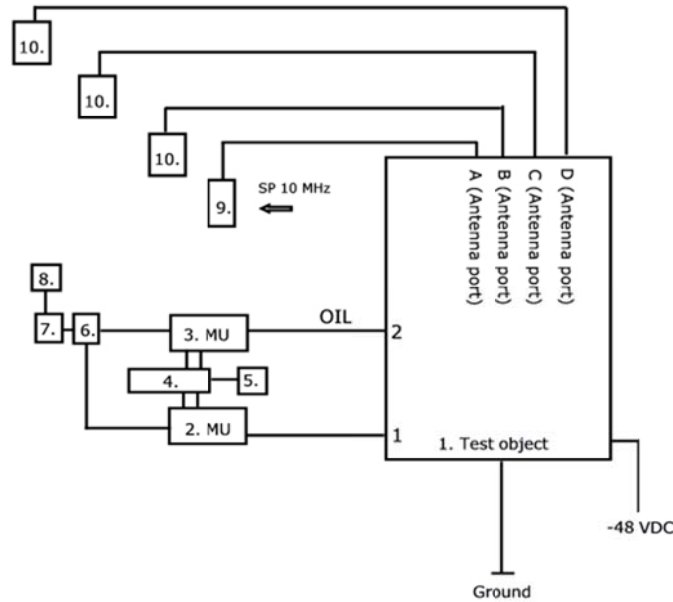

Test object:

1.	RRUS32 B66A, KRC 161 583/1, rev. R1A, S/N: D16Q869113 With Radio Software: CXP 901 7316/5, Rev. R62AM FCC ID TA8AKRC161583-1 and IC 287AB-AS1615831
----	---

Associated equipment:

2.	RBS 6601 Main Unit: SUP 6601, 1/BFL 901 009/4, rev. R1E, s/n: BR82691785 DUW 30 01, KDU 127 161/3, rev. R4C, s/n: C825194264 SW: CXP 102 051/24, rev. R13BT
3.	RBS 6601 Main Unit: SUP 6601, 1/BFL 901 009/4, rev. R2A, s/n: BR83064952 DUS 41 01, KDU 137 624/1, rev. R5A/A, s/n: D16F285423 SW: CXP 102 051/23, Rev. R17ACS
6.	GPS 02 01, NCD 901 41/1, rev. R1D, s/n: TU8K474887
8.	GPS Active Antenna, KRE 101 2082/1

Functional test equipment

4.	ERN-C-SIM 130, BAMS – 1000660991 Netgear Switch FS726T
5.	Laptop HP Elitebook 8540w, BAMS – 1001052061
7.	1x4 GPS SPLITTER, KRY 101 1946/1, s/n: FG1017916
9.	SP Test Instrumentation according to measurement equipment list. The signal analyzer was connected to an external 10 MHz reference standard during the measurements
10.	Attenuator/ terminator 50 ohm

Appendix 1

Test set-up radiated measurements

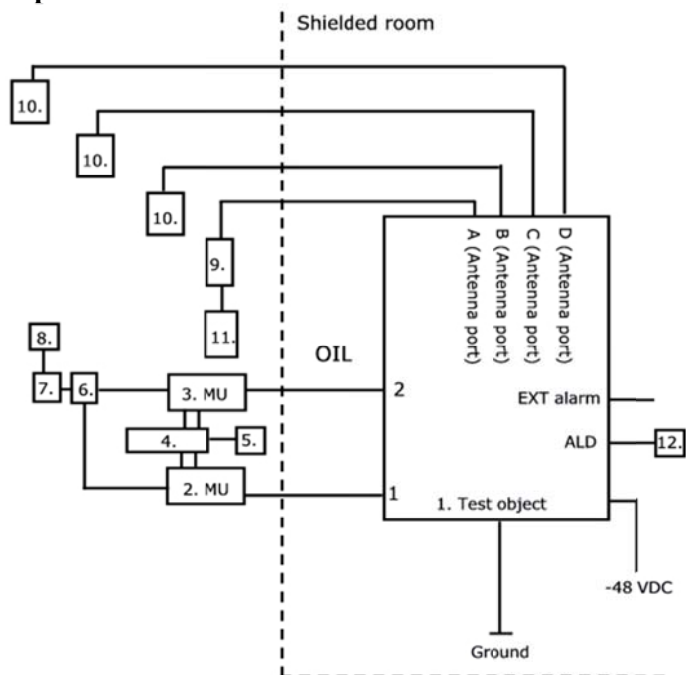

Test object:

1.	RRUS32 B66A, KRC 161 583/1, rev. R1A, S/N: D16Q917977 With Radio Software: CXP 901 7316/5, Rev. R62AM FCC ID TA8AKRC161583-1 and IC 287AB-AS1615831
----	---

Associated equipment:

2.	RBS 6601 Main Unit: SUP 6601, 1/BFL 901 009/4, rev. R1E, s/n: BR82691785 DUW 30 01, KDU 127 161/3, rev. R4C, s/n: C825194264 SW: CXP 102 051/24, rev. R13BT
3.	RBS 6601 Main Unit: SUP 6601, 1/BFL 901 009/4, rev. R2A, s/n: BR83066291 DUS 41 01, KDU 137 624/1, rev. R5A/A, s/n: A401981873 SW: CXP 102 051/23, Rev. R17ACS
6.	GPS 02 01, NCD 901 41/1, rev. R1D, s/n: TU8KH75515
8.	GPS Active Antenna, KRE 101 2082/1
12.	Remote Control Unit, s/n: CS61547222

Functional test equipment

4.	ERNC-SIM 130, BAMS – 1000660991 Netgear Switch FS726T
5.	Laptop HP EliteBook 8560w, BAMS – 1001236856
7.	1x4 GPS SPLITTER, KRY 101 1946/1
9.	Attenuator
10.	Attenuator/ terminator 50 ohm
11.	R&S ESI 26 SP 503 292, for supervision only

Appendix 1

Interfaces:	Type of port:
Power: -48 VDC	DC Power
RF port A, 7/16 connector, combined TX/RX	Antenna
RF port B, 7/16 connector, combined TX/RX	Antenna
RF port C, 7/16 connector, combined TX/RX	Antenna
RF port D, 7/16 connector, combined TX/RX	Antenna
1, optical interface	Signal
2, optical interface	Signal
Remote Control Unit	Signal
EXT. alarm	Signal
Ground wire	Ground

Appendix 2

RF power output measurements according to CFR 47 §27.50 / IC RSS-139 6.5

Date	Temperature	Humidity
2015-10-19	23 °C ± 3 °C	25 % ± 5 %

Test set-up and procedure

The test object was connected to a signal analyzer measuring peak and RMS output power in CDF mode. A resolution bandwidth of 80 MHz was used.

Measurement equipment	SP number
R&S FSW 43	902 073
RF attenuator	902 282
Directional coupler	901 496
Testo 635, temperature and humidity meter	504 203

Measurement uncertainty: 1.1 dB

Results

MSR, WCDMA + LTE:

Rated output power level at RF connector 2x 43 dBm.

BW and symbolic name	Output power CCDF [RMS dBm/ PAR dB]				
	Port RF A	Port RF B	Port RF C	Port RF D	Total power ¹⁾
2W1L5M	44.8/ 8.1	44.9/ 8.0	44.8/ 8.0	44.9/ 8.0	50.87
2W2L5M	44.9/ 7.9	44.8/ 7.8	44.8/ 7.9	44.8/ 7.8	50.84

¹⁾: Summed output power according to FCC KDB662911 D01 Multiple transmitter output v02.

Note: The PAR value is the 0.1 % Peak to Average Ratio



Appendix 2

Limits

§27.50 (d)

The power of each base station transmitting in the 2110-2180 MHz band and located in any county with population density of 100 or fewer persons per square mile is limited to an EIRP of 3280 W/MHz, when transmitting with an emission bandwidth greater than 1 MHz.

The power of each base station transmitting in the 2110-2180 MHz band and situated in any geographic location other than that described above is limited to an EIRP of 1640 W/MHz, when transmitting with an emission bandwidth greater than 1 MHz.

A licensee operating a base station in the 2110-2180 MHz band utilizing a power greater than 1640 watts/MHz EIRP must coordinate such operations in advance with all parties addressed in the rules.

In measuring transmissions in this band using an average power technique, the peak-to-average ratio (PAR) of the transmission may not exceed 13 dB.

RSS-139 6.5:

There is no power limit specified for base station equipment in the RSS-139.

EIRP compliance is addressed at the time of licensing, as required by the responsible IC Bureau. Licensee's are required to take into account the antenna gain to get the maximum usable power settings to prevent the radiated output power to exceed the ERP/EIRP limits specified in SRSP-513

When the transmitter power is measured in terms of average value, the peak-to-average ratio of the power shall not exceed 13 dB.

Complies?	Yes
-----------	-----

Appendix 3

Conducted spurious emission measurements according to CFR 47 §27.53(h)/ IC RSS-139 6.6

Date 2013-04-30	Temperature 23 °C ± 3 °C	Humidity 25 % ± 5 %
--------------------	-----------------------------	------------------------

Test set-up and procedure

The measurements were made per definition in §27.53(h) and IC RSS-139.6.6. The output was connected to a spectrum analyzer with a RBW setting of 1 MHz and RMS detector activated. The spectrum analyzer was connected to an external 10 MHz reference standard during the measurements.

Before comparing the results to the limit, 6 dB [10 log (4)] should be added according to method 2 “measure and add 10 log(N_{ANT})” of FCC KDB662911 D01 Multiple Transmitter Output v02r01.

Measurement equipment	SP number
R&S FSW 43	902 073
RF attenuator	902 282
Directional coupler	901 496
HP filter	901 502
Testo 635, temperature and humidity meter	504 203

Measurement uncertainty: 3.7 dB

Results

MSR, WCDMA + LTE:

Diagram	Symbolic name	Tested Port
1 a+b+c+d+e	2W1L5M	RF B
2 a+b+c+d+e	2W2L5M	RF B

Remark

The emission at 9 kHz on the plots was not generated by the test object. A complementary measurement with a smaller RBW showed that it was related to the LO feed-through.

The highest fundamental frequency is 2.180 GHz. The measurements were made up to 22 GHz (10x2.180 GHz = 21.80 GHz).

Limits

§27.53(h) and RSS-139 6.6

Outside a licensee’s frequency band(s) of operation the power of any emission shall be attenuated below the transmitter power (P) by at least 43 + 10 log (P) dB, resulting in a limit of -13 dBm per 1 MHz RBW.

Complies?	Yes
-----------	-----

Appendix 3

Diagram 1a:

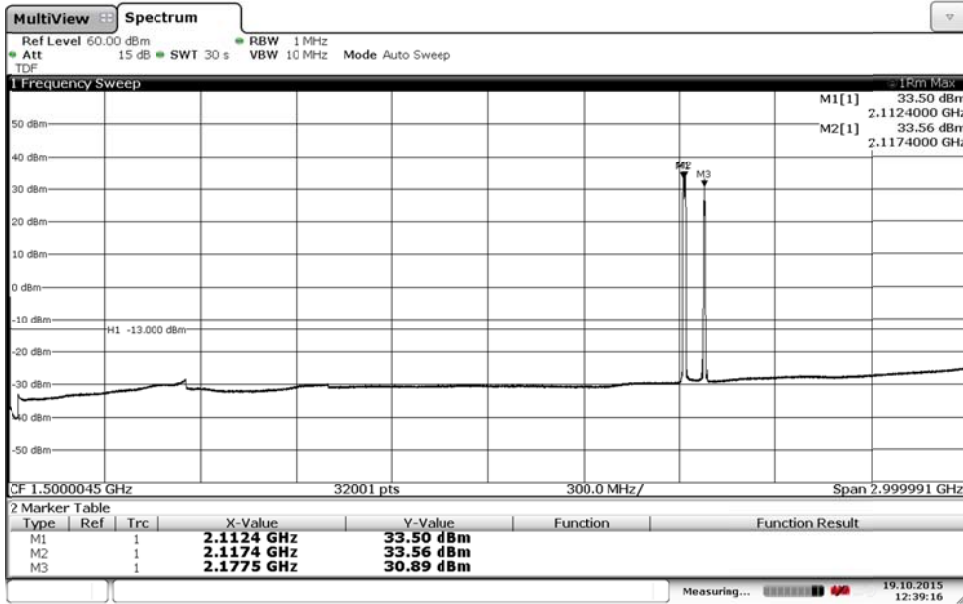

Date: 19.OCT.2015 12:39:16

Diagram 1b:

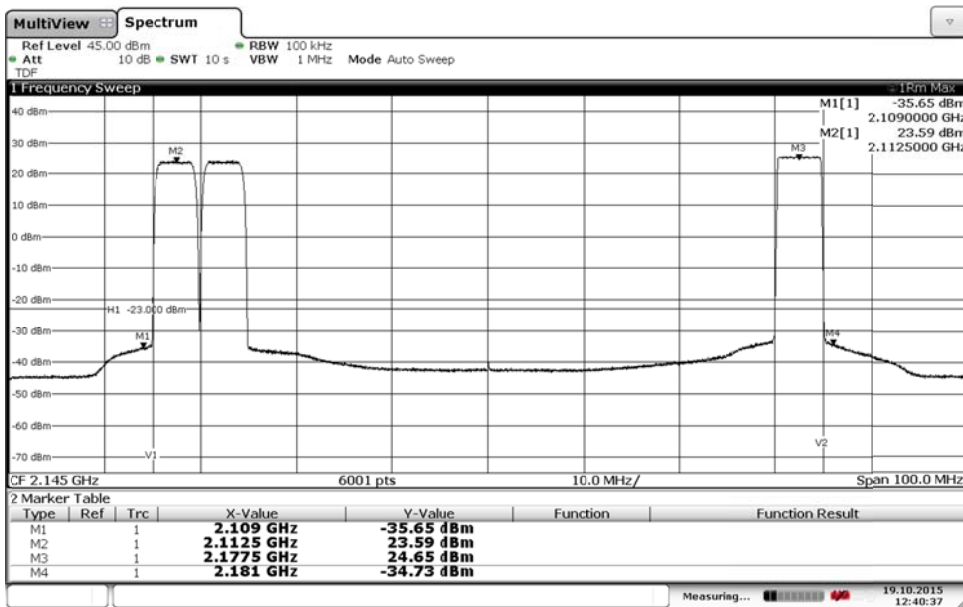

Date: 19.OCT.2015 12:40:37

Appendix 3

Diagram 1c:

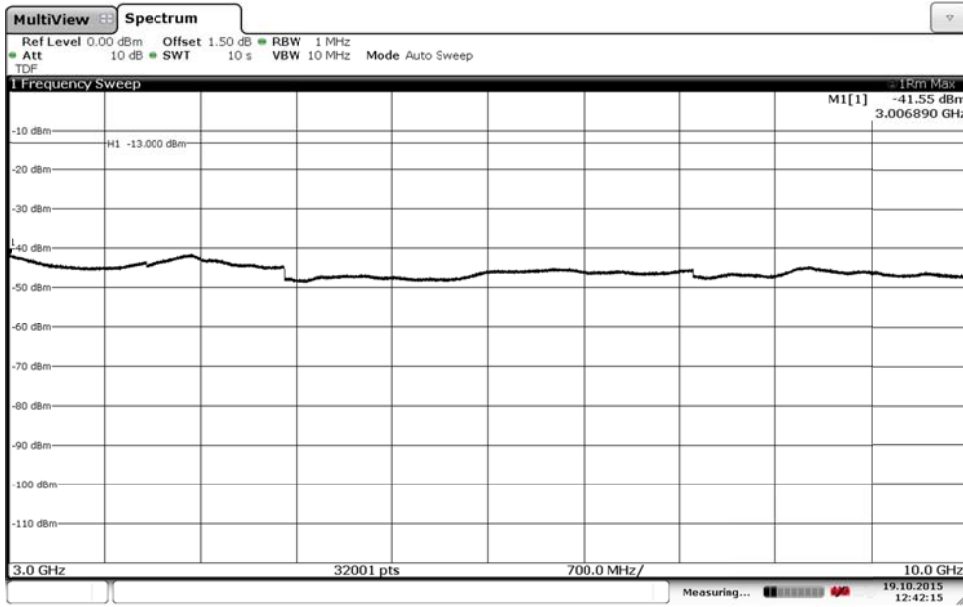
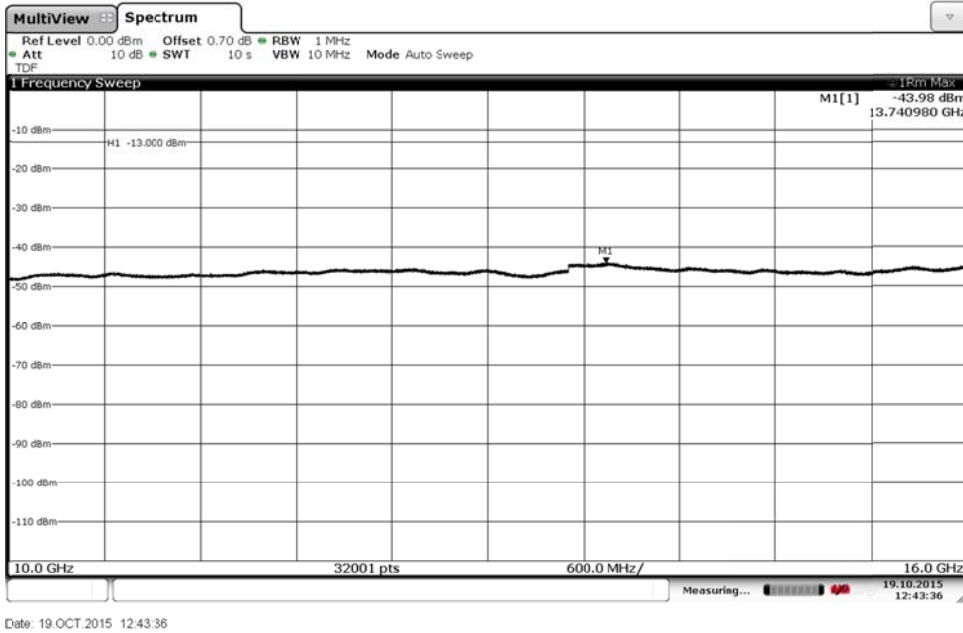
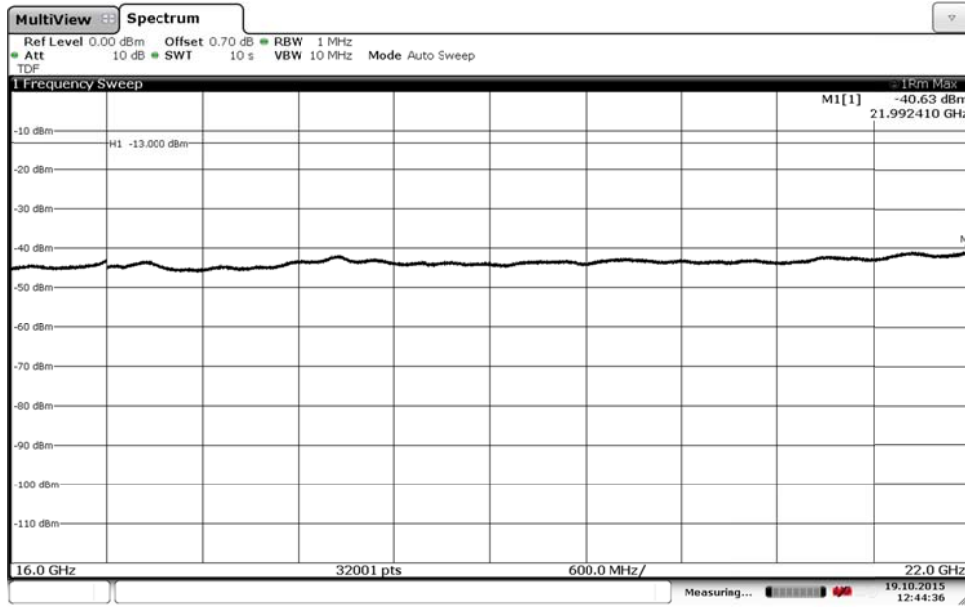

Diagram 1d:



Appendix 3

Diagram 1e:



Appendix 3

Diagram 2a:

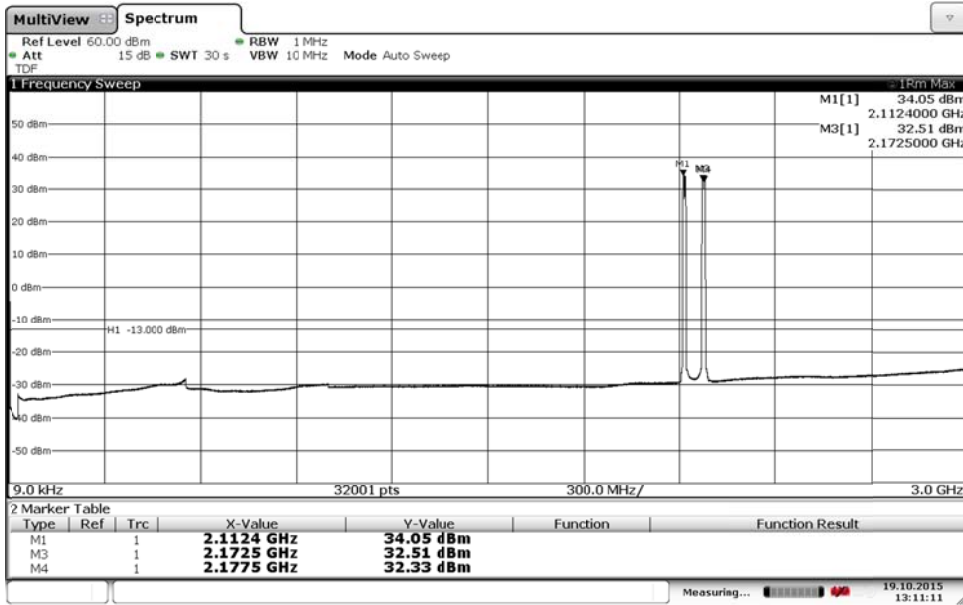

Date: 19.OCT.2015 13:11:11

Diagram 2b:

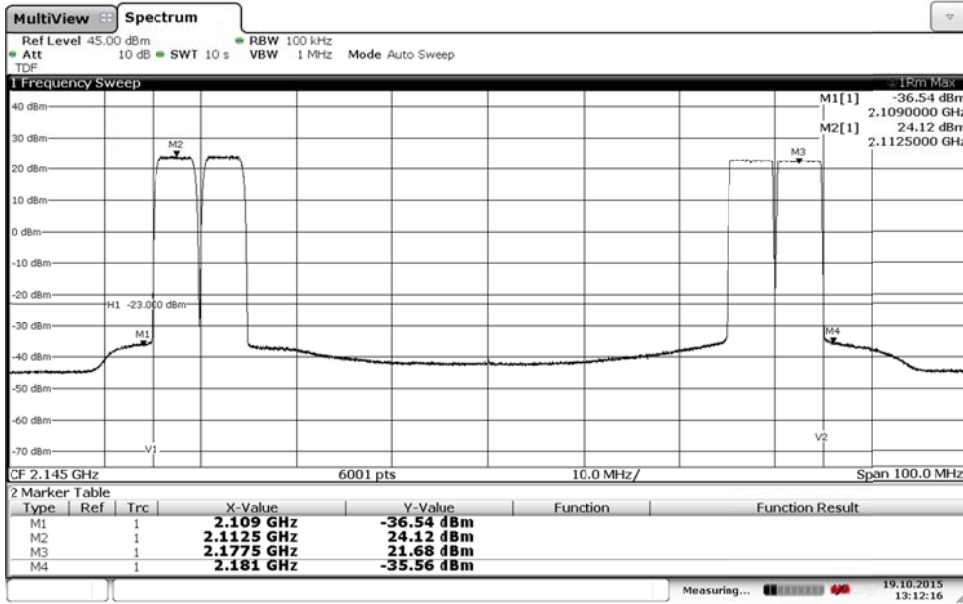

Date: 19.OCT.2015 13:12:16

Appendix 3

Diagram 2c:

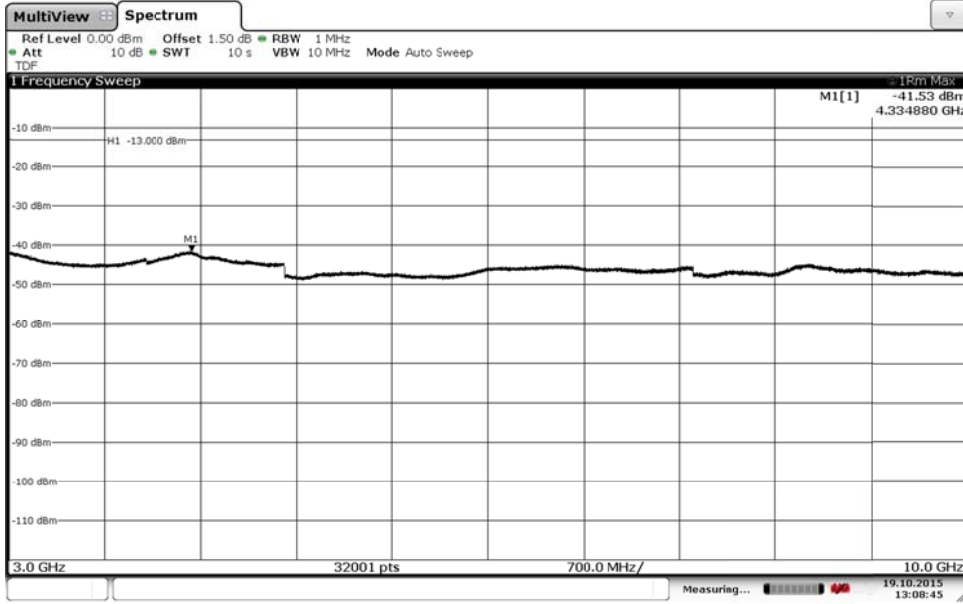
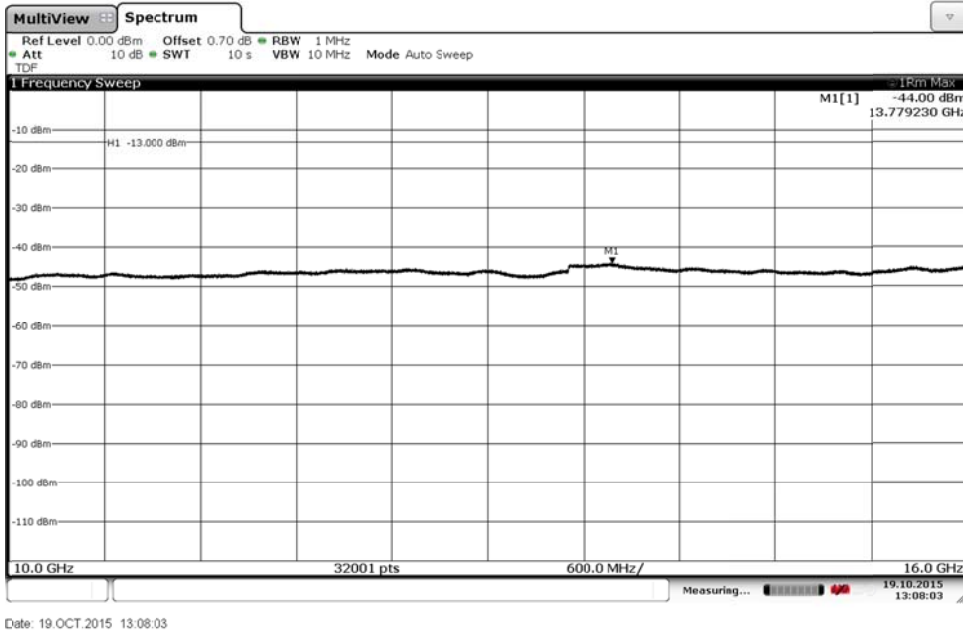
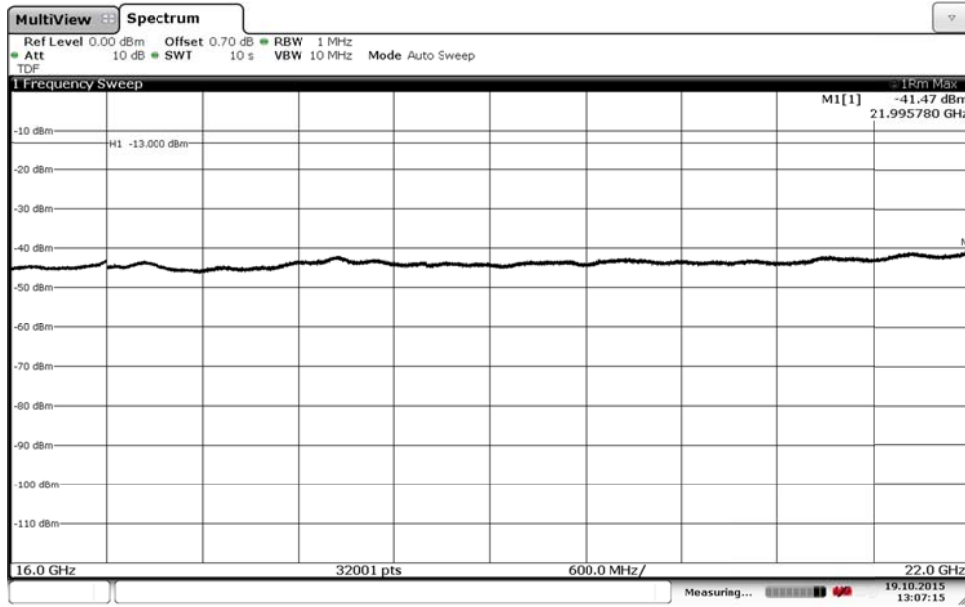

Diagram 2d:



Appendix 3

Diagram 2e:



Appendix 4

Field strength of spurious radiation measurements according to 47 CFR 27.53 (h) / IC RSS-139 6.6

Date	Temperature	Humidity
2015-10-10	23°C ± 3°C	35 % ± 5 %
2015-10-12	23°C ± 3°C	32 % ± 5 %

Test set-up and procedure

The test sites are listed at FCC, Columbia with registration number: 93866. The test site complies with RSS-Gen, Industry Canada file no. 3482A-1.

The measurements were performed with both horizontal and vertical polarization of the antenna. The antenna distance was 3 m in the frequency range 30 MHz – 18 GHz and 1m in the frequency range 18 - 22 GHz.

In the frequency range 30 MHz – 22 GHz the measurement was performed in power with a RBW of 1 MHz. A propagation loss in free space was calculated. The used formula was

$$\gamma = 20 \log \left(\frac{4\pi D}{\lambda} \right), \gamma \text{ is the propagation loss and } D \text{ is the antenna distance.}$$

The measurement procedure was as the following:

1. The pre-measurement was first performed with peak detector. The EUT was measured in eight directions and with the antenna at three heights, 1.0 m, 1.5 m and 2.0 m.
2. Spurious radiation on frequencies closer than 20 dB to the limit in the pre-measurement is scanned 0-360 degrees and the antenna is scanned 1- 4 m for maximum response. The emission is then measured with the RMS detector and the RMS value is reported. Frequencies closer than 10 dB to the limit when measured with the RMS detector were measured with the substitution method according to the standard.

Appendix 4

The test set-up during the spurious radiation measurements is shown in the picture below:



Measurement equipment

Measurement equipment	SP number
Semi anechoic chamber	503 881
R&S ESU40	901 385
EMC 32 ver. 9.15.0	503 745
Chase Bilog Antenna CBL 6111A	503 182
EMCO Horn Antenna 3115	902 212
Flann STD Gain Horn Antenna 20240-20	503 674
Flann STD Gain Horn Antenna 22240-20	503 674
High pass filter	504 200
Miteq, Low Noise Amplifier	503 278
Schwarzbeck BBV9742, Low Noise Amplifier	504 085
µComp Nordic, Low Noise Amplifier	901 545
Testo 635 temperature and humidity meter	504 203

Appendix 4

Tested configurations:

2W1L5M-Rspr
2W2L5M-Rspr
1W1L5M-Rspr

Results, representing worst case

2W1L5M-Rspr: Diagram 1 a-d

Frequency (MHz)	Spurious emission level (dBm)	
	Vertical	Horizontal
30-22 000	All emission > 20 dB below limit	All emission > 20 dB below limit

Measurement uncertainty:

3.2 dB up to 18 GHz, 3.6 dB above 18 GHz

Limits

§27.53(h) and RSS-139 6.6

Outside a licensee's frequency band(s) of operation the power of any emission shall be attenuated below the transmitter power (P) by at least $43 + 10 \log (P)$ dB, resulting in a limit of -13 dBm per 1 MHz RBW.

Complies?	Yes
-----------	-----

Appendix 4

Diagram 1a:

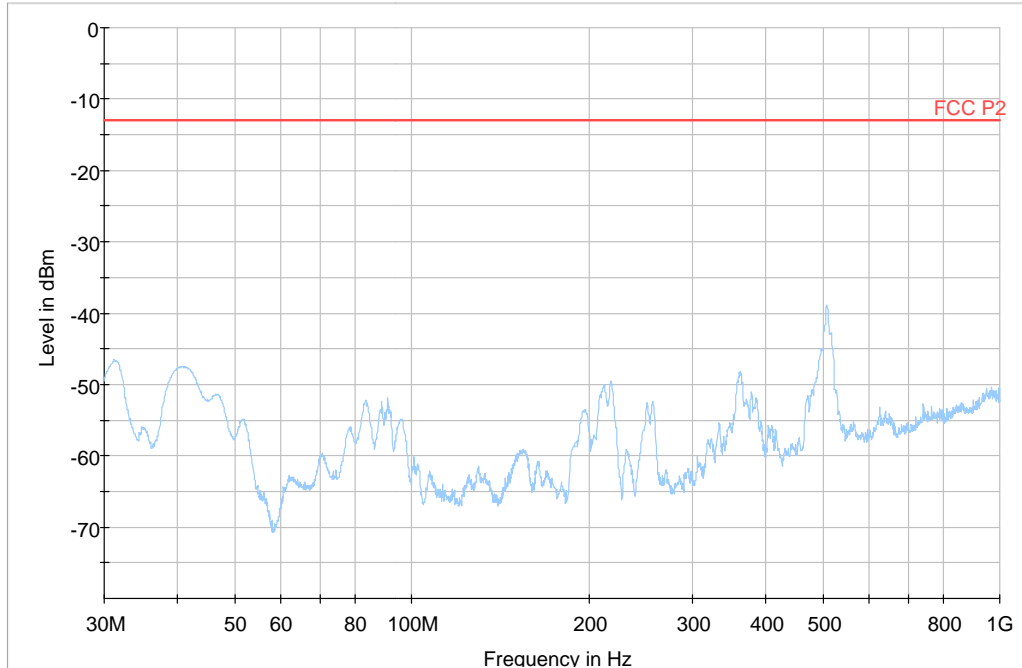
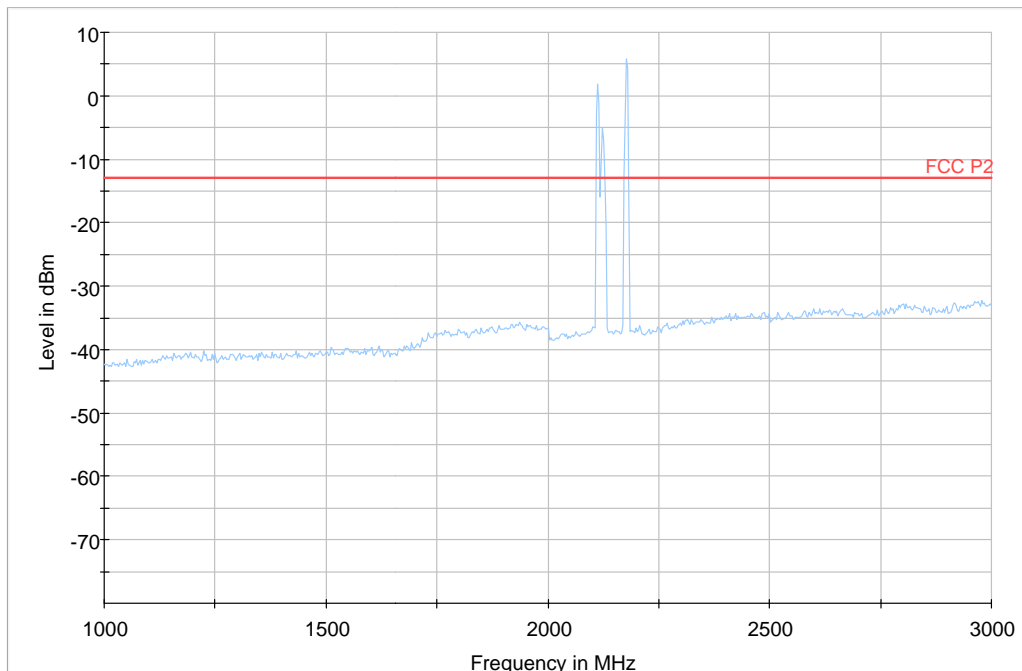

Diagram 1b:



Note: The emission between 2110 and 2180 MHz are the carrier frequencies and shall be ignored in the context.

Appendix 4

Diagram 1c:

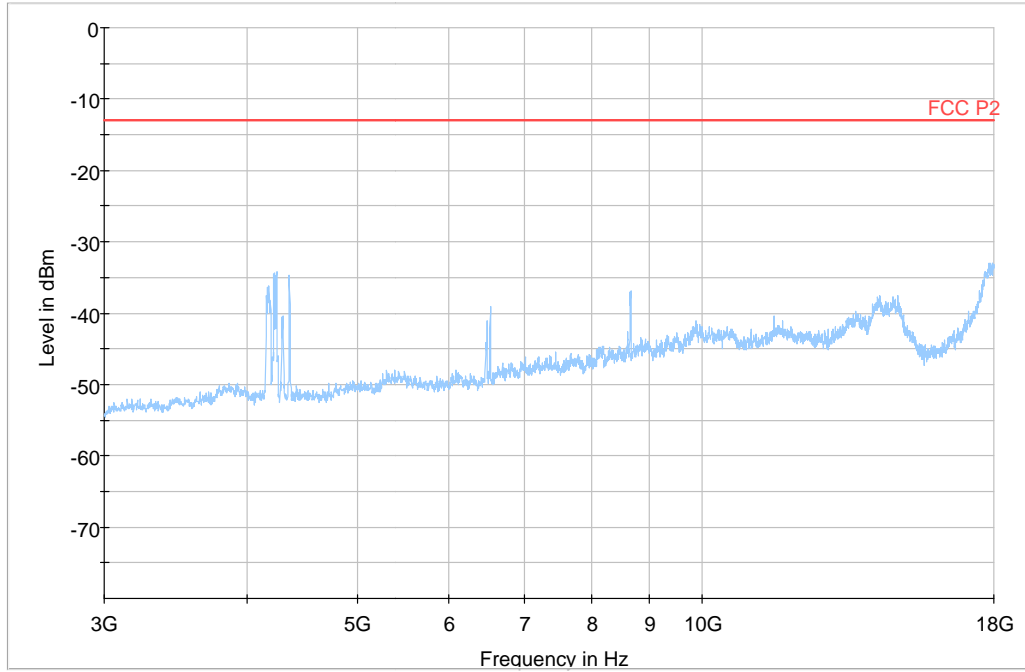
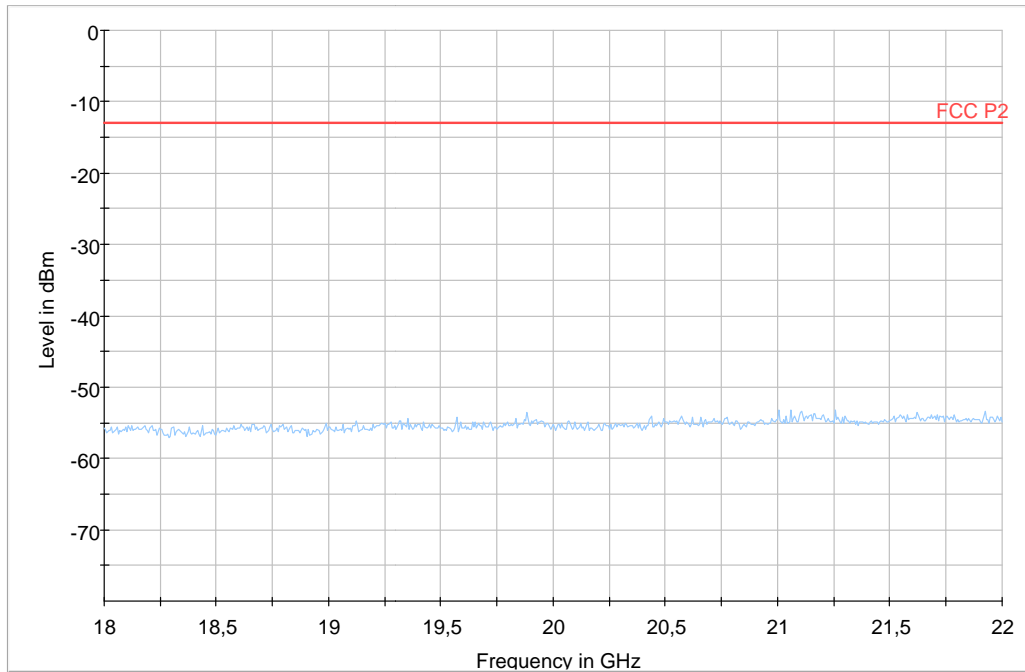

Diagram 1d:



Appendix 5

External photos

Front side



Appendix 5

Rear side



Appendix 5

Left side



Right side



Appendix 5

Bottom side



Appendix 5

Top side



Product label



FCC and IC label

