



Add value.
Inspire trust.



Report On

FCC and ISED Testing of the
Ericsson KRC 161 566/2 Radio 2217 B5 (850 MHz) NR Base Station in
accordance with FCC CFR 47 Part 2, FCC CFR 47 Part 22, ISED RSS-
GEN and Industry Canada RSS-132

COMMERCIAL-IN-CONFIDENCE

FCC ID: TA8AKRC161566

IC: 287AB-AS161566

PREPARED BY

APPROVED BY

DATED

Daria Fiedorowicz
Senior Administrator
(Technical)

Steve Scarfe
Authorised Signatory

02 April 2020

Document 75948011 Report 05 Issue 2

April 2020



TÜV SÜD, Octagon House, Concorde Way, Segensworth North,
Fareham, Hampshire, United Kingdom, PO15 5RL
Tel: +44 (0) 1489 558100. Website: www.tuv-sud.co.uk

COMMERCIAL-IN-CONFIDENCE

CONTENTS

Section	Page No
1	REPORT INFORMATION 1
1.1	Report Details 2
1.2	Brief Summary of Results 3
1.3	Configuration Description 4
1.4	Declaration of Build Status 5
1.5	Product Information 6
1.6	Test Setup 7
1.7	Test Conditions 8
1.8	Deviation From The Standard 8
1.9	Modification Record 8
2	TEST DETAILS 9
2.1	Maximum Peak Output Power and Peak to Average Ratio - Conducted 10
2.2	Occupied Bandwidth 21
2.3	Band Edge 28
2.4	Transmitter Spurious Emissions 35
3	TEST EQUIPMENT USED 38
3.1	Test Equipment Used 39
3.2	Measurement Uncertainty 40
4	ACCREDITATION, DISCLAIMERS AND COPYRIGHT 41
4.1	Accreditation, Disclaimers and Copyright 42
ANNEX A	Module Lists A.2



SECTION 1

REPORT INFORMATION



1.1 REPORT DETAILS

Manufacturer	Ericsson
Address	Torshamnsgatan 23 Kista SE-16480 Stockholm Sweden
Product Name & Product Number	Radio 2217 B5 & KRC 161 566/2
IC Model Name	AS1615661, AS1615662
Serial Number(s)	CD3X367474
Software Version	CXP 901 3268/9 Rev. R77ZT
Hardware Version	R1E
Non-Tested Variant	KRC 161 566/1
Test Specification/Issue/Date	FCC CFR 47 Part 2: 2018 FCC CFR 47 Part 22: 2018 ISED RSS-GEN Issue 5: (04-2018) + A1 (03-2019) Industry Canada RSS-132: Issue 3 (12-2013)
Test Plan	20Q1 FCC_IC test plan for NR legacy_PB1 (1)
Start of Test	30 January 2020
Finish of Test	30 January 2020
Name of Engineer(s)	Brian Scarfe
Related Document(s)	KDB 971168 D01 v02r02 KDB 662911 D01 v02r01

This Report has been up issued to Issue 2 and should be read in place of Issue1, to correct Frequency Error

ENGINEERING STATEMENT

The measurements shown in this report were made in accordance with the procedures described on test pages. All reported testing was carried out on a sample equipment to demonstrate compliance with FCC CFR 47 Part 22. The sample tested was found to comply with the requirements defined in the applied rules.

Test Engineer(s);

Brian Scarfe



1.2 BRIEF SUMMARY OF RESULTS

A brief summary of results for each configuration, in accordance with FCC CFR 47 Part 2, FCC CFR 47 Part 22, ISED RSS-GEN and Industry Canada RSS-132 is shown below.

Section	Specification Clause				Test Description	Result
	FCC CFR 47 Part 2	FCC CFR 47 Part 22	RSS-GEN	RSS-132		
2.1	2.1046	22.913 (a)	-	5.4	Maximum Peak Output Power and Peak to Average Ratio - Conducted	Pass
2.2	2.1049	22.917 (b)	6.7	-	Occupied Bandwidth	Pass
2.3	2.1051	22.917(b)	-	5.5	Band Edge	Pass
2.4	2.1051	22.917(a)	-	5.5	Transmitter Spurious Emissions	Pass

Measurement Uncertainty Decision Rule

Determination of conformity with the specification limits is based on the decision rule according to IEC Guide 115: 2007, clause 4.4.3 and 4.5.1.



1.3 CONFIGURATION DESCRIPTION

Configuration	RAT	No. Of carriers	Carrier Bandwidth	Carrier Frequency Configuration (MHz)		
				Bottom	Middle	Top
A	NR	1	5 MHz – SCS 15kHz	871.5	-	891.5
	NR	1	10 MHz – SCS 15kHz	874.0	-	889.0
	NR	1	15 MHz – SCS 15kHz	876.5	-	886.5
	NR	1	20 MHz – SCS 15kHz	879.0	-	884.0
	NR	1	20 MHz – SCS 60kHz	879.0	-	884.0
B	NR	2	10 MHz + 15 MHz SCS 15kHz	-	874.0+886.5	-



1.4 DECLARATION OF BUILD STATUS

MAIN EUT	
MANUFACTURING DESCRIPTION	Radio Unit
MANUFACTURER	Ericsson AB
PRODUCT NAME	Radio 2217 B5
PART NUMBER	KRC 161 566/1, KRC 161 566/2
IC Model Name	AS1615661, AS1615662
SERIAL NUMBER	CD3X367474
HARDWARE VERSION	R1E
SOFTWARE VERSION	CXP 901 3268/9 – R77ZT
TRANSMITTER OPERATING RANGE	B5: 869 - 894 MHz
MODULATIONS	WCDMA: QPSK, 16QAM, 64QAM LTE & NR: QPSK, 16QAM, 64QAM, 256QAM
ITU DESIGNATION OF EMISSION	WCDMA 5 MHz BW channel: 5M00F9W
	LTE 1.4 MHz BW channel: 1M40F9W
	LTE 3 MHz BW channel: 3M00F9W
	LTE 5 MHz BW channel: 5M00F9W
	LTE 10 MHz BW channel: 10M0F9W
	NR 5 MHz BW channel: 5M00W7D
	NR 10 MHz BW channel: 10M0W7D
	NR 15 MHz BW channel: 15M0W7D
	NR 20 MHz BW channel: 20M0W7D
NR CA channel: 25M0W7D	
OUTPUT POWER (RMS) (W or dBm)	2 ports, 40W per port
FCC ID	TA8AKRC161566
IC ID	287AB-AS161566
TECHNICAL DESCRIPTION (a brief description of the intended use and operation)	Base station radio

Supports NB IoT IB for LTE

Signature Xiaoying Jiang
Xiaoying Jiang

Date 2020-03-09

No responsibility will be accepted by TÜV SÜD as to the accuracy of the information declared in this document by the manufacturer.

1.5 PRODUCT INFORMATION

1.5.1 Technical Description

The Equipment Under Test (EUT) Radio 2217 B5 is an Ericsson AB Radio Unit working in the public mobile service 850MHz band which provides communication connections to 850MHz network. The Radio 2217 B5 operates from a -48V DC supply.

The Equipment Under Test (EUT) is shown in the photograph below. A full technical description can be found in the Manufacturer's documentation.

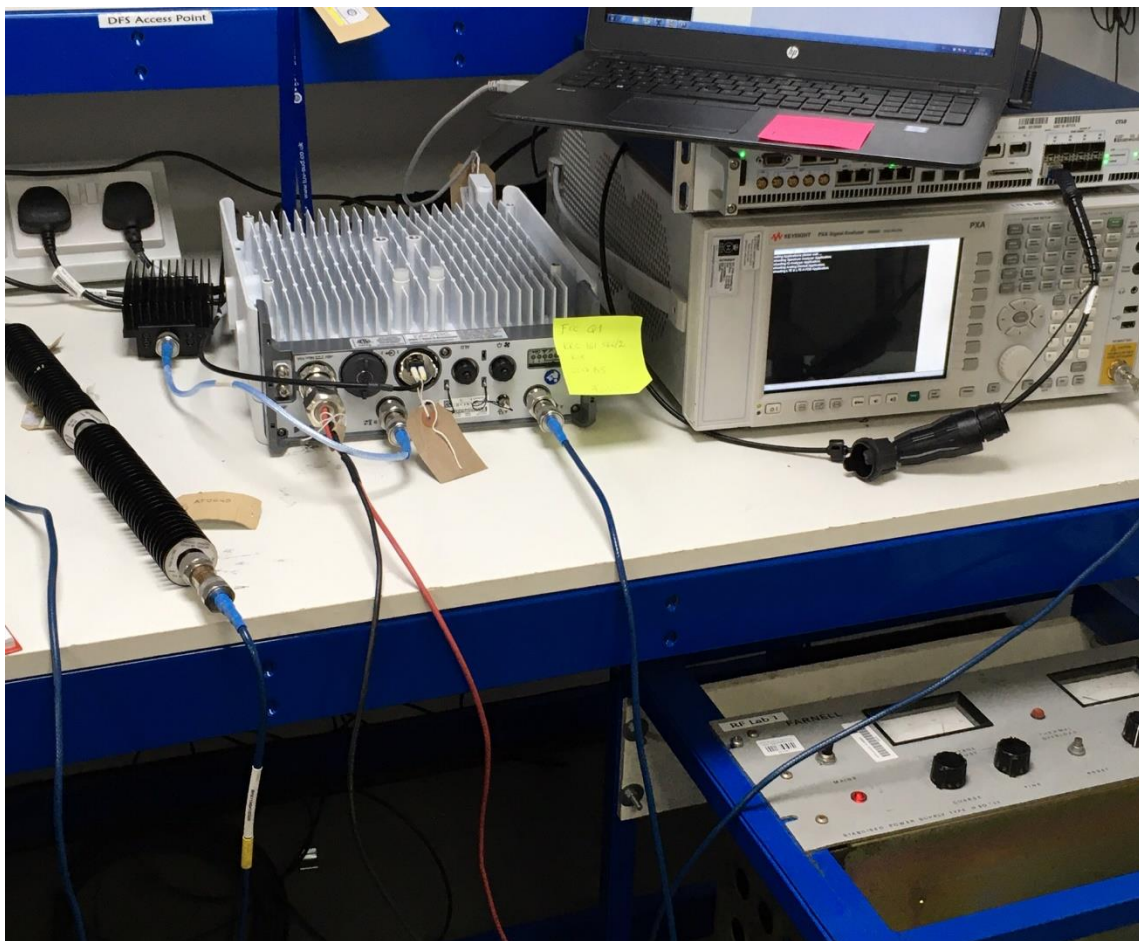

Equipment Under Test



1.6 TEST SETUP

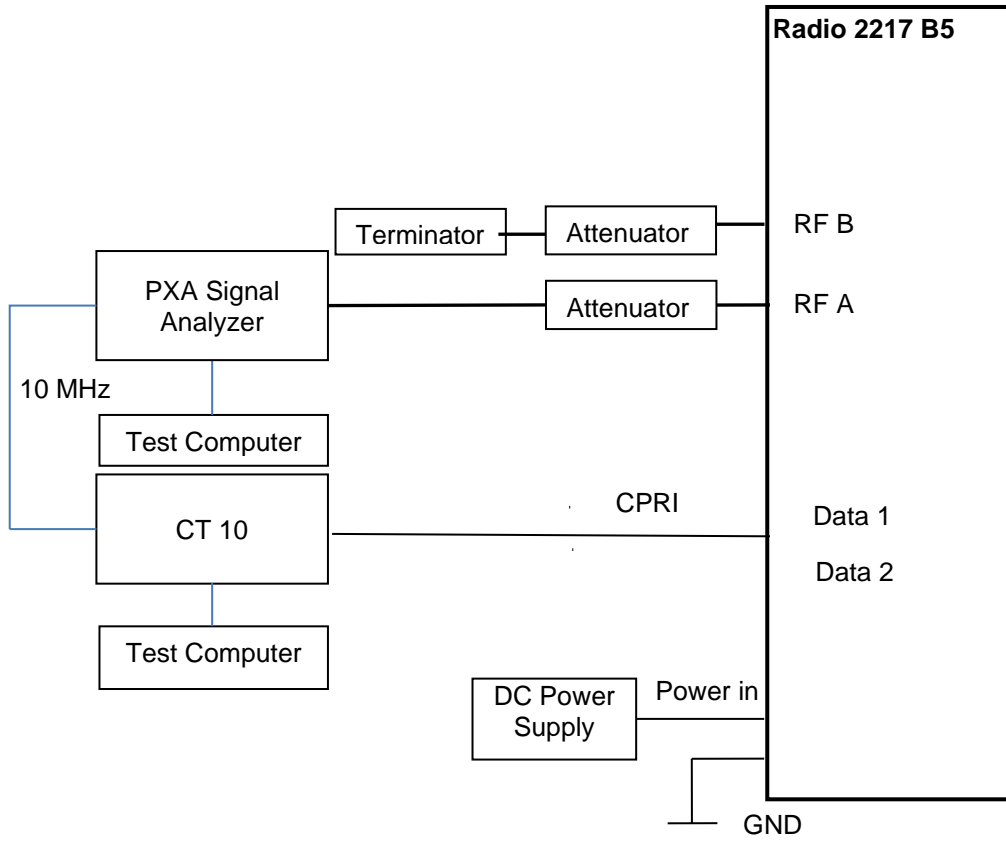



1.7 TEST CONDITIONS

For all tests the EUT was set up in accordance with the relevant test standard and to represent typical operating conditions. Tests were applied with the EUT situated as described in the Test Method for each Test.

The EUT was powered from a -48V DC supply.

FCC Measurement Facility Registration Number
90987 Octagon House, Fareham Test Laboratory

ISED Accreditation
12669A Octagon House, Fareham Test Laboratory

Test Name	Name of Engineer(s)
Maximum Peak Output Power and Peak to Average Ratio - Conducted	Brian Scarfe
Occupied Bandwidth	Brian Scarfe
Band Edge	Brian Scarfe
Transmitter Spurious Emissions	Brian Scarfe

1.8 DEVIATION FROM THE STANDARD

No deviations from the applicable test standards or test plan were made during testing.

1.9 MODIFICATION RECORD

No modifications were made to the EUT during testing.



SECTION 2

TEST DETAILS



2.1 MAXIMUM PEAK OUTPUT POWER AND PEAK TO AVERAGE RATIO - CONDUCTED

2.1.1 Specification Reference

FCC CFR 47 Part 22, Clause 22.913 (a)
 Industry Canada RSS-132, Clause 5.4
 FCC CFR 47 Part 2, Clause 2.1046

2.1.2 Date of Test and Modification State

30 January 2020 - Modification State 0

2.1.3 Test Equipment Used

The major items of test equipment used for the above tests are identified in Section 3.1.

2.1.4 Environmental Conditions

Ambient Temperature 21.3°C
 Relative Humidity 45.8%

2.1.5 Test Method

All measurements were made in accordance with FCC KDB 971168 D01, clause 5.2.1 and summed in accordance with FCC KDB 662911 D01.

2.1.6 Test Results

Configuration A

Maximum Output Power 46.00 dBm

Antenna	NR Modulation	NR Carrier Bandwidth	Peak to Average Ratio (PAR) / Output Power		
			PAR (dB)	Channel Position B	
				Average Power	
			dBm	dBm/MHz	
A	QPSK	5.0 MHz 15 kHz SCS	7.27	45.93	40.00
A	QPSK	10.0 MHz 15 kHz SCS	-	45.80	-
A	QPSK	15.0 MHz 15 kHz SCS	-	45.78	-
A	QPSK	20.0 MHz 15 kHz SCS	-	45.72	-
A	QPSK	20.0 MHz 60 kHz SCS	-	45.79	-
A	QPSK	10.0+15.0 MHz 15 kHz SCS	-	45.75	-



Antenna A - NR Modulation QPSK - NR Carrier Bandwidth 5.0 MHz 15 kHz SCS - Channel Position B

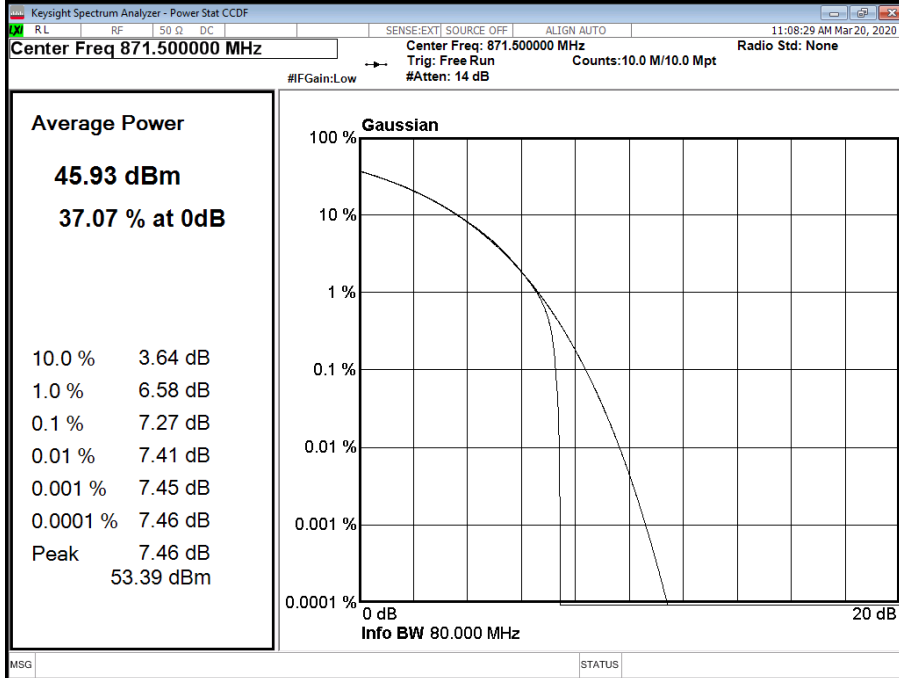

Antenna A - NR Modulation QPSK - NR Carrier Bandwidth 5.0 MHz 15 kHz SCS - Channel Position B

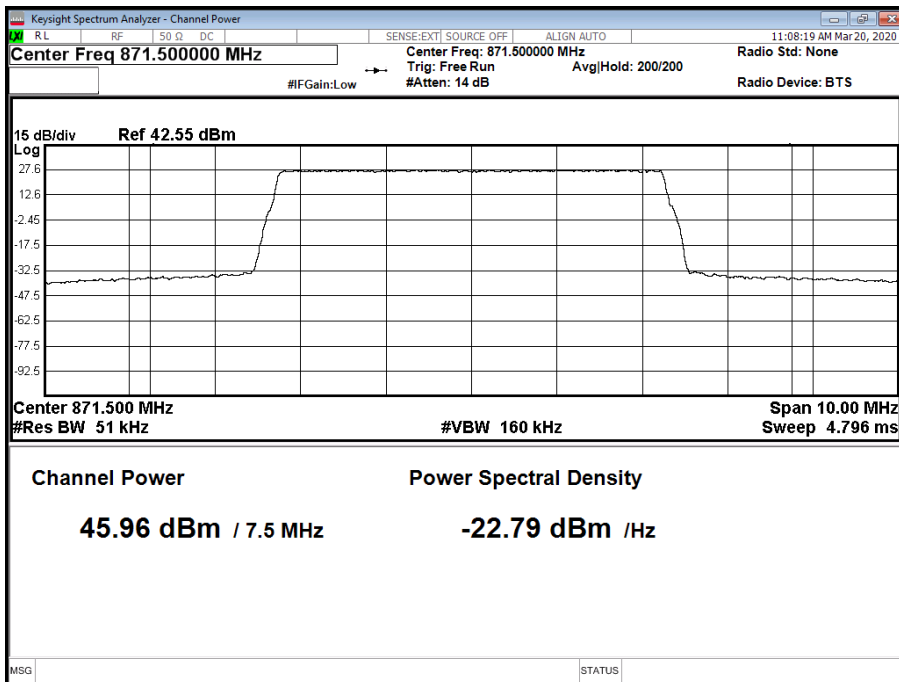



Antenna A - NR Modulation QPSK - NR Carrier Bandwidth 10.0 MHz 15 kHz SCS - Channel Position B

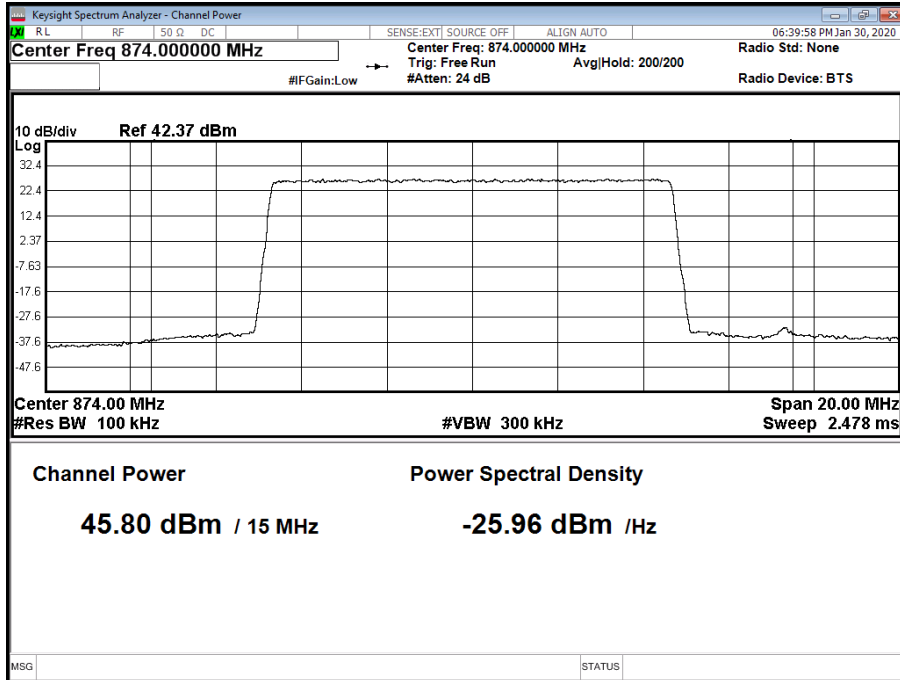



Antenna A - NR Modulation QPSK - NR Carrier Bandwidth 15.0 MHz 15 kHz SCS - Channel Position B

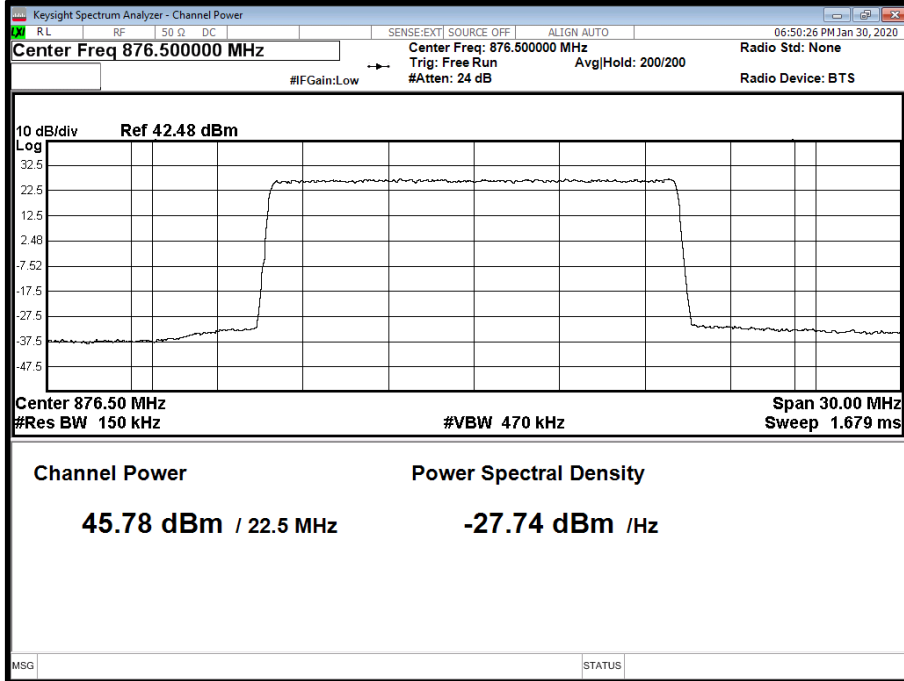

Antenna A - NR Modulation QPSK - NR Carrier Bandwidth 20.0 MHz 15 kHz SCS - Channel Position B

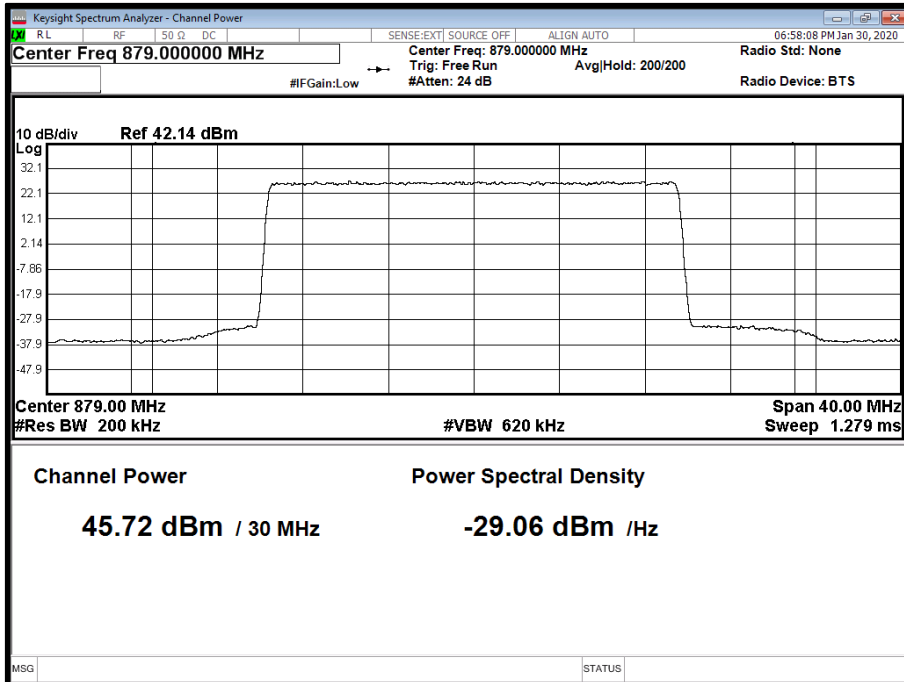



Antenna A - NR Modulation QPSK - NR Carrier Bandwidth 20.0 MHz 60 kHz SCS - Channel Position B

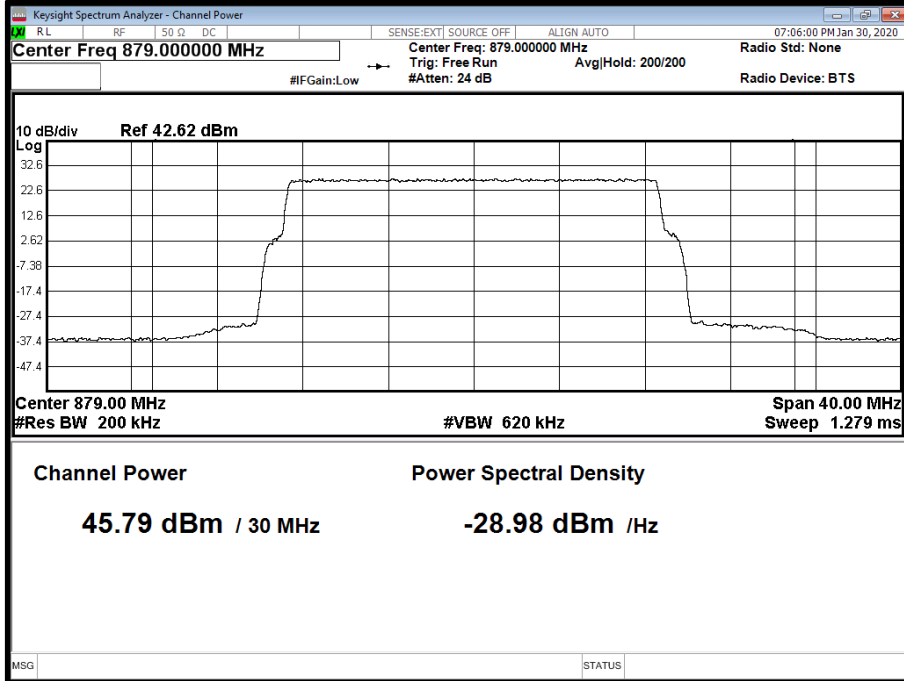

Configuration B

Maximum Output Power 46.00 dBm

Antenna	NR Modulation	NR Carrier Bandwidth	Peak to Average Ratio (PAR) / Output Power		
			Channel Position M		
			PAR (dB)	Average Power	
dBm	dBm/MHz				
A	QPSK	10.0+15.0 MHz 15 kHz SCS	-	45.75	-



Antenna A - NR Modulation QPSK - NR Carrier Bandwidth 10.0+15.0 MHz 15kHz SCS - Channel Position M

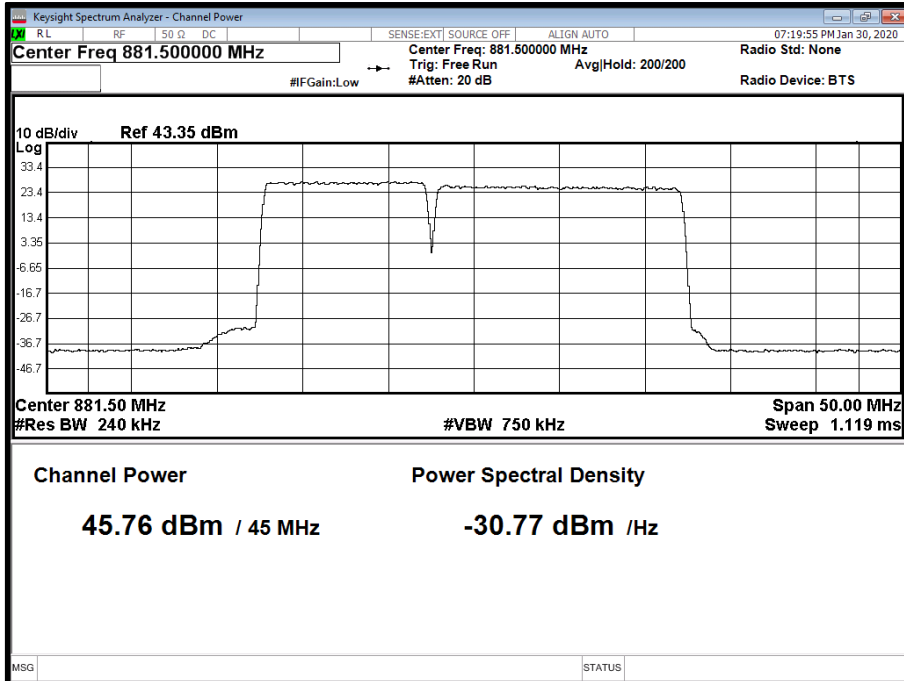



Configuration A

Maximum Output Power 46.00 dBm

Antenna	NR Modulation	NR Carrier Bandwidth	Peak to Average Ratio (PAR) / Output Power		
			Channel Position T		
			PAR (dB)	Average Power	
dBm	dBm/MHz				
A	QPSK	5.0 MHz 15 kHz SCS	7.37	45.82	39.96
A	QPSK	10.0 MHz 15 kHz SCS	-	45.78	-
A	QPSK	15.0 MHz 15 kHz SCS	-	45.83	-
A	QPSK	20.0 MHz 15 kHz SCS	-	45.80	-
A	QPSK	20.0 MHz 60 kHz SCS	-	45.93	-



Antenna A - NR Modulation QPSK - NR Carrier Bandwidth 5.0 MHz 15 kHz SCS - Channel Position T

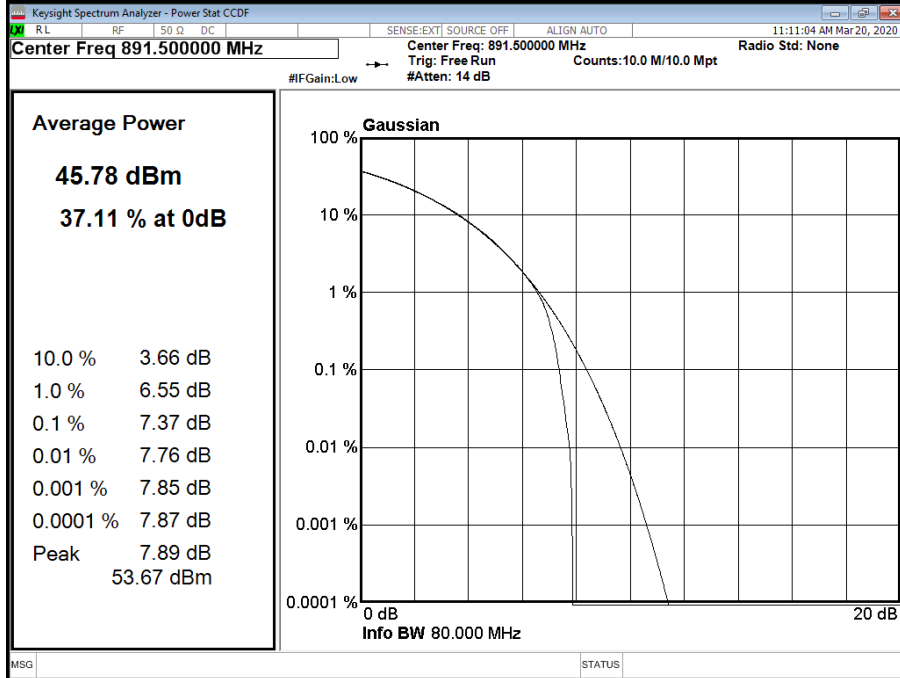

Antenna A - NR Modulation QPSK - NR Carrier Bandwidth 5.0 MHz 15 kHz SCS - Channel Position T

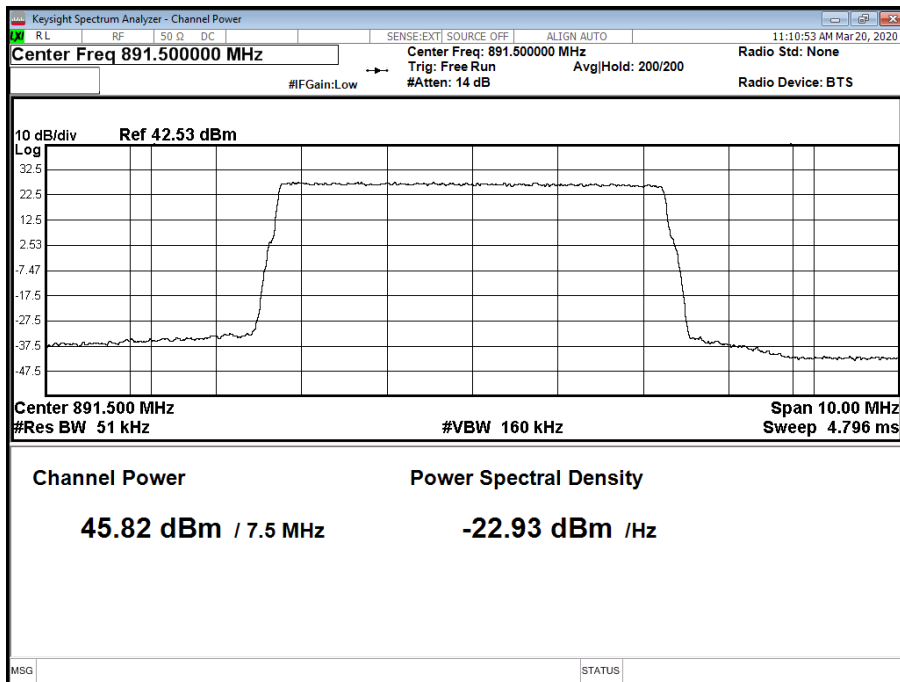



Antenna A - NR Modulation QPSK - NR Carrier Bandwidth 10.0 MHz 15 kHz SCS - Channel Position T

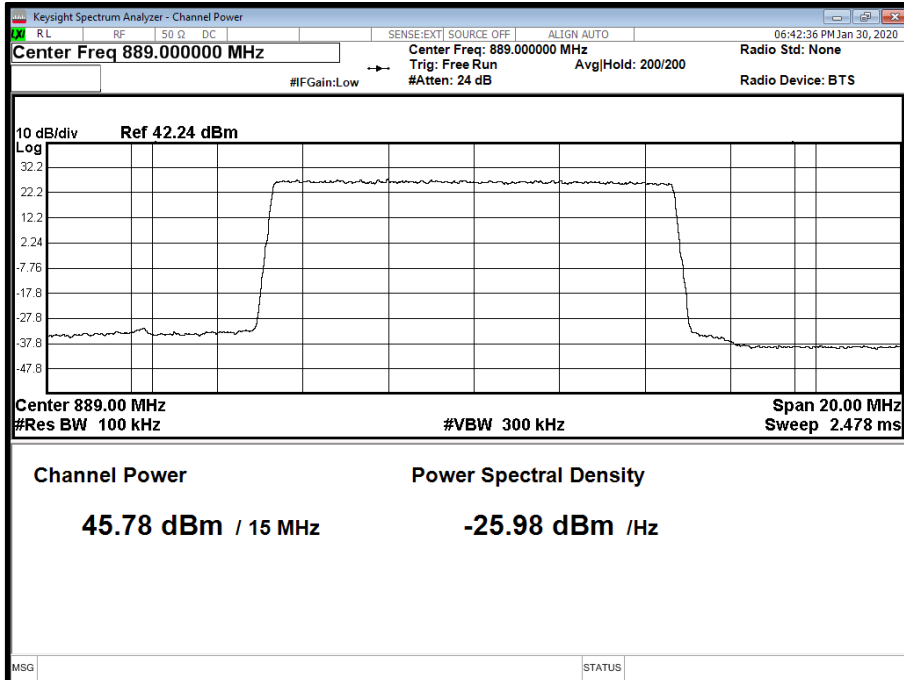



Antenna A - NR Modulation QPSK - NR Carrier Bandwidth 15.0 MHz 15 kHz SCS - Channel Position T

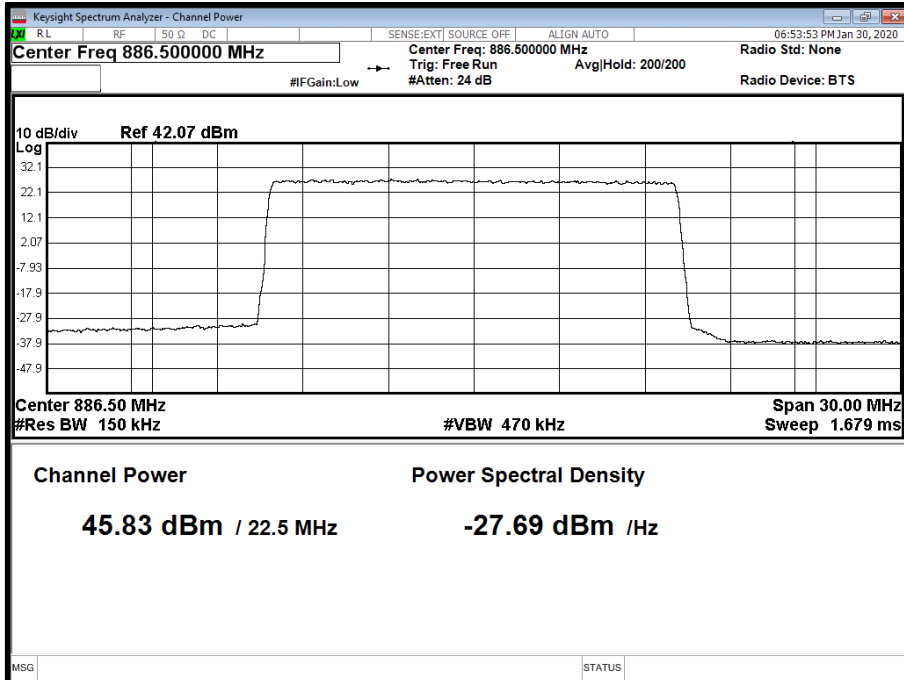

Antenna A - NR Modulation QPSK - NR Carrier Bandwidth 20.0 MHz 15 kHz SCS - Channel Position T

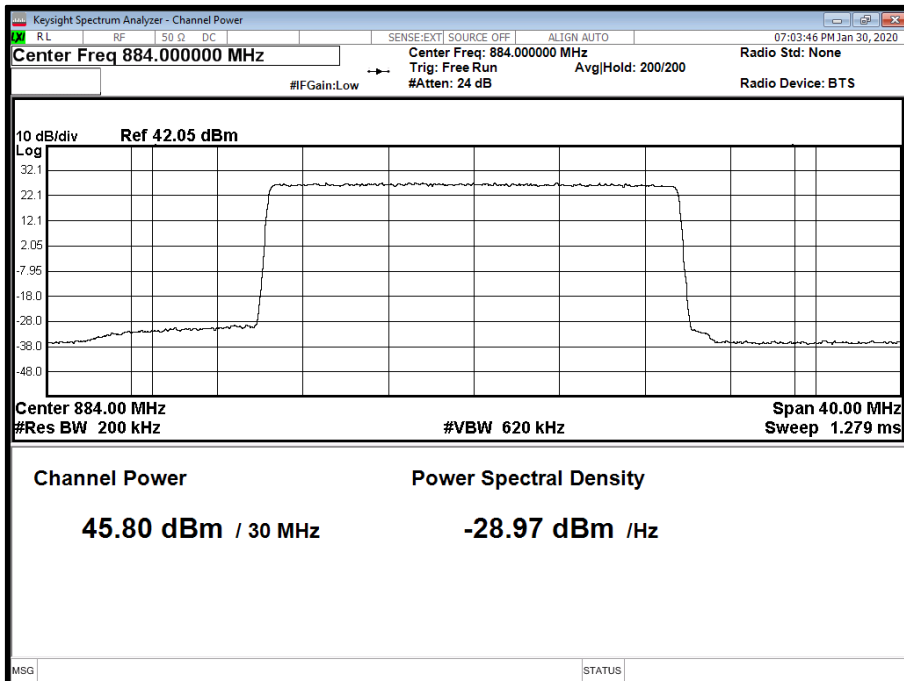



Antenna A - NR Modulation QPSK - NR Carrier Bandwidth 20.0 MHz 60 kHz SCS - Channel Position T

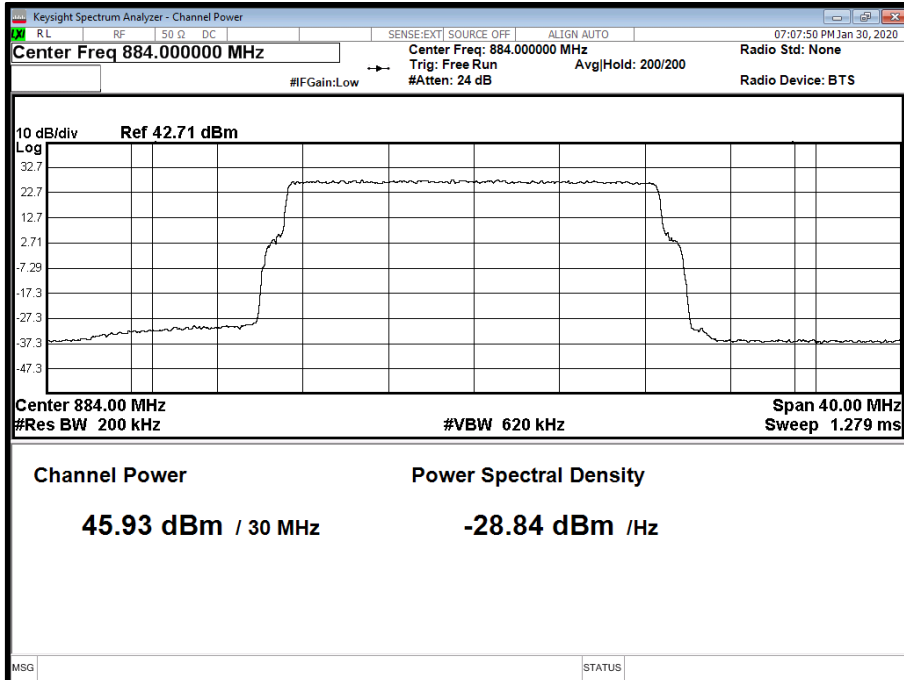

Limit	
Peak Power	≤ 1640 W/MHz or ≤+62.15 dBm
Peak to Average Ratio	13 dB



2.2 OCCUPIED BANDWIDTH

2.2.1 Specification Reference

FCC CFR 47 Part 22, Clause 22.917 (b)
 ISED RSS-GEN, Clause 6.7
 FCC CFR 47 Part 2, Clause 2.1049

2.2.2 Date of Test and Modification State

30 January 2020 - Modification State 0

2.2.3 Test Equipment Used

The major items of test equipment used for the above tests are identified in Section 3.1.

2.2.4 Environmental Conditions

Ambient Temperature 21.3°C
 Relative Humidity 45.8%

2.2.5 Test Method

All measurements were made in accordance with FCC KDB 971168 D01.

2.2.6 Test Results

Configuration A and B

Maximum Output Power 46.00 dBm

Antenna	NR Modulation	NR Carrier Bandwidth	Result (KHz)					
			Channel Position B		Channel Position M		Channel Position T	
			Occupied Bandwidth	-26 dB Bandwidth	Occupied Bandwidth	-26 dB Bandwidth	Occupied Bandwidth	-26 dB Bandwidth
A	QPSK	5.0 MHz 15 kHz SCS	4474.70	4828.99	-	-	4468.81	4825.09
A	QPSK	10.0 MHz 15 kHz SCS	9282.39	9779.28	-	-	9291.93	9771.33
A	QPSK	15.0 MHz 15 kHz SCS	14089.04	14757.59	-	-	14093.96	14768.24
A	QPSK	20.0 MHz 15 kHz SCS	18929.34	19735.65	-	-	18900.28	19693.80
A	QPSK	20.0 MHz 60 kHz SCS	17193.72	19511.55	-	-	17181.63	19517.91
A	QPSK	10.0+15.0 MHz 60 kHz SCS	-	-	24073.22	24982.73	-	-



Antenna A - NR Modulation QPSK - NR Carrier Bandwidth 5.0 MHz 15 kHz SCS - Channel Position B

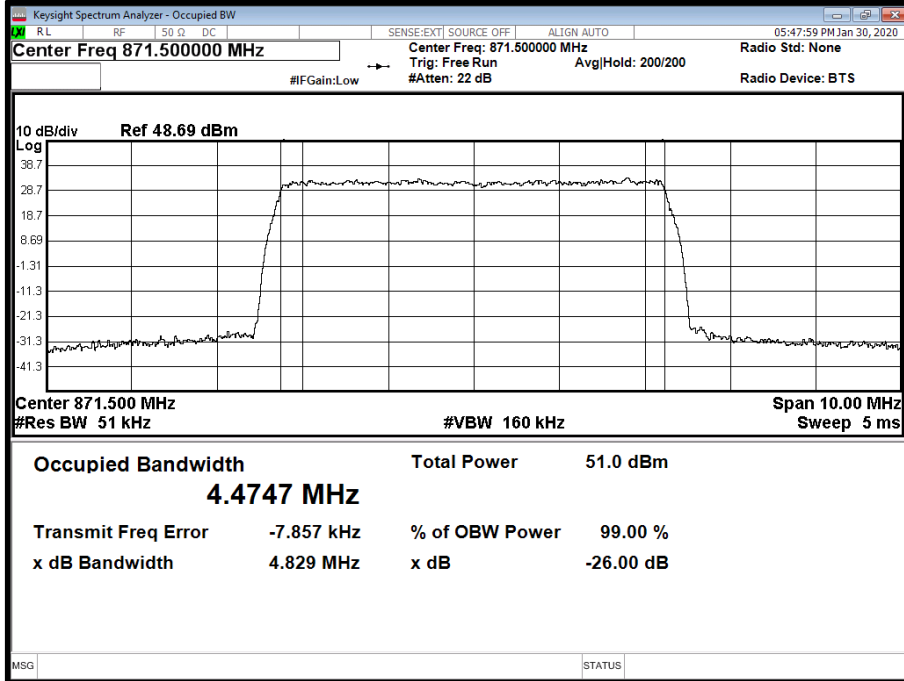

Antenna A - NR Modulation QPSK - NR Carrier Bandwidth 5.0 MHz 15 kHz SCS - Channel Position T

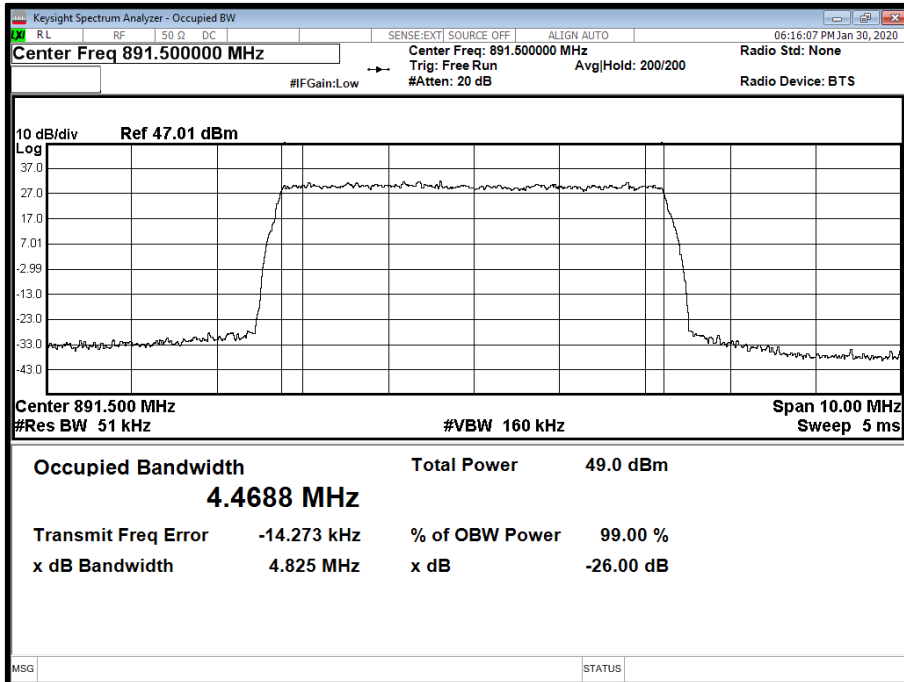



Antenna A - NR Modulation QPSK - NR Carrier Bandwidth 10.0 MHz 15 kHz SCS - Channel Position B

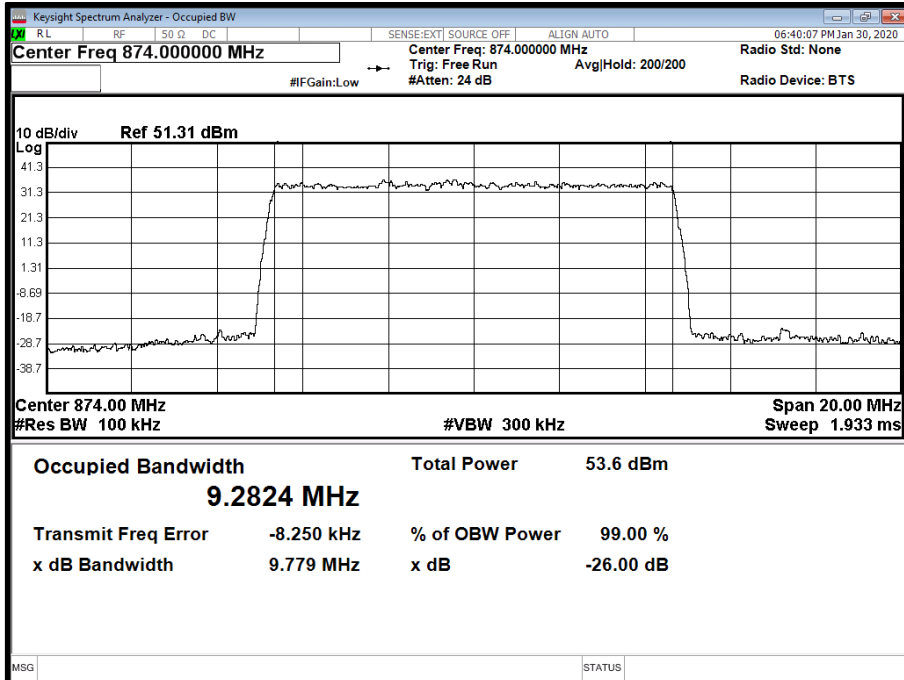

Antenna A - NR Modulation QPSK - NR Carrier Bandwidth 10.0 MHz 15 kHz SCS - Channel Position T

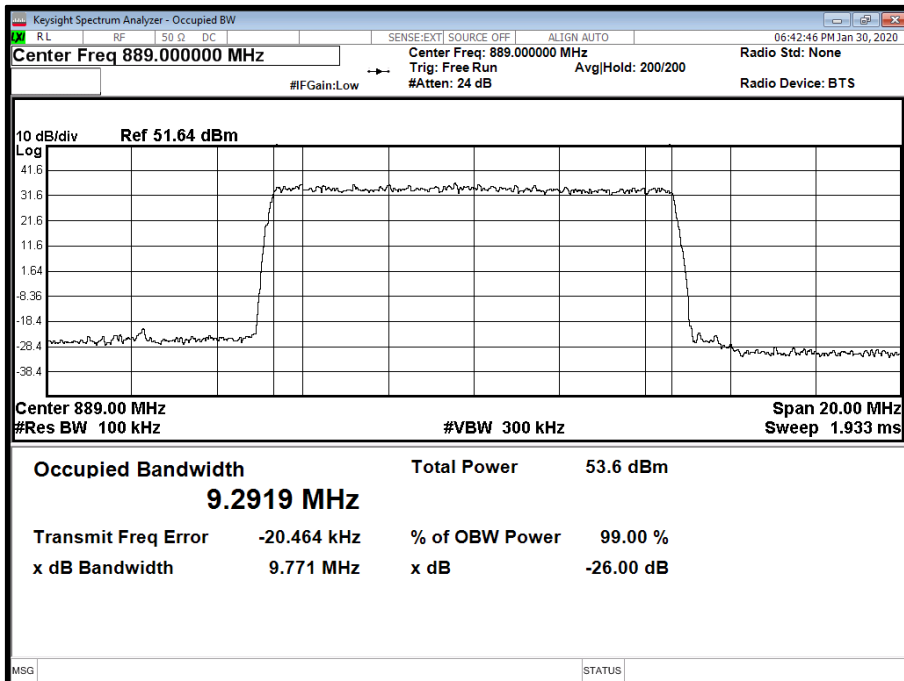



Antenna A - NR Modulation QPSK - NR Carrier Bandwidth 15.0 MHz 15 kHz SCS - Channel Position B

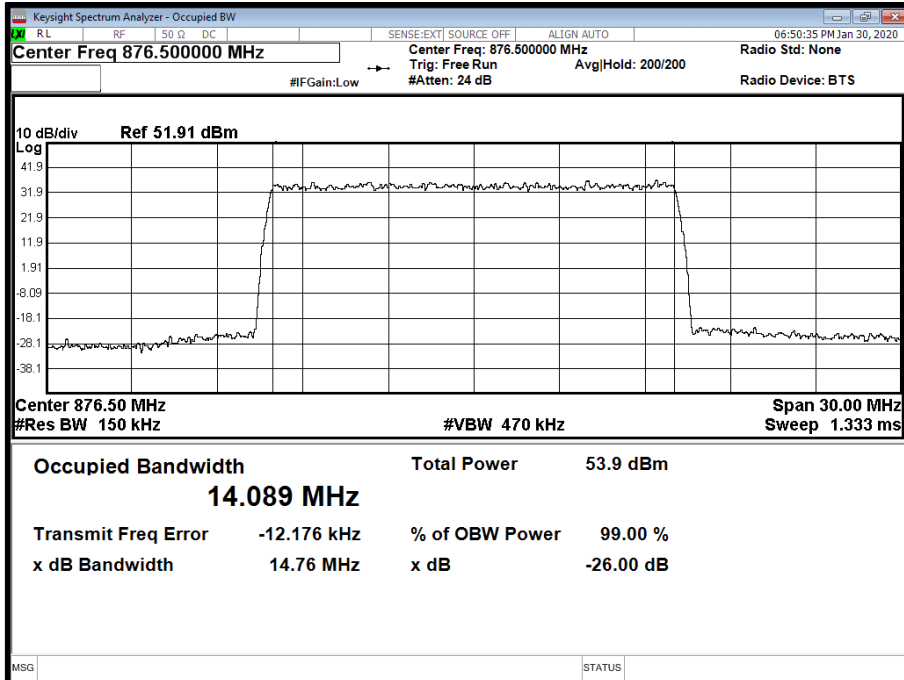

Antenna A - NR Modulation QPSK - NR Carrier Bandwidth 15.0 MHz 15 kHz SCS - Channel Position T

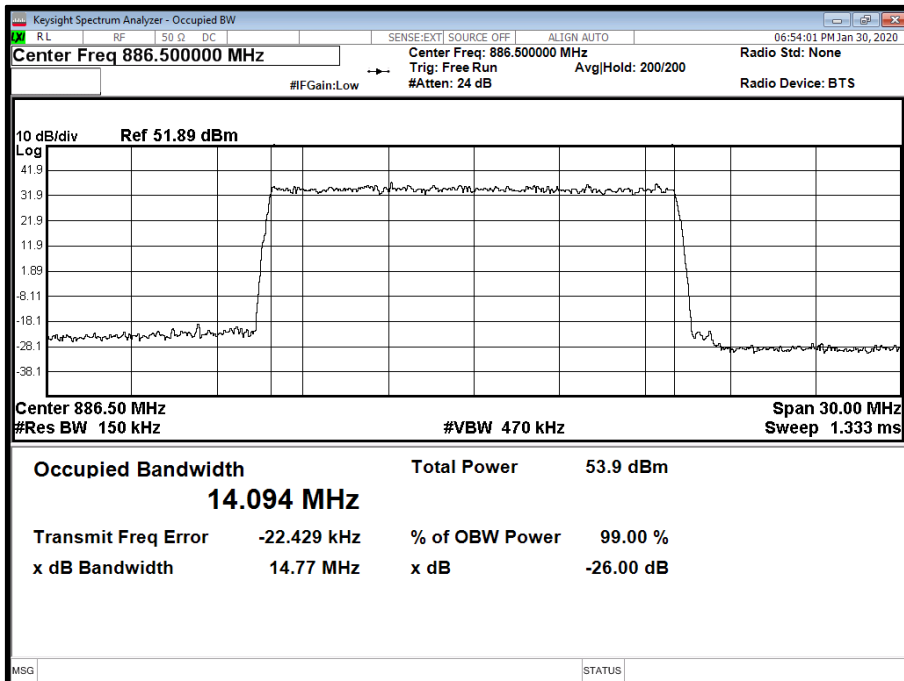



Antenna A - NR Modulation QPSK - NR Carrier Bandwidth 20.0 MHz 15 kHz SCS - Channel Position B

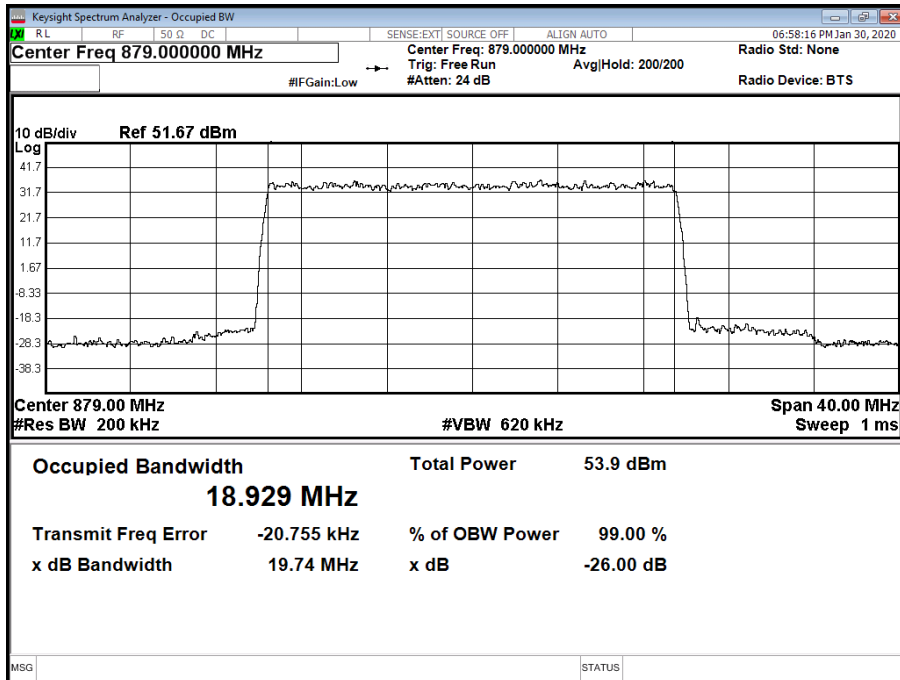

Antenna A - NR Modulation QPSK - NR Carrier Bandwidth 20.0 MHz 15 kHz SCS - Channel Position T

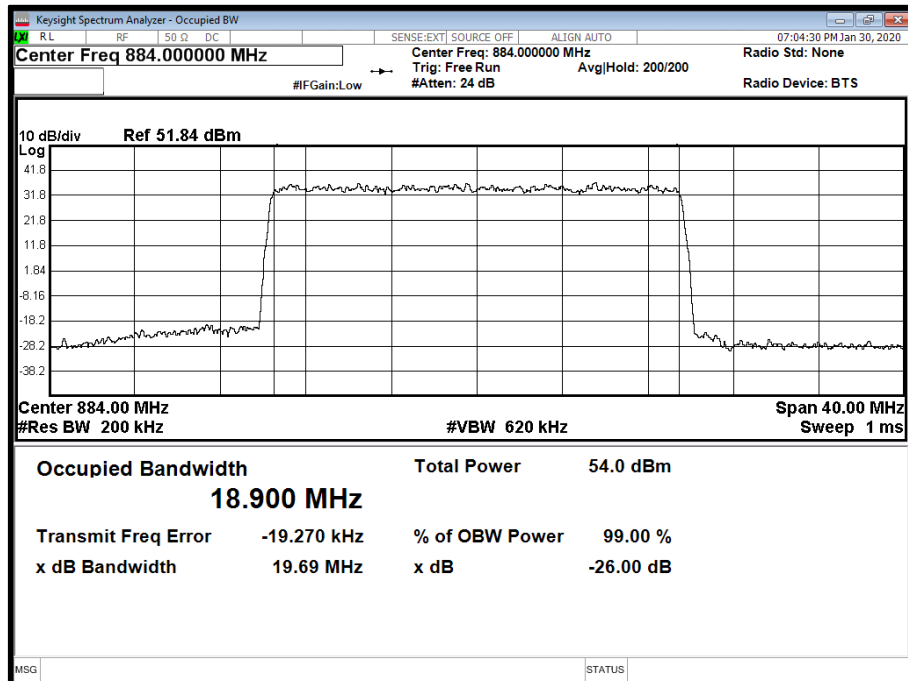



Antenna A - NR Modulation QPSK - NR Carrier Bandwidth 20.0 MHz 60 kHz SCS - Channel Position B

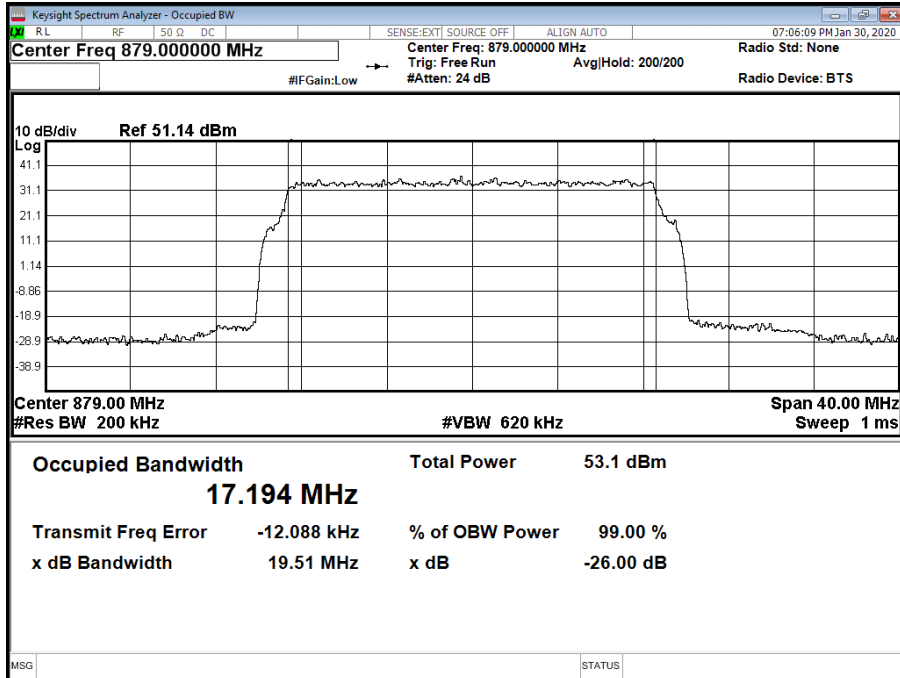

Antenna A - NR Modulation QPSK - NR Carrier Bandwidth 20.0 MHz 60 kHz SCS - Channel Position T

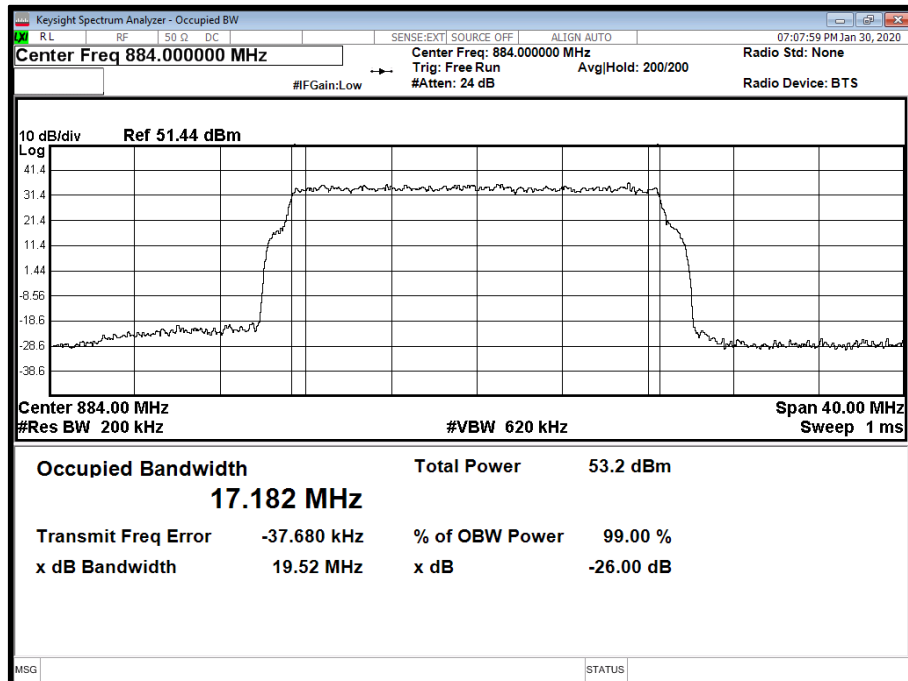



Antenna A - NR Modulation QPSK - NR Carrier Bandwidth 10MHz and 15.0 MHz 60 kHz SCS - Channel Position M

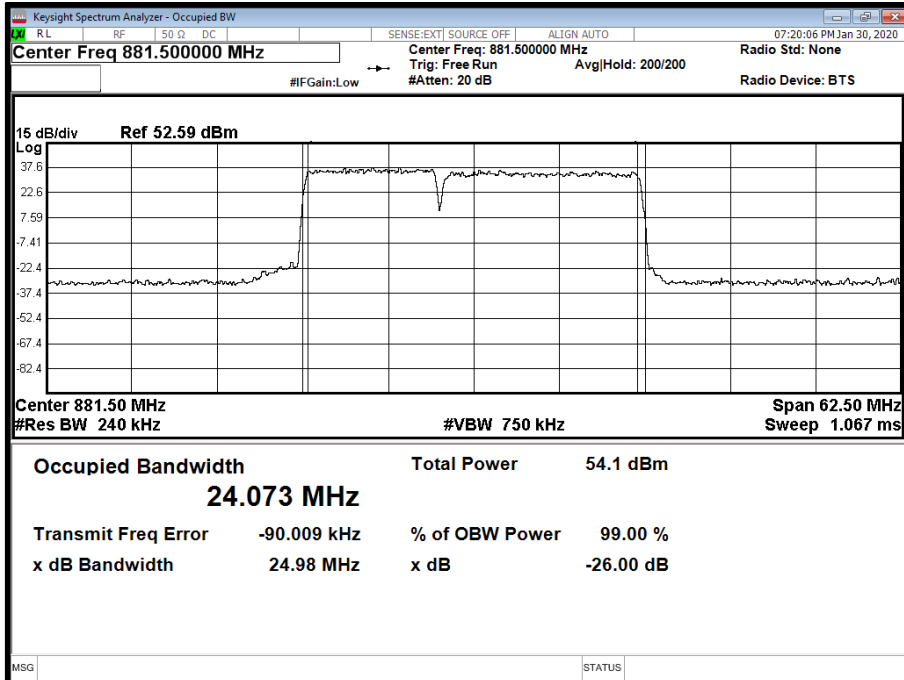



2.3 BAND EDGE

2.3.1 Specification Reference

FCC CFR 47 Part 22, Clause 22.917(b)
 Industry Canada RSS-132, Clause 5.5
 FCC CFR 47 Part 2, Clause 2.1051

2.3.2 Date of Test and Modification State

30 January 2020 - Modification State 0

2.3.3 Test Equipment Used

The major items of test equipment used for the above tests are identified in Section 3.1.

2.3.4 Environmental Conditions

Ambient Temperature 21.3°C
 Relative Humidity 45.8%

2.3.5 Test Method

All measurements were made in accordance with FCC KDB 971168 D01.

Each antenna port has been declared as being equivalent, therefore measurements were made on one antenna port only. To account for this, the limit was tightened by $10 * \text{Log}(N)$, where N is equal to the number of MIMO antenna ports.

For four ports, the limit was calculated as being $-13 \text{ dBm} - 10 * \text{Log}(4) = -19 \text{ dBm}$.

For dual ports, the limit was calculated as being $-13 \text{ dBm} - 10 * \text{Log}(2) = -16 \text{ dBm}$.

2.3.6 Test Results

Configuration A

Maximum Output Power 46.00 dBm

Antenna	NR Modulation	NR Carrier Bandwidth	Band Edge (MHz)	
			Channel Position B	Channel Position T
A	QPSK	5.0 MHz 15 kHz SCS	871.5	891.5
A	QPSK	10.0 MHz 15 kHz SCS	874.0	889.0
A	QPSK	15.0 MHz 15 kHz SCS	876.5	886.5
A	QPSK	20.0 MHz 15 kHz SCS	879.0	884.0
A	QPSK	20.0 MHz 60 kHz SCS	879.0	884.0
A	QPSK	10.0+15.0 MHz 15 kHz SCS	874.0	886.5



Antenna A - NR Modulation QPSK - NR Carrier Bandwidth 5.0 MHz 15 kHz SCS - Channel Position B

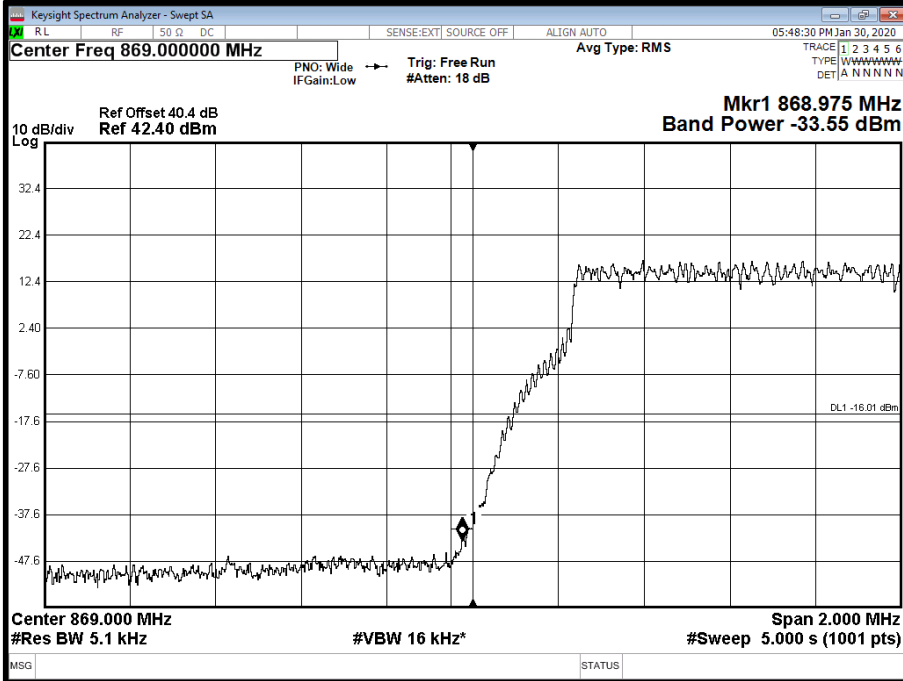

Antenna A - NR Modulation QPSK - NR Carrier Bandwidth 5.0 MHz 15 kHz SCS - Channel Position T

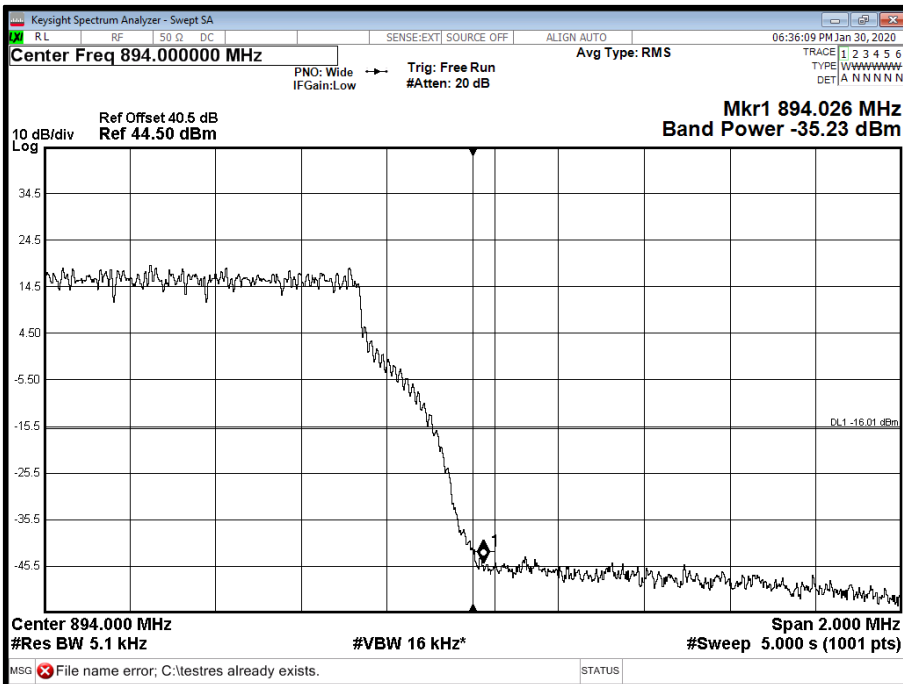



Antenna A - NR Modulation QPSK - NR Carrier Bandwidth 10.0 MHz 15 kHz SCS - Channel Position B

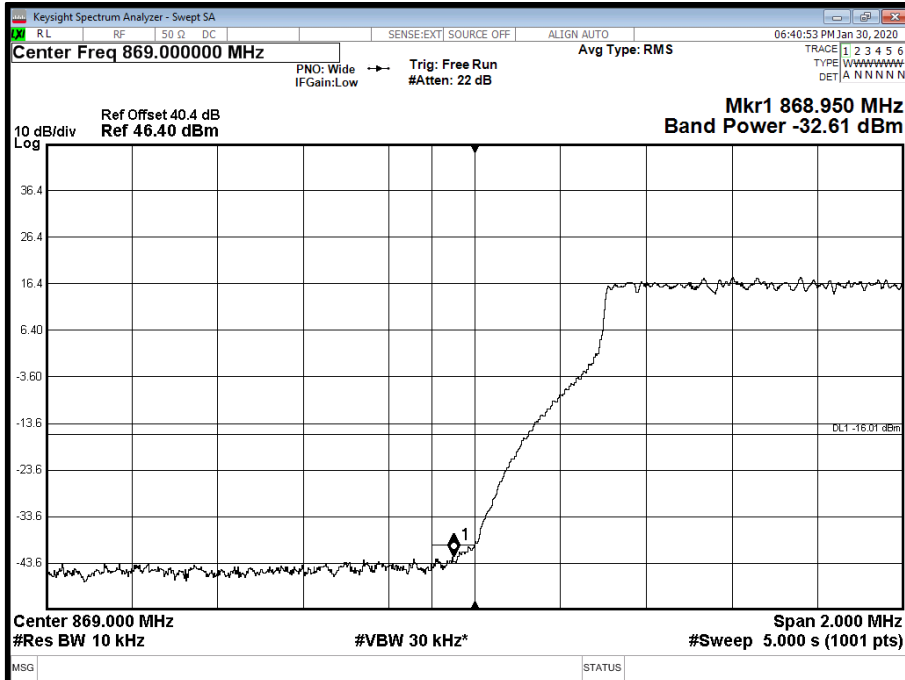

Antenna A - NR Modulation QPSK - NR Carrier Bandwidth 10.0 MHz 15 kHz SCS - Channel Position T

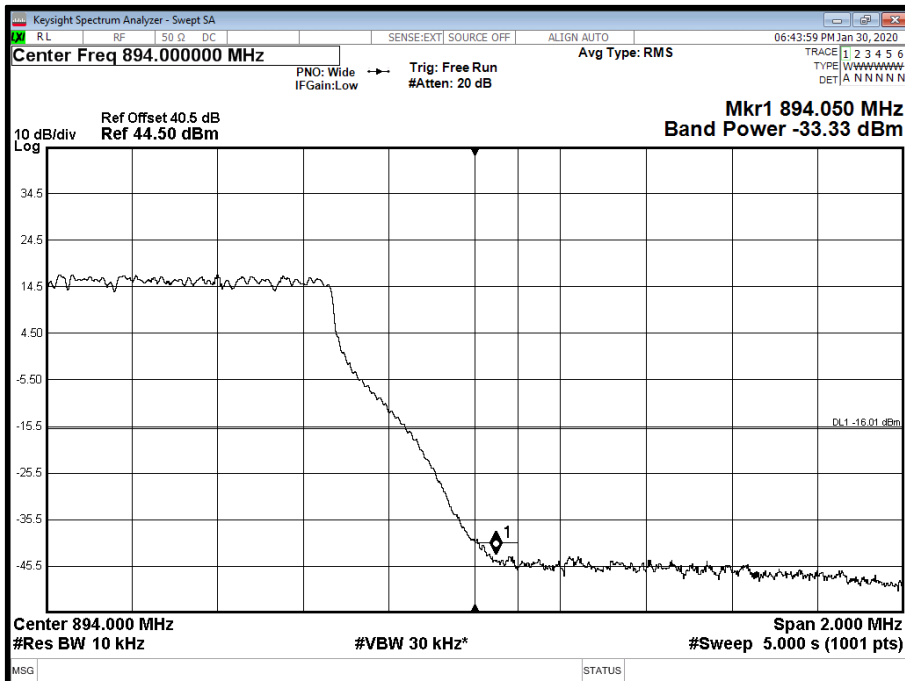



Antenna A - NR Modulation QPSK - NR Carrier Bandwidth 15.0 MHz 15 kHz SCS - Channel Position B

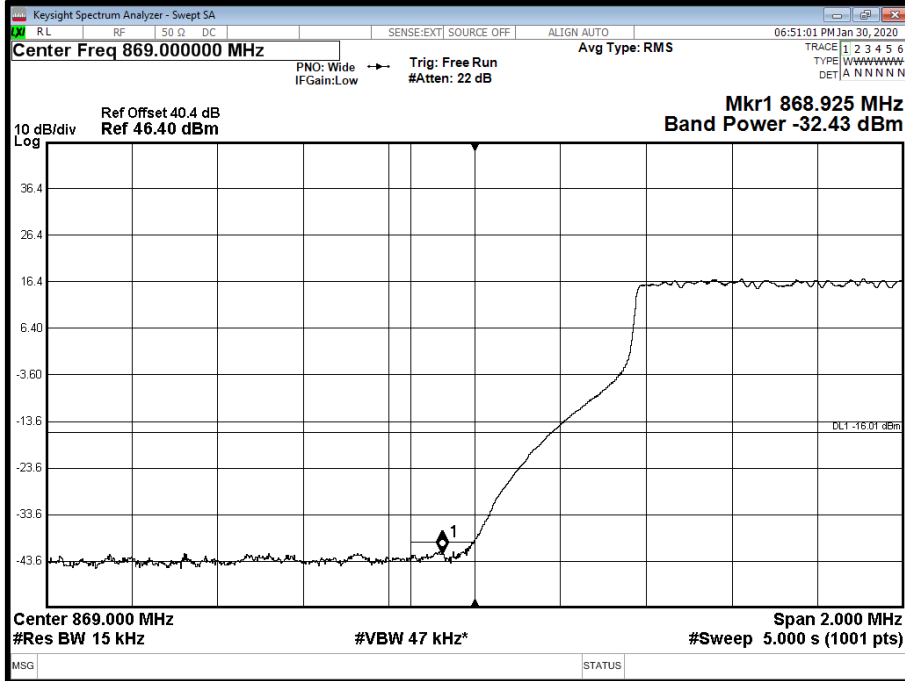

Antenna A - NR Modulation QPSK - NR Carrier Bandwidth 15.0 MHz 15 kHz SCS - Channel Position T

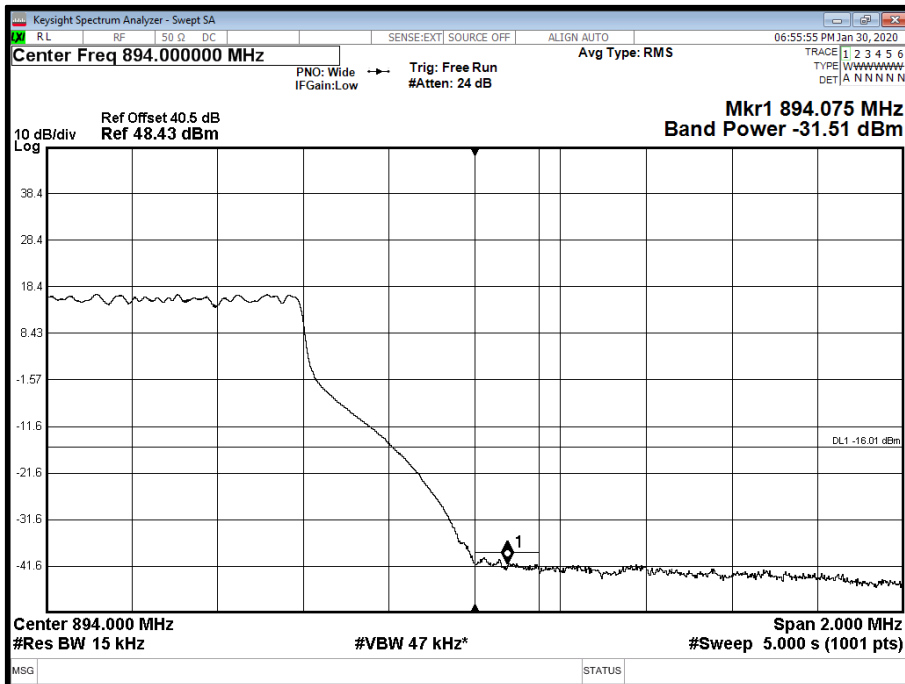



Antenna A - NR Modulation QPSK - NR Carrier Bandwidth 20.0 MHz 15 kHz SCS - Channel Position B

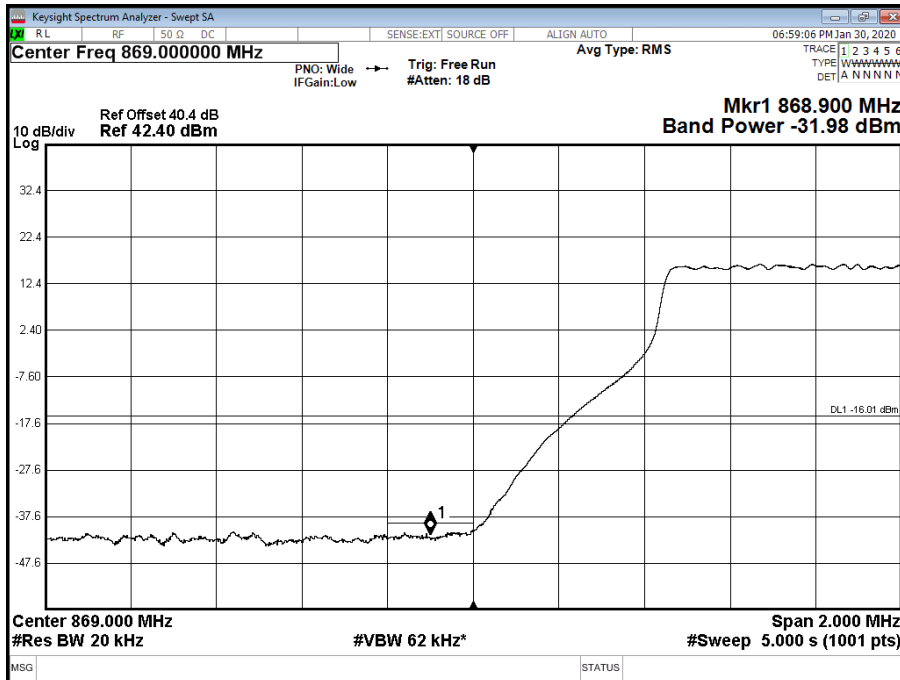

Antenna A - NR Modulation QPSK - NR Carrier Bandwidth 20.0 MHz 15 kHz SCS - Channel Position T

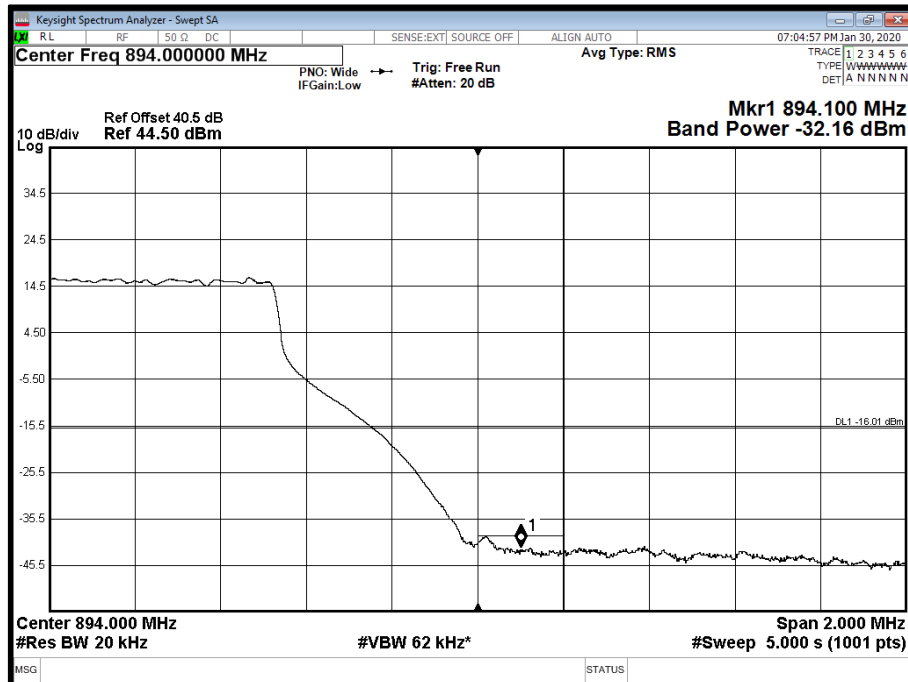



Antenna A - NR Modulation QPSK - NR Carrier Bandwidth 20.0 MHz 60 kHz SCS - Channel Position B

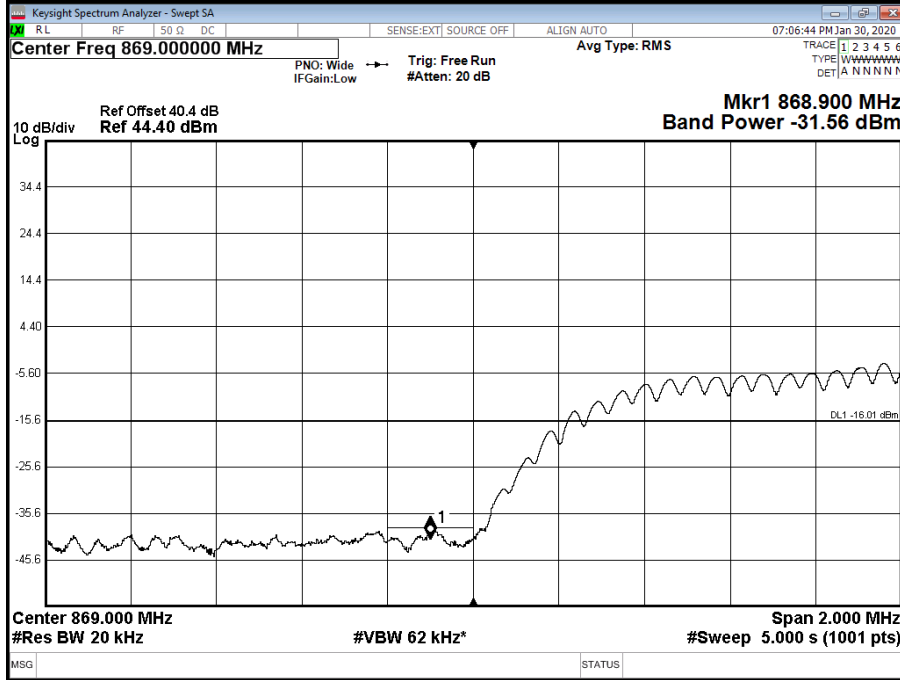

Antenna A - NR Modulation QPSK - NR Carrier Bandwidth 20.0 MHz 60 kHz SCS - Channel Position T

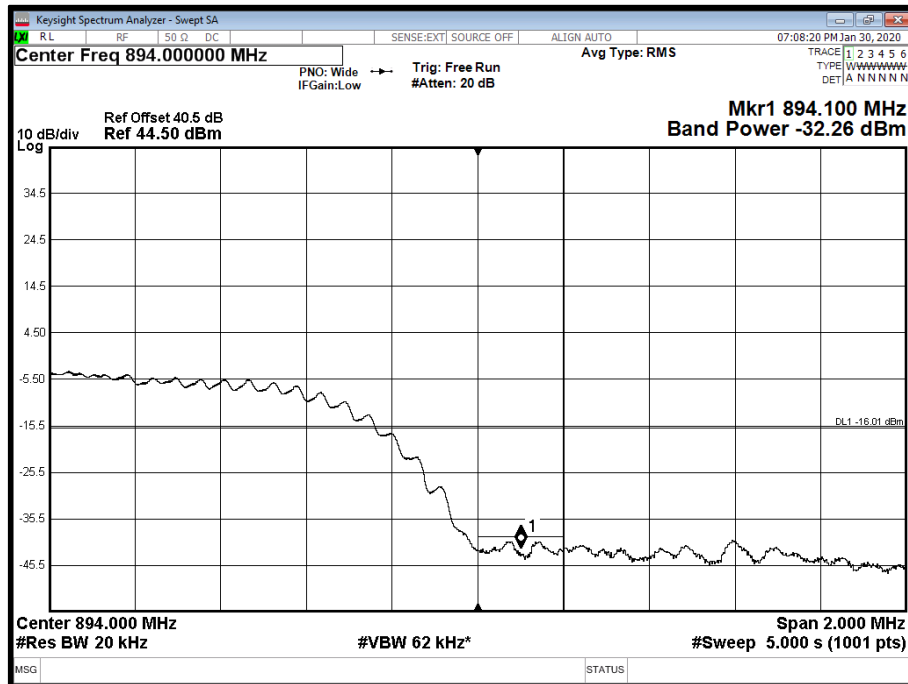



Antenna A - NR Modulation QPSK - NR Carrier Bandwidth 10.0+15.0.0 MHz 15 kHz SCS - Channel Position B

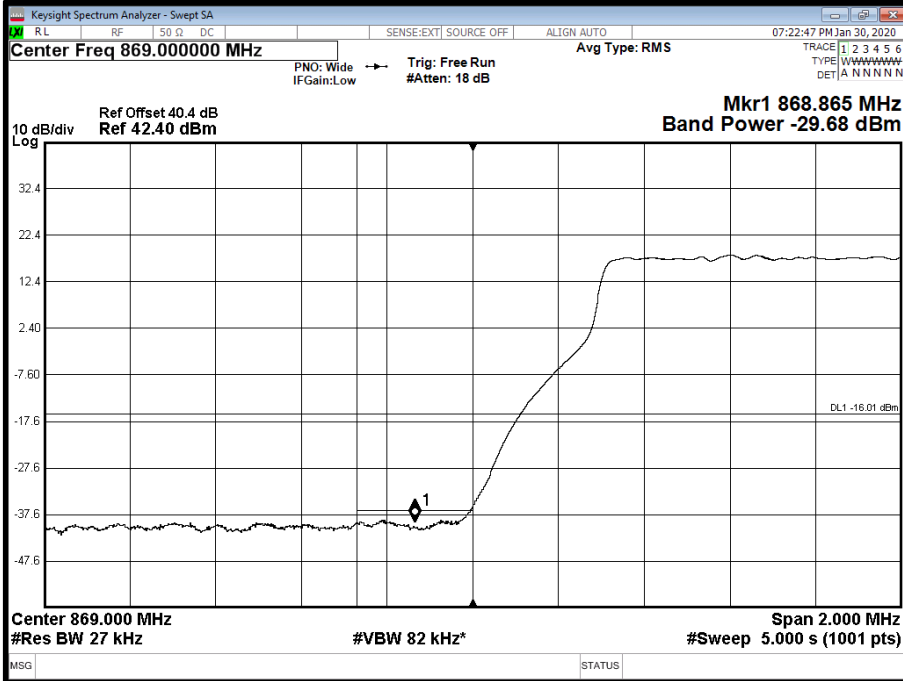

Antenna A - NR Modulation QPSK - NR Carrier Bandwidth 10.0+15.0.0 MHz 15 kHz SCS - Channel Position T

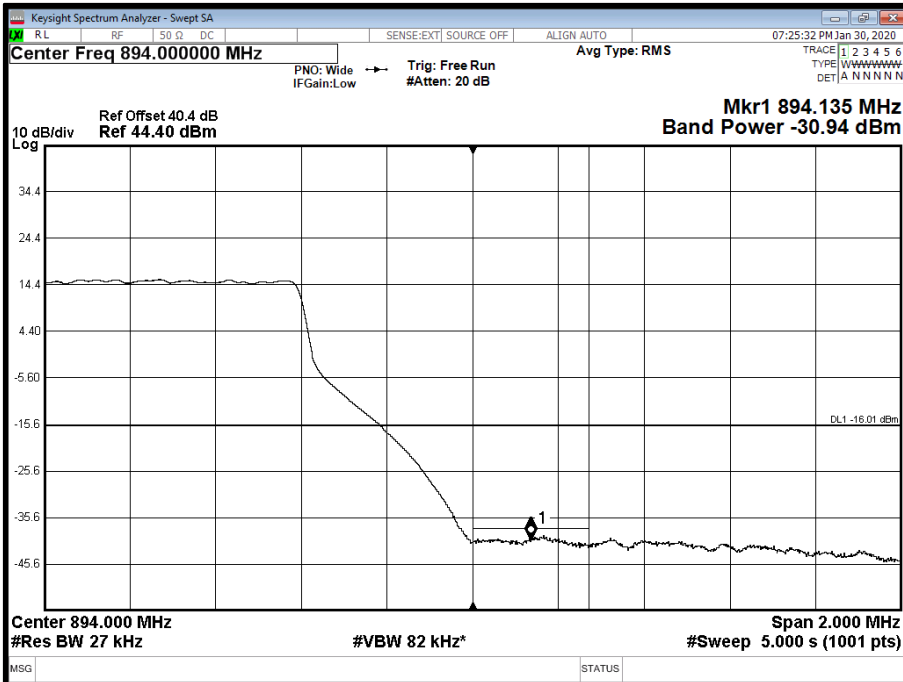

Limit	-16 dBm
-------	---------



2.4 TRANSMITTER SPURIOUS EMISSIONS

2.4.1 Specification Reference

FCC CFR 47 Part 22, Clause 22.917(a)
Industry Canada RSS-132, Clause 5.5
FCC CFR 47 Part 2, Clause 2.1051

2.4.2 Date of Test and Modification State

30 January 2020 - Modification State 0

2.4.3 Test Equipment Used

The major items of test equipment used for the above tests are identified in Section 3.1.

2.4.4 Environmental Conditions

Ambient Temperature	21.3°C
Relative Humidity	45.8%

2.4.5 Test Method

All measurements were made in accordance with FCC KDB 971168 D01.

Each antenna port has been declared as being equivalent, therefore measurements were made on one antenna port only. To account for this, the limit was tightened by $10 * \text{Log}(N)$, where N is equal to the number of MIMO antenna ports.

For four port, the limit was calculated as being $-13 \text{ dBm} - 10 * \text{Log}(4) = -19 \text{ dBm}$.

For dual port, the limit was calculated as being $-13 \text{ dBm} - 10 * \text{Log}(2) = -16 \text{ dBm}$.

2.4.6 Test Results

Configuration A

Maximum Output Power 46.00 dBm



Antenna A - NR Modulation QPSK - NR Carrier Bandwidth 5.0 MHz 15 kHz SCS - Channel Position B - Band 1- Range 0.009 to 1500 MHz

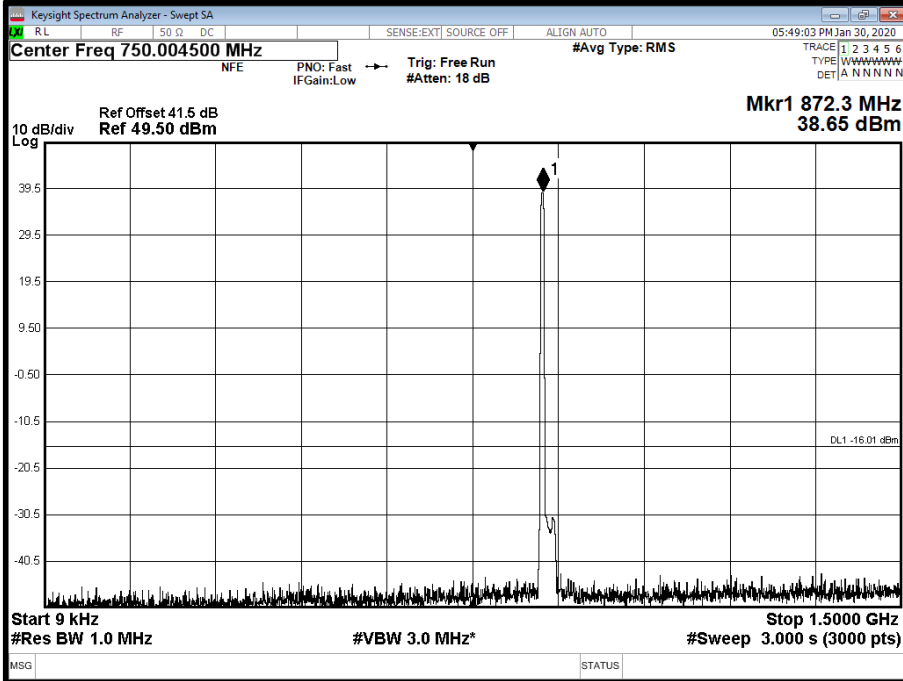

Antenna A - NR Modulation QPSK - NR Carrier Bandwidth 5.0 MHz 15 kHz SCS - Channel Position B - Band 2- Range 1500 to 9000 MHz

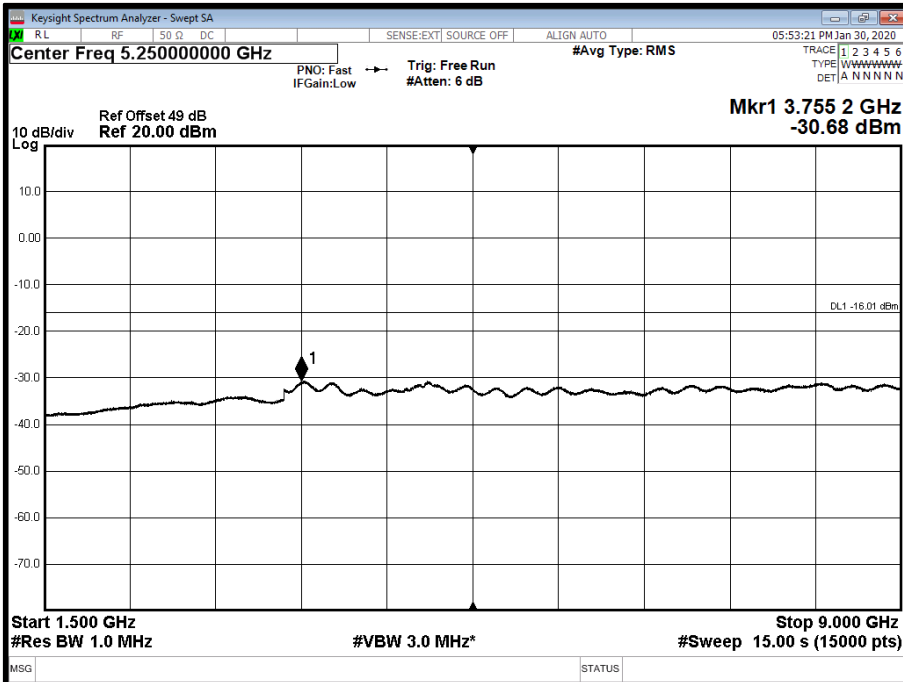



Antenna A - NR Modulation QPSK - NR Carrier Bandwidth 5.0 MHz 15 kHz SCS - Channel Position T - Band 1- Range 0.009 to 1500 MHz

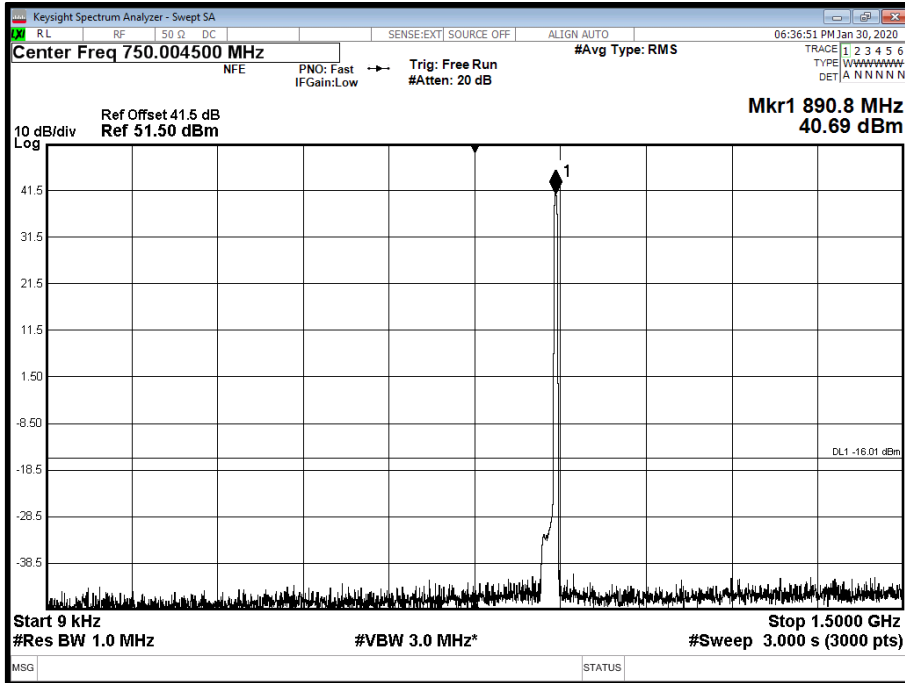

Antenna A - NR Modulation QPSK - NR Carrier Bandwidth 5.0 MHz 15 kHz SCS - Channel Position T - Band 2. - Range 1500 to 9000 MHz

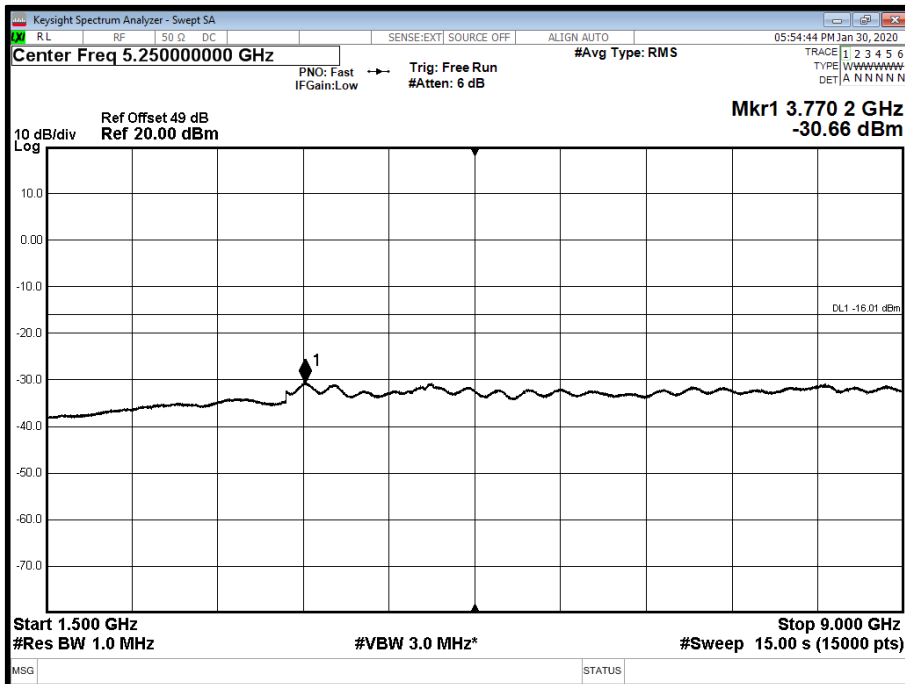

Limit	-16dBm
-------	--------



SECTION 3

TEST EQUIPMENT USED



3.1 TEST EQUIPMENT USED

List of absolute measuring and other principal items of test equipment.

Maximum Peak Output Power and Peak to Average Ratio - Conducted					
3.5 mm 2m K-Type Cable	Junkosha	1911S239	5426	6	13-Jun-2020
3.5 mm 2m K-Type Cable	Junkosha	1911S237	5424	6	13-Jun-2020
PXA Signal Analyser	Keysight	N9030A	4654	12	21-Oct-2020
Attenuator	API weinschel inc.	10dB	4867	12	29-Nov-2020
Attenuator	API weinschel inc.	40dB	5134	12	29-Nov-2020
Multimeter	Fluke	13380293	3813	12	09-Oct-2020
Hygrometer	Rotronic	HP21	5004	12	02-Oct-2020
Occupied Bandwidth					
3.5 mm 2m K-Type Cable	Junkosha	1911S239	5426	6	13-Jun-2020
3.5 mm 2m K-Type Cable	Junkosha	1911S237	5424	6	13-Jun-2020
PXA Signal Analyser	Keysight	N9030A	4654	12	21-Oct-2020
Attenuator	API weinschel inc.	10dB	4867	12	29-Nov-2020
Attenuator	API weinschel inc.	40dB	5134	12	29-Nov-2020
Multimeter	Fluke	13380293	3813	12	09-Oct-2020
Hygrometer	Rotronic	HP21	5004	12	02-Oct-2020
Band Edge					
3.5 mm 2m K-Type Cable	Junkosha	1911S239	5426	6	13-Jun-2020
3.5 mm 2m K-Type Cable	Junkosha	1911S237	5424	6	13-Jun-2020
PXA Signal Analyser	Keysight	N9030A	4654	12	21-Oct-2020
Attenuator	API weinschel inc.	10dB	4867	12	29-Nov-2020
Attenuator	API weinschel inc.	40dB	5134	12	29-Nov-2020
Multimeter	Fluke	13380293	3813	12	09-Oct-2020
Hygrometer	Rotronic	HP21	5004	12	02-Oct-2020
Transmitter Spurious Emissions					
3.5 mm 2m K-Type Cable	Junkosha	1911S239	5426	6	13-Jun-2020
3.5 mm 2m K-Type Cable	Junkosha	1911S237	5424	6	13-Jun-2020
PXA Signal Analyser	Keysight	N9030A	4654	12	21-Oct-2020
Attenuator	API weinschel inc.	10dB	4867	12	29-Nov-2020
Attenuator	API weinschel inc.	40dB	5134	12	29-Nov-2020
Multimeter	Fluke	13380293	3813	12	09-Oct-2020
Hygrometer	Rotronic	HP21	5004	12	02-Oct-2020
1500 Mhz High Pass Filter	Wainwright	WHKX12-1290-1500-18000-80SS	4961	12	11-Oct-2020



3.2 MEASUREMENT UNCERTAINTY

For a 95% confidence level, the measurement uncertainties for defined systems are:-

Test Discipline	Frequency / Parameter	MU	
Conducted Maximum Peak Output Power	30 MHz to 20 GHz Amplitude	± 0.7 dB	
Conducted Emissions	30 MHz to 20 GHz Amplitude	± 2.1 dB	
Frequency Stability	30 MHz to 2 GHz	± 5.0 Hz	
Occupied Bandwidth	Up to 20 MHz Bandwidth	5 MHz Bandwidth	± 11547 Hz
		10 MHz Bandwidth	± 23094 Hz
		15 MHz Bandwidth	± 34641 Hz
		20 MHz Bandwidth	± 46188 Hz
Band Edge	30 MHz to 20 GHz Amplitude	±0.8 dB	

Measurement Uncertainty Decision Rule

Determination of conformity with the specification limits is based on the decision rule according to IEC Guide 115: 2007, clause 4.4.3 and 4.5.1.



SECTION 4

ACCREDITATION, DISCLAIMERS AND COPYRIGHT



4.1 ACCREDITATION, DISCLAIMERS AND COPYRIGHT



This report relates only to the actual item/items tested.

Our UKAS Accreditation does not cover opinions and interpretations and any expressed are outside the scope of our UKAS Accreditation.

Results of tests not covered by our UKAS Accreditation Schedule are marked NUA (Not UKAS Accredited).

© 2020 TÜV SÜD



ANNEX A

MODULE LIST



Configuration A and B			
Product	Product No	R-State	Serial No
Radio 2217 B5	KRC 161 566/2	R1E	CD3X367474
Software Version:	CXP 901 3268/9	Revision:	R77ZT