



Add value.
Inspire trust.



Report On

FCC and ISED Testing of the Ericsson Remote Radio Unit RRUS 32 B30, KRC 161 423/1, NR (2300 MHz), with compatible Main Unit in a Base Station configuration in accordance with FCC CFR 47 Part 2, FCC CFR 47 Part 27, ISED RSS-GEN and Industry Canada RSS-195

COMMERCIAL-IN-CONFIDENCE

FCC: TA8AKRC161423-1
ISED ID: 287AB-AS1614231

PREPARED BY

APPROVED BY

DATED

Handwritten signature of Maggie Whiting in black ink.

Maggie Whiting
Key Account Manager

Handwritten signature of Steve Scarfe in black ink.

Steve Scarfe
Authorised Signatory

16 November 2020

Document 75950227 Report 01 Issue 1

November 2020



CONTENTS

Section	Page No
1	REPORT INFORMATION 2
1.1	Report Details 3
1.2	Brief Summary of Results 4
1.3	Configuration Description 5
1.4	Declaration of Build Status 6
1.5	Product Information 7
1.6	Test Setup 8
1.7	Test Conditions 9
1.8	Deviation From The Standard 9
1.9	Modification Record 9
2	TEST DETAILS 10
2.1	Maximum Peak Output Power and Peak to Average Ratio - Conducted 11
2.2	Occupied Bandwidth 15
2.3	Band Edge 18
2.4	Transmitter Spurious Emissions 21
3	TEST EQUIPMENT USED 32
3.1	Test Equipment Used 33
3.2	Measurement Uncertainty 35
4	ACCREDITATION, DISCLAIMERS AND COPYRIGHT 36
4.1	Accreditation, Disclaimers and Copyright 37
ANNEX A	Module Lists A.2



SECTION 1

REPORT INFORMATION



1.1 REPORT DETAILS

Manufacturer	Ericsson AB
Address	Torshamnsgatan 23 Kista SE-16480 Stockholm Sweden
Product Name & Product Number	RRUS 32 B30 & KRC 161 423/1
IC Model Name	AS1614231
Serial Number(s)	CF84039913
Software Version	CXP9013268/12 Rev R79EM
Hardware Version	R1D
Test Specification/Issue/Date	FCC CFR 47 Part 2: 2019 FCC CFR 47 Part 27: 2019 ISED RSS-GEN: Issue 5: March 2019 Amendment 1 Industry Canada RSS-195: Issue 2: April 2014
Test Plan	Q4 FCC_IC test plan for NR legacy
Start of Test	10 November 2020
Finish of Test	13 November 2020
Name of Engineer(s)	Neil Rousell
Related Document(s)	KDB 971168 D01 v02r02 KDB 662911 D01 v02r01

ENGINEERING STATEMENT

The measurements shown in this report were made in accordance with the procedures described on test pages. All reported testing was carried out on a sample equipment to demonstrate compliance with FCC CFR 47 Part 2: 2019, FCC CFR 47 Part 27: 2019, ISED RSS-GEN: Issue 5: March 2019 Amendment 1, Industry Canada RSS-195: Issue 2: April 2014 The sample tested was found to comply with the requirements defined in the applied rules.

Test Engineer(s);

Neil Rousell



1.2 BRIEF SUMMARY OF RESULTS

A brief summary of results for each configuration, in accordance with FCC CFR 47 Part 2, FCC CFR 47 Part 27, ISED RSS-GEN and Industry Canada RSS-195 is shown below.

Section	Specification Clause				Test Description	Result
	FCC CFR 47 Part 2	FCC CFR 47 Part 27	RSS-GEN	RSS-195		
-	-	-	-		Equivalent Isotropically Radiated Power (EIRP)	N/A ¹
2.1	2.1046	27.50	-	5.5	Maximum Peak Output Power and Peak to Average Ratio - Conducted	Pass
2.2	2.1049	27.53	6.6	-	Occupied Bandwidth	Pass
2.3	2.1051	27.53 (h)	-	5.6	Band Edge	Pass
2.4	2.1051	27.53 (h)	-	5.6	Transmitter Spurious Emissions	Pass

N/A¹ – Not Applicable, due to no integral antenna

N/A – Not Applicable

This unit was tested without an antenna. ERP/EIRP compliance is addressed at the time of licensing, as required by the responsible IC Bureau(s). Licensees are required to take into account the maximum allowed antenna gain used in combination with the power settings to prevent the radiated output power exceeding the limits.



1.3 CONFIGURATION DESCRIPTION

Configuration	RAT	No. Of carriers	Carrier Bandwidth	Carrier Frequency Configuration (MHz)		
				Bottom	Middle	Top
A1	NR	1	5 MHz – SCS 15kHz	2352.5	2355.0	2357.5
	NR	1	10 MHz – SCS 15kHz	-	2355.0	-



1.4 DECLARATION OF BUILD STATUS

MAIN EUT	
MANUFACTURING DESCRIPTION	Radio Unit
MANUFACTURER	Ericsson AB
PRODUCT NAME	RRUS 30 B30
PART NUMBER	KRC161423/1
IC MODEL NAME	AS1614231
SERIAL NUMBER	CF84039913
HARDWARE VERSION	R1D
SOFTWARE VERSION	CXP9013268/12 Rev R79EM
TRANSMITTER OPERATING RANGE	B30: 2350-2360 MHz (DL) 2305-2315 (UL)
MODULATIONS	LTE & NR: QPSK, 16QAM, 64QAM, 256QAM
ITU DESIGNATION OF EMISSION	LTE 5 MHz BW channel: 5M00F9W
	LTE 10 MHz BW channel: 10M0F9W
	NR 5 MHz BW channel: 4M47W7D
	NR 10 MHz BW channel: 9M28W7D
OUTPUT POWER (RMS) (W or dBm)	4 ports, 25W per port
FCC ID	TA8AKRC161752-1
IC ID	287AB-AS1617521
TECHNICAL DESCRIPTION (a brief description of the intended use and operation)	Base station radio

Signature *Faysal Pirmohamed*

Faysal Pirmohamed

Date 2020-11-16

No responsibility will be accepted by TÜV SÜD Product Service UK Limited as to the accuracy of the information declared in this document by the manufacturer

1.5 PRODUCT INFORMATION

1.5.1 Technical Description

The Equipment Under Test (EUT) RRUS 32 B30 is an Ericsson AB Radio Unit working in the public mobile service 2300 MHz band which provides communication connections to 2300 MHz network. The RRUS 32 B30 operates from a -48V DC supply.

The Equipment Under Test (EUT) is shown in the photograph below. A full technical description can be found in the Manufacturer's documentation.

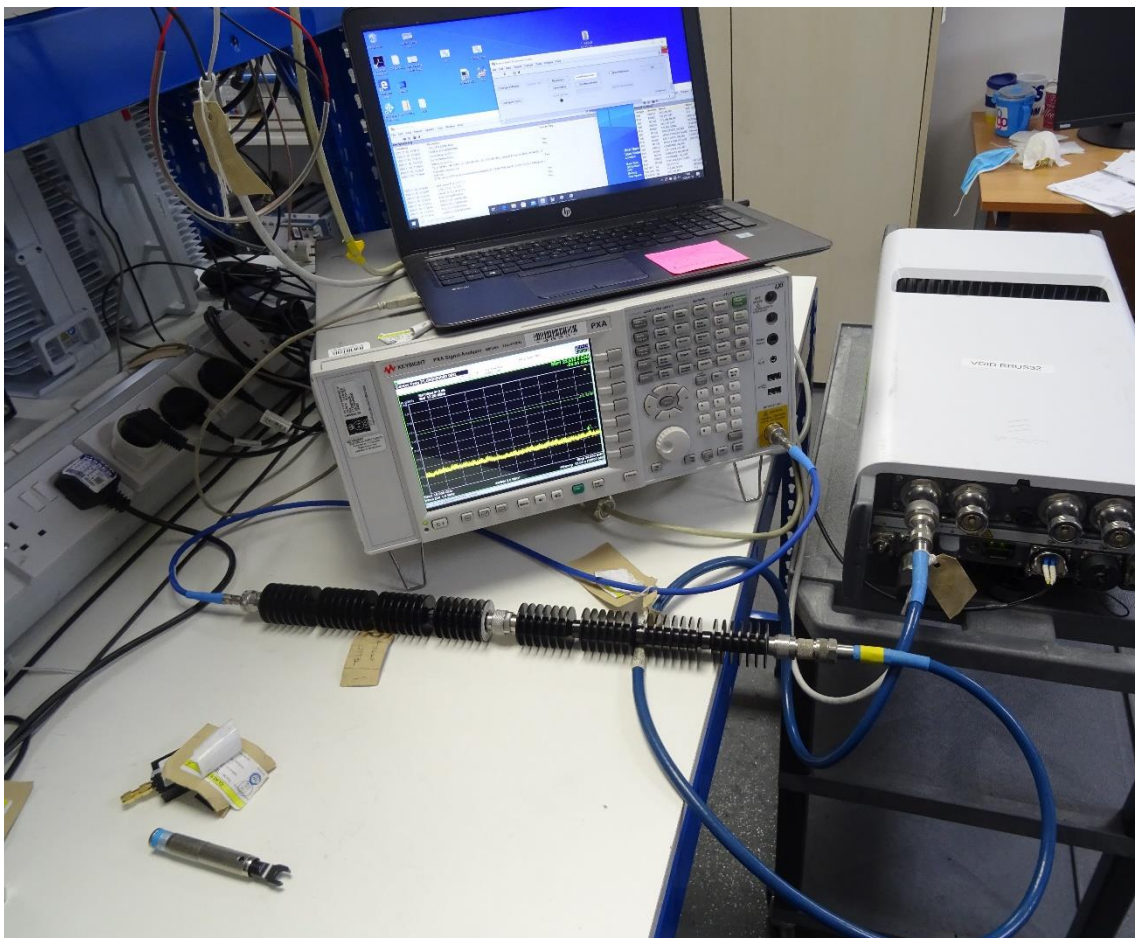

Equipment Under Test



1.6 TEST SETUP

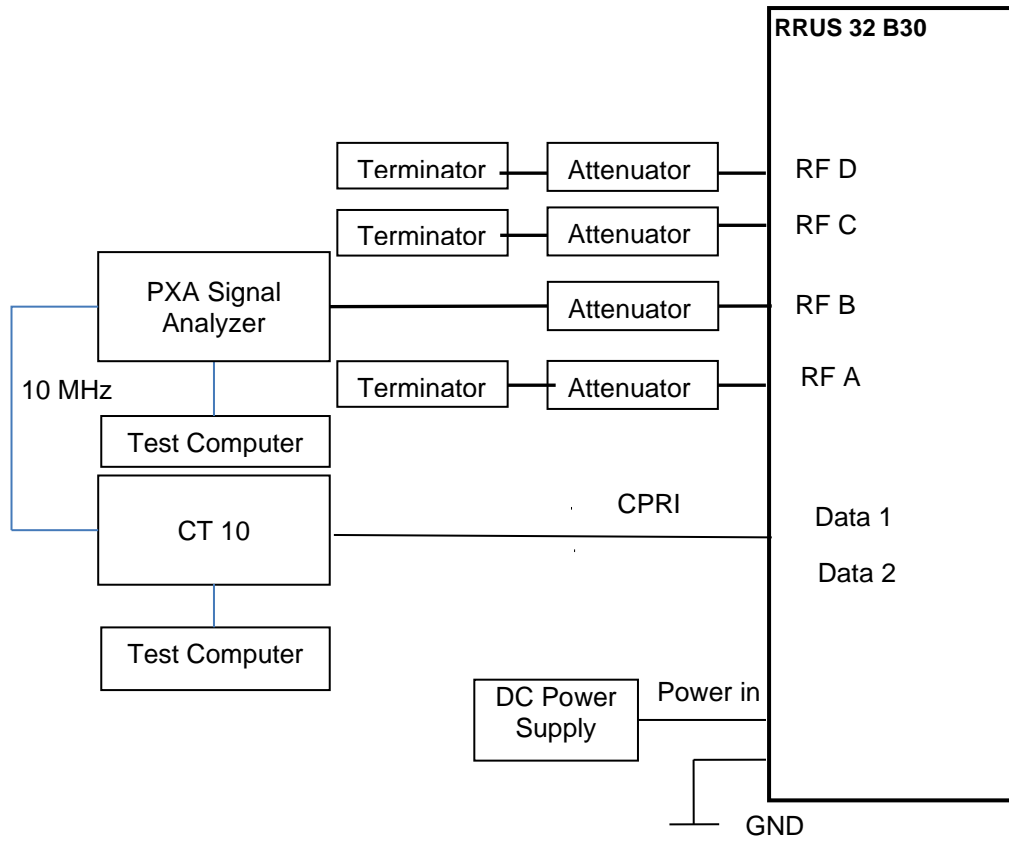



1.7 TEST CONDITIONS

For all tests the EUT was set up in accordance with the relevant test standard and to represent typical operating conditions. Tests were applied with the EUT situated as described in the Test Method for each Test.

The EUT was powered from a -48V DC supply.

FCC Measurement Facility Registration Number
90987 Octagon House, Fareham Test Laboratory

ISED Accreditation
ISED#12669A Octagon House, Fareham Test Laboratory

Test Name	Name of Engineer(s)
Maximum Peak Output Power and Peak to Average Ratio - Conducted	Neil Rousell
Occupied Bandwidth	Neil Rousell
Band Edge	Neil Rousell
Transmitter Spurious Emissions	Neil Rousell

1.8 DEVIATION FROM THE STANDARD

No deviations from the applicable test standards or test plan were made during testing.

1.9 MODIFICATION RECORD

No modifications were made to the EUT during testing.



SECTION 2

TEST DETAILS



2.1 MAXIMUM PEAK OUTPUT POWER AND PEAK TO AVERAGE RATIO - CONDUCTED

2.1.1 Specification Reference

FCC CFR 47 Part 2, Clause 2.1046
 FCC CFR 47 Part 27, Clause 27.50
 Industry Canada RSS-195, Clause 5.5

2.1.2 Date of Test and Modification State

11 October 2020 - Modification State 0

2.1.3 Test Equipment Used

The major items of test equipment used for the above tests are identified in Section 3.1.

2.1.4 Environmental Conditions

Ambient Temperature 23.4°C
 Relative Humidity 53.0%

2.1.5 Test Method

All measurements were made in accordance with FCC KDB 971168 D01, clause 5.2.1 and summed in accordance with FCC KDB 662911 D01.

2.1.6 Test Results

Configuration A1

Maximum Output Power 44 dBm

Antenna	NR Modulation	NR Carrier Bandwidth	Peak to Average Ratio (PAR) / Output Power			
			Channel Position B			Total Power Ports A + B
			PAR (dB)	Average Power		
	dBm	dBm/MHz		dBm		
A	QPSK	5.0 MHz 15 kHz SCS	7.15	43.82	37.84	46.83

Remarks

Calculations: Total power = measured output power (port A, worst case) + 10log (2) and PSD = measured output power – (10*log(OBW/1MHz)).



Antenna A - NR Modulation QPSK - NR Carrier Bandwidth 5.0 MHz 15 kHz SCS - Channel Position B

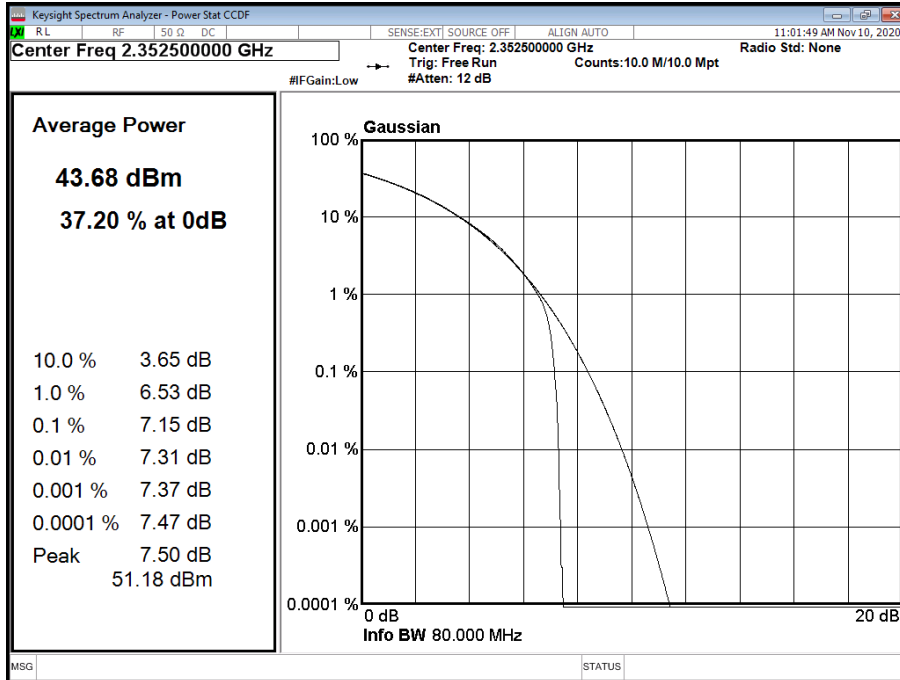

Configuration A1

Maximum Output Power 44 dBm

Antenna	NR Modulation	NR Carrier Bandwidth	Peak to Average Ratio (PAR) / Output Power			
			Channel Position M			Total Power Ports A + B
			PAR (dB)	Average Power		
				dBm	dBm/MHz	dBm
A	QPSK	5.0 MHz 15 kHz SCS	7.12	43.84	37.87	46.85
A	QPSK	10.0 MHz 15 kHz SCS	7.15	43.71	35.20	46.72

Remarks

Calculations: Total power = measured output power (port A, worst case) + 10log (2) and PSD = measured output power – (10*log(OBW/1MHz)).



Antenna A - NR Modulation QPSK - NR Carrier Bandwidth 5.0 MHz 15 kHz SCS - Channel Position M

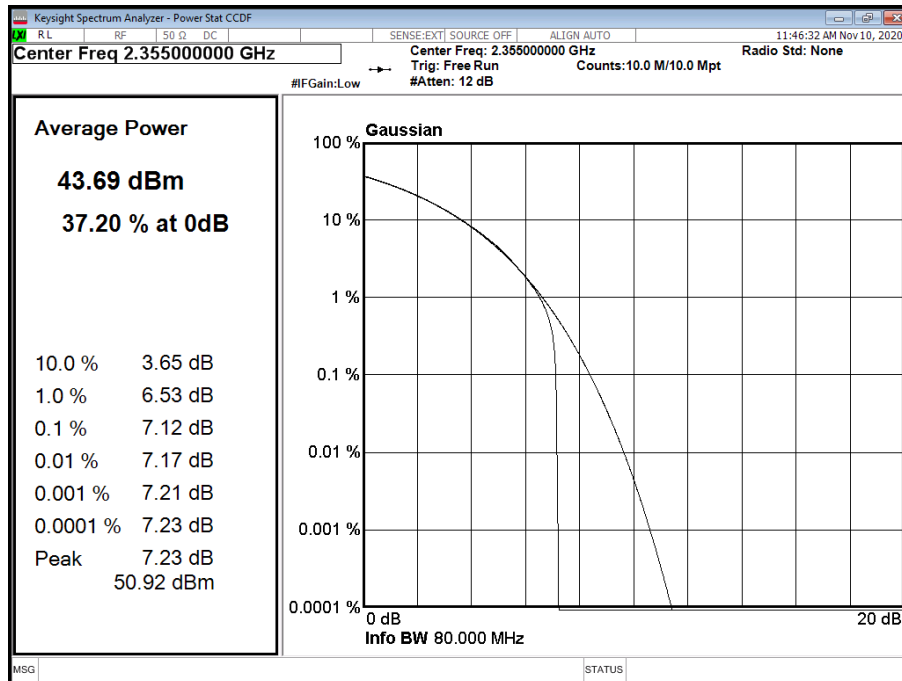

Antenna A - NR Modulation QPSK - NR Carrier Bandwidth 10.0 MHz 15 kHz SCS - Channel Position M

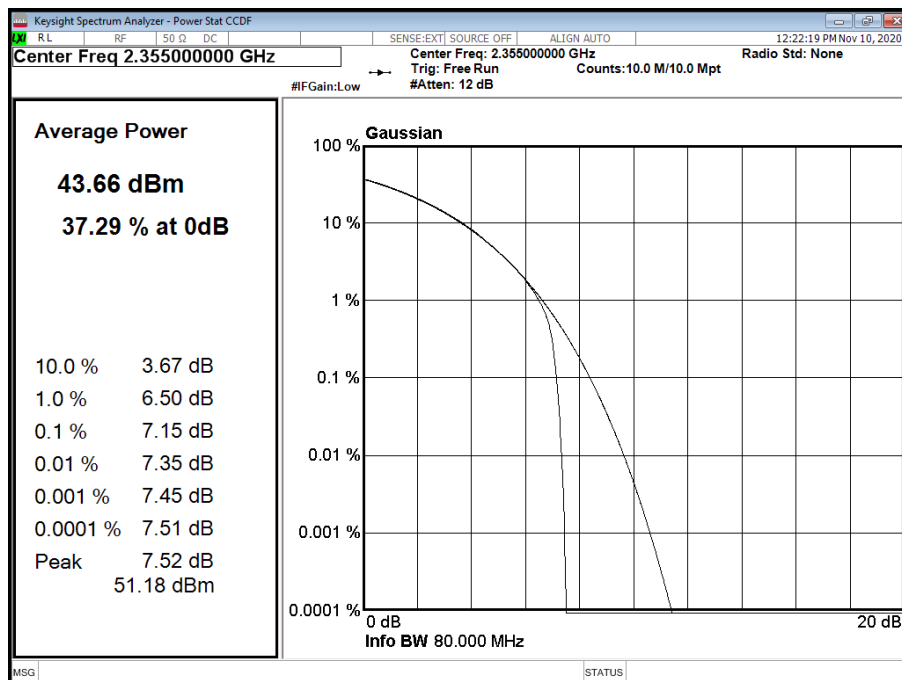



Configuration A1

Maximum Output Power 44 dBm

Antenna	NR Modulation	NR Carrier Bandwidth	Peak to Average Ratio (PAR) / Output Power			
			Channel Position T			
			PAR (dB)	Average Power		Total Power Ports A + B
dBm	dBm/MHz	dBm				
A	QPSK	5.0 MHz 15 kHz SCS	7.17	43.64	37.67	46.65

Remarks

Calculations: Total power = measured output power (port A, worst case) + 10log (2) and PSD = measured output power – (10*log(OBW/1MHz)).

Antenna A - NR Modulation QPSK - NR Carrier Bandwidth 5.0 MHz 15 kHz SCS - Channel Position T

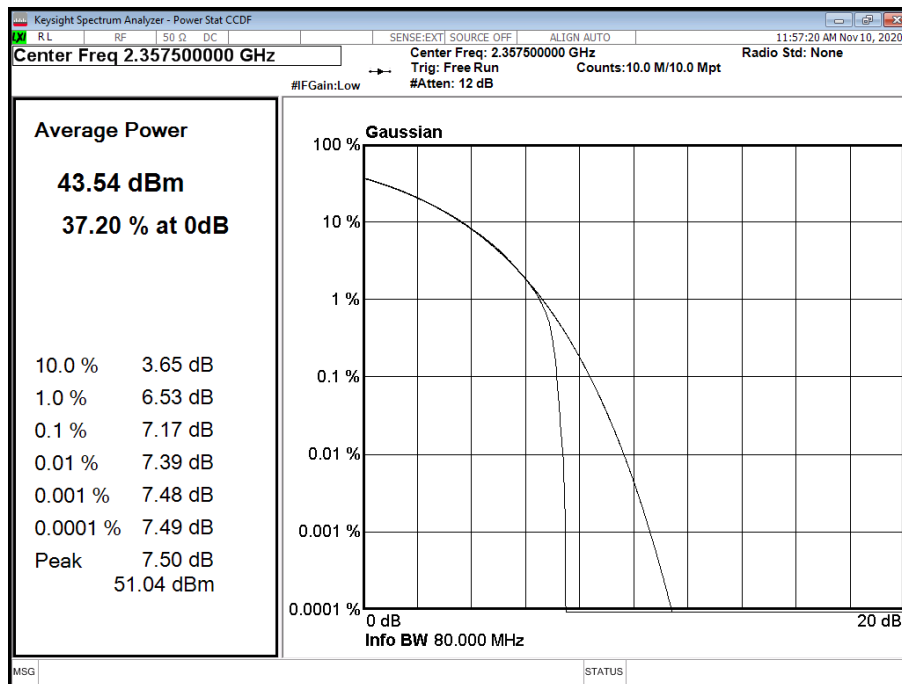

Limit	
Peak Power	≤ 1640 W/MHz or ≤+62.15 dBm
Peak to Average Ratio	13 dB

The radio unit was tested with maximum output power and without an antenna. ERP/EIRP compliance is addressed at the time of licensing, as required by the responsible FCC/ISED Bureau(s). Licensees are required to take into account maximum allowed antenna gain used in combination with the above power settings to prevent the radiated output power exceeding the limits.



2.2 OCCUPIED BANDWIDTH

2.2.1 Specification Reference

FCC CFR 47 Part 2, Clause 2.1049
 FCC CFR 47 Part 27, Clause 27.53
 ISSED RSS-GEN, Clause 6.6

2.2.2 Date of Test and Modification State

11 October 2020 - Modification State 0

2.2.3 Test Equipment Used

The major items of test equipment used for the above tests are identified in Section 3.1.

2.2.4 Environmental Conditions

Ambient Temperature 23.4°C
 Relative Humidity 53.0%

2.2.5 Test Method

All measurements were made in accordance with FCC KDB 971168 D01.

2.2.6 Test Results

Configuration A1

Maximum Output Power 44 dBm

Antenna	NR Modulation	NR Carrier Bandwidth	Result (KHz)					
			Channel Position B		Channel Position M		Channel Position T	
			Occupied Bandwidth	-26 dB Bandwidth	Occupied Bandwidth	-26 dB Bandwidth	Occupied Bandwidth	-26 dB Bandwidth
A	QPSK	5.0 MHz 15 kHz SCS	4,471.48	4,826.81	4,467.76	4,828.70	4,469.94	4,836.38
A	QPSK	10.0 MHz 15 kHz SCS	-	-	9,279.43	9,745.95	-	-



Antenna A - NR Modulation QPSK - NR Carrier Bandwidth 5.0 MHz 15 kHz SCS - Channel Position B

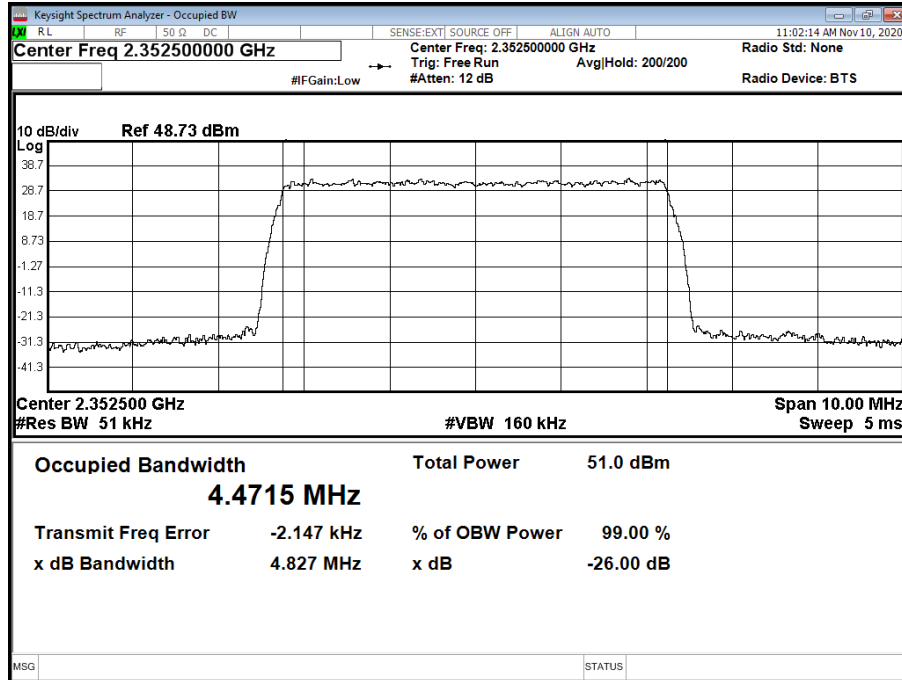

Antenna A - NR Modulation QPSK - NR Carrier Bandwidth 5.0 MHz 15 kHz SCS - Channel Position M

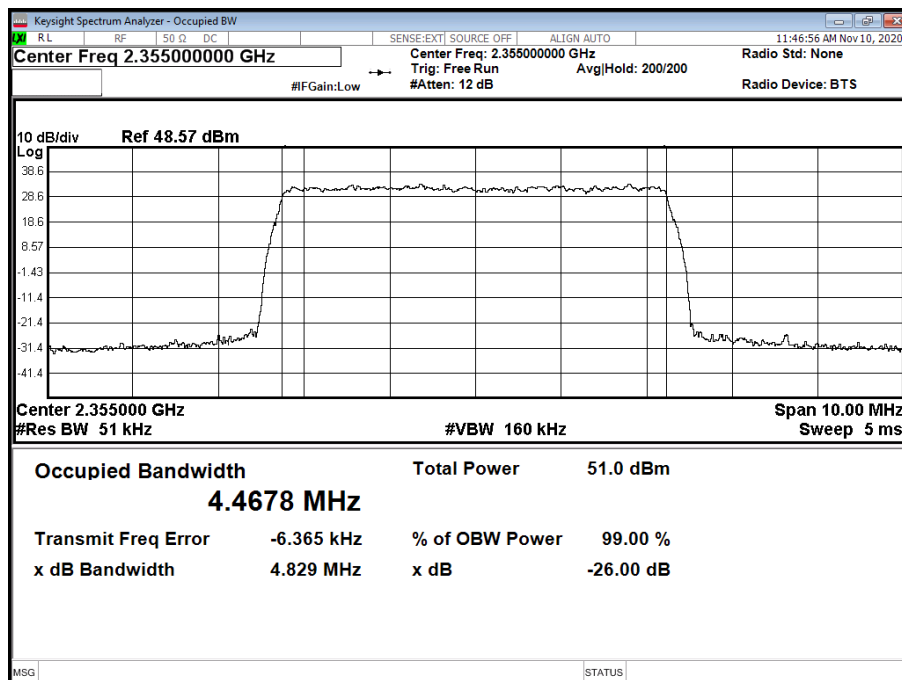



Antenna A - NR Modulation QPSK - NR Carrier Bandwidth 5.0 MHz 15 kHz SCS - Channel Position T

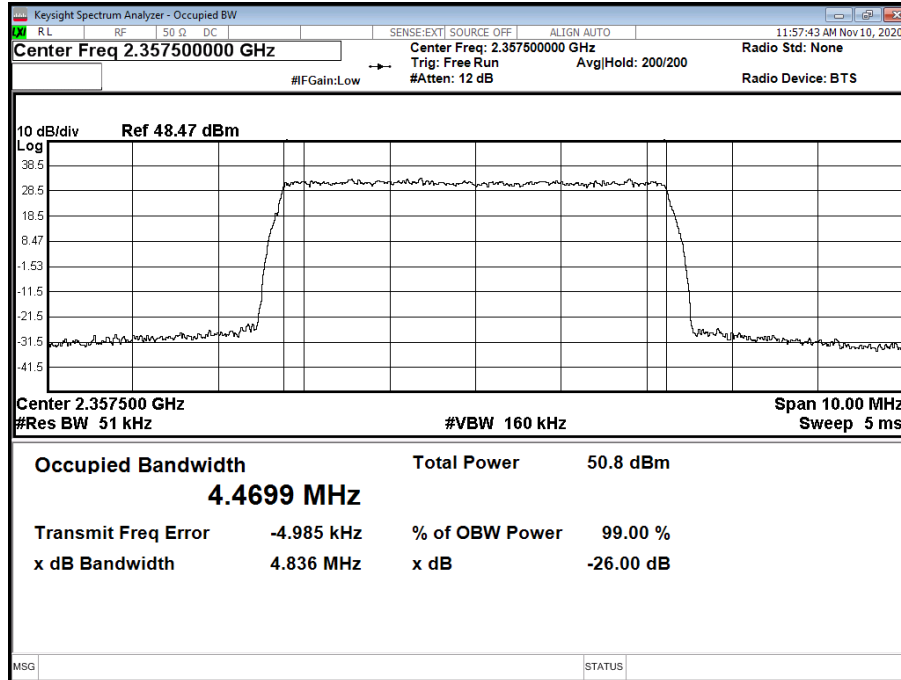

Antenna A - NR Modulation QPSK - NR Carrier Bandwidth 10.0 MHz 15 kHz SCS - Channel Position M

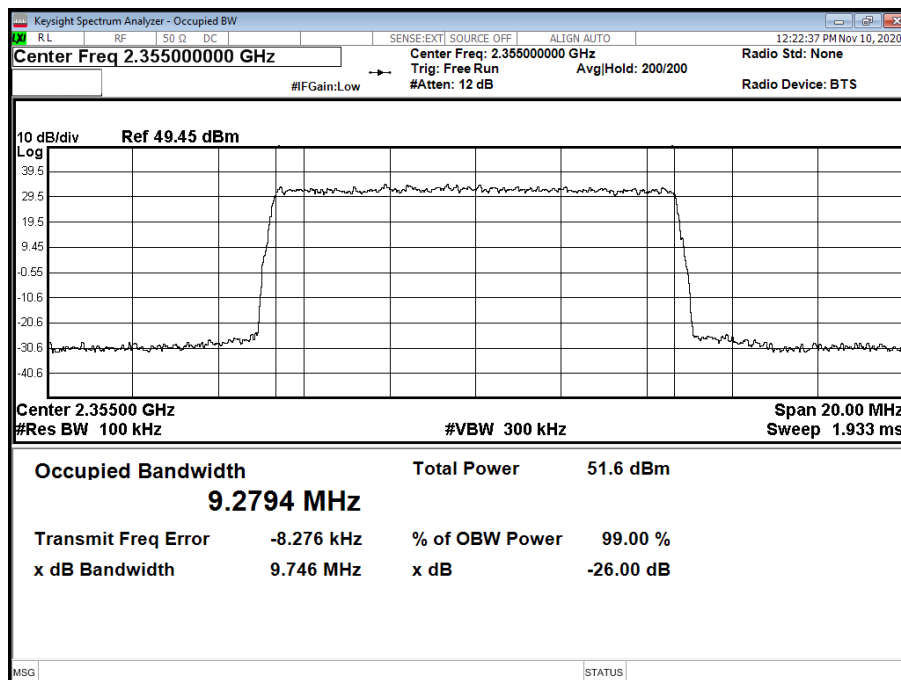



2.3 BAND EDGE

2.3.1 Specification Reference

FCC CFR 47 Part 2, Clause 2.1051
FCC CFR 47 Part 27, Clause 27.53 (h)
Industry Canada RSS-195, Clause 5.6

2.3.2 Date of Test and Modification State

13 November 2020 - Modification State 0

2.3.3 Test Equipment Used

The major items of test equipment used for the above tests are identified in Section 3.1.

2.3.4 Environmental Conditions

Ambient Temperature 23.7°C
Relative Humidity 45.3%

2.3.5 Test Method

All measurements were made in accordance with FCC KDB 971168 D01.

Each antenna port has been declared as being equivalent, therefore measurements were made on one antenna port only. To account for this, the limit was tightened by $10 * \text{Log}(N)$, where N is equal to the number of MIMO antenna ports.

For dual port, the limit was calculated as being $-13 \text{ dBm} - 10 * \text{Log}(2) = -16 \text{ dBm}$.

2.3.6 Test Results

Configuration A1

Maximum Output Power 44 dBm

Antenna	NR Modulation	NR Carrier Bandwidth	Band Edge (MHz)	
			Channel Position B	Channel Position T
A	QPSK	5.0 MHz 15 kHz SCS	2,352.5	2,357.5
A	QPSK	10.0 MHz 15 kHz SCS	2,355.0	2,355.0



Antenna A - NR Modulation QPSK - NR Carrier Bandwidth 5.0 MHz 15 kHz SCS - Channel Position B

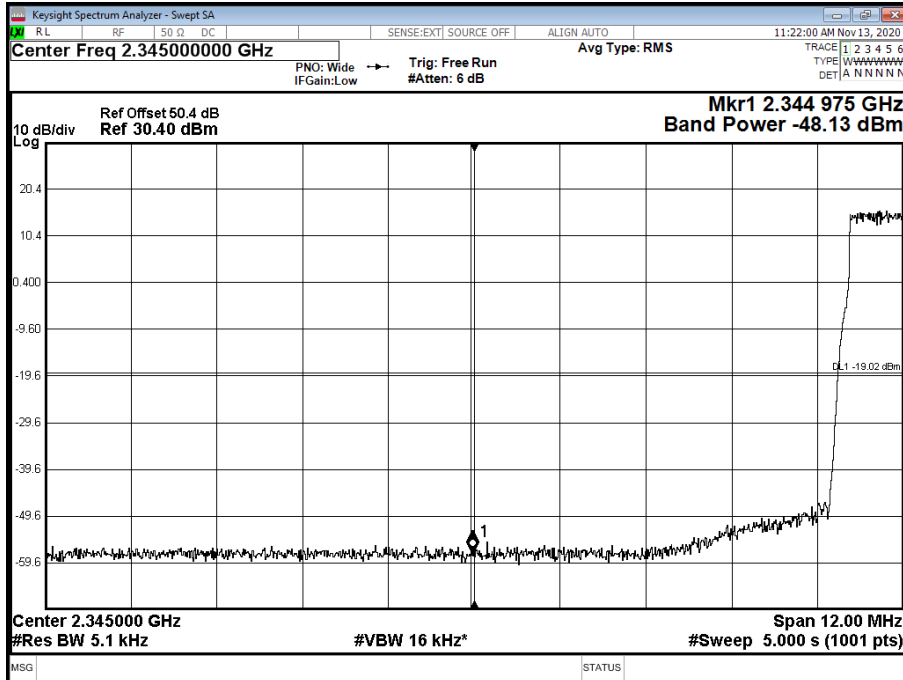

Antenna A - NR Modulation QPSK - NR Carrier Bandwidth 5.0 MHz 15 kHz SCS - Channel Position T

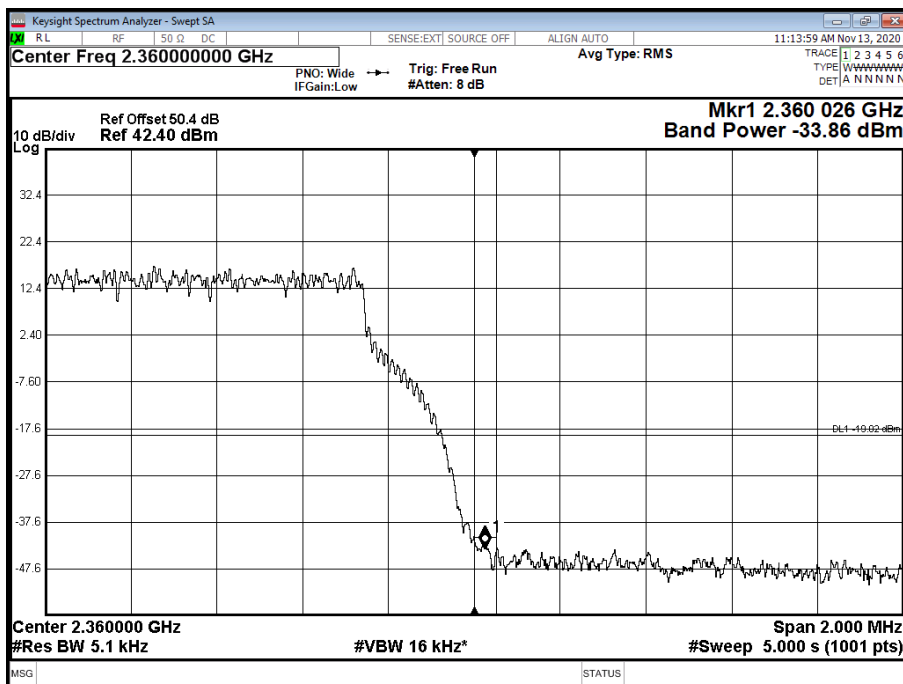



Antenna A - NR Modulation QPSK - NR Carrier Bandwidth 10.0 MHz 15 kHz SCS - Channel Position B

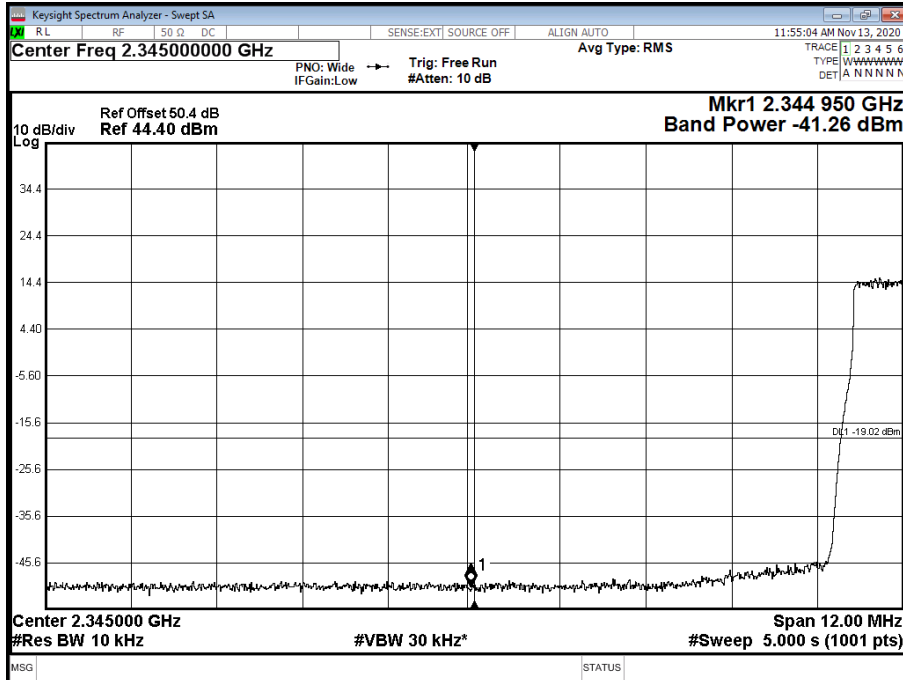

Antenna A - NR Modulation QPSK - NR Carrier Bandwidth 10.0 MHz 15 kHz SCS - Channel Position T

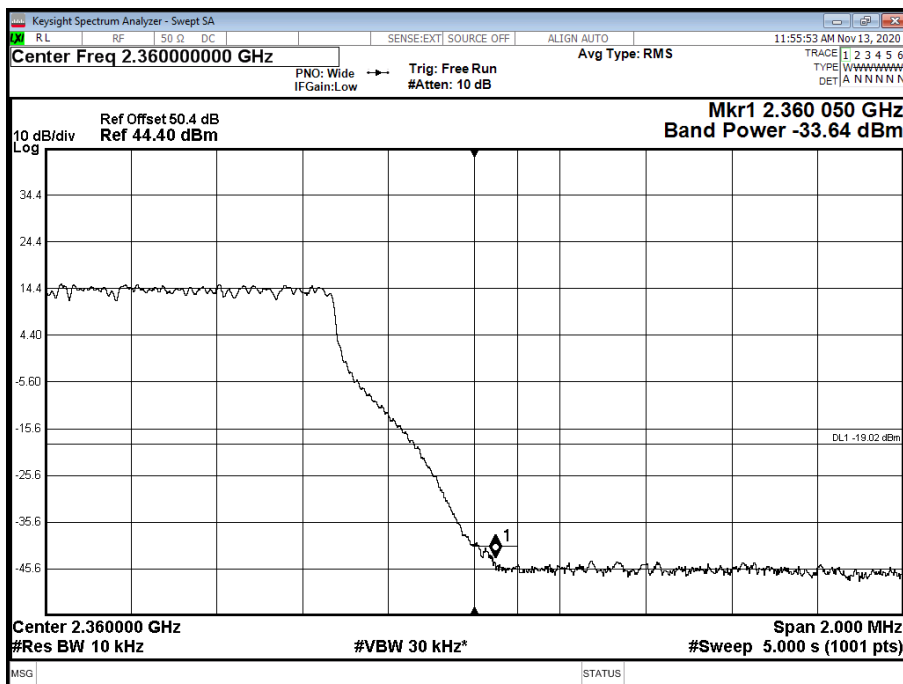

Limit	-16 dBm
-------	---------



2.4 TRANSMITTER SPURIOUS EMISSIONS

2.4.1 Specification Reference

FCC CFR 47 Part 2, Clause 2.1051
FCC CFR 47 Part 27, Clause 27.53 (h)
Industry Canada RSS-195, Clause 5.6

2.4.2 Date of Test and Modification State

13 November 2020 - Modification State 0

2.4.3 Test Equipment Used

The major items of test equipment used for the above tests are identified in Section 3.1.

2.4.4 Environmental Conditions

Ambient Temperature	23.7°C
Relative Humidity	45.3%

2.4.5 Test Method

All measurements were made in accordance with FCC KDB 971168 D01.

Each antenna port has been declared as being equivalent, therefore measurements were made on one antenna port only. To account for this, the limit was tightened by $10 * \text{Log}(N)$, where N is equal to the number of MIMO antenna ports.

For dual port, the limit was calculated as being $-13 \text{ dBm} - 10 * \text{Log}(2) = -16 \text{ dBm}$.

2.4.6 Test Results

Configuration A1

Maximum Output Power 44 dBm



Antenna A - NR Modulation QPSK - NR Carrier Bandwidth 5.0 MHz 15 kHz SCS - Channel Position B - Band 1 - Range 0.009 to 4500 MHz

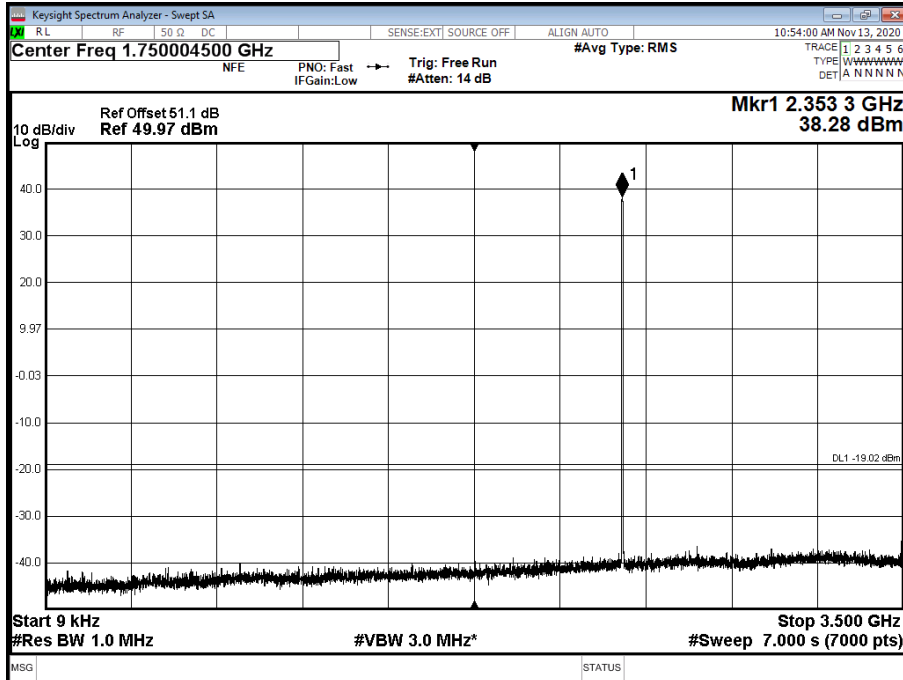

Antenna A - NR Modulation QPSK - NR Carrier Bandwidth 5.0 MHz 15 kHz SCS - Channel Position B - Band 2 - Range 4500 to 8000 MHz

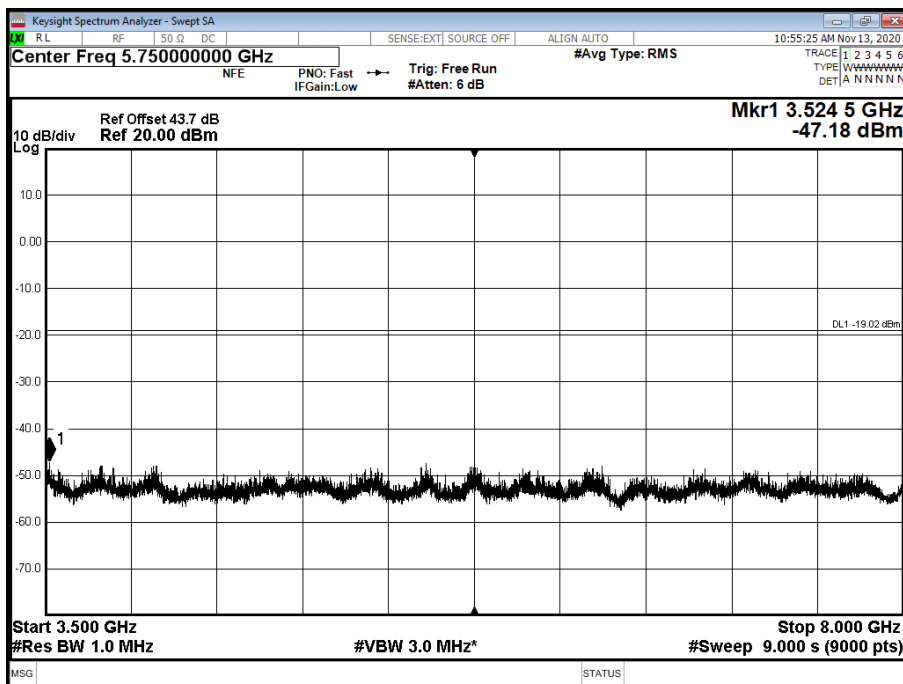



Antenna A - NR Modulation QPSK - NR Carrier Bandwidth 5.0 MHz 15 kHz SCS - Channel Position B - Band 3 - Range 8000 to 12000 MHz

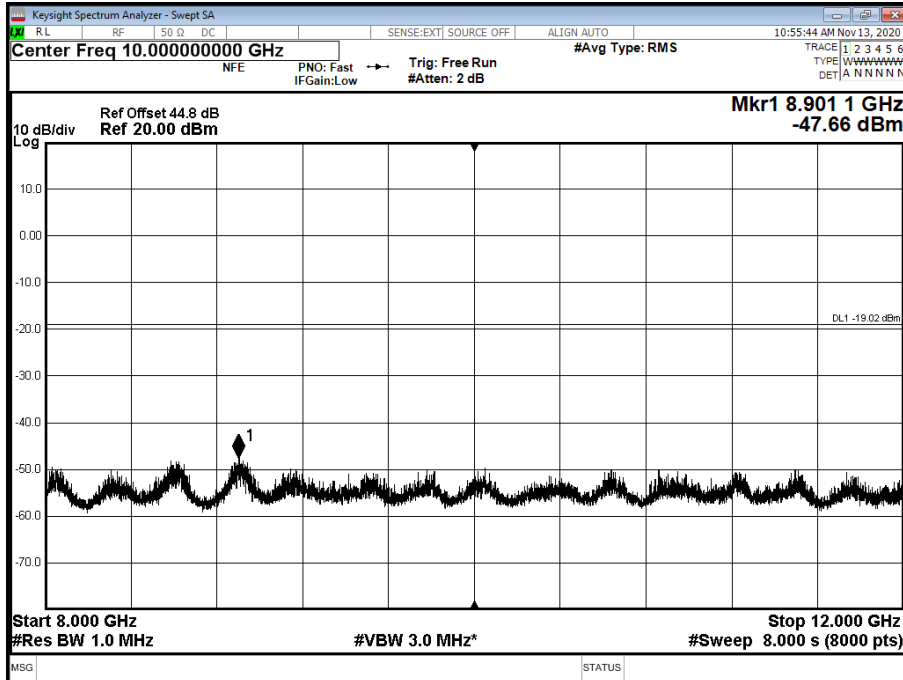

Antenna A - NR Modulation QPSK - NR Carrier Bandwidth 5.0 MHz 15 kHz SCS - Channel Position B - Band 4 - Range 12000 to 18000 MHz

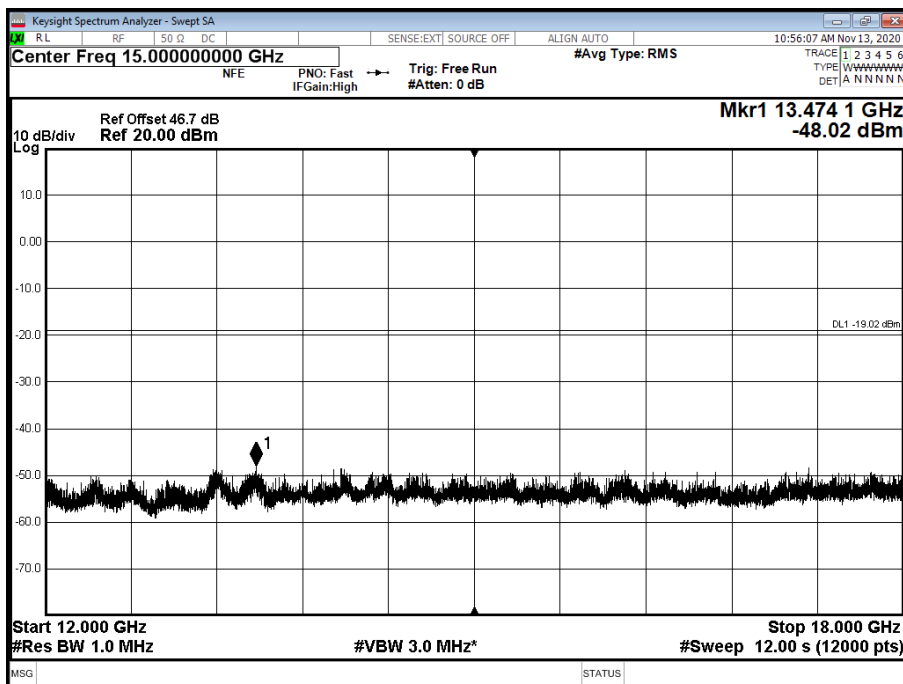



Antenna A - NR Modulation QPSK - NR Carrier Bandwidth 5.0 MHz 15 kHz SCS - Channel Position B - Band 5 - Range 18000 to 24000 MHz

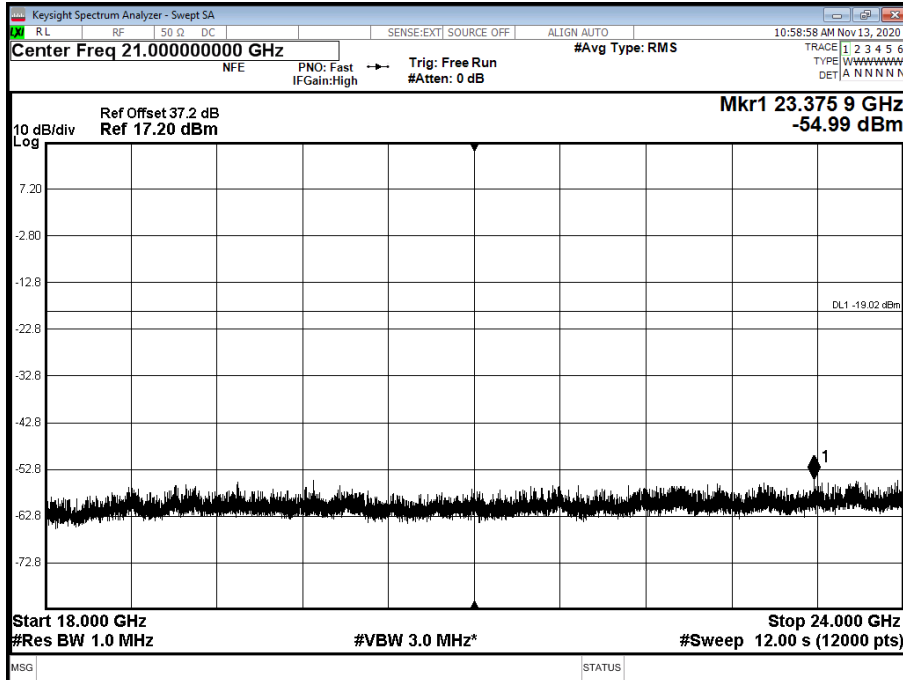

Antenna A - NR Modulation QPSK - NR Carrier Bandwidth 5.0 MHz 15 kHz SCS - Channel Position M - Band 1 - Range 0.009 to 4500 MHz

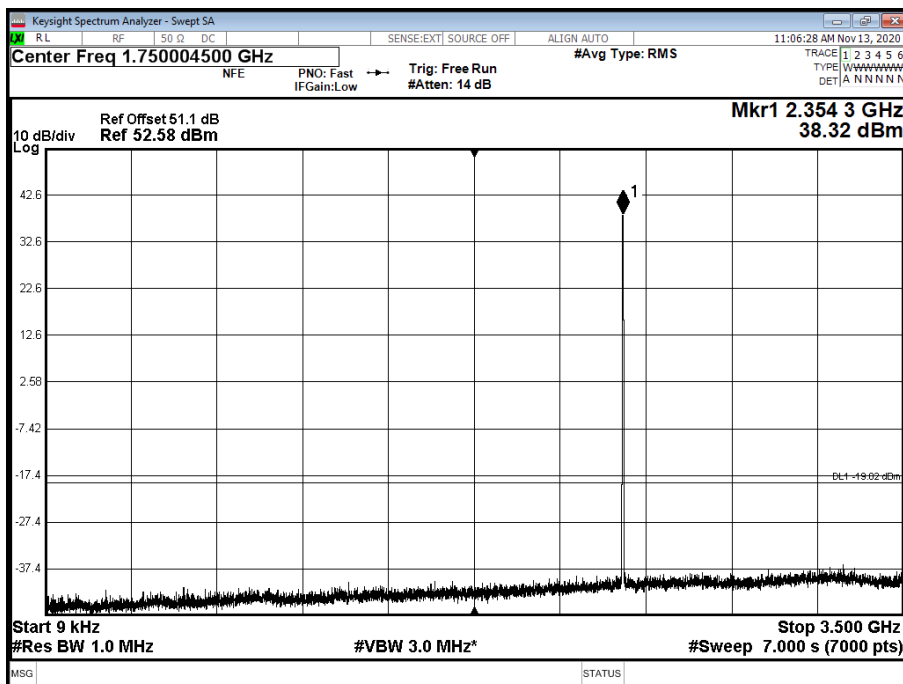



Antenna A - NR Modulation QPSK - NR Carrier Bandwidth 5.0 MHz 15 kHz SCS - Channel Position M - Band 2 - Range 4500 to 8000 MHz

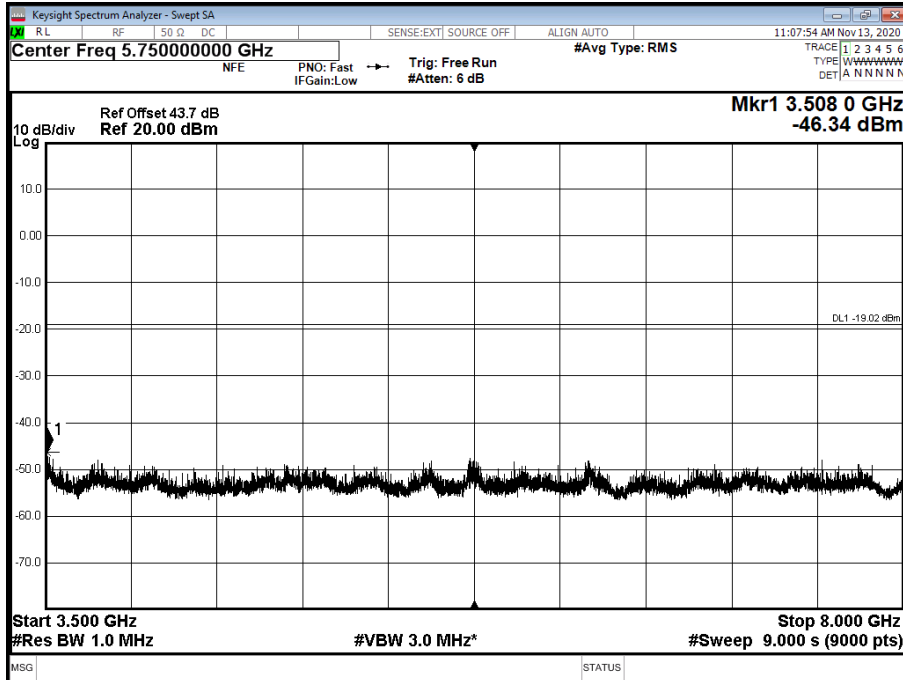

Antenna A - NR Modulation QPSK - NR Carrier Bandwidth 5.0 MHz 15 kHz SCS - Channel Position M - Band 3 - Range 8000 to 12000 MHz

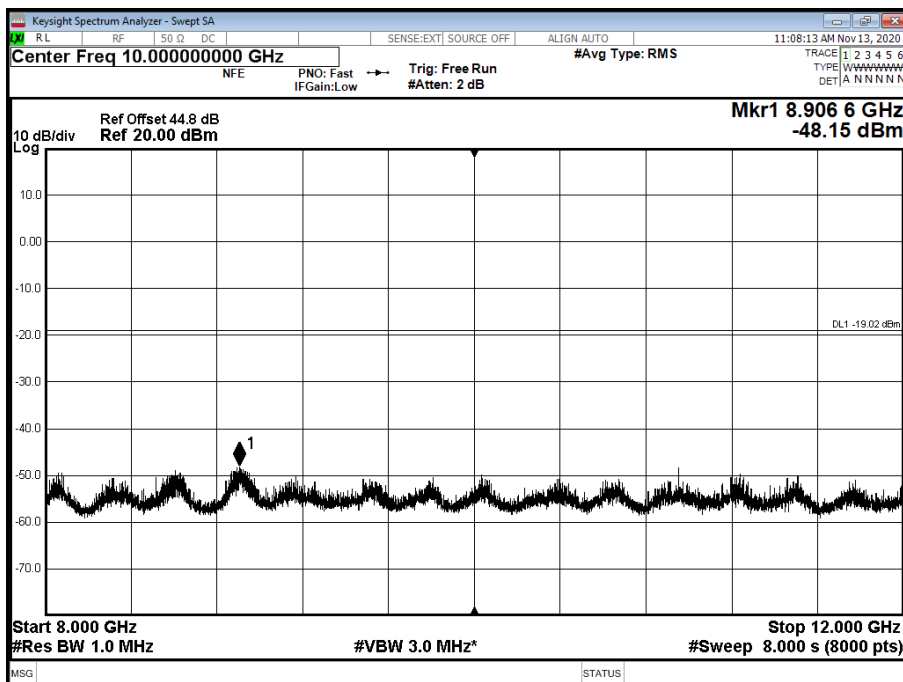



Antenna A - NR Modulation QPSK - NR Carrier Bandwidth 5.0 MHz 15 kHz SCS - Channel Position M - Band 4 - Range 12000 to 18000 MHz

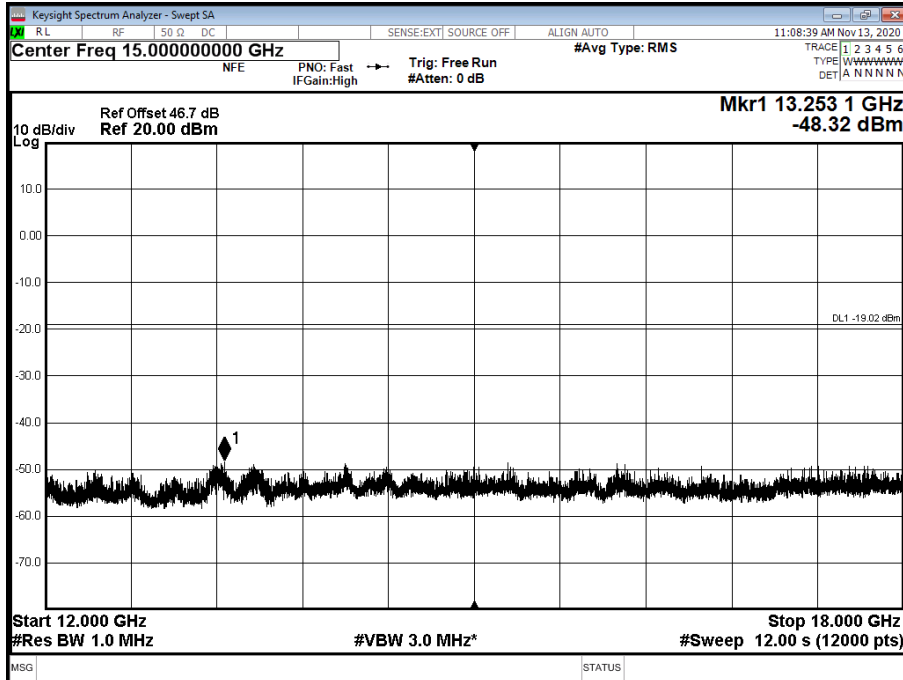

Antenna A - NR Modulation QPSK - NR Carrier Bandwidth 5.0 MHz 15 kHz SCS - Channel Position M - Band 5 - Range 18000 to 24000 MHz

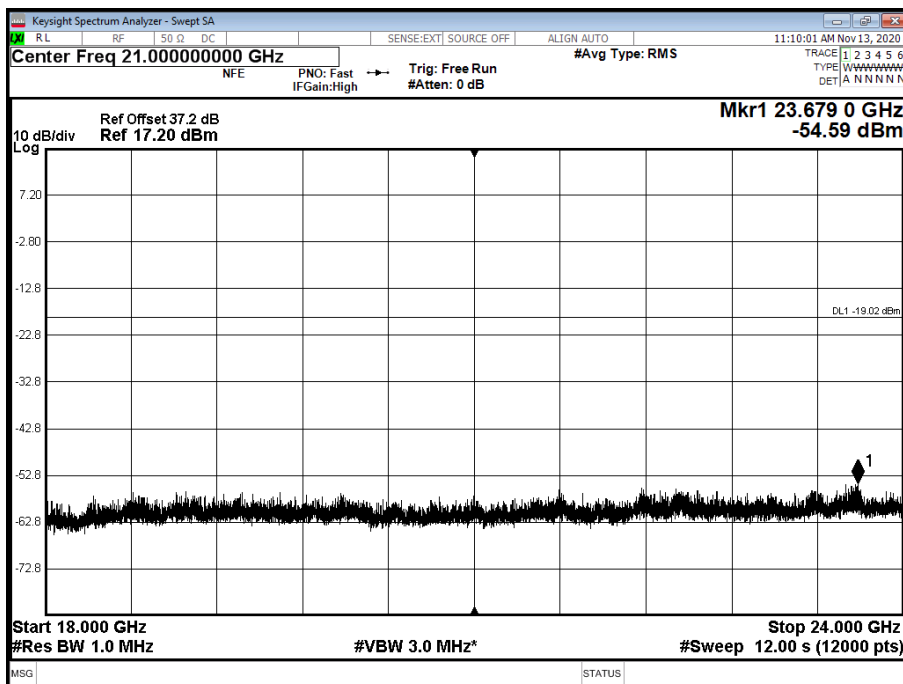



Antenna A - NR Modulation QPSK - NR Carrier Bandwidth 5.0 MHz 15 kHz SCS - Channel Position T - Band 1 - Range 0.009 to 4500 MHz

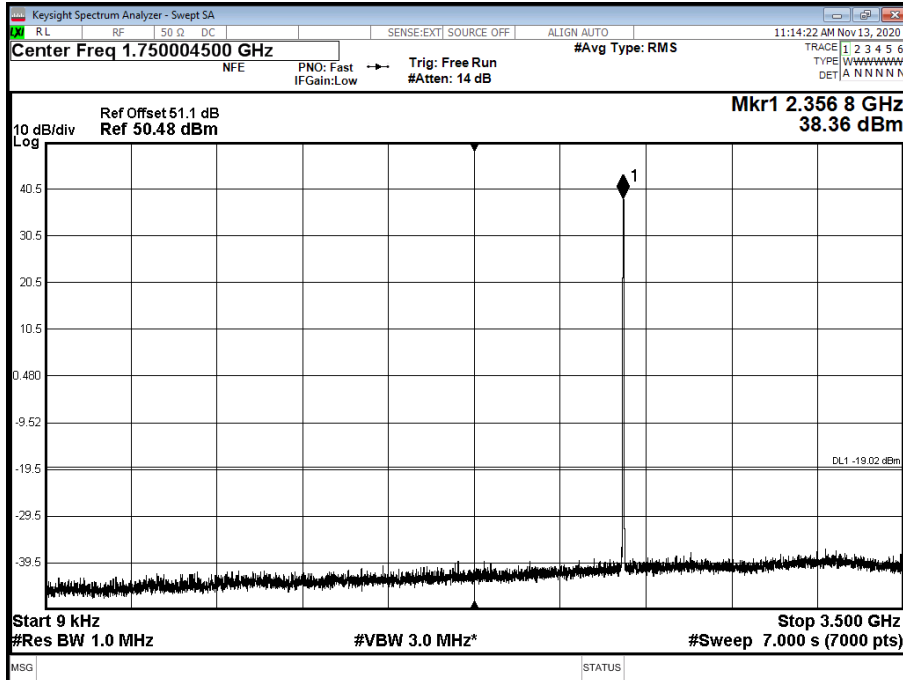

Antenna A - NR Modulation QPSK - NR Carrier Bandwidth 5.0 MHz 15 kHz SCS - Channel Position T - Band 2 - Range 4500 to 8000 MHz

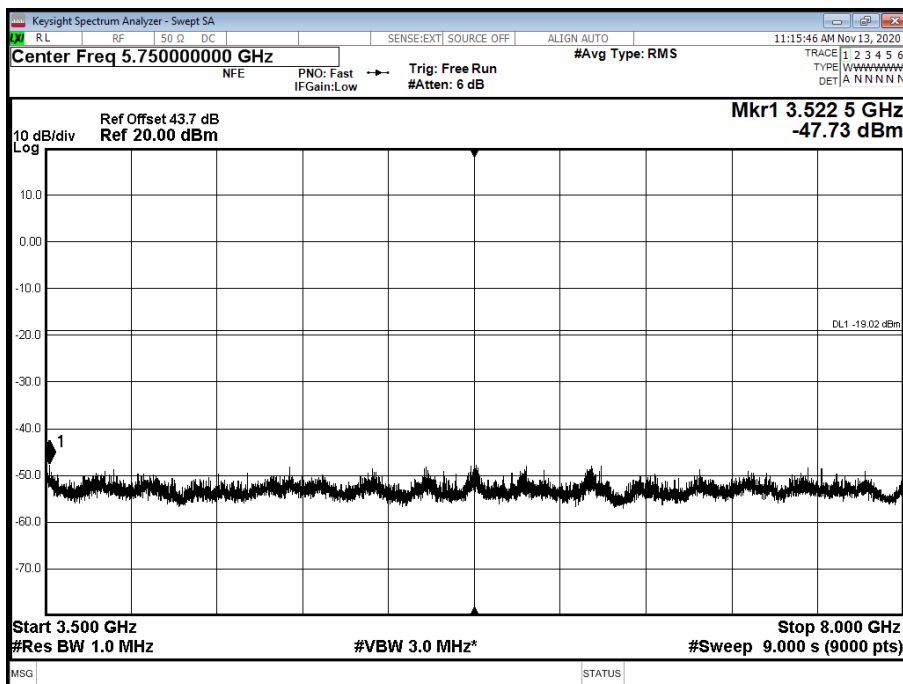



Antenna A - NR Modulation QPSK - NR Carrier Bandwidth 5.0 MHz 15 kHz SCS - Channel Position T - Band 3 - Range 8000 to 12000 MHz

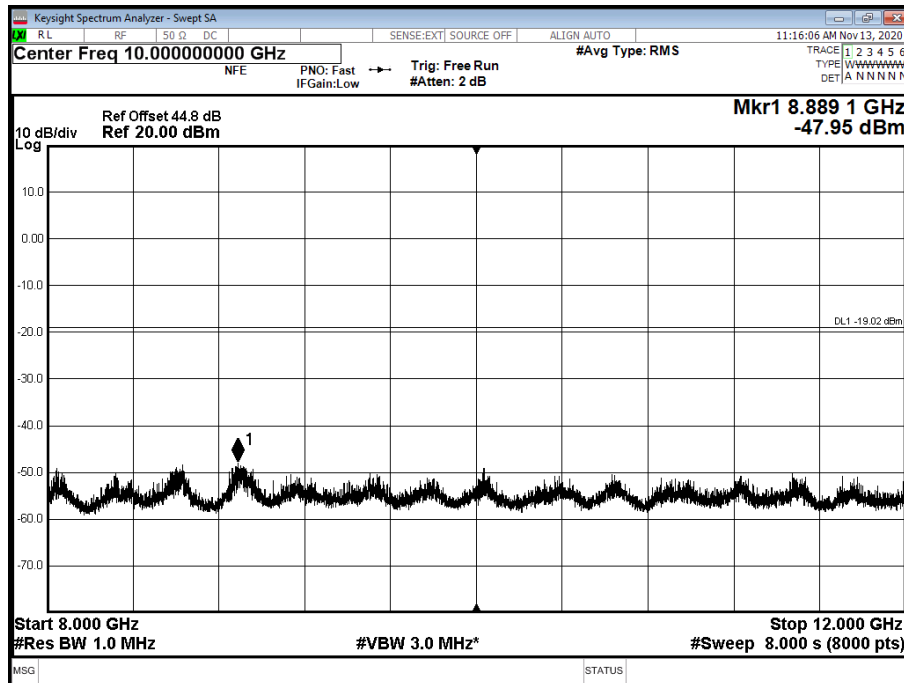

Antenna A - NR Modulation QPSK - NR Carrier Bandwidth 5.0 MHz 15 kHz SCS - Channel Position T - Band 4 - Range 12000 to 18000 MHz

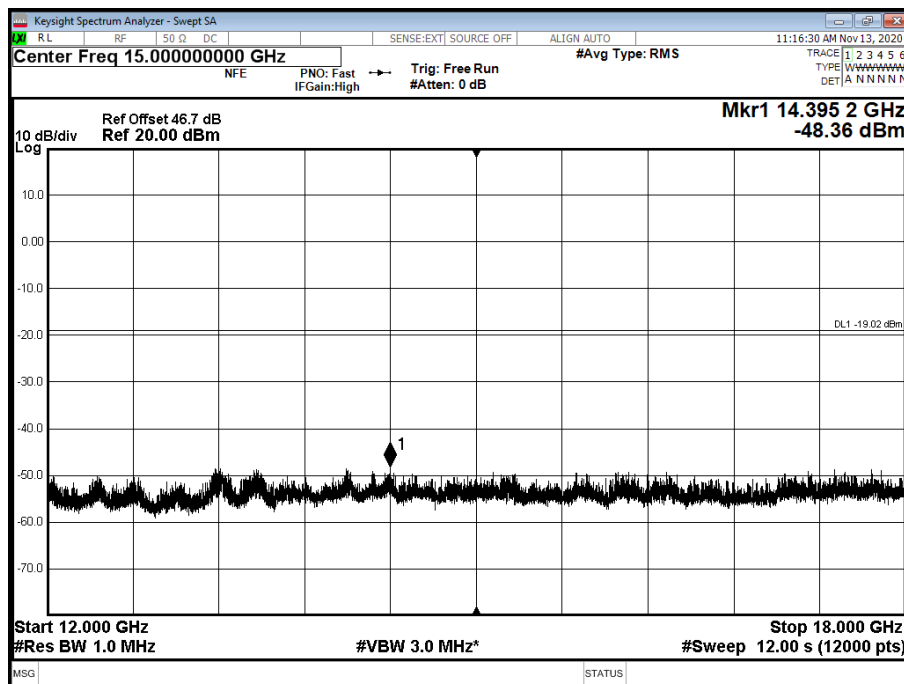



Antenna A - NR Modulation QPSK - NR Carrier Bandwidth 5.0 MHz 15 kHz SCS - Channel Position T - Band 5 - Range 18000 to 24000 MHz

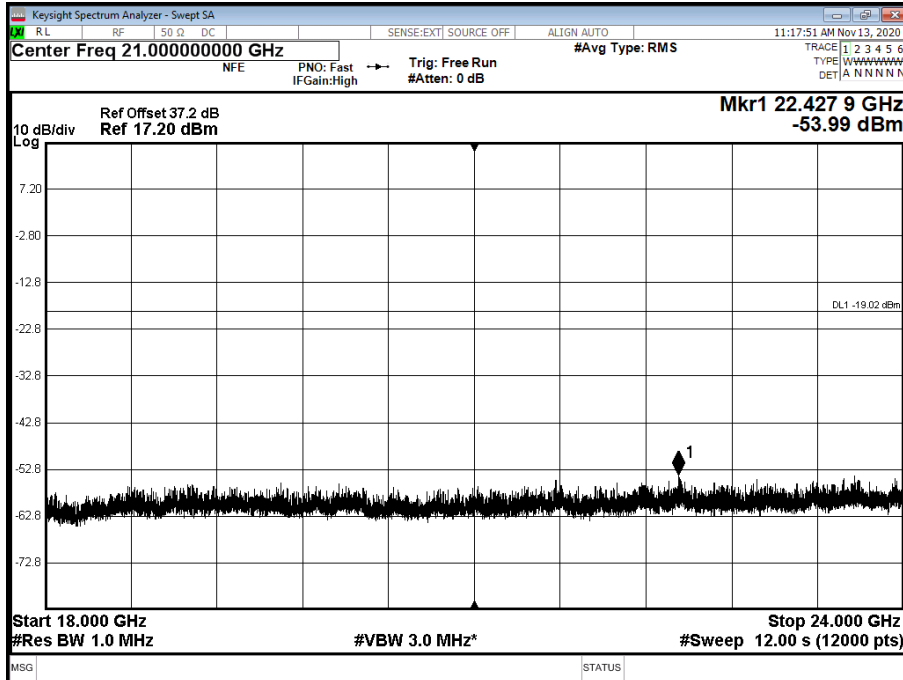

Antenna A - NR Modulation QPSK - NR Carrier Bandwidth 10.0 MHz 15 kHz SCS - Channel Position M - Band 1 - Range 0.009 to 4500 MHz

12

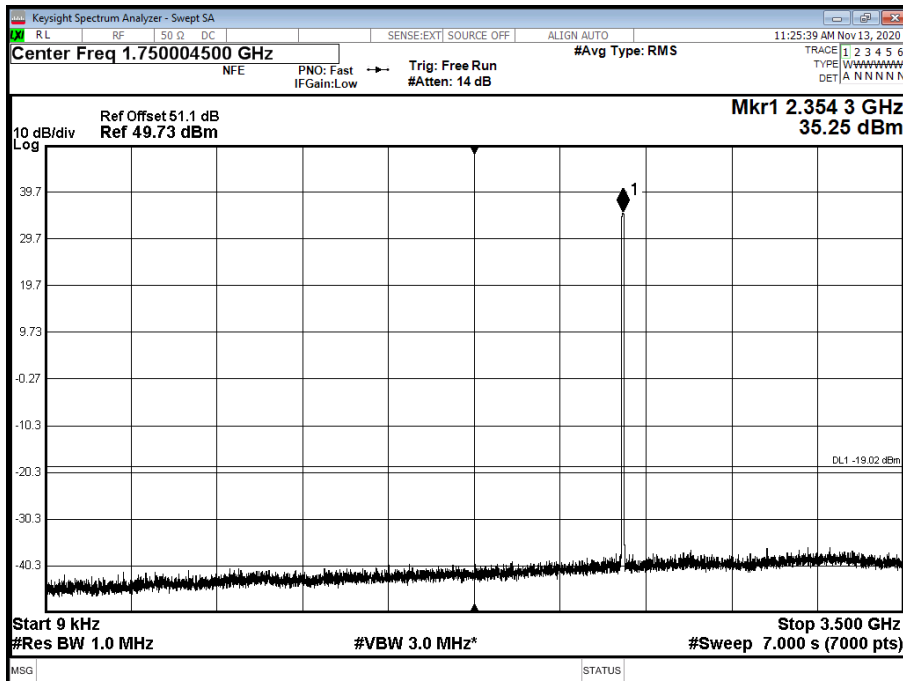



Antenna A - NR Modulation QPSK - NR Carrier Bandwidth 10.0 MHz 15 kHz SCS - Channel Position M - Band 2 - Range 4500 to 8000 MHz

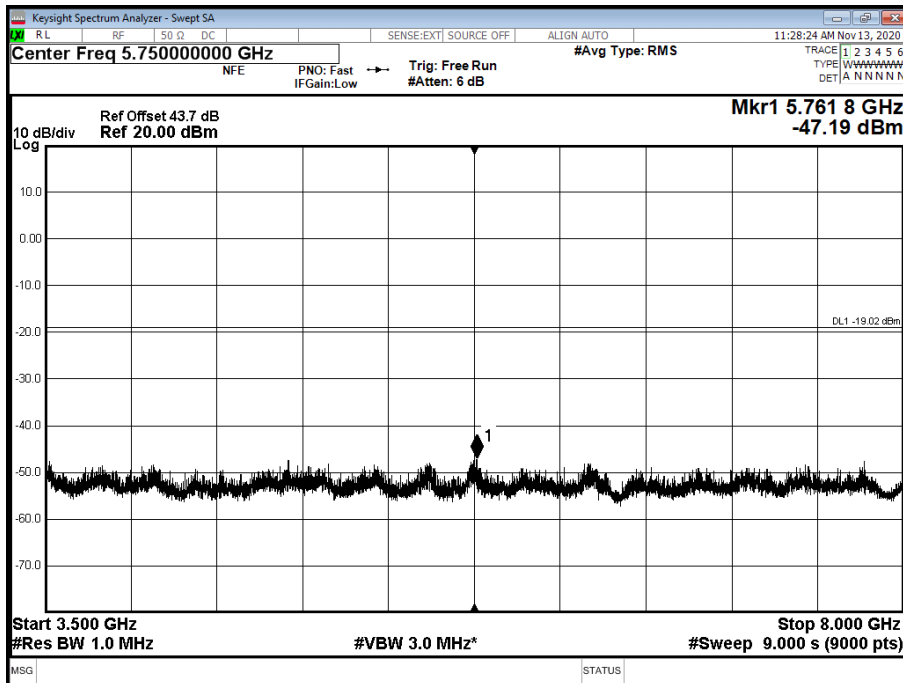

Antenna A - NR Modulation QPSK - NR Carrier Bandwidth 10.0 MHz 15 kHz SCS - Channel Position M - Band 3 - Range 8000 to 12000 MHz

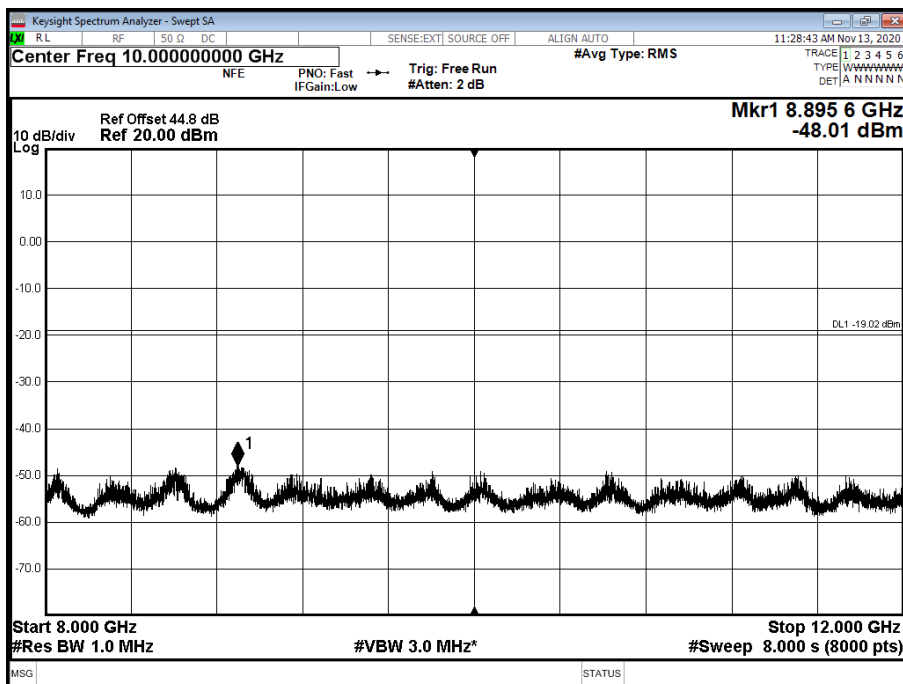



Antenna A - NR Modulation QPSK - NR Carrier Bandwidth 10.0 MHz 15 kHz SCS - Channel Position M - Band 4 - Range 12000 to 18000 MHz

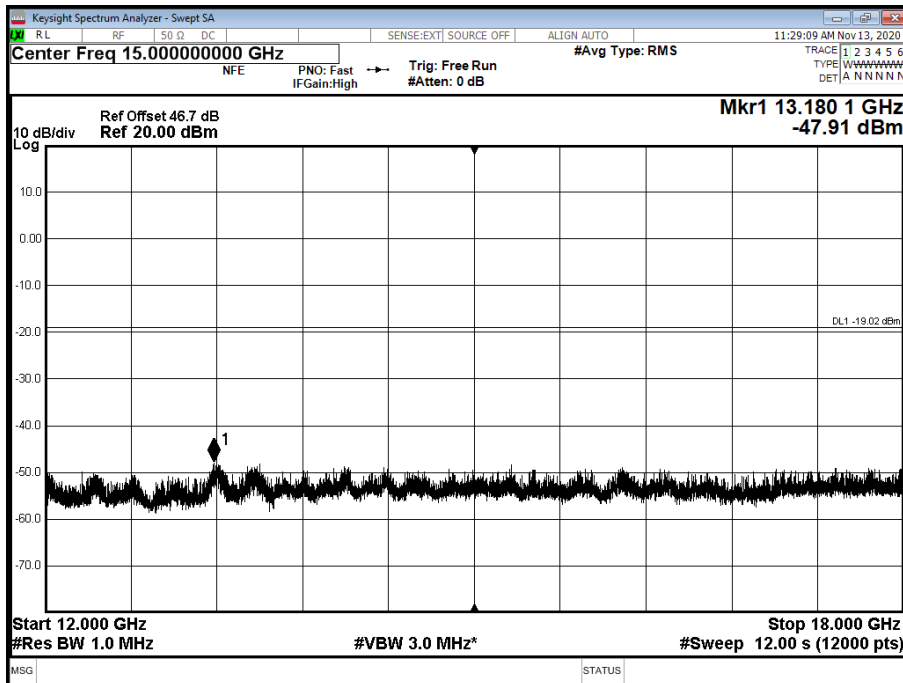

Antenna A - NR Modulation QPSK - NR Carrier Bandwidth 10.0 MHz 15 kHz SCS - Channel Position M - Band 5 - Range 18000 to 24000 MHz

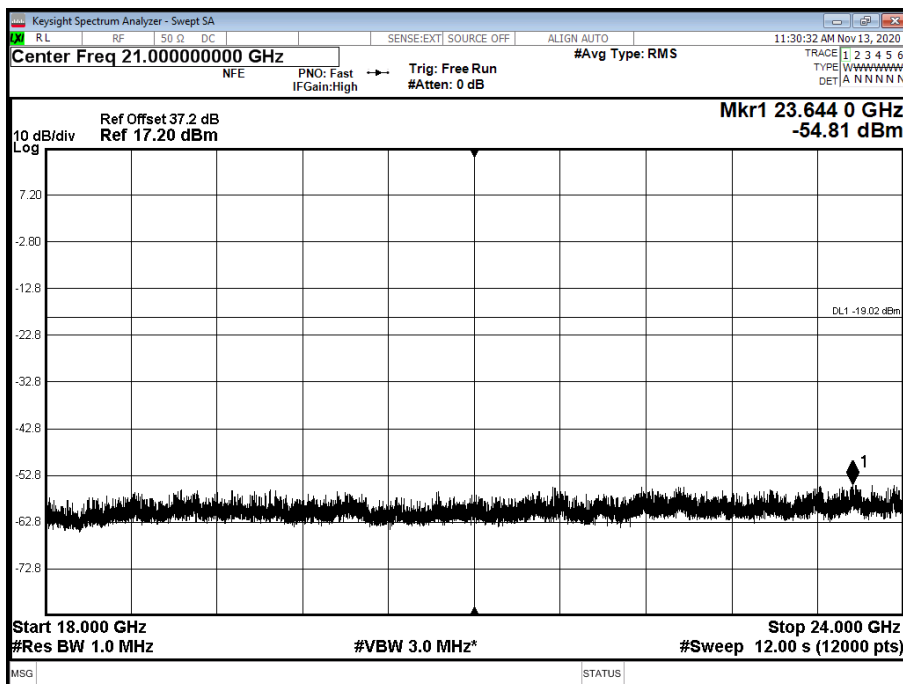

Limit	-16dBm
-------	--------



SECTION 3

TEST EQUIPMENT USED



3.1 TEST EQUIPMENT USED

List of absolute measuring and other principal items of test equipment.

Instrument	Manufacturer	Type No.	TE No.	Calibration Period (months)	Calibration Due
Maximum Peak Output Power and Peak to Average Ratio - Conducted					
Thermo-Hygro-Barometer	PCE Instruments	PCE-THB-40	5480	12	18-Mar-2021
Power Supply	Rohde & Schwarz	HMP4040	4954	-	O/P MON
Multimeter	Fluke	79	3057	12	21-Aug-2021
Attenuator 10dB 100W	Weinschel	48-10-43	4867	12	23-Jul-2021
Attenuator 40dB 100W	Weinschel	48-40-43-LIM	5134	12	29-Nov-2020
PXA Signal Analyser	Keysight	N9030A	4653	12	10-Feb-2021
Frequency Standard	Spectracom	SecureSync 1200-0408-0601	4393	6	08-May-2021
Rubidium Standard	Rohde & Schwarz	XSRM	1316	6	08-May-2021
Analyser	Rohde & Schwarz	ZVA 40	3548	12	11-Dec-2020
Calibration Kit	Rohde & Schwarz	ZV-Z54	4368	12	28-Nov-2020
Occupied Bandwidth					
Thermo-Hygro-Barometer	PCE Instruments	PCE-THB-40	5480	12	18-Mar-2021
Power Supply	Rohde & Schwarz	HMP4040	4954	-	O/P MON
Multimeter	Fluke	79	3057	12	21-Aug-2021
Attenuator 10dB 100W	Weinschel	48-10-43	4867	12	23-Jul-2021
Attenuator 40dB 100W	Weinschel	48-40-43-LIM	5134	12	29-Nov-2020
PXA Signal Analyser	Keysight	N9030A	4653	12	10-Feb-2021
Frequency Standard	Spectracom	SecureSync 1200-0408-0601	4393	6	08-May-2021
Rubidium Standard	Rohde & Schwarz	XSRM	1316	6	08-May-2021
Analyser	Rohde & Schwarz	ZVA 40	3548	12	11-Dec-2020
Calibration Kit	Rohde & Schwarz	ZV-Z54	4368	12	28-Nov-2020
Band Edge					
Thermo-Hygro-Barometer	PCE Instruments	PCE-THB-40	5480	12	18-Mar-2021
Power Supply	Rohde & Schwarz	HMP4040	4954	-	O/P MON
Multimeter	Fluke	79	3057	12	21-Aug-2021
Attenuator 10dB 100W	Weinschel	48-10-43	4867	12	23-Jul-2021
Attenuator 40dB 100W	Weinschel	48-40-43-LIM	5134	12	29-Nov-2020
PXA Signal Analyser	Keysight	N9030A	4653	12	10-Feb-2021
Frequency Standard	Spectracom	SecureSync 1200-0408-0601	4393	6	08-May-2021
Rubidium Standard	Rohde & Schwarz	XSRM	1316	6	08-May-2021
Analyser	Rohde & Schwarz	ZVA 40	3548	12	11-Dec-2020
Calibration Kit	Rohde & Schwarz	ZV-Z54	4368	12	28-Nov-2020
Transmitter Spurious Emissions					
Thermo-Hygro-Barometer	PCE Instruments	PCE-THB-40	5480	12	18-Mar-2021
Power Supply	Rohde & Schwarz	HMP4040	4954	-	O/P MON
Multimeter	Fluke	79	3057	12	21-Aug-2021



Instrument	Manufacturer	Type No.	TE No.	Calibration Period (months)	Calibration Due
Attenuator 10dB 100W	Weinschel	48-10-43	4867	12	23-Jul-2021
Attenuator 40dB 100W	Weinschel	48-40-43-LIM	5134	12	29-Nov-2020
PXA Signal Analyser	Keysight	N9030A	4653	12	10-Feb-2021
Frequency Standard	Spectracom	SecureSync 1200-0408-0601	4393	6	08-May-2021
Rubidium Standard	Rohde & Schwarz	XSRM	1316	6	08-May-2021
Analyser	Rohde & Schwarz	ZVA 40	3548	12	11-Dec-2020
Calibration Kit	Rohde & Schwarz	ZV-Z54	4368	12	28-Nov-2020
Cable attenuator	Aralab	CSF6767C-C2S6500	5175	-	O/P MON
HPF 3GHz	Advance Power Components	11SH10-3000/X18000-O/O	4411	12	01-Jul-2021
Waveguide	FMI UK	18-26 GHz	-	-	OP/MON

N/A – Not Applicable

O/P Mon – Output Monitored with Calibrated Equipment



3.2 MEASUREMENT UNCERTAINTY

For a 95% confidence level, the measurement uncertainties for defined systems are:-

Test Discipline	Frequency / Parameter	MU	
Conducted Maximum Peak Output Power	30 MHz to 20 GHz Amplitude	± 0.886 dB	
Conducted Emissions	30 MHz to 20 GHz Amplitude	± 1.791 dB	
Occupied Bandwidth	Up to 15MHz Bandwidth	5 MHz Bandwidth	± 33321 Hz
		10 MHz Bandwidth	± 67172 Hz
Band Edge	30 MHz to 20 GHz Amplitude	±0.886 dB	

Measurement Uncertainty Decision Rule

Determination of conformity with the specification limits is based on the decision rule according to IEC Guide 115: 2007, clause 4.4.3 and 4.5.1.



SECTION 5

ACCREDITATION, DISCLAIMERS AND COPYRIGHT



4.1 ACCREDITATION, DISCLAIMERS AND COPYRIGHT



This report relates only to the actual item/items tested.

Our UKAS Accreditation does not cover opinions and interpretations and any expressed are outside the scope of our UKAS Accreditation.

Results of tests not covered by our UKAS Accreditation Schedule are marked NUA (Not UKAS Accredited).

© 2020 TÜV SÜD

ANNEX A

MODULE LIST

Configuration A1			
Product	Product No	R-State	Serial No
RRUS 32 B30	KRC161 423/1	R1D	CF84039913
Software Version:	CXP9013268/12	Revision:	R79EM