



Add value.
Inspire trust.



Report On

FCC and ISED Testing of the Ericsson RRUS 32 B2, KRC 161 414/1 NR (1900 MHz) Base Station in accordance with FCC CFR 47 Part 2, FCC CFR 47 Part 24, ISED RSS-GEN and Industry Canada RSS-133

COMMERCIAL-IN-CONFIDENCE

FCC: TA8AKRC161414-1
IC: 287AB-AS1614141

PREPARED BY

Maggie Whiting
Key Account Manager

APPROVED BY

Steve Scarfe
Authorised Signatory

DATED

01 February 2022

Document 75953954 Report 08 Issue 1

February 2022



CONTENTS

Section	Page No
1	REPORT INFORMATION 2
1.1	Report Details 3
1.2	Brief Summary of Results 4
1.3	Test Rationale..... 5
1.4	Configuration Description 6
1.5	Declaration of Build Status 7
1.6	Product Information 9
1.7	Test Setup 10
1.8	Test Conditions..... 12
1.9	Deviation From The Standard 12
1.10	Modification Record 12
1.11	Additional Information 12
2	TEST DETAILS 13
2.1	Maximum Peak Output Power and Peak to Average Ratio - Conducted..... 14
2.2	Occupied Bandwidth..... 22
2.3	Band Edge 28
2.4	Transmitter Spurious Emissions 32
2.5	Radiated Emissions 56
3	TEST EQUIPMENT USED 60
3.1	Test Equipment Used 61
3.2	Measurement Uncertainty 63
3.3	Measurement Software Used 64
4	ACCREDITATION, DISCLAIMERS AND COPYRIGHT..... 65
4.1	Accreditation, Disclaimers and Copyright..... 66
ANNEX A	Module Lists.....A.2



SECTION 1

REPORT INFORMATION



1.1 REPORT DETAILS

Manufacturer	Ericsson
Address	Torshamnsgatan 23 Kista SE-16480 Stockholm Sweden
Product Name & Product Number	RRUS 32 B2 - KRC 161 414/1
IC Model Name	AS1614141
Serial Number(s)	CF84764285
Software Version	CXP9013268/12 Revision R84BD
Hardware Version	R1D
Test Specification/Issue/Date	FCC CFR 47 Part 2: 2020 FCC CFR 47 Part 24: 2020 ISED RSS-GEN: Issue 5: March 2019 Amendment 1, 2021 Amendment 2 Industry Canada RSS-133: Issue 6: January 2018 Amendment 1
Test Plan	Q1 2022 FCC_IC test plan for MR7602-1 NR-IoT V 1.1
Start of Test	17-December-2021
Finish of Test	13-January-2022
Name of Engineer(s)	Neil Rousell, Paul Dickson, Graeme Lawler
Related Document(s)	KDB 971168 D01 v02r02 KDB 662911 D01 v02r01 ICES-003:Issue 7 (2020-10) ANSI C63.26-2015

ENGINEERING STATEMENT

The measurements shown in this report were made in accordance with the procedures described on test pages. All reported testing was carried out on a sample equipment to demonstrate compliance with and FCC CFR 47 Part 2: 2020, FCC CFR 47 Part 24: 2020, ISED RSS-GEN: Issue 5: March 2019 Amendment 1, 2021 Amendment 2 Industry Canada RSS-133: Issue 6: January 2018 Amendment 1 The sample tested was found to comply with the requirements defined in the applied rules.

Test Engineer(s);

Neil Rousell, Paul Dickson, Graeme Lawler



1.2 BRIEF SUMMARY OF RESULTS

A brief summary of results for each configuration, in accordance with FCC CFR 47 Part 2, FCC CFR 47 Part 24, ISED RSS-GEN and Industry Canada RSS-133 is shown below.

Section	Specification Clause				Test Description	Result
	FCC CFR 47 Part 2	FCC CFR 47 Part 24	RSS-GEN	RSS-133		
2.1	2.1046	24.232	-	6.4	Maximum Peak Output Power and Peak to Average Ratio - Conducted	Pass
2.2	2.1049	24.238 (b)	6.7		Occupied Bandwidth	Pass
2.3	2.1051	24.238 (b)	-	6.5	Band Edge	Pass
2.4	2.1051	24.238 (a)	6.13	6.5	Transmitter Spurious Emissions	Pass
2.5	2.1053	-	6.13	6.5	Radiated Emissions	Pass



1.3 TEST RATIONALE

The tests that have been selected are detailed in the customer Test Plan as defined in section 1.1 of this report. The Test Plan is based on the TÜV SÜD FCC Test Plan Rationale, available on request.



1.4 CONFIGURATION DESCRIPTION

Config Number	Band	RATs	Carriers	Pout (W)	NR Main carrier			
					Position	BW	Freq	NR-ARFCN
1	B2	NR in NR/ESS Setup (NB IoT IB) 15 kHz SCS, QPSK	1	40	B	10	1935	387000
	B2				M	10	1960	392000
	B2				T	10	1985	397000
	B2				B	15	1937.5	387500
	B2				M	15	1960	392000
	B2				T	15	1982.5	396500
	B2				B	20	1940	388000
	B2				M	20	1960	392000
	B2				T	20	1980	396000
	B2				T	10	1985	397000



1.5 DECLARATION OF BUILD STATUS

Equipment Description			
Technical Description: (Please provide a brief description of the intended use of the equipment including the technologies the product supports)		Multi-standard remote radio unit RRUS 32 B2 4Tx and 4Rx	
Manufacturer:		Ericsson AB	
Model:		RRUS 32 B2	
Part Number:		KRC161414/1	
Hardware Version:		R1D	
Software Version:		CXP 9013268/12 R84BD	
FCC ID of the product under test		TA8AKRC161414-1	
IC ID of the product under test		287AB-AS1614141	
Intentional Radiators			
RAT	LTE (incl. NB IoT IB, GB)	NR ,SCS 15kHz(incl. NB IoT IB, GB)	
Frequency Range (MHz to MHz)	DL: 1930 - 1990 MHz, UL 1850 - 1910MHz	DL: 1930 - 1990 MHz, UL 1850 - 1910MHz	
Conducted Declared Output Power (dBm)	46.0 Max output power per port 40W	46.0 Max output power per port 40W	
Total RF bandwidth (IBW)	40MHz	40MHz	
Supported Bandwidth(s) (MHz)	5, 10, 15, 20MHz	5, 10, 15, 20MHz	
Modulation Scheme(s)	QPSK, 16QAM, 64QAM, 256QAM	QPSK, 16QAM, 64QAM, 256QAM	
ITU Emission Designator (From previously Declaration 2019-11-28)	5 MHz, BW: 5M00F9W 10 MHz, BW: 10M0F9W 15 MHz, BW: 15M0F9W 20 MHz, BW: 20M0F9W	5 MHz, BW: 4M47W7D 10 MHz, BW: 9M29W7D 15 MHz, BW: 14M1W7D 20 MHz, BW: 18M9W7D 20+20 MHz, BW: 38M8W7D (20+20 MHz, Carrier aggregation)	
ITU Emission Designator NB-IoT SA (From previously Declaration 2019-11-28)	B2: 200kHz, Max output per port 20W BW 210KW7D	-	
ITU Emission Designator(NR NB IoT IB) Test Report No. 75953954.	NR with NB IoT IB: 10 MHz, BW: 9M45W7D 15 MHz, BW: 14M4W7D 20 MHz, BW: 19M2W7D		
Duplex mode:	FDD	FDD	
Supported transmission modes:	4X4 MIMO	4X4 MIMO	
Maximum number of carriers	3	3	
Unintentional Radiators			
Highest frequency generated or used in the device or on which the device operates or tunes		Up to 9.8 Gbit/s	
Lowest frequency generated or used in the device or on which the device operates or tunes if <30MHz		-	
Class A Digital Device (Use in commercial, industrial or business environment)		-	
Class B Digital Device (Use in residential environment)		Class B	
DC Power Supply (Delete if Not Applicable)			
Nominal voltage:	-48V		
Extreme upper voltage:	-39V		
Extreme lower voltage:	-58.5V		
Max current:	32A		
Temperature			
Minimum temperature:	-40°C		
Maximum temperature:	55°C		
Ancillaries			
Manufacturer:	X	Part Number:	X
Model:	X	Model:	X



I hereby declare that I am entitled to sign on behalf of the manufacturer and that the information supplied is correct and complete.	
Name:	Afrah Ali sadiq
Position held:	Regulatory Approval Engineer
Email address:	Afrah.ali.sadiq@ericsson.com
Telephone number:	.+46724650796
Date:	29-Jan-2022

No responsibility will be accepted by TÜV SÜD UK Limited as to the accuracy of the information declared in this document by the manufacturer.

1.6 PRODUCT INFORMATION

1.6.1 Technical Description

The Equipment Under Test (EUT) RRUS 32 B2 - KRC 161 414/1 is an Ericsson AB Radio Unit working in the public mobile service Band 2 band which provides communication connections to Band 2 network. The EUT operates from a -48V DC supply.

The Equipment Under Test (EUT) is shown in the photograph below. A full technical description can be found in the Manufacturer's documentation.

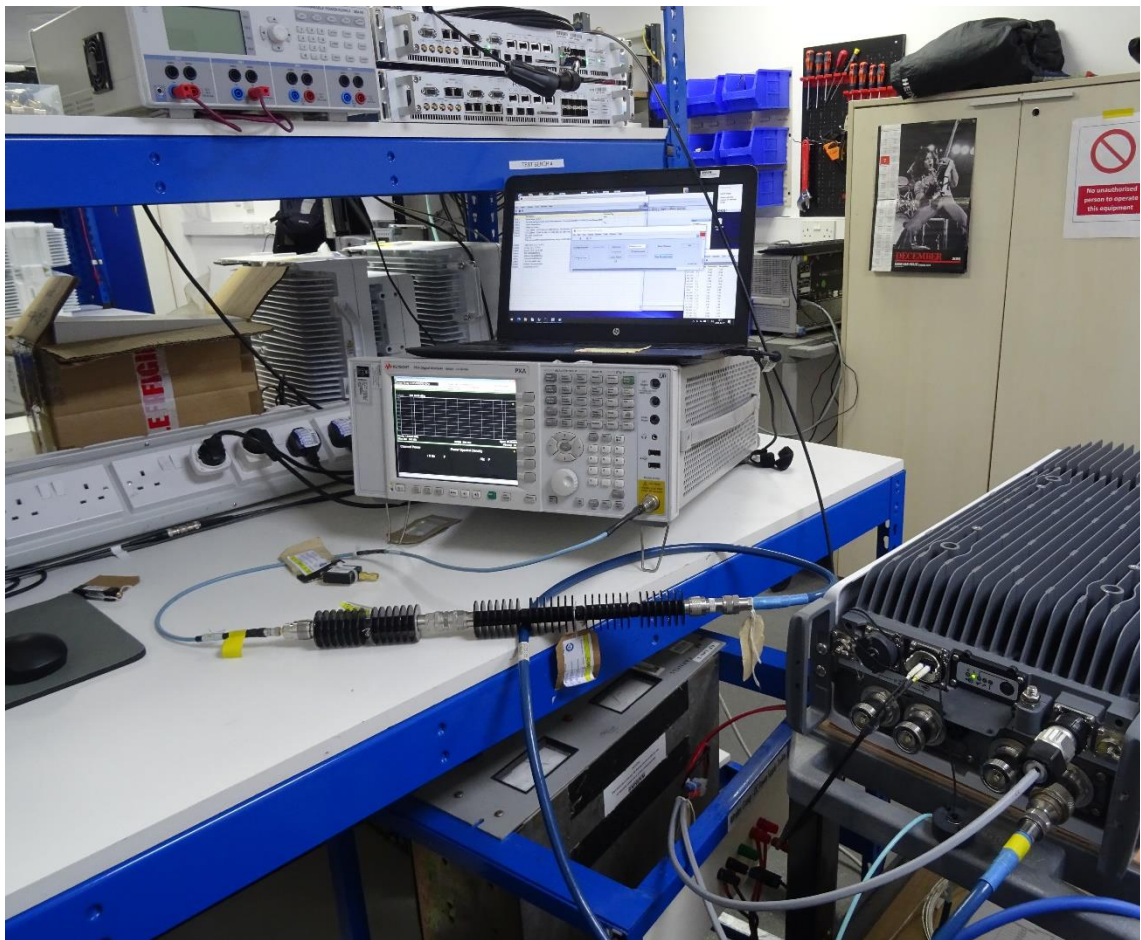

Equipment Under Test



1.7 TEST SETUP

Conducted Test Set Up

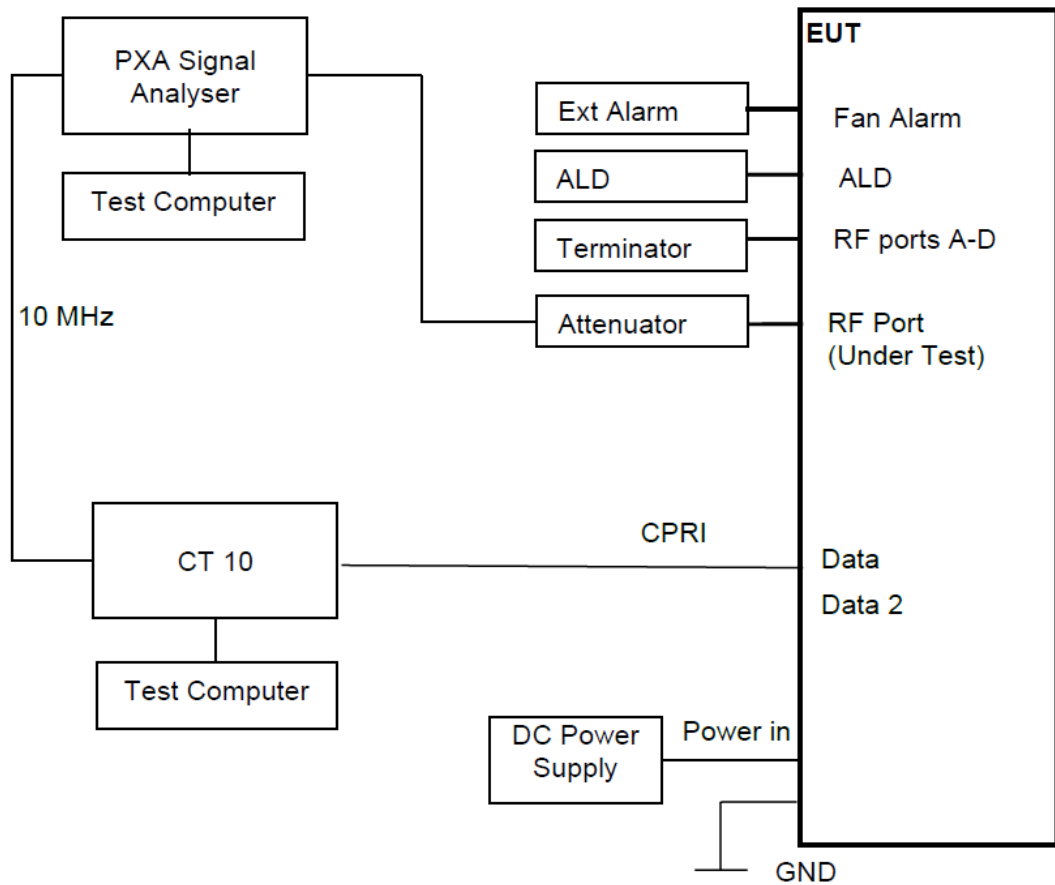



Radiated Test Set Up – Dashed line indicates equipment inside the Chamber for Radiated testing.

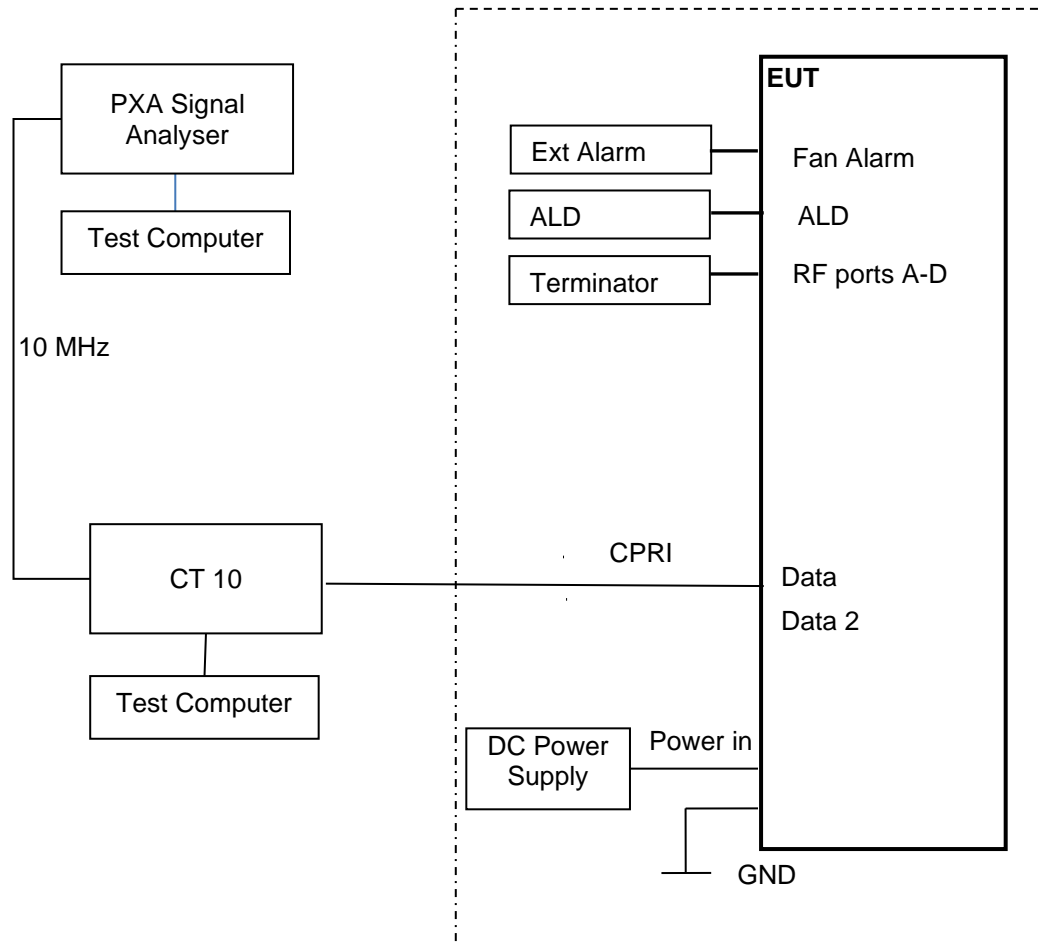



1.8 TEST CONDITIONS

For all tests the EUT was set up in accordance with the relevant test standard and to represent typical operating conditions. Tests were applied with the EUT situated as described in the Test Method for each Test.

The EUT was powered from a -48V DC supply.

FCC Measurement Facility Registration Number
90987 Octagon House, Fareham Test Laboratory
Postal Address: Octagon House, Concorde Way, Fareham, Hampshire, UK, PO15 5RL

Under our UKAS Accreditation, TÜV SÜD conducted the following tests Octagon House, Fareham Laboratory.

Test Name	Name of Engineer(s)
Maximum Peak Output Power and Peak to Average Ratio - Conducted	Neil Rousell
Occupied Bandwidth	Neil Rousell,
Band Edge	Neil Rousell
Transmitter Spurious Emissions	Neil Rousell
Radiated Emissions	Paul Dickinson, Graeme Lawler

1.9 DEVIATION FROM THE STANDARD

No deviations from the applicable test standards or test plan were made during testing.

1.10 MODIFICATION RECORD

No modifications were made to the EUT during testing.

1.11 ADDITIONAL INFORMATION

This EUT uses the same port for Tx and Rx and therefore RX Spurious Emissions has not been performed.

Rx Spurious Emissions have been covered by testing to FCC Part 15B, which are covered by a separate test report.



SECTION 2

TEST DETAILS



2.1 MAXIMUM PEAK OUTPUT POWER AND PEAK TO AVERAGE RATIO - CONDUCTED

2.1.1 Specification Reference

FCC CFR 47 Part 24, Clause 24.232
 Industry Canada RSS-133, Clause 6.4
 FCC CFR 47 Part 2, Clause 2.1046

2.1.2 Date of Test and Modification State

17-December-2021 - Modification State 0

2.1.3 Test Equipment Used

The major items of test equipment used for the above tests are identified in Section 3.1.

2.1.4 Environmental Conditions

Ambient Temperature 21.2°C
 Relative Humidity 43.0%

2.1.5 Test Method

All measurements were made in accordance with FCC KDB 971168 D01, clause 5.2.1 and summed in accordance with FCC KDB 662911 D01.

2.1.6 Test Results

Configuration 1

Maximum Output Power 46.00 dBm

Antenna	NR Modulation	NR Carrier Bandwidth	Peak to Average Ratio (PAR) / Output Power / PSD				
			Channel Position B				
			PAR (dB)	Average Power/PSD		Total Power Port A + B + C + D	Total Power Port A + B + C + D
dBm	dBm/MHz	dBm		dBm/MHz			
A	QPSK	10.0 MHz 15 kHz SCS	7.26	45.74	36.85	51.76	42.87
A	QPSK	15.0 MHz 15 kHz SCS	7.43	45.71	36.37	51.73	42.39
A	QPSK	20.0 MHz 15 kHz SCS	7.45	45.55	36.31	51.57	42.33

Remarks

Calculations: Total Power = Measured Output Power (port A, worst case) + 10log (NANT)
 Where NANT refers to the number of Ports. In this product = 4.



Antenna A - NR Modulation QPSK - NR Carrier Bandwidth 10.0 MHz 15 kHz SCS - Channel Position B

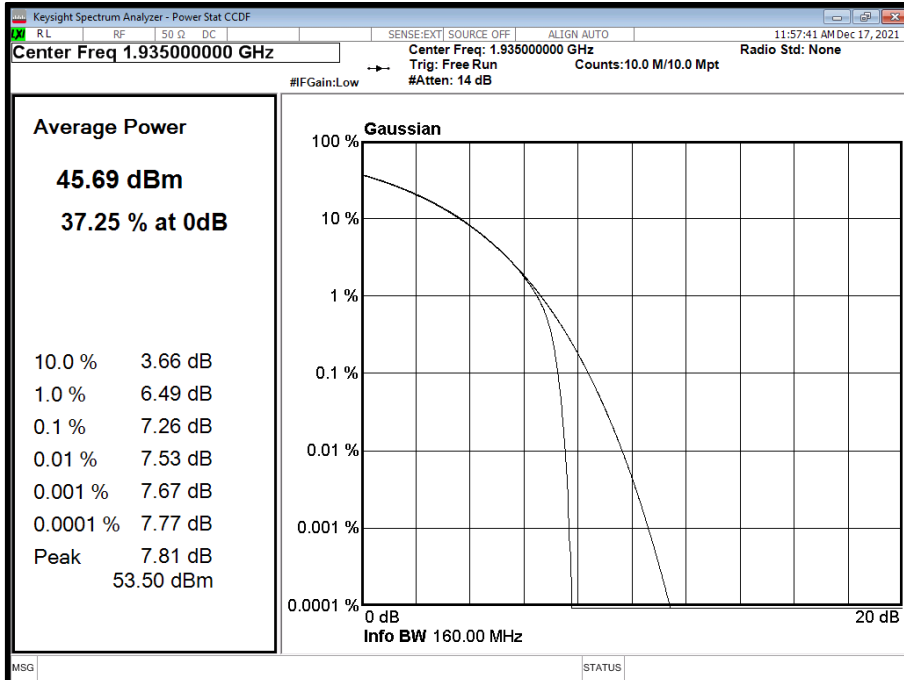

Antenna A - NR Modulation QPSK - NR Carrier Bandwidth 15.0 MHz 15 kHz SCS - Channel Position B

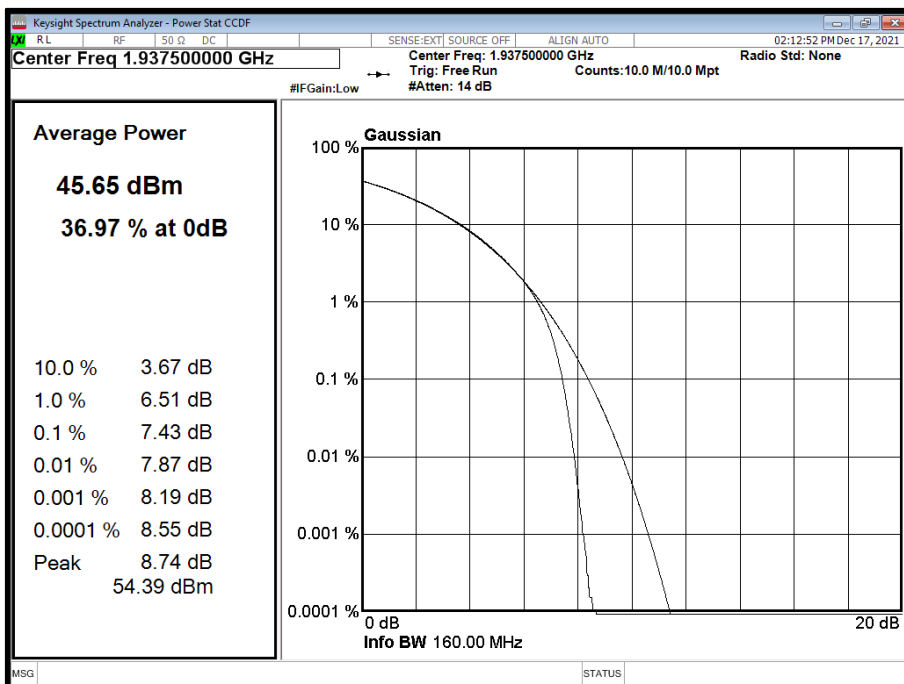



Antenna A - NR Modulation QPSK - NR Carrier Bandwidth 20.0 MHz 15 kHz SCS - Channel Position B

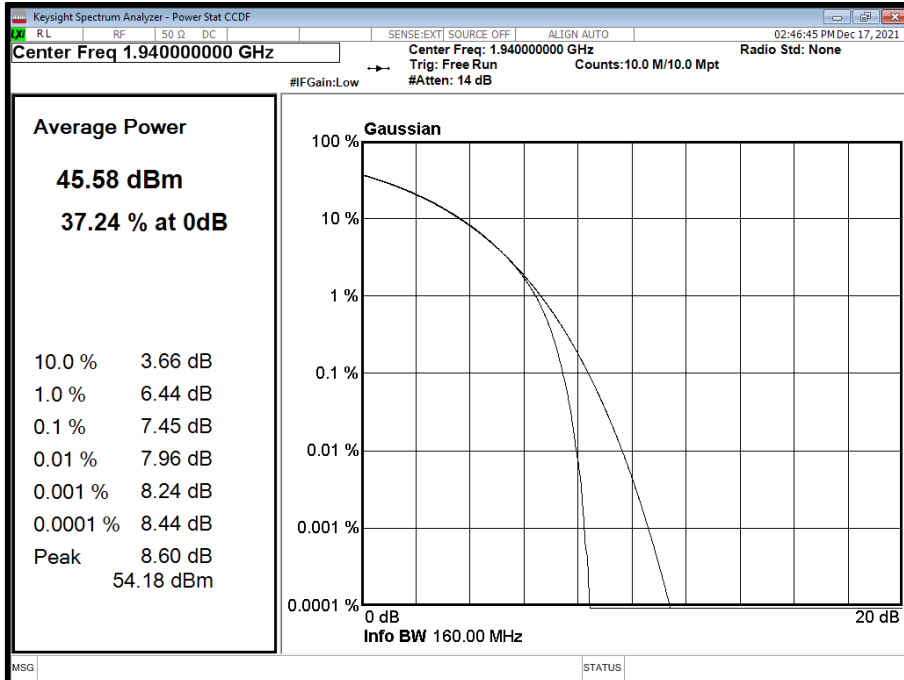



Configuration 1

Maximum Output Power 46.00 dBm

Antenna	NR Modulation	NR Carrier Bandwidth	Peak to Average Ratio (PAR) / Output Power / PSD				
			Channel Position M				
			PAR (dB)	Average Power/PSD		Total Power Port A + B + C + D	Total Power Port A + B + C + D
dBm	dBm/MHz	dBm		dBm/MHz			
A	QPSK	10.0 MHz 15 kHz SCS	7.17	45.58	36.76	51.60	42.78
A	QPSK	15.0 MHz 15 kHz SCS	7.26	45.53	36.31	51.55	42.33
A	QPSK	20.0 MHz 15 kHz SCS	7.21	45.54	36.14	51.56	42.16

Remarks

Calculations: Total Power = Measured Output Power (port A, worst case) + 10log (NANT)
 Where NANT refers to the number of Ports. In this product = 4.

Antenna A - NR Modulation QPSK - NR Carrier Bandwidth 10.0 MHz 15 kHz SCS - Channel Position M

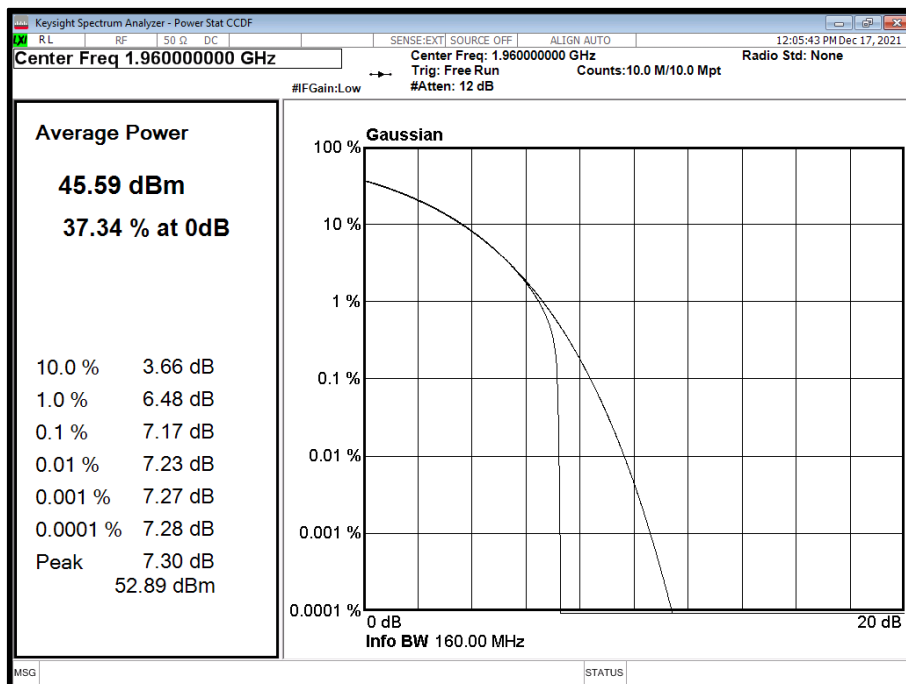



Antenna A - NR Modulation QPSK - NR Carrier Bandwidth 15.0 MHz 15 kHz SCS - Channel Position M

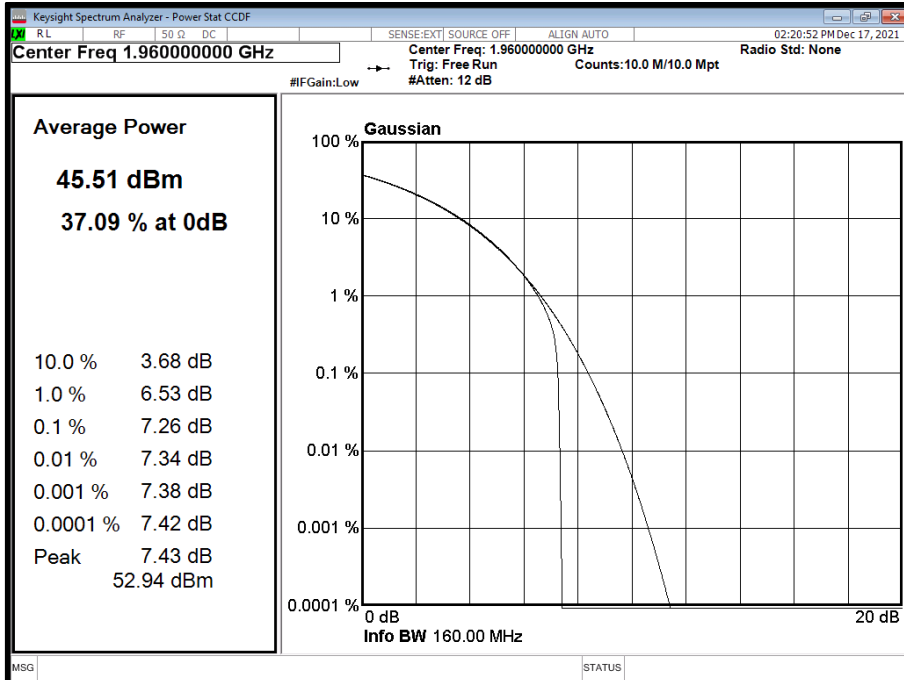

Antenna A - NR Modulation QPSK - NR Carrier Bandwidth 20.0 MHz 15 kHz SCS - Channel Position M

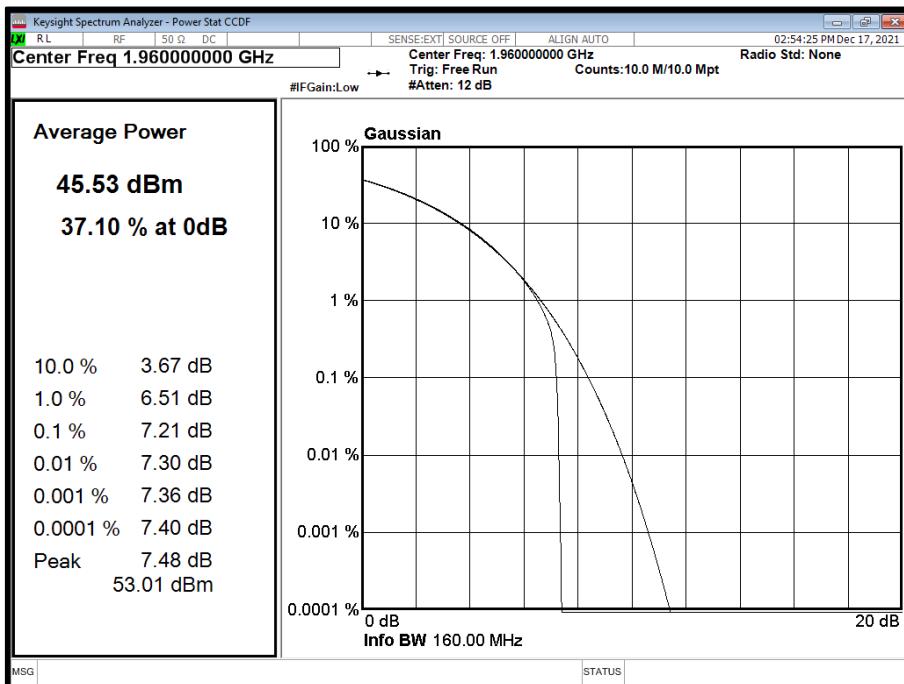



Configuration 1

Maximum Output Power 46.00 dBm

Antenna	NR Modulation	NR Carrier Bandwidth	Peak to Average Ratio (PAR) / Output Power / PSD				
			Channel Position T				
			PAR (dB)	Average Power/PSD		Total Power Port A + B + C + D	Total Power Port A + B + C + D
dBm	dBm/MHz	dBm		dBm/MHz			
A	QPSK	10.0 MHz 15 kHz SCS	7.22	45.67	36.93	51.69	42.95
A	QPSK	15.0 MHz 15 kHz SCS	7.32	45.60	36.35	51.62	42.37
A	QPSK	20.0 MHz 15 kHz SCS	7.36	45.55	36.29	51.57	42.31

Remarks

Calculations: Total Power = Measured Output Power (port A, worst case) + 10log (NANT)
 Where NANT refers to the number of Ports. In this product = 4.

Antenna A - NR Modulation QPSK - NR Carrier Bandwidth 10.0 MHz 15 kHz SCS - Channel Position T

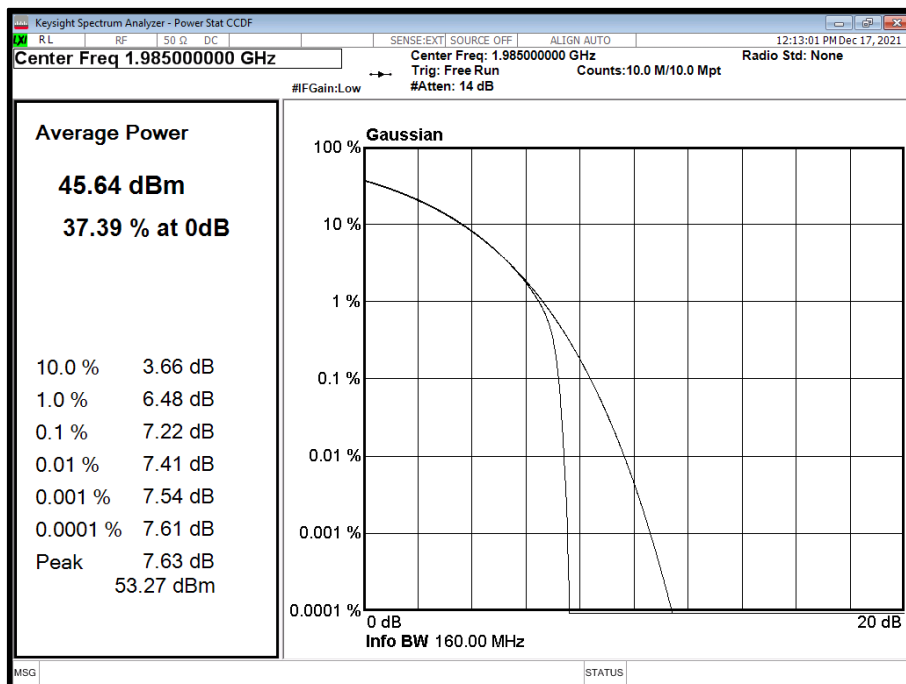



Antenna A - NR Modulation QPSK - NR Carrier Bandwidth 15.0 MHz 15 kHz SCS - Channel Position T

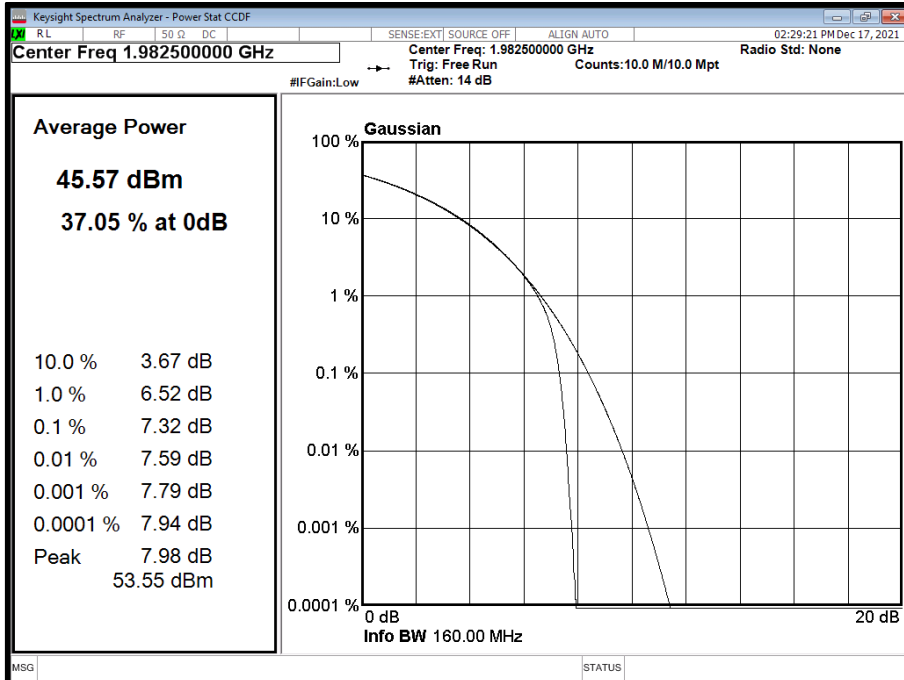

Antenna A - NR Modulation QPSK - NR Carrier Bandwidth 20.0 MHz 15 kHz SCS - Channel Position T

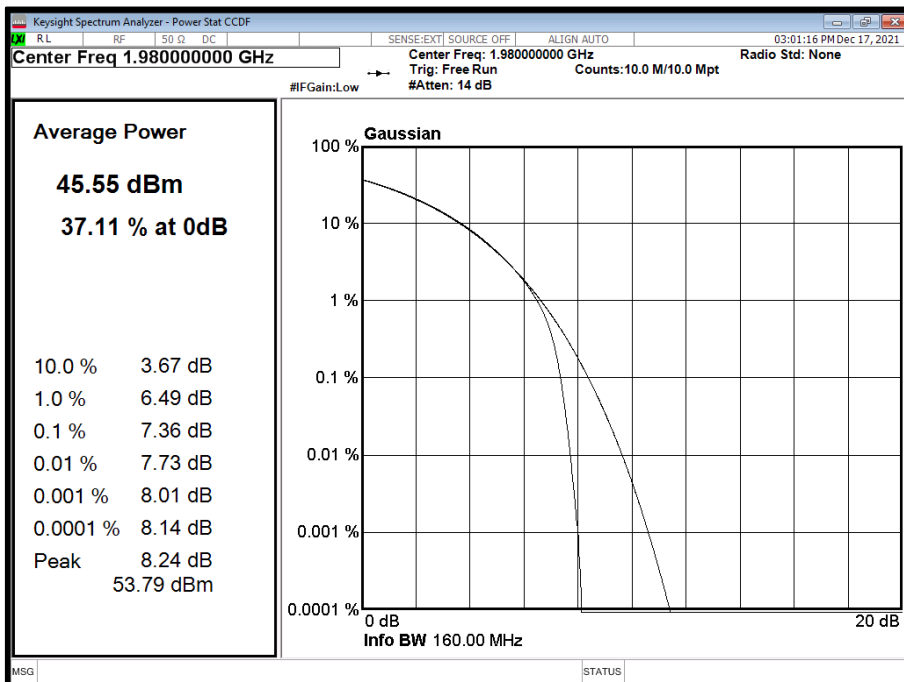



RSS-133 Clause 6.4

Limit	
Peak to Average Ratio	13 dB



2.2 OCCUPIED BANDWIDTH

2.2.1 SPECIFICATION REFERENCE

FCC CFR 47 Part 24, Clause 24.238 (b)
ISED RSS-GEN, Clause 6.7
FCC CFR 47 Part 2, Clause 2.1049

2.2.2 Date of Test and Modification State

17-December-2021 - Modification State 0

2.2.3 Test Equipment Used

The major items of test equipment used for the above tests are identified in Section 3.1.

2.2.4 Environmental Conditions

Ambient Temperature	21.2°C
Relative Humidity	43.0%

2.2.5 Test Method

All measurements were made in accordance with FCC KDB 971168 D01, Clause 4.2 and 4.3. The Spectrum Analyser RBW was configured to be at least 1% of the channel bandwidth of the carrier to be measured.

For 26 dB Bandwidth, in accordance with KDB 971168 D01, a peak detector and a trace setting of Max Hold were used. The trace was allowed to stabilise. Using the Spectrum Analyser function, the 26dB measurement result was obtained.

4.2 Occupied bandwidth – relative measurement procedure

The reference value is the highest level of the spectral envelope of the modulated signal, unless otherwise specified in an applicable rule section.

Subclause 5.4.3 of ANSI C63.26-2015 is applicable.

4.3 Occupied bandwidth – power bandwidth (99 %) measurement procedure

Subclause 5.4.4 of ANSI C63.26-2015 is applicable (wherein the recommendation is to use the 99 % power bandwidth function of a spectrum analyzer).

2.2.6 Test Results



Configuration 1

Maximum Output Power 46.00 dBm

Antenna	NR Modulation	NR Carrier Bandwidth	Result (kHz)					
			Channel Position B		Channel Position M		Channel Position T	
			Occupied Bandwidth	-26 dB Bandwidth	Occupied Bandwidth	-26 dB Bandwidth	Occupied Bandwidth	-26 dB Bandwidth
A	QPSK	10.0 MHz 15 kHz SCS	9443.61	9796.78	9438.26	9808.18	9446.08	9803.07
A	QPSK	15.0 MHz 15 kHz SCS	14351.51	14801.43	14345.00	14794.78	14345.58	14799.95
A	QPSK	20.0 MHz 15 kHz SCS	19173.70	19740.04	19177.93	19753.26	19175.55	19749.76

Antenna A - NR Modulation QPSK - NR Carrier Bandwidth 10.0 MHz 15 kHz SCS - Channel Position B

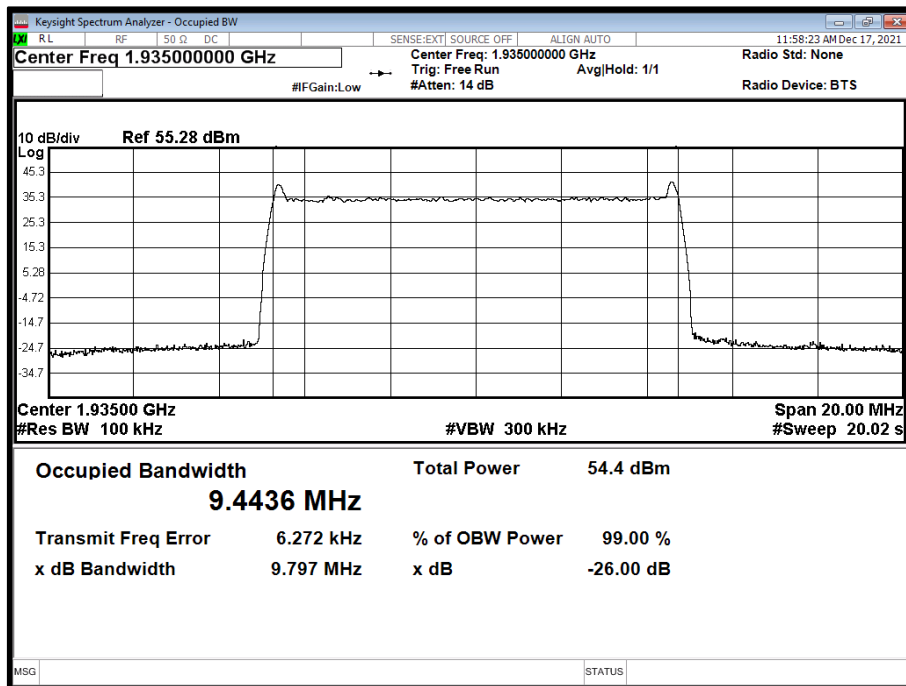



Antenna A - NR Modulation QPSK - NR Carrier Bandwidth 10.0 MHz 15 kHz SCS - Channel Position M

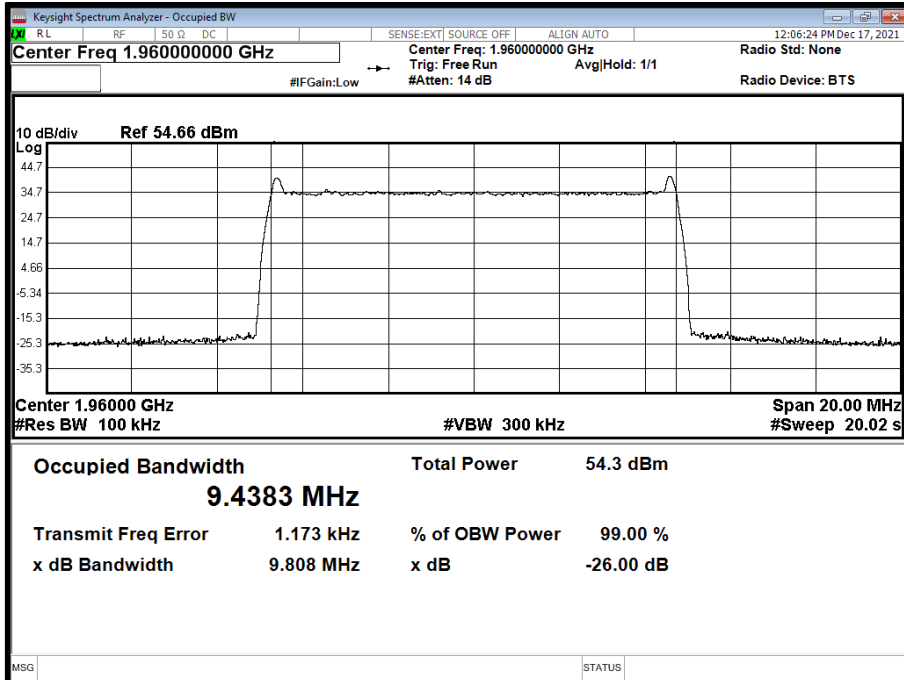

Antenna A - NR Modulation QPSK - NR Carrier Bandwidth 10.0 MHz 15 kHz SCS - Channel Position T

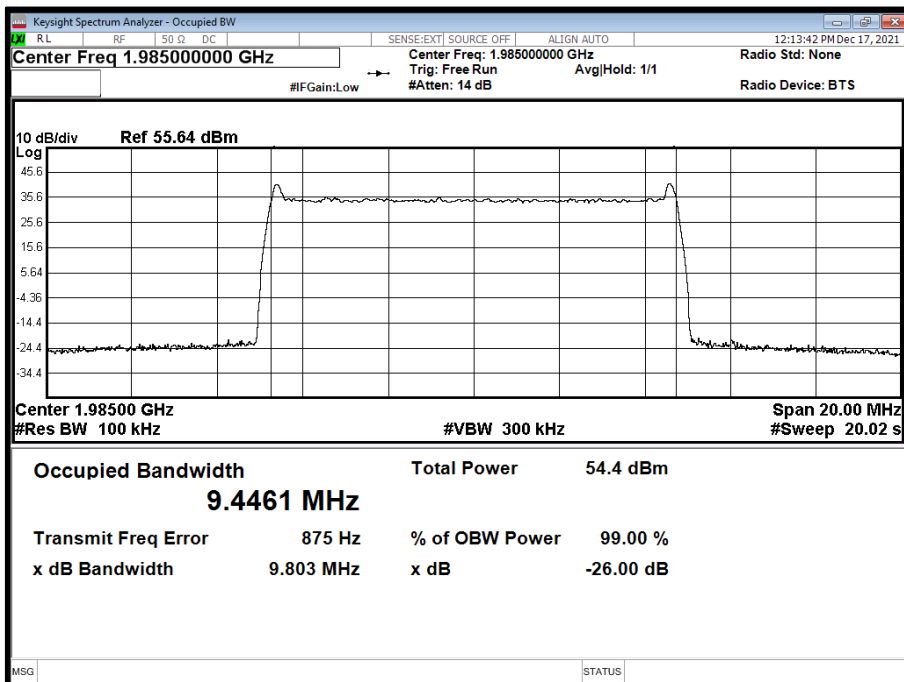



Antenna A - NR Modulation QPSK - NR Carrier Bandwidth 15.0 MHz 15 kHz SCS - Channel Position B

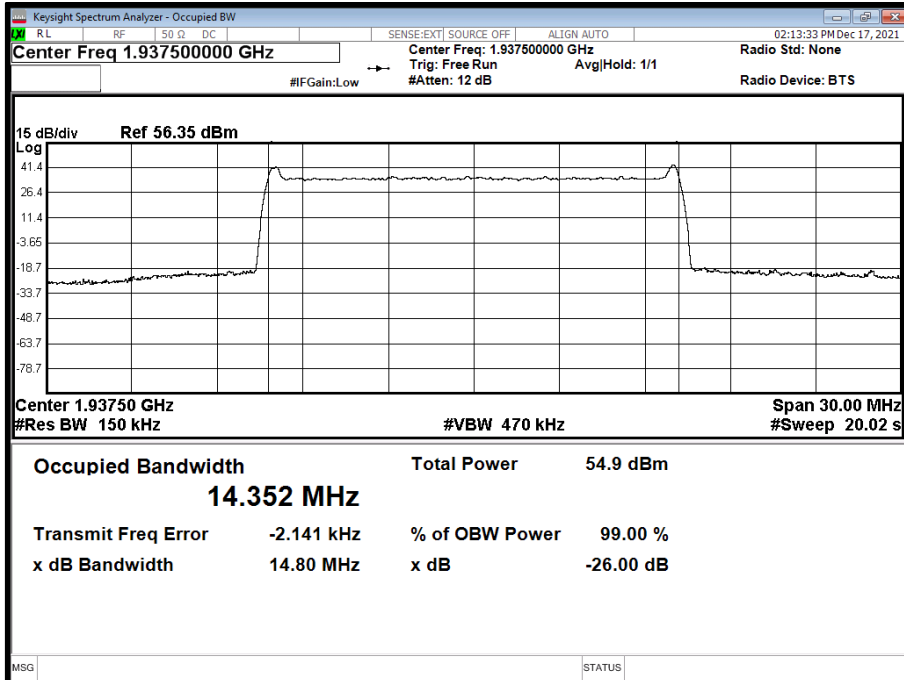

Antenna A - NR Modulation QPSK - NR Carrier Bandwidth 15.0 MHz 15 kHz SCS - Channel Position M

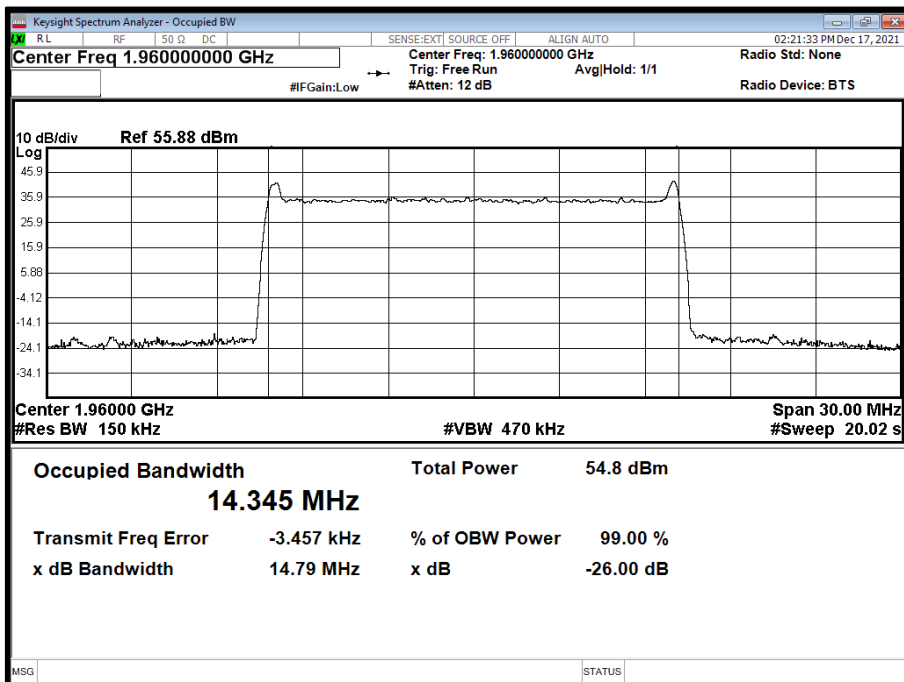



Antenna A - NR Modulation QPSK - NR Carrier Bandwidth 15.0 MHz 15 kHz SCS - Channel Position T

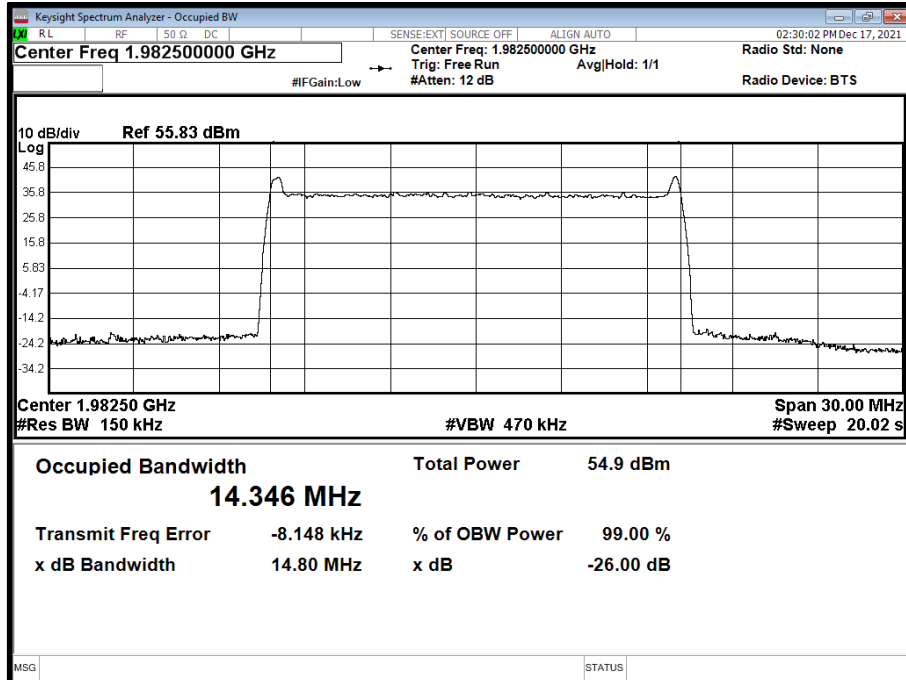

Antenna A - NR Modulation QPSK - NR Carrier Bandwidth 20.0 MHz 15 kHz SCS - Channel Position B

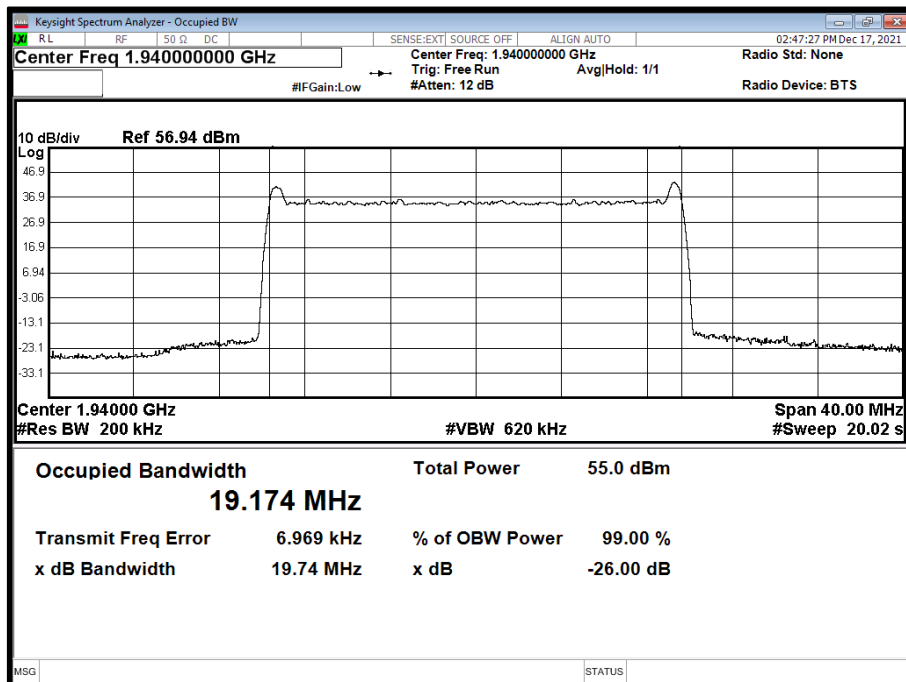



Antenna A - NR Modulation QPSK - NR Carrier Bandwidth 20.0 MHz 15 kHz SCS - Channel Position M

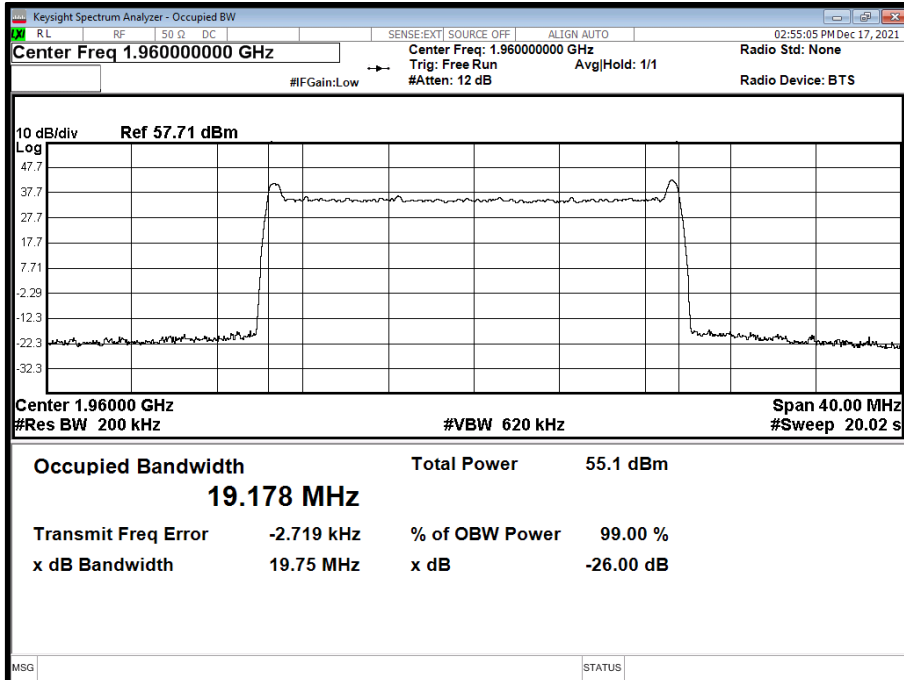

Antenna A - NR Modulation QPSK - NR Carrier Bandwidth 20.0 MHz 15 kHz SCS - Channel Position T

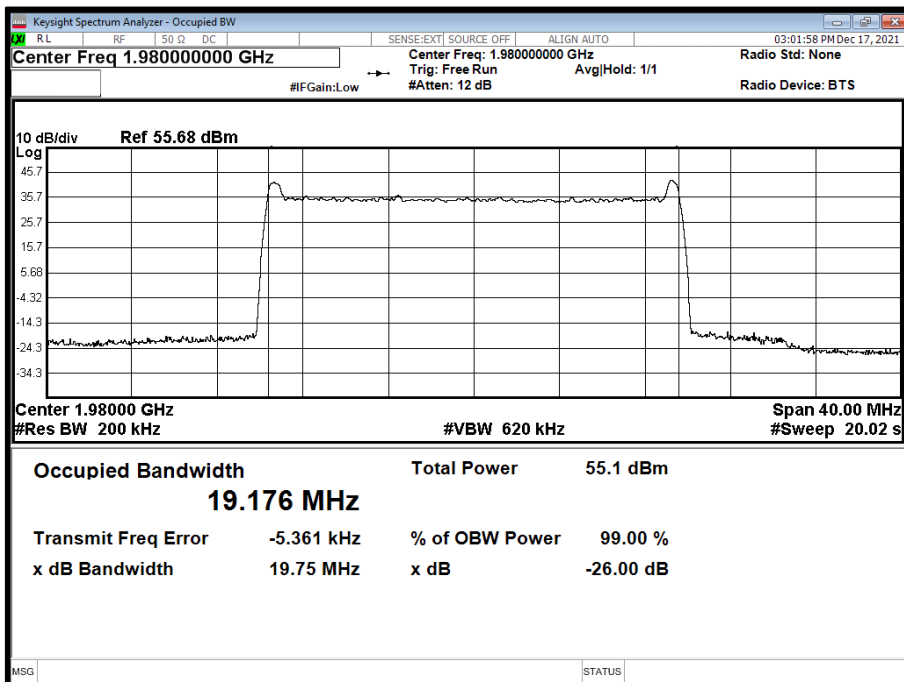



2.3 BAND EDGE

2.3.1 Specification Reference

FCC CFR 47 Part 24, Clause 24.238 (b)
Industry Canada RSS-133, Clause 6.5
FCC CFR 47 Part 2, Clause 2.1051

2.3.2 Date of Test and Modification State

17-December-2021 - Modification State 0

2.3.3 Test Equipment Used

The major items of test equipment used for the above tests are identified in Section 3.1.

2.3.4 Environmental Conditions

Ambient Temperature 21.2°C
Relative Humidity 43.0%

2.3.5 Test Method

All measurements were made in accordance with FCC KDB 971168 D01, Clause 6.0.

Band Edge measurements were used an Integration Bandwidth of at least 1% of the measured 26dB Bandwidth.

Each antenna port has been declared as being equivalent, therefore measurements were made on one antenna port only. To account for this, the limit was tightened by $10 * \text{Log}(N)$, where N is equal to the number of MIMO antenna ports.

For single port, the limit was calculated as being $-13 \text{ dBm} - 10 * \text{Log}(4) = -19 \text{ dBm}$.

2.3.6 Test Results

Configuration 1

Maximum Output Power 46.00 dBm

Antenna	NR Modulation	NR Carrier Bandwidth	Band Edge (MHz)	
			Channel Position B	Channel Position T
A	QPSK	10.0 MHz 15 kHz SCS	1,935.0	1,985.0
A	QPSK	15.0 MHz 15 kHz SCS	1,937.5	1,982.5
A	QPSK	20.0 MHz 15 kHz SCS	1,940.0	1,980.0



Antenna A - NR Modulation QPSK - NR Carrier Bandwidth 10.0 MHz 15 kHz SCS - Channel Position B

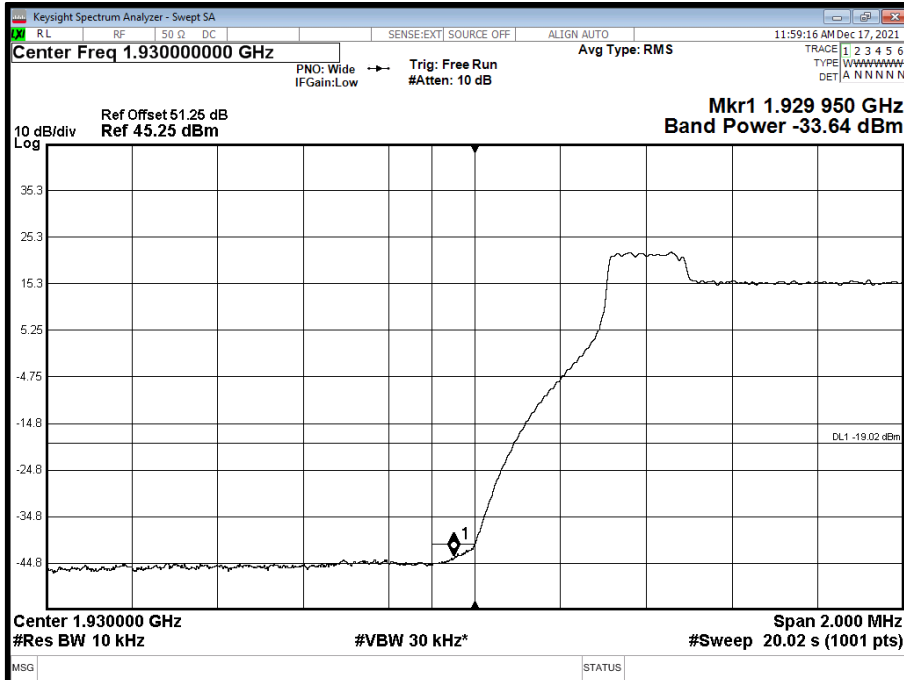

Antenna A - NR Modulation QPSK - NR Carrier Bandwidth 10.0 MHz 15 kHz SCS - Channel Position T

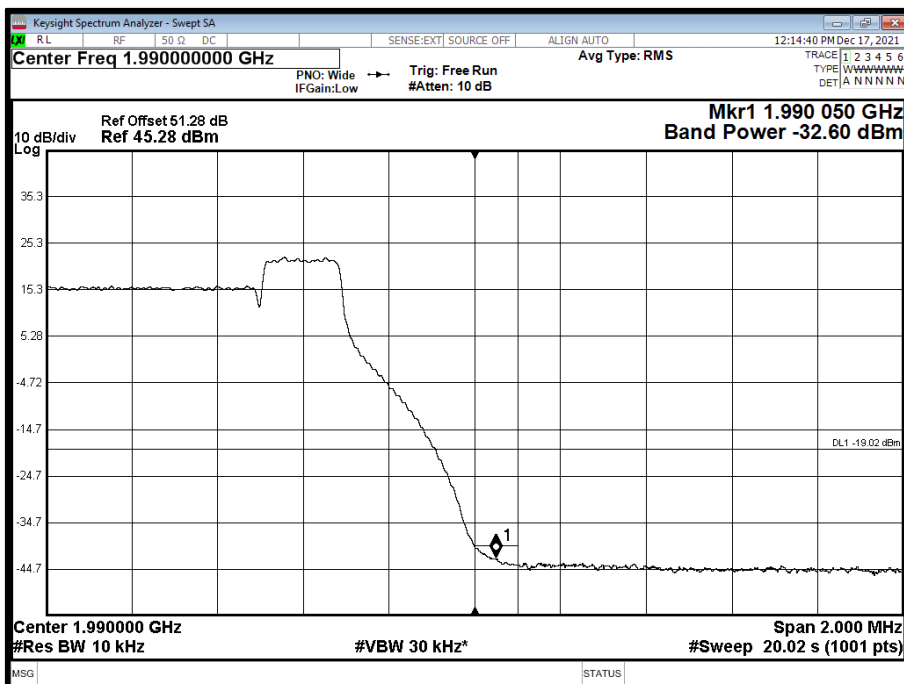



Antenna A - NR Modulation QPSK - NR Carrier Bandwidth 15.0 MHz 15 kHz SCS - Channel Position B

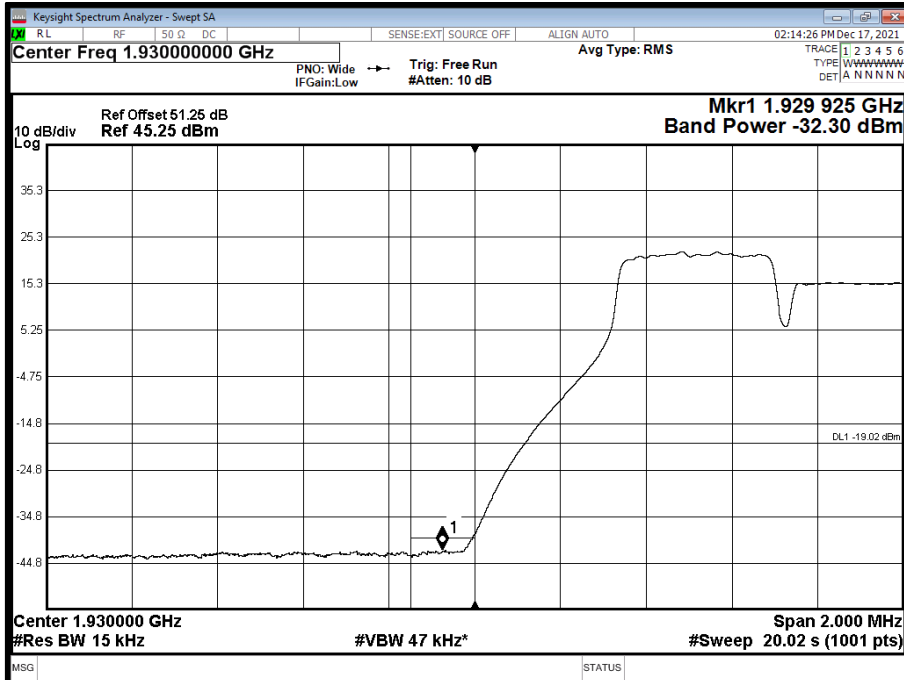

Antenna A - NR Modulation QPSK - NR Carrier Bandwidth 15.0 MHz 15 kHz SCS - Channel Position T

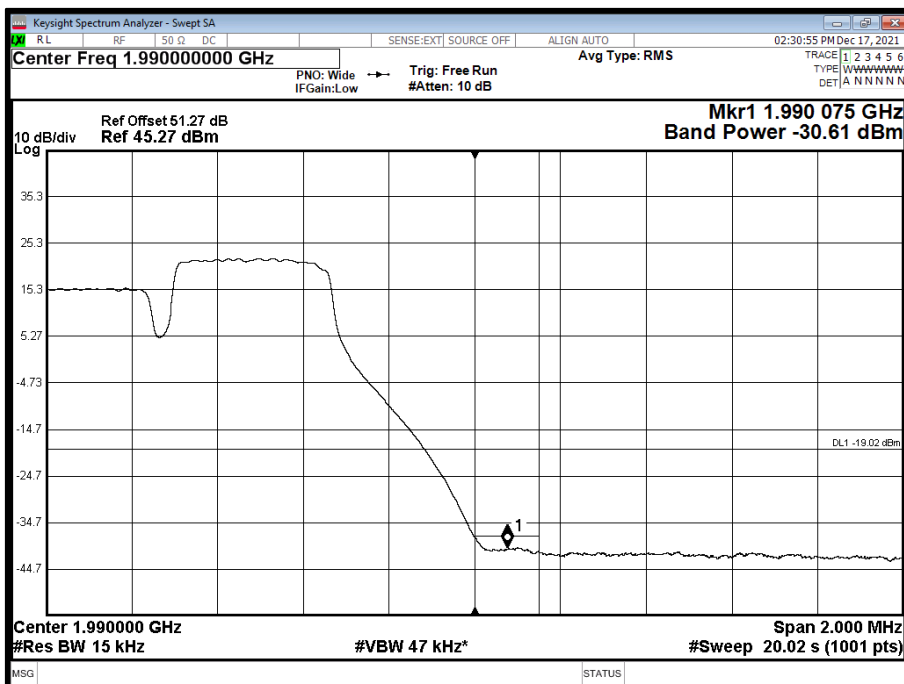



Antenna A - NR Modulation QPSK - NR Carrier Bandwidth 20.0 MHz 15 kHz SCS - Channel Position B

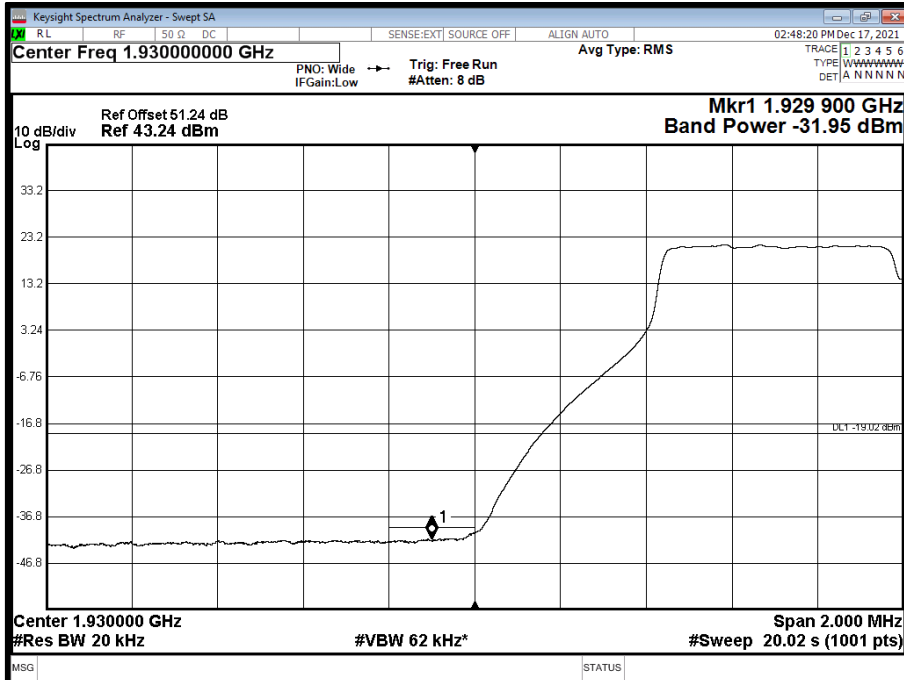

Antenna A - NR Modulation QPSK - NR Carrier Bandwidth 20.0 MHz 15 kHz SCS - Channel Position T

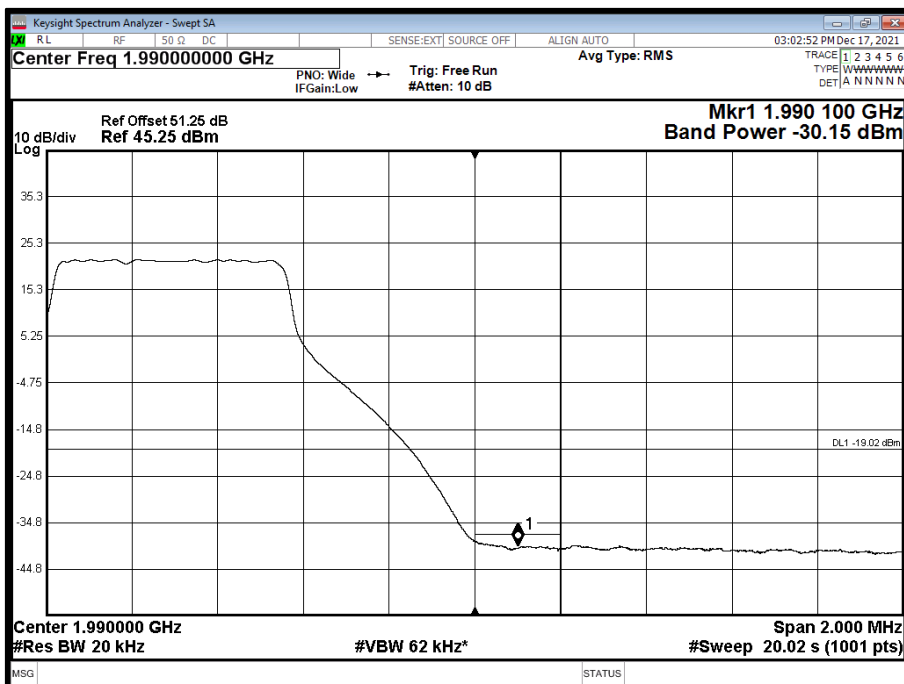

Limit	-19 dBm
-------	---------



2.4 TRANSMITTER SPURIOUS EMISSIONS

2.4.1 Specification Reference

FCC CFR 47 Part 24, Clause 24.238 (a)
ISED RSS-GEN, Clause 6.13
Industry Canada RSS-133, Clause 6.5
FCC CFR 47 Part 2, Clause 2.1051

2.4.2 Date of Test and Modification State

17-December-2021 - Modification State 0

2.4.3 Test Equipment Used

The major items of test equipment used for the above tests are identified in Section 3.1.

2.4.4 Environmental Conditions

Ambient Temperature	21.2°C
Relative Humidity	43.0%

2.4.5 Test Method

All measurements were made in accordance with FCC KDB 971168 D01, Clause 6.1.

Each antenna port has been declared as being equivalent, therefore measurements were made on one antenna port only. To account for this, the limit was tightened by $10 * \text{Log}(N)$, where N is equal to the number of MIMO antenna ports.

For single port, the limit was calculated as being $-13 \text{ dBm} - 10 * \text{Log}(4) = -19 \text{ dBm}$.

2.4.6 Test Results

Configuration 1

Maximum Output Power 46.00 dBm



Antenna A - NR Modulation QPSK - NR Carrier Bandwidth 10.0 MHz 15 kHz SCS - Channel Position B - Band 1.00 - Range 0.009 to 3500 MHz

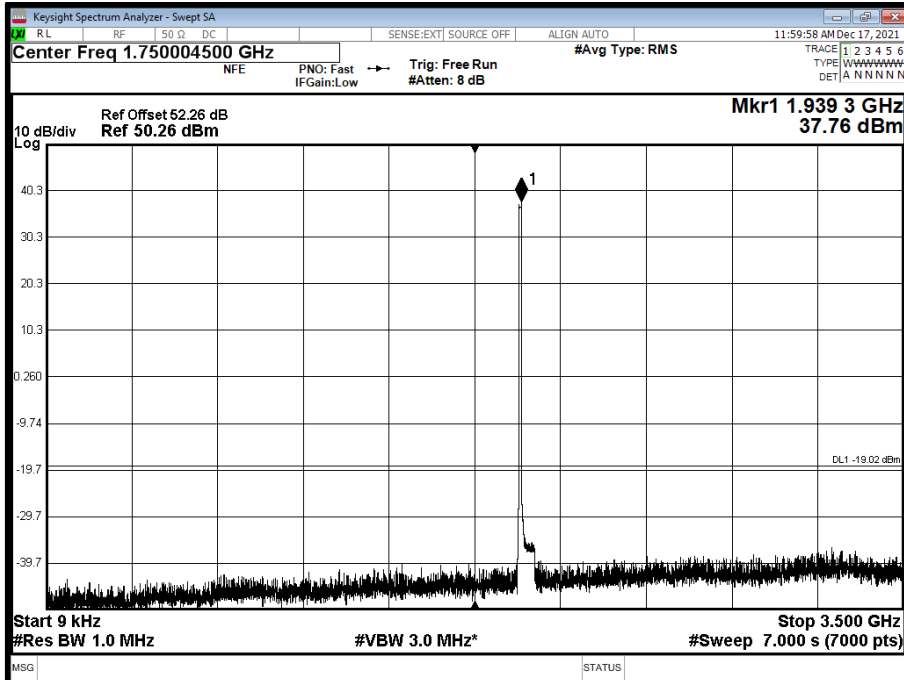

Antenna A - NR Modulation QPSK - NR Carrier Bandwidth 10.0 MHz 15 kHz SCS - Channel Position B - Band 2 - Range 3500 to 8000 MHz

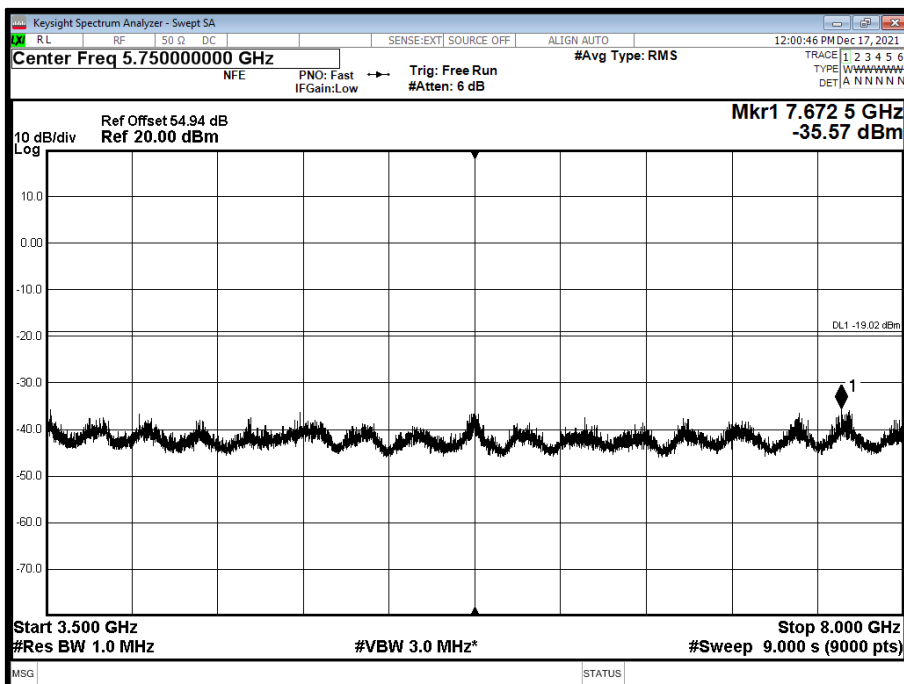



Antenna A - NR Modulation QPSK - NR Carrier Bandwidth 10.0 MHz 15 kHz SCS - Channel Position B - Band 3 - Range 8000 to 12000 MHz

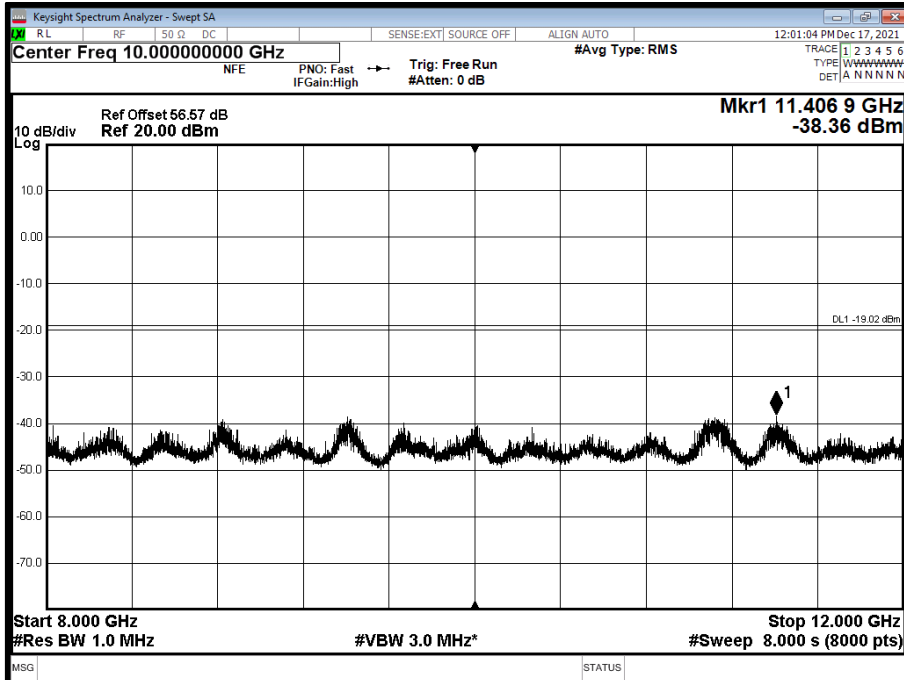

Antenna A - NR Modulation QPSK - NR Carrier Bandwidth 10.0 MHz 15 kHz SCS - Channel Position B - Band 4 - Range 12000 to 18000 MHz

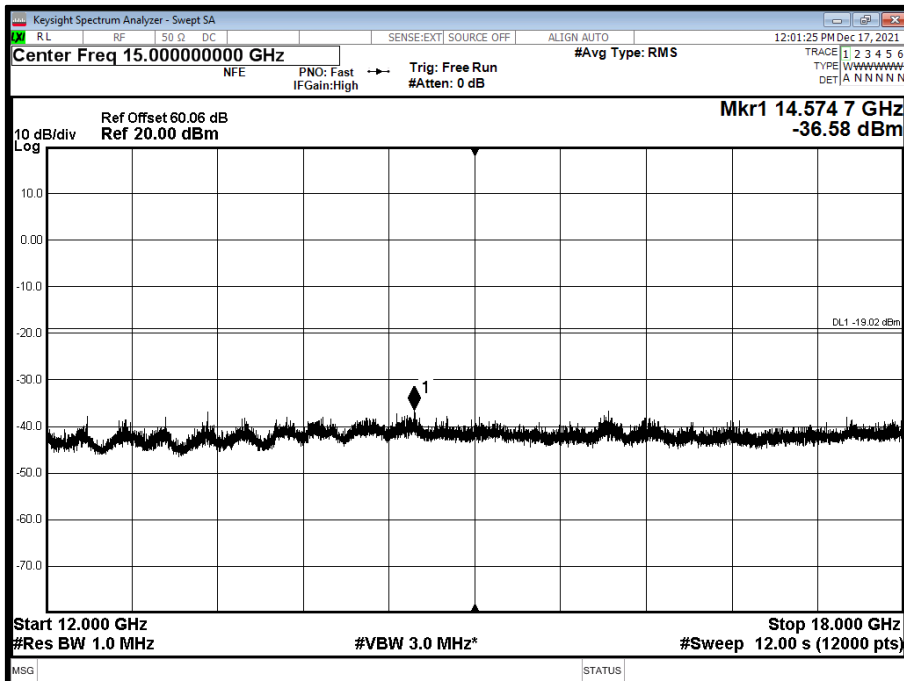



Antenna A - NR Modulation QPSK - NR Carrier Bandwidth 10.0 MHz 15 kHz SCS - Channel Position B - Band 5 - Range 18000 to 20000 MHz

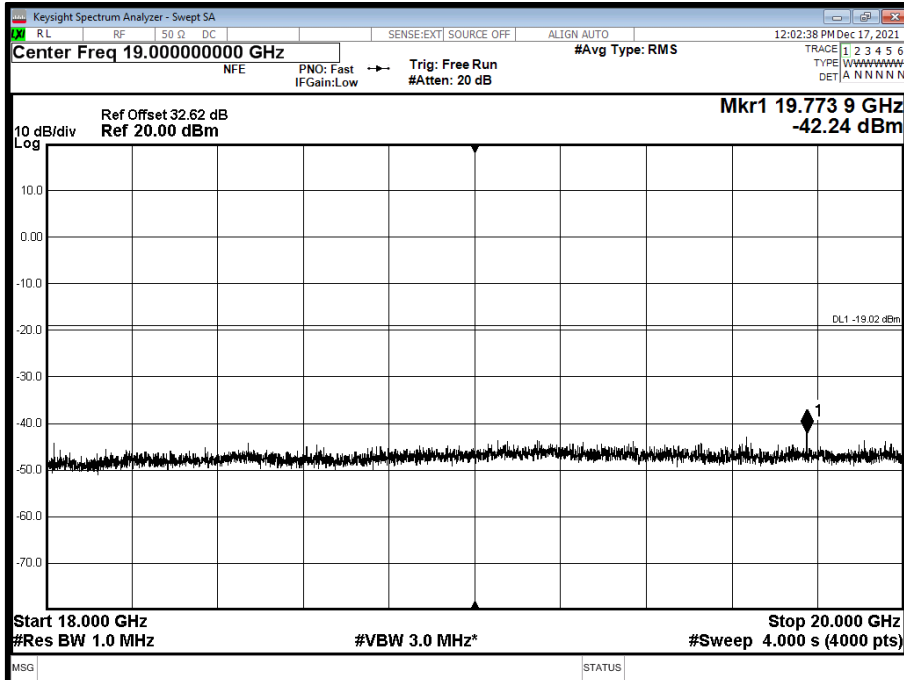

Antenna A - NR Modulation QPSK - NR Carrier Bandwidth 10.0 MHz 15 kHz SCS - Channel Position M - Band 1.00 - Range 0.009 to 3500 MHz

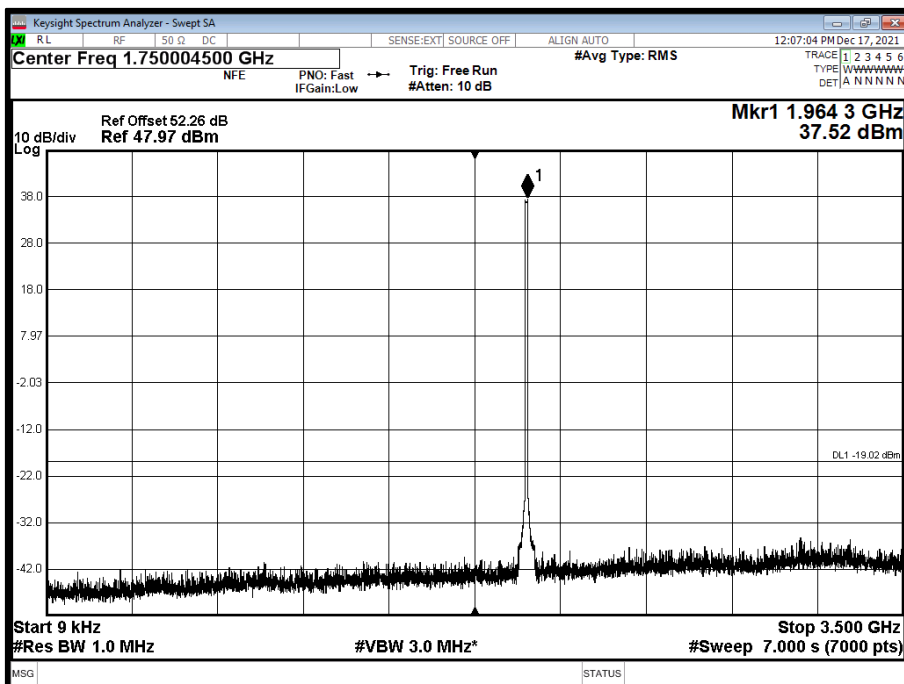



Antenna A - NR Modulation QPSK - NR Carrier Bandwidth 10.0 MHz 15 kHz SCS - Channel Position M - Band 2 - Range 3500 to 8000 MHz

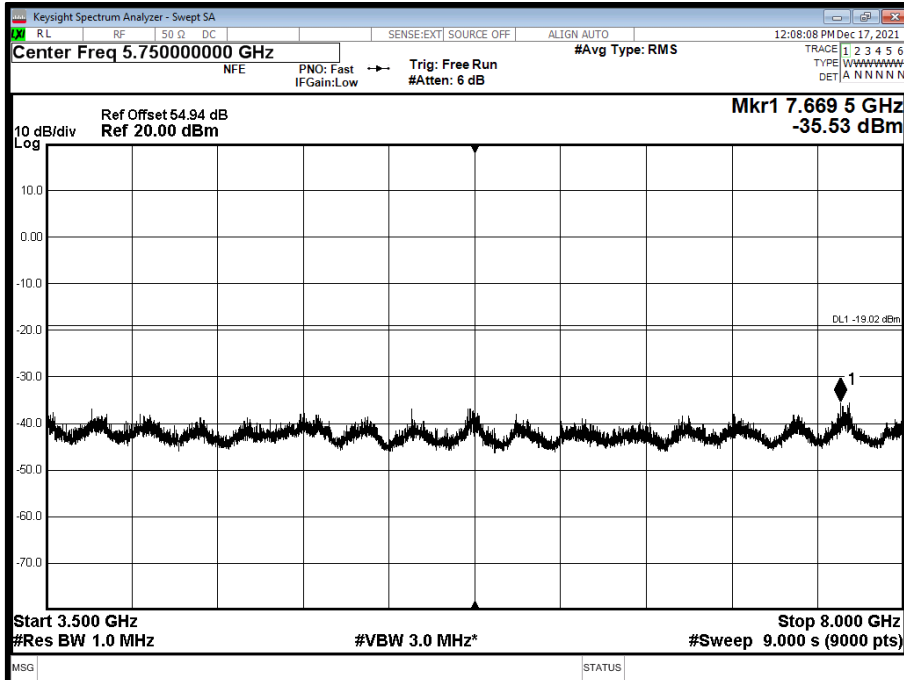

Antenna A - NR Modulation QPSK - NR Carrier Bandwidth 10.0 MHz 15 kHz SCS - Channel Position M - Band 3 - Range 8000 to 12000 MHz

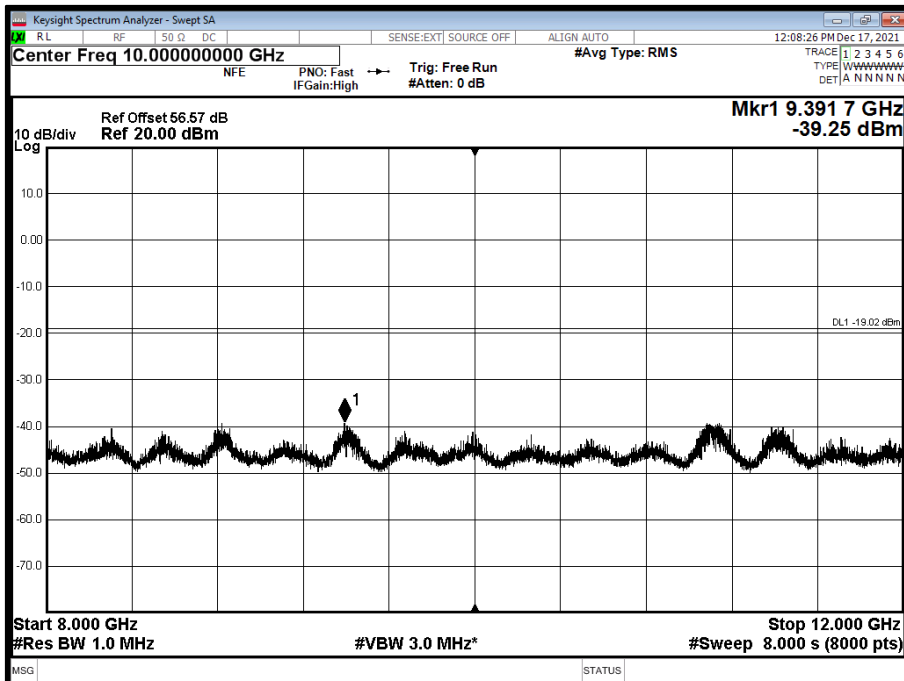



Antenna A - NR Modulation QPSK - NR Carrier Bandwidth 10.0 MHz 15 kHz SCS - Channel Position M - Band 4 - Range 12000 to 18000 MHz

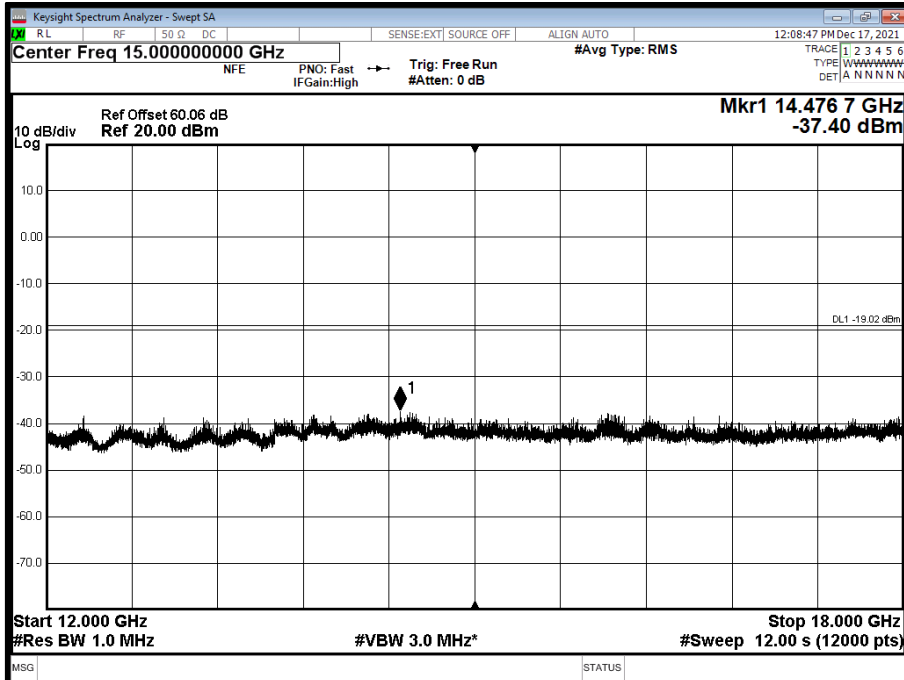

Antenna A - NR Modulation QPSK - NR Carrier Bandwidth 10.0 MHz 15 kHz SCS - Channel Position M - Band 5 - Range 18000 to 20000 MHz

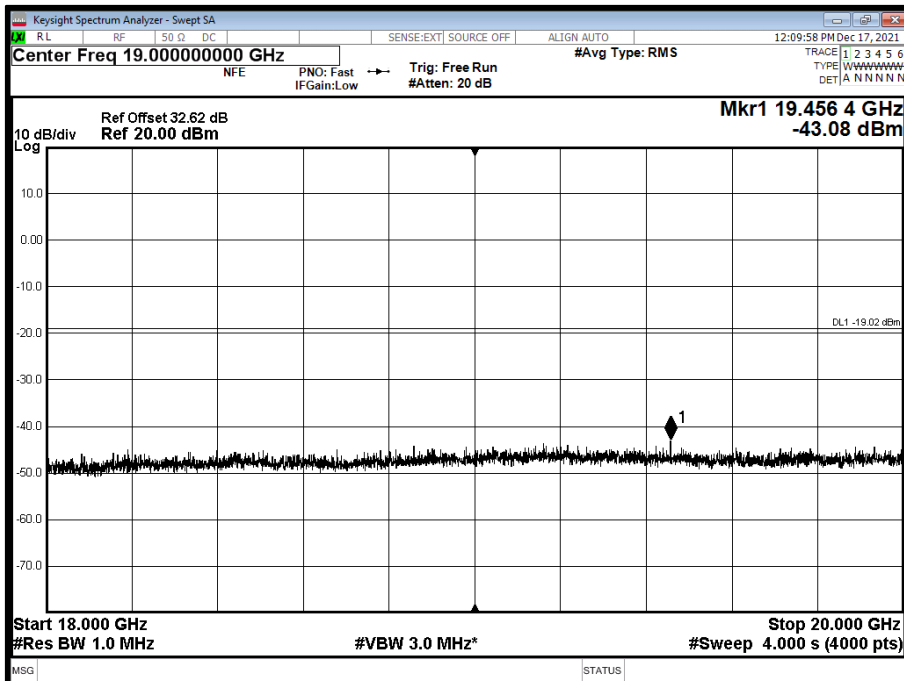



Antenna A - NR Modulation QPSK - NR Carrier Bandwidth 10.0 MHz 15 kHz SCS - Channel Position T - Band 1.00 - Range 0.009 to 3500 MHz

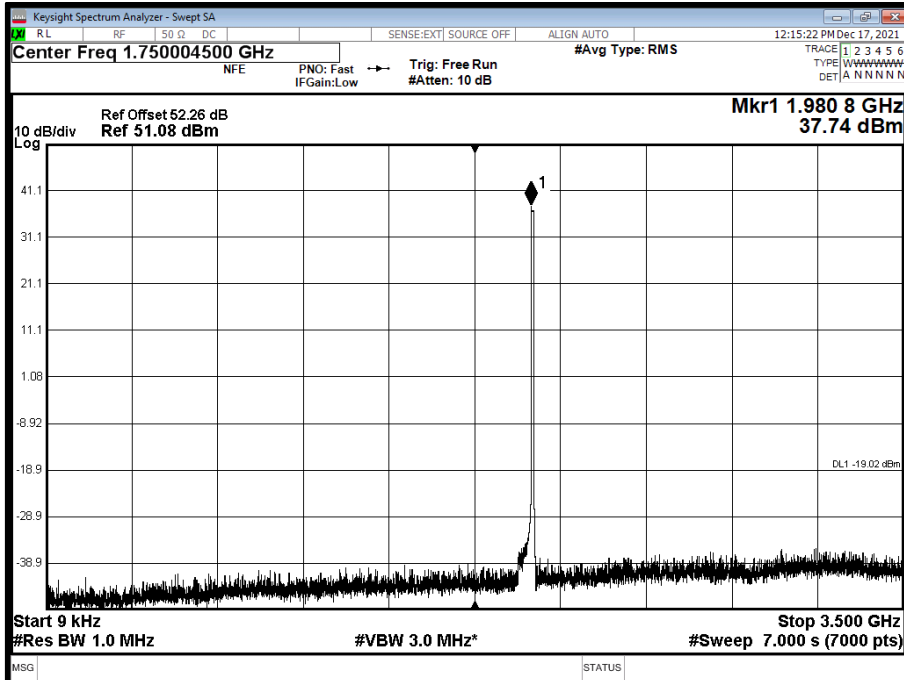

Antenna A - NR Modulation QPSK - NR Carrier Bandwidth 10.0 MHz 15 kHz SCS - Channel Position T - Band 2 - Range 3500 to 8000 MHz

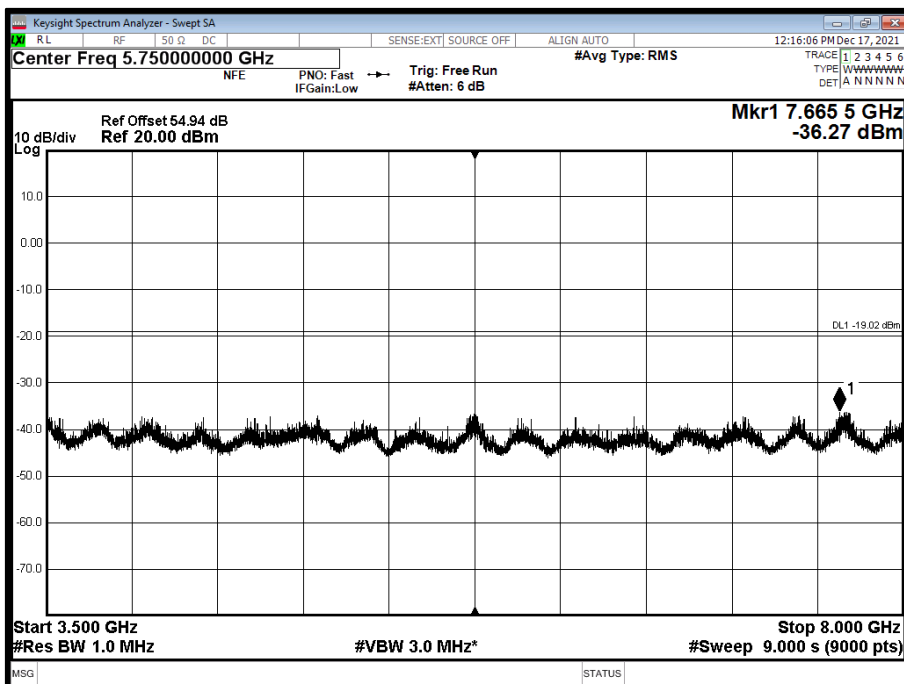



Antenna A - NR Modulation QPSK - NR Carrier Bandwidth 10.0 MHz 15 kHz SCS - Channel Position T - Band 3 - Range 8000 to 12000 MHz

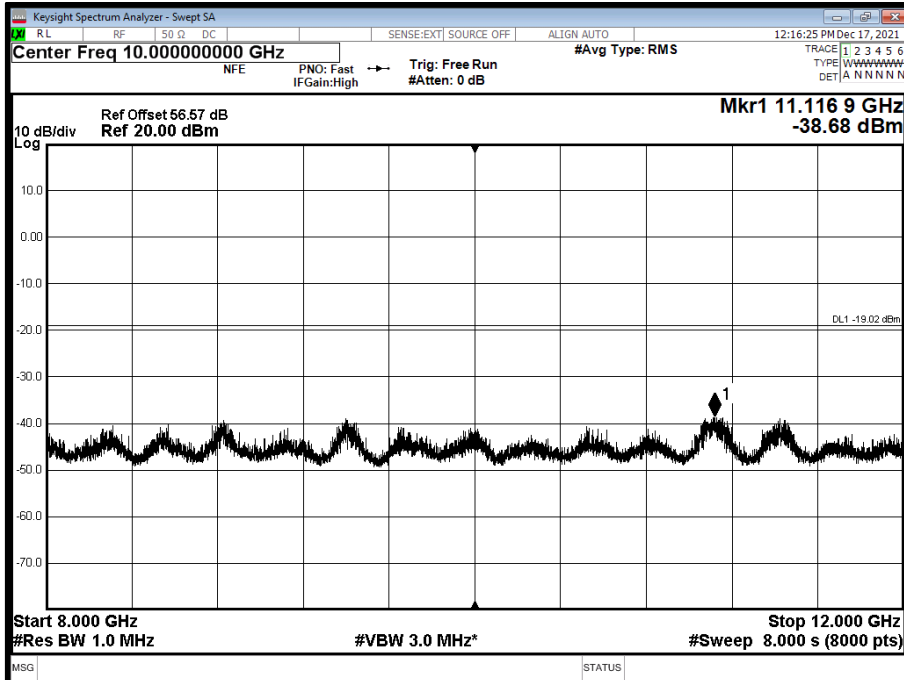

Antenna A - NR Modulation QPSK - NR Carrier Bandwidth 10.0 MHz 15 kHz SCS - Channel Position T - Band 4 - Range 12000 to 18000 MHz

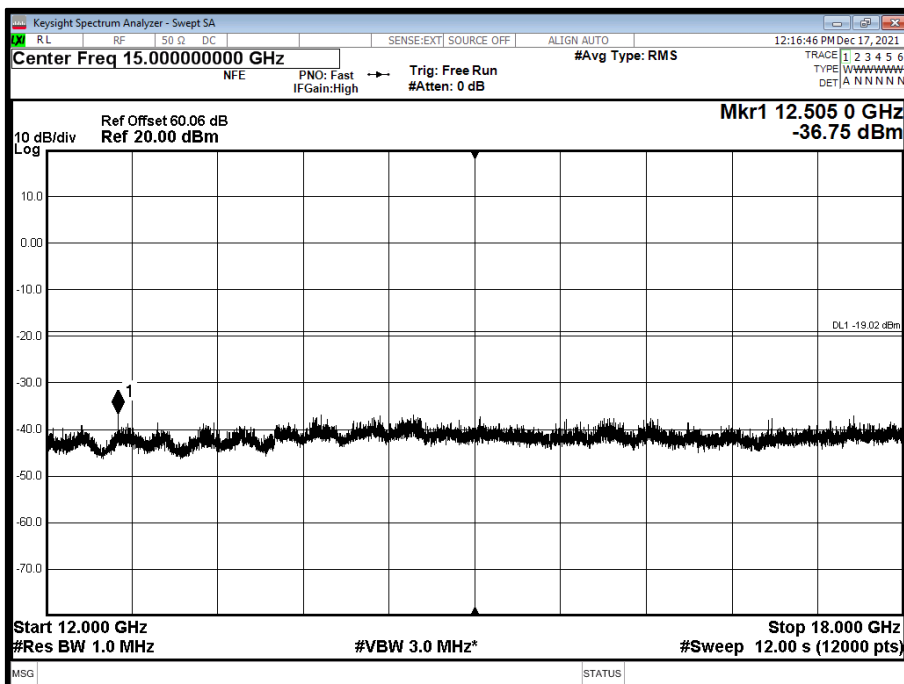



Antenna A - NR Modulation QPSK - NR Carrier Bandwidth 10.0 MHz 15 kHz SCS - Channel Position T - Band 5 - Range 18000 to 20000 MHz

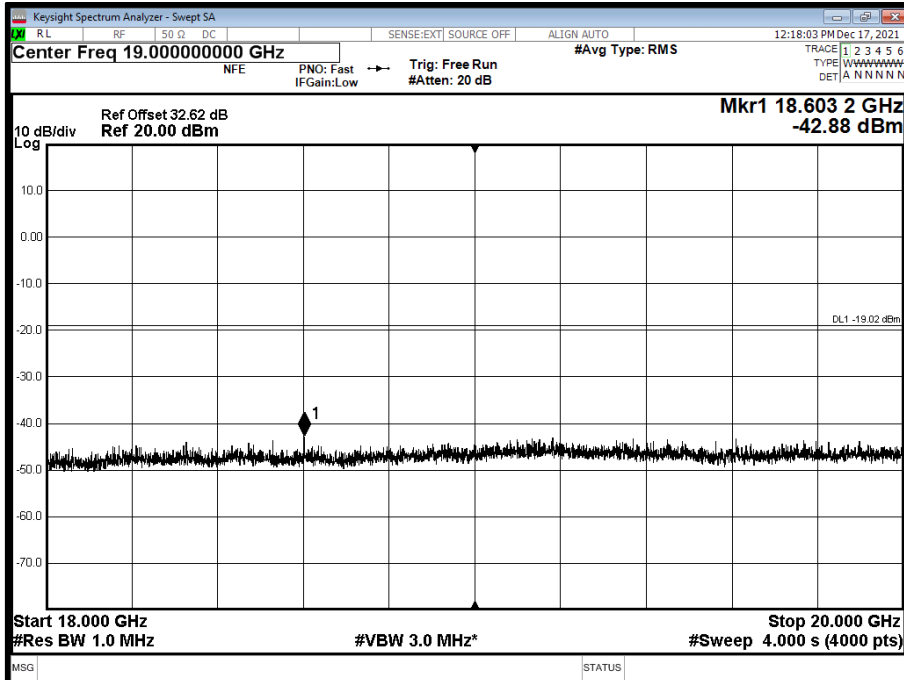

Antenna A - NR Modulation QPSK - NR Carrier Bandwidth 15.0 MHz 15 kHz SCS - Channel Position B - Band 1.00 - Range 0.009 to 3500 MHz

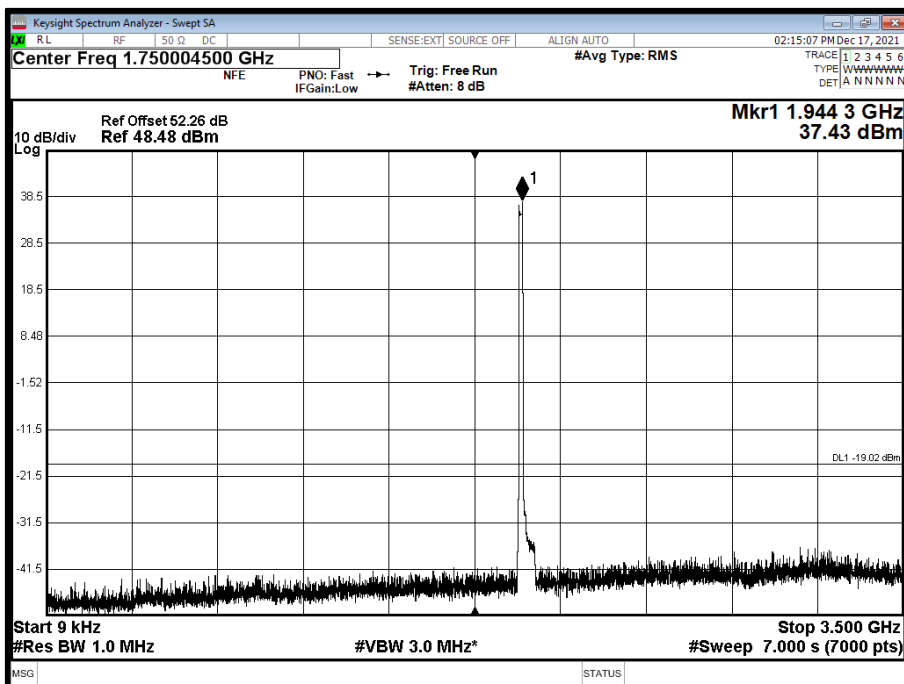



Antenna A - NR Modulation QPSK - NR Carrier Bandwidth 15.0 MHz 15 kHz SCS - Channel Position B - Band 2 - Range 3500 to 8000 MHz

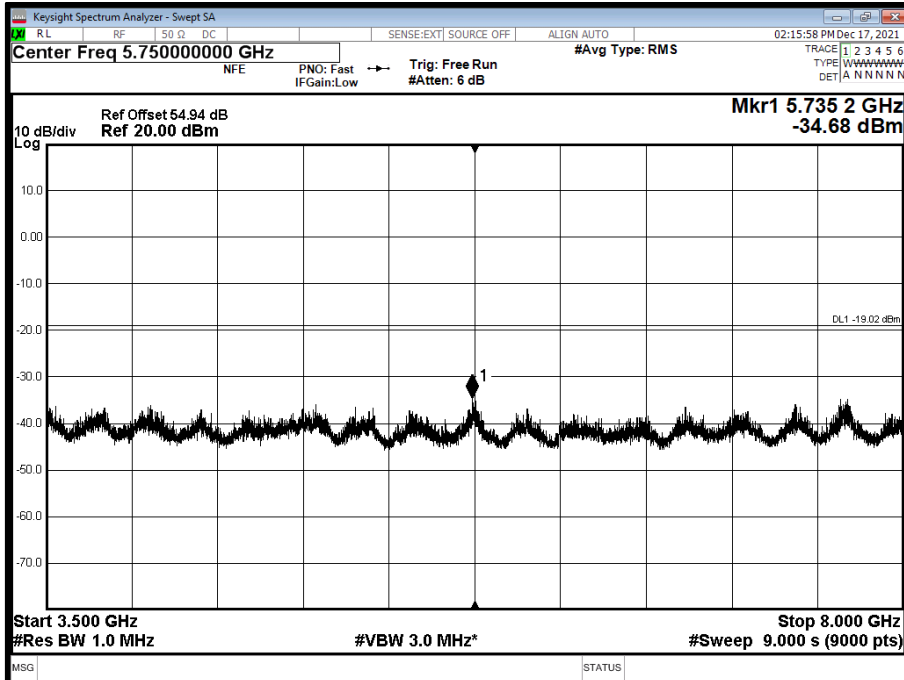

Antenna A - NR Modulation QPSK - NR Carrier Bandwidth 15.0 MHz 15 kHz SCS - Channel Position B - Band 3 - Range 8000 to 12000 MHz

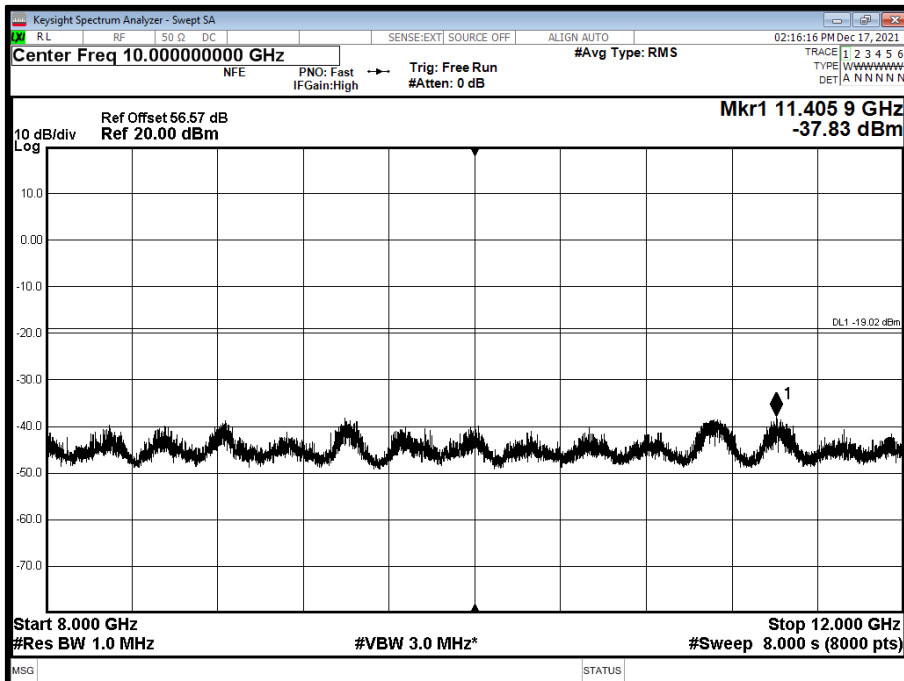



Antenna A - NR Modulation QPSK - NR Carrier Bandwidth 15.0 MHz 15 kHz SCS - Channel Position B - Band 4 - Range 12000 to 18000 MHz

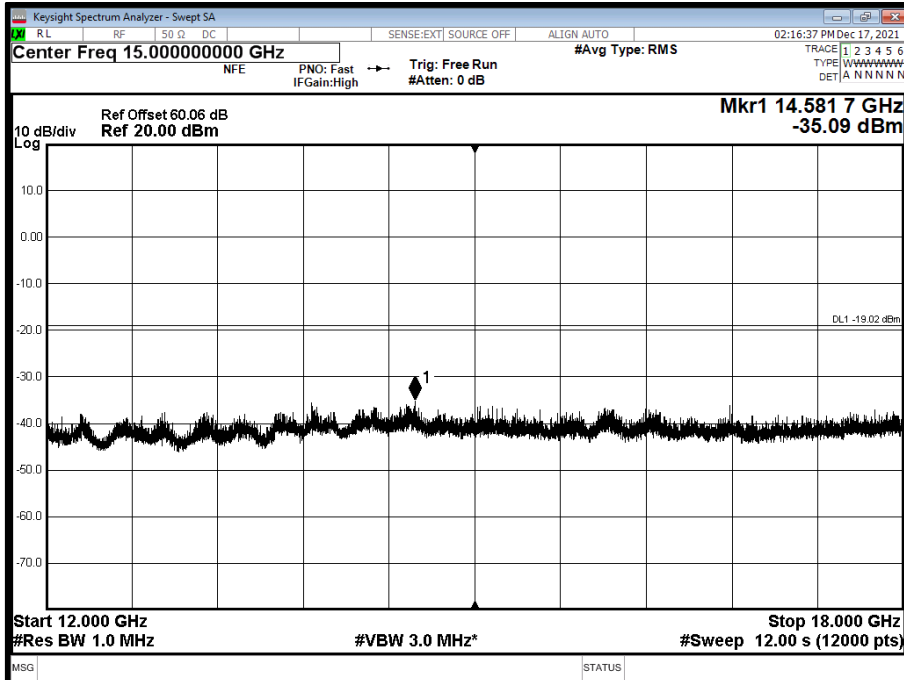

Antenna A - NR Modulation QPSK - NR Carrier Bandwidth 15.0 MHz 15 kHz SCS - Channel Position B - Band 5 - Range 18000 to 20000 MHz

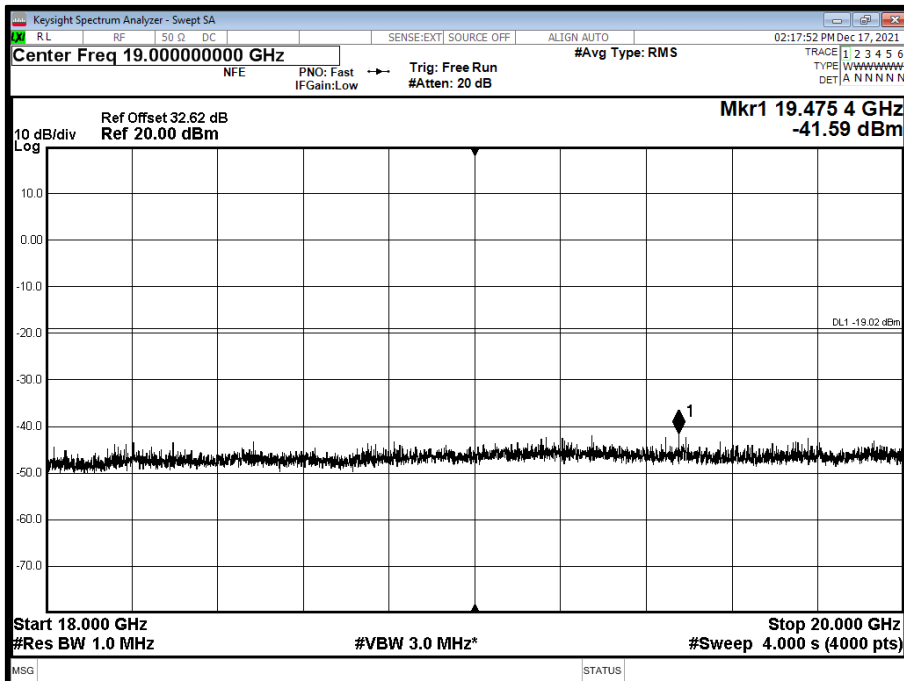



Antenna A - NR Modulation QPSK - NR Carrier Bandwidth 15.0 MHz 15 kHz SCS - Channel Position M - Band 1.00 - Range 0.009 to 3500 MHz

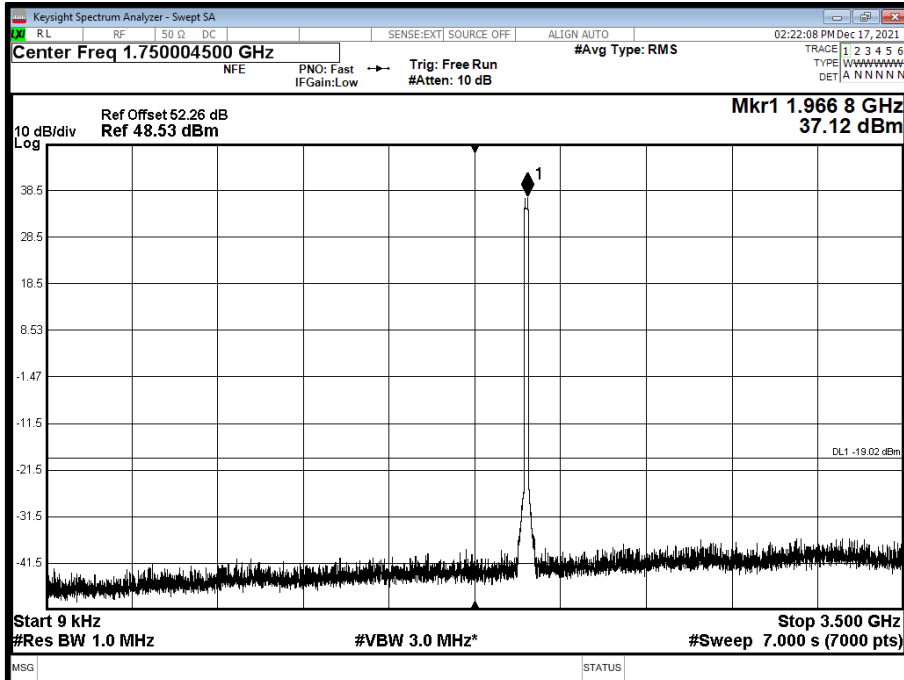

Antenna A - NR Modulation QPSK - NR Carrier Bandwidth 15.0 MHz 15 kHz SCS - Channel Position M - Band 2 - Range 3500 to 8000 MHz

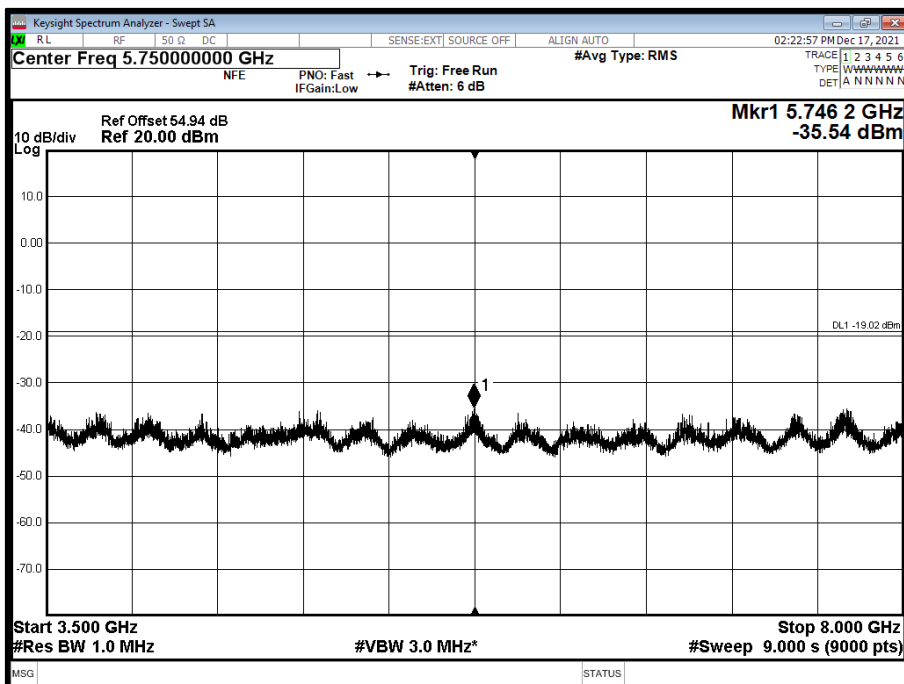



Antenna A - NR Modulation QPSK - NR Carrier Bandwidth 15.0 MHz 15 kHz SCS - Channel Position M - Band 3 - Range 8000 to 12000 MHz

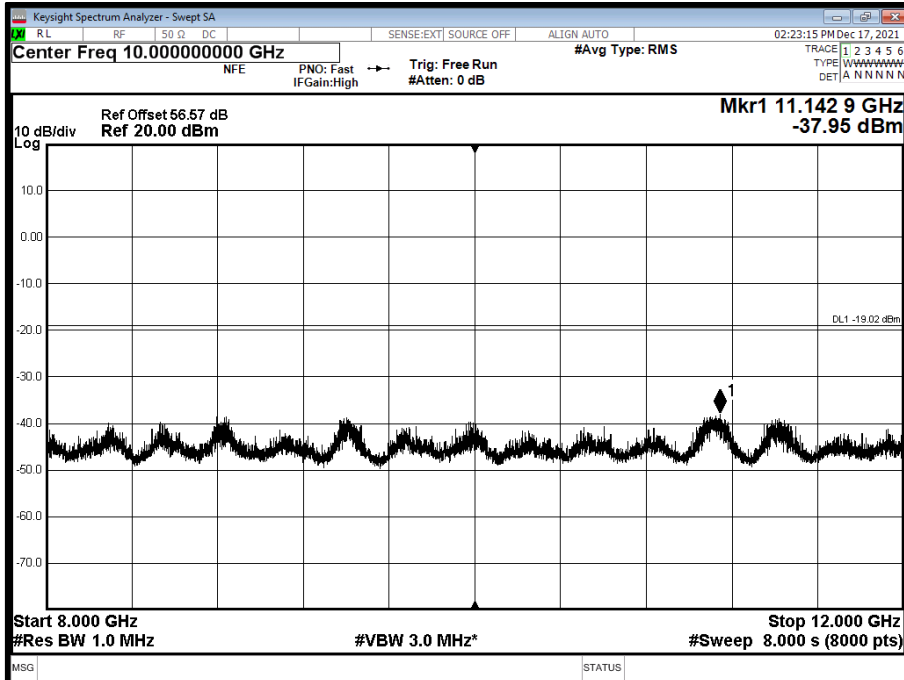

Antenna A - NR Modulation QPSK - NR Carrier Bandwidth 15.0 MHz 15 kHz SCS - Channel Position M - Band 4 - Range 12000 to 18000 MHz

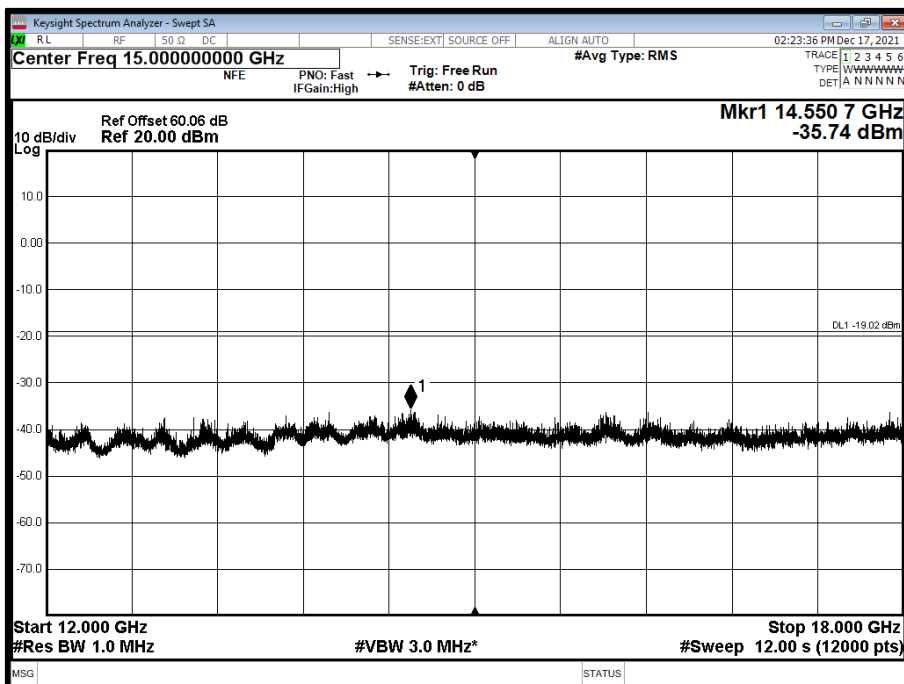



Antenna A - NR Modulation QPSK - NR Carrier Bandwidth 15.0 MHz 15 kHz SCS - Channel Position M - Band 5 - Range 18000 to 20000 MHz

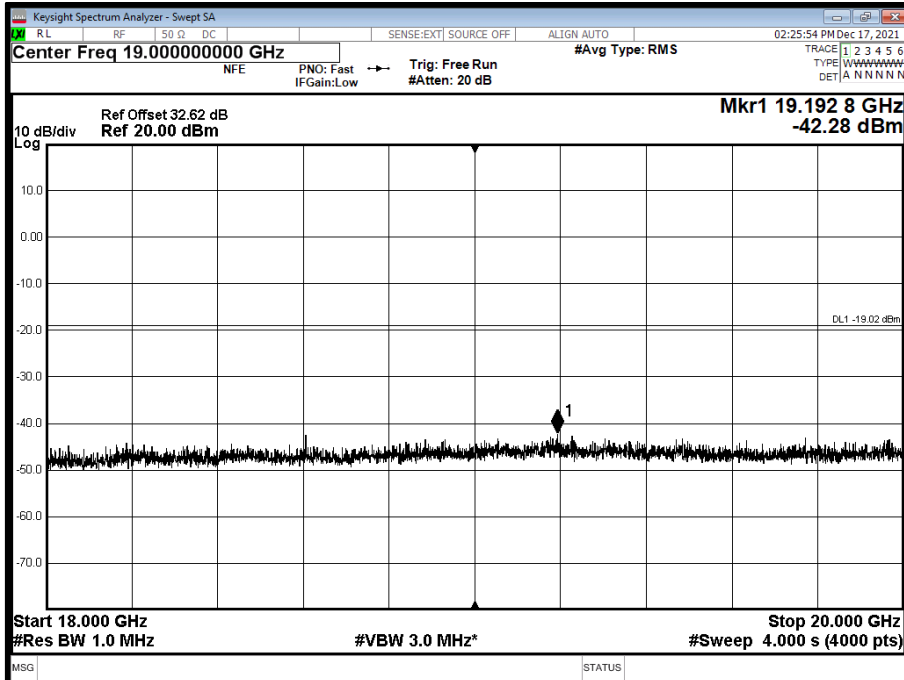

Antenna A - NR Modulation QPSK - NR Carrier Bandwidth 15.0 MHz 15 kHz SCS - Channel Position T - Band 1.00 - Range 0.009 to 3500 MHz

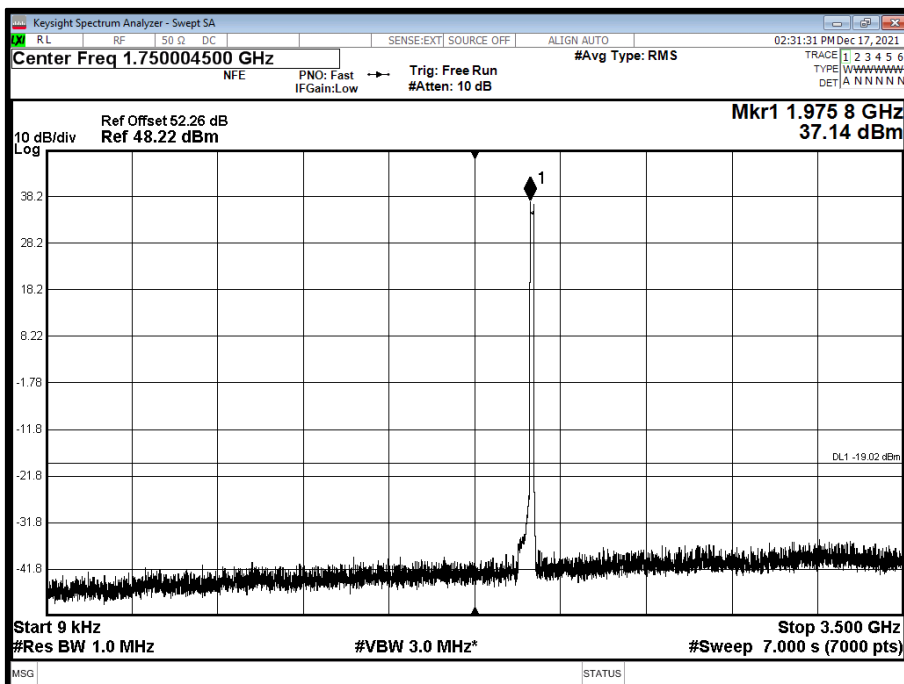



Antenna A - NR Modulation QPSK - NR Carrier Bandwidth 15.0 MHz 15 kHz SCS - Channel Position T - Band 2 - Range 3500 to 8000 MHz

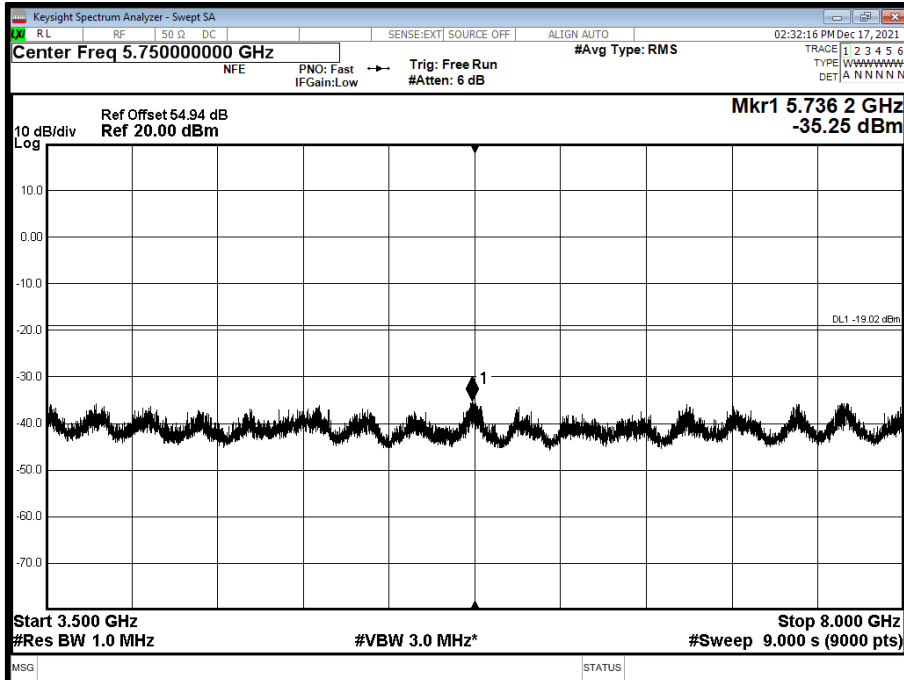

Antenna A - NR Modulation QPSK - NR Carrier Bandwidth 15.0 MHz 15 kHz SCS - Channel Position T - Band 3 - Range 8000 to 12000 MHz

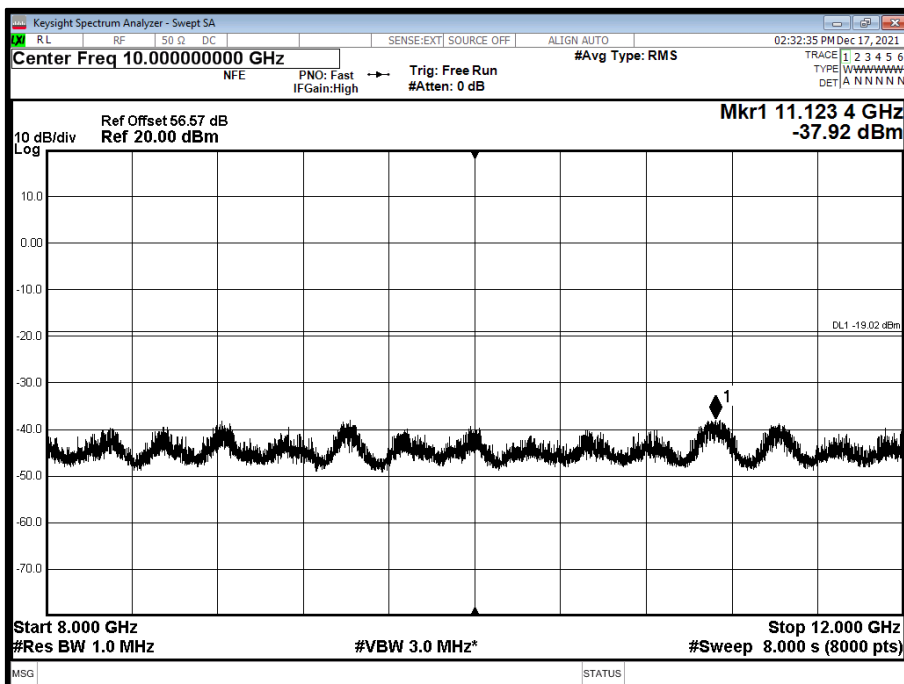



Antenna A - NR Modulation QPSK - NR Carrier Bandwidth 15.0 MHz 15 kHz SCS - Channel Position T - Band 4 - Range 12000 to 18000 MHz

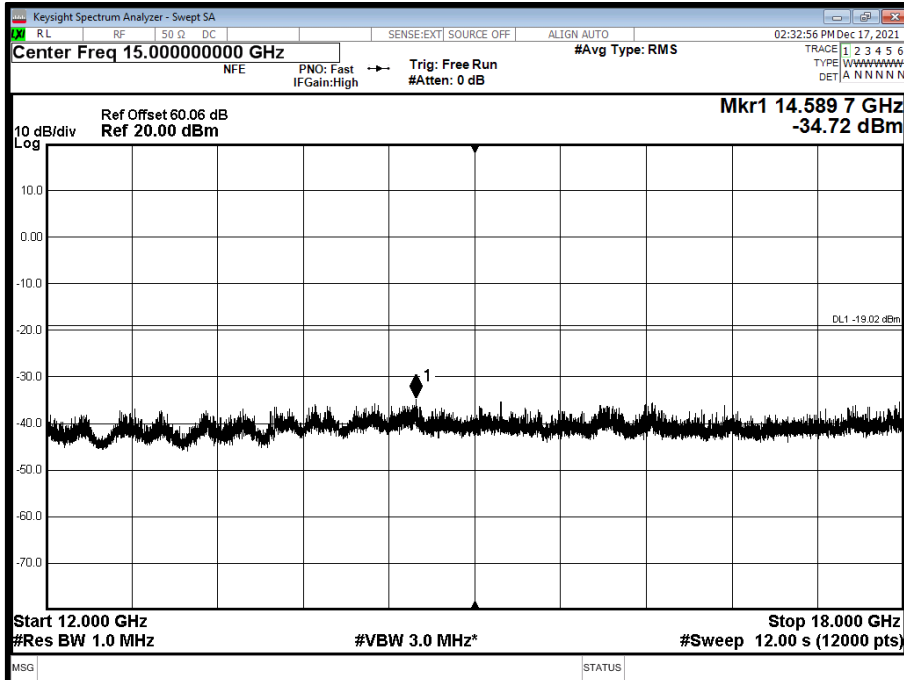

Antenna A - NR Modulation QPSK - NR Carrier Bandwidth 15.0 MHz 15 kHz SCS - Channel Position T - Band 5 - Range 18000 to 20000 MHz

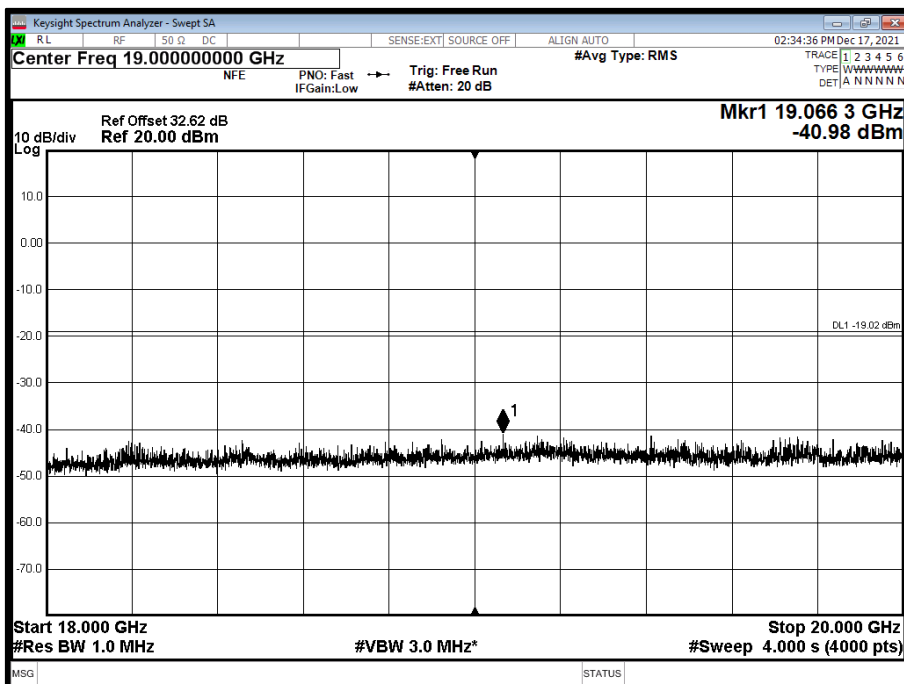



Antenna A - NR Modulation QPSK - NR Carrier Bandwidth 20.0 MHz 15 kHz SCS - Channel Position B - Band 1.00 - Range 0.009 to 3500 MHz

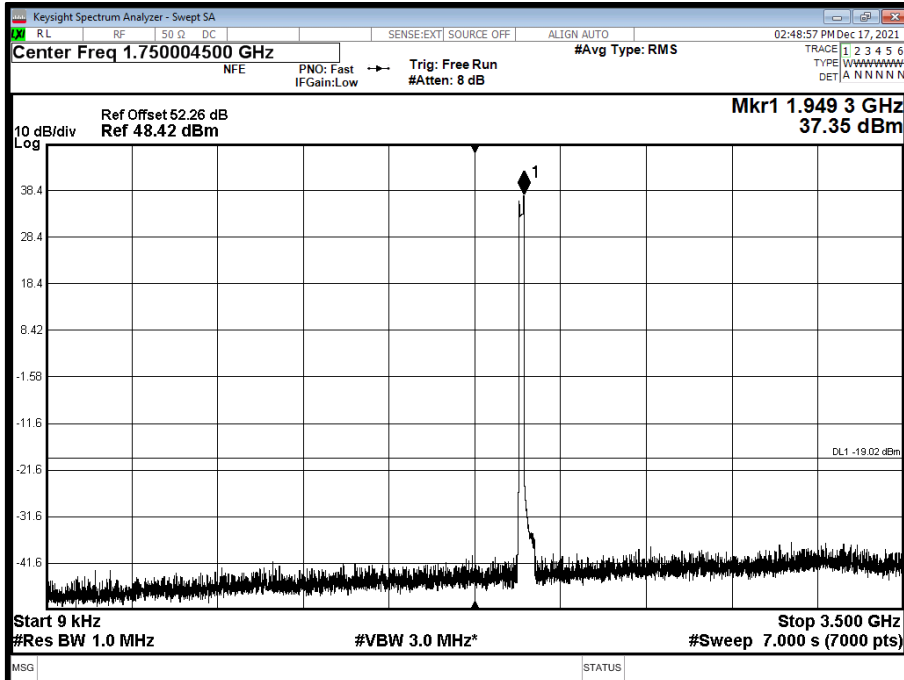

Antenna A - NR Modulation QPSK - NR Carrier Bandwidth 20.0 MHz 15 kHz SCS - Channel Position B - Band 2 - Range 3500 to 8000 MHz

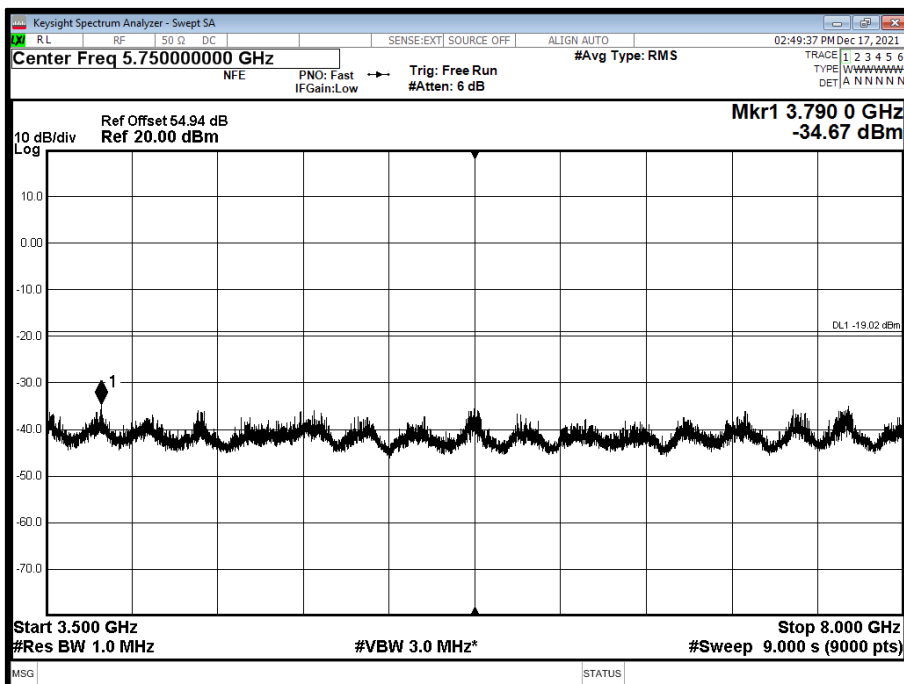



Antenna A - NR Modulation QPSK - NR Carrier Bandwidth 20.0 MHz 15 kHz SCS - Channel Position B - Band 3 - Range 8000 to 12000 MHz

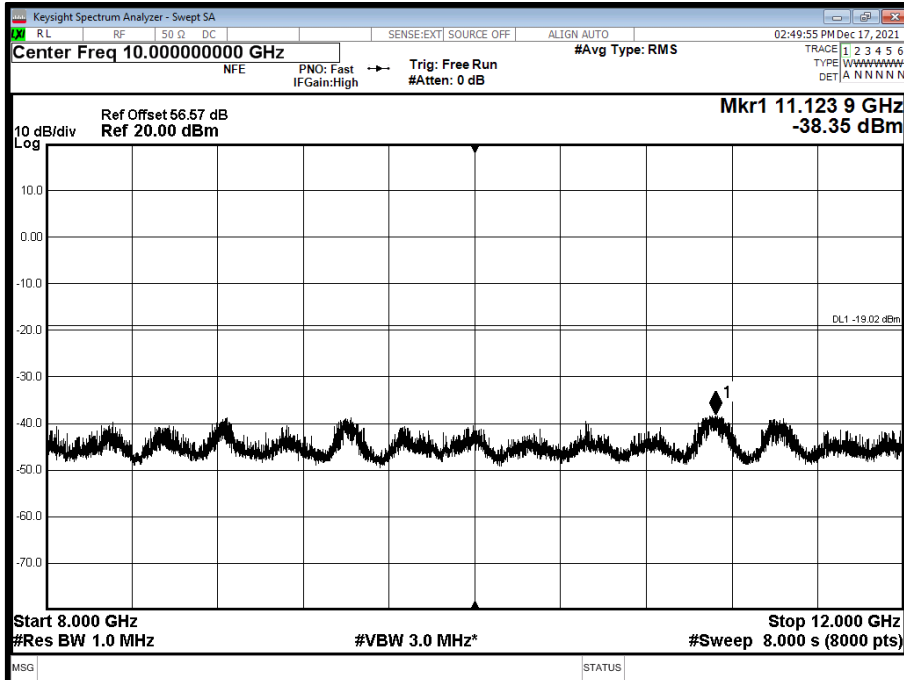

Antenna A - NR Modulation QPSK - NR Carrier Bandwidth 20.0 MHz 15 kHz SCS - Channel Position B - Band 4 - Range 12000 to 18000 MHz

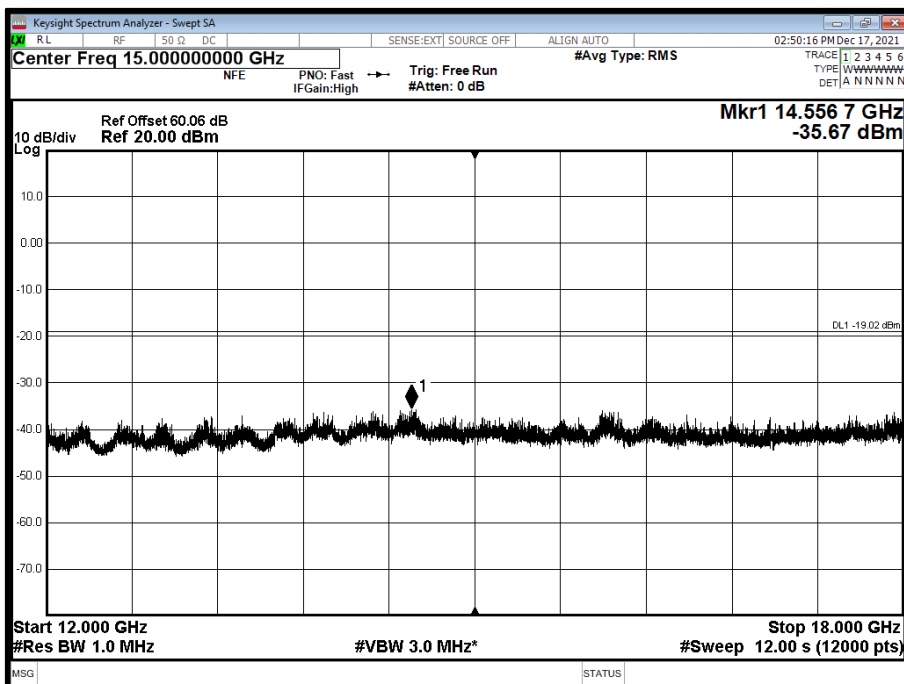



Antenna A - NR Modulation QPSK - NR Carrier Bandwidth 20.0 MHz 15 kHz SCS - Channel Position B - Band 5 - Range 18000 to 20000 MHz

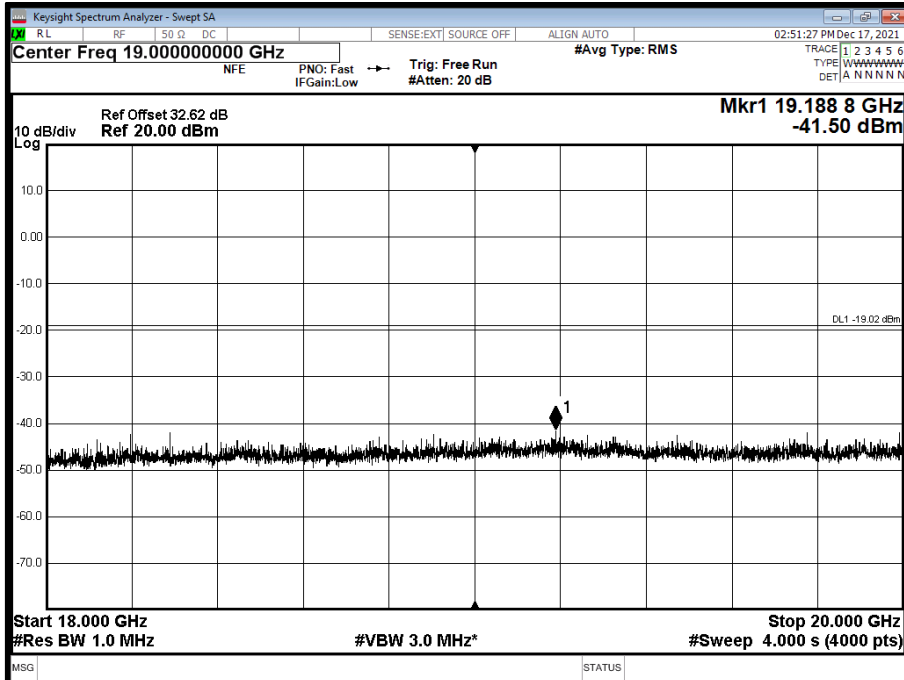

Antenna A - NR Modulation QPSK - NR Carrier Bandwidth 20.0 MHz 15 kHz SCS - Channel Position M - Band 1.00 - Range 0.009 to 3500 MHz

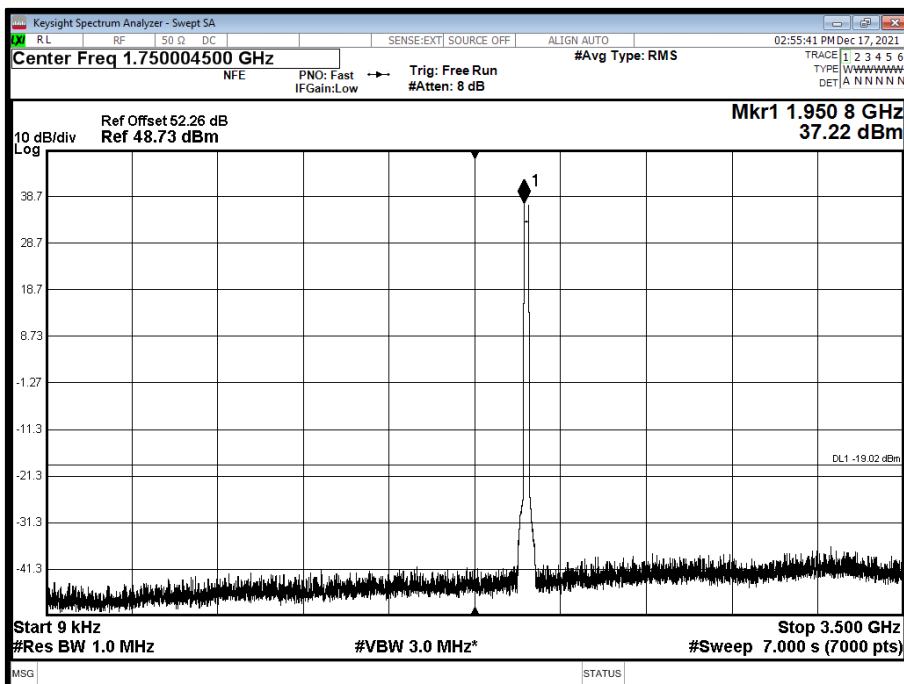



Antenna A - NR Modulation QPSK - NR Carrier Bandwidth 20.0 MHz 15 kHz SCS - Channel Position M - Band 2 - Range 3500 to 8000 MHz

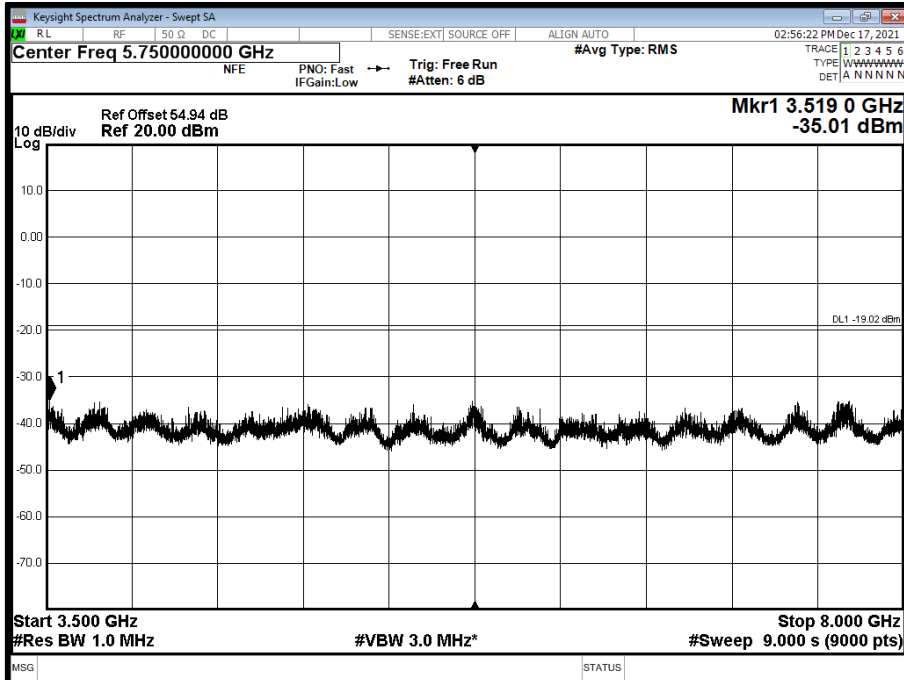

Antenna A - NR Modulation QPSK - NR Carrier Bandwidth 20.0 MHz 15 kHz SCS - Channel Position M - Band 3 - Range 8000 to 12000 MHz

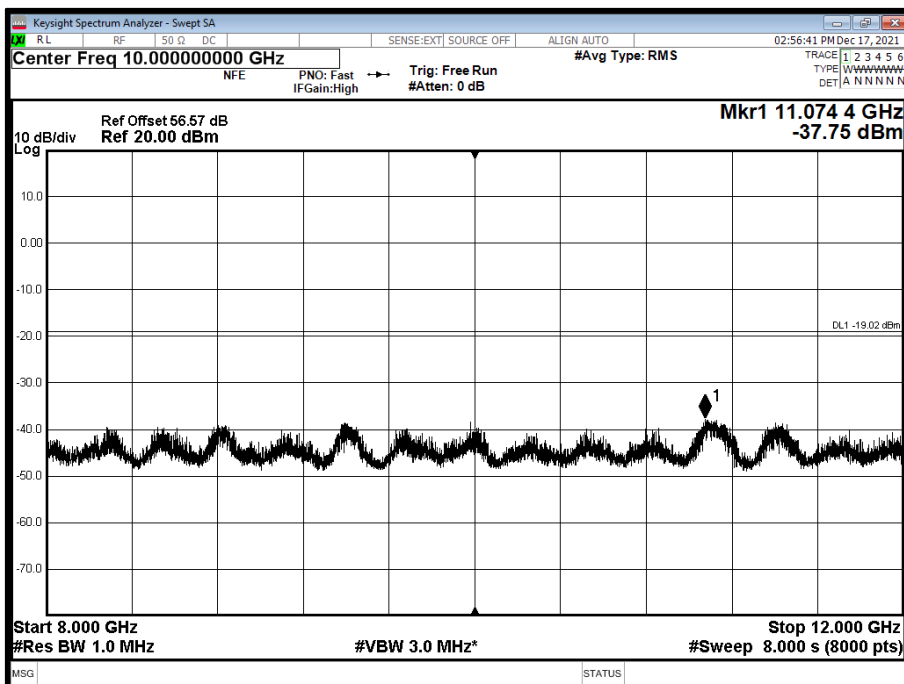



Antenna A - NR Modulation QPSK - NR Carrier Bandwidth 20.0 MHz 15 kHz SCS - Channel Position M - Band 4 - Range 12000 to 18000 MHz

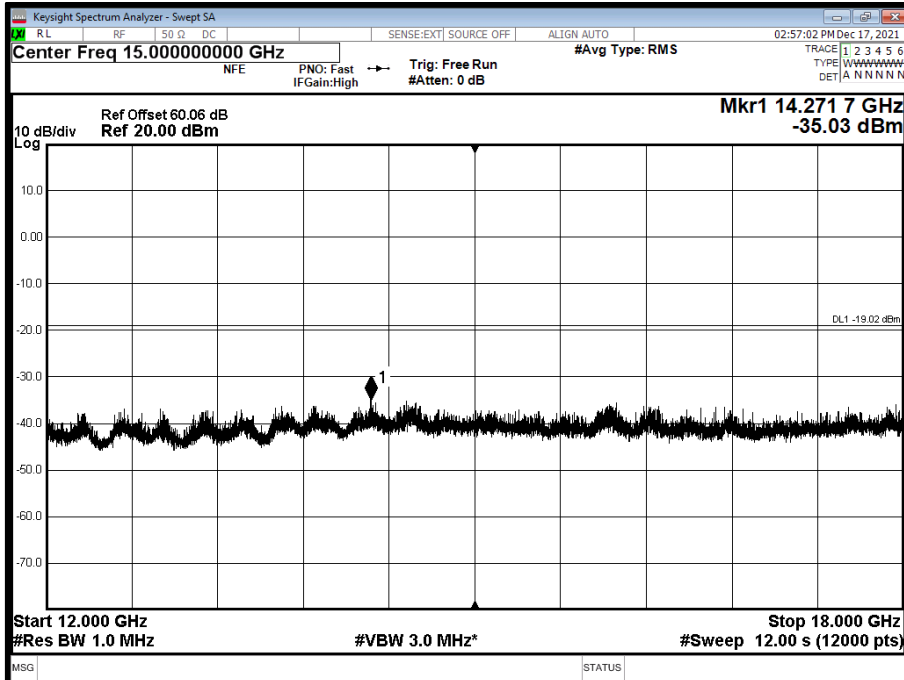

Antenna A - NR Modulation QPSK - NR Carrier Bandwidth 20.0 MHz 15 kHz SCS - Channel Position M - Band 5 - Range 18000 to 20000 MHz

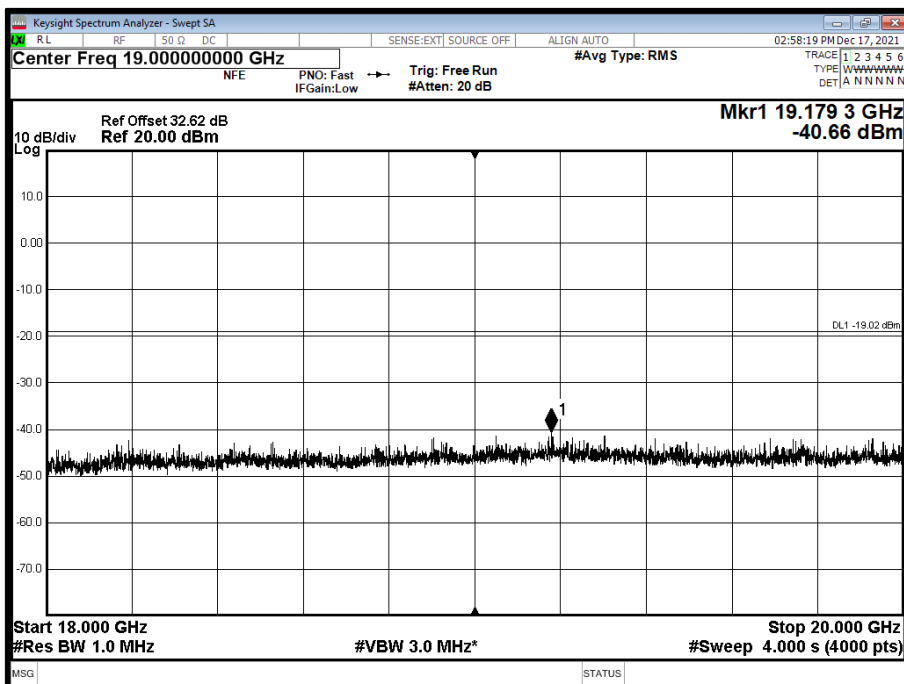



Antenna A - NR Modulation QPSK - NR Carrier Bandwidth 20.0 MHz 15 kHz SCS - Channel Position T - Band 1.00 - Range 0.009 to 3500 MHz

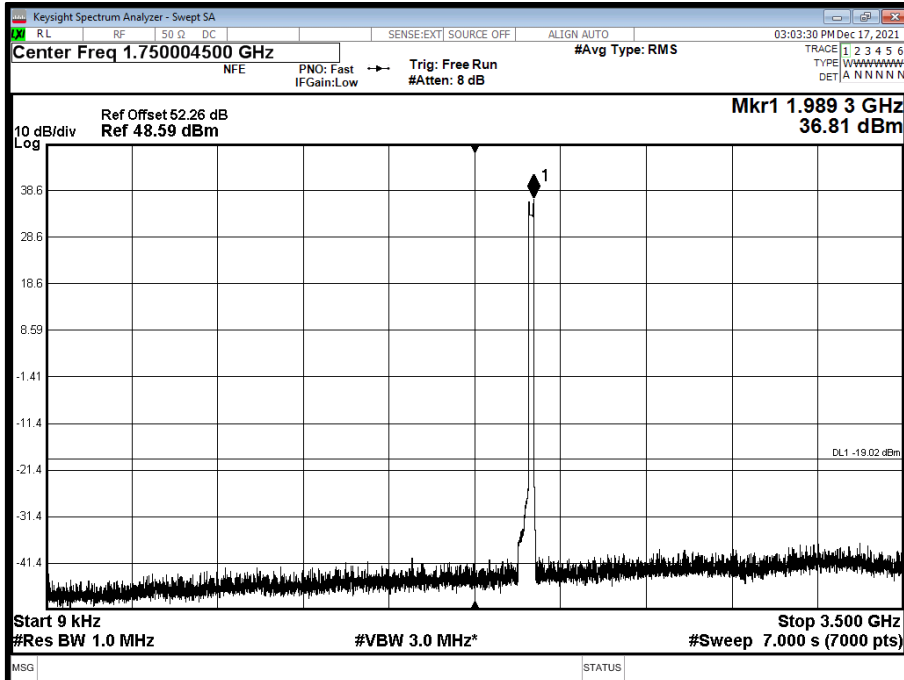

Antenna A - NR Modulation QPSK - NR Carrier Bandwidth 20.0 MHz 15 kHz SCS - Channel Position T - Band 2 - Range 3500 to 8000 MHz

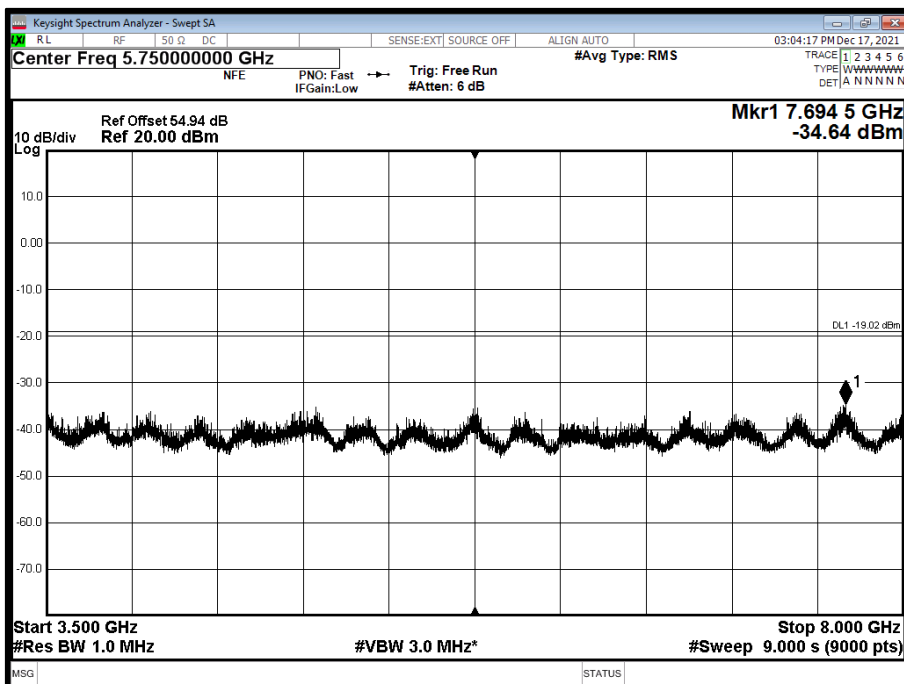



Antenna A - NR Modulation QPSK - NR Carrier Bandwidth 20.0 MHz 15 kHz SCS - Channel Position T - Band 3 - Range 8000 to 12000 MHz

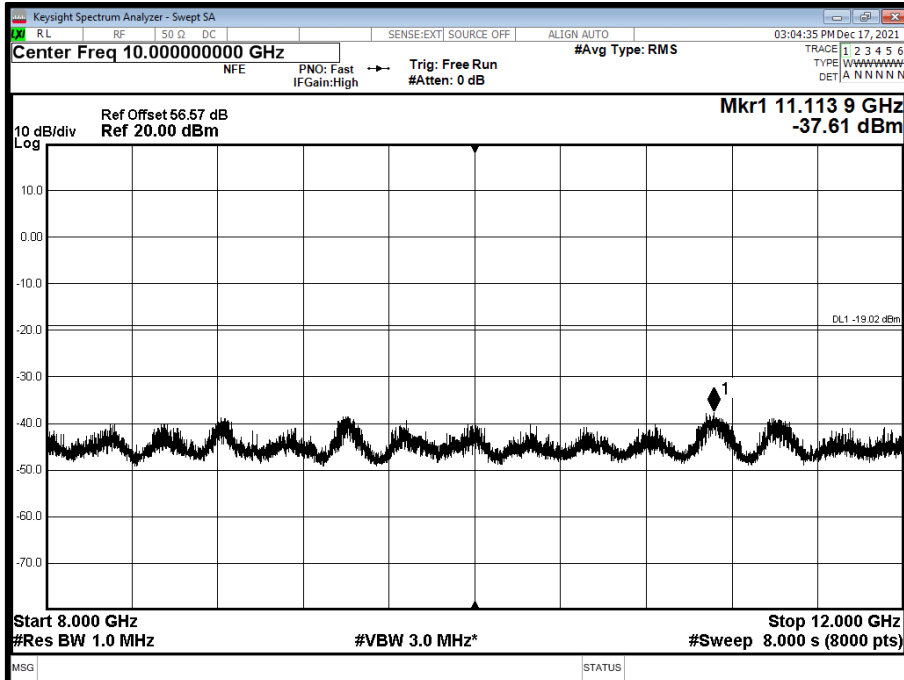

Antenna A - NR Modulation QPSK - NR Carrier Bandwidth 20.0 MHz 15 kHz SCS - Channel Position T - Band 4 - Range 12000 to 18000 MHz

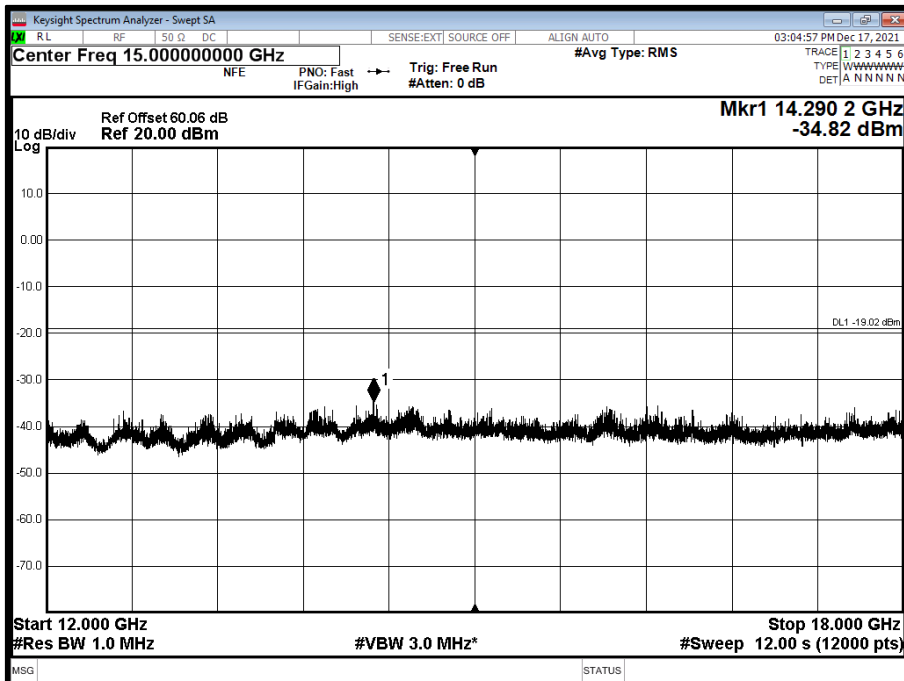



Antenna A - NR Modulation QPSK - NR Carrier Bandwidth 20.0 MHz 15 kHz SCS - Channel Position T - Band 5 - Range 18000 to 20000 MHz

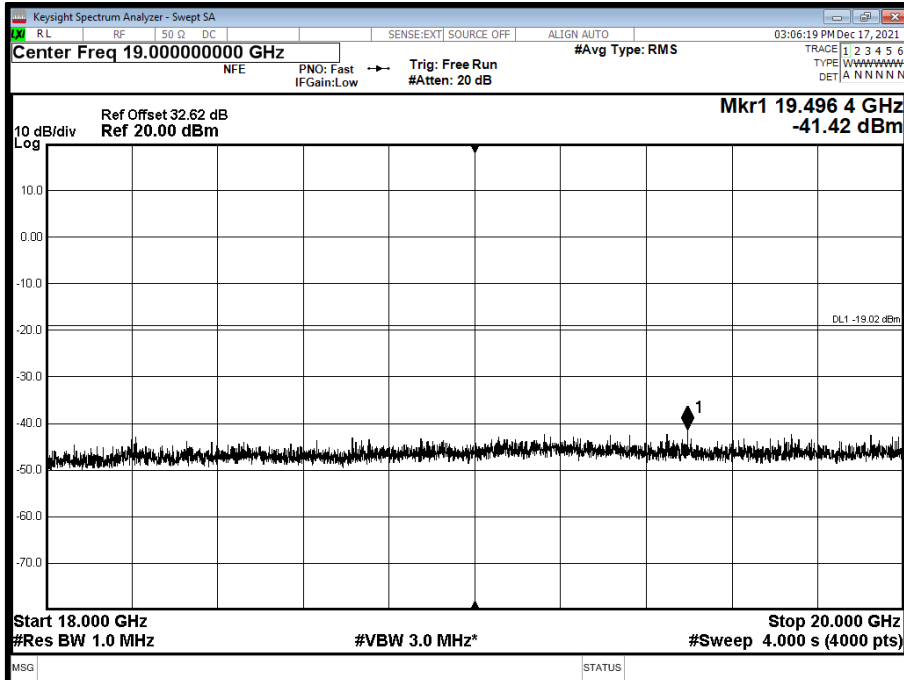

Limit	-19dBm
-------	--------



2.5 RADIATED EMISSIONS

2.5.1 Specification Reference

ISED RSS-GEN, Clause 6.13
Industry Canada RSS-133, Clause 6.5
FCC CFR 47 Part 2, Clause 2.1053

2.5.2 Date of Test and Modification State

12-January-2022 - Modification State 0

2.5.3 Test Equipment Used

The major items of test equipment used for the above tests are identified in Section 3.1.

2.5.4 Environmental Conditions

Ambient Temperature	21.6°C
Relative Humidity	42.6%

2.5.5 Test Method

The test was performed in accordance with ANSI C63.26 Clause 5. The EUT was configured as defined in ANSI C63.26, clause 5.5.2.3.2.

As a result of the conducted measurements that were performed on the EUT, it was established that 10 MHz was the bandwidth configuration which gave the highest output power and therefore deemed to be worst case operating modes. Testing was performed on the Top, Middle and Bottom channels for single carrier.

The EUT was set up on a support replicating typical installation conditions at a height of 0.8 m above the reference ground plane for measurements below 1GHz, (see setup photos) within a semi-anechoic chamber on a remotely controlled turntable. Above 1 GHz, the height was increased to 1.5 m above the reference ground plane.

2.5.6 Test Results

Configuration 1

Maximum Output Power 46.00 dBm



Frequency (MHz)	Level (dBm)	Limit (dBm)	Margin (dB)	Detector	Angle (°)	Height (cm)	Polarisation
*							

Bot - NR&NB-IoT - B2, 1935MHz, 30 MHz to 22 GHz

*No emissions found within 6 dB of the limit.

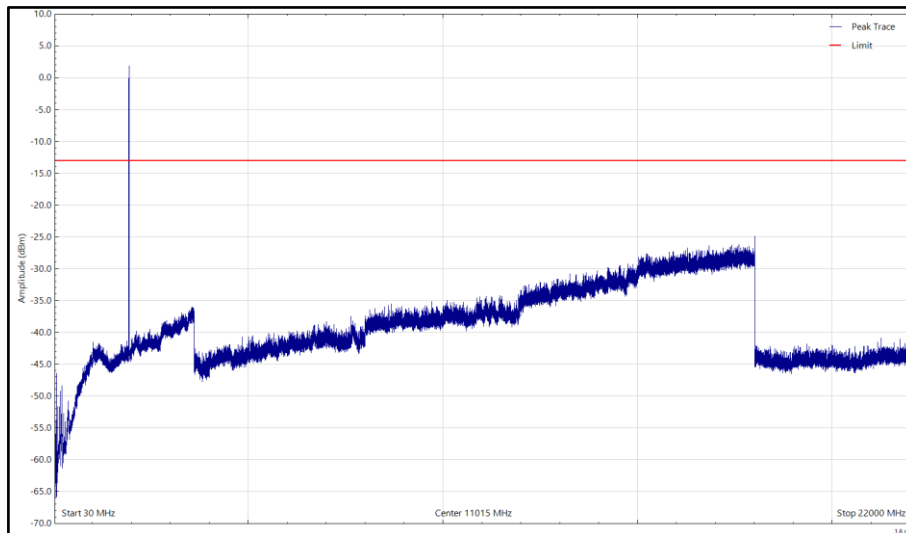

Bot - NR&NB-IoT - B2, 1935MHz, 30 MHz to 22 GHz, Horizontal (Peak)

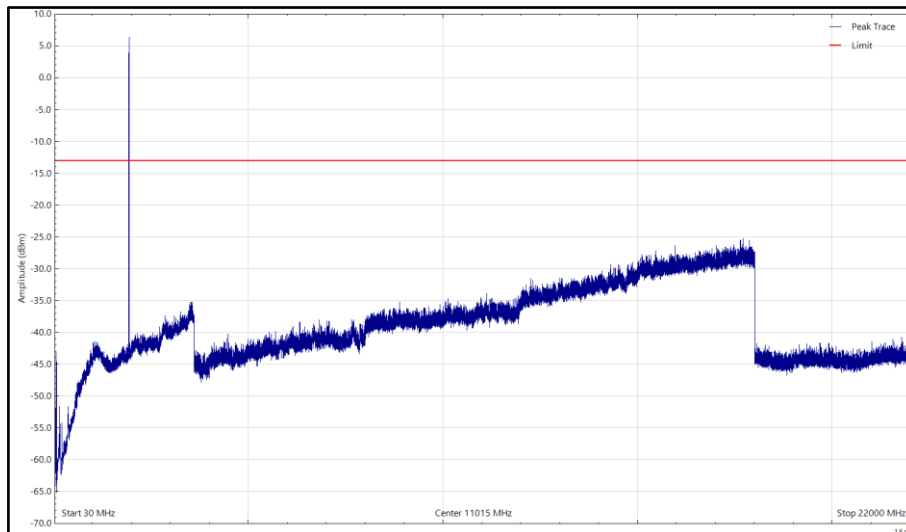

Bot - NR&NB-IoT - B2, 1935MHz, 30 MHz to 22 GHz, Vertical (Peak)



Frequency (MHz)	Level (dBm)	Limit (dBm)	Margin (dB)	Detector	Angle (°)	Height (cm)	Polarisation
*							

Mid - NR&NB-IoT - B2, 1960MHz, 30 MHz to 22 GHz

*No emissions found within 6 dB of the limit.

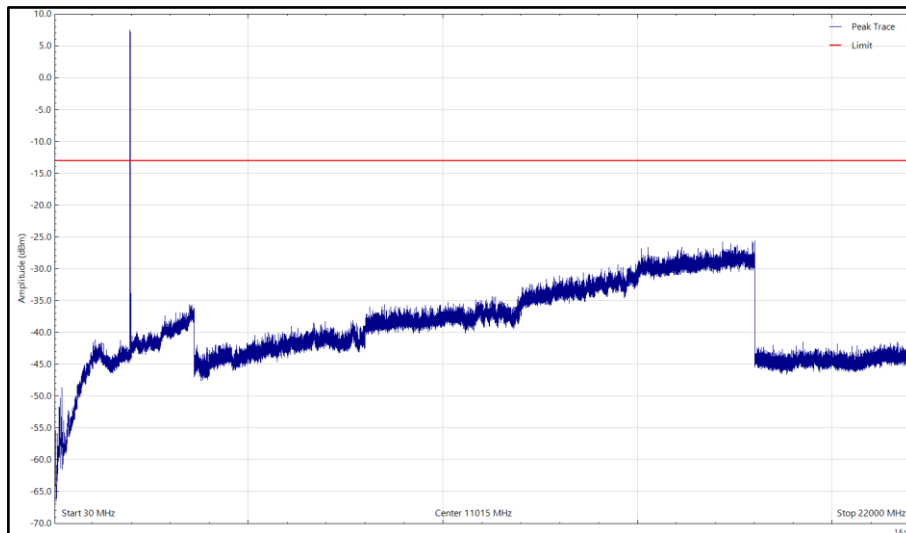

Mid - NR&NB-IoT - B2, 1960MHz, 30 MHz to 22 GHz, Horizontal (Peak)

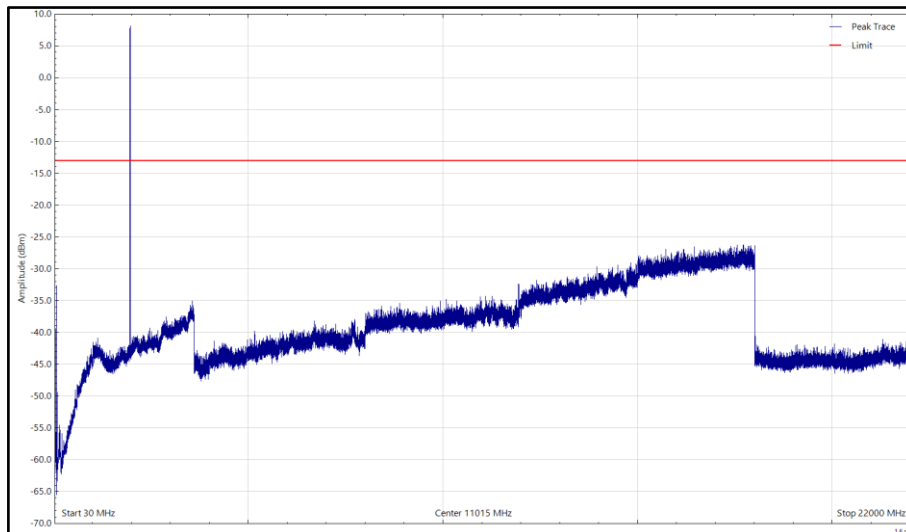

Mid - NR&NB-IoT - B2, 1960MHz, 30 MHz to 22 GHz, Vertical (Peak)



Frequency (MHz)	Level (dBm)	Limit (dBm)	Margin (dB)	Detector	Angle (°)	Height (cm)	Polarisation
*							

Top - NR&NB-IoT - B2, 1985MHz, 30 MHz to 22 GHz

*No emissions found within 6 dB of the limit.

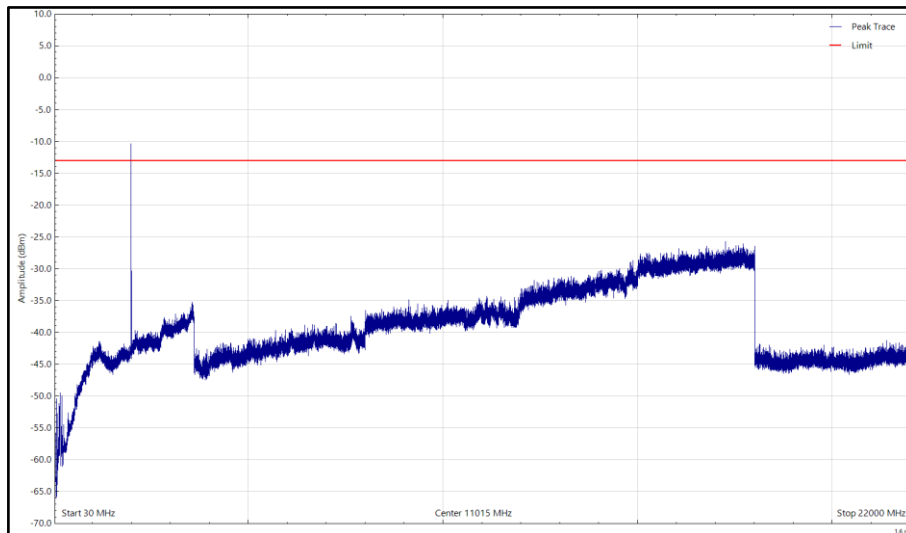

Top - NR&NB-IoT - B2, 1985MHz, 30 MHz to 22 GHz, Horizontal (Peak)

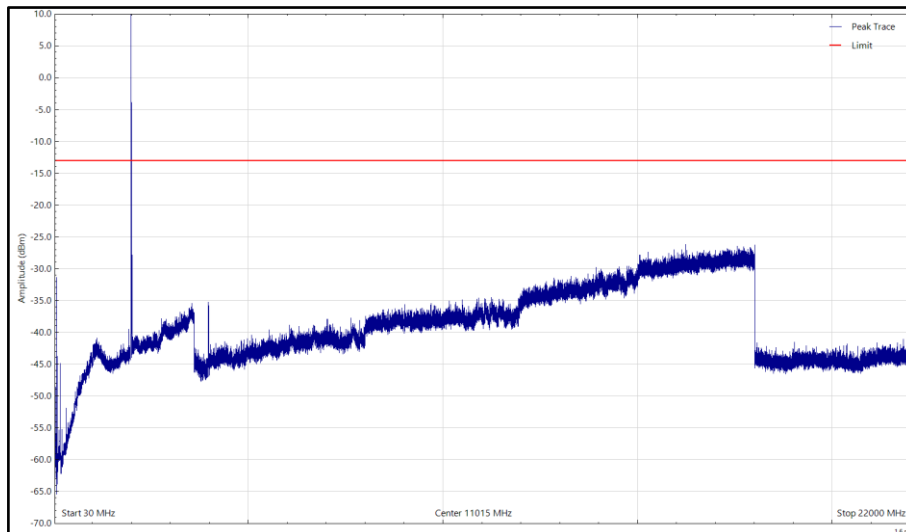

Top - NR&NB-IoT - B2, 1985MHz, 30 MHz to 22 GHz, Vertical (Peak)

Limit

The power of any emission outside of the authorized operating frequency ranges must be attenuated below the transmitting power (P) by a factor of at least $43 + 10 \log(P)$ db.	$46 - (43 + 10 \log 46)$ $= -13.6 \text{ dBm}$
--	---



SECTION 3

TEST EQUIPMENT USED



3.1 TEST EQUIPMENT USED

List of absolute measuring and other principal items of test equipment.

Instrument	Manufacturer	Type No.	TE No.	Calibration Period (months)	Calibration Due
Maximum Peak Output Power and Peak to Average Ratio - Conducted					
Hygrometer	PCE Instruments	PCE-THB-40	5475	12	06-Apr-2022
Frequency Standard	Spectracom	SecureSync 1200-0408-0601	4393	6	03-Jan-2022
Analyser	Keysight	N9030A	4654	12	24-Nov-2022
Power Supply	Farnell	H60-25	1092	-	OP-MON
Multimeter	Fluke	79 Series II	3057	12	23-Aug-2022
Attenuator	Weinschel	48-40-43-LIM	5134	12	03-Jan-2022
Attenuator	Aeroflex / Weinschel	47-10-34	3166	12	13-Sep-2022
Network Analyser	Rohde & Schwarz	ZVA 40	3548	12	29-Jan-2022
Calibration Unit	Rohde & Schwarz	ZV-Z54	4368	12	30-Dec-2021
Occupied Bandwidth					
Hygrometer	PCE Instruments	PCE-THB-40	5475	12	06-Apr-2022
Frequency Standard	Spectracom	SecureSync 1200-0408-0601	4393	6	03-Jan-2022
Analyser	Keysight	N9030A	4654	12	24-Nov-2022
Power Supply	Farnell	H60-25	1092	-	OP-MON
Multimeter	Fluke	79 Series II	3057	12	23-Aug-2022
Attenuator	Weinschel	48-40-43-LIM	5134	12	03-Jan-2022
Attenuator	Aeroflex / Weinschel	47-10-34	3166	12	13-Sep-2022
Network Analyser	Rohde & Schwarz	ZVA 40	3548	12	29-Jan-2022
Calibration Unit	Rohde & Schwarz	ZV-Z54	4368	12	30-Dec-2021
Band Edge					
Hygrometer	PCE Instruments	PCE-THB-40	5475	12	06-Apr-2022
Frequency Standard	Spectracom	SecureSync 1200-0408-0601	4393	6	03-Jan-2022
Analyser	Keysight	N9030A	4654	12	24-Nov-2022
Power Supply	Farnell	H60-25	1092	-	OP-MON
Multimeter	Fluke	79 Series II	3057	12	23-Aug-2022
Attenuator	Weinschel	48-40-43-LIM	5134	12	03-Jan-2022
Attenuator	Aeroflex / Weinschel	47-10-34	3166	12	13-Sep-2022
Network Analyser	Rohde & Schwarz	ZVA 40	3548	12	29-Jan-2022
Calibration Unit	Rohde & Schwarz	ZV-Z54	4368	12	30-Dec-2021
Transmitter Spurious Emissions					
Hygrometer	PCE Instruments	PCE-THB-40	5475	12	06-Apr-2022
Frequency Standard	Spectracom	SecureSync 1200-0408-0601	4393	6	03-Jan-2022
Analyser	Keysight	N9030A	4654	12	24-Nov-2022



Instrument	Manufacturer	Type No.	TE No.	Calibration Period (months)	Calibration Due
Power Supply	Farnell	H60-25	1092	-	OP-MON
Multimeter	Fluke	79 Series II	3057	12	23-Aug-2022
Attenuator	Weinschel	48-40-43-LIM	5134	12	03-Jan-2022
Attenuator	Aeroflex / Weinschel	47-10-34	3166	12	13-Sep-2022
Network Analyser	Rohde & Schwarz	ZVA 40	3548	12	29-Jan-2022
Calibration Unit	Rohde & Schwarz	ZV-Z54	4368	12	30-Dec-2021
HPF	Advance Power Components	11SH10-3000/X18000-O/O	4411	12	02-Jul-2022
Cable	Junkosha	MWX241-01000KMS	5414	12	23-Jun-2022
Cable	Rosenberger	LU1-001-2000	5020	12	07-Jan-2022
Waveguide filter	Quasar	QWS20SB-UBR-UBR-50	5789	12	04/05/2022
WG20 Coaxial Adapter	Quasar	QWC20SB-UBR-K-F	5785	-	OP-MON
WG20 Coaxial Adapter	Quasar	QWC20SB-UBR-K-F	5786	-	OP-MON
Cable attenuator	Aralab	CSF6767C-C2S6500	5175	-	OP-MON
Radiated Emissions					
Antenna (DRG, 18 GHz to 40 GHz)	Link Microtek Ltd	AM180HA-K-TU2	230	24	27-Jul-2022
Antenna with attenuator (Bilog, 30 MHz to 3 GHz)	Schaffner	CBL6143	287	24	14-Oct-2022
Pre-Amplifier (8 GHz to 18 GHz)	Phase One	PS04-0086	1533	12	05-Feb-2022
Pre-Amplifier (18 GHz to 40 GHz)	Phase One	PSO4-0087	1534	12	02-Aug-2022
Comb Generator	Schaffner	RSG1000	3034	-	TU
Multimeter	Fluke	79 Series II	3057	12	23-Aug-2022
Test Receiver	Rohde & Schwarz	ESU40	3506	12	18-Mar-2022
Cable 1503 2M 2.92(P)m 2.92(P)m	Rhophase	KPS-1503A-2000-KPS	4293	12	18-Nov-2022
Cable (K-Type to K-Type, 2 m)	Scott Cables	KPS-1501-2000-KPS	4526	6	06-Mar-2022
Cable (N-Type to N-Type, 1 m)	Rosenberger	LU7-036-1000	5031	12	23-Jul-2022
Emissions Software	TUV SUD	EmX V2.1.11 V.2.1.11	5125	-	Software
DRG Horn Antenna (7.5-18GHz)	Schwarzbeck	HWRD750	5216	12	01-Apr-2022
Digital Multimeter	Keysight Technologies	U1282A	5320	12	25-Aug-2022
Cable (sma-sma, 2 m)	Junkosha	MWX221-02000DMS	5428	12	20-Oct-2022
Cable (N-Type to N-Type, 8 m)	Teledyne	PR90-088-8MTR	5450	6	08-Mar-2022
Thermo-Hygro-Barometer	PCE Instruments	PCE-THB-40	5481	12	31-Mar-2022
Cable (K-Type to K-Type, 1 m)	Junkosha	MWX241-01000KMSKMS/A	5511	12	09-Apr-2022
1m K-Type Cable	Junkosha	MWX241-01000KMSKMS/A	5512	12	09-Apr-2022
2m K Type Cable	Junkosha	MWX241-02000KMSKMS/A	5524	12	24-Mar-2022
Antenna (DRG, 7.5 GHz to 18 GHz)	Schwarzbeck	HWRD750	5610	12	15-Oct-2022
Antenna (DRG, 1 GHz to 10 GHz)	Schwarzbeck	BBHA 9120 B	5611	12	15-Oct-2022
Turntable & Mast Controller	Maturo Gmbh	NCD/498/2799.01	5612	-	TU
Tilt Antenna Mast	Maturo Gmbh	TAM 4.0-P	5613	-	TU
Turntable	Maturo Gmbh	Turntable 1.5 SI-2t	5614	-	TU
Antenna (Bi-Log, 30 MHz to 1 GHz)	Teseq	CBL6111D	5615	24	16-Oct-2022
Screened Room (12)	MVG	EMC-3	5621	36	11-Aug-2023

N/A – Not Applicable

O/P Mon – Output Monitored with Calibrated Equipment



3.2 MEASUREMENT UNCERTAINTY

For a 95% confidence level, the measurement uncertainties for defined systems are:-

Test Discipline	Frequency / Parameter	MU
Conducted Maximum Peak Output Power	9 kHz to 40 GHz Amplitude	± 1.0 dB
Conducted Emissions	9 kHz to 40 GHz Amplitude	± 3.5 dB
Occupied Bandwidth	10 MHz Bandwidth	± 16.7 kHz
	15 MHz Bandwidth	
	20 MHz Bandwidth	
Band Edge	< 3.6 GHz Amplitude	± 0.6 dB
Radiated Spurious Emissions	30 MHz to 1 GHz	± 5.2 dB
	1 GHz to 40 GHz	± 6.3 dB

Measurement Uncertainty Decision Rule

Determination of conformity with the specification limits is based on the decision rule according to IEC Guide 115:2007, Clause 4.4.3 and 4.5.1. (Procedure 2). The measurement results are directly compared with the test limit to determine conformance with the requirements of the standard.

Risk: The uncertainty of measurement about the measured result is negligible with regard to the final pass/fail decision. The measurement result can be directly compared with the test limit to determine conformance with the requirement (compare IEC Guide 115). The level of risk to falsely accept and falsely reject items is further described in ILAC-G8



3.3 MEASUREMENT SOFTWARE USED

List of measurement software versions used for testing.

Instrument	Manufacturer	Type No.	TE No.	Software Version
PXA Signal Analyser	Keysight	N9030B	4654	A22.08
HP-VEE Software	TUV SUD	HP_VEE	N/A	V3.28



SECTION 4

ACCREDITATION, DISCLAIMERS AND COPYRIGHT



4.1 ACCREDITATION, DISCLAIMERS AND COPYRIGHT

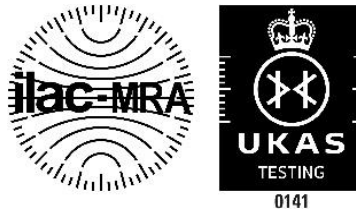

This report relates only to the actual item/items tested.

Our UKAS Accreditation does not cover opinions and interpretations and any expressed are outside the scope of our UKAS Accreditation.

Results of tests not covered by our UKAS Accreditation Schedule are marked NUA (Not UKAS Accredited).

© 2022 TÜV SÜD
TÜV SÜD

Postal Address :Octagon House, Concorde Way, Fareham, Hampshire, UK, PO15 5RL



ANNEX A

MODULE LIST



Configuration 1			
Product	Product No	R-State	Serial No
RRUS 32 B2	KRC 161 414/1	R1D	CF84764285
Software Version:	CXP9013268/12	Revision:	R84BD