



REPORT

issued by an FCC listed Laboratory Reg. no. 93866.
The test site complies with RSS-Gen, IC file no: 3482A-1

Contact person
Martin Theorin
Electronics
+46 10 516 58 85
Martin.Theorin@sp.se

Date
2013-07-01

Reference
3P01987-03-F27

Page
1 (2)



Ericsson AB
Klaes Holm
PDU HW
164 80 Stockholm

Radio measurements on mRRUS 12 B4 1700/2100 MHz radio equipment with FCC ID: TA8AKRC161326 and IC: 287AB-AS161326

(5 appendices)

Test object

Product name: mRRUS 12 B4
Product number: KRC 161 326/X, see appendix 1 for details.

Summary

Standard	Compliant	Appendix
FCC CFR 47 / IC RSS-139 ISSUE 2		
2.1046 / RSS-139 6.4 RF power output	Yes	2
2.1051 / RSS-139 6.5 Spurious emission at antenna terminals	Yes	3
2.1053 / RSS-139 6.5 Field strength of spurious radiation	Yes	4

Note: Above RSS-139 items are given as cross-reference only. Measurements were performed according to ANSI procedures referenced by FCC and covered by SP's accreditation.

SP Technical Research Institute of Sweden Electronics - EMC

Performed by

Martin Theorin

Examined by

Christer Karlsson

SP Technical Research Institute of Sweden

Postal address

SP
Box 857
SE-501 15 BORÅS
Sweden

Office location

Västeråsen
Brinellgatan 4
SE-504 62 BORÅS

Phone / Fax / E-mail

+46 10 516 50 00
+46 33 13 55 02
info@sp.se

Laboratories are accredited by the Swedish Board for Accreditation and Conformity Assessment (SWEDAC) under the terms of Swedish legislation. This report may not be reproduced other than in full, except with the prior written approval of the issuing laboratory.

Table of contents

Description of the test object	Appendix 1
Operation mode during measurements	Appendix 1
Test setups	Appendix 1
Purpose of test	Appendix 1
RF power output	Appendix 2
Spurious emission at antenna terminals	Appendix 3
Field strength of spurious radiation	Appendix 4
External photos	Appendix 5

Appendix 1

Description of the test object

Equipment:	Product name: mRRUS 12 B4, supporting mixed mode WCDMA+LTE Product number: KRC 161 326/1, 110-240VAC internal antenna Product number: KRC 161 326/2, -48VDC internal antenna Product number: KRC 161 326/3, 110-240VAC no internal antenna Product number: KRC 161 326/4, -48VDC no internal antenna FCC ID TA8AKRC161326 IC 287AB-AS161326 IC model numbers: IC MODEL NO: AS1613261 IC MODEL NO: AS1613262 IC MODEL NO: AS1613263 IC MODEL NO: AS1613264
Antenna ports:	2 TX/RX ports
RF configurations:	Single carrier, multi carrier, TX diversity and MIMO 2x2 (TX diversity only LTE)
Frequency bands:	TX: 2110 – 2155 MHz RX: 1710 – 1755 MHz
Nominal output power per antenna port:	1-2 LTE + 1-3 WCDMA (Total power 37dBm, 5W) Total number of carriers 4
LTE Modulations:	QPSK, 16QAM and 64QAM
Channel bandwidth:	1.4 MHz, 3 MHz, 5 MHz and 10 MHz
WCDMA Modulations:	QPSK, 16QAM and 64QAM
Channel bandwidth:	4.2 to 5 MHz (configurable in steps of 100/200 kHz)
Channel spacing:	4.4 to 5 MHz (configurable in steps of 100/200 kHz)
Nominal power voltage:	-48 VDC 110-240 VAC

Appendix 1

Operation mode during measurements

MSR, WCDMA + LTE

WCDMA measurements were performed with the test object transmitting test models as defined in 3GPP TS 25.141. Test model 1 (TM1) was used to represent QPSK. Test model 5 (TM5) to represent 16QAM modulation and Test model 6 (TM6) to represent 64QAM modulation.

LTE measurements were performed with the test object transmitting test models as defined in 3GPP TS 36.141. Test model E-TM1.1 was used to represent QPSK, test model E-TM3.2 to represent 16QAM and test model E-TM3.1 to represent 64QAM modulation.

The settings below were deemed representative for all traffic scenarios when settings with different modulations, channel bandwidths, number of carriers and RF configurations has been tested to find the worst case setting. The settings below were used for all measurements if not otherwise noted.

WCDMA MIMO mode

TM5:8 HS-PDSCH at 240ksps + 30 DPCH:s at 30 ksps (SF=128)

Channel bandwidth 5 MHz

LTE MIMO mode

E-TM1.1

Channel bandwidth 1.4MHz.

Measurements were performed with the test object configured for the maximum transmit power applicable for the tested configuration.

Conducted measurements

The test object was supplied with -48 VDC by an external power supply. Additional connections are documented in the set-up drawings below.

All measurements were made on RF A and additional measurements on RF B to verify that the ports were electrical identical, as declared by the client.

Radiated measurements

The test object was powered with -48 VDC. All measurements were performed with the test object configured for maximum transmit power

Appendix 1

Purpose of test

The purpose of the tests is to verify compliance to the performance characteristics specified in applicable items of FCC CFR 47 and Industry Canada RSS-139 and RSS-Gen.

References

Measurements were done according to relevant parts of the following standards:

- ANSI 63.4-2009
- ANSI/TIA/EIA-603-C-2004
- CFR 47 part 2, October 1st, 2012
- CFR 47 part 27, October 1st, 2012
- 3GPP TS 25.141, version 11.4.0
- 3GPP TS 36.141, version 11.4.0
- 3GPP TS 37.141, version 11.3.0
- RSS-Gen Issue 3
- RSS-139 Issue 2

Measurement equipment

	Calibration Due	SP number
Test site Tesla	2014-01	503 881
R&S FSIQ 40	2013-07	503 738
R&S FSW 43	2013-10	902 073
R&S FSQ 40	2014-03	504 143
R&S ESI 26	2013-07	503 292
Control computer with R&S software EMC32 version 8.52.0	-	503 479
High pass filter	2013-07	901 501
High pass filter	2013-07	901 502
High pass filter	2013-07	504 199
High pass filter	2013-08	901 373
High pass filter	2014-08	503 739
High pass filter	2013-07	503 740
RF attenuator	2013-07	504 159
RF attenuator	2013-08	900 691
RF attenuator	2013-12	901 508
Chase Bilog Antenna CBL 6111A	2014-10	503 182
EMCO Horn Antenna 3115	2014-01	502 175
Std.gain horn FLANN model 20240-20	2014-03	503 674
Schwarzbeck preamplifier BBV 9742	2014-03	504 085
µComp Nordic, Low Noise Amplifier	2014-04	901 545
MITEQ Low Noise Amplifier	2013-08	503 285
Testo 635 Temperature and humidity meter	2014-06	504 203

Appendix 1

Uncertainties

Measurement and test instrument uncertainties are described in the quality assurance documentation "SP-QD 10885". The uncertainties are calculated with a coverage factor $k=2$ (95% level of confidence).

Compliance evaluation is based on a shared risk principle with respect to the measurement uncertainty.

Reservation

The test results in this report apply only to the particular test object as declared in the report.

Delivery of test object

The test object was delivered 2013-04-22.

Manufacturer's representative

Christer Gustavsson, Ericsson AB.

Test engineers

Andreas Johnson, Tomas Lennhager, Kexin Chen, Tomas Isbring, Jörgen Wassholm and Martin Theorin, SP

Test participant

None

Appendix 1

Test frequencies during measurements

Bim1:

	WCDMA	LTE
	(2W)	(3W)
Downlink	1540 (2113 MHz)	2022 (2117.2 MHz)
Uplink	1315 (1713 MHz)	20022 (1717.2 MHz)
Test model	TM5	E-TM1.1
Bandwidth	5 MHz	1.4 MHz

Bim2:

	WCDMA	LTE
	(2W)	(3W)
Downlink	1600 (2125 MHz)	2262 (2141.2 MHz)
Uplink	1375 (1725 MHz)	20262 (1741.2 MHz)
Test model	TM5	E-TM1.1
Bandwidth	5 MHz	1.4 MHz

Appendix 1

Tim 1:

	WCDMA	LTE
	(2W)	(3W)
Downlink	1714 (2147.8 MHz)	2370 (2152 MHz)
Uplink	1489 (1747.8 MHz)	20370 (1752 MHz)
Test model	TM5	E-TM1.1
Bandwidth	5 MHz	1.4 MHz

Tim 2:

	WCDMA	LTE
	(2W)	(3W)
Downlink	1594 (2123.8 MHz)	2250 (2140 MHz)
Uplink	1369 (1723.8 MHz)	20250 (1740 MHz)
Test model	TM5	E-TM1.1
Bandwidth	5 MHz	1.4 MHz

All RX frequencies were configured 400 MHz below the corresponding TX frequency according the applicable duplex offset for the operating band.

Appendix 1

Test set-up conducted measurements TX, MSR

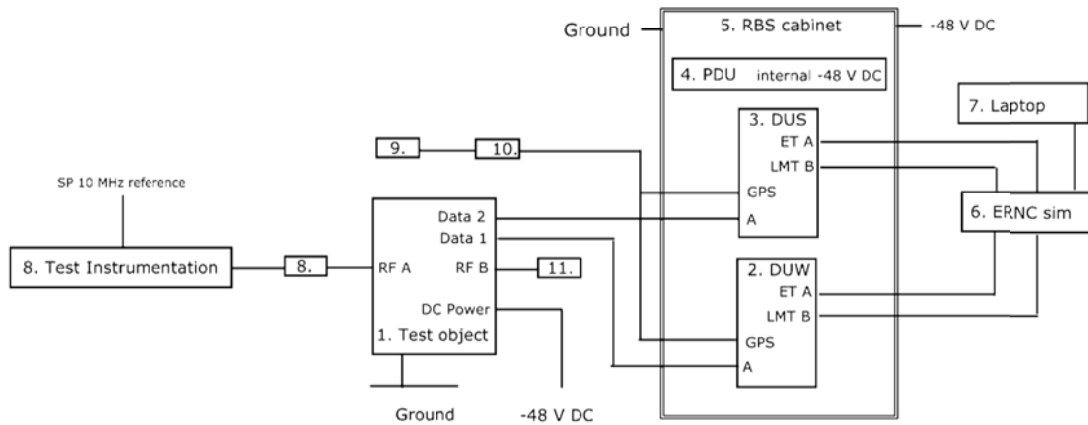

Test object:

1.	mRRUS 12 B4, KRC 161 326/4, revision R1A, S/N: C826922101 working software CXP 901 3268/9, Rev. R51MD06 with FCC ID TA8AKRC161326 and IC 287AB-AS161326
----	---

Functional test equipment

2.	DUW 41 01, KDU 127 174/4, rev:R2C, s/n: A402005488
3.	DUS 40 01, KDU 137 624/1, Rev R5A, S/N: D165724696
4.	PDU 0202, BMG 980 336/5, revision R1E, S/N: C941030896
5.	RBS 6202 cabinet, BAMS 1000961945 PFU 0202, KFE 101 1162/3, revision R1B, S/N: R80954554 SCU 0301, BGM 136 1006/3, revision R1A, S/N: C823563230
6.	ERNC Sim 127, BAMS – 1000660988 Netgear Switch FS726T
7.	Controlling laptop HP Elitebook 8560w, BAMS 1001236854 running software MOSHELL V9.0u
8.	SP Test Instrumentation according to measurement equipment list
9.	GPS Active Antenna, KRE 101 2082/1
10.	GPS 02 01, NCD 901 41/1, rev. R1D, s/n: TU8K474887
11.	Terminator, 50 ohm

Appendix 1

Test set-up radiated measurements

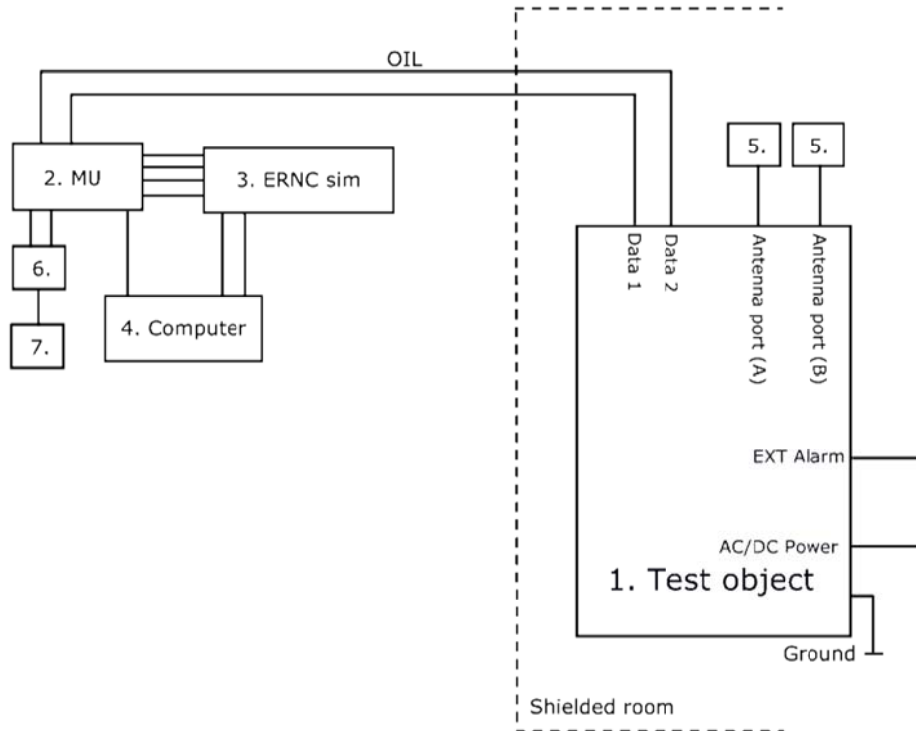

Test object:

1.	mRRUS 12 B4, KRC 161 326/2, rev. R1A, s/n: C826925910 working software CXP 901 3268/9, Rev. R51MD06 with FCC ID TA8AKRC161326 and IC 287AB-AS161326
----	---

Functional test equipment:

2.	DUS 41 01 KDU 137 624/1 R5A, s/n: D165724698, hosted in SUP 6601 1/BFL 901 009/4, rev. R1D, s/n. BR82081105 DUW 41 01 KDU 127 174/4 R2C, s/n: A402007255, hosted in SUP 6601 1/BFL 901 009/4, rev. R1D, s/n. BW98450216
3.	ERNC-SIM 130, BAMS – 1000660991 Netgear Switch FS726T
4.	Computer HP Elitebook 8560w, BAMS – 1001236856
5.	Terminator
6.	GPS 02 01, NCD 901 41/1, rev. R1D, s/n: TU8K356428
7.	GPS Active Antenna, KRE 101 2082/1

Appendix 1

Interface:	Type of port:
Power: -48 VDC	DC Power
Data 1, optical interface	Signal
Data 2, optical interface	Signal
Ext Alarm, unshielded multi wire	Signal
Ground wire	Ground

RBS software:

RAT	Software	Revision
LTE	CXP 102 151/18	R25Y
WCDMA	CXP 902 171/9	R1CA23

Appendix 2

RF power output measurements according to CFR 47 §27.50 / IC RSS-139 6.4

Date	Temperature	Humidity
2013-04-30	23 °C ± 3 °C	25 % ± 5 %

Test set-up and procedure

The test object was connected to a signal analyzer measuring peak and RMS output power in CDF mode. A resolution bandwidth of 50 MHz was used.

Measurement equipment	SP number
R&S FSQ 40	504 143
RF attenuator	901 508
Testo 635, temperature and humidity meter	504 203

Measurement uncertainty: 1.1 dB

Appendix 2

Results

MSR, WCDMA + LTE:

Rated output power level at RF connector 2x34 dBm/ RF port. Total nominal RF power 40dBm.

Test configurations	Transmitter power RMS (dBm)		
	Port RF A	Port RF B	Total power ¹⁾
Bim 1	36.97 (Diagram 1)	36.88 (Diagram 2)	39.94
Bim 2	36.91 Diagram 3)	Not tested ²⁾	39.91
Tim 1	36.95 (Diagram 4)	Not tested ²⁾	39.95
Tim 2	36.93 (Diagram 5)	Not tested ²⁾	39.93

¹⁾: Summed output power according to FCC KDB662911 D01 Multiple transmitter output v02

²⁾: Note: Measurements were limited to port RF A due to the measurement result in WCDMA and LTE single carrier MIMO mode that shows that the ports are electrical identical as declared by the client.

Limits

§27.50: The maximum output power may not exceed 1640 W (EIRP)/ MHz.
The Peak to Average Ratio (PAR) may not exceed 13 dB.

RSS-139 6.4: The average equivalent isotropically radiated power (e.i.r.p.) limits in SRSP-513 apply, resulting in a maximum EIRP of 1640 W/ MHz for the scope of this report. The peak-to-average ratio of the power shall not exceed 13 dB.

Complies?	Yes
-----------	-----

Appendix 2

Diagram 1:

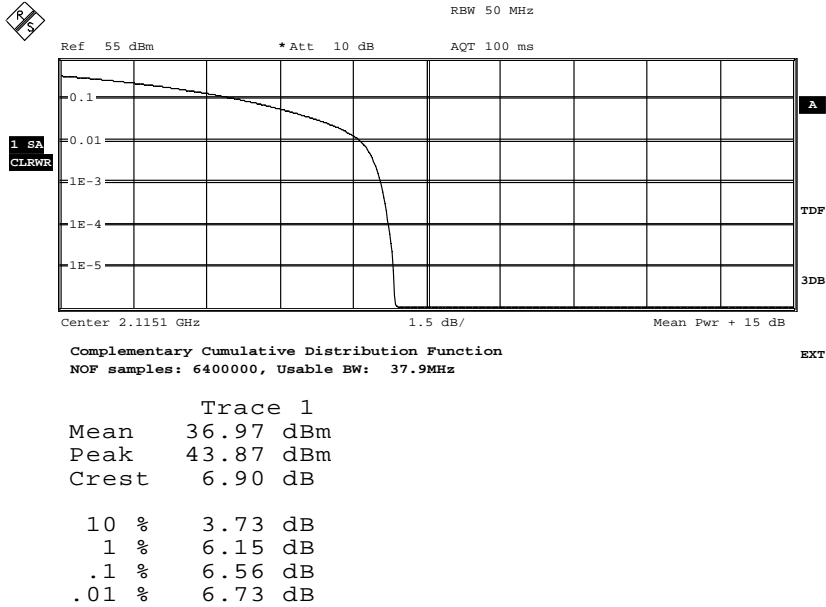

Date: 30.APR.2013 10:22:57

Diagram 2:

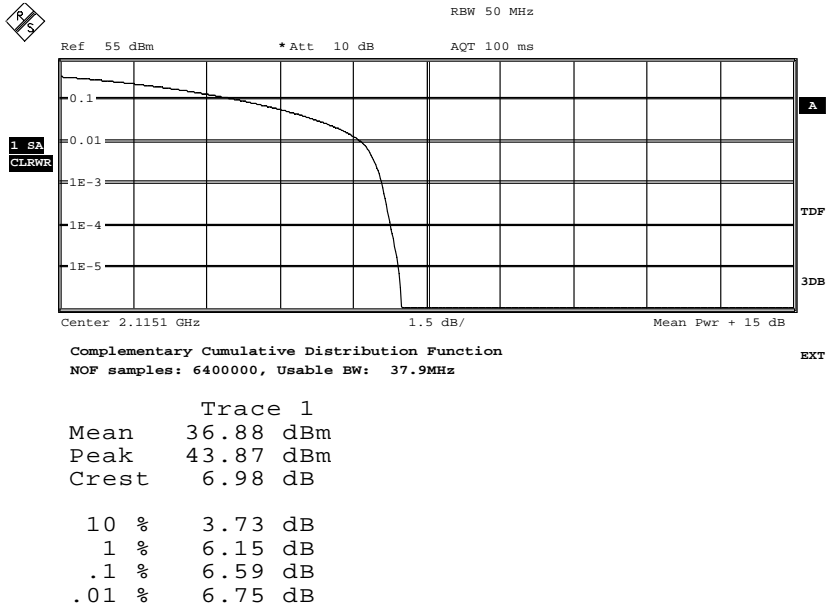

Date: 30.APR.2013 12:11:04

Appendix 2

Diagram 3:

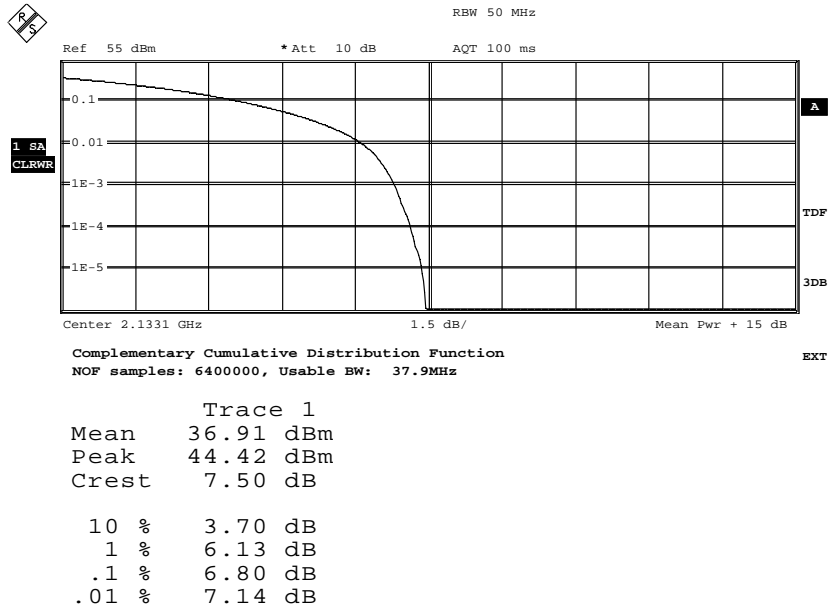

Date: 30.APR.2013 09:56:31

Diagram 4:

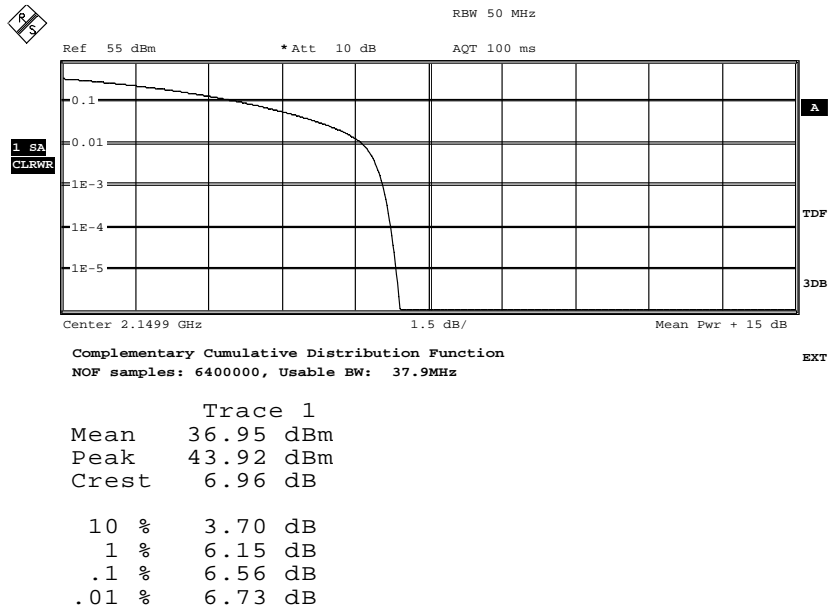

Date: 30.APR.2013 09:44:32

Appendix 2

Diagram 5:

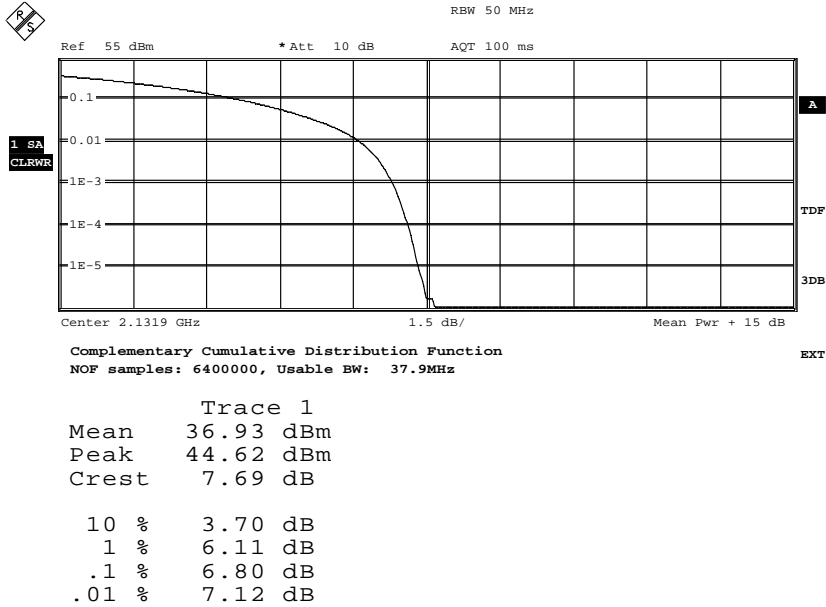

Date: 30.APR.2013 09:34:38

Appendix 3

Conducted spurious emission measurements according to CFR 47 §27.53(h)/ IC RSS-139 6.5

Date	Temperature	Humidity
2013-04-30	23 °C ± 3 °C	25 % ± 5 %

Test set-up and procedure

The measurements were made per definition in §27.53(h). The output was connected to a spectrum analyzer with a RBW setting of 1 MHz and RMS detector activated. The spectrum analyzer was connected to an external 10 MHz reference standard during the measurements.

Before comparing the results to the limit, 3 dB [10 log (2)] should be added according to method E), 3), (iii) “measure and add 10 log(N_{ANT})” of FCC KDB662911 D01 Multiple Transmitter Output v02.

Measurement equipment	SP number
R&S FSW 43	902 073
RF attenuator	901 508
HP filter	901 502
Testo 635, temperature and humidity meter	504 203

Measurement uncertainty: 3.7 dB

Results

MSR, WCDMA + LTE:

Diagram	Tested configuration	Tested Port
1 a+b+c+d+e	Bim 1	RF A
2 a+b+c+d+e	Bim 1	RF B
3 a+b+c+d+e	Bim 2	RF A
4 a+b+c+d+e	Tim 1	RF A
5 a+b+c+d+e	Tim 2	RF A

Appendix 3

Diagram 1a:

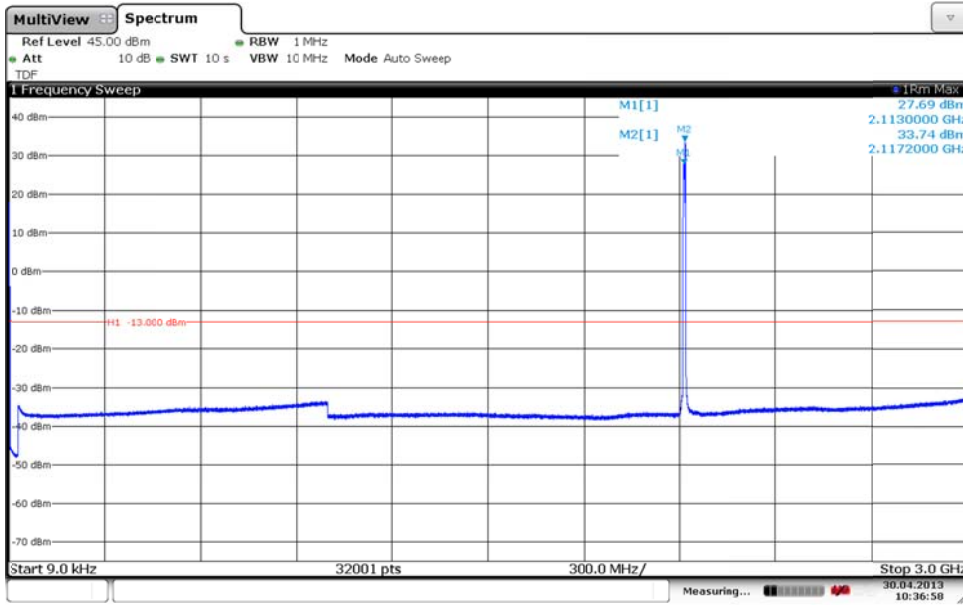

Date: 30.APR.2013 10:36:59

Diagram 1b:

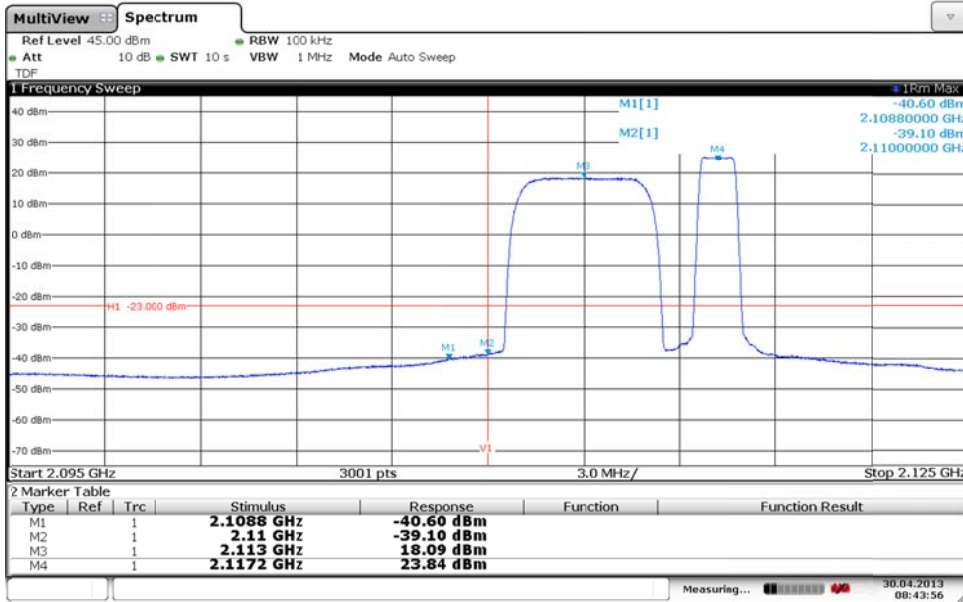

Date: 30.APR.2013 08:43:56

Appendix 3

Diagram 1c:

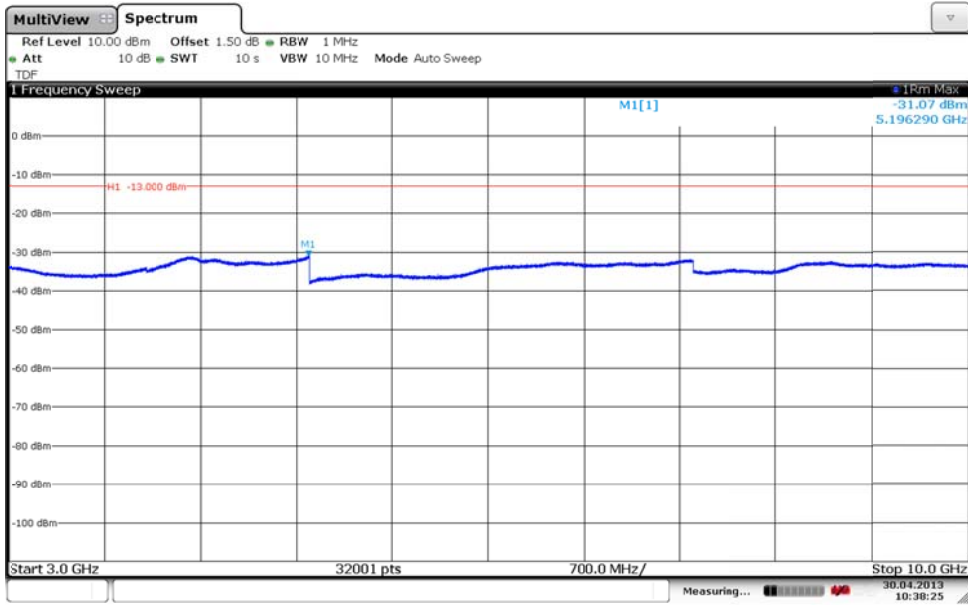
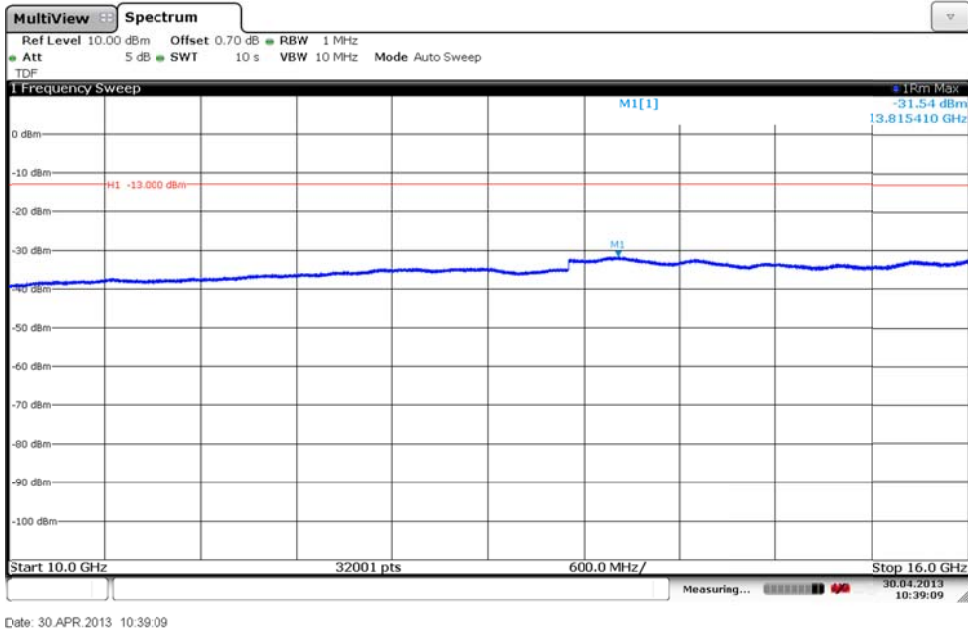
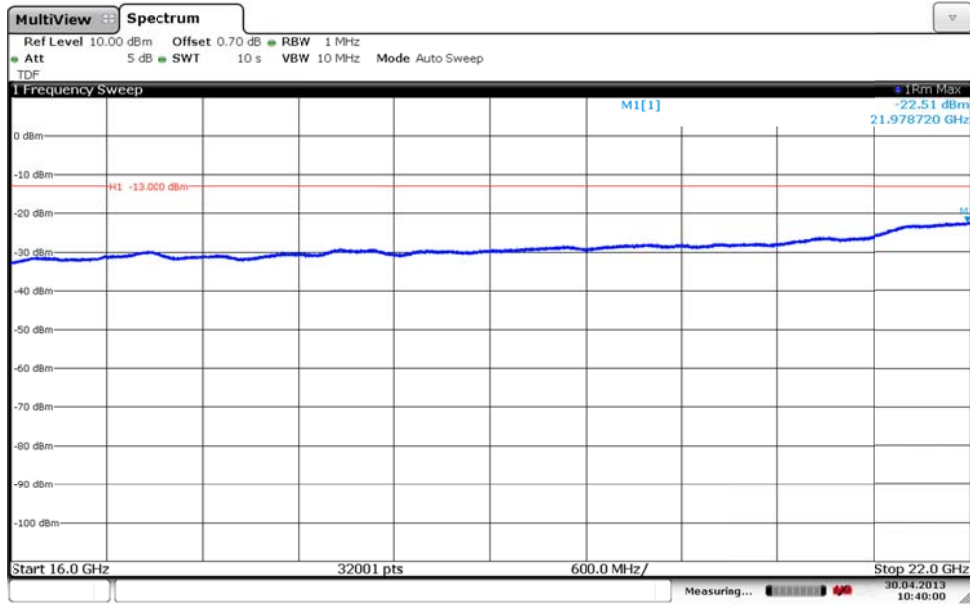

Diagram 1d:



Appendix 3

Diagram 1e:



Appendix 3

Diagram 2a:

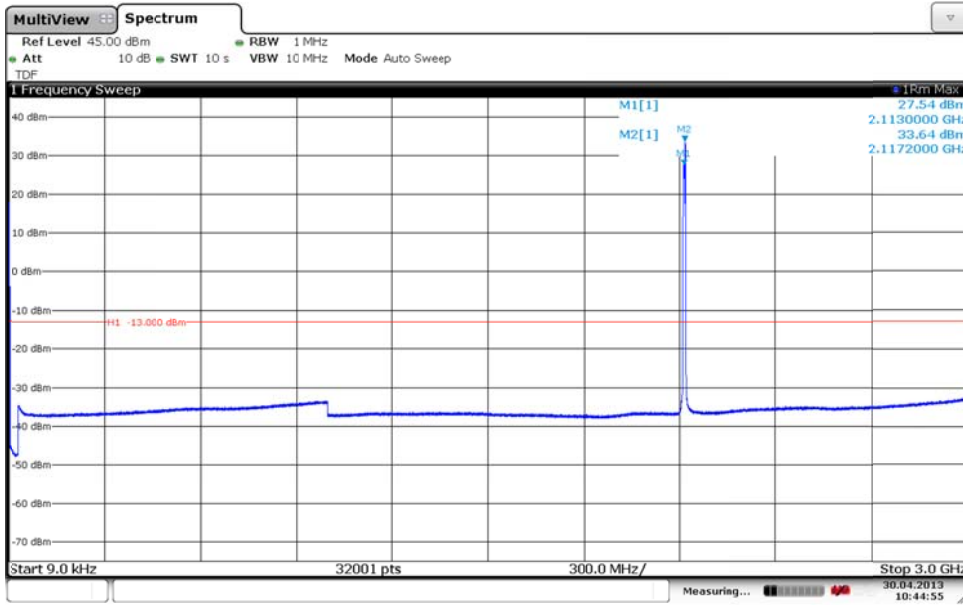
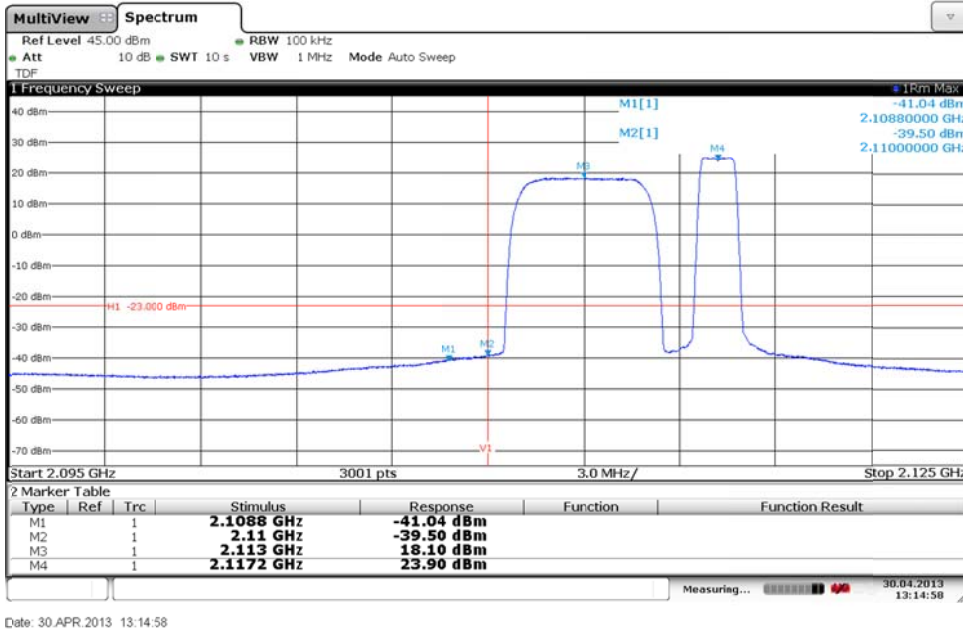
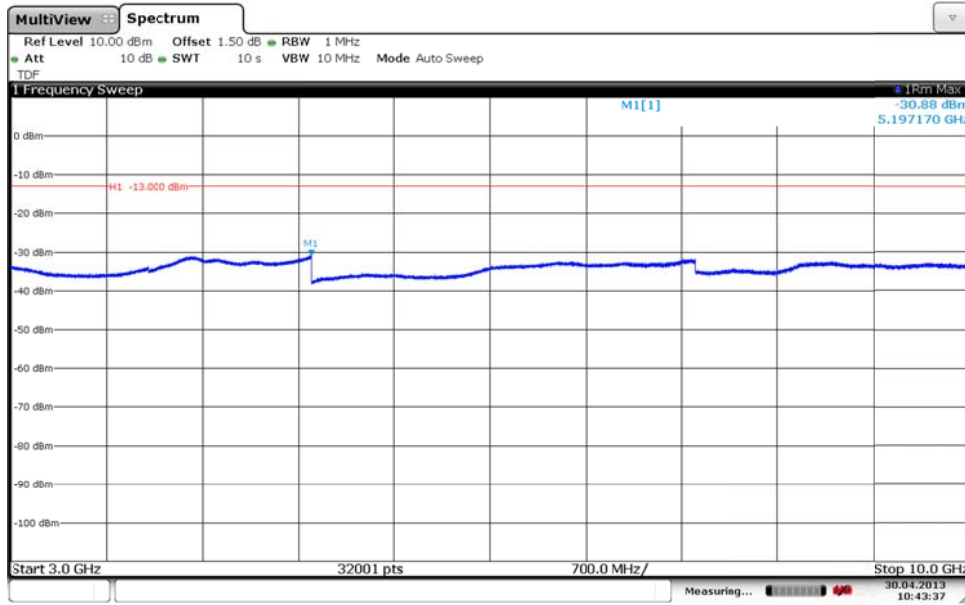

Diagram 2b:



Appendix 3

Diagram 2c:



Date: 30.APR.2013 10:43:37

Diagram 2d:

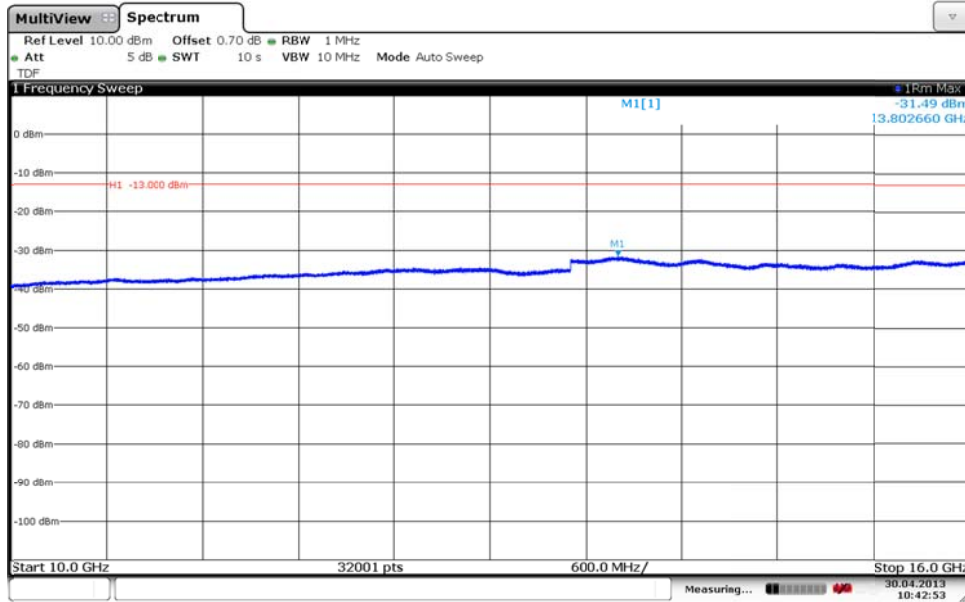

Date: 30.APR.2013 10:42:53

Appendix 3

Diagram 2e:

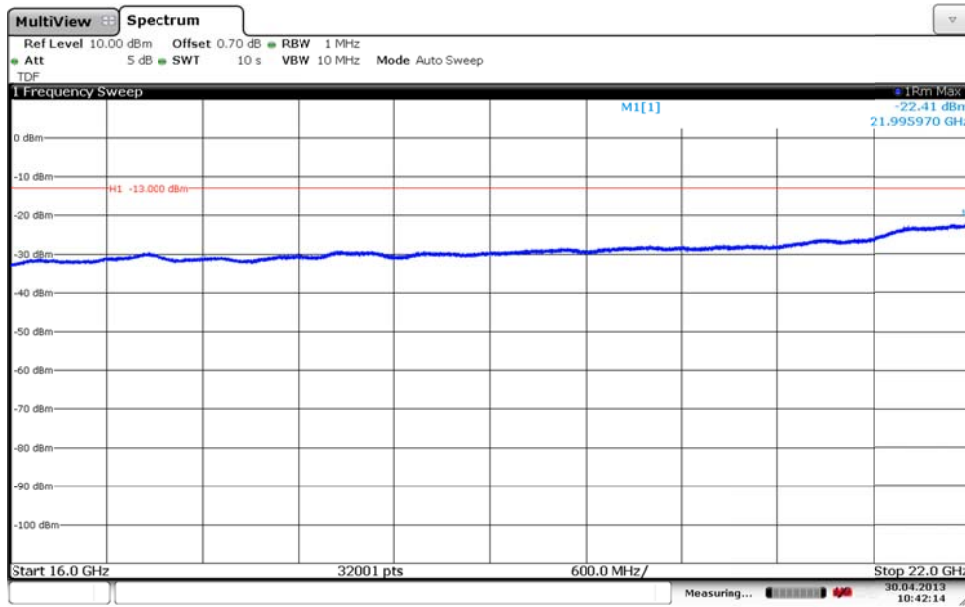

Date: 30.APR.2013 10:42:14

Appendix 3

Diagram 3a:

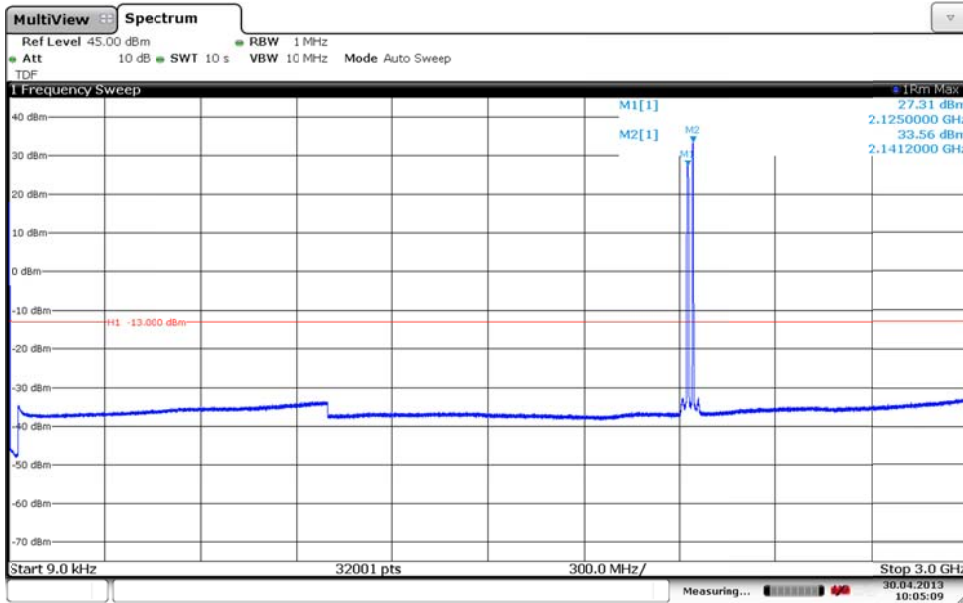

Date: 30.APR.2013 10:05:09

Diagram 3b:

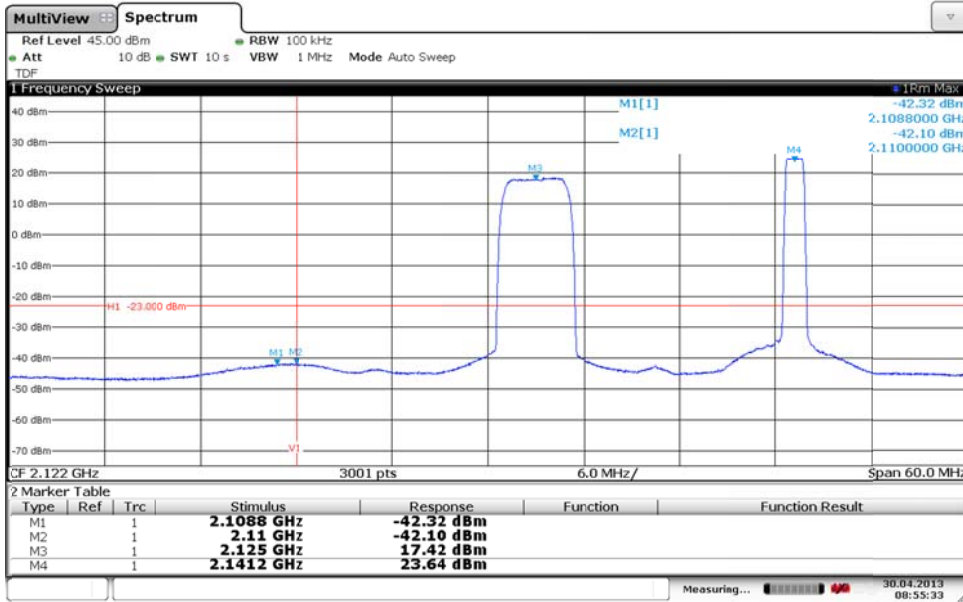

Date: 30.APR.2013 08:55:33

Appendix 3

Diagram 3c:

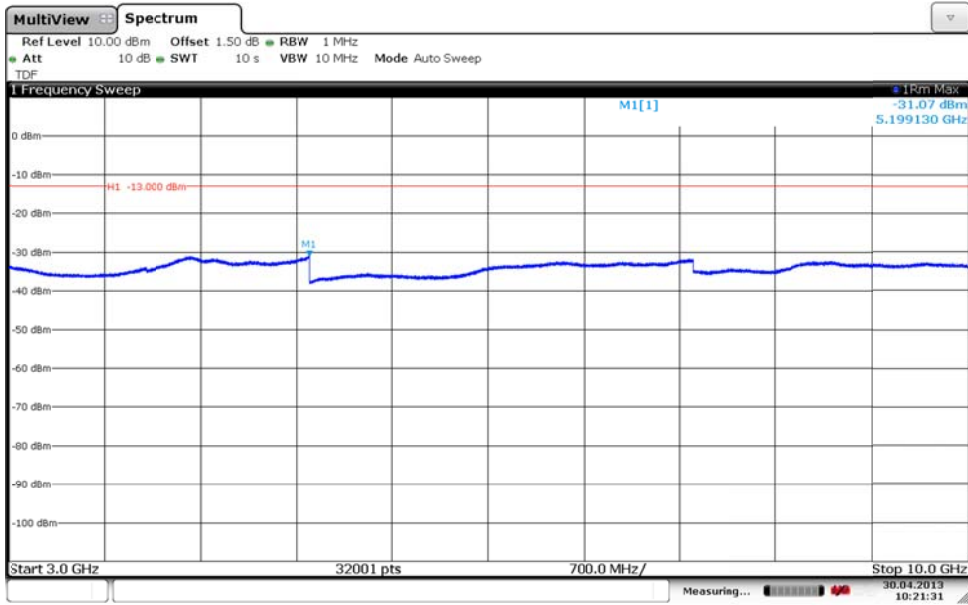
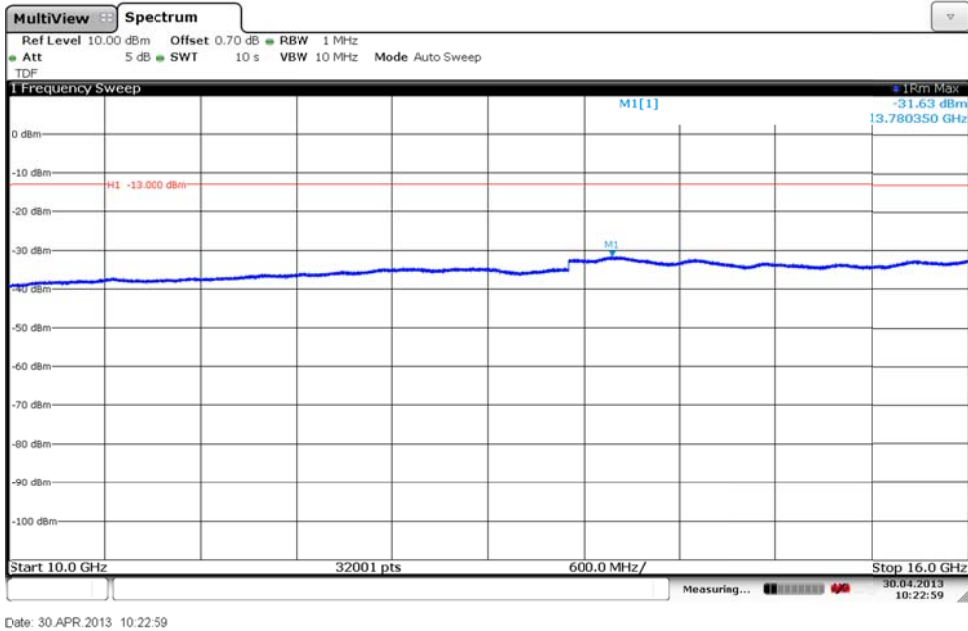
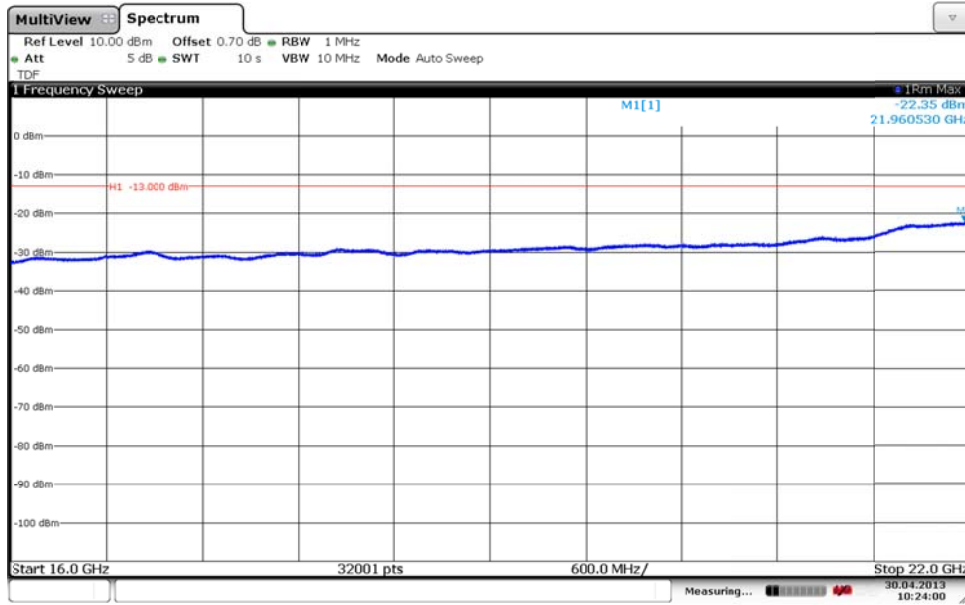

Diagram 3d:



Appendix 3

Diagram 3e:



Date: 30.APR.2013 10:23:59

Appendix 3

Diagram 4a:

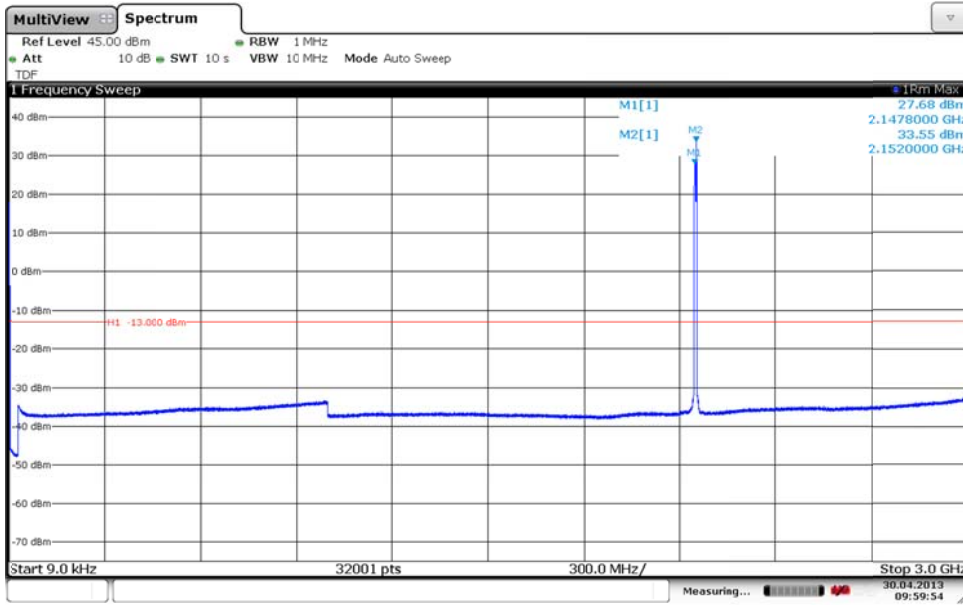

Date: 30.APR.2013 09:59:53

Diagram 4b:

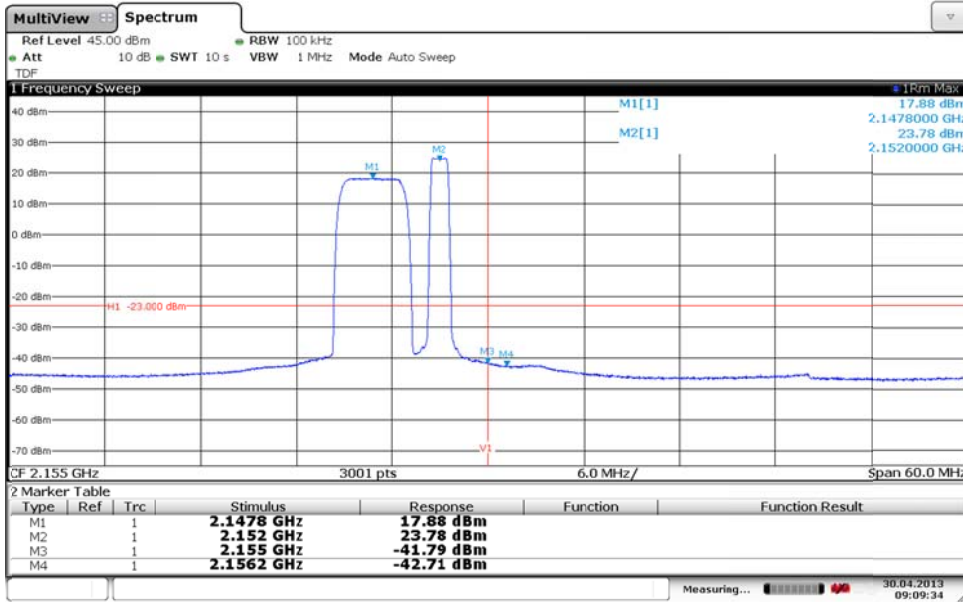

Date: 30.APR.2013 09:09:34

Appendix 3

Diagram 4c:

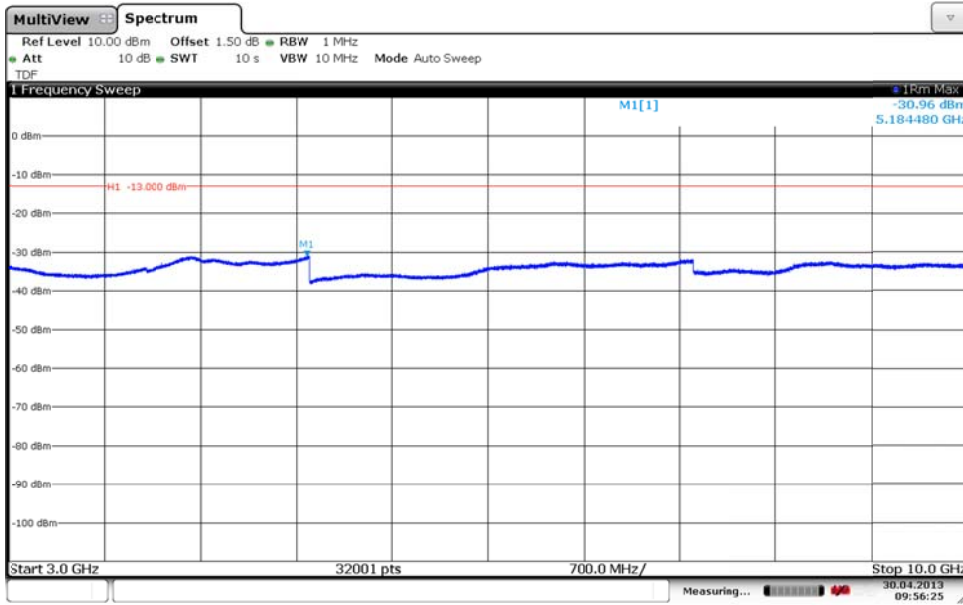

Date: 30.APR.2013 09:56:25

Diagram 4d:

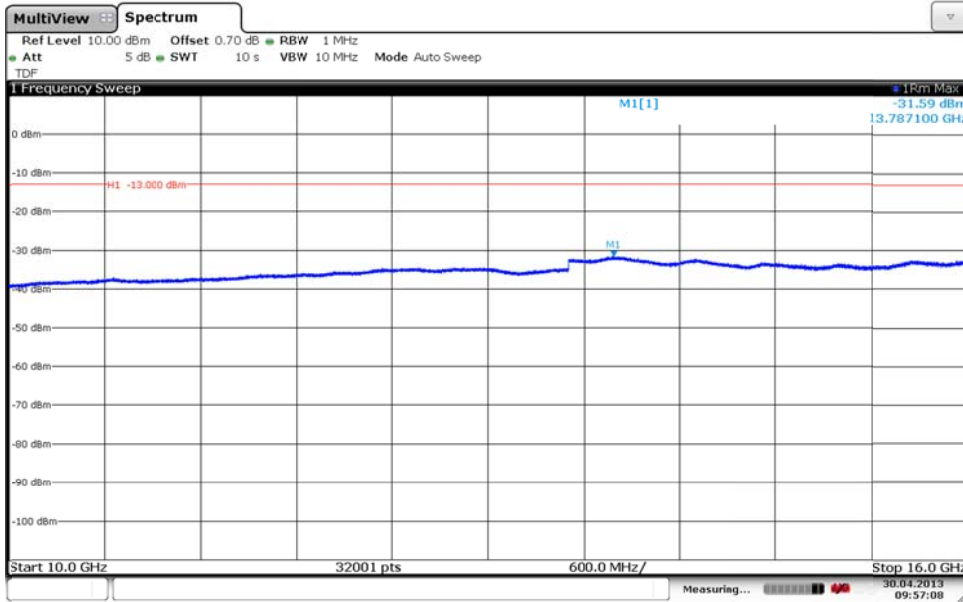

Date: 30.APR.2013 09:57:08

Appendix 3

Diagram 4e:

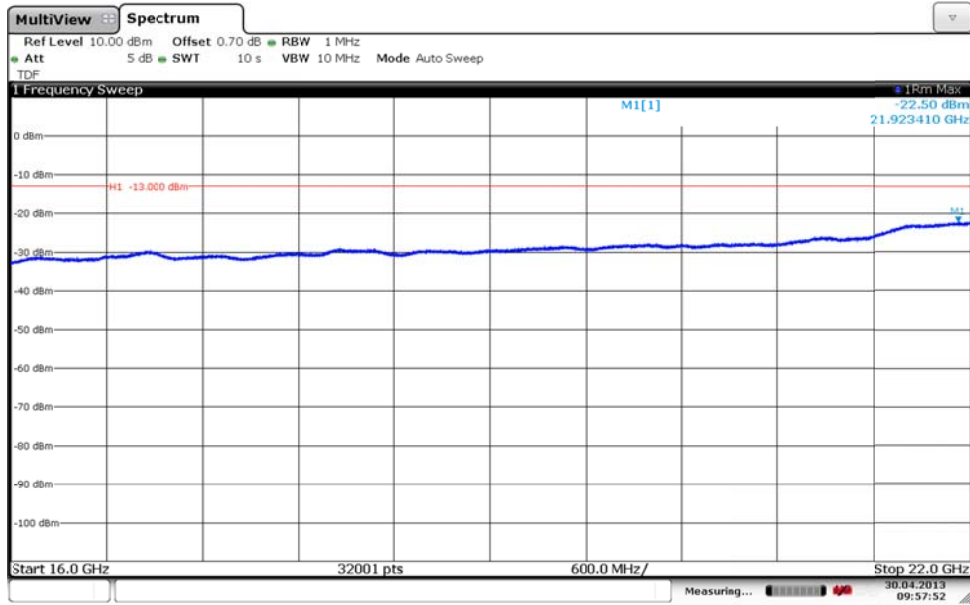

Date: 30.APR.2013 09:57:52

Appendix 3

Diagram 5a:

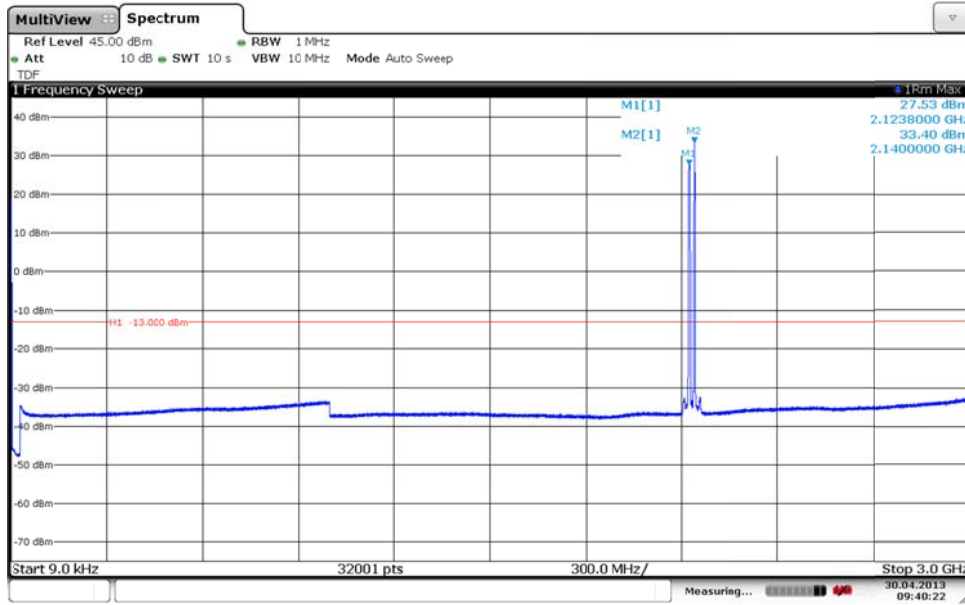

Date: 30.APR.2013 09:40:23

Diagram 5b:

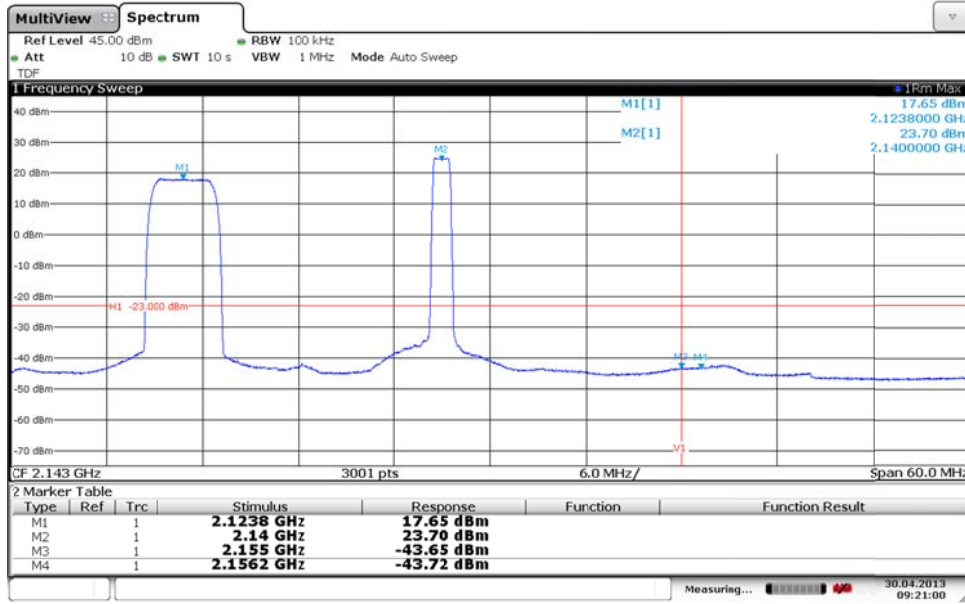

Date: 30.APR.2013 09:21:00

Appendix 3

Diagram 5c:

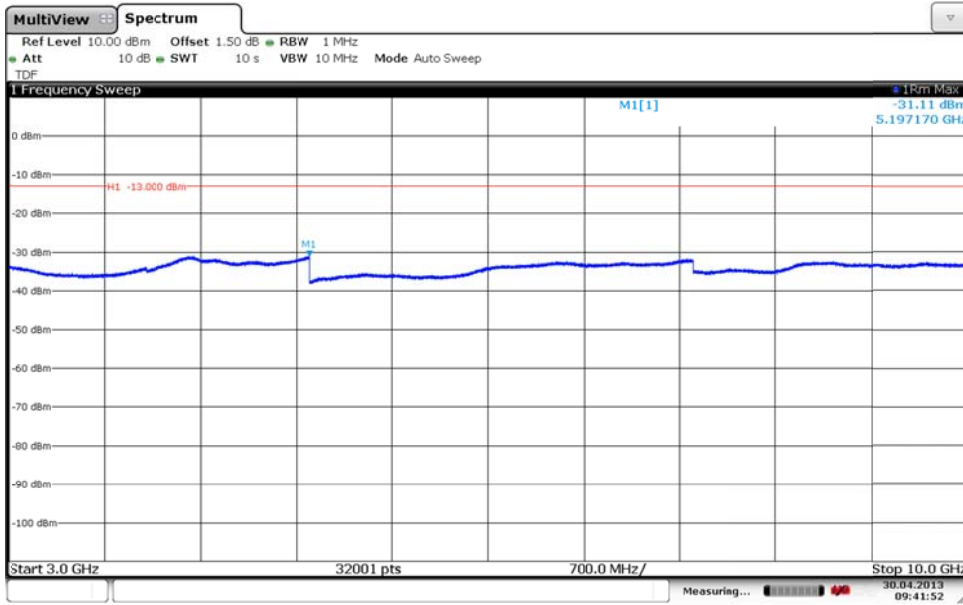
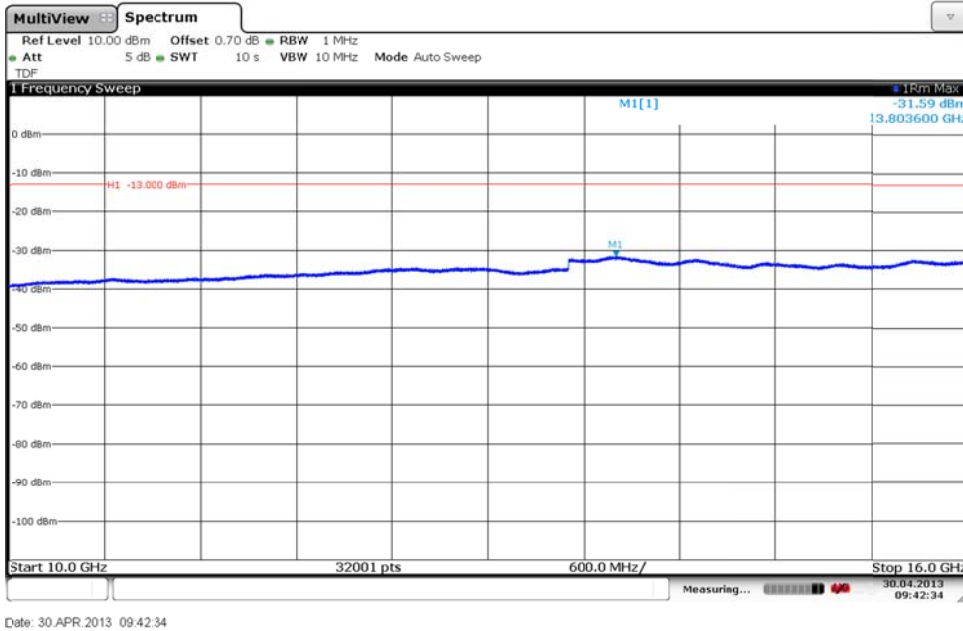
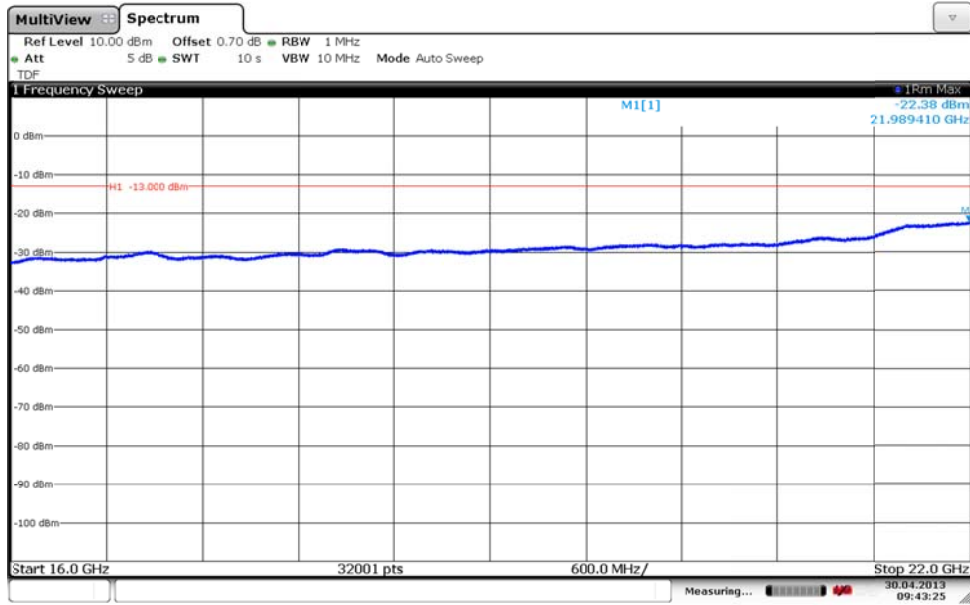

Diagram 5d:



Appendix 3

Diagram 5e:



Date: 30.APR.2013 09:43:25

Appendix 3

Remark

The emission at 9 kHz on the plots was not generated by the test object. A complementary measurement with a smaller RBW showed that it was related to the LO feed-through.

The highest fundamental frequency is 2.155 GHz. The measurements were made up to 22 GHz ($10 \times 2.155 \text{ GHz} = 21.55 \text{ GHz}$).

Limits

§27.53(h) and RSS-139 6.5

Outside a licensee's frequency band(s) of operation the power of any emission shall be attenuated below the transmitter power (P) by at least $43 + 10 \log (P)$ dB, resulting in a limit of -13 dBm per 1 MHz RBW.

Complies?	Yes
-----------	-----

Appendix 4

Field strength of spurious radiation measurements according to 47 CFR 27.53 (h) / IC RSS-139 6.5

Date	Temperature	Humidity
2013-05-06	22°C ± 3°C	34 % ± 5 %

Test set-up and procedure

The test sites are listed at FCC, Columbia with registration number: 93866. The test site complies with RSS-Gen, Industry Canada file no. 3482A-1.

The measurements were performed with both horizontal and vertical polarization of the antenna. The antenna distance was 3 m in the frequency range 30 MHz – 18 GHz and 1m in the frequency range 18 - 22 GHz.

In the frequency range 30 MHz – 22 GHz the measurement was performed in power with a RBW of 1 MHz. A propagation loss in free space was calculated. The used formula was

$$\gamma = 20 \log \left(\frac{4\pi D}{\lambda} \right), \gamma \text{ is the propagation loss and } D \text{ is the antenna distance.}$$

The measurement procedure was as the following:

1. The pre-measurement was first performed with peak detector. The EUT was measured in eight directions and with the antenna at three heights, 1.0 m, 1.5 m and 2.0 m.
2. Spurious radiation on frequencies closer than 20 dB to the limit in the pre-measurement is scanned 0-360 degrees and the antenna is scanned 1- 4 m for maximum response. The emission is then measured with the RMS detector and the RMS value is reported. Frequencies closer than 10 dB to the limit when measured with the RMS detector were measured with the substitution method according to the standard.

Appendix 4

The test set-up during the spurious radiation measurements is shown in the picture below:

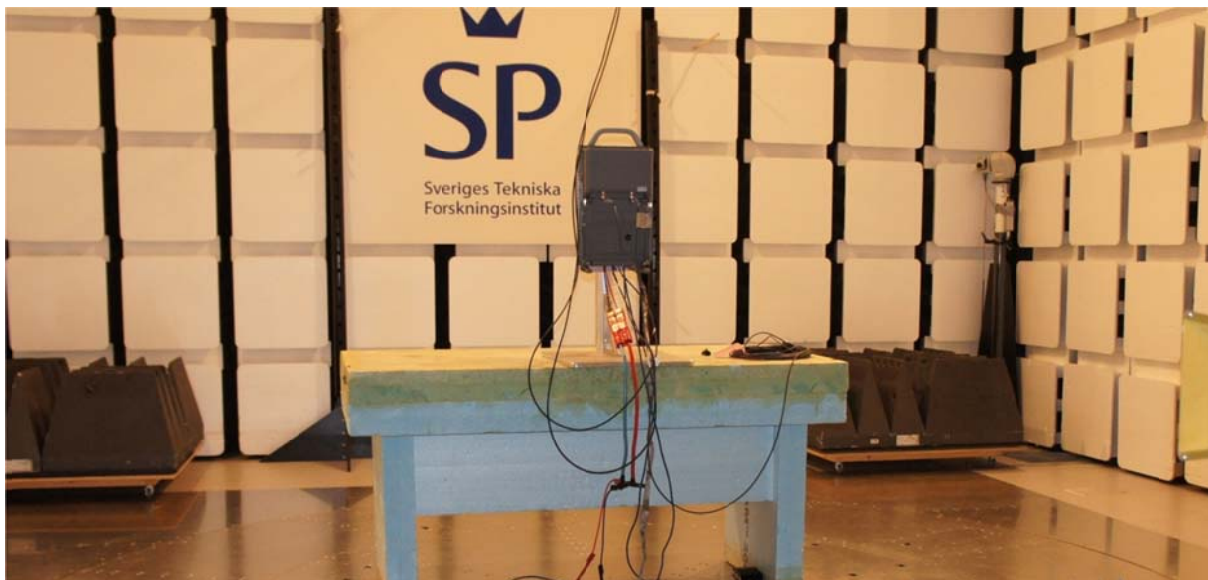

Measurement equipment

Measurement equipment	SP number
Semi anechoic chamber	503 881
R&S ESI 26	503 292
EMC 32 ver. 8.52.0	503 745
Chase Bilog Antenna CBL 6111A	503 182
EMCO Horn Antenna 3115	502 175
Flann STD Gain Horn Antenna 20240-20	503 674
High pass filter, RLC Electronics	901 373
Schwarzbeck preamplifier BBV 9742	504 085
Miteq, Low Noise Amplifier	503 285
µComp Nordic, Low Noise Amplifier	901 545
Testo 635 temperature and humidity meter	504 203

Appendix 4

Tested configurations

Bim 1
Bim 2
Tim 1
Tim 2

Results, representing worst case

Bim 2: Diagram 1 a-d

Frequency (MHz)	Spurious emission level (dBm)	
	Vertical	Horizontal
30-22 000	All emission > 20 dB below limit	All emission > 20 dB below limit

Measurement uncertainty:

3.2 dB up to 18 GHz, 3.6 dB above 18 GHz

Limits

§27.53(h) and RSS-139 6.5

Outside a licensee's frequency band(s) of operation the power of any emission shall be attenuated below the transmitter power (P) by at least $43 + 10 \log (P)$ dB, resulting in a limit of -13 dBm per 1 MHz RBW.

Complies?	Yes
-----------	-----

Appendix 4

Diagram 1a:

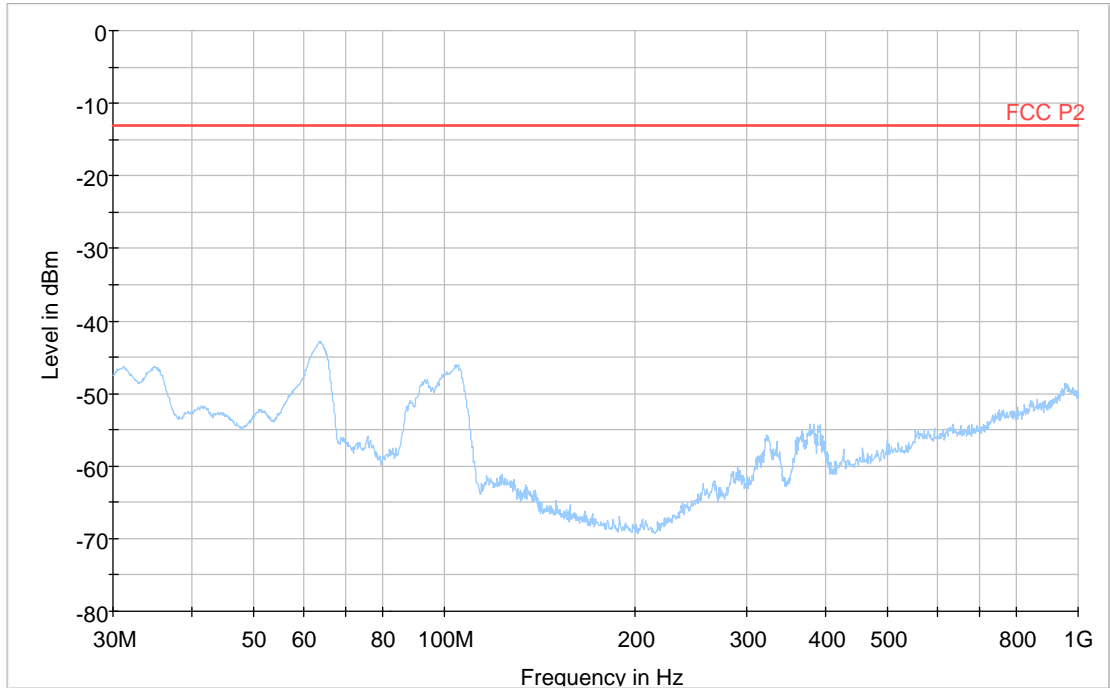
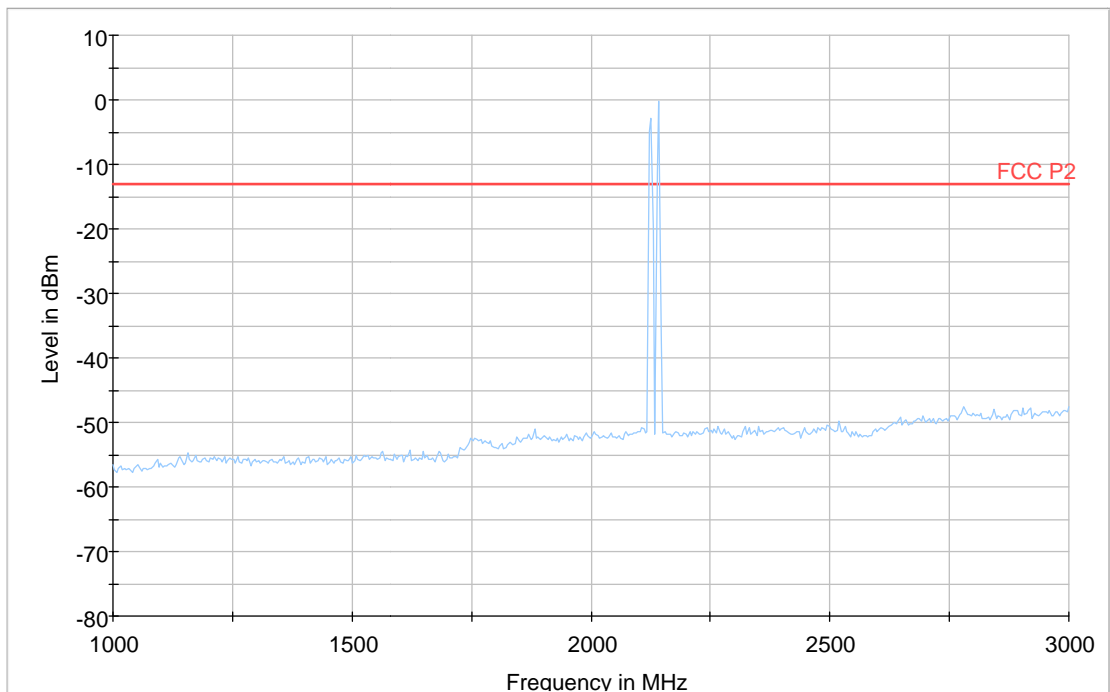

Diagram 1b:



Note: The emission between 2141 and 2148 MHz are the carrier frequencies and shall be ignored in the context.

Appendix 4

Diagram 1c:

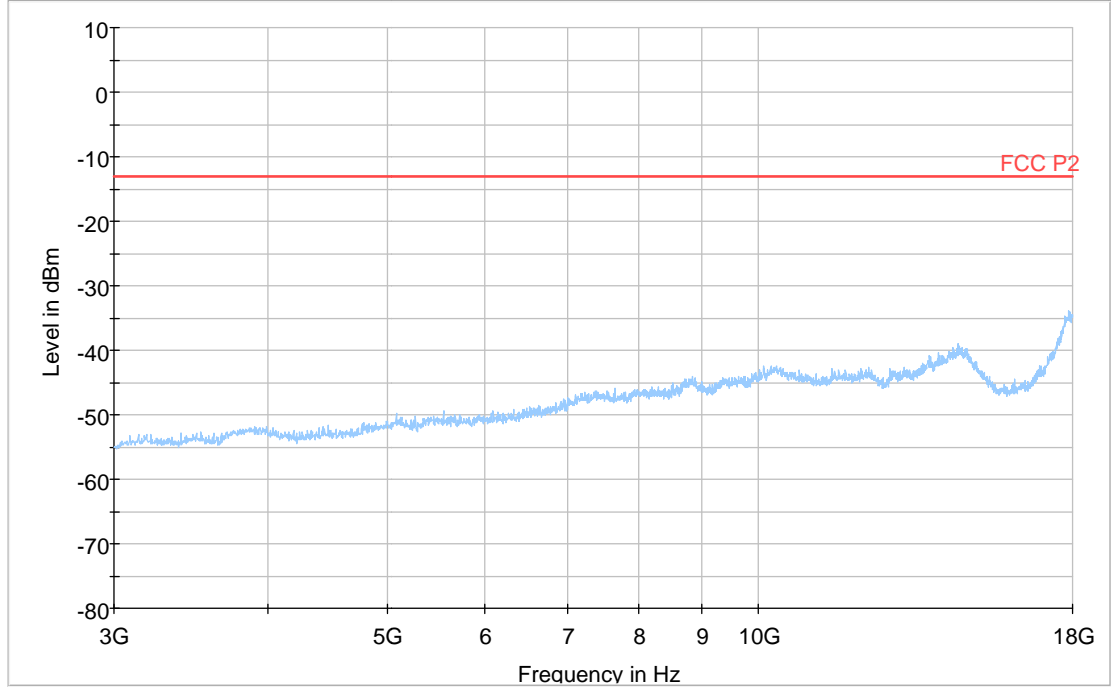
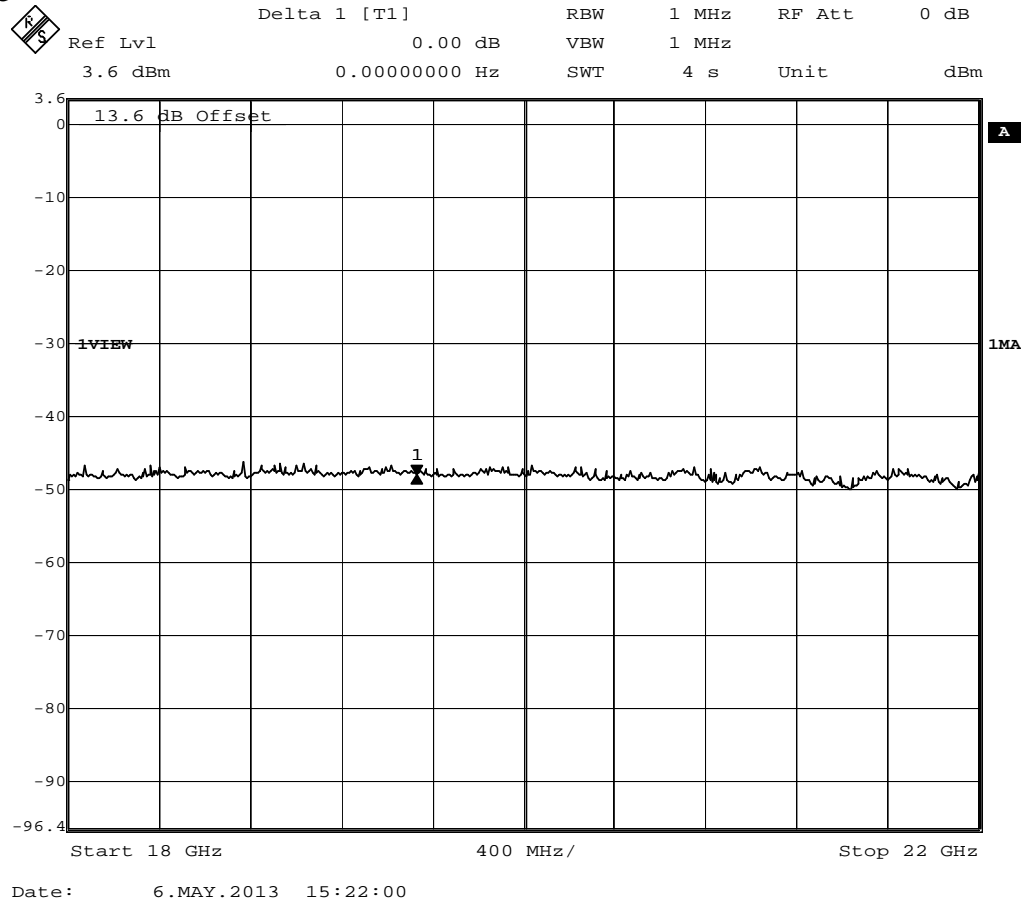

Diagram 1d:



Appendix 5

External photos

Front side



Appendix 5

Rear side

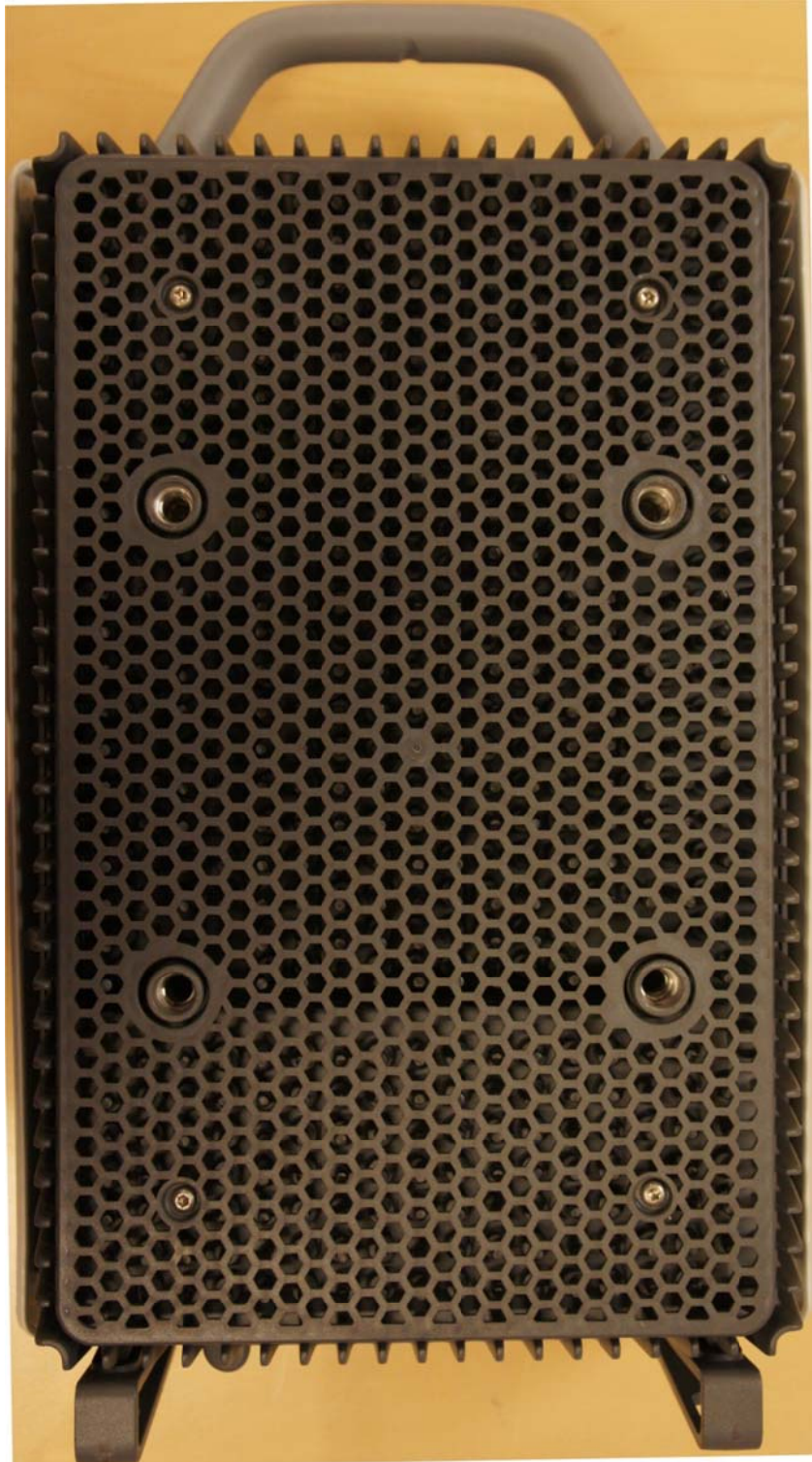

Appendix 5

Left side



Right side



Appendix 5

Bottom side



Top side

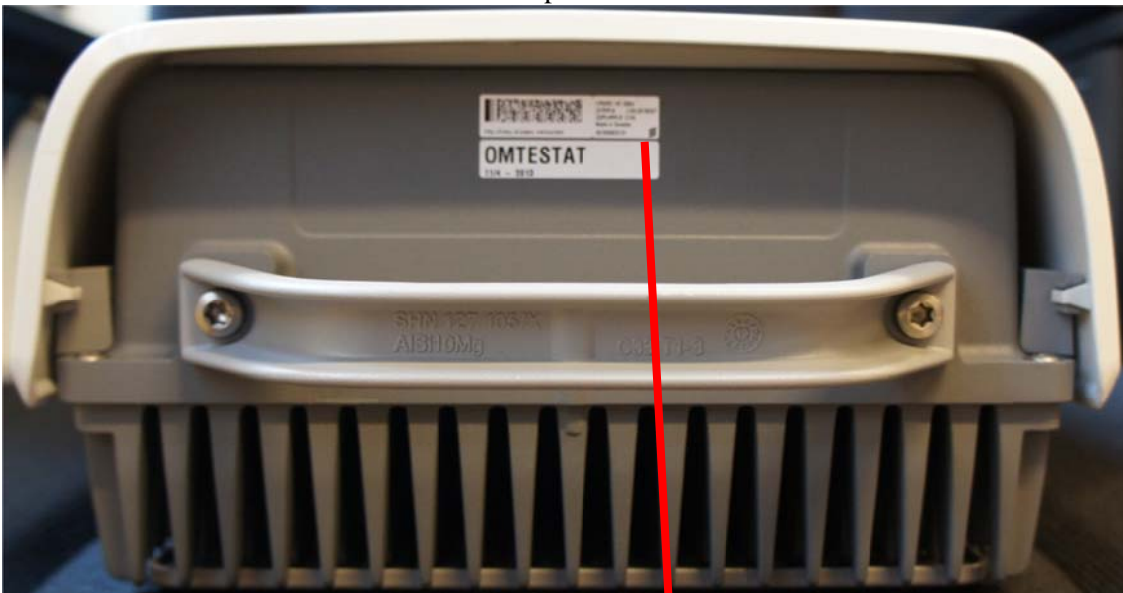

Product label

