



Product Service

**Choose certainty.
Add value.**

Report On

FCC and Industry Canada Testing of the
Ericsson RRUS 11 B4 / KRC 161 254/1

COMMERCIAL-IN-CONFIDENCE

FCC ID: TA8AKRC161254-1

IC ID: 287AB-AS1612541

Document 75914707 Report 01 Issue 1

August 2011



Product Service

TÜV SÜD Product Service Ltd, Octagon House, Concorde Way, Segensworth North,
Fareham, Hampshire, United Kingdom, PO15 5RL
Tel: +44 (0) 1489 558100. Website: www.tuvps.co.uk

COMMERCIAL-IN-CONFIDENCE

REPORT ON

FCC and Industry Canada Testing of the
Ericsson RRUS 11 B4 / KRC 161 254/1

Document 75914707 Report 01 Issue 1

August 2011

PREPARED FOR

Ericsson AB
Torshamnsgatan 23
SE-164 80
Stockholm
Sweden

PREPARED BY

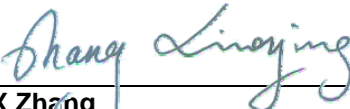

X Zhang
Test Engineer

APPROVED BY



M J Hardy
Authorised Signatory

DATED

31 August 2011

ENGINEERING STATEMENT

The measurements shown in this report were made in accordance with the procedures described on test pages. All reported testing was carried out on a sample equipment to demonstrate compliance with FCC CFR 47: Part 27 and Industry Canada RSS-139. The sample tested was found to comply with the requirements defined in the applied rules.

Test Engineer(s);

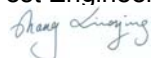

X Zhang



C Zhang





CONTENTS

Section	Page No
1	REPORT SUMMARY 3
1.1	Introduction 4
1.2	Brief Summary of Results 5
1.3	Declaration of Build Status 9
1.4	Product Information 10
1.5	Test Conditions 15
1.6	Deviations From the Standard 15
1.7	Modification Record 15
1.8	Alternative Test Site 15
2	TEST DETAILS 16
2.1	Maximum Peak Output Power - Conducted 17
2.2	Peak – Average Ratio 21
2.3	Modulation Characteristics 36
2.4	Occupied Bandwidth 39
2.5	Spurious Emissions at Antenna Terminals (± 1 MHz) 43
2.6	Radiated Spurious Emissions 49
2.7	Conducted Spurious Emissions 54
2.8	Frequency Stability Under Temperature Variations 62
2.9	Frequency Stability Under Voltage Variations 64
2.10	Receiver Spurious Emissions 66
3	TEST EQUIPMENT USED 71
3.1	Test Equipment Used 72
3.2	Measurement Uncertainty 74
4	ACCREDITATION, DISCLAIMERS AND COPYRIGHT 75
4.1	Accreditation, Disclaimers and Copyright 76



SECTION 1

REPORT SUMMARY

FCC and Industry Canada Testing of the
Ericsson RRUS 11 B4 / KRC 161 254/1



1.1 INTRODUCTION

The information contained in this report is intended to show verification of the Ericsson RRUS 11 B4 / KRC 161 254/1 to the requirements of FCC CFR 47 Part 27 and Industry Canada RSS-139.

Testing was carried out in support of a C2PC application for Grant of RRUS 11 B4 / KRC 161 254/1 for the hardware update.

Objective	To perform FCC and Industry Canada Testing to determine the Equipment Under Test's (EUT's) compliance with the Test Specification, for the series of tests carried out.
Manufacturer	Ericsson AB
Product Name	RRUS 11 B4
Part Number	KRC 161 254/1
IC Model Number	AS1612541
Serial Number(s)	CB4J379552
Software Version	CXP9017316%1_R32LY
Hardware Version	R2C
Number of Samples Tested	1
Test Specification/Issue/Date	FCC CFR 47 Part 27: 2010 Industry Canada RSS-139 Issue 2: 2009
Incoming Release Date	Declaration of Build Status 18 July 2011
Order Number Date	PTP 15 July 2011
Start of Test	21 July 2011
Finish of Test	3 August 2011
Name of Engineer(s)	X Zhang C Zhang
Related Document(s)	ANSI C63.4: 2009 FCC CFR 47 Part 2: 2010 Industry Canada RSS-GEN Issue 3: 2010 3GPP TS 36.141 V9.5.0



1.2 BRIEF SUMMARY OF RESULTS

A brief summary of results in accordance with FCC CFR 47 Part 27 and Industry Canada RSS-139, is shown below.

Configuration 1 – Radio Equipment							
Section	Spec Clause		Test Description	Mode	Mod State	Result	Comments
	FCC Part 2 and 27	RSS-139 and RSS-GEN					
	27.50 (d)	6.4	Effective Radiated Power	2112.4MHz		N/A	No integral antenna.
				2132.4MHz		N/A	
				2152.6MHz		N/A	
				2112.4MHz + 2127.4MHz		N/A	
				2132.4MHz + 2147.4MHz		N/A	
				2137.6MHz + 2152.6MHz		N/A	
				2112.4MHz + 2117.4MHz + 2122.4MHz + 2127.4MHz		N/A	
				2127.4MHz + 2132.4MHz + 2137.4MHz + 2142.4MHz		N/A	
2137.6MHz + 2142.6MHz + 2147.6MHz + 2152.6MHz		N/A					
2.1	2.1046, 27.50 (d)	6.4	Maximum Peak Output Power - Conducted	2112.4MHz	0	Pass	-
				2132.4MHz	0	Pass	
				2152.6MHz	0	Pass	
				2112.4MHz + 2127.4MHz	0	Pass	
				2132.4MHz + 2147.4MHz	0	Pass	
				2137.6MHz + 2152.6MHz	0	Pass	
				2112.4MHz + 2117.4MHz + 2122.4MHz + 2127.4MHz	0	Pass	
				2127.4MHz + 2132.4MHz + 2137.4MHz + 2142.4MHz	0	Pass	
2137.6MHz + 2142.6MHz + 2147.6MHz + 2152.6MHz	0	Pass					
2.2	27.50 (i)	6.4	Peak – Average Ratio	2112.4MHz	0	Pass	-
				2132.4MHz	0	Pass	
				2152.6MHz	0	Pass	
				2112.4MHz + 2127.4MHz	0	Pass	
				2132.4MHz + 2147.4MHz	0	Pass	
				2137.6MHz + 2152.6MHz	0	Pass	
				2112.4MHz + 2117.4MHz + 2122.4MHz + 2127.4MHz	0	Pass	
				2127.4MHz + 2132.4MHz + 2137.4MHz + 2142.4MHz	0	Pass	
2137.6MHz + 2142.6MHz + 2147.6MHz + 2152.6MHz	0	Pass					



Configuration 1 – Radio Equipment							
Section	Spec Clause		Test Description	Mode	Mod State	Result	Comments
	FCC Part 2 and 27	RSS-139 and RSS-GEN					
2.3	2.1047 (d)	6.2	Modulation Characteristics	2112.4MHz		N/A	-
				2132.4MHz	0	Pass	
				2152.6MHz		N/A	
				2112.4MHz + 2127.4MHz		N/A	
				2132.4MHz + 2147.4MHz		N/A	
				2137.6MHz + 2152.6MHz		N/A	
				2112.4MHz + 2117.4MHz + 2122.4MHz + 2127.4MHz		N/A	
				2127.4MHz + 2132.4MHz + 2137.4MHz + 2142.4MHz		N/A	
2137.6MHz + 2142.6MHz + 2147.6MHz + 2152.6MHz		N/A					
2.4	2.1049, 27.53 (h)	RSS-Gen 4.6.1	Occupied Bandwidth	2112.4MHz	0	Pass	-
				2132.4MHz	0	Pass	
				2152.6MHz	0	Pass	
				2112.4MHz + 2127.4MHz		N/A	
				2132.4MHz + 2147.4MHz		N/A	
				2137.6MHz + 2152.6MHz		N/A	
				2112.4MHz + 2117.4MHz + 2122.4MHz + 2127.4MHz		N/A	
				2127.4MHz + 2132.4MHz + 2137.4MHz + 2142.4MHz		N/A	
2137.6MHz + 2142.6MHz + 2147.6MHz + 2152.6MHz		N/A					
2.5	2.1051, 27.53 (h)	6.5	Spurious Emissions at Antenna Terminals (±1MHz)	2112.4MHz	0	Pass	-
				2132.4MHz		N/A	
				2152.6MHz	0	Pass	
				2112.4MHz + 2117.4MHz	0	Pass	
				2132.4MHz + 2147.4MHz		N/A	
				2147.6MHz + 2152.6MHz	0	Pass	
				2112.4MHz + 2117.4MHz + 2122.4MHz + 2127.4MHz		N/A	
				2127.4MHz + 2132.4MHz + 2137.4MHz + 2142.4MHz		N/A	
2137.6MHz + 2142.6MHz + 2147.6MHz + 2152.6MHz		N/A					



Configuration 1 – Radio Equipment							
Section	Spec Clause		Test Description	Mode	Mod State	Result	Comments
	FCC Part 2 and 27	RSS-139 and RSS-GEN					
2.6	2.1053, 27.53 (h)	6.5	Radiated Spurious Emissions	2112.4MHz	0	Pass	-
				2132.4MHz	0	Pass	
				2152.6MHz	0	Pass	
				2112.4MHz + 2127.4MHz		N/A	
				2132.4MHz + 2147.4MHz	0	Pass	
				2137.6MHz + 2152.6MHz		N/A	
				2112.4MHz + 2117.4MHz + 2122.4MHz + 2127.4MHz		N/A	
				2127.4MHz + 2132.4MHz + 2137.4MHz + 2142.4MHz	0	Pass	
2137.6MHz + 2142.6MHz + 2147.6MHz + 2152.6MHz		N/A					
2.7	2.1051, 27.53 (h)	6.5	Conducted Spurious Emissions	2112.4MHz	0	Pass	-
				2132.4MHz	0	Pass	
				2152.6MHz	0	Pass	
				2112.4MHz + 2127.4MHz	0	Pass	
				2132.4MHz + 2147.4MHz	0	Pass	
				2137.6MHz + 2152.6MHz	0	Pass	
				2112.4MHz + 2117.4MHz + 2122.4MHz + 2127.4MHz		N/A	
				2127.4MHz + 2132.4MHz + 2137.4MHz + 2142.4MHz		N/A	
2137.6MHz + 2142.6MHz + 2147.6MHz + 2152.6MHz		N/A					
2.8	2.1055, 27.54	6.3	Frequency Stability Under Temperature Variations	2112.4MHz		N/A	-
				2132.4MHz	0	Pass	
				2152.6MHz		N/A	
				2112.4MHz + 2127.4MHz		N/A	
				2132.4MHz + 2147.4MHz		N/A	
				2137.6MHz + 2152.6MHz		N/A	
				2112.4MHz + 2117.4MHz + 2122.4MHz + 2127.4MHz		N/A	
				2127.4MHz + 2132.4MHz + 2137.4MHz + 2142.4MHz		N/A	
2137.6MHz + 2142.6MHz + 2147.6MHz + 2152.6MHz		N/A					



Configuration 1 – Radio Equipment							
Section	Spec Clause		Test Description	Mode	Mod State	Result	Comments
	FCC Part 2 and 27	RSS-139 and RSS-GEN					
2.9	2.1055, 27.54	6.3	Frequency Stability Under Voltage Variations	2112.4MHz		N/A	-
				2132.4MHz	0	Pass	
				2152.6MHz		N/A	
				2112.4MHz + 2127.4MHz		N/A	
				2132.4MHz + 2147.4MHz		N/A	
				2137.6MHz + 2152.6MHz		N/A	
				2112.4MHz + 2117.4MHz + 2122.4MHz + 2127.4MHz		N/A	
				2127.4MHz + 2132.4MHz + 2137.4MHz + 2142.4MHz		N/A	
2137.6MHz + 2142.6MHz + 2147.6MHz + 2152.6MHz		N/A					
2.10	-	6.6	Receiver Spurious Emissions	2112.4MHz	0	Pass	-
				2132.4MHz	0	Pass	
				2152.6MHz	0	Pass	
				2112.4MHz + 2127.4MHz		N/A	
				2132.4MHz + 2147.4MHz		N/A	
				2137.6MHz + 2152.6MHz		N/A	
				2112.4MHz + 2117.4MHz + 2122.4MHz + 2127.4MHz		N/A	
				2127.4MHz + 2132.4MHz + 2137.4MHz + 2142.4MHz		N/A	
2137.6MHz + 2142.6MHz + 2147.6MHz + 2152.6MHz		N/A					

N/A – Not Applicable



Product Service

1.3 DECLARATION OF BUILD STATUS

MAIN EUT	
MANUFACTURING DESCRIPTION	Radio Equipment
MANUFACTURER	Ericsson AB
PRODUCT NAME	RRUS 11 B4
PART NUMBER	KRC 161 254/1
IC Model Number	AS1612541
SERIAL NUMBER(s)	CB4J379552
HARDWARE VERSION	R2C
SOFTWARE VERSION	CXP9017316%1_R32LY
TRANSMITTER OPERATING RANGE	TX: 2110MHz - 2155MHz RX: 1710MHz - 1755MHz
MODULATIONS	QPSK, 16QAM, 64QAM
INTERMEDIATE FREQUENCIES	--
ITU DESIGNATION OF EMISSION	5M00F9W
CHANNEL BANDWIDTH	4.2 to 5MHz (configurable in steps of 100/200kHz)
OUTPUT POWER (RMS) (W or dBm)	Single Carrier: 1 x 44.8dBm (1 x 30W) Multi Carrier (x 2): 2 x 41.8dBm (2 x 15W) Multi Carrier (x 4): 4 x 38.8dBm (4 x 7.5W)
NUMBER OF ANTENNA PORTS	2 TX/RX ports
SUPPORTED CONFIGURATION	Dual Single Carrier. Both RF chains are identical
FCC ID	TA8AKRC161254-1
IC ID	287AB-AS1612541
TECHNICAL DESCRIPTION (a brief description of the intended use and operation)	The equipment is the Radio Part of WCDMA Base Station.

Signature

Date

8 August 2011

D of B S Serial No

75914707 /01

No responsibility will be accepted by TÜV SÜD Product Service Ltd as to the accuracy of the information declared in this document by the manufacturer.



1.4 PRODUCT INFORMATION

1.4.1 Technical Description

The Equipment Under Test (EUT) RRUS 11 B4 / KRC 161 254/1 is an Ericsson Radio Equipment working in the public mobile service 2100MHz band which provides communication connections to WCDMA2100 network. The RRUS 11 B4 / KRC 161 254/1 operates from a -48V DC supply.

The Equipment Under Test (EUT) is shown in the photograph below. A full technical description can be found in the Manufacturers documentation.

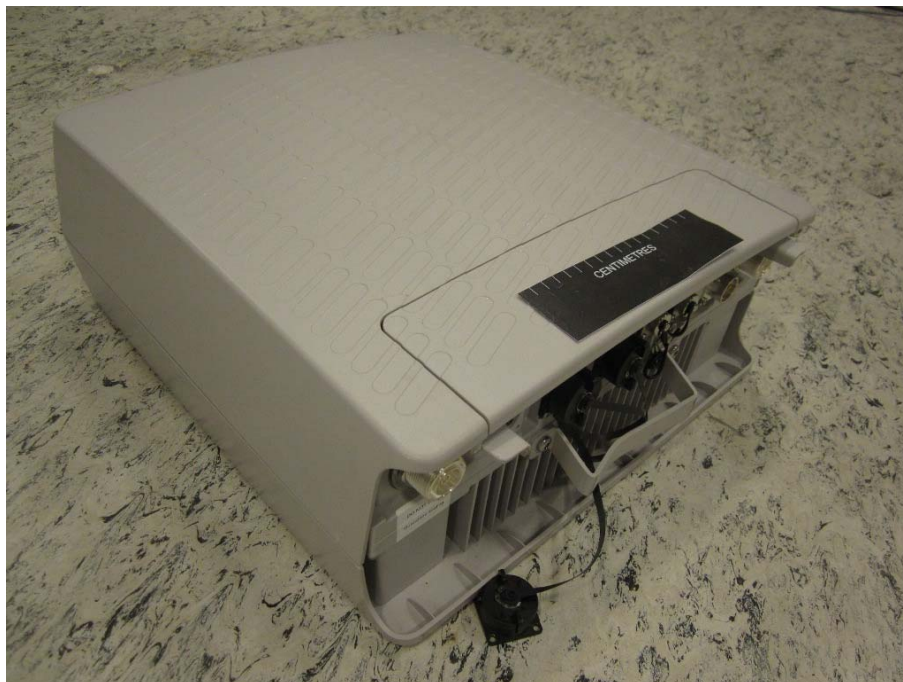

Equipment Under Test



1.4.2 Test Configuration

Configuration 1: Radio Equipment

The EUT was configured in accordance with FCC CFR 47 Part 27 and Industry Canada RSS-139.

The RRUS 11 B4 / KRC 161 254/1 supports Test Models TM1, TM5 and TM6 at 2100MHz defined in 3GPP TS 25.141. Test Model 1 (TM1) uses the QPSK modulation only, Test Model 5 (TM5) includes 16QAM modulation and Test Model 6 (TM6) includes 64QAM modulation.

The settings below were found to be representative for all traffic scenarios when several settings with the different modulations, channel bandwidths and the number of carriers were tested to find the worst case setting. These settings were used for all measurements if not otherwise stated:

Single carrier:

Test Model 1 (TM1): 64 DPCHs at 30 ksps (SF=128)

Multi carrier (1x2):

Test model 1 (TM1): 32 DPCHs at 30 ksps (SF=128)

Channel bandwidth 5MHz

The EUT has two TX/RX ports and it can be configured to transmit with 2100MHz single or multi carrier at both RF output connectors. All TX measurements were performed on the combined TX/RX output connector RF A. Limited complementary TX measurements were done at connector RF B to verify identical performance for both transmitter chains. RX testing was performed on the RX connector RF B of the EUT when the EUT was set as single Transmitter. The complete testing was performed with the EUT transmitting at maximum RF power unless otherwise stated.

The EUT was powered by a -48V DC Power supply.



Test Setup, Conducted Measurement:

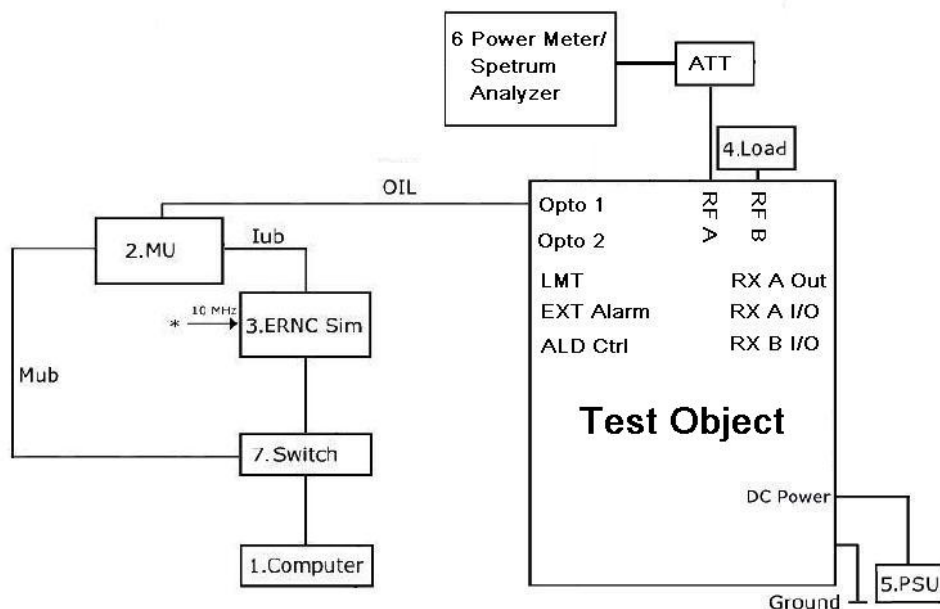

Test Object	Part Number	Version	Serial Number
Radio Part	RRUS 11 B4 / KRC 161 254/1	R2C	CB4J379552

No.	Auxiliary Equipment	Part Number / Model Type	Version	Serial Number
1	Computer	Sun Ultra 45	--	0826TFC1VX
2.1	RBS 6601 (Master)	BFL 901 009/1	--	--
	DUW 3001	KDU 127 161/3	R4C	CB24609602
	SUP 6601	1/BFL 901 009/1	R3B	BR80910316
2.2	RBS 6601 (Slave)	BFL 901 009/1	--	--
	DUW 3001	KDU 127 161/3	R4C	CB24609609
	SUP 6601	1/BFL 901 009/1	R3B	BR81262545
3	RNC Sim	2/BFD 7422018	R1B	TB81009397
4	Load	TFZ50C-3FR	--	JW08042-04A-007
5	Power Supply	DH1716-5D	--	200360033
	Power Supply	DH1716A-14	--	20080405
6	Power Metre	Rohde & Schwarz NRP	--	102624
	Thermal Power Sensor	Rohde & Schwarz NRP-Z51	--	102168
	Spectrum Analyzer	FSQ26	--	200014
7	Switch	TEH1085K	--	S108SK014848011011



Test Setup, Radiated Measurement:

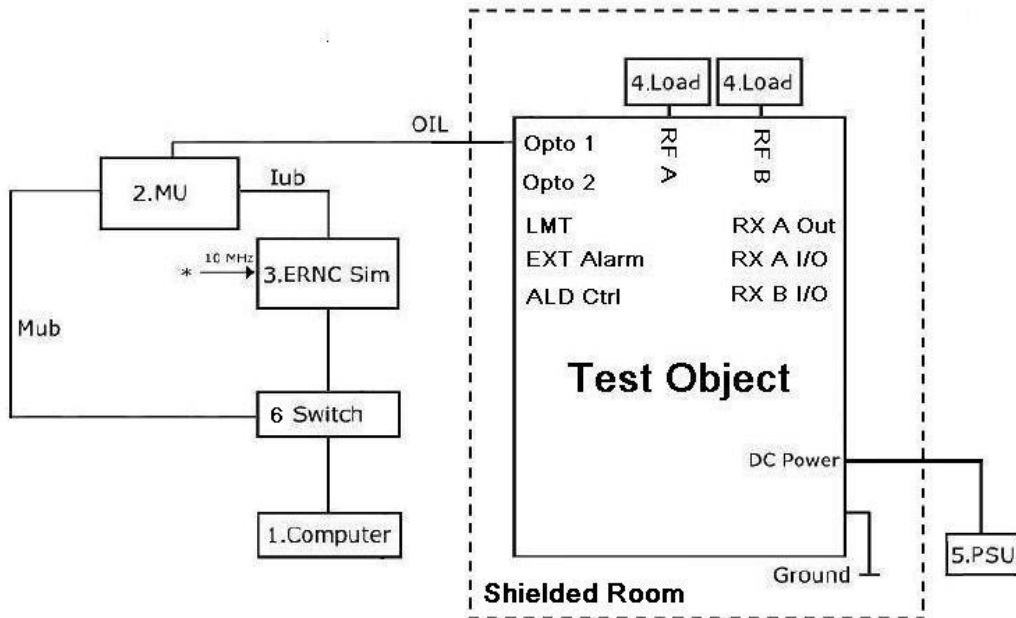

Test Object	Part Number	Version	Serial Number
Radio Part	RRUS 11 B4 / KRC 161 254/1	R2C	CB4J379552

No.	Auxiliary Equipment	Part Number / Model Type	Version	Serial Number
1	Computer	Sun Ultra 45	--	0826TFC1VX
2.1	RBS 6601 (Master)	BFL 901 009/1	--	--
	DUW 3001	KDU 127 161/3	R4C	CB24609602
	SUP 6601	1/BFL 901 009/1	R3B	BR80910316
2.2	RBS 6601 (Slave)	BFL 901 009/1	--	--
	DUW 3001	KDU 127 161/3	R4C	CB24609609
	SUP 6601	1/BFL 901 009/1	R3B	BR81262545
3	RNC Sim	2/BFD 7422018	R1B	TB81009397
4	Load	TF150-3	--	090323433
	Load	TF100	--	09121603
5	Power Supply	DH1716-5D	--	200360033
	Power Supply	DH1716A-14	--	20080405
6	Switch	TEH1085K	--	S108SK014848011011



1.4.3 Modes of Operation

Modes of operation of each EUT during testing were as follows:

Mode 1 - ARFCN 1537: 2112.4MHz (Bottom Channel)

Mode 2 - ARFCN 1637: 2132.4MHz (Middle Channel)

Mode 3 - ARFCN 1738: 2152.6MHz (Top Channel)

Mode 4 - ARFCN 1537 + 1612: 2112.4MHz + 2127.4MHz (B and B+15MHz)

Mode 5 - ARFCN 1637 + 1712: 2132.4MHz + 2147.4MHz (M and M+15MHz)

Mode 6 - ARFCN 1663 + 1738: 2137.6MHz + 2152.6MHz (T-15MHz and T)

Mode 7 - ARFCN 1537 + 1562: 2112.4MHz + 2117.4MHz (B and B+5MHz)

Mode 8 - ARFCN 1713 + 1738: 2147.6MHz + 2152.6MHz (T-5MHz and T)

Mode 9 - ARFCN 1537 + 1562 + 1587 + 1612:
2112.4MHz + 2117.4MHz + 2122.4MHz + 2127.4MHz (B, B+5MHz, B+10MHz and B+15MHz)

Mode 10 - ARFCN 1612 + 1637 + 1662 + 1687:
2127.4MHz + 2132.4MHz + 2137.4MHz + 2142.4MHz (M-5MHz, M, M+5MHz and M+10MHz)

Mode 11 - ARFCN 1663 + 1688 + 1713 + 1738:
2137.6MHz + 2142.6MHz + 2147.6MHz + 2152.6MHz (T-15MHz, T-10MHz, T-5MHz and T)

Information on the specific test modes utilised are detailed in the test procedure for each individual test.



1.5 TEST CONDITIONS

For all tests the EUT was set up in accordance with the relevant test standard and to represent typical operating conditions. Tests were applied with the EUT situated in a shielded enclosure, test laboratories or an open test area as appropriate.

The EUT was powered from a -48V DC supply.

1.6 DEVIATIONS FROM THE STANDARD

No deviations from the applicable test standards or test plan were made during testing.

1.7 MODIFICATION RECORD

No modifications were made to the EUT during testing.

1.8 ALTERNATIVE TEST SITE

Testing has been performed under the following site registrations:

FCC Accreditation 910917:

The State Radio Monitoring Centre, No.80 Beilishi Road Xicheng District Beijing, China.

Industry Canada Accreditation 7308A:

The State Radio Monitoring Centre, No.80 Beilishi Road Xicheng District Beijing, China.



Product Service

SECTION 2

TEST DETAILS

FCC and Industry Canada Testing of the
Ericsson RRUS 11 B4 / KRC 161 254/1



Product Service

2.1 MAXIMUM PEAK OUTPUT POWER - CONDUCTED

2.1.1 Specification Reference

FCC CFR 47 Part 2.1046
 FCC CFR 47 Part 27, Clause 27.50 (d)
 Industry Canada RSS-139, Clause 6.4

2.1.2 Equipment Under Test

RRUS 11 B4 / KRC 161 254/1, S/N: CB4J379552

2.1.3 Date of Test and Modification State

21 and 22 July 2011 – Modification State 0

2.1.4 Test Equipment Used

The major items of test equipment used for the above tests are identified in Section 3.1.

2.1.5 Test Method and Operating Modes

The test was applied in accordance with the test method requirements of FCC CFR 47 Part 2 and Part 27 and Industry Canada RSS-139.

Using a power meter and attenuator(s), the output power of the EUT was measured at the antenna terminal. The carrier power was measured with QPSK, 16QAM and 64QAM using the test model described.

The path loss was measured and entered as a reference level offset.

The test was performed with the EUT in the following configurations and modes of operation:

Configuration 1 - Mode 1
 - Mode 2
 - Mode 3
 - Mode 4
 - Mode 5
 - Mode 6
 - Mode 9
 - Mode 10
 - Mode 11

2.1.6 Environmental Conditions

	21 July 2011	22 July 2011
Ambient Temperature	24.8°C	25.0°C
Relative Humidity	55.0%	59.5%

2.1.7 Test Results

For the period of test the EUT met the requirements of FCC CFR 47 Part 2 and Part 27 and Industry Canada RSS-139 for Maximum Peak Output Power.

The test results are shown below

Single Carrier

Configuration 1 - Mode 1, 2 and 3

TM1

UARFCN	Frequency (MHz)	Path Loss (dB)	Result (dBm) RMS	Result (W) RMS
1537 (Bottom)	2112.4	40.9	44.74	29.79
1637 (Middle)	2132.4	40.9	44.61	28.91
1738 (Top)	2152.6	40.9	44.73	29.72

TM5

UARFCN	Frequency (MHz)	Path Loss (dB)	Result (dBm) RMS	Result (W) RMS
1537 (Bottom)	2112.4	40.9	44.70	29.51
1637 (Middle)	2132.4	40.9	44.65	29.17
1738 (Top)	2152.6	40.9	44.78	30.06

TM6

UARFCN	Frequency (MHz)	Path Loss (dB)	Result (dBm) RMS	Result (W) RMS
1537 (Bottom)	2112.4	40.9	44.52	28.31
1637 (Middle)	2132.4	40.9	44.43	27.73
1738 (Top)	2152.6	40.9	44.55	28.51

**Multi Carrier (1x2)**Configuration 1 - Mode 4, 5 and 6TM1

UARFCN	Frequency (MHz)	Path Loss (dB)	Result (dBm) RMS	Result (W) RMS
1537 & 1612	2112.4 & 2127.4	40.9	44.64	29.11
1637 & 1712	2132.4 & 2147.4	40.9	44.59	28.77
1663 & 1738	2137.6 & 2152.6	40.9	44.68	29.37

TM5

UARFCN	Frequency (MHz)	Path Loss (dB)	Result (dBm) RMS	Result (W) RMS
1537 & 1612	2112.4 & 2127.4	40.9	44.71	29.58
1637 & 1712	2132.4 & 2147.4	40.9	44.69	29.44
1663 & 1738	2137.6 & 2152.6	40.9	44.72	29.65

TM6

UARFCN	Frequency (MHz)	Path Loss (dB)	Result (dBm) RMS	Result (W) RMS
1537 & 1612	2112.4 & 2127.4	40.9	44.49	28.12
1637 & 1712	2132.4 & 2147.4	40.9	44.47	27.99
1663 & 1738	2137.6 & 2152.6	40.9	44.53	28.38



Multi Carrier (1x4)

Configuration 1 - Mode 9, 10 and 11

TM1

UARFCN	Frequency (MHz)	Path Loss (dB)	Result (dBm) RMS	Result (W) RMS
1537 & 1562 & 1587 & 1612	2112.4 & 2117.4 & 2122.4 & 2127.4	40.9	44.63	29.04
1612 & 1637 & 1713 & 1738	2127.4 & 2132.4 & 2137.4 & 2142.4	40.9	44.71	29.58
1663 & 1688 & 1713 & 1738	2137.6 & 2142.6 & 2147.6 & 2152.6	40.9	44.66	29.24

TM5

UARFCN	Frequency (MHz)	Path Loss (dB)	Result (dBm) RMS	Result (W) RMS
1537 & 1562 & 1587 & 1612	2112.4 & 2117.4 & 2122.4 & 2127.4	40.9	44.59	28.77
1612 & 1637 & 1713 & 1738	2127.4 & 2132.4 & 2137.4 & 2142.4	40.9	44.73	29.72
1663 & 1688 & 1713 & 1738	2137.6 & 2142.6 & 2147.6 & 2152.6	40.9	44.68	29.38

TM6

UARFCN	Frequency (MHz)	Path Loss (dB)	Result (dBm) RMS	Result (W) RMS
1537 & 1562 & 1587 & 1612	2112.4 & 2117.4 & 2122.4 & 2127.4	40.9	44.23	26.49
1612 & 1637 & 1713 & 1738	2127.4 & 2132.4 & 2137.4 & 2142.4	40.9	44.28	26.79
1663 & 1688 & 1713 & 1738	2137.6 & 2142.6 & 2147.6 & 2152.6	40.9	44.23	26.49

Limit	≤1640W/MHz or ≤+62.1dBm/MHz
-------	-----------------------------

Remarks

The EUT does not exceed 1640W/MHz or 62.1dBm/MHz at the measured frequencies.



2.2 PEAK – AVERAGE RATIO

2.2.1 Specification Reference

FCC CFR 47 Part 27, Clause 27.50 (i)
Industry Canada RSS-139, Clause 6.4

2.2.2 Equipment Under Test

RRUS 11 B4 / KRC 161 254/1, S/N: CB4J379552

2.2.3 Date of Test and Modification State

21, 22 and 25 to 27 July 2011 – Modification State 0

2.2.4 Test Equipment Used

The major items of test equipment used for the above tests are identified in Section 3.1.

2.2.5 Test Method and Operating Modes

The test was applied in accordance with the test method requirements of FCC CFR 47 Part 27 and Industry Canada RSS-139.

A peak to average ratio measurement is performed at the conducted port of the EUT. The spectrum analyzers Complementary Cumulative Distribution Function (CCDF) measurement profile is used to determine the largest deviation between the average and the peak power of the EUT in given bandwidth. The CCDF curve shows how much time the peak waveform spends at or above a given average power level. The percent of time the signal spends at or above the level defines the probability for that particular power level.

The spectrum analyzer Measurement bandwidth was set to 10MHz for single carrier and 20MHz for multi carrier and the path loss measured and entered as a reference level offset.

The test was performed with the EUT operating on the modes in section 1.4.3 and record the result of the following configurations and modes of operation for worst case:

- Configuration 1 - Mode 1
- Mode 2
- Mode 3
- Mode 4
- Mode 5
- Mode 6
- Mode 9
- Mode 10
- Mode 11

2.2.6 Environmental Conditions

	21 July 2011	22 July 2011	25 July 2011	26 July 2011	27 July 2011
Ambient Temperature	24.8°C	25.0°C	23.2°C	24.0°C	24.8°C
Relative Humidity	55.0%	59.5%	58.0%	54.5%	55.0%



Product Service

2.2.7 Test Results

For the period of test the EUT met the requirements of FCC CFR 47 Part 27 and Industry Canada RSS-139 for Peak – Average Ratio.

The test results are shown below.

Single Carrier

Configuration 1 - Mode 1

TM1

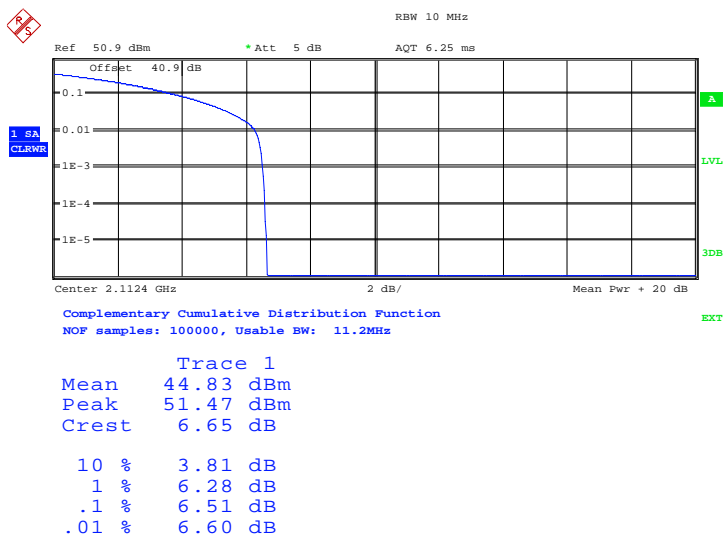

Date: 21.JUL.2011 01:49:55



Product Service

TM5

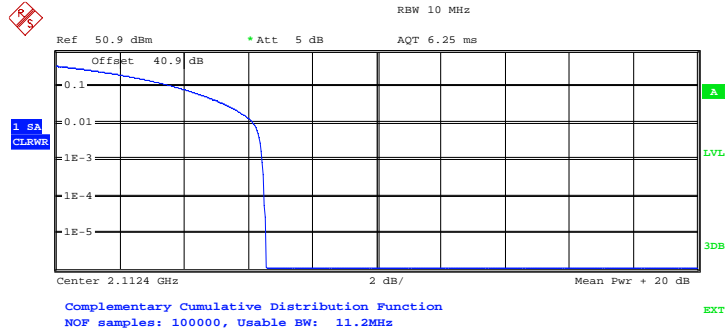

Trace 1

Mean	44.80 dBm
Peak	51.36 dBm
Crest	6.56 dB
10 %	3.75 dB
1 %	6.15 dB
.1 %	6.44 dB
.01 %	6.51 dB

Date: 21.JUL.2011 06:51:53

TM6

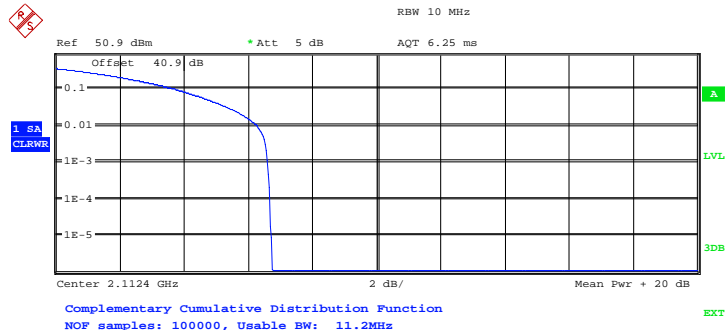

Trace 1

Mean	44.65 dBm
Peak	51.40 dBm
Crest	6.75 dB
10 %	3.75 dB
1 %	6.25 dB
.1 %	6.60 dB
.01 %	6.70 dB

Date: 21.JUL.2011 08:18:12



Product Service

Configuration 1 - Mode 2

TM1

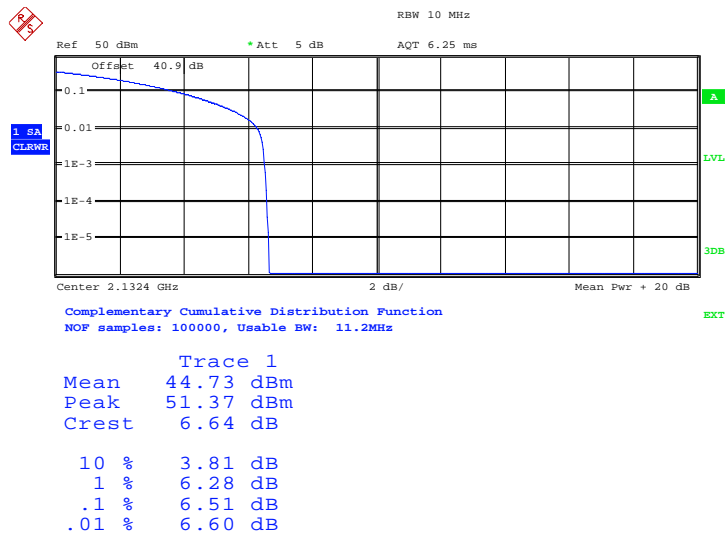

Date: 21.JUL.2011 02:50:44

TM5

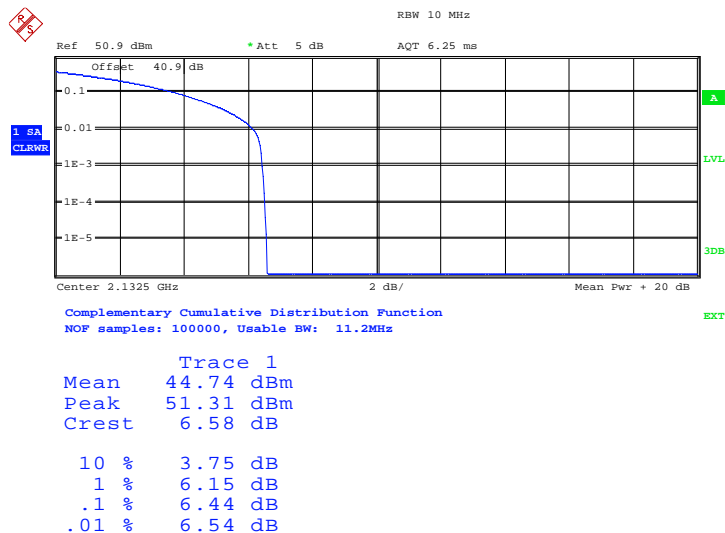

Date: 21.JUL.2011 05:54:43



Product Service

TM6

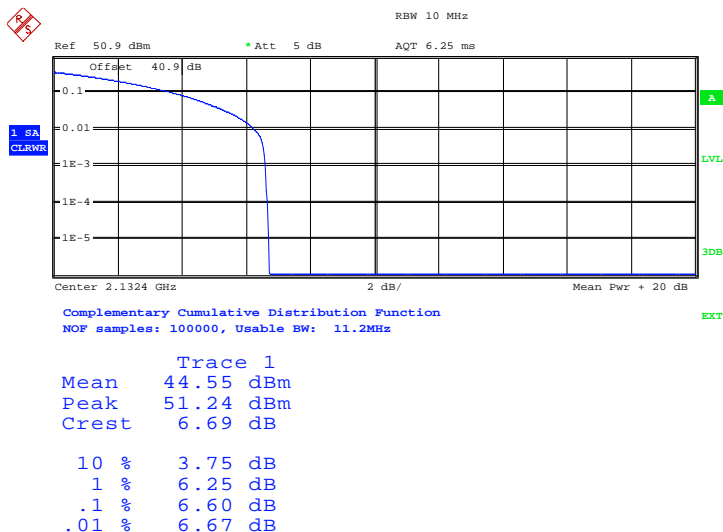

Date: 21.JUL.2011 07:27:38

Configuration 1 - Mode 3

TM1

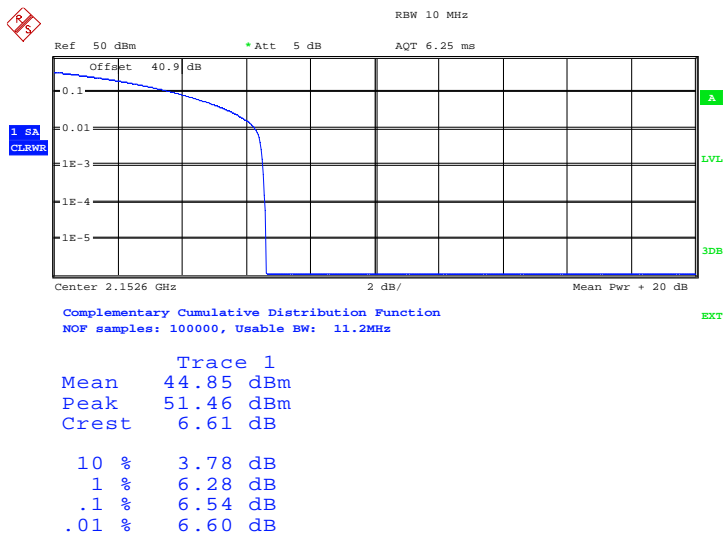

Date: 22.JUL.2011 01:52:05



Product Service

TM5

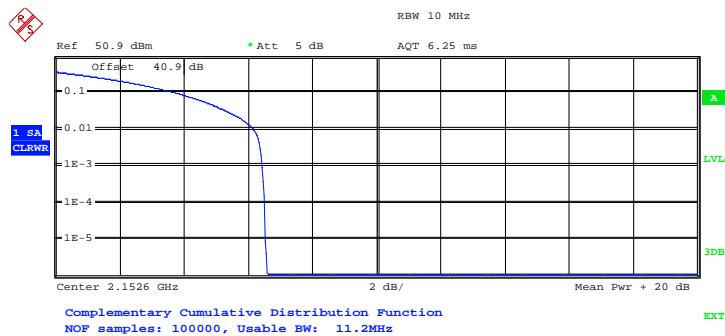

Trace 1
Mean 44.89 dBm
Peak 51.48 dBm
Crest 6.59 dB

10 % 3.75 dB
1 % 6.15 dB
.1 % 6.44 dB
.01 % 6.51 dB

Date: 21.JUL.2011 05:43:33

TM6

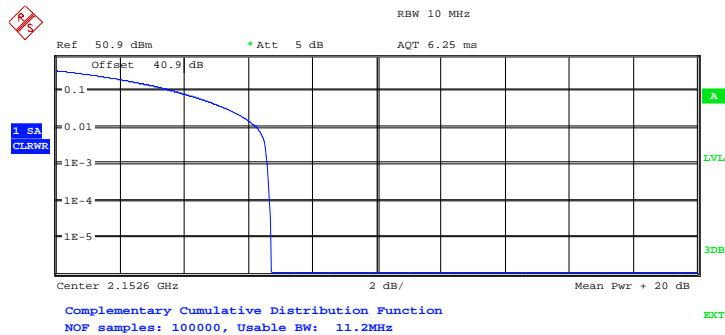

Trace 1
Mean 44.68 dBm
Peak 51.38 dBm
Crest 6.70 dB

10 % 3.75 dB
1 % 6.25 dB
.1 % 6.60 dB
.01 % 6.67 dB

Date: 21.JUL.2011 08:48:12



Product Service

Multi Carrier (1x2)

Configuration 1 - Mode 4

TM1

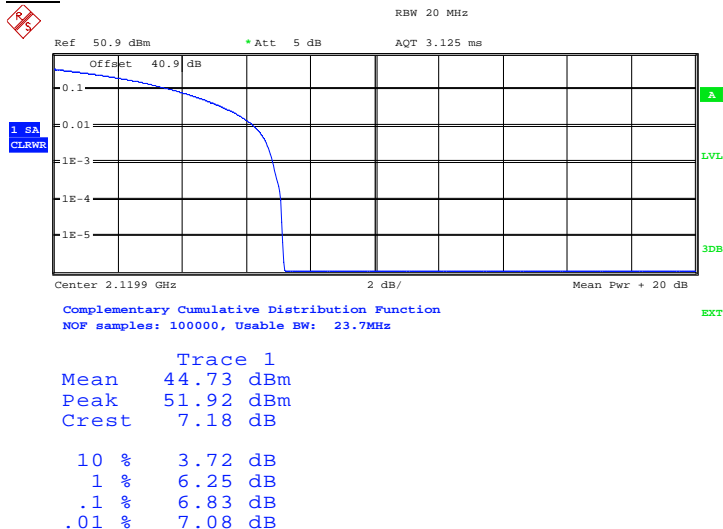

Date: 26.JUL.2011 05:41:26

TM5

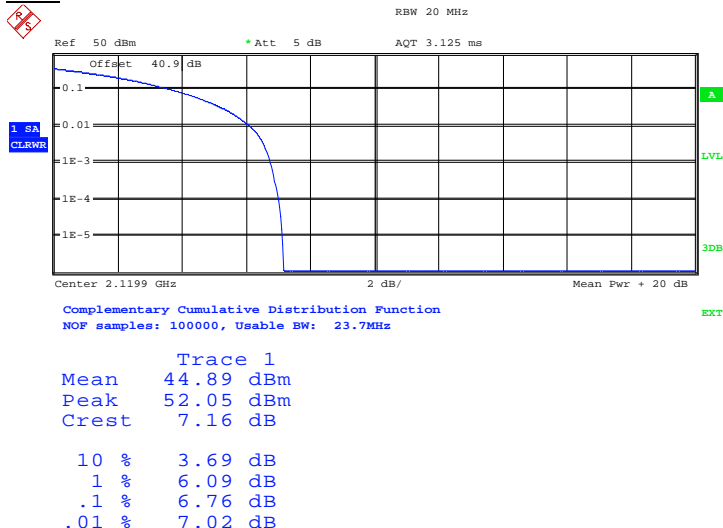

Date: 22.JUL.2011 06:02:43



Product Service

TM6

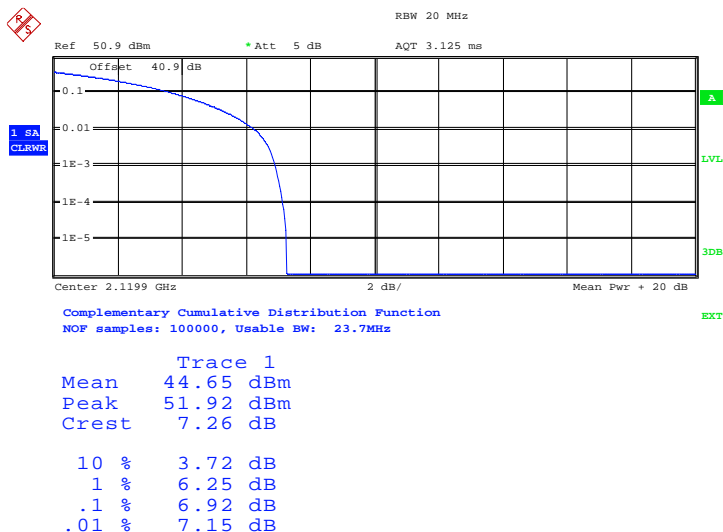

Date: 22.JUL.2011 07:28:16

Configuration 1 - Mode 5

TM1

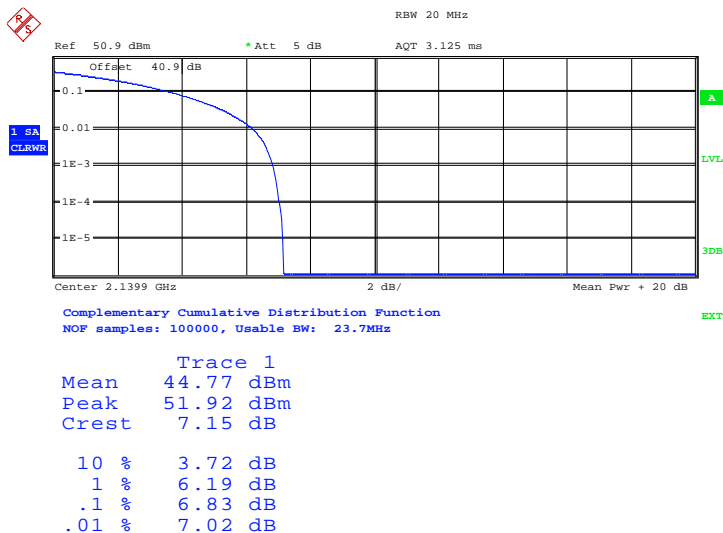

Date: 22.JUL.2011 03:10:50



Product Service

TM5

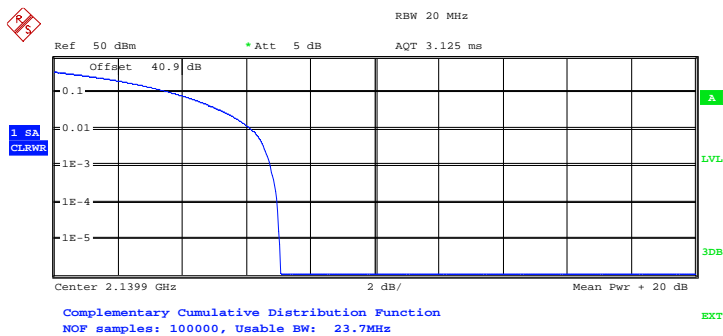

Trace 1

Mean	44.78 dBm
Peak	51.84 dBm
Crest	7.06 dB
10 %	3.69 dB
1 %	6.15 dB
.1 %	6.76 dB
.01 %	6.96 dB

Date: 22.JUL.2011 06:18:29

TM6

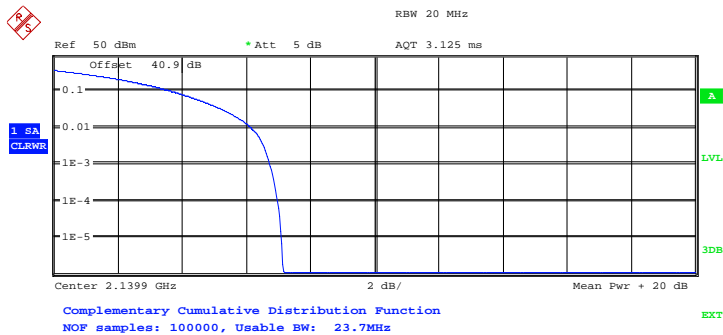

Trace 1

Mean	44.76 dBm
Peak	51.91 dBm
Crest	7.15 dB
10 %	3.72 dB
1 %	6.15 dB
.1 %	6.73 dB
.01 %	6.99 dB

Date: 22.JUL.2011 06:38:57



Product Service

Configuration 1 - Mode 6

TM1

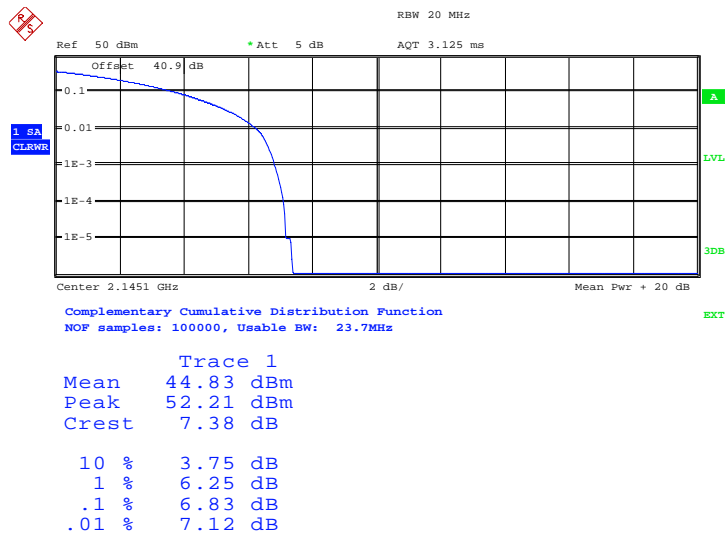

Date: 22.JUL.2011 04:52:08

TM5

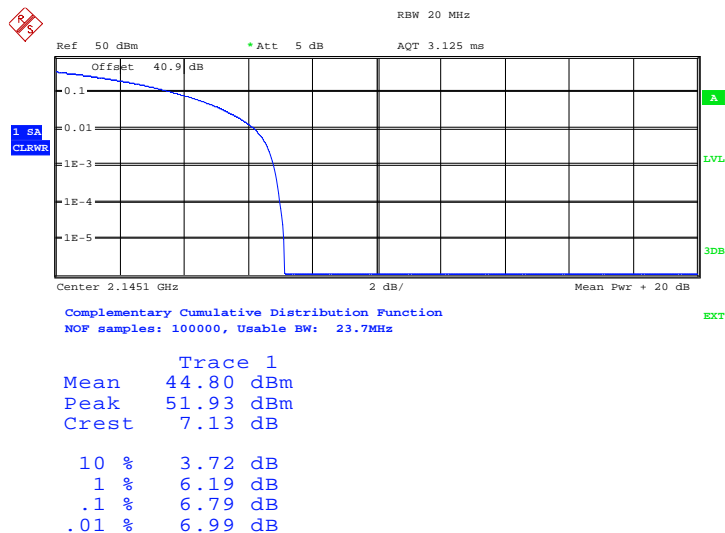

Date: 22.JUL.2011 05:18:32



Product Service

TM6

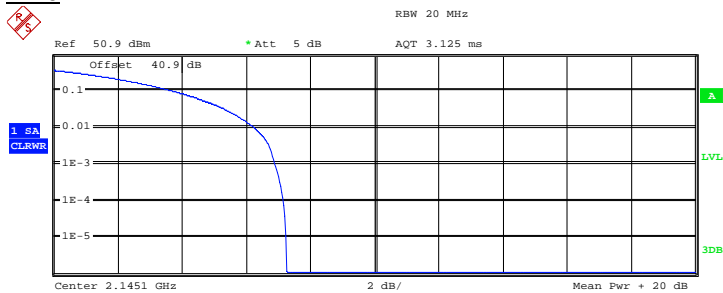

Center 2.1451 GHz 2 dB/ Mean Pwr + 20 dB
Complementary Cumulative Distribution Function
NOF samples: 100000, Usable BW: 23.7MHz EXT

Trace 1
Mean 44.69 dBm
Peak 51.94 dBm
Crest 7.24 dB

10 % 3.72 dB
1 % 6.25 dB
.1 % 6.89 dB
.01 % 7.15 dB

Date: 22.JUL.2011 07:43:01

Multi Carrier (1x4)

Configuration 1 - Mode 9

TM1

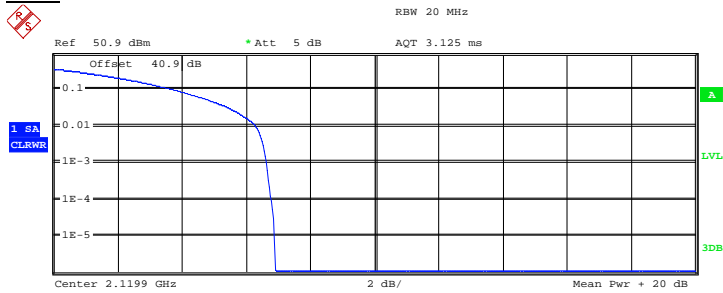

Center 2.1199 GHz 2 dB/ Mean Pwr + 20 dB
Complementary Cumulative Distribution Function
NOF samples: 100000, Usable BW: 23.7MHz EXT

Trace 1
Mean 44.75 dBm
Peak 51.63 dBm
Crest 6.89 dB

10 % 3.75 dB
1 % 6.28 dB
.1 % 6.63 dB
.01 % 6.76 dB

Date: 25.JUL.2011 08:09:29



Product Service

TM5

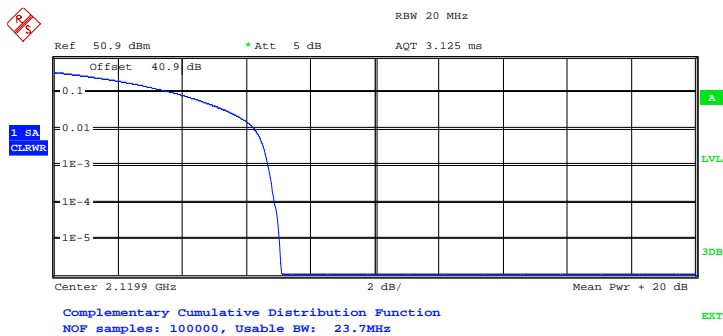

Trace 1

Mean	44.34 dBm
Peak	51.42 dBm
Crest	7.09 dB
10 %	3.75 dB
1 %	6.25 dB
.1 %	6.67 dB
.01 %	6.89 dB

Date: 27.JUL.2011 04:55:29

TM6

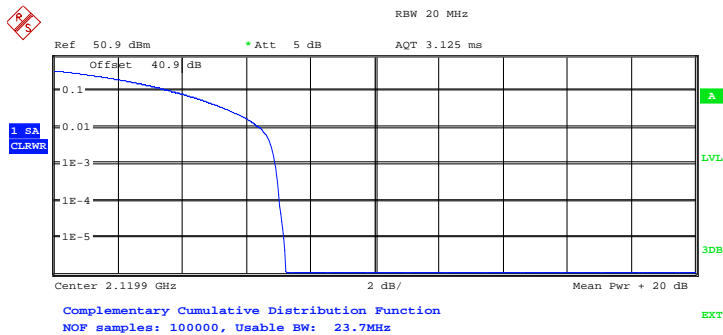

Trace 1

Mean	44.33 dBm
Peak	51.56 dBm
Crest	7.23 dB
10 %	3.72 dB
1 %	6.41 dB
.1 %	6.92 dB
.01 %	7.05 dB

Date: 25.JUL.2011 05:42:06



Product Service

Configuration 1 - Mode 10

TM1

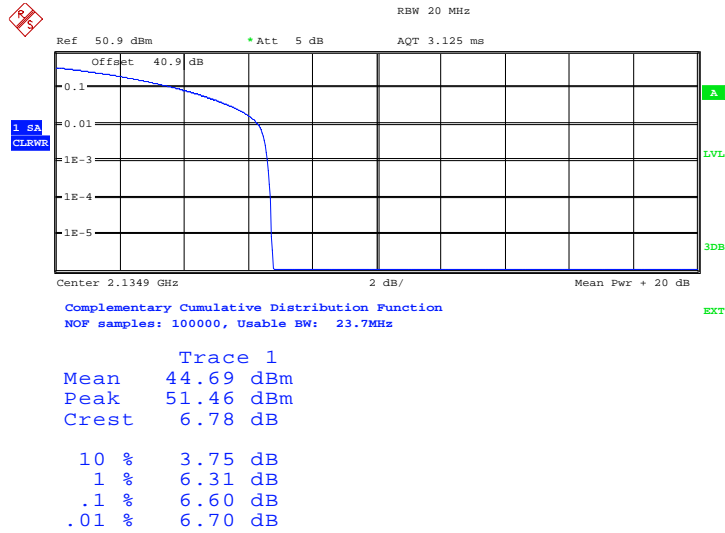

Date: 25.JUL.2011 01:36:55

TM5

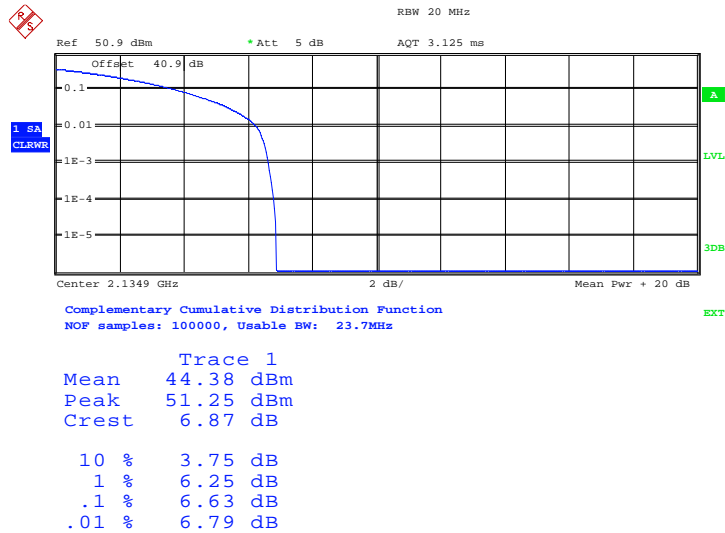

Date: 27.JUL.2011 04:43:26



Product Service

TM6

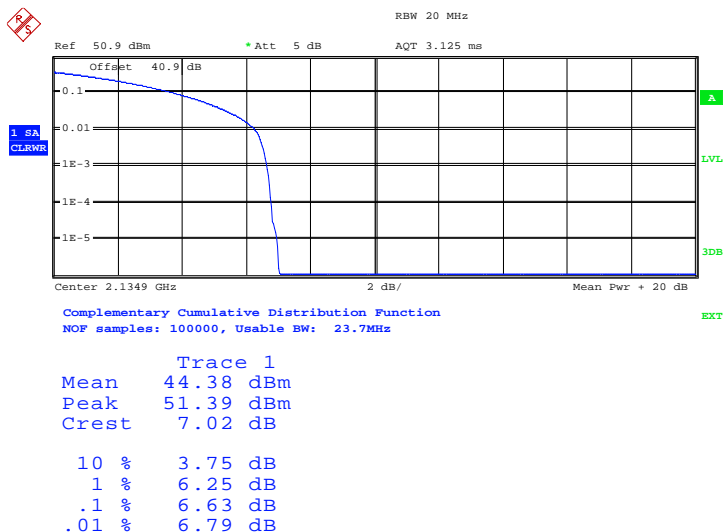

Date: 27.JUL.2011 04:43:02

Configuration 1 - Mode 11

TM1

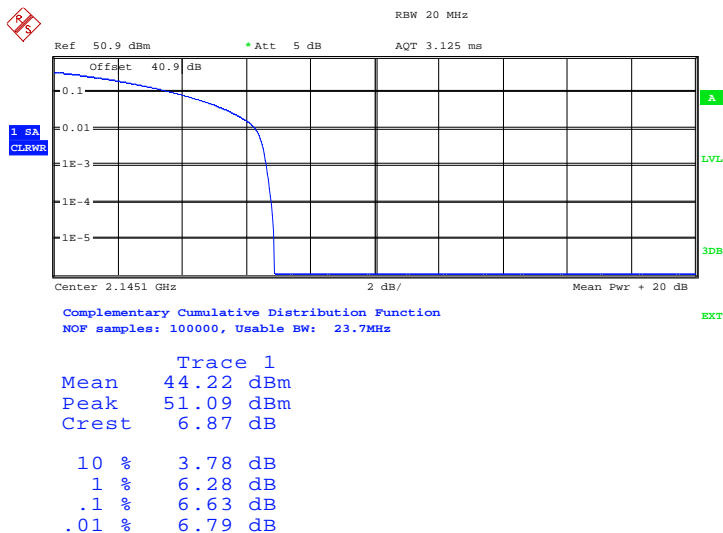

Date: 27.JUL.2011 03:23:23



Product Service

TM5

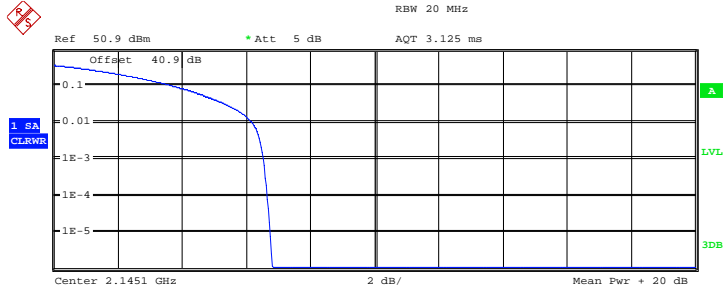

Center 2.1451 GHz 2 dB/ Mean Pwr + 20 dB
 Complementary Cumulative Distribution Function
 NOF samples: 100000, Usable BW: 23.7MHz

Trace 1
 Mean 44.29 dBm
 Peak 51.09 dBm
 Crest 6.80 dB
 10 % 3.75 dB
 1 % 6.19 dB
 .1 % 6.54 dB
 .01 % 6.67 dB

Date: 27.JUL.2011 03:35:27

TM6

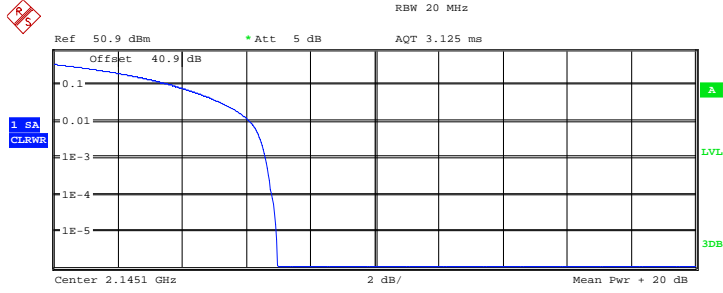

Center 2.1451 GHz 2 dB/ Mean Pwr + 20 dB
 Complementary Cumulative Distribution Function
 NOF samples: 100000, Usable BW: 23.7MHz

Trace 1
 Mean 44.41 dBm
 Peak 51.37 dBm
 Crest 6.97 dB
 10 % 3.72 dB
 1 % 6.12 dB
 .1 % 6.60 dB
 .01 % 6.79 dB

Date: 27.JUL.2011 03:51:31

Limit	13dB
-------	------

Remarks

The Peak – Average ratio does not exceed 13dB at the measured frequencies.



Product Service

2.3 MODULATION CHARACTERISTICS

2.3.1 Specification Reference

FCC CFR 47 Part 2, Clause 2.1047 (d)
Industry Canada RSS-139 Clause 6.2

2.3.2 Equipment Under Test

RRUS 11 B4 / KRC 161 254/1, S/N: CB4J379552

2.3.3 Date of Test and Modification State

21 July 2011 – Modification State 0

2.3.4 Test Method and Operating Modes

The test was applied in accordance with the test method requirements of FCC CFR 47 Part 2 and Industry Canada RSS-139.

Connect the TX output connector RF A to a spectrum analyzer with an attenuator. The other connector RF B was connected to match load. The EUT was controlled to transmit maximum power. Measure and record the constellation of the EUT by the spectrum analyzer.

The EUT supports QPSK, 16QAM and 32QAM modulations.

The test was performed with the EUT in the following configurations and modes of operation:

Configuration 1 - Mode 2

2.3.5 Environmental Conditions

	21 July 2011
Ambient Temperature	24.8°C
Relative Humidity	55.0%



Product Service

2.3.6 Test Result

Plots are shown on the following showing the EUT transmitting with all of the modulations:

The test results are shown below

Single Carrier

Configuration 1 - Mode 2

TM1: EUT transmitting with QPSK modulation:

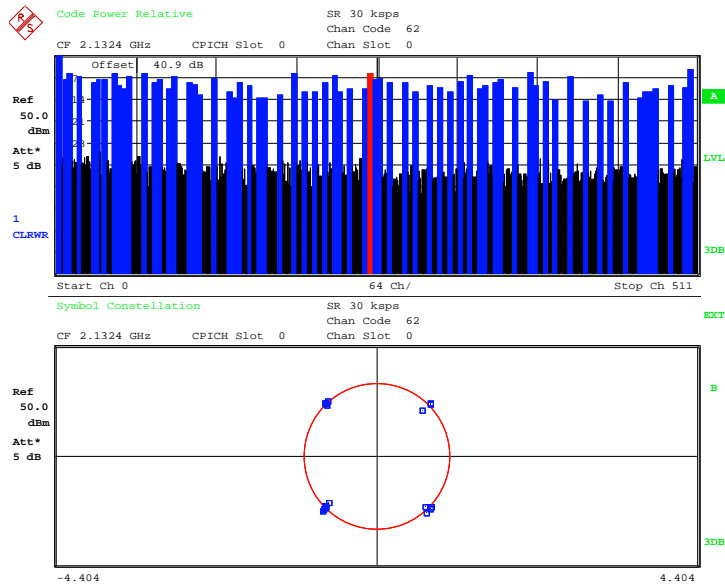

Date: 21.JUL.2011 02:48:52



Product Service

TM5: EUT transmitting with 16QAM modulation:

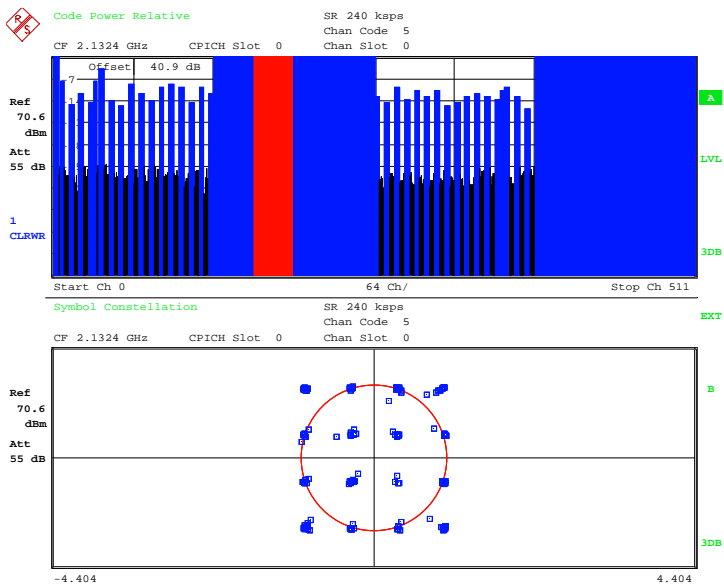

Date: 21.JUL.2011 07:16:26

TM6: EUT transmitting with 64QAM modulation:

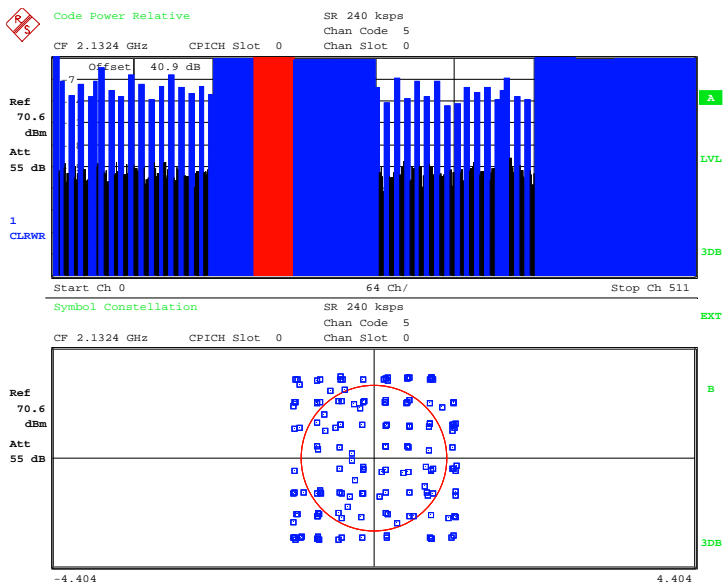

Date: 21.JUL.2011 07:26:56



Product Service

2.4 OCCUPIED BANDWIDTH

2.4.1 Specification Reference

FCC CFR 47 Part 2, Clause 2.1049
 FCC CFR 47 Part 27, Clause 27.53 (h)
 Industry Canada RSS-GEN, Clause 4.6.1

2.4.2 Equipment Under Test

RRUS 11 B4 / KRC 161 254/1, S/N: CB4J379552

2.4.3 Date of Test and Modification State

21 and 22 July 2011 – Modification State 0

2.4.4 Test Equipment Used

The major items of test equipment used for the above tests are identified in Section 3.1.

2.4.5 Test Method and Operating Modes

The test was applied in accordance with the test method requirements of FCC CFR 47 Part 2 and Part 27 and Industry Canada RSS-GEN.

The EUT was transmitting at maximum power, modulated using the test model described. Using a resolution bandwidth of 50kHz and a video bandwidth of 500kHz. The occupied bandwidth, that is the frequency bandwidth such that, below its lower and above its upper frequency limits, the mean powers radiated are each equal to 0.5 percent of the total mean power radiated by a given emission.

The test was performed with the EUT in the following configurations and modes of operation:

Configuration 1 - Mode 1
 - Mode 2
 - Mode 3

2.4.6 Environmental Conditions

	21 July 2011	22 July 2011
Ambient Temperature	24.8°C	25.0°C
Relative Humidity	55.0%	59.5%



Product Service

2.4.7 Test Results

For the period of test the EUT met the requirements of FCC CFR 47 Part 2 and Part 27 and Industry Canada RSS-GEN for Occupied Bandwidth.

The test results are shown below

Single Carrier: 4.2MHz Bandwidth

TM1

Configuration 1 - Mode 2

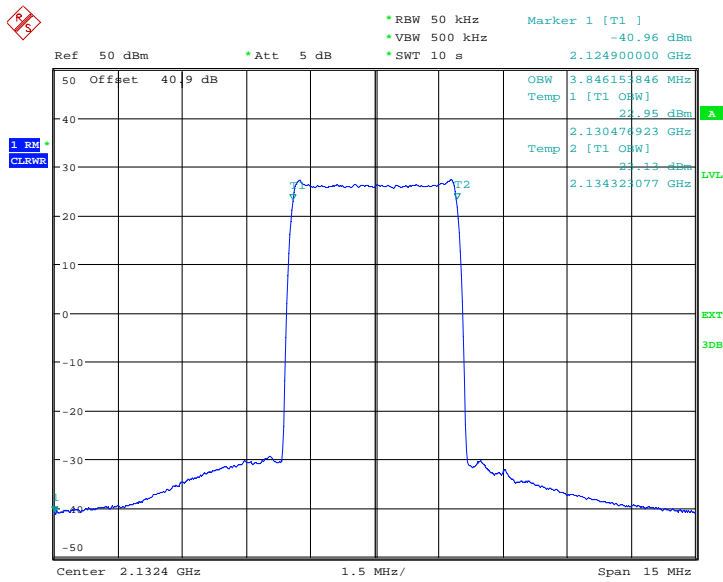

Date: 22.JUL.2011 01:36:09



Product Service

Single Carrier: 5MHz Bandwidth

TM1

Configuration 1 - Mode 1

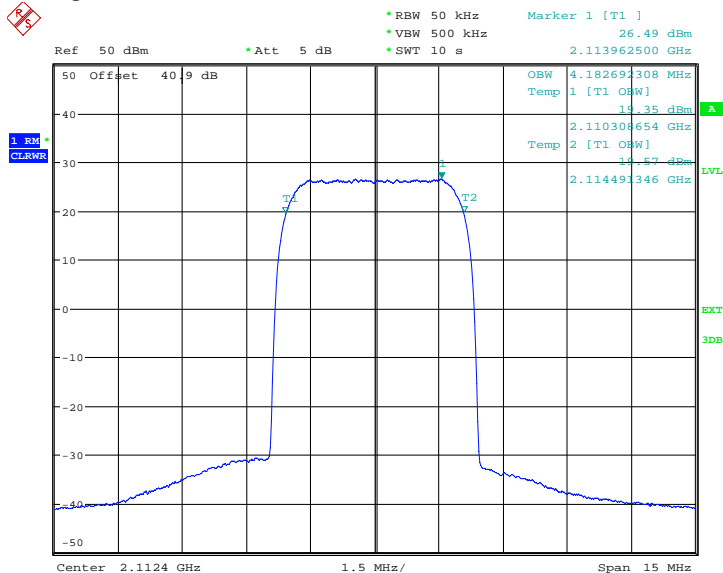

Date: 21.JUL.2011 01:52:56

Configuration 1 - Mode 2

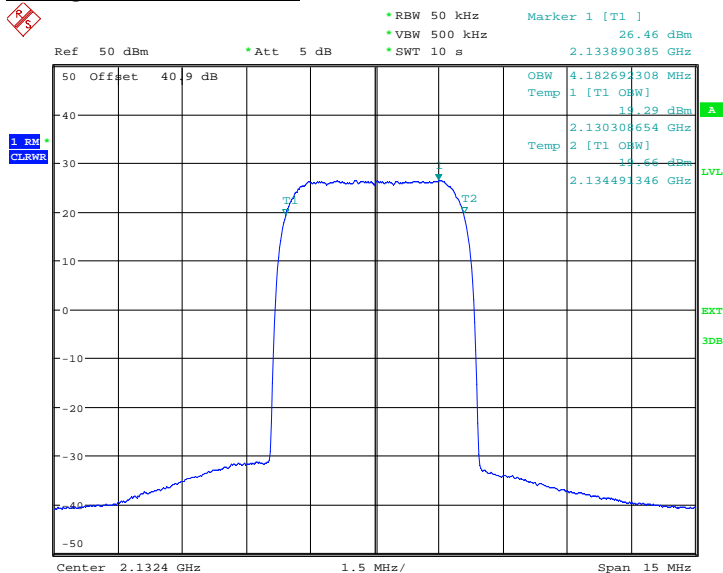

Date: 21.JUL.2011 02:45:29



Product Service

Configuration 1 - Mode 3

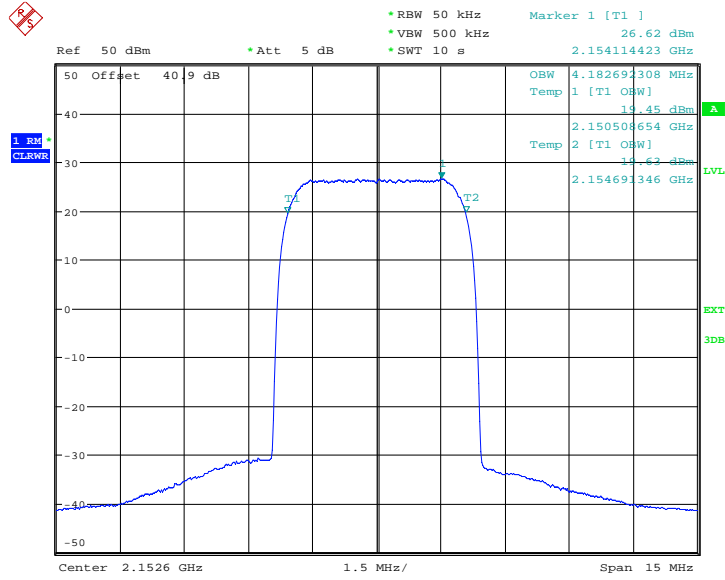

Date: 21.JUL.2011 04:55:38



2.5 SPURIOUS EMISSIONS AT ANTENNA TERMINALS (± 1 MHz)

2.5.1 Specification Reference

FCC CFR 47 Part 2, Clause 2.1051
 FCC CFR 47 Part 27, Clause 27.53 (h)
 Industry Canada RSS-139 Clause 6.5

2.5.2 Equipment Under Test

RRUS 11 B4 / KRC 161 254/1, S/N: CB4J379552

2.5.3 Date of Test and Modification State

21 and 26 July 2011 – Modification State 0

2.5.4 Test Equipment Used

The major items of test equipment used for the above tests are identified in Section 3.1.

2.5.5 Test Method and Operating Modes

The test was applied in accordance with the test method requirements of FCC CFR 47 Part 2 and Part 27 and Industry Canada RSS-139.

In accordance with 27.53(h)(1), at least 1% of the emission bandwidth was used for the resolution and video bandwidths up to 1MHz away from the block edge. For Single Carrier, a resolution bandwidth of 30kHz was used up to 1MHz away from the band edges. 30kHz is <1% of the Emission Bandwidth (4.33MHz between the 26dB points for 5MHz nominal BW setting). To compensate for the reduced measurement bandwidth, the limit was adjusted to -15dBm up to 1MHz away from the band edges. For Multi Carrier, a resolution bandwidth of 50kHz was used up to 1MHz away from the band edges. A resolution bandwidth of 50kHz was used between 1MHz to 5MHz away from the band edge. As the FCC rules specify a RBW of 1MHz for measurements of emissions > 1MHz away from the band edges, the limit was adjusted with -13dB to -26dBm to compensate for the reduced measurement bandwidth. Spectrum analyser detector was set as RMS.

The EUT was tested at its maximum power level. The path loss measured and entered as a reference level offset.

The test was performed with the EUT in the following configurations and modes of operation:

Configuration 1 - Mode 1
 - Mode 3
 - Mode 7
 - Mode 8

2.5.6 Environmental Conditions

	21 July 2011	24 July 2011
Ambient Temperature	24.8°C	24.0°C
Relative Humidity	55.0%	54.5%



2.5.7 Test Results

For the period of test the EUT met the requirements of FCC CFR 47 Part 2 and Part 27 and Industry Canada RSS-139 for Spurious Emissions Antenna Terminals (± 1 MHz)

Below are the Frequencies the EUT was tested against along with the tested channels.

TM1

Single Carrier

Configuration 1 - Mode 1 and 3

Band Edge Frequency	Edge Test with QPSK modulation Channel No./Frequencies
Bottom 2110 MHz	Channel: 1537 Frequency: 2112.4 MHz
Top 2155 MHz	Channel: 1738 Frequency: 2152.6 MHz

Multi Carrier (1x2)

Configuration 1 - Mode 7 and 8

Band Edge Frequency	Edge Test with QPSK modulation Channel No./Frequencies
Bottom 2110 MHz	Channel: 1537 & 1562 Frequency: 2112.4 & 2117.4 MHz
Top 2155 MHz	Channel: 1713 & 1738 Frequency: 2147.6 & 2152.6 MHz

The channels shown in the table above are the minimum and maximum channels that can be used in the authorised frequency ranges to maintain compliance.



Product Service

The test results are shown below

TM1

Single Carrier

Configuration 1 - Mode 1

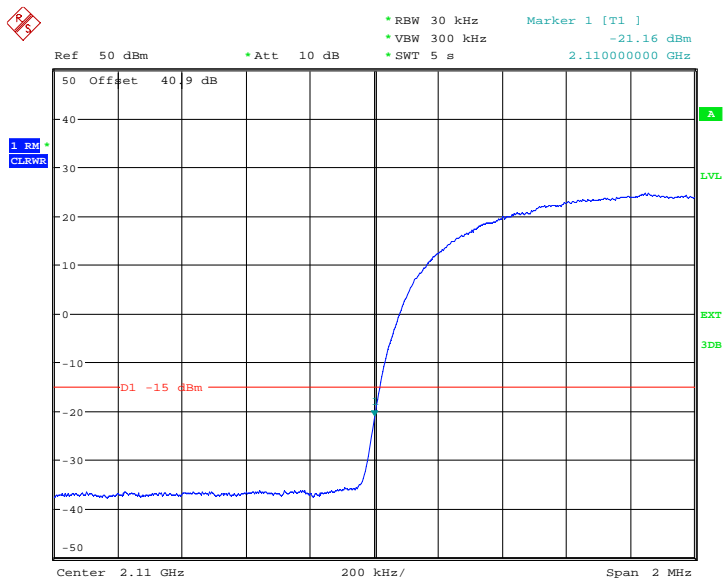

Date: 21.JUL.2011 02:23:35

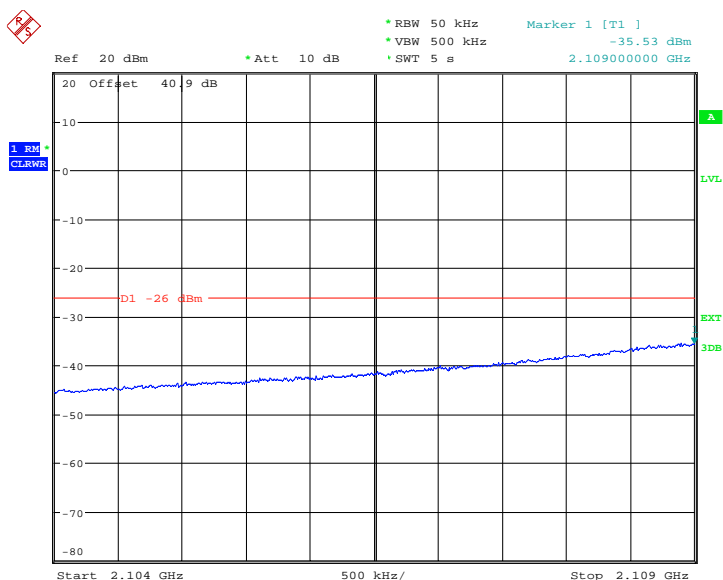

Date: 21.JUL.2011 02:24:36



Product Service

Configuration 1 - Mode 3

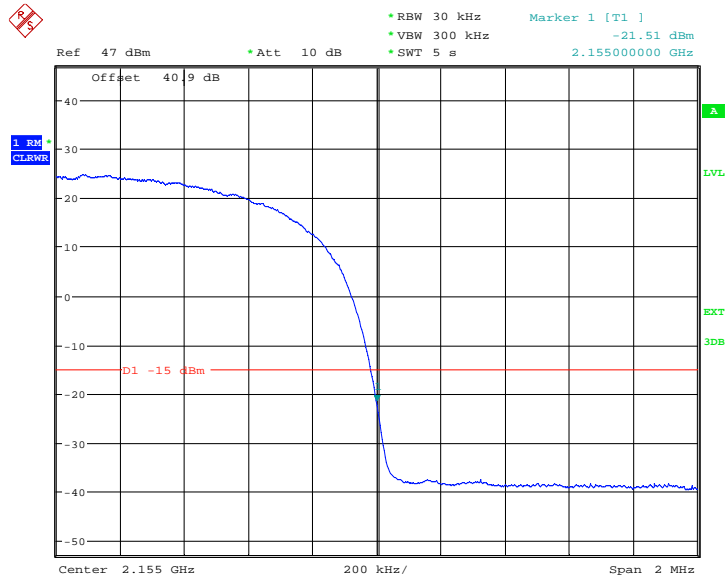

Date: 21.JUL.2011 05:04:05

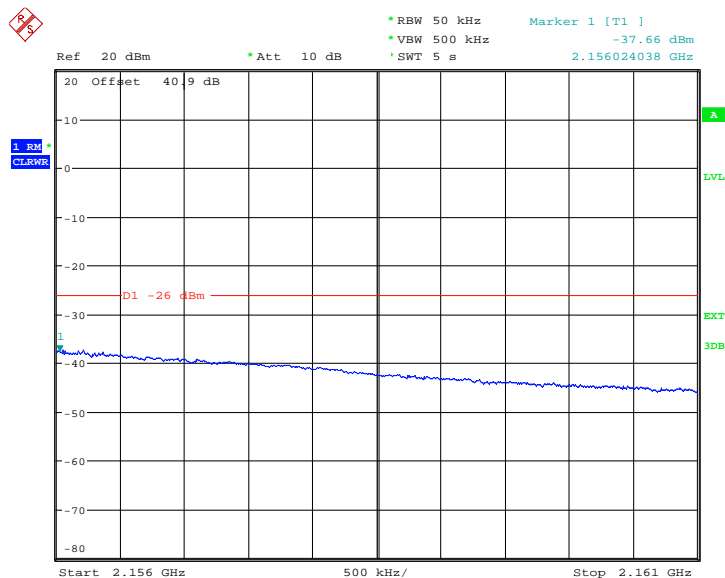

Date: 21.JUL.2011 05:08:22



Product Service

Multi Carrier (1x2)

Configuration 1 - Mode 7

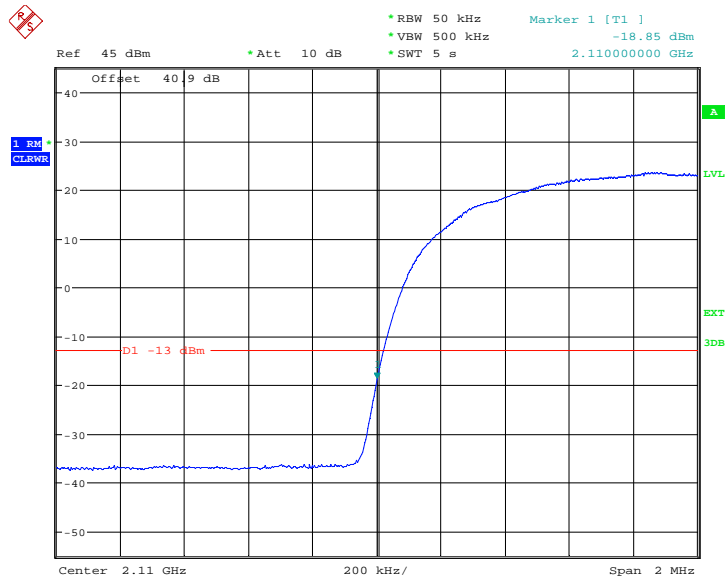

Date: 26.JUL.2011 01:20:26

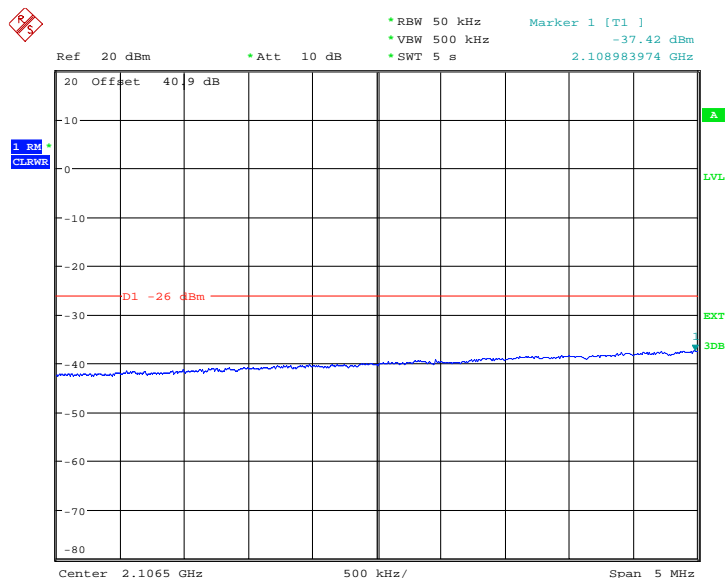

Date: 26.JUL.2011 01:17:57



Product Service

Configuration 1 - Mode 8

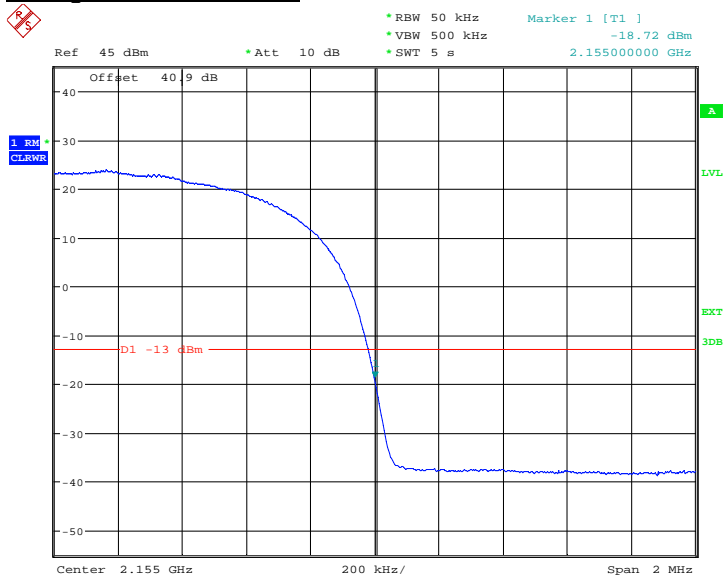

Date: 26.JUL.2011 02:56:01

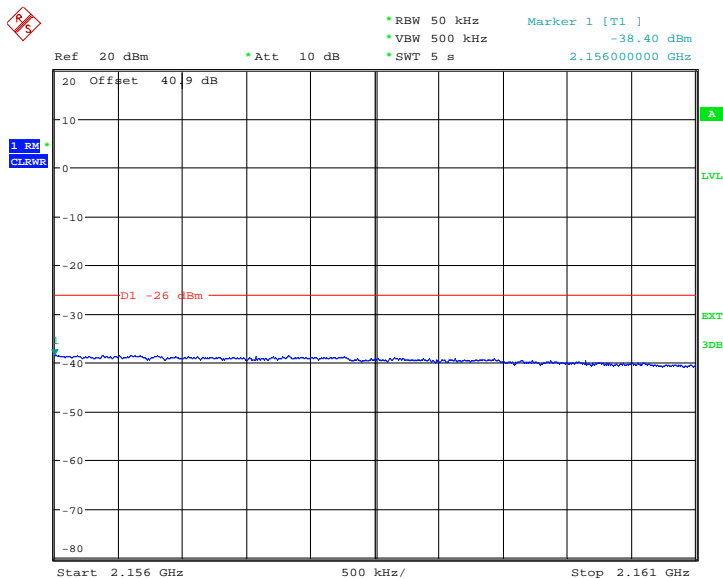

Date: 26.JUL.2011 02:56:46

Limit

The power of any emission outside the frequency band shall be attenuated below the transmitter power (P) by at least $43 + 10\log P$ dB.



2.6 RADIATED SPURIOUS EMISSIONS

2.6.1 Specification Reference

FCC CFR 47 Part 2, Clause 2.1053
FCC CFR 47 Part 27, Clause 27.53 (h)
Industry Canada RSS-139, Clause 6.5

2.6.2 Equipment Under Test

RRUS 11 B4 / KRC 161 254/1, S/N: CB4J379552

2.6.3 Date of Test and Modification State

2 and 3 August 2011 – Modification State 0

2.6.4 Test Equipment Used

The major items of test equipment used for the above tests are identified in Section 3.1.

2.6.5 Test Method and Operating Modes

The test was applied in accordance with the test method requirements of FCC CFR 47 Part 2 and Part 27 and Industry Canada RSS-139.

A preliminary profile of the Spurious Radiated Emissions was obtained by operating the EUT on a remotely controlled turntable within the chamber. Measurements of emissions from the EUT were obtained with the Measurement Antenna in both Horizontal and Vertical Polarizations.

Emissions identified within the range 30MHz – 25GHz were then formally measured using a Peak detector as the worst case.

In the frequency Range 30MHz – 25GHz, the measurement was performed with a resolution bandwidth of 1MHz.

The measurements were performed at a 3m distance unless otherwise stated.

The limits for Spurious Emissions have been calculated, as shown below using the following formula:

Field Strength of Carrier - $(43 + 10\text{Log}(P))$ dB

Where:

Field Strength is measured in dB μ V/m

P is measured Transmitter Power in Watts



Determination of Spurious Emission Limit

As the EUT does not have an integral antenna, the field strength of the carrier has been calculated assuming that the power is to be fed to a half-wave tuned dipoles as per 2.1053 (a).

$$E_{(v/m)} = (30 \times G_i \times P_o)^{0.5} / d$$

Where G_i is the antenna gain of ideal half-wave dipoles,
 P_o is the power out of the transceiver in W,
 d is the measurement distance in meter.

Therefore at 3m measurement distance the field strength using the lowest transceiver output power would be:

$$E_{(v/m)} = (30 \times 1.64 \times 26.49)^{0.5} / 3 = 12.034V/m = 141.6dB\mu V/m$$

As per 27.53(h) the spurious emission must be attenuated by $43 + 10\log(P_o)$ dB this gives:

$$43 + 10\log(26.49) = 57.2dB$$

Therefore the limit at 3m measurement distance is:

$$141.6 - 57.2 = 84.4 \text{ dB}\mu V/m$$

This limit has been used to determine Pass or Fail for the harmonics measured and detailed in the following results.

The test was performed with the EUT in the following configurations and modes of operation:

- Configuration 1 - Mode 1
 - Mode 2
 - Mode 3
 - Mode 5
 - Mode 10

2.6.6 Environmental Conditions

	2 August 2011	3 August 2011
Ambient Temperature	27.0°C	25.2°C
Relative Humidity	51.7%	48.2%



2.6.7 Test Results

For the period of test the EUT met the requirements of FCC CFR 47 Part 2 & Part 27 and Industry Canada RSS-139 for Radiated Spurious Emissions.

The test results are shown below

Note: Only the worst case results plots have been included as all of the emissions are greater than 20dB below the limit. A set of plots have been included to show the measurement system noise floor

Single Carrier

TM1

Configuration 1 - Mode 1

No emissions were detected within 20dB of the limit.

Configuration 1 - Mode 2

30MHz to 1GHz

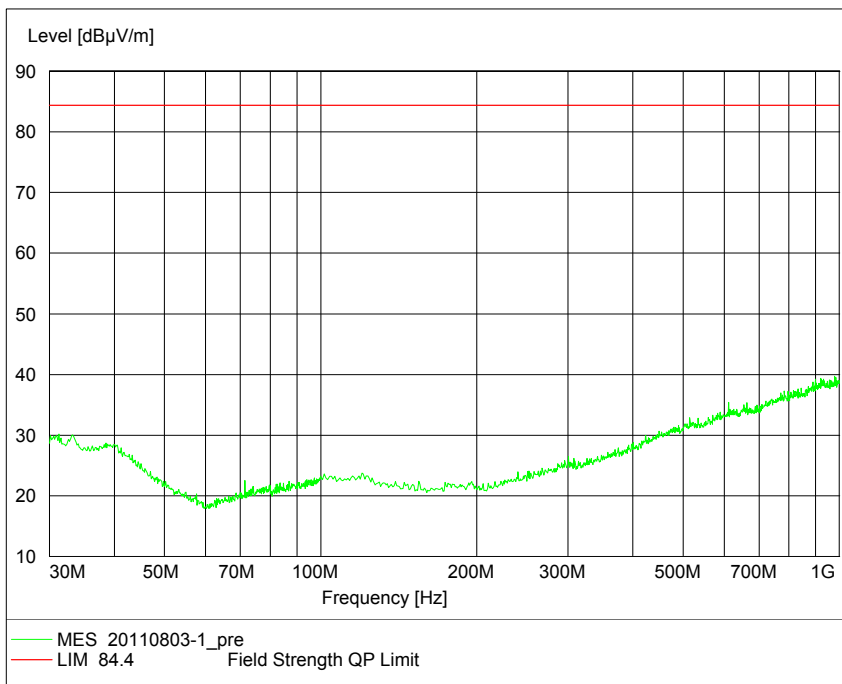



Product Service

1GHz to 18GHz

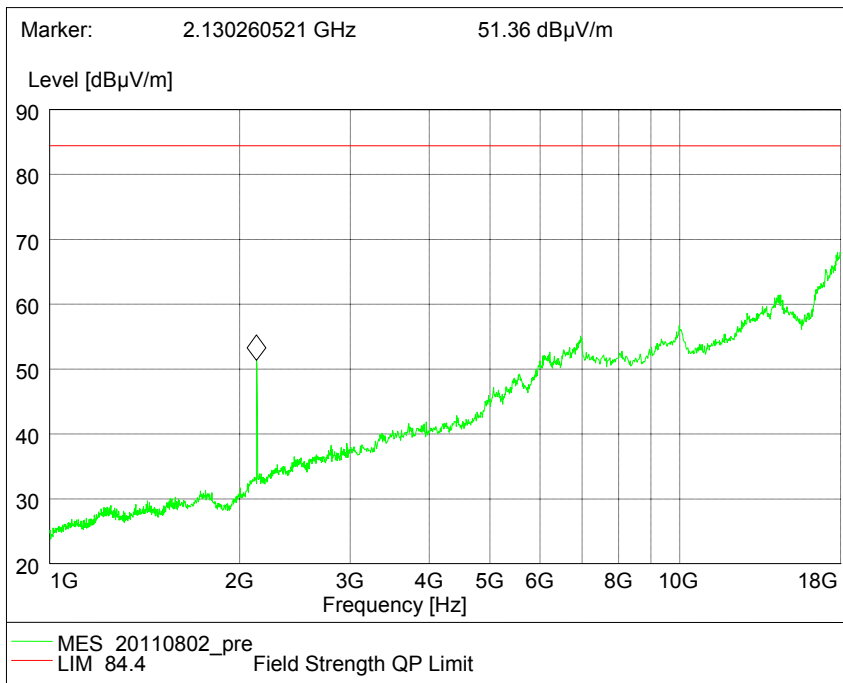

Note: The emission marked is the operating frequency.

18GHz to 25GHz

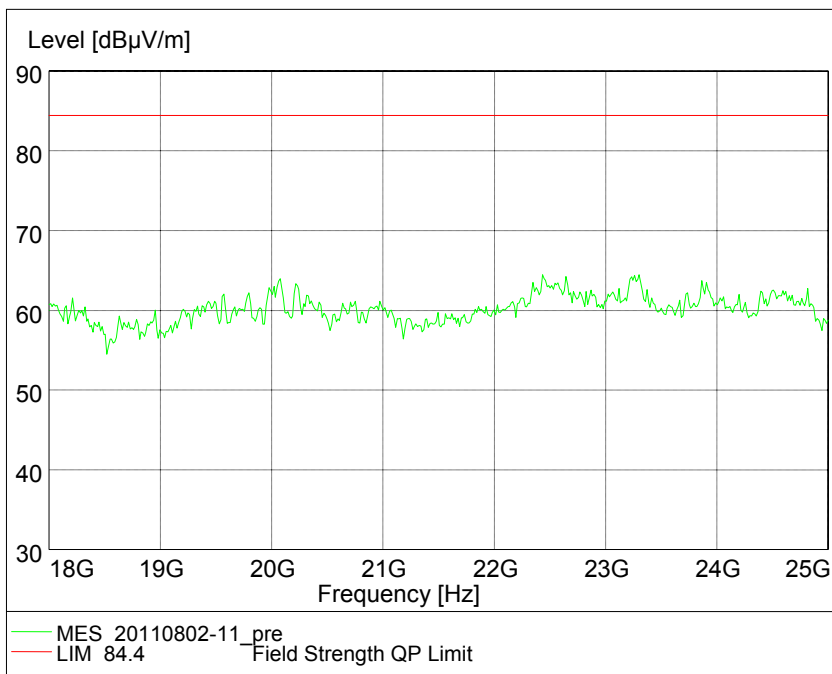



Configuration 1 - Mode 3

No emissions were detected within 20dB of the limit.

TM5

Configuration 1 - Mode 2

No emissions were detected within 20dB of the limit.

TM6

Configuration 1 - Mode 2

No emissions were detected within 20dB of the limit.

Multi Carrier (1x2)

TM1

Configuration 1 - Mode 5

No emissions were detected within 20dB of the limit.

Multi Carrier (1x4)

TM1

Configuration 1 - Mode 10

No emissions were detected within 20dB of the limit.

Limit	-13dBm / 84.4dBµV/m
-------	---------------------

Remarks

The EUT does not exceed -13dBm / 84.4dBµV/m at the measured frequencies.



Product Service

2.7 CONDUCTED SPURIOUS EMISSIONS

2.7.1 Specification Reference

FCC CFR 47 Part 2, Clause 2.1051
 FCC CFR 47 Part 27, Clause 27.53 (h)
 Industry Canada RSS-139, Clause 6.5

2.7.2 Equipment Under Test

RRUS 11 B4 / KRC 161 254/1, S/N: CB4J379552

2.7.3 Date of Test and Modification State

21, 22 and 26 July 2011 – Modification State 0

2.7.4 Test Equipment Used

The major items of test equipment used for the above tests are identified in Section 3.1.

2.7.5 Test Method and Operating Modes

The test was applied in accordance with the test method requirements of FCC CFR 47 Part 2 and Part 27 and Industry Canada RSS-139.

In accordance with Part 2.1051, the spurious emissions from the antenna terminal were measured. The transmitter output power was attenuated using an attenuator and the frequency spectrum investigated from 9kHz to 25GHz. The EUT was set to transmit on maximum power. The EUT was tested on Bottom, Middle and Top channels for QPSK, 16QAM and 64QAM modulation types. The resolution was set to 1MHz for 9kHz to 25GHz thus meeting the requirements of Part 27.53(h)(1). The spectrum analyser detector was set to peak and trace was kept on Max Hold.

The maximum path loss across the measurement band was used as the reference level offset to ensure worst case.

In addition, measurements were made up to the 10th harmonic of the highest internal frequency.

The test was performed with the EUT in the following configurations and modes of operation:

Configuration 1 - Mode 1
 - Mode 2
 - Mode 3
 - Mode 4
 - Mode 5
 - Mode 6

2.7.6 Environmental Conditions

	21 July 2011	22 July 2011	26 July 2011
Ambient Temperature	24.8°C	25.0°C	24.0°C
Relative Humidity	55.0%	59.5%	54.5%



Product Service

2.7.7 Test Results

For the period of test the EUT met the requirements of FCC CFR 47 Part 2 and Part 27 and Industry Canada RSS-139 for Conducted Spurious Emissions.

The test results are shown below

Remark:

The emissions at 9kHz on the plots was not generated by the test object. A complementary measurement with a smaller Span showed that it was related to the LO feedthrough

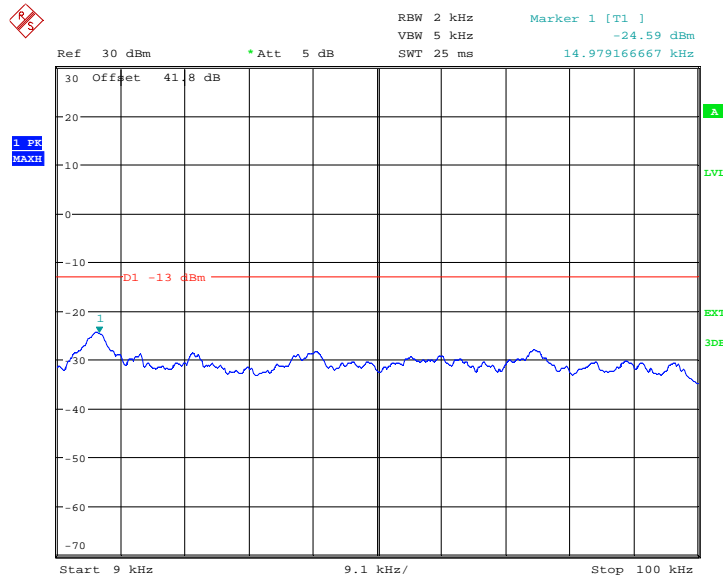

Date: 21.JUL.2011 02:56:55



Product Service

TM1

Single Carrier

Configuration - Mode 1

9kHz to 3GHz

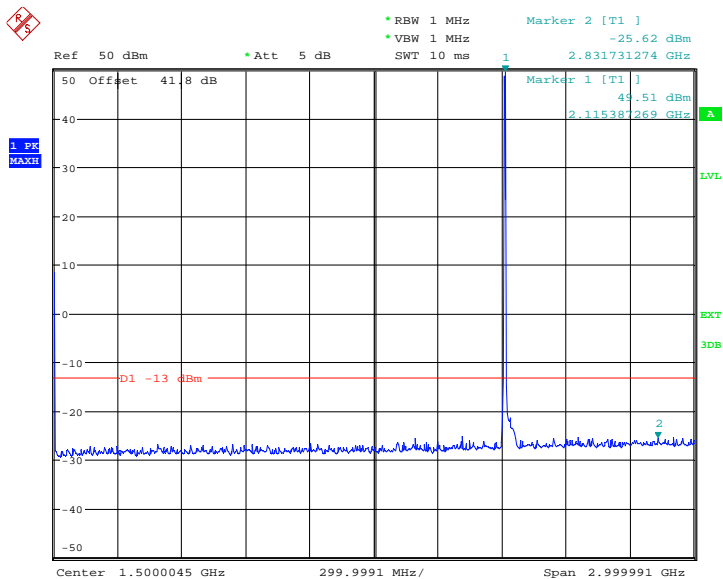

Date: 21.JUL.2011 02:00:33

Note: The emission beyond the limit is the operating frequency.

3GHz to 25GHz

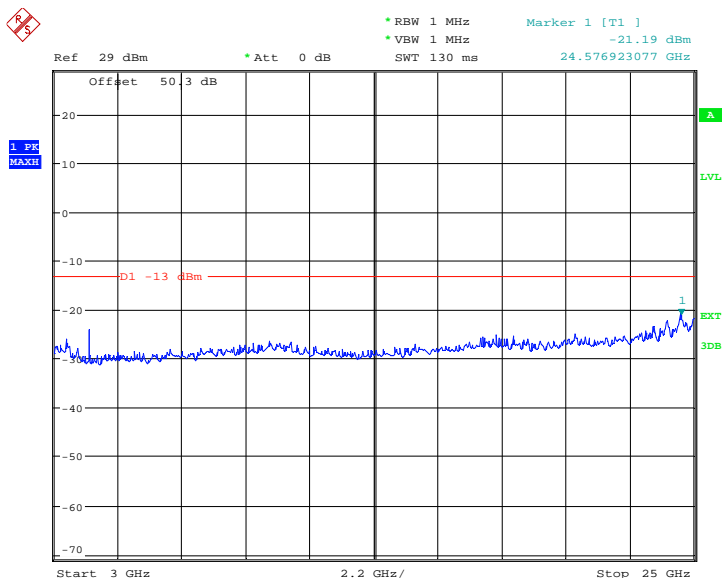

Date: 21.JUL.2011 02:09:15



Product Service

Configuration 1 - Mode 2

9kHz to 3GHz

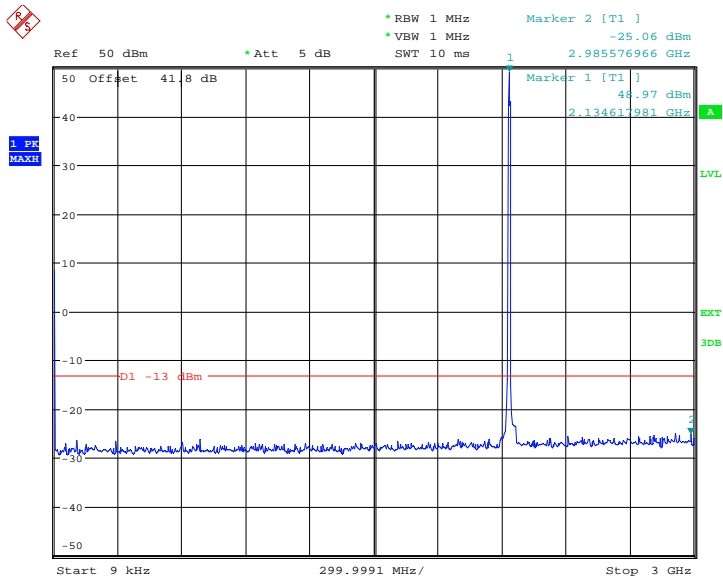

Date: 21.JUL.2011 02:55:48

Note: The emission beyond the limit is the operating frequency.

3GHz to 25GHz

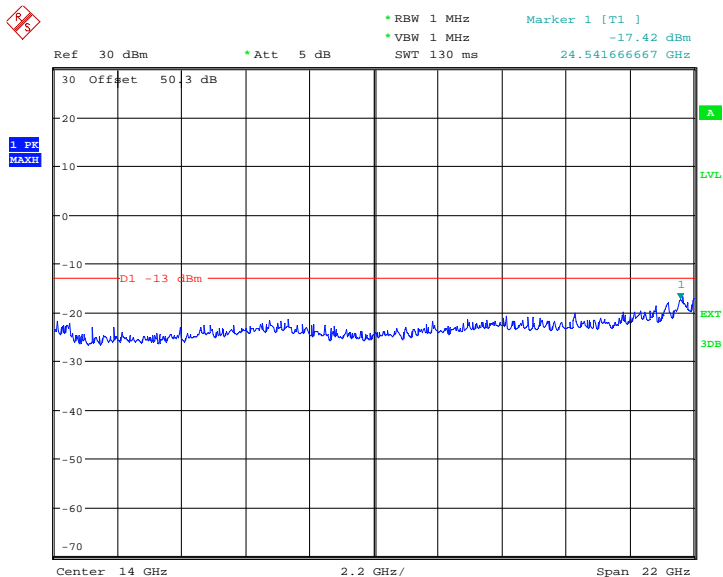

Date: 21.JUL.2011 05:24:09



Product Service

Configuration 1 - Mode 3

9kHz to 3GHz

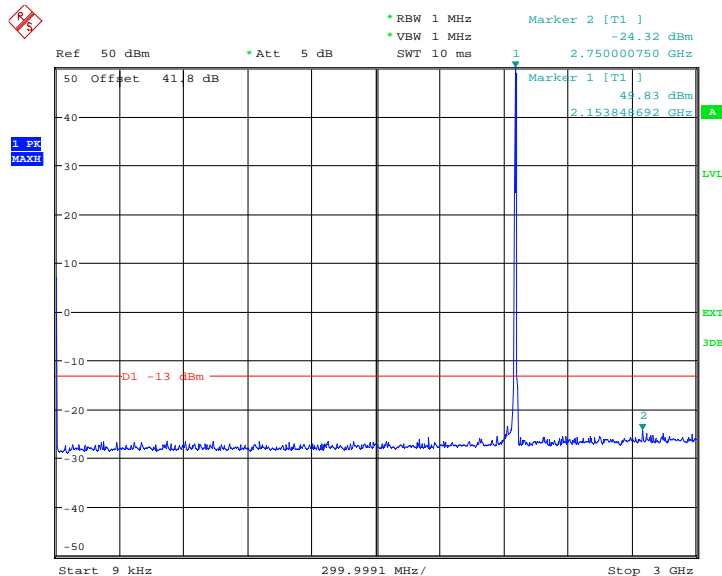

Date: 21.JUL.2011 05:12:38

Note: The emission beyond the limit is the operating frequency.

3GHz to 25GHz

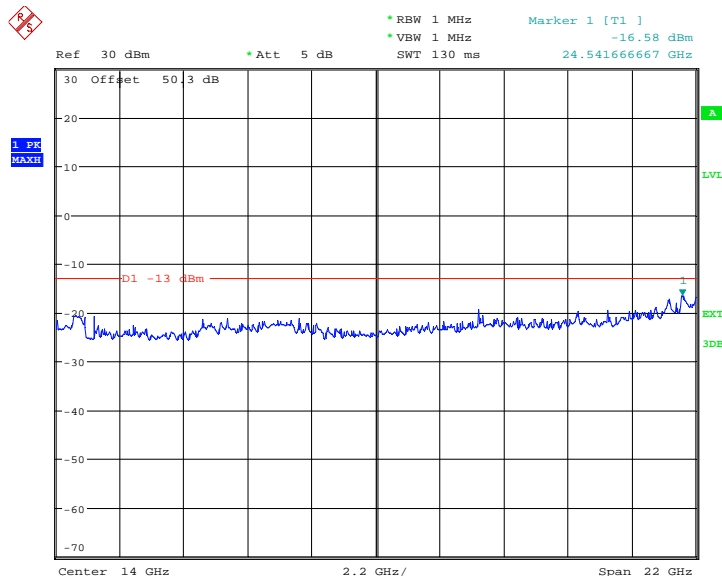

Date: 21.JUL.2011 05:17:52



Product Service

Multi Carrier (1x2)

Configuration 1 - Mode 4

9kHz to 3GHz

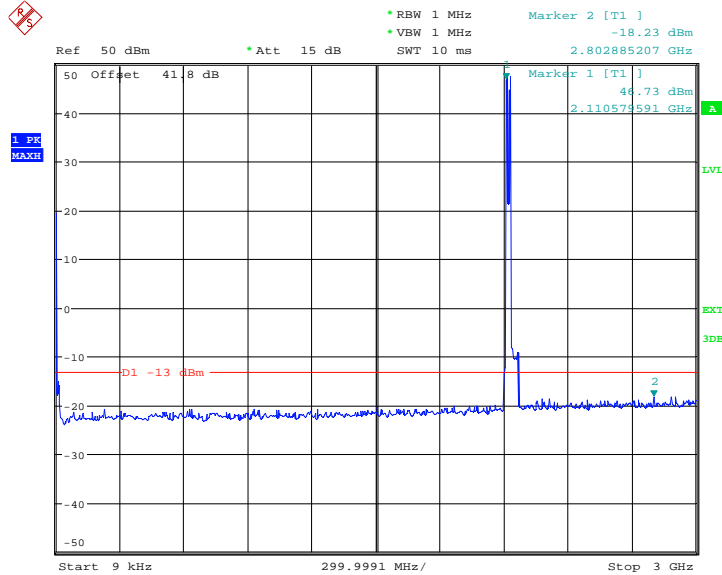

Date: 26.JUL.2011 05:12:06

Note: The emissions beyond the limit are the operating frequencies.

3GHz to 25GHz

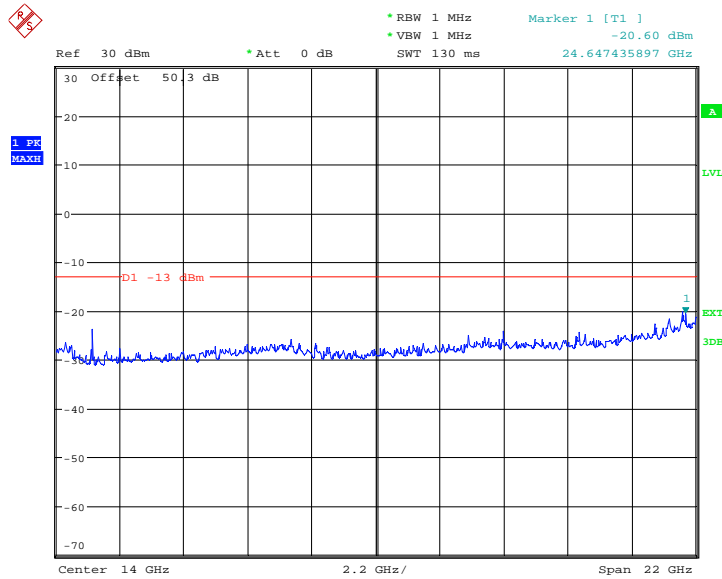

Date: 26.JUL.2011 05:13:38



Product Service

Configuration 1 - Mode 5

9kHz to 3GHz

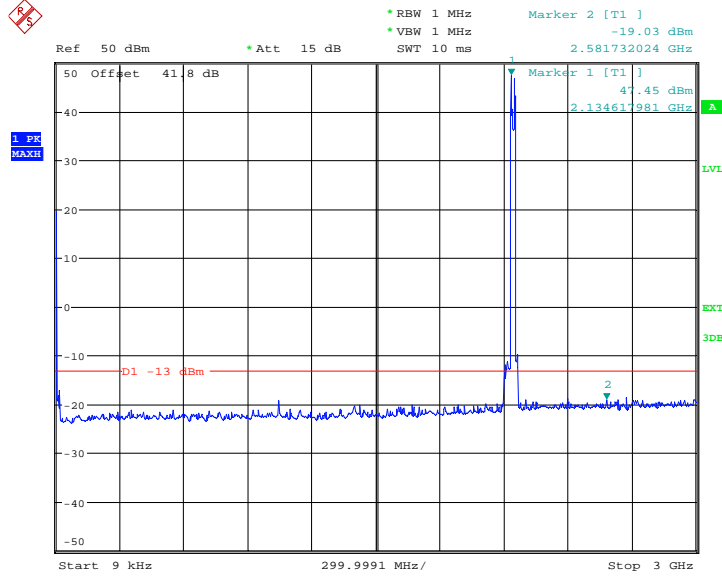

Date: 22.JUL.2011 03:18:44

Note: The emissions beyond the limit are the operating frequencies.

3GHz to 25GHz

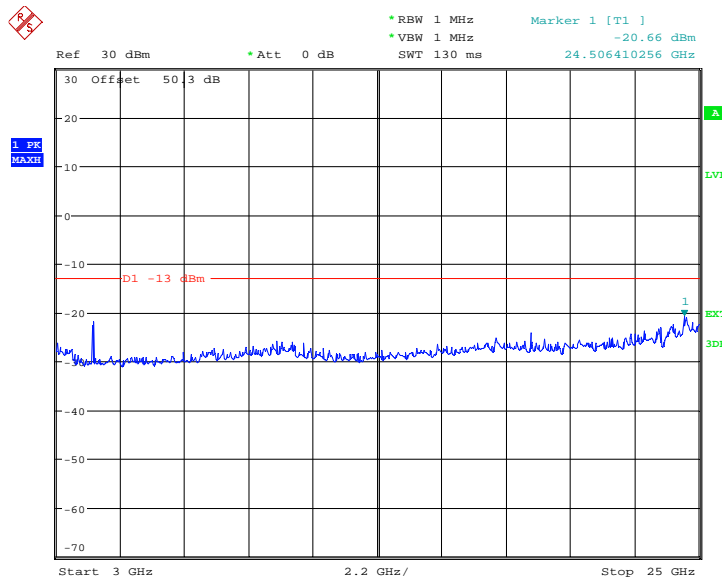

Date: 22.JUL.2011 03:21:02



Product Service

Configuration 1 - Mode 6

9kHz to 3GHz

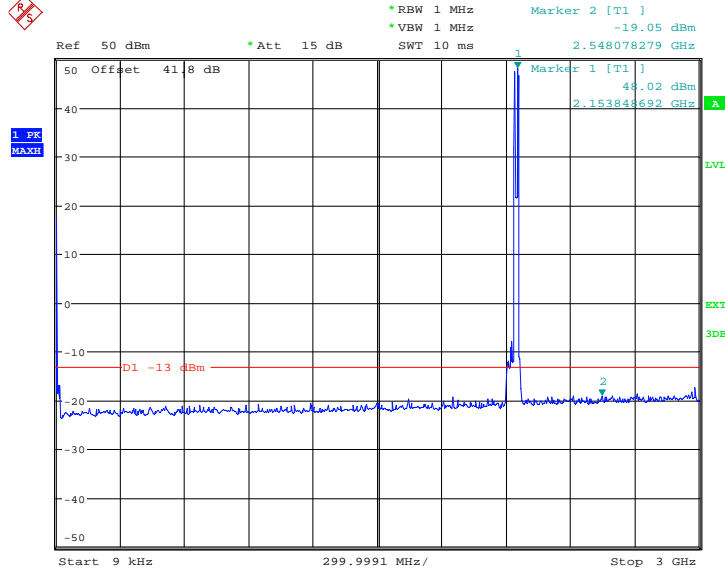

Date: 22.JUL.2011 04:44:50

Note: The emissions beyond the limit are the operating frequencies.

3GHz to 25GHz

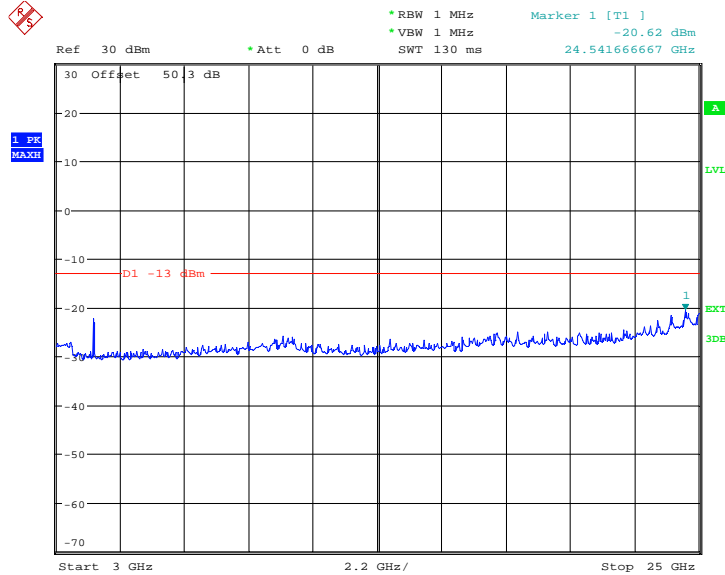

Date: 22.JUL.2011 04:42:11

Limit	-13dBm
-------	--------

Remarks

The EUT does not exceed -13dBm at the frequency range of 9kHz to 25GHz.



Product Service

2.8 FREQUENCY STABILITY UNDER TEMPERATURE VARIATIONS

2.8.1 Specification Reference

FCC CFR 47 Part 2, Clause 2.1055
FCC CFR 47 Part 27, Clause 27.54
Industry Canada RSS-139, Clause 6.3

2.8.2 Equipment Under Test

RRUS 11 B4 / KRC 161 254/1, S/N: CB4J379552

2.8.3 Date of Test and Modification State

27 July 2011 – Modification State 0

2.8.4 Test Equipment Used

The major items of test equipment used for the above tests are identified in Section 3.1.

2.8.5 Test Method and Operating Modes

The test was applied in accordance with the test method requirements of FCC CFR 47 Part 2 and Part 27 and Industry Canada RSS-139.

The EUT was set to transmit on maximum power. A Spectrum Analyser was used to measure the frequency error. The temperature was adjusted between -30°C and +50°C in 10° steps as per 2.1055.

The test was performed with the EUT in the following configurations and modes of operation:

Configuration 1 - Mode 2

2.8.6 Environmental Conditions

	27 July 2011
Ambient Temperature	23.5°C
Relative Humidity	56.0%



Product Service

2.8.7 Test Results

For the period of test the EUT met the requirements of FCC CFR 47 Part 2 and Part 27 and Industry Canada RSS-139 for Frequency Stability Under Temperature Variations.

The test results are shown below

Power Supply: -48V DC

Single Carrier

TM1

Configuration 1 - Mode 2

Temperature Interval (°C)	Deviation (Hz)
-30	-12.07
-20	7.74
-10	-9.56
0	-13.14
+10	-11.70
+20	-19.35
+30	-19.95
+40	-8.27
+50	-6.83

Limit	$\pm (0.05 \text{ ppm} + 12 \text{ Hz})$ or $\pm 118.63 \text{ Hz}^*$
-------	---

Remarks

* Limit according to 3GPP TS 36.141 V9.5.0.

The frequency stability of the EUT is sufficient to keep it within the authorised frequency ranges at any temperature interval across the measured range.



Product Service

2.9 FREQUENCY STABILITY UNDER VOLTAGE VARIATIONS

2.9.1 Specification Reference

FCC CFR 47 Part 2, Clause 2.1055
 FCC CFR 47 Part 27, Clause 27.54
 Industry Canada RSS-139, Clause 6.3

2.9.2 Equipment Under Test

RRUS 11 B4 / KRC 161 254/1, S/N: CB4J379552

2.9.3 Date of Test and Modification State

27 July 2011 – Modification State 0

2.9.4 Test Equipment Used

The major items of test equipment used for the above tests are identified in Section 3.1.

2.9.5 Test Method and Operating Modes

The test was applied in accordance with the test method requirements of FCC CFR 47 Part 2 and Part 27 and Industry Canada RSS-139.

The EUT was set to transmit on maximum power. A Spectrum Analyser was used to measure the frequency error. The supplied voltage was varied from 85 to 115 percent of the nominal value.

The test was performed with the EUT in the following configurations and modes of operation:

Configuration 1 - Mode 2

2.9.6 Environmental Conditions

	27 July 2011
Ambient Temperature	23.5°C
Relative Humidity	56.0%



2.9.7 Test Results

For the period of test the EUT met the requirements of FCC CFR 47 Part 2 and Part 27 and Industry Canada RSS-139 for Frequency Stability Under Voltage Variations.

The test results are shown below

Temperature: 20°C

Single Carrier

TM1

Configuration 1 - Mode 2

DC Voltage (V)	Deviation (Hz)
-40.8	-19.01
-48.0	-19.35
-55.2	-17.86

Limit	$\pm (0.05 \text{ ppm} + 12 \text{ Hz})$ or $\pm 118.63 \text{ Hz}^*$
-------	---

Remarks

* Limit according to 3GPP TS 36.141 V9.5.0.

The frequency stability of the EUT is sufficient to keep it within the authorised frequency ranges under voltage variations across the measured range.



Product Service

2.10 RECEIVER SPURIOUS EMISSIONS

2.10.1 Specification Reference

Industry Canada RSS-139, Clause 6.6

2.10.2 Equipment Under Test

RRUS 11 B4 / KRC 161 254/1, S/N: CB4J379552

2.10.3 Date of Test and Modification State

26 July 2011 – Modification State 0

2.10.4 Test Equipment Used

The major items of test equipment used for the above tests are identified in Section 3.1.

2.10.5 Test Method and Operating Modes

The test was applied in accordance with the test method requirements of Industry Canada RSS-139.

In accordance with RSS-Gen Clause 6(b), the receiver spurious emissions from the antenna terminal were measured. Measurements were performed on the receiver antenna connector RF B. The EUT was set to transmitter mode on the TX connector RF A and during the measurement the RF A was terminated with match load, (50 Ohm).

The resolution was set to 1MHz in the frequency range 9kHz to 13GHz thus meeting the requirements of RSS-Gen Clause 6(b), the spectrum analyser detector was set to peak and trace was kept on Max Hold to give the worst case. The limit line was displayed, showing the -57dBm, 2 nanowatts in band 9kHz to 1GHz and above 1GHz, -53dBm, 5 nanowatts.

The maximum path loss across the measurement band was used as the reference level offset to ensure worst case.

In addition, measurements were made from 9kHz up to the 5th harmonic of the highest internal frequency.

The test was performed with the EUT in the following configurations and modes of operation as the worst cases:

Configuration 1 - Mode 1
 - Mode 2
 - Mode 3

2.10.6 Environmental Conditions

	26 July 2011
Ambient Temperature	24.0°C
Relative Humidity	54.5%



Product Service

2.10.7 Test Results

For the period of test the EUT met the requirements of Industry Canada RSS-139 for Receiver Spurious Emissions.

The test results are shown below

Remark:

The emissions at 9kHz on the plots was not generated by the test object. A complementary measurement with a smaller Span showed that it was related to the LO feedthrough.

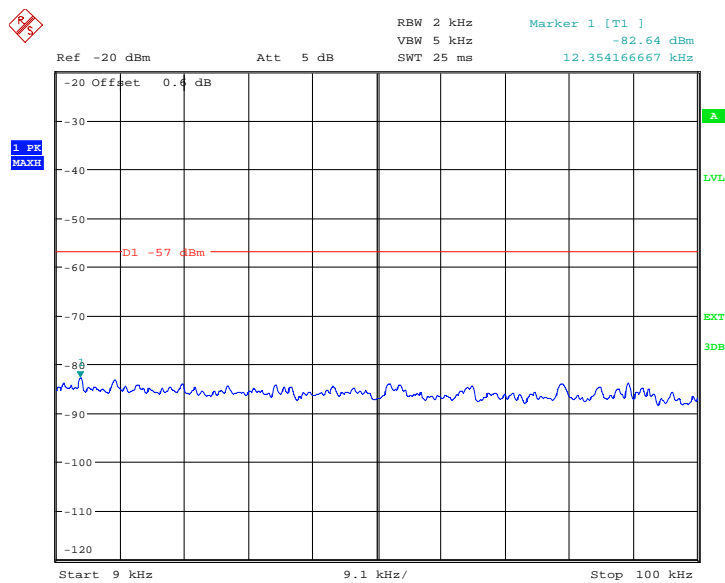

Date: 26.JUL.2011 03:43:52



Product Service

TM1

Single Carrier

Configuration 1 - Mode 1

9kHz to 1GHz

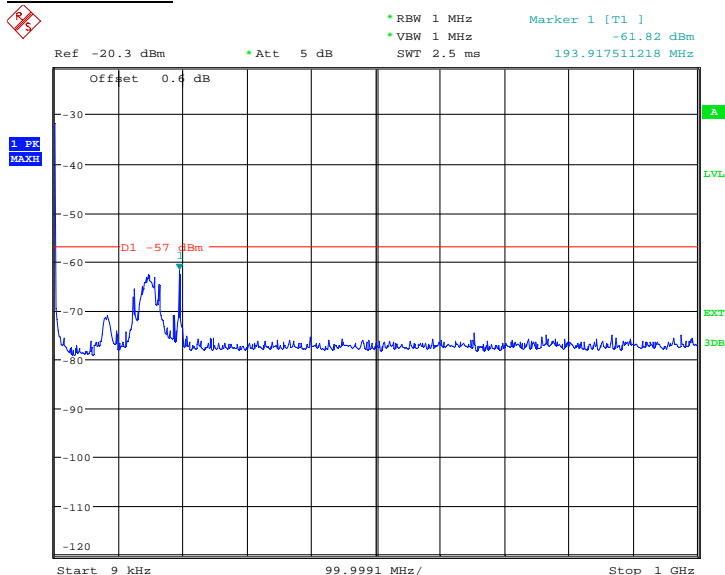

Date: 26.JUL.2011 03:26:37

1GHz to 13GHz

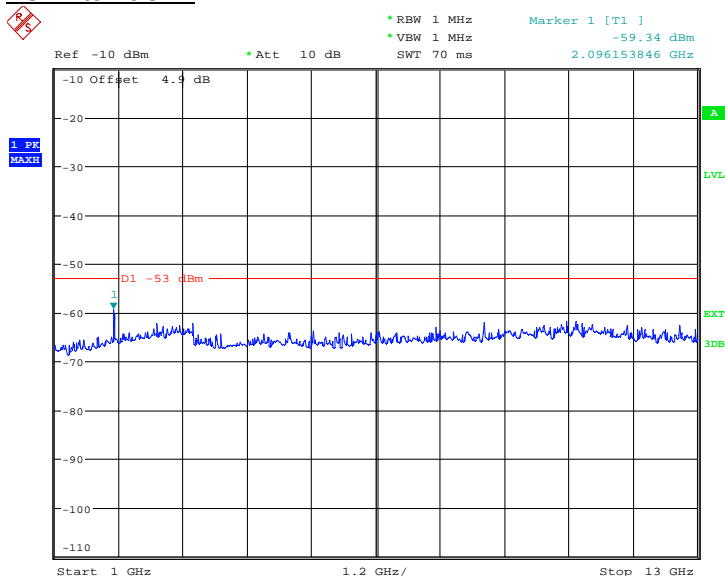

Date: 26.JUL.2011 03:29:05



Configuration 1 - Mode 2

9kHz to 1GHz

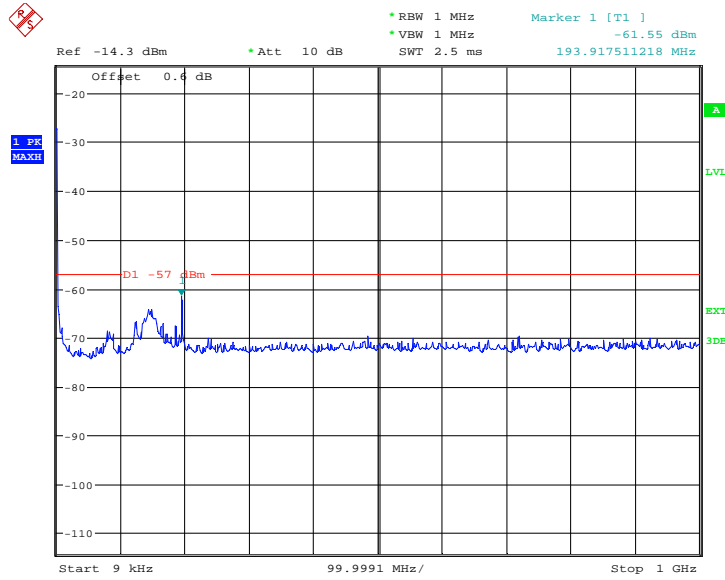

Date: 26.JUL.2011 03:41:36

1GHz to 13GHz

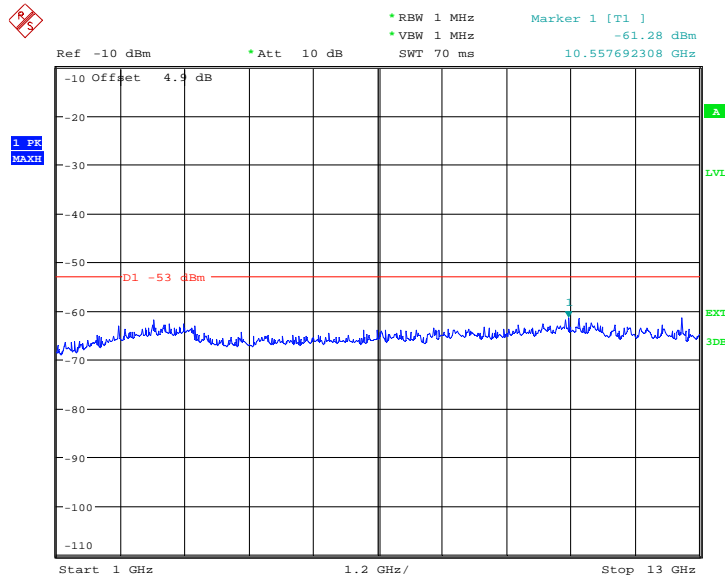

Date: 26.JUL.2011 03:40:23



Product Service

Configuration 1 - Mode 3

9kHz to 1GHz

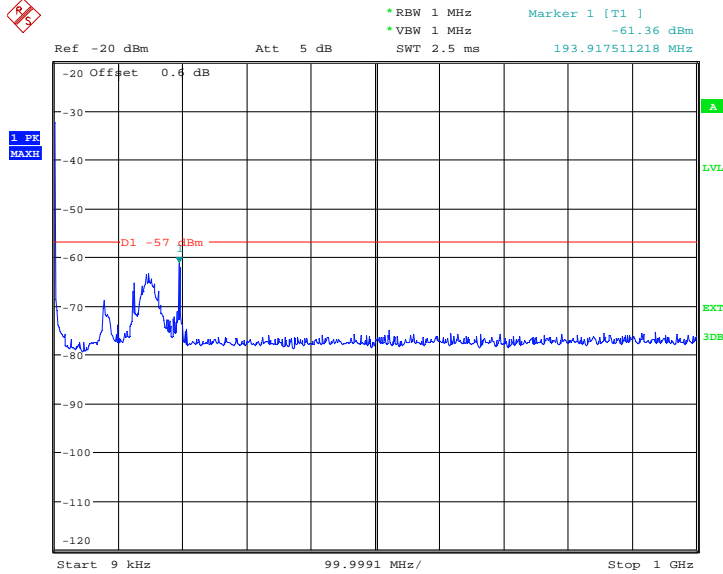

Date: 26.JUL.2011 04:38:08

1GHz to 13GHz

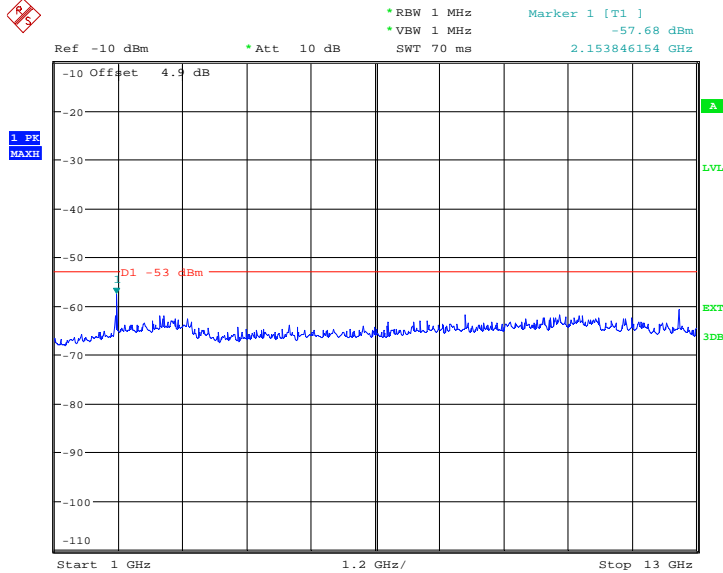

Date: 26.JUL.2011 04:40:25

Limit	-57dBm (30MHz-1GHz) and -53dBm (above 1GHz)
-------	---

Remarks

The EUT does not exceed -57dBm at the frequency range of 9kHz to 1GHz and does not exceed -53dBm at the frequency range of 1GHz to 13GHz.



Product Service

SECTION 3

TEST EQUIPMENT USED



3.1 TEST EQUIPMENT USED

List of absolute measuring and other principal items of test equipment.

Instrument	Manufacturer	Type No.	Serial No.	Calibration Period (months)	Calibration Due
Section 2.1, 2.2, 2.3, 2.4, 2.5, 2.7 and 2.10 – Maximum Conducted Output Power, Peak – Average Ratio, Modulation Characteristics, Occupied Bandwidth, Spurious Emissions at Antenna Terminals (± 1MHz), Conducted Spurious Emissions and Receiver Spurious Emissions.					
Spectrum Analyser	Rohde & Schwarz	FSQ26	200014	12	24-Aug-2011
Power Meter	Rohde & Schwarz	NRP	102624	12	27-Mar-2012
Thermal Power Sensor	Rohde & Schwarz	NRP-Z51	102168	12	24-Aug-2011
Network Analyzer	Agilent	8720D	US38431317	12	24-Aug-2011
40dB Attenuator	Aeroflex / Weinschel	48-40-43-LIM	BR5020	-	O/P MON
Load	Nanjing Jiexi	TFZ50C-3FR	JW08042-04A-007	-	O/P MON
Power Supply	Dahua	DH1716-5D	200360033	-	O/P MON
Power Supply	Dahua	DH1716A-14	20080401	-	O/P MON
Digital Multi-meter	FLUKE	179	91820401	12	03-Jan-2012
Thermo-hygrometer	AZ Instruments	8705	9151655	12	16-Dec-2011
Section 2.6 – Radiated Spurious Emissions					
Load	Shanghai Huaxiang	TF150-3	090323433	-	O/P MON
Load	Shanghai Huaxiang	TF100	09121603	-	O/P MON
EMI Receiver	Rohde & Schwarz	ESI 40	100015	12	19-Aug-2011
Ultra log test antenna	Rohde & Schwarz	HL562	100167	12	19-Aug-2011
Double-Ridged Waveguide Horn Antenna	Rohde & Schwarz	HF 906	100029	12	19-Aug-2011
Pyramidal Horn Antenna	EMCO	3160-09	-	-	-
Antenna master	Frankonia	MA 260	-	12	19-Aug-2011
Relay Switch Unit	Rohde & Schwarz	331.1601.31	338965002	-	TU
Semi Anechoic Chamber	Frankonia	23.18m×16.88m×9.60m	-	12	19-Aug-2011
Power Supply	Dahua	DH1716-5D	200360033	-	O/P MON
Power Supply	Dahua	DH1716A-14	20080401	-	O/P MON
Digital Multimeter	FLUKE	179	91820401	12	03-Jan-2012
Thermo-hygrometer	AZ Instruments	8705	9151655	12	16-Dec-2011



Product Service

Section 2.8 and 2.9 – Frequency Stability Under Temperature and Voltage Variations					
Spectrum Analyser	Rohde & Schwarz	FSQ26	200014	12	24-Aug-2011
40dB Attenuator	Aeroflex / Weinschel	48-40-43-LIM	BR5020	-	O/P MON
Temperature Chamber	Weiss-Voetsch	C1000-70	54686070200 30	12	08-Jun-2012
Power Supply	Dahua	DH1716-5D	200360033	-	O/P MON
Power Supply	Dahua	DH1716A-14	20080401	-	O/P MON
Digital Multimeter	FLUKE	179	91820401	12	03-Jan-2012
Thermo-hygrometer	AZ Instruments	8705	9151655	12	16-Dec-2011

O/P MON Output monitored with calibration equipment
 TU Traceability Unscheduled



Product Service

3.2 MEASUREMENT UNCERTAINTY

For a 95% confidence level, the measurement uncertainties for defined systems are:-

Test Discipline	Frequency / Parameter	MU
Conducted Maximum Peak Output Power	30MHz to 10GHz Amplitude	0.5dB*
Conducted Emissions	30MHz to 40GHz Amplitude	3.0dB*
Frequency Stability	30MHz to 2GHz Amplitude	$<1 \times 10^{-7}$
Radiated Emissions, Bilog Antenna, AOATS	30MHz to 1GHz Amplitude	5.1dB*
Radiated Emissions, Horn Antenna, AOATS	1GHz to 40GHz Amplitude	6.3dB*
Worst case error for both Time and Frequency measurement 12 parts in 10^6		

* In accordance with CISPR 16-4



Product Service

SECTION 4

ACCREDITATION, DISCLAIMERS AND COPYRIGHT



4.1 ACCREDITATION, DISCLAIMERS AND COPYRIGHT



This report relates only to the actual item/items tested.

Our UKAS Accreditation does not cover opinions and interpretations and any expressed are outside the scope of our UKAS Accreditation.

Results of tests not covered by our UKAS Accreditation Schedule are marked NUA
(Not UKAS Accredited).

This report must not be reproduced, except in its entirety, without the written permission of
TÜV SÜD Product Service Limited

© 2011 TÜV SÜD Product Service Limited