



REPORT

issued by an Accredited Testing Laboratory, FCC listed with Reg. no. 93866 and IC recognized pursuant IC file no. 3482A



Contact person
Reinhold Reul
Electronics
+46 10 516 55 84
Reinhold.Reul@sp.se

Date
2012-03-26

Reference
FX108941-18

Page
1 (2)

Ericsson (China) Communications Company Ltd
Att. Hua Yang
Ericsson Tower
No. 5 Lize East Street
Chaoyang District, Beijing 100102
P. R. China

Class II permissive change measurements on RUG 11 B5 850 MHz cellular radio equipment with FCC ID: TA8AKRC161194-1 and IC: 287AB-AG1611941

(7 appendices)

Test object

RUG 11 B5, product KRC 161 194/1, revision RIC

Summary

Standard	Compliant	Appendix
FCC CFR 47 / IC RSS-132		
2.1046 / RSS-132 4.4 RF power output	Yes	2
2.1049 / RSS-Gen 4.6.1 Occupied bandwidth	Yes	3
2.1051 / RSS-132 4.5 Band edge	Yes	4
2.1051 / RSS-132 4.5 Spurious emission at antenna terminals	Yes	5
2.1053 / RSS-132 4.5 Field strength of spurious radiation	Yes	6

Note 1: Above RSS-132 items are given as cross-reference only. Measurements were performed according to ANSI procedures referenced by FCC and covered by SP's accreditation.

SP Technical Research Institute of Sweden Electronics - EMC

Performed by

Reinhold Reul

Examined by

Christer Karlsson

SP Technical Research Institute of Sweden

Postal address
SP
Box 857
SE-501 15 BORÅS
Sweden

Office location
Västeråsen
Brinellgatan 4
SE-504 62 BORÅS

Phone / Fax / E-mail
+46 10 516 50 00
+46 33 13 55 02
info@sp.se

Laboratories are accredited by the Swedish Board for Accreditation and Conformity Assessment (SWEDAC) under the terms of Swedish legislation. This report may not be reproduced other than in full, except with the prior written approval of the issuing laboratory.



Table of contents

Description of the test object	Appendix 1
Operation mode during measurements	Appendix 1
Purpose of test	Appendix 1
Test setups	Appendix 1
RF power output	Appendix 2
Occupied bandwidth	Appendix 3
Band edge	Appendix 4
Spurious emission at antenna terminals	Appendix 5
Field strength of spurious radiation	Appendix 6
Photos of the test object	Appendix 7

Appendix 1

Description - Equipment Under Test (EUT)

Equipment:	GSM Base station transceiver unit				
TX frequency band:	869 – 894 MHz				
Modulations:	GMSK, 8PSK, 16QAM, 32QAM and AQPSK				
Nominal maximum output power	Per configuration and modulation, RMS value in [dBm]				
	GMSK	8PSK	16QAM	32QAM	AQPSK
Mode HC:	42.5	39.2	37.8	37.4	39.1
Mode UC:	46.0	42.7	41.3	40.9	42.6
Mode TCC:	48.5	45.2	43.8	43.4	45.1
Nominal supply voltage:	-48 V DC				

Purpose of test

The purpose of this test is to justify a Class II Permissive Change of the test object to include the use of modulation AQPSK in SCPIR 0 dB. This report verifies maintained performance characteristics of affected items by re-testing the updated equipment and comparing results for GMSK modulation with results for the new modulation.

Tested configurations and set-ups

For the scope of the test it was deemed sufficient to test TCC mode resulting in the highest RMS power. The EUT was activated at the maximum nominal RF output power and random data was transmitted in all time slots, with the various modulations being tested one at a time. Connections and reference points for measurements are shown in the set-ups below.

Test frequencies used

Channel	ARFCN	Frequency	Comment
B+1	129	869.4 MHz	TX lowest frequency
M	190	881.6 MHz	TX band center frequency
T-1	250	893.6 MHz	TX highest frequency

Reservation

The test results in this report apply only to the particular Equipment Under Test (EUT) as declared in the report.

Delivery of test object

The test object was delivered: 2011-06-07

Appendix 1

Test equipment

Measurement equipment	Calibration Due	SP number
Anechoic chamber, Hertz	2013-10	15:116
Boonton 4500A RF Peak power meter/analyser	2012-11	503 144
Boonton Power sensor 56518-S/4	2012-11	503 146
Rohde & Schwarz FSIQ40	2012-07	503 738
Rohde & Schwarz ESI40	2012-07	503 125
Rohde & Schwarz Vector Network Analyser	2012-07	503 687
Chase bilog antenna CBL 6121A	2014-10	502 460
Schaffner Reference Dipole BSRD6500	2012-03	502 181
EMCO Horn Antenna 3115	2014-01	502 175
EMCO Horn Antenna 3115	2014-01	501 548
MITEQ Low Noise Amplifier	2012-08	503 277
Flann Std gain horn 20240-20	2014-03	503 674
Attenuator 40 dB	2012-08	504 159
Attenuator 30 dB	2012-08	900 229
Attenuator 30 dB	2012-05	503 870
Attenuator 10 dB	2012-08	900 118
High pass filter	2012-08	504 199
High pass filter	2012-08	502 758
Multimeter Fluke 87	2012-05	502 190
Testo 615 temperature and humidity meter	2012-03	503 498
Testo 635 temperature and humidity meter	2013-05	504 203

Uncertainties

Measurement and test instrument uncertainties are described in the quality assurance documentation "SP-QD 10885". The uncertainties are calculated with a coverage factor k=2 (95% level of confidence).

Test engineers

Jörgen Wassholm, Martin Nilsson, Martin Forsberg and Reinhold Reul, SP

Manufacturer's representative

Hua Yang, Ericsson (China) Communications Company Ltd

Appendix 1

Test set-up, conducted measurements

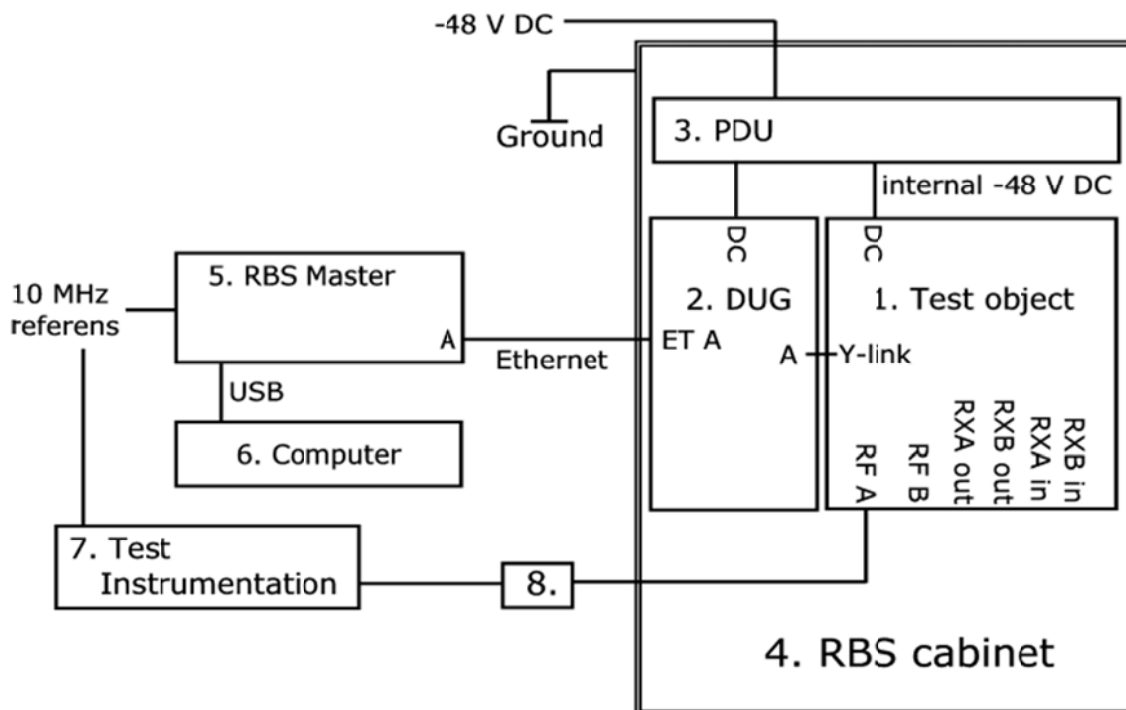

Test object

1. RUG 11 B5, product KRC 161 194/1, revision R1C, SN CB4G584239 with FCC ID: TA8AKRC161194-1 and IC: 287AB-AG1611941

Functional test equipment

2. Digital unit DUG 10 01, product KDU 137 597/1, revision R1G, CB4E569537
3. Power distribution unit PDU 02 01, product BMG 980 336/4, revision R2A, SN BJ31528316
4. RBS 6201 cabinet, BAMS 1000778792, external connections:

Interface	Type of port:
-48 V DC to internal DC connection port	DC power
Ground strap to frame grounding point	Ground
DUG port ET A to RBS master 2E port A using shielded Ethernet multi-wire RJ-45 connectors, using transmission mode E1	Telecom
5. RBS Master 2E hardware, product LPY 107 1007/3, revision R1C/A, SN T01E655543, BAMS 1000878432
6. Laptop Compaq nc6220, S/N: CNU54722NZ, BAMS 1000208319, with RBS Master 2E control software
7. Measurement equipment specified in respective appendix or client supplied Agilent MXA Signal Analyser model N9020A 20 Hz – 3.6 GHz, BAMS 1000785533 used to verify the modulation schemes
8. Attenuator / filter listed under test equipment in respective appendix

Appendix 1

Test set-up, radiated emission

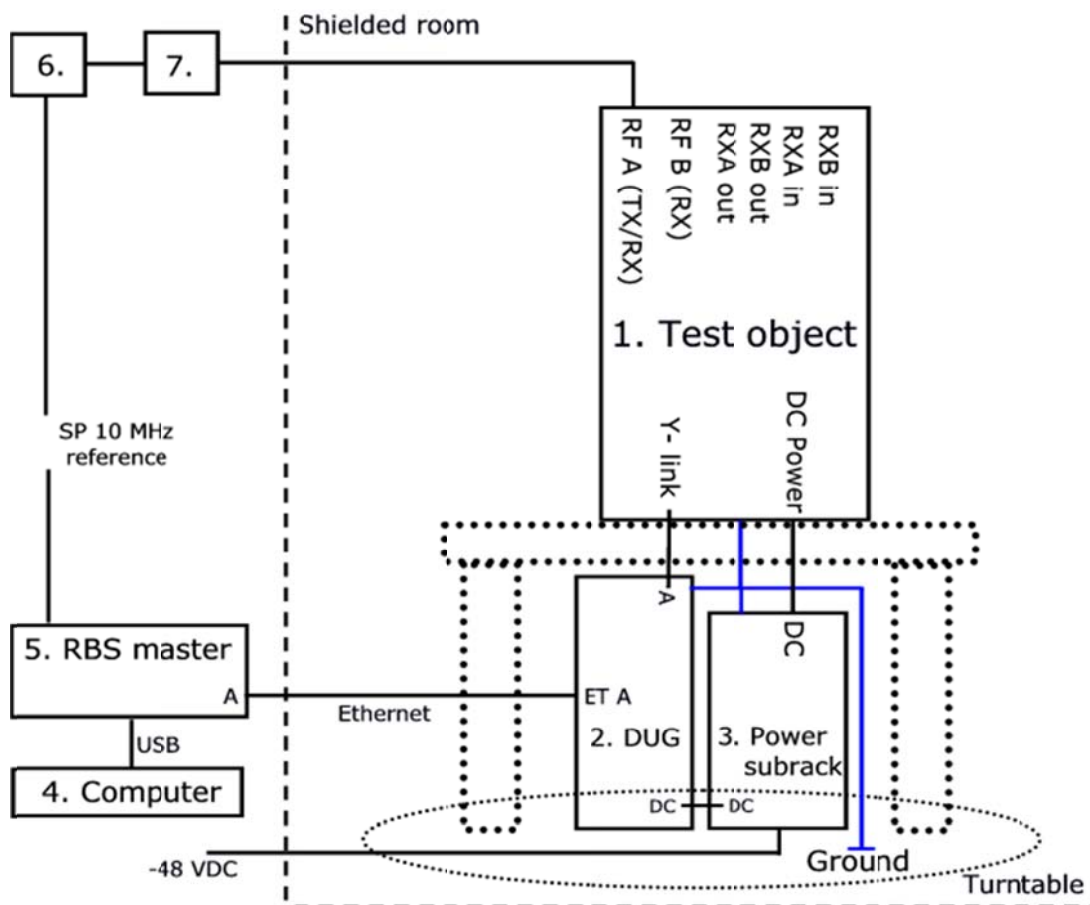

Test object

1. RUG 11 B5, product KRC 161 194/1, revision R1C, SN CB4G584239 with FCC ID:TA8AKRC161194-1 and IC:287AB-AG1611941

Functional test equipment

2. Digital unit DUG 10 01, product KDU 137 597/1, revision R1G, CB4E569537, DUG port ET A to RBS master 2E port A using shielded Ethernet multi-wire RJ-45 connectors, using transmission mode E1
3. Power sub-rack, details see below
4. Laptop Compaq nc6220, S/N: CNU54722NZ, BAMS 1000208319, with software RBS Master 2E control software
5. RBS Master 2E hardware, product LPY 107 1007/3, revision R1C/A, SN T01E655543, BAMS 1000878432
6. Rohde & Schwarz ESI40 (SP 503 125) for signal monitoring or 50 ohm termination
7. Attenuator 30 dB, SP 900229

Appendix 1

Power sub-rack modules:

Pos.	Unit	Product Number	Revision	Serial Number
	Power subrack	SXK 109 8115/1	R2A	-
1	PDU 01 01	BMG 980 336/2	R4F	BJ31532384
2	PDU 01 01	BMG 980 336/2	R4F	BJ31532382
3	SHU 01 01	BGK 901 18/1	R3C	BJ31446269
4	DUMMY	SXK 109 8257/1	R1F	-
5	DUMMY	SXK 109 8257/1	R1F	-
6	PFU	KFE 101 11621	R1B	BR80910495
7	DUMMY	SXK 109 8257/1	R1F	-
8	DUMMY	SXK 109 8257/1	R1F	-
9	PCF 02 01	KFE 101 1157/1	R1C	BW95301450

Test object connections

Interface	Type of port
-48.0 V DC	DC power
Ground strap connected to shell in stand-alone radiated test,	Ground
Grounding through RBS cabinet frame in conducted test	
RF A, 7/16" female RF connector, combined TX/RX	RF/Antenna
RF B, 7/16" female RF connector, unconnected, RX only	RF/Antenna
Y-link data connection	Signal
RXA out, unconnected	Signal
RXB out, unconnected	Signal
RXA in, unconnected	Signal
RXB in, unconnected	Signal

Test object software

Software	Revision
CXP 104 0007/05	R31E

References

Measurements were done according to relevant parts of the following standards:

- ANSI C63.4-2009
- ANSI/TIA/EIA-603-C-2004
- ANSI/TIA/EIA 136-280-D-2002
- CFR 47 part 2, October 1st, 2010
- CFR 47 part 22, October 1st, 2010
- RSS Gen, Issue 3
- RSS 132, Issue 2

Appendix 2

RF Power output measurements according to CFR 47 2.1046 / RSS-132 4.4

Date	Temperature	Humidity
2011-12-05	23 °C ± 3 °C	23 % ± 5 %

Test set-up and procedure

Measurements were made with EUT port RF A via an 50 ohm attenuator connected to a peak power analyser.

Measurement equipment	SP number
Boonton 4500A RF Peak power meter/analyzer	503 144
Boonton Power sensor 56518-S/4	503 146
Attenuator	504 159
Multimeter Fluke 87	502 190
Testo 615 temperature and humidity meter	503 498

Measurement uncertainty: 0.7 dB

Results

Configuration: TCC mode, RBS master 2E setting 51 for maximum nominal output power.

Transmitter power (dBm)		Peak / RMS
Channel:	M	
Modulation:		
GMSK	49.6 / 48.8	
AQPSK	49.1 / 45.1	

Limits

CFR 47 § 22.913: 500 W ERP shall not be exceeded.

Complies?	Yes
-----------	-----

Appendix 3

Occupied bandwidth measurements according to 47CFR 2.1049 / RSS-Gen 4.6.1

Date	Temperature	Humidity
2011-12-05	23 °C ± 3 °C	23 % ± 5 %

Test set-up and procedure

Measurements were made at connector RF A. The output was connected to a spectrum analyser with the RMS detector activated. The spectrum analyser was connected to an external 10 MHz reference standard during the measurements.

Measurement equipment	SP number
Rohde & Schwarz FSIQ40	503 738
Attenuator	504 159
Multimeter Fluke 87	502 190
Testo 615 temperature and humidity meter	503 498

Measurement uncertainty: 3.7 dB, 1.33 kHz

Results

Configuration: TCC mode, RBS master 2E setting 51 for maximum nominal output power.

	Channel	Modulation	OBW
Diagram 1:	M	GMSK	241 kHz
Diagram 2:	M	AQPSK	240 kHz

The diagrams are shown on the following page.

Appendix 3

Diagram 1:

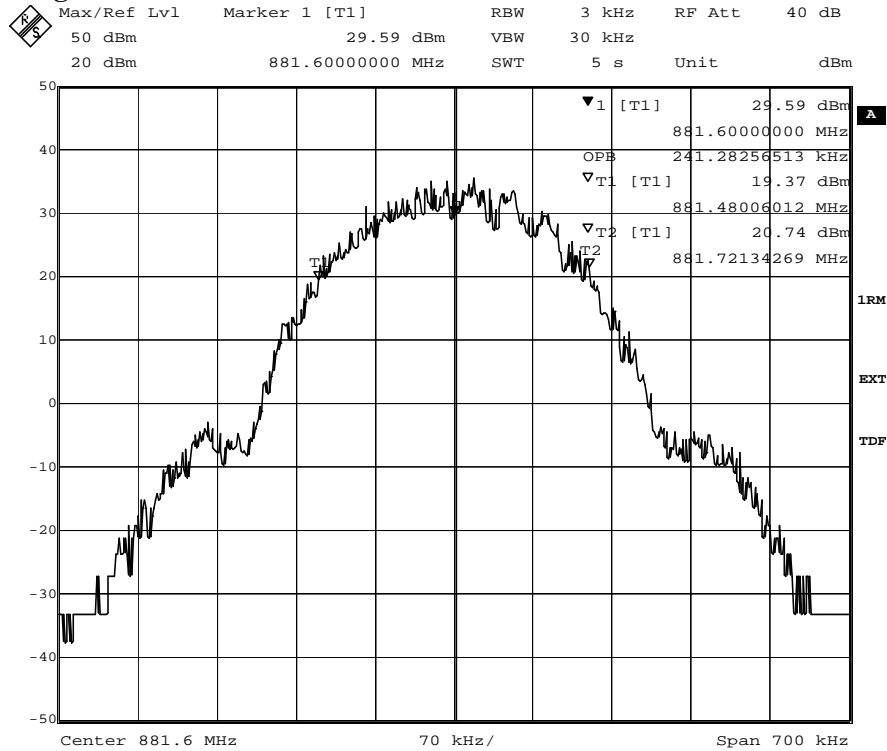

Date: 5.DEC.2011 10:16:14

Diagram 2:

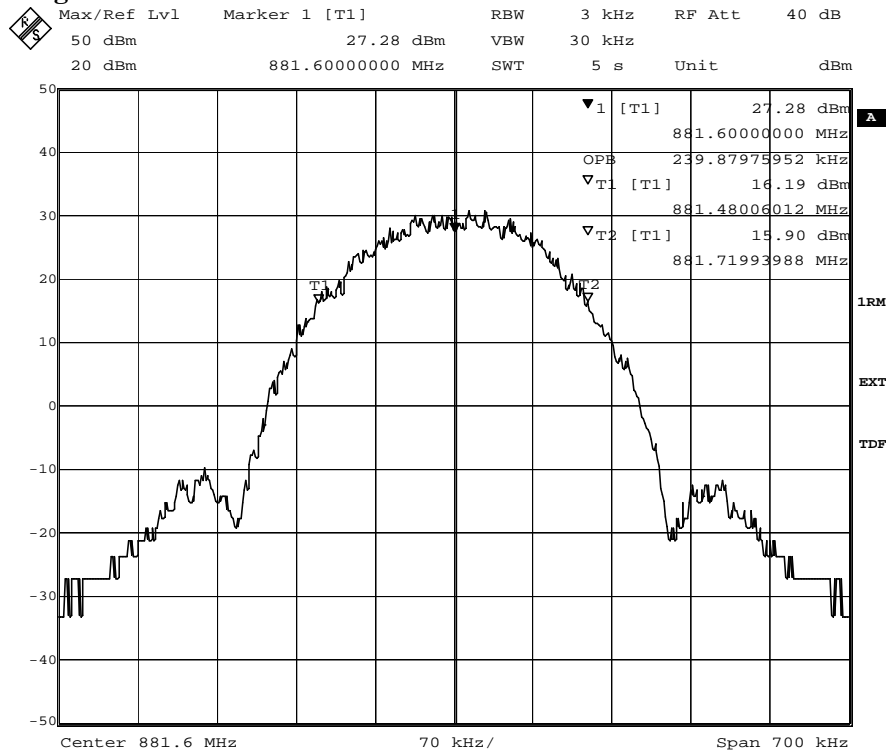

Date: 5.DEC.2011 10:14:25



Appendix 4

Band edge measurements according to 47CFR 2.1051 / RSS-132 4.5

Date	Temperature	Humidity
2011-12-05	23 °C ± 3 °C	23 % ± 5 %

Test set-up and procedure

The measurements were made per definition in §22.917, with the EUT port RF A via attenuators connected to a spectrum analyzer with the RMS detector activated. The spectrum analyzer was connected to an external 10 MHz reference standard during the measurements.

Measurement equipment	SP number
Rohde & Schwarz FSIQ40	503 738
Attenuator	504 159
Multimeter Fluke 87	502 190
Testo 615 temperature and humidity meter	503 498

Measurement uncertainty: 3.7 dB

Results

Configuration: TCC mode, RBS master 2E setting 51 for maximum nominal output power.

Diagram	Channel	Modulation
1 a, b, c	B+1	AQPSK
2 a, b, c	T-1	AQPSK

The diagrams are shown on the following pages.

Remark

The channels adjacent to the TX frequency band edges must not be used. The lowest channel to be used is ARFCN 129, the highest ARFCN is 250.

Limits

The power of any emission outside the frequency band shall be attenuated below the transmitter power (P) by at least $43 + 10 \log P$ dB.

Complies?	Yes
-----------	-----

Appendix 4

Diagram 1 a:

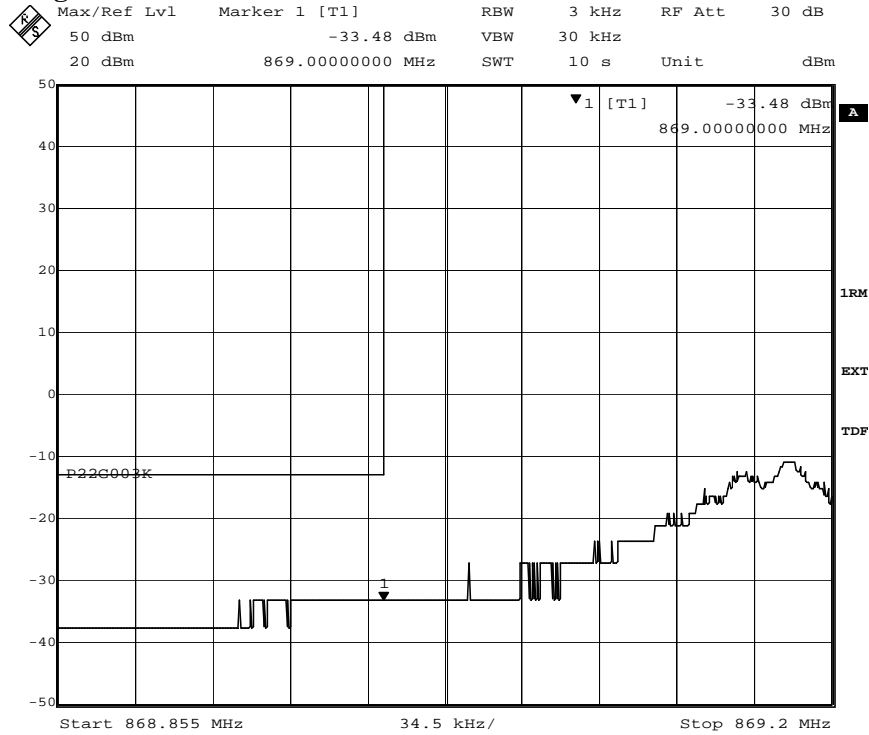

Date: 5.DEC.2011 10:27:35

Diagram 1 b:

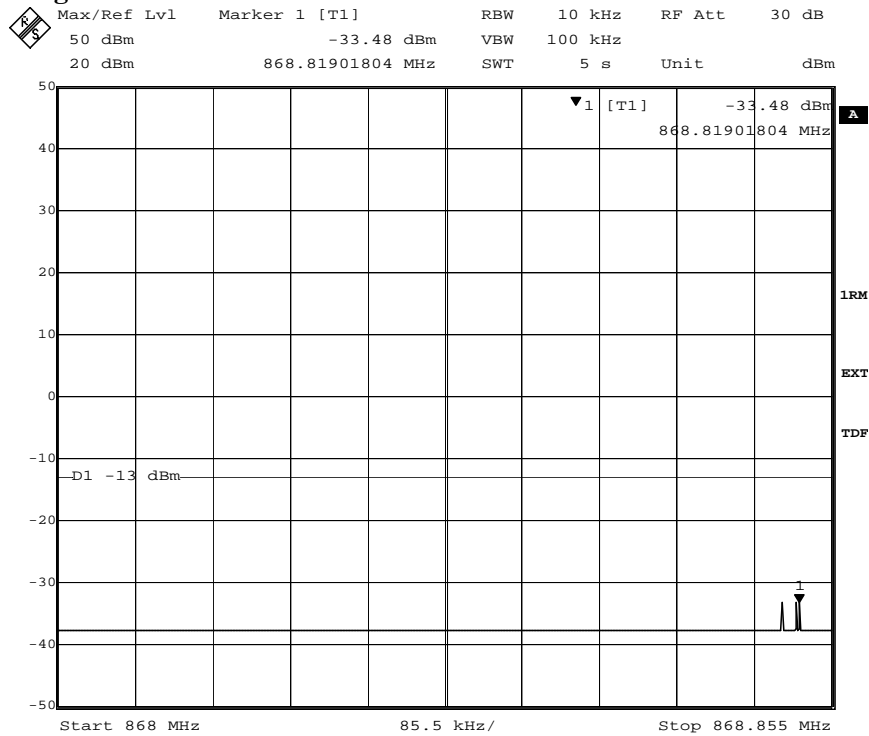

Date: 5.DEC.2011 10:29:29



REPORT

FCC ID:TA8AKRC161194-1
IC:287AB-AG1611941

Date 2012-03-26 Reference FX108941-18

Page 3 (5)

Appendix 4

Diagram 1c:

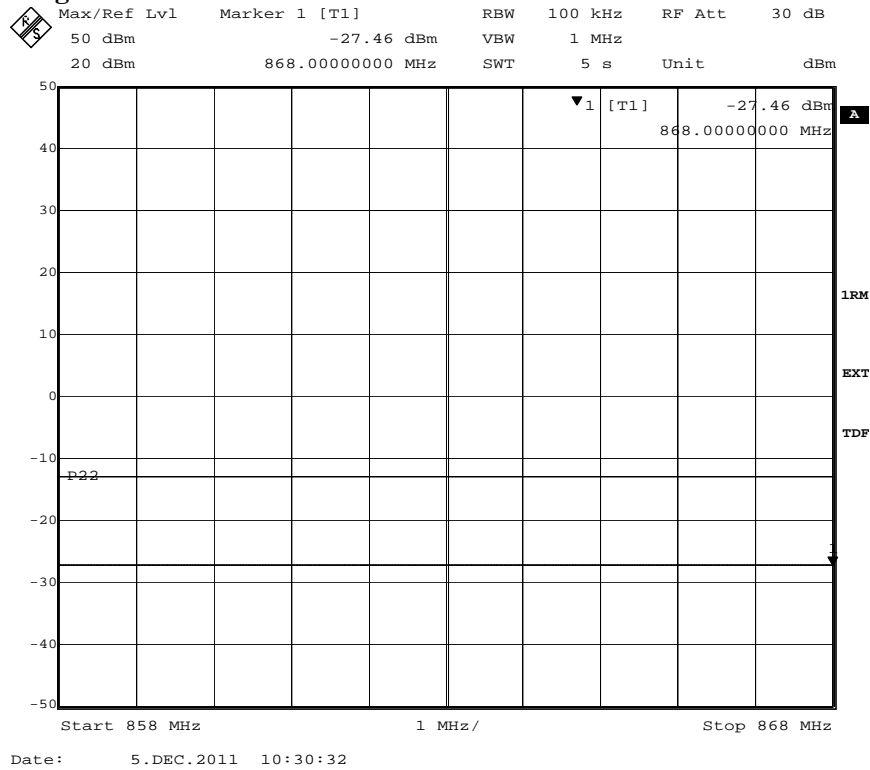

Appendix 4

Diagram 2 a:

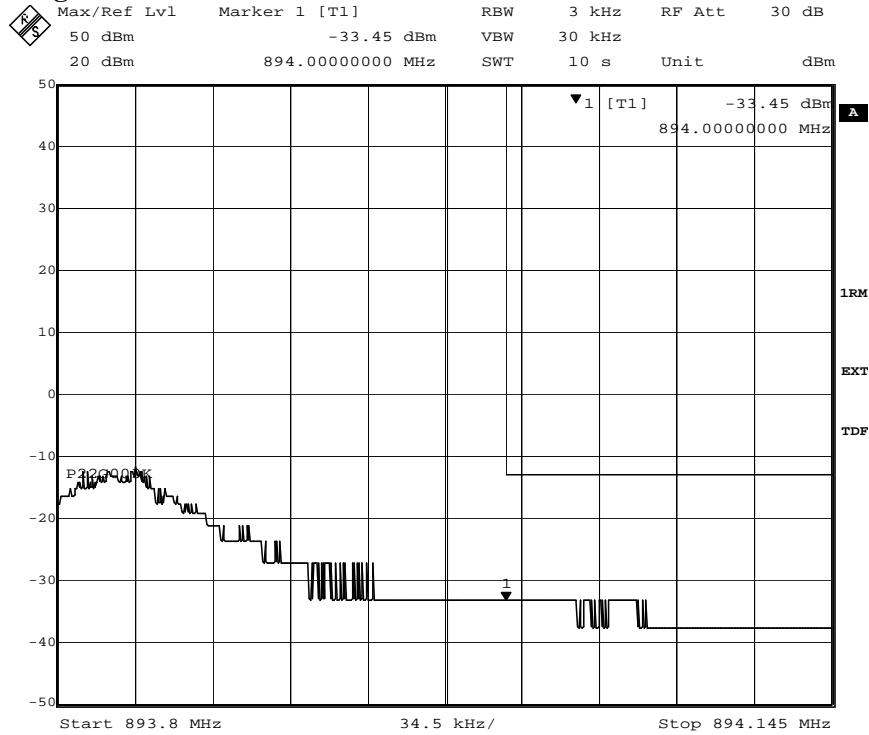

Date: 5.DEC.2011 10:41:48

Diagram 2 b:

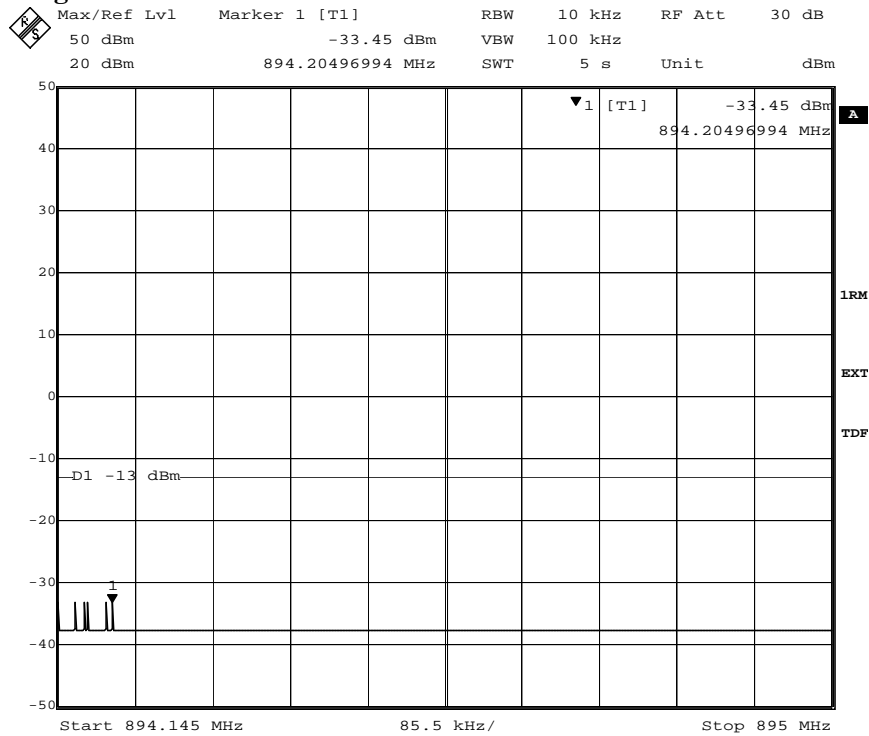

Date: 5.DEC.2011 10:43:08



Appendix 4

Diagram 2c:

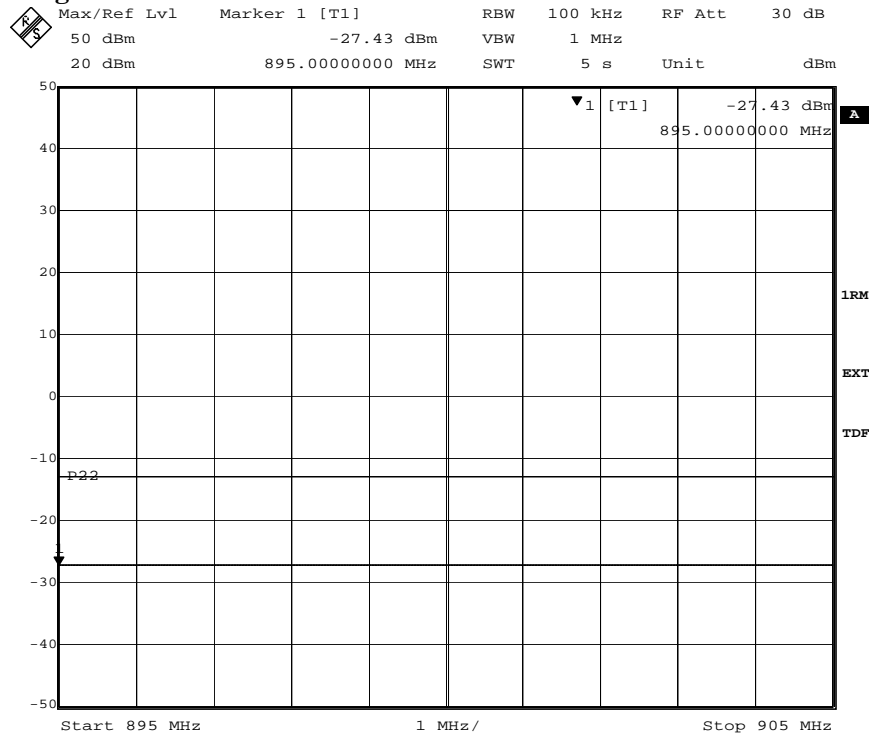

Date: 5.DEC.2011 10:45:06

Appendix 5

Conducted spurious emission measurements according to 47CFR 2.1051 / RSS-132 4.5

Date	Temperature	Humidity
2011-12-05	23 °C ± 3 °C	23 % ± 5 %

Test set-up and procedure

The measurements were made at EUT port RF A. The output was connected to a spectrum analyser. A pre-measurement was performed with the PEAK detector activated. Emission close to or above the limit with the PEAK detector is measured with the RMS detector activated. The spectrum analyser was connected to an external 10 MHz reference standard during the measurements.

Measurement equipment	SP number
Rohde & Schwarz FSIQ40	503 738
Attenuator	504 159
High pass filter	504 199
Testo 615 temperature and humidity meter	503 498

Measurement uncertainty: 3.7 dB

Results

Configuration: TCC mode, RBS master 2E setting 51 for maximum nominal output power. The TX was activated on channel M.

Diagram	Modulation	Frequency range measured
1 a:	GMSK	9 kHz – 1 GHz
1 b:	GMSK	1 GHz – 10 GHz
2 a:	AQPSK	9 kHz – 1 GHz
2 b:	AQPSK	1 GHz – 10 GHz

The diagrams are shown on the following pages.

Remark

The emission at 9 kHz on some plots was not generated by the test object. A complementary measurement with a smaller RBW showed that it was related to the LO feed-through.

Limits

The power of any emission outside the frequency band shall be attenuated below the transmitter power (P) by at least 43 + 10 log P dB.

Complies?	Yes
-----------	-----

Appendix 5

Diagram 1 a:

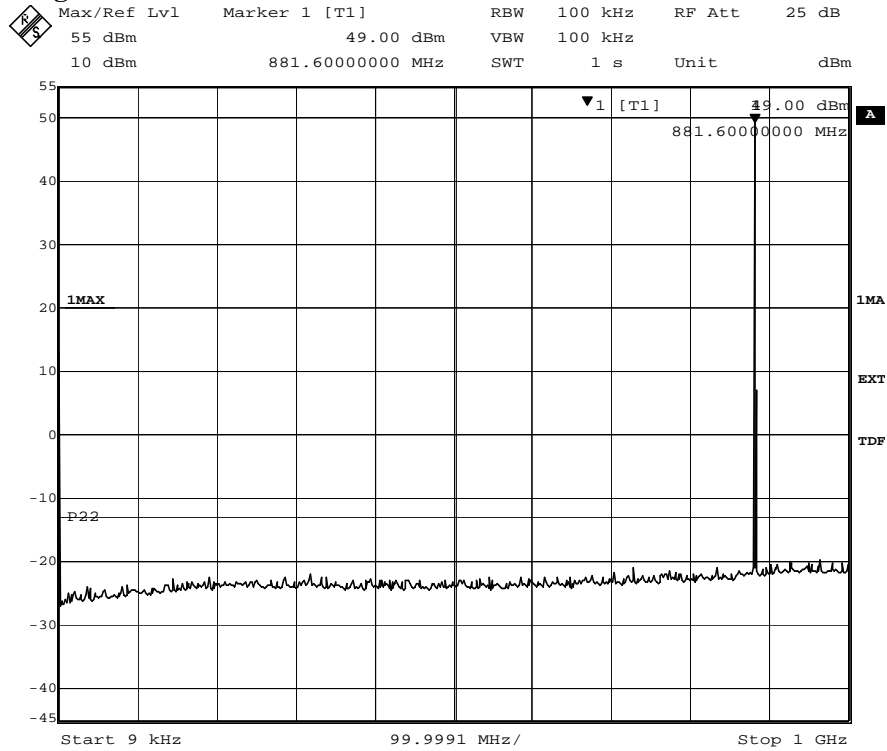

Date: 5.DEC.2011 10:00:58

Diagram 1 b:

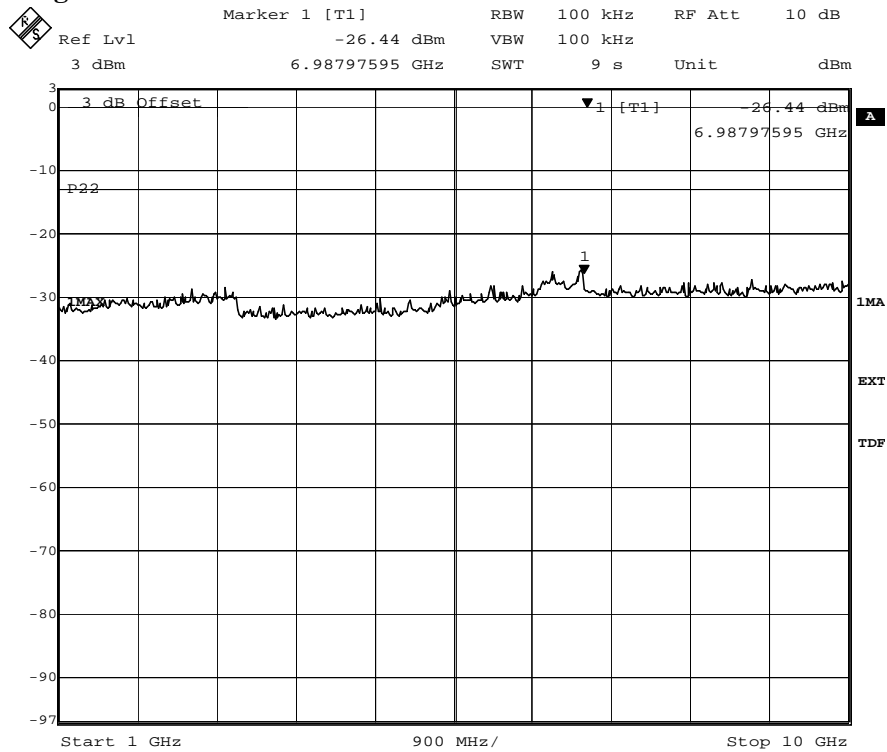

Date: 5.DEC.2011 10:10:40

Appendix 5

Diagram 2 a:

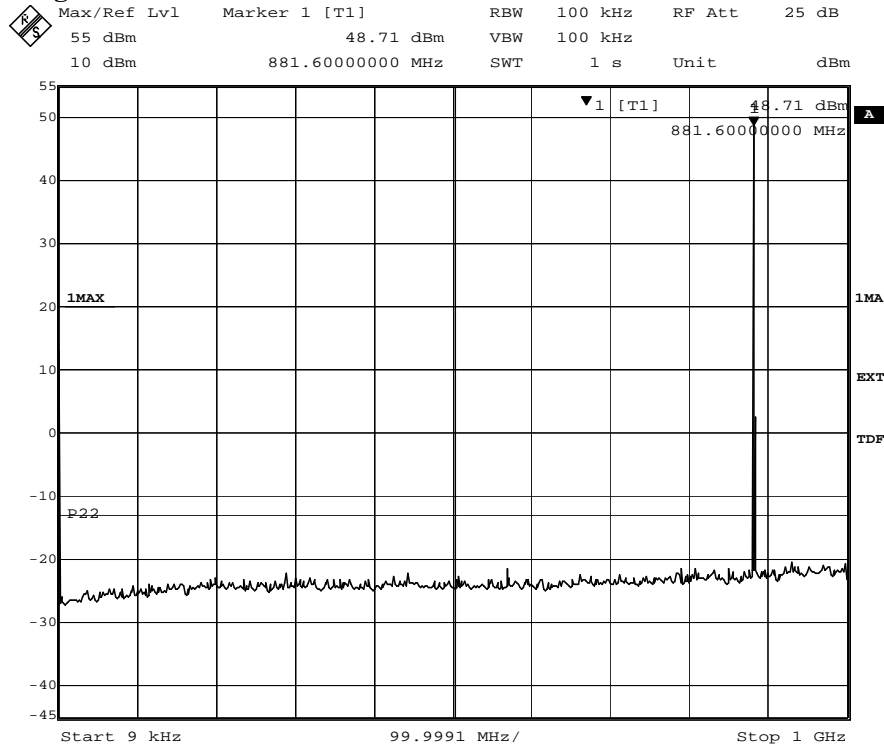

Date: 5.DEC.2011 10:03:36

Diagram 2 b:

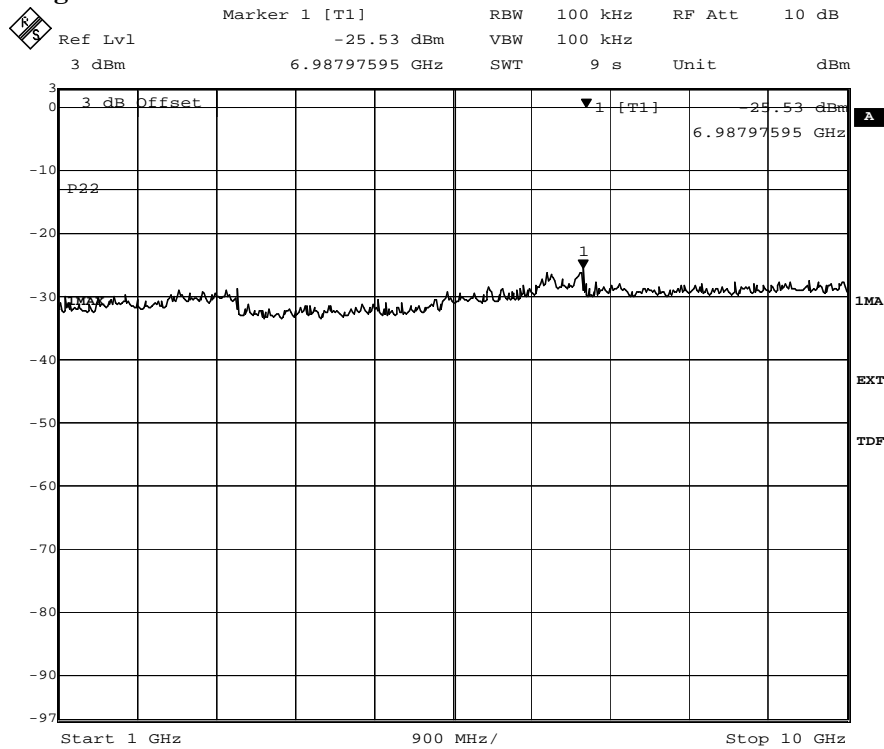

Date: 5.DEC.2011 10:12:08

Appendix 6

Field strength of spurious radiation measurements according to 47CFR 2.1053 / RSS-132 4.5

Date	Temperature	Humidity
2011-06-28	22 °C ± 3 °C	43 % ± 5 %

Test set-up and procedure

The measurements were performed with both horizontal and vertical polarisation of the antenna. The antenna distance was 3 m in the frequency range 30 MHz – 10 GHz. The measurements were performed in Effective Radiated Power (ERP). A fully anechoic chamber was used during the measurements. The chamber is regularly calibrated with the substitution method and from that calibration an ERP correction factor is derived. The correction factor was used as a transducer to get the readings in ERP.

The measurement procedure was as the following:

1. A pre-measurement was first performed with peak detector. The EUT was continuously measured in 360 degrees.
2. Spurious radiation on frequencies closer than 6 dB to the limit was re-measured with RMS detector and with the substitution method according to the standard.

Configuration: TCC mode, RBS master 2E setting 51 for maximum nominal power. The TX was activated on channel M.

Measurement equipment	SP number
Anechoic chamber, Hertz	15:116
R&S FSIQ40 Signal Analyser	503 738
R&S EMI Test Receiver ESI40	503 125
Chase bilog antenna CBL 6121A	502 460
Schaffner Reference Dipole BSRD6500	503 649
EMCO Horn Antenna 3115	502 175
EMCO Horn Antenna 3115	501 548
MITEQ Low Noise Amplifier	503 277
R&S Vector Network Analyser	503 687
Hiphpass filter	504 199
Testo 615 temperature and humidity meter	503 498

Appendix 6

The test set-up is shown in the picture below:



Appendix 6

Results

Modulation GMSK

Frequency (MHz)	Spurious emission level (dBm)	
	Vertical	Horizontal
30-10 000	All emission > 20 dB below limit	All emission > 20 dB below limit

Modulation AQPSK in SCPIR 0 dB

Frequency (MHz)	Spurious emission level (dBm)	
	Vertical	Horizontal
30-10 000	All emission > 20 dB below limit	All emission > 20 dB below limit

Measurement uncertainty: 3.1 dB

Limits

The power of any emission outside the frequency band shall be attenuated below the transmitter power (P) by at least $43 + 10 \log P$ dB.

Complies?	Yes
-----------	-----

Appendix 7

Photos of the test object

Front side



Rear side

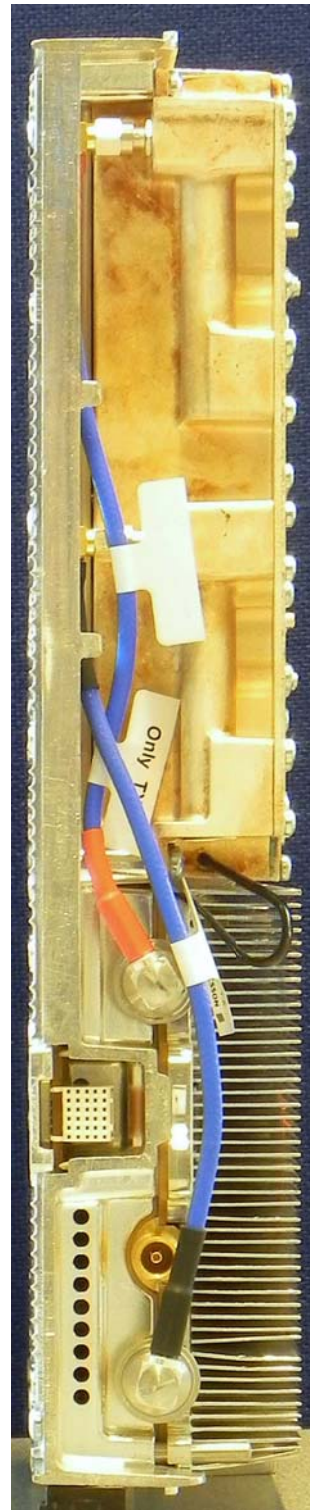

Appendix 7

Left side

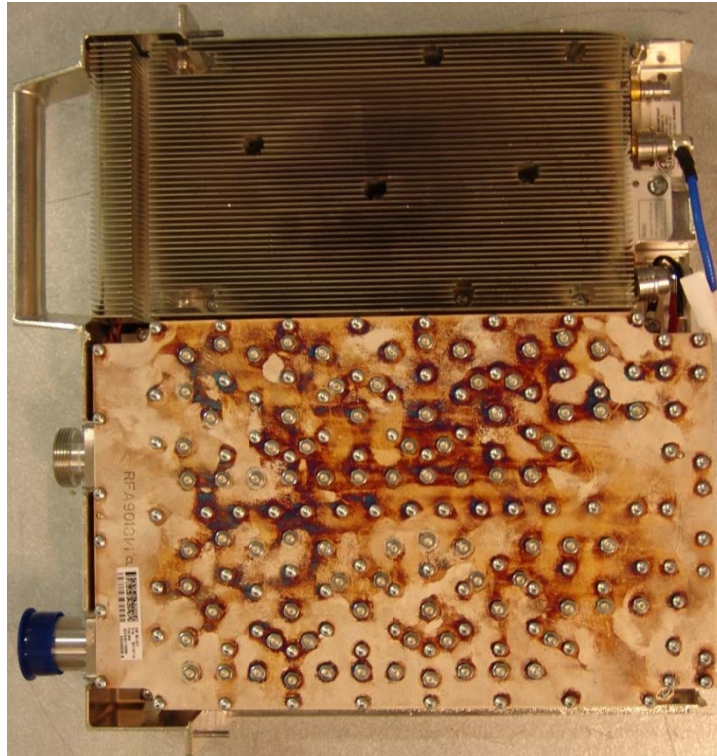

Right side

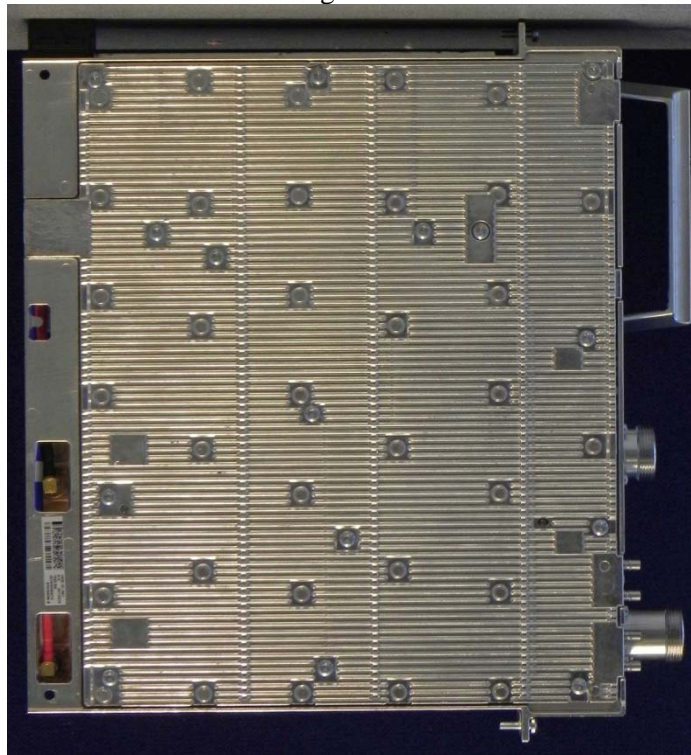

Appendix 7

Top side



Bottom side

