



Product Service

**Choose certainty.
Add value.**

Report On

FCC and Industry Canada Testing of the
Ericsson AB
RUG 11 B5

COMMERCIAL-IN-CONFIDENCE

FCC ID: TA8AKRC161194-1
IC ID: 287AB-AG1611941

Document 75909919 Report 01 Issue 2

June 2010



Product Service

TÜV Product Service Ltd, Octagon House, Concorde Way, Segensworth North,
Fareham, Hampshire, United Kingdom, PO15 5RL
Tel: +44 (0) 1489 558100. Website: www.tuvps.co.uk

COMMERCIAL-IN-CONFIDENCE

REPORT ON

FCC and Industry Canada Testing of the
Ericsson AB
RUG 11 B5

Document 75909919 Report 01 Issue 2

June 2010

PREPARED FOR

Ericsson AB
Torshamnsgatan 23
S-164 80
Stockholm
Sweden

PREPARED BY

N Bennett
Senior Administrator

APPROVED BY

M Jenkins
Authorised Signatory

DATED

22 June 2010

This report has been re-issued as issue 2 to update Max Output Power and Band Edge and OBW Test Data

ENGINEERING STATEMENT

The measurements shown in this report were made in accordance with the procedures described on test pages. All reported testing was carried out on a sample equipment to demonstrate limited compliance with FCC CFR 47: Part 22 and Industry Canada RSS-132. The sample tested was found to comply with the requirements defined in the applied rules.

Test Engineer(s);

X Zhang

C Zhang



0141



CONTENTS

Section	Page No
1	REPORT SUMMARY 3
1.1	Introduction 4
1.2	Brief Summary of Results 5
1.3	Declaration of Build Status 11
1.4	Product Information 12
1.5	Test Conditions 17
1.6	Deviations From the Standard 17
1.7	Modification Record 17
1.8	Alternative Test Site 17
2	TEST DETAILS 18
2.1	Maximum Peak Output Power - Conducted 19
2.2	Modulation Characteristics 22
2.3	Occupied Bandwidth 26
2.4	Spurious Emissions at Terminals (± 1 MHz) 31
2.5	Radiated Spurious Emissions 39
2.6	Conducted Spurious Emissions 51
2.7	Frequency Stability Under Temperature Variations 77
2.8	Frequency Stability Under Voltage Variations 79
3	TEST EQUIPMENT USED 81
3.1	Test Equipment Used 82
3.2	Measurement Uncertainty 83
4	ACCREDITATION, DISCLAIMERS AND COPYRIGHT 84
4.1	Accreditation, Disclaimers and Copyright 85



SECTION 1

REPORT SUMMARY

FCC and Industry Canada Testing of the
Ericsson AB
RUG 11 B5



1.1 INTRODUCTION

The information contained in this report is intended to show verification of the Ericsson AB RUG 11 B5 to the requirements of FCC CFR 47 Part 22 and Industry Canada RSS-132.

Testing was carried out in support of an application for Grant of Equipment Authorisation in the name of Ericsson AB RUG 11 B5.

Objective	To perform FCC and Industry Canada Testing to determine the Equipment Under Test's (EUT's) compliance with the Test Specification, for the series of tests carried out.
Manufacturer	Ericsson AB
Product Model	RUG 11 B5
Product Name	KRC 161 194/1
Serial Number(s)	CB4C986602
Software Version	G10A/1_R25E
Hardware Version	R1B
Number of Samples Tested	1
Test Specification/Issue/Date	FCC CFR 47 Part 22: 2009 Industry Canada RSS-132: 2005
Incoming Release Date	Declaration of Build Status 17 May 2010
Order Number Date	PTP 19 May 2010
Start of Test	17 May 2010
Finish of Test	19 June 2010
Name of Engineer(s)	X Zhang C Zhang
Related Document(s)	ANSI C63.4: 2009 FCC CFR 47 Part 2: 2009 FCC CFR 47 Part 15: 2009 Industry Canada RSS-GEN Issue 2: 2007



1.2 BRIEF SUMMARY OF RESULTS

A brief summary of results in accordance with FCC CFR 47 Part 22 and Industry Canada RSS-132, is shown below.

Configuration 1 – UC (Hybrid Uncombined): Output 1 without internal combiner							
Section	Spec Clause		Test Description	Mode	Mod State	Result	Comments
	FCC Part 22	RSS-132					
	22.913(a)	4.4	Effective Radiated Power	869.2 MHz		N/A	No integral antenna.
				881.6 MHz		N/A	
				893.8 MHz		N/A	
				869.4 MHz		N/A	
				893.6 MHz		N/A	
				869.2 MHz+ 881.6 MHz		N/A	
881.6 MHz+ 893.8 MHz		N/A					
2.1	2.1046, 22.913 (a)	4.4	Maximum Peak Output Power - Conducted	869.2 MHz	0	Pass	
				881.6 MHz	0	Pass	
				893.8 MHz	0	Pass	
				869.4 MHz		N/A	
				893.6 MHz		N/A	
				869.2 MHz+ 881.6 MHz		N/A	
881.6 MHz+ 893.8 MHz		N/A					
2.2	2.1047 (d)	4.2	Modulation Characteristics	869.2 MHz	0	Pass	Technical description provided
				881.6 MHz		N/A	
				893.8 MHz	0	Pass	
				869.4 MHz		N/A	
				893.6 MHz		N/A	
				869.2 MHz+ 881.6 MHz		N/A	
881.6 MHz+ 893.8 MHz		N/A					
2.3	2.1049, 22.917(b)	RSS-Gen 4.6.1	Occupied Bandwidth	869.2 MHz	0	Pass	
				881.6 MHz	0	Pass	
				893.8 MHz	0	Pass	
				869.4 MHz		N/A	
				893.6 MHz		N/A	
				869.2 MHz+ 881.6 MHz		N/A	
881.6 MHz+ 893.8 MHz		N/A					



Configuration 1 – UC (Hybrid Uncombined): Output 1 without internal combiner							
Section	Spec Clause		Test Description	Mode	Mod State	Result	Comments
	FCC Part 22	RSS-132					
2.4	2.1051, 22.917(b)	4.5	Spurious Emissions at Antenna Terminals (±1MHz)	869.2 MHz		N/A	The channel adjacent to the lower and higher band-edge cannot be used. The lowest usable channel is 129 (869.4MHz), the highest usable channel is 250 (893.6 MHz)
				881.6 MHz		N/A	
				893.8 MHz		N/A	
				869.4 MHz	0	Pass	
				893.6 MHz	0	Pass	
				869.2 MHz+ 881.6 MHz		N/A	
				881.6 MHz+ 893.8 MHz		N/A	
2.5	2.1053, 22.917(a)	4.5	Radiated Spurious Emissions	869.2 MHz	0	Pass	
				881.6 MHz	0	Pass	
				893.8 MHz	0	Pass	
				869.4 MHz		N/A	
				893.6 MHz		N/A	
				869.2 MHz+ 881.6 MHz		N/A	
				881.6 MHz+ 893.8 MHz		N/A	
2.6	2.1051, 22.917(a)	4.5	Conducted Spurious Emissions	869.2 MHz	0	Pass	
				881.6 MHz	0	Pass	
				893.8 MHz	0	Pass	
				869.4 MHz		N/A	
				893.6 MHz		N/A	
				869.2 MHz+ 881.6 MHz		N/A	
				881.6 MHz+ 893.8 MHz		N/A	
2.7	2.1055, 22.355	4.3	Frequency Stability Under Temperature Variations	869.2 MHz		N/A	
				881.6 MHz	0	Pass	
				893.8 MHz		N/A	
				869.4 MHz		N/A	
				893.6 MHz		N/A	
				869.2 MHz+ 881.6 MHz		N/A	
				881.6 MHz+ 893.8 MHz		N/A	
2.8	2.1055, 22.355	4.3	Frequency Stability Under Voltage Variations	869.2 MHz		N/A	
				881.6 MHz	0	Pass	
				893.8 MHz		N/A	
				869.4 MHz		N/A	
				893.6 MHz		N/A	
				869.2 MHz+ 881.6 MHz		N/A	
				881.6 MHz+ 893.8 MHz		N/A	



Configuration 2 – TCC (Transmitter Coherent Combining): Output 1 with internal combiner plus TCC							
Section	Spec Clause		Test Description	Mode	Mod State	Result	Comments
	FCC Part 22	RSS-132					
	22.913(a)	4.4	Effective Radiated Power	869.2 MHz		N/A	No integral antenna.
				881.6 MHz		N/A	
				893.8 MHz		N/A	
				869.4 MHz		N/A	
				893.6 MHz		N/A	
				869.2 MHz+ 881.6 MHz		N/A	
				881.6 MHz+ 893.8 MHz		N/A	
2.1	2.1046, 22.913 (a)	4.4	Maximum Peak Output Power - Conducted	869.2 MHz	0	Pass	
				881.6 MHz	0	Pass	
				893.8 MHz	0	Pass	
				869.4 MHz		N/A	
				893.6 MHz		N/A	
				869.2 MHz+ 881.6 MHz		N/A	
				881.6 MHz+ 893.8 MHz		N/A	
2.2	2.1047 (d)	4.2	Modulation Characteristics	869.2 MHz		N/A	Technical description provided
				881.6 MHz		N/A	
				893.8 MHz		N/A	
				869.4 MHz		N/A	
				893.6 MHz		N/A	
				869.2 MHz+ 881.6 MHz		N/A	
				881.6 MHz+ 893.8 MHz		N/A	
2.3	2.1049, 22.917(b)	RSS-Gen 4.6.1	Occupied Bandwidth	869.2 MHz		N/A	
				881.6 MHz		N/A	
				893.8 MHz		N/A	
				869.4 MHz		N/A	
				893.6 MHz		N/A	
				869.2 MHz+ 881.6 MHz		N/A	
				881.6 MHz+ 893.8 MHz		N/A	



Configuration 2 – TCC (Transmitter Coherent Combining): Output 1 with internal combiner plus TCC							
Section	Spec Clause		Test Description	Mode	Mod State	Result	Comments
	FCC Part 22	RSS-132					
2.4	2.1051, 22.917(b)	4.5	Spurious Emissions at Antenna Terminals (±1MHz)	869.2 MHz		N/A	The channel adjacent to the lower and higher band-edge cannot be used. The lowest usable channel is 129 (869.4MHz), the highest usable channel is 250 (893.6 MHz)
				881.6 MHz		N/A	
				893.8 MHz		N/A	
				869.4 MHz	0	Pass	
				893.6 MHz	0	Pass	
				869.2 MHz+ 881.6 MHz		N/A	
881.6 MHz+ 893.8 MHz		N/A					
2.5	2.1053, 22.917(a)	4.5	Radiated Spurious Emissions	869.2 MHz	0	Pass	
				881.6 MHz	0	Pass	
				893.8 MHz	0	Pass	
				869.4 MHz		N/A	
				893.6 MHz		N/A	
				869.2 MHz+ 881.6 MHz		N/A	
881.6 MHz+ 893.8 MHz		N/A					
2.6	2.1051, 22.917(a)	4.5	Conducted Spurious Emissions	869.2 MHz	0	Pass	
				881.6 MHz	0	Pass	
				893.8 MHz	0	Pass	
				869.4 MHz		N/A	
				893.6 MHz		N/A	
				869.2 MHz+ 881.6 MHz		N/A	
881.6 MHz+ 893.8 MHz		N/A					
2.7	2.1055, 22.355	4.3	Frequency Stability Under Temperature Variations	869.2 MHz		N/A	
				881.6 MHz		N/A	
				893.8 MHz		N/A	
				869.4 MHz		N/A	
				893.6 MHz		N/A	
				869.2 MHz+ 881.6 MHz		N/A	
881.6 MHz+ 893.8 MHz		N/A					
2.8	2.1055, 22.355	4.3	Frequency Stability Under Voltage Variations	869.2 MHz		N/A	
				881.6 MHz		N/A	
				893.8 MHz		N/A	
				869.4 MHz		N/A	
				893.6 MHz		N/A	
				869.2 MHz+ 881.6 MHz		N/A	
881.6 MHz+ 893.8 MHz		N/A					



Configuration 3 – HC (Hybrid Combined): Output 1 with internal combiner							
Section	Spec Clause		Test Description	Mode	Mod State	Result	Comments
	FCC Part 22	RSS-132					
	22.913(a)	4.4	Effective Radiated Power	869.2 MHz		N/A	No integral antenna.
				881.6 MHz		N/A	
				893.8 MHz		N/A	
				869.4 MHz		N/A	
				893.6 MHz		N/A	
				869.2 MHz+ 881.6 MHz		N/A	
881.6 MHz+ 893.8 MHz		N/A					
2.1	2.1046, 22.913 (a)	4.4	Maximum Peak Output Power - Conducted	869.2 MHz	0	Pass	
				881.6 MHz	0	Pass	
				893.8 MHz	0	Pass	
				869.4 MHz		N/A	
				893.6 MHz		N/A	
				869.2 MHz+ 881.6 MHz		N/A	
881.6 MHz+ 893.8 MHz		N/A					
2.2	2.1047 (d)	4.2	Modulation Characteristics	869.2 MHz		N/A	Technical description provided
				881.6 MHz		N/A	
				893.8 MHz		N/A	
				869.4 MHz		N/A	
				893.6 MHz		N/A	
				869.2 MHz+ 881.6 MHz		N/A	
881.6 MHz+ 893.8 MHz		N/A					
2.3	2.1049, 22.917(b)	RSS-Gen 4.6.1	Occupied Bandwidth	869.2 MHz		N/A	
				881.6 MHz		N/A	
				893.8 MHz		N/A	
				869.4 MHz		N/A	
				893.6 MHz		N/A	
				869.2 MHz+ 881.6 MHz		N/A	
881.6 MHz+ 893.8 MHz		N/A					



Configuration 3 – HC (Hybrid Combined): Output 1 with internal combiner							
Section	Spec Clause		Test Description	Mode	Mod State	Result	Comments
	FCC Part 22	RSS-132					
2.4	2.1051, 22.917(b)	4.5	Spurious Emissions at Antenna Terminals (±1MHz)	869.2 MHz		N/A	The channel adjacent to the lower and higher band-edge cannot be used. The lowest usable channel is 129 (869.4MHz), the highest usable channel is 250 (893.6 MHz)
				881.6 MHz		N/A	
				893.8 MHz		N/A	
				869.4 MHz	0	Pass	
				893.6 MHz	0	Pass	
				869.2 MHz+ 881.6 MHz		N/A	
				881.6 MHz+ 893.8 MHz		N/A	
2.5	2.1053, 22.917(a)	4.5	Radiated Spurious Emissions	869.2 MHz		N/A	
				881.6 MHz		N/A	
				893.8 MHz		N/A	
				869.4 MHz		N/A	
				893.6 MHz		N/A	
				869.2 MHz+ 881.6 MHz	0	Pass	
				881.6 MHz+ 893.8 MHz	0	Pass	
2.6	2.1051, 22.917(a)	4.5	Conducted Spurious Emissions	869.2 MHz		N/A	
				881.6 MHz		N/A	
				893.8 MHz		N/A	
				869.4 MHz		N/A	
				893.6 MHz		N/A	
				869.2 MHz+ 881.6 MHz	0	Pass	
				881.6 MHz+ 893.8 MHz	0	Pass	
2.7	2.1055, 22.355	4.3	Frequency Stability Under Temperature Variations	869.2 MHz		N/A	
				881.6 MHz		N/A	
				893.8 MHz		N/A	
				869.4 MHz		N/A	
				893.6 MHz		N/A	
				869.2 MHz+ 881.6 MHz		N/A	
				881.6 MHz+ 893.8 MHz		N/A	
2.8	2.1055, 22.355	4.3	Frequency Stability Under Voltage Variations	869.2 MHz		N/A	
				881.6 MHz		N/A	
				893.8 MHz		N/A	
				869.4 MHz		N/A	
				893.6 MHz		N/A	
				869.2 MHz+ 881.6 MHz		N/A	
				881.6 MHz+ 893.8 MHz		N/A	

N/A – Not Applicable



Product Service

1.3 DECLARATION OF BUILD STATUS

MAIN EUT			
MANUFACTURING DESCRIPTION	Radio Unit		
MANUFACTURER	Ericsson AB		
PART NUMBER	KRC 161 194/1		
SERIAL NUMBER	CB4C986602		
HARDWARE VERSION	R1B		
SOFTWARE VERSION	G10A/1_R25E		
TRANSMITTER OPERATING RANGE	869.4MHz - 893.6MHz		
INTERMEDIATE FREQUENCIES	--		
ITU DESIGNATION OF EMISSION	250KGXW 250KG7W		
HIGHEST INTERNALLY GENERATED FREQUENCY	894MHz		
OUTPUT POWER (RMS) (W or dBm)	GMSK: UC: 46.0dBm	HC: 42.5dBm	TCC: 48.5dBm
	8PSK: UC: 42.7dBm	HC: 39.2dBm	TCC: 45.2dBm
OUTPUT POWER TOLERANCE	± 2dB		
FCC ID	TA8AKRC161194-1		
IC ID	287AB-AG1611941		
TECHNICAL DESCRIPTION (a brief description of the intended use and operation)	The equipment is a Radio Unit of GSM Base Stations		

Signature

Date

28 May 2010

D of B S Serial No

75909919/01

No responsibility will be accepted by TÜV Product Service as to the accuracy of the information declared in this document by the manufacturer.



1.4 PRODUCT INFORMATION

1.4.1 Technical Description

The Equipment Under Test (EUT) was an Ericsson AB RUG 11 B5 working in the public mobile service 800MHz band which provides communication connections to GSM850 network. The RUG 11 B5 operates from a -48V volt supply.

The Equipment Under Test (EUT) is shown in the photograph below. A full technical description can be found in the Manufacturers documentation.



Equipment Under Test



Product Service

1.4.2 Test Configuration

Configuration 1 – UC (Hybrid Uncombined): Output 1 without internal combiner

The EUT was configured in accordance with FCC CFR 47 Part 22 and Industry Canada RSS-132.

Configuration 2 – TCC (Transmitter Coherent Combining): Output 1 with internal combiner plus TCC

The EUT was configured in accordance with FCC CFR 47 Part 22 and Industry Canada RSS-132.

Configuration 3 – HC (Hybrid combined): Output 1 with internal combiner

The EUT was configured in accordance with FCC CFR 47 Part 22 and Industry Canada RSS-132.

The RUG 11 B5 supports both GMSK and 8PSK modulation at 850MHz, the unit includes a maximum of two TRX's. Testing was performed on one TRX RF output connector. The complete testing was performed with both modulation schemes at maximum RF power unless otherwise stated. The EUT was powered by a -48V DC Power supply.



Test Setup, Radiated Measurement:

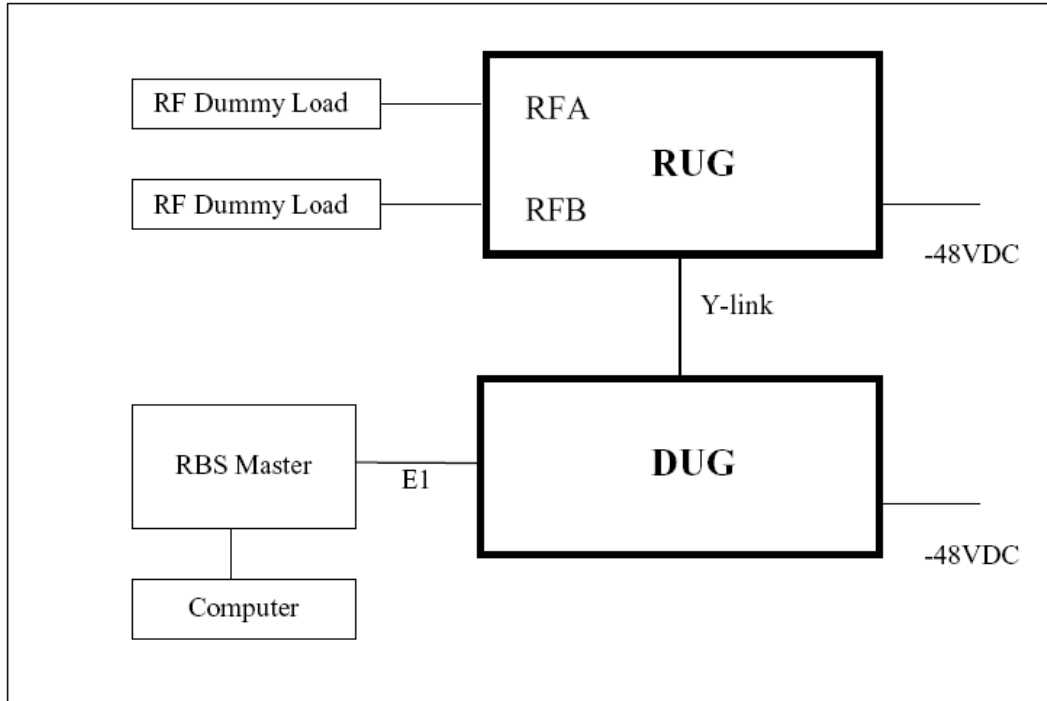

Test Object	Model Type	Version	Serial Number
RUG 11 B5	KRC 161 194/1	R1B	CB4C986602

Auxiliary Equipment	Model Type	Version	Serial Number
Computer	HP NC6400	--	--
DUG 10 01	KDU 137 597/1	R1G	CB4C823749
RBS Master 2	LPY 107 1007/1	R1D/B	05W42



Product Service

1.4.3 Modes of Operation

Modes of operation of each EUT during testing were as follows:

Mode 1 - ARFCN 128: 869.2 MHz (Bottom Channel)

Mode 2 - ARFCN 190: 881.6 MHz (Middle Channel)

Mode 3 - ARFCN 251: 893.8 MHz (Top Channel)

Mode 4 - ARFCN 129: 869.4 MHz

Mode 5 - ARFCN 250: 893.6 MHz

Mode 6 - ARFCN 128 + 190: 869.2 MHz + 881.6 MHz (Bottom Channel + Middle Channel)

Mode 7 - ARFCN 190 + 251: 881.6 MHz + 893.8 MHz (Middle Channel + Top Channel)

Information on the specific test modes utilised are detailed in the test procedure for each individual test.



Product Service

1.5 TEST CONDITIONS

For all tests the EUT was set up in accordance with the relevant test standard and to represent typical operating conditions. Tests were applied with the EUT situated in a shielded enclosure, test laboratories or a chamber as appropriate.

The EUT was powered from a -48 V DC supply.

1.6 DEVIATIONS FROM THE STANDARD

No deviations from the applicable test standards or test plan were made during testing.

1.7 MODIFICATION RECORD

No modifications were made to the EUT during testing.

1.8 ALTERNATIVE TEST SITE

Testing has been performed under the following site registrations:

FCC Accreditation 910917:

The State Radio Monitoring Centre, No.80 Beilishi Road Xicheng District Beijing, China.

Industry Canada Accreditation 7308A:

The State Radio Monitoring Centre, No.80 Beilishi Road Xicheng District Beijing, China.



Product Service

SECTION 2

TEST DETAILS

FCC and Industry Canada Testing of the
Ericsson AB
RUG 11 B5



Product Service

2.1 MAXIMUM PEAK OUTPUT POWER - CONDUCTED

2.1.1 Specification Reference

FCC CFR 47 Part 22, Clause 22.913(a)
Industry Canada RSS-132, Clause 4.4

2.1.2 Equipment Under Test

RUG 11 B5, S/N: CB4C986602

2.1.3 Date of Test and Modification State

17 May and 17 June 2010 – Modification State 0

2.1.4 Test Equipment Used

The major items of test equipment used for the above tests are identified in Section 3.1.

2.1.5 Test Method and Operating Modes

The test was applied in accordance with the test method requirements of FCC CFR 47 Part 22 and Industry Canada RSS-132.

Using a spectrum analyzer/power metre and attenuator(s), the output power of the EUT was measured at the antenna terminals. The EUT supports GMSK and 8PSK modulation schemes. The carrier power was measured with both modulations and all of the timeslots working.

The spectrum analyzer RBW and VBW were set to 1MHz and the path loss measured and entered as a reference level offset.

The test was performed with the EUT in the following configurations and modes of operation:

- Configuration 1 - Mode 1
 - Mode 2
 - Mode 3
- Configuration 2 - Mode 1
 - Mode 2
 - Mode 3
- Configuration 3 - Mode 1
 - Mode 2
 - Mode 3

2.1.6 Environmental Conditions

	17 May 2010	17 June 2010
Ambient Temperature	25.3°C	27.4°C
Relative Humidity	37.7%	39.8%



2.1.7 Test Results

For the period of test the EUT met the requirements of FCC CFR 47 Part 22 and Industry Canada RSS-132 for Maximum Peak Output Power.

The test results are shown below

GMSK

Configuration 1 - Mode 1, 2 and 3

Channel	Frequency (MHz)	Path Loss (dB)	Result (dBm) Peak / RMS	Result (W) Peak / RMS
Bottom	869.2	40.9	46.32 / 46.00	42.85 / 39.81
Middle	881.6	40.9	46.51 / 46.13	44.77 / 41.02
Top	893.8	40.9	46.52 / 46.08	44.87 / 40.55

Configuration 2 - Mode 1, 2 and 3

Channel	Frequency (MHz)	Path Loss (dB)	Result (dBm) Peak / RMS	Result (W) Peak / RMS
Bottom	869.2	40.9	49.15 / 48.63	82.22 / 72.95
Middle	881.6	40.9	49.21 / 48.70	83.37 / 74.13
Top	893.8	40.9	49.21 / 48.72	83.37 / 74.47

Configuration 3 - Mode 1, 2 and 3

Channel	Frequency (MHz)	Path Loss (dB)	Result (dBm) Peak / RMS	Result (W) Peak / RMS
Bottom	869.2	40.9	43.22 / 42.75	20.99 / 18.84
Middle	881.6	40.9	42.92 / 42.85	19.59 / 19.28
Top	893.8	40.9	43.00 / 42.87	19.95 / 19.36

**8PSK****Configuration 1 - Mode 1, 2 and 3**

Channel	Frequency (MHz)	Path Loss (dB)	Result (dBm) Peak / RMS	Result (W) Peak / RMS
Bottom	869.2	40.9	46.31 / 42.60	42.76 / 18.20
Middle	881.6	40.9	46.43 / 42.70	43.95 / 18.62
Top	893.8	40.9	46.52 / 42.60	44.87 / 18.20

Configuration 2 - Mode 1, 2 and 3

Channel	Frequency (MHz)	Path Loss (dB)	Result (dBm) Peak / RMS	Result (W) Peak / RMS
Bottom	869.2	40.9	49.09 / 45.41	81.09 / 34.75
Middle	881.6	40.9	49.10 / 45.53	81.28 / 35.73
Top	893.8	40.9	49.11 / 45.42	81.47 / 34.83

Configuration 3 - Mode 1, 2 and 3

Channel	Frequency (MHz)	Path Loss (dB)	Result (dBm) Peak / RMS	Result (W) Peak / RMS
Bottom	869.2	40.9	43.18 / 39.43	20.80 / 8.77
Middle	881.6	40.9	42.85 / 39.51	19.28 / 8.93
Top	893.8	40.9	42.98 / 39.50	19.86 / 8.91

Limit	≤500W or <+57dBm
-------	------------------

Remarks

The EUT does not exceed 500W or +57dBm at the measured frequencies.



Product Service

2.2 MODULATION CHARACTERISTICS

2.2.1 Specification Reference

FCC CFR 47 Part 2, Clause 2.1047(d)
Industry Canada RSS-132, Clause 4.2

2.2.2 Date of Test and Modification State

18 May 2010 – Modification State 0

2.2.3 Test Equipment Used

The major items of test equipment used for the above tests are identified in Section 3.1.

2.2.4 Test Method and Operating Modes

The test was applied in accordance with the test method requirements of FCC CFR 47 Part 2 and Industry Canada RSS-132.

Configuration 1 - Mode 1
- Mode 3

2.2.5 Modulation Description

The modulation scheme used in GSM is called Gaussian Minimum Shift Keying (GMSK). GMSK facilitates the use of narrow bandwidth and allows for both coherent and non coherent detection capabilities. It is a scheme in which the transitions from One to Zero or Zero to One do not occur quickly, but over a period of time. If pulses are transmitted quickly harmonics are transmitted. The power spectrum for a square wave is rich in harmonics, and the power within the side lobes is wasted, and can be a cause of potential interference.

A method to reduce the harmonics is to round off the edges of the pulses thus lowering the spectral components of the signal. In GSM this is done by using a Gaussian pre-filter which typically has a bandwidth of 81.25kHz. The output from the Gaussian filter then phase modulates the carrier. As there are no dramatic phase transitions of the carrier this gives a constant envelope and low spectral component output from the transmitter.

The spectral efficiency is calculated by

$\text{bit rate} / \text{Channel bandwidth} = 270.83333 \text{ kbit/s} / 200 \text{ kHz} = 1.354 \text{ bit/s/Hz}$.

The bandwidth product $BT = \text{Bandwidth} \times \text{bit duration} = 81.25 \text{ kHz} \times 3.6923 \text{ micros} = 0.3$

GMSK and 8PSK overview.

The modulation schemes used for the EUT are GMSK and 8PSK. The 8PSK modulation scheme is EDGE (Enhanced Data Rates for GSM Evolution).

A brief overview of how GMSK and 8PSK works is shown below.



GMSK (Gaussian Minimum Shift Keying)

The fundamental principal behind GMSK is Phase shift keying. This splits a data stream into a series of 2-digit phase shifts, using the following phase shifts to represent data pairs.

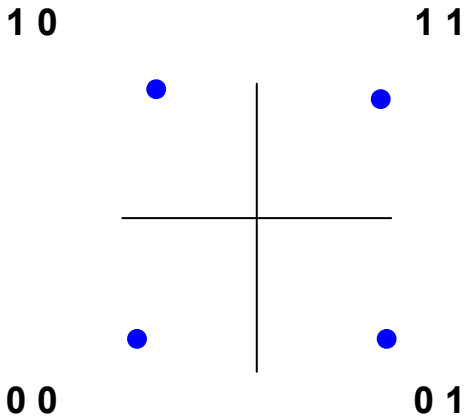

Therefore for the BIT sequence 0 0 1 1 1 0 0 1 The corresponding phase shift will be used

BIT SEQUENCE	0 0	1 1	1 0	0 1
PHASE	225°	45°	135°	315°

This is called QPSK (Quadratic Phase Shift Keying)

However

There is a problem with QPSK: transition from e.g. 00 to 11 gives phase shift of 180° (π radians). This has the effect of inverting the carrier waveform and this can lead to detection errors at the receiver.

Solution: restrict phase changes to $\pm 90^\circ$

1. Split bit stream into 2 streams e.g.

	0 0		1 1		0 1		1 0	
I Stream	0		1		0		1	
Q stream		0		1		1		0

2. Modulate each stream with PSK (1 = 90° or $\pi/2$, 0 = -90° or $-\pi/2$ phase shift)

I Stream	0		1		0		1	
	$-\pi/2$		$-\pi/2$		$-\pi/2$		$\pi/2$	
Q stream		0		1		1		0
		$-\pi/2$		$\pi/2$		$\pi/2$		$-\pi/2$



3. Combine (add) the two PSK signals:

Combined Phase	$-\pi/2$	$-\pi$	$-\pi/2$	0	$-\pi/2$	0	$\pi/2$	0
----------------	----------	--------	----------	---	----------	---	---------	---

Result: offset - QPSK, phase change is restricted to $\pm \pi/2$ radians:

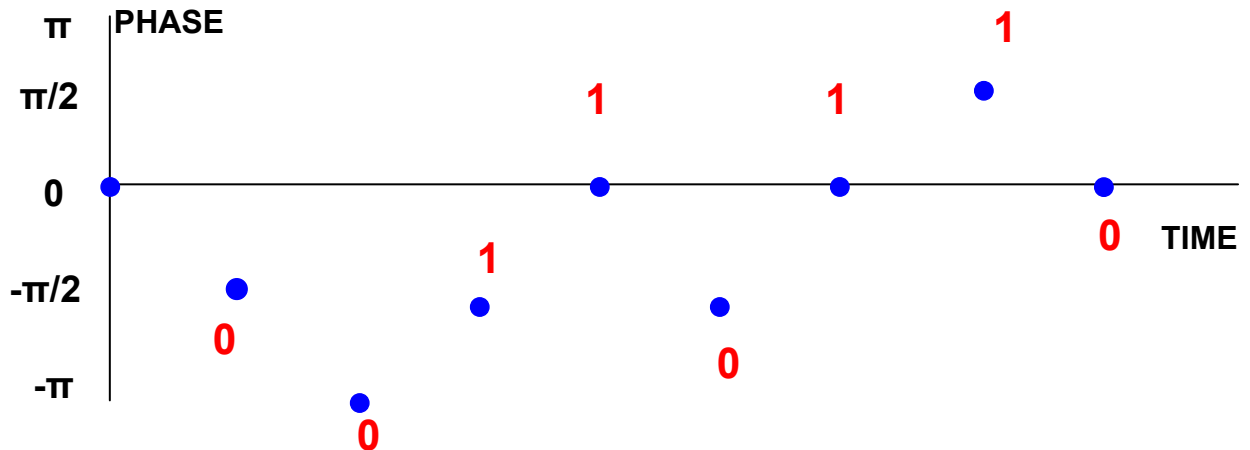

It would be preferable to have "gradual" changes in phase between each pair of bits (Continuous-phase modulation). Replacing each "rectangular" shaped pulse (for 1 or 0) with a sinusoidal pulse can do this:

Result: Minimum Shift Keying (MSK):

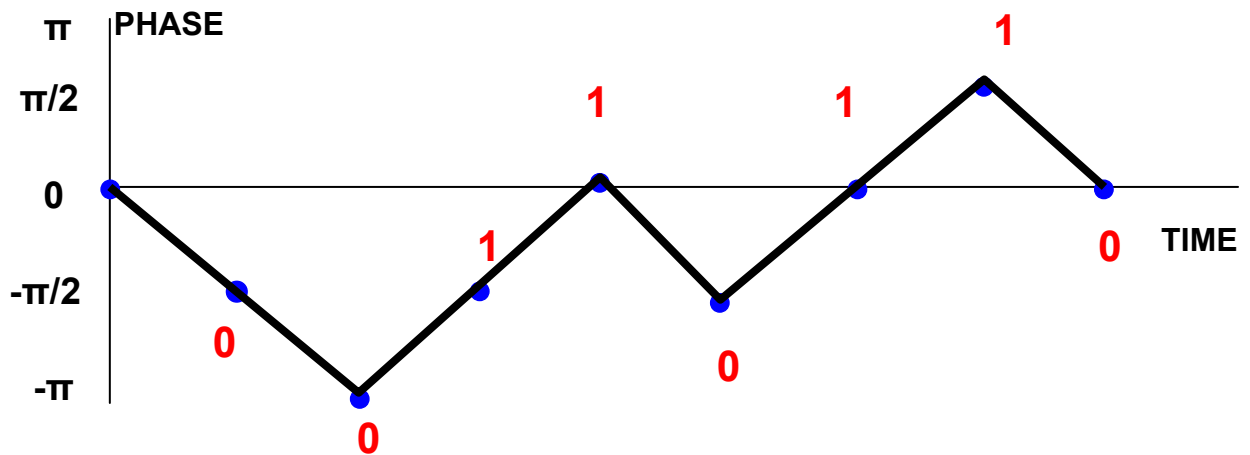



Gaussian Minimum Shift Keying

MSK has high sidebands relative to the main lobes in the frequency domain - this can lead to interference with adjacent signals.

If the rectangular pulses corresponding to the bit stream are filtering using a Gaussian-shaped impulse response filter, we get Gaussian MSK (GMSK) - this has low side lobes compared to MSK.

8-PSK (8-Phase Shift Keying)

8PSK uses the same basic principle of phase shift modulation. The only difference being the increased number of vectors.

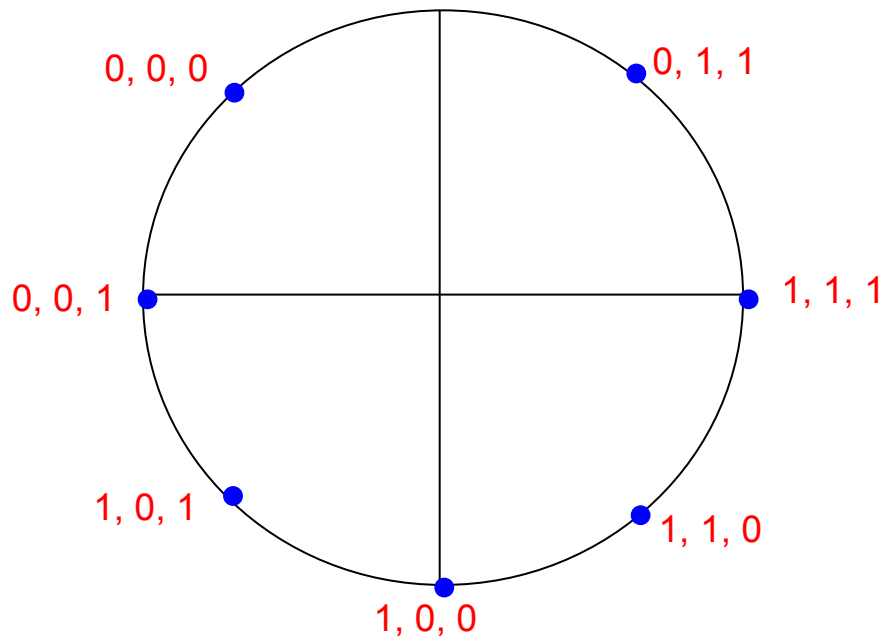



Product Service

2.3 OCCUPIED BANDWIDTH

2.3.1 Specification Reference

FCC CFR 47 Part 2, Clause 2.1049(h)
 FCC CFR 47 Part 22, Clause 22.917(b)
 Industry Canada RSS-GEN, Clause 4.6.1

2.3.2 Equipment Under Test

RUG 11 B5, S/N: CB4C986602

2.3.3 Date of Test and Modification State

18 May and 19 June 2010 – Modification State 0

2.3.4 Test Equipment Used

The major items of test equipment used for the above tests are identified in Section 3.1.

2.3.5 Test Method and Operating Modes

The test was applied in accordance with the test method requirements of FCC CFR 47 Part 2 and Part 22 and Industry Canada RSS-GEN.

The EUT was transmitting at maximum power, modulated with all timeslots active. Using a resolution bandwidth of 10 kHz and a video bandwidth of 100 kHz. The occupied bandwidth, that is the frequency bandwidth such that, below its lower and above its upper frequency limits, the mean powers radiated are each equal to 0.5 percent of the total mean power radiated by a given emission. The -26dBc points were also established and the emission bandwidth determined.

The test was performed with the EUT in the following configurations and modes of operation:

Configuration 1 - Mode 1
 - Mode 2
 - Mode 3

2.3.6 Environmental Conditions

	18 May 2010	19 June 2010
Ambient Temperature	25.8°C	26.7°C
Relative Humidity	37.6%	38.2%



Product Service

2.3.7 Test Results

For the period of test the EUT met the requirements of FCC CFR 47 Part 22 and Industry Canada RSS-132 for Occupied Bandwidth.

The test results are shown below

GMSK

Configuration 1 - Mode 1

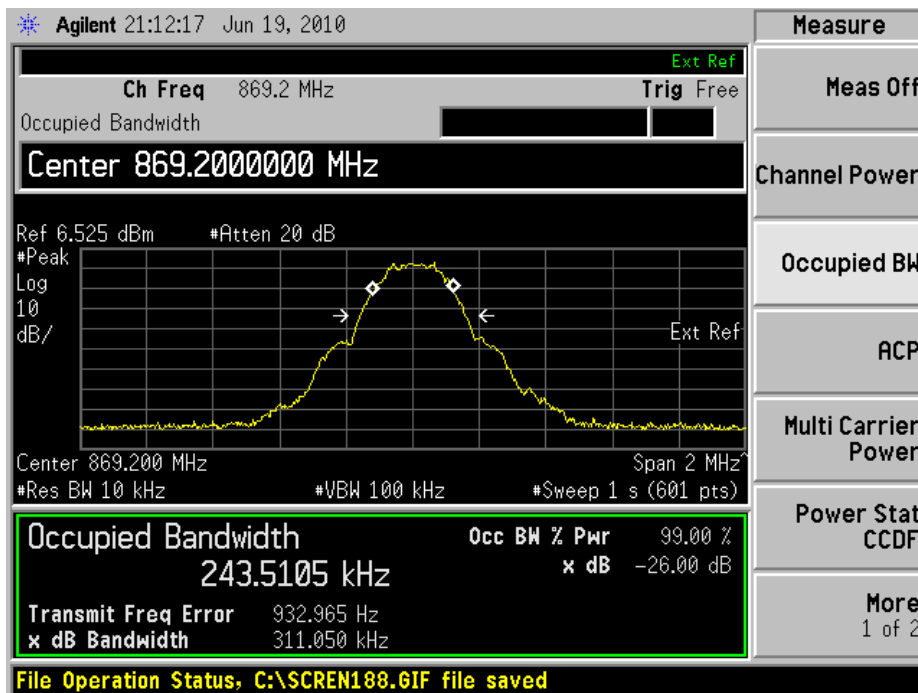



Configuration 1 - Mode 2

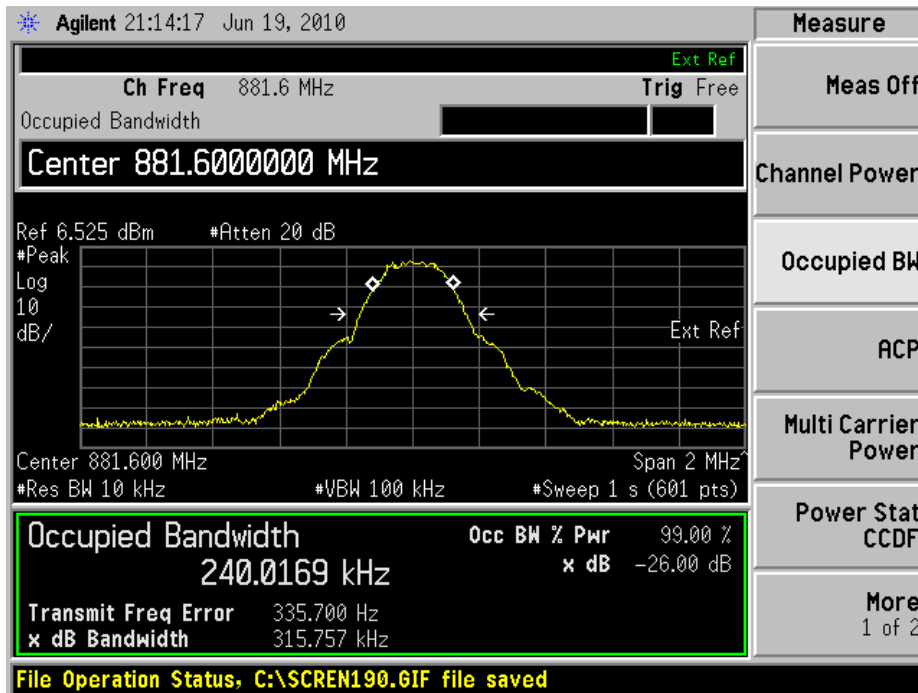

Configuration 1 - Mode 3

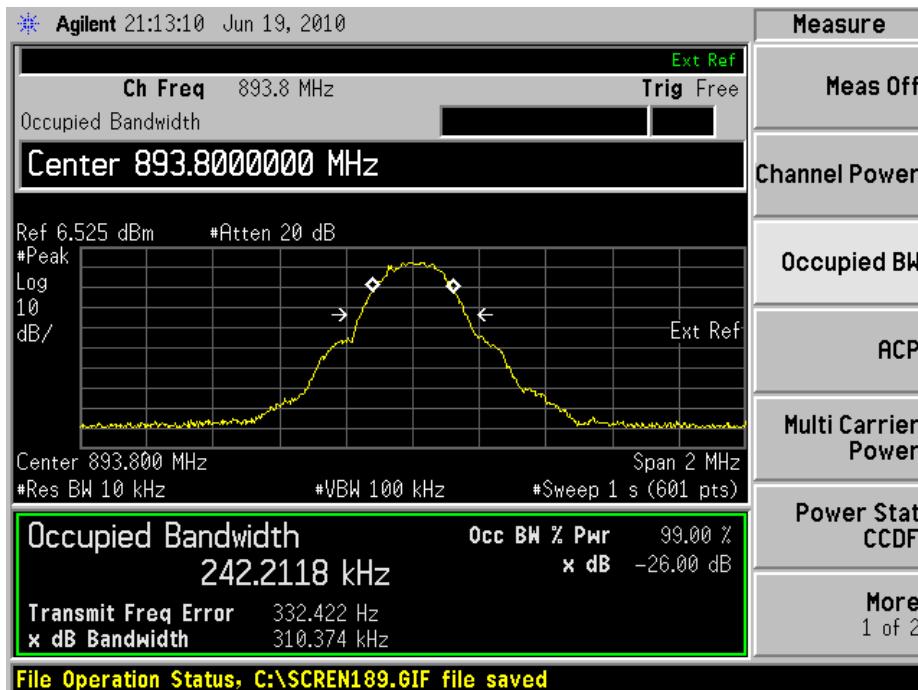



8PSK

Configuration 1 - Mode 1

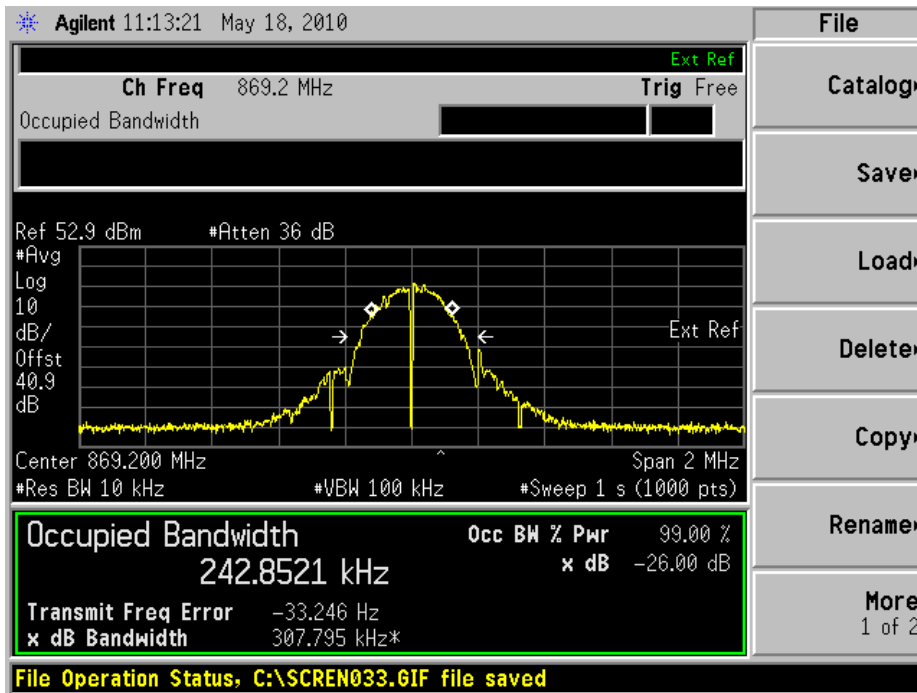

Configuration 1 - Mode 2

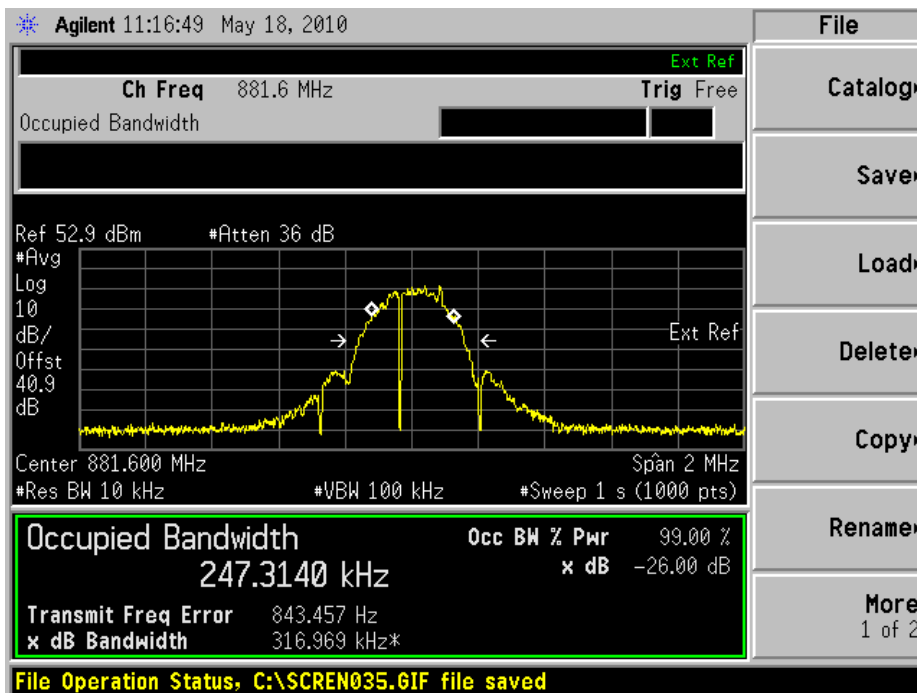



Product Service

Configuration 1 - Mode 3

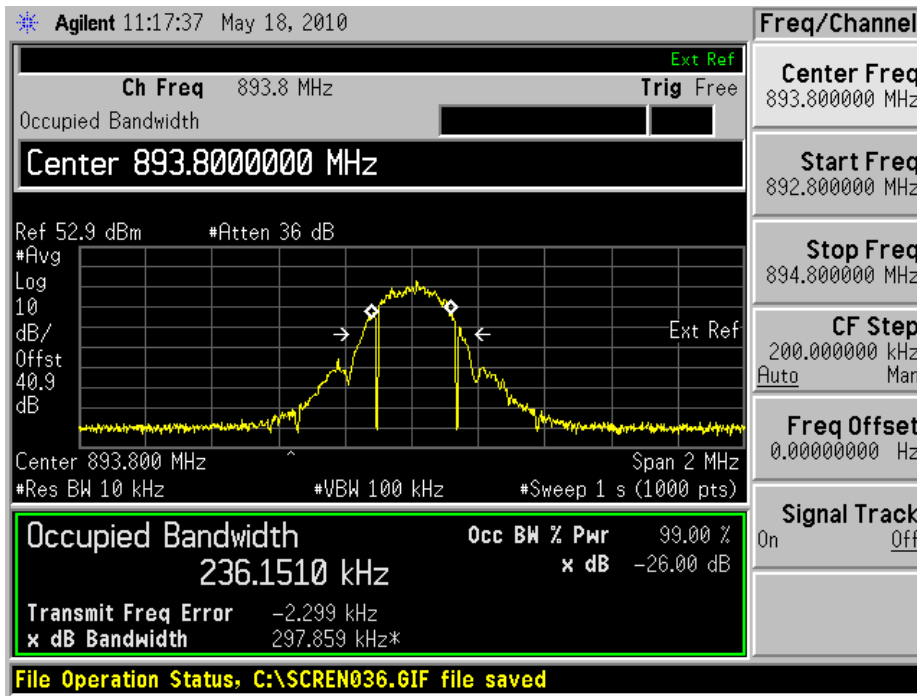



Product Service

2.4 SPURIOUS EMISSIONS AT TERMINALS (± 1 MHz)

2.4.1 Specification Reference

FCC CFR 47 Part 2, Clause 2.1051
 FCC CFR 47 Part 22, Clause 22.917(b)
 Industry Canada RSS-132 Clause 4.5

2.4.2 Equipment Under Test

RUG 11 B5, S/N: CB4C986602

2.4.3 Date of Test and Modification State

18 May and 18 June 2010 – Modification State 0

2.4.4 Test Equipment Used

The major items of test equipment used for the above tests are identified in Section 3.1.

2.4.5 Test Method and Operating Modes

The test was applied in accordance with the test method requirements of FCC CFR 47 Part 2 and Part 22 and Industry Canada RSS-132.

In accordance with 22.917(b), at least 1% of the 26dB bandwidth was used for the resolution and video bandwidths up to 1 MHz away from the block edge. At greater than 1MHz the resolution and video bandwidths were increased to 1 MHz. The spectrum analyser detector was set as RMS.

The reference power and path losses of all channels used for testing in each frequency block were measured. It was found that there was <0.5dB variation in all channels, thus the worst case reference level offset was used throughout. Having entered the reference level offset, the limit line was displayed, showing the -13 dBm.

The EUT was tested at it's maximum power level with all timeslots active.

The test was performed with the EUT in the following configurations and modes of operation:

Configuration 1 - Mode 4
 - Mode 5
 Configuration 2 - Mode 4
 - Mode 5
 Configuration 3 - Mode 4
 - Mode 5

2.4.6 Environmental Conditions

	18 May 2010	18 June 2010
Ambient Temperature	25.8°C	27.6°C
Relative Humidity	37.6%	39.9%



2.4.7 Test Results

For the period of test the EUT met the requirements of FCC CFR 47 Part 2 and Part 22 and Industry Canada RSS-132 for Spurious Emissions Antenna Terminals (± 1 MHz)

Below are the Frequencies the EUT was tested against along with the tested channels.

Remark:

The channel adjacent to the lower and higher band-edge cannot be used. The lowest usable channel is 129 (869.4MHz), the highest usable channel is 250 (893.6 MHz)

Configuration 1 - Mode 4 & 5

Channel (MHz)	Edge Test with GMSK modulation Channel No./Frequencies	Edge Test with 8PSK modulation Channel No./Frequencies
Bottom 869.4	Channel: 129 Frequency: 869MHz P0 Power level	Channel: 129 Frequency : 869MHz P0 Power level
Top 893.6	Channel: 250 Frequency : 894MHz P0 Power level	Channel : 250 Frequency: 894MHz P0 Power level

Configuration 2 - Mode 4 & 5

Channel (MHz)	Edge Test with GMSK modulation Channel No./Frequencies	Edge Test with 8PSK modulation Channel No./Frequencies
Bottom 869.4	Channel: 129 Frequency: 869MHz P0 Power level	Channel: 129 Frequency : 869MHz P0 Power level
Top 893.6	Channel: 250 Frequency : 894MHz P0 Power level	Channel : 250 Frequency: 894MHz P0 Power level

Configuration 3 - Mode 4 & 5

Channel (MHz)	Edge Test with GMSK modulation Channel No./Frequencies	Edge Test with 8PSK modulation Channel No./Frequencies
Bottom 869.4	Channel: 129 Frequency: 869MHz P0 Power level	Channel: 129 Frequency : 869MHz P0 Power level
Top 893.6	Channel: 250 Frequency : 894MHz P0 Power level	Channel : 250 Frequency: 894MHz P0 Power level

The channels shown in the table above are the minimum and maximum channels that can be used in the authorised frequency ranges to maintain compliance. Channels used outside of those stated and power levels used beyond those stated in the table exceed the specification limits, thus they cannot be used.

The channels outside of those shown in the table above were not tested at lower power levels to determine a level at which compliance would be achieved. Therefore, to maintain compliance, only the channels shown in the table above shall be used.



The test results are shown below

Configuration 1 - Mode 4

GMSK - Edge Measurement with EUT Transmitting on P0 Power Level

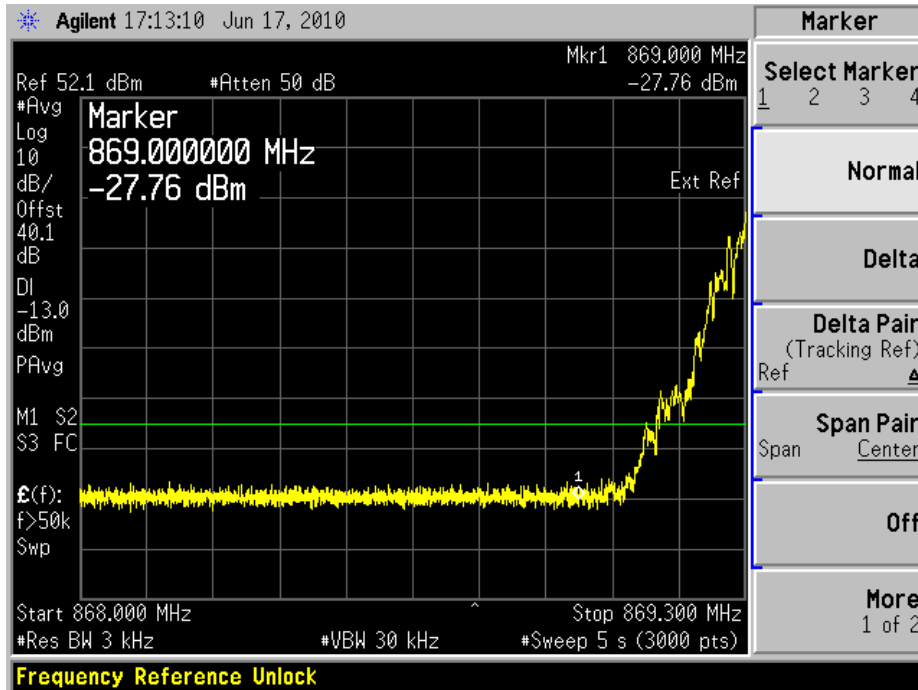

8PSK - Edge Measurement with EUT Transmitting on P0 Power Level

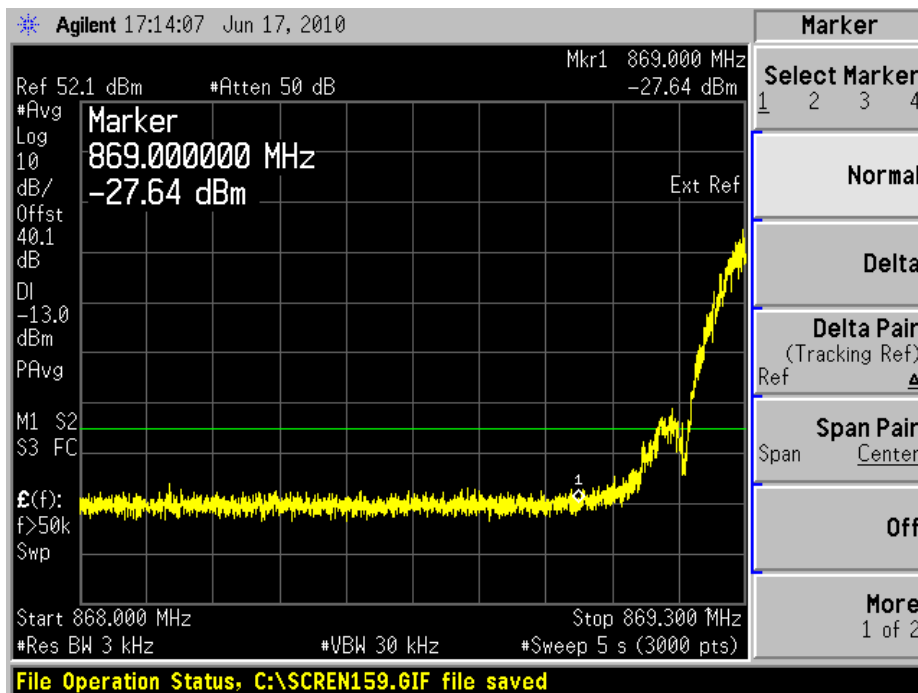



Product Service

Configuration 1 - Mode 5

GMSK - Edge Measurement with EUT Transmitting on P0 Power Level

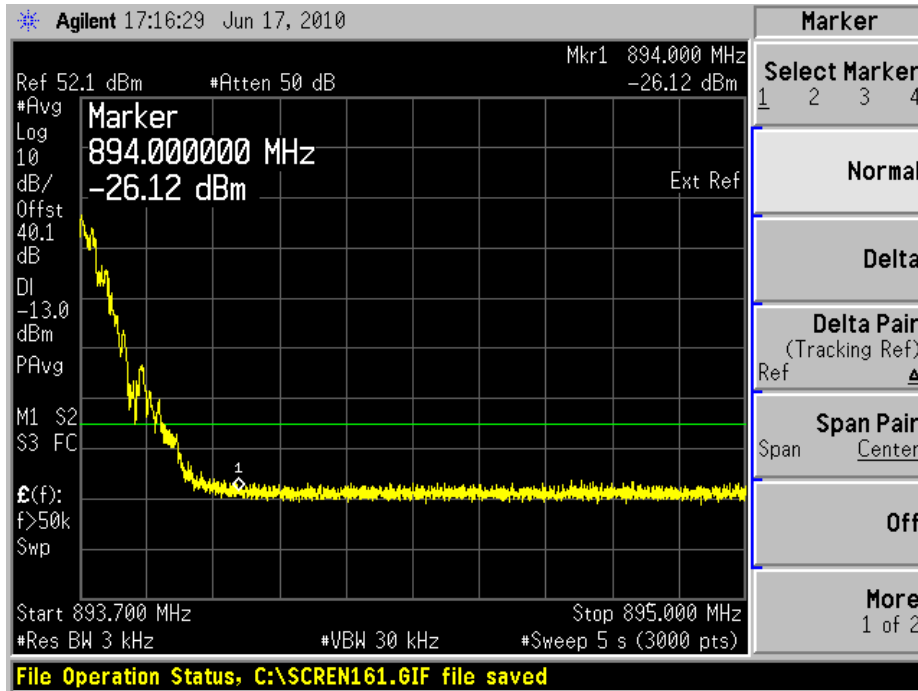

8PSK - Edge Measurement with EUT Transmitting on P0 Power Level

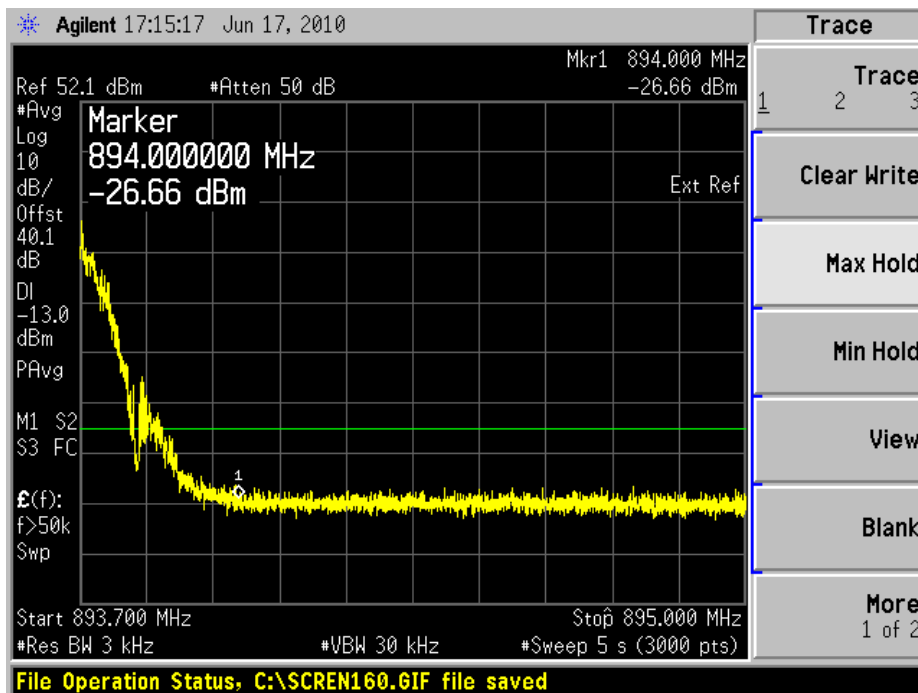



Configuration 2 - Mode 4

GMSK - Edge Measurement with EUT Transmitting on P0 Power Level

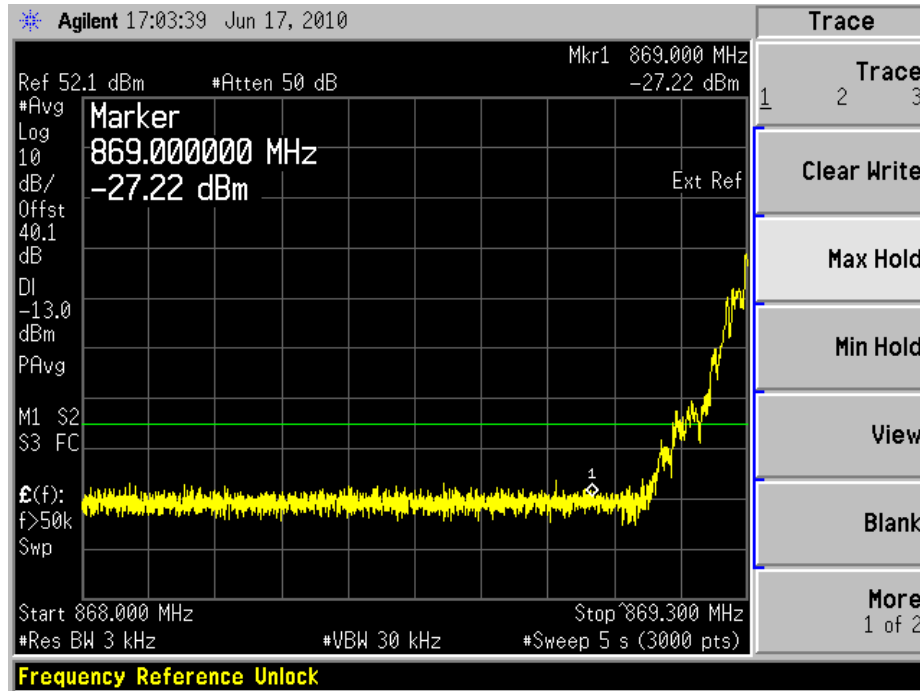

8PSK - Edge Measurement with EUT Transmitting on P0 Power Level

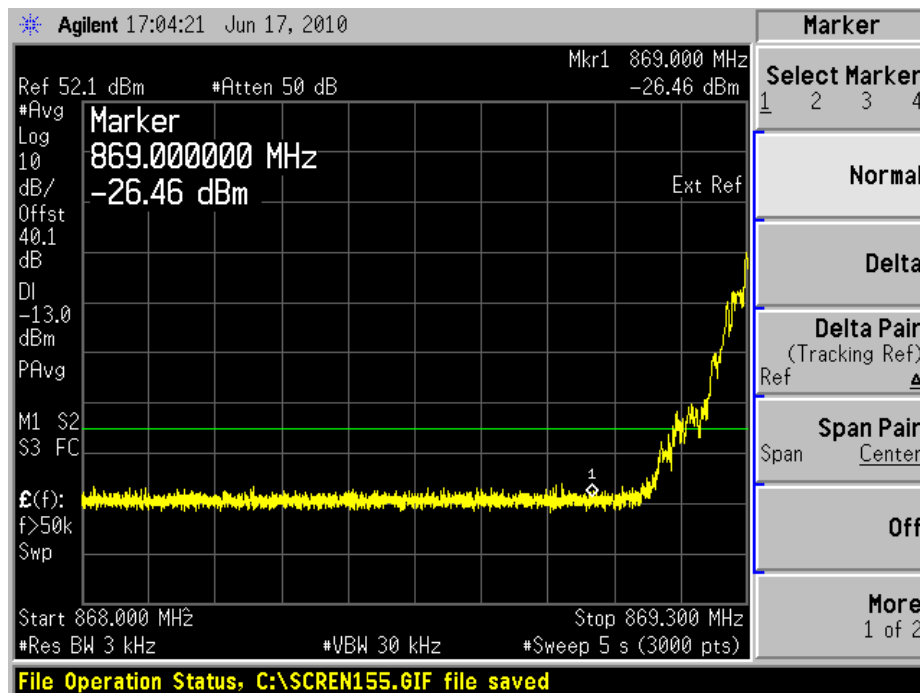



Configuration 2 - Mode 5

GMSK - Edge Measurement with EUT Transmitting on P0 Power Level

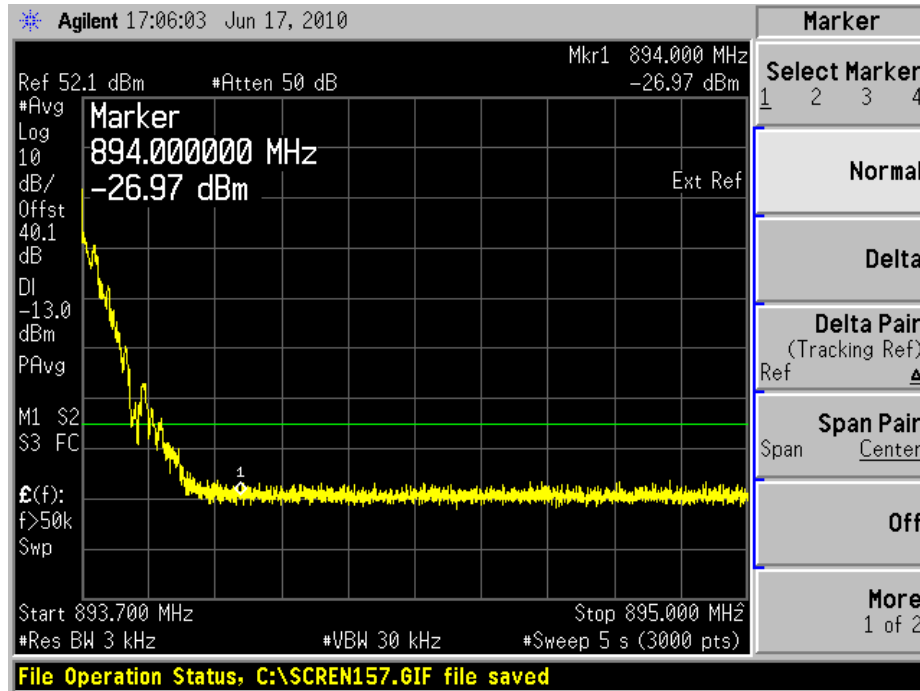

8PSK - Edge Measurement with EUT Transmitting on P0 Power Level

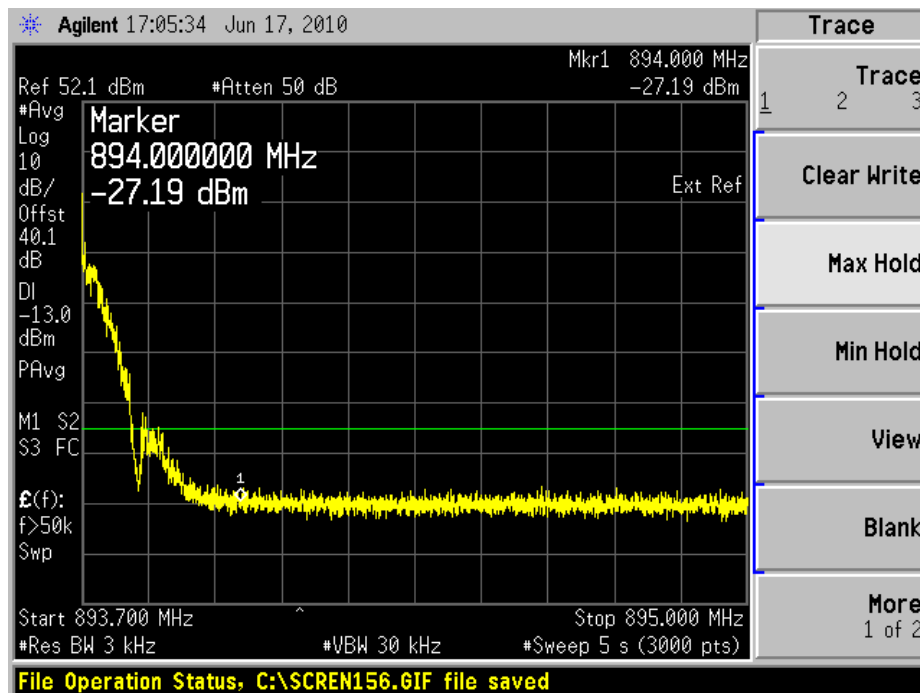



Configuration 3 - Mode 4

GMSK - Edge Measurement with EUT Transmitting on P0 Power Level

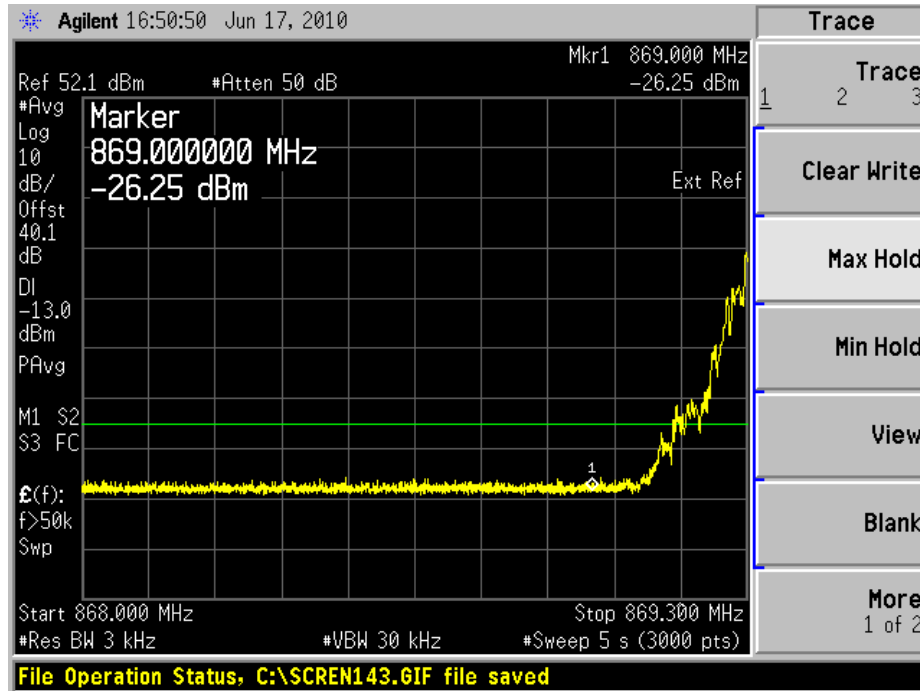

8PSK - Edge Measurement with EUT Transmitting on P0 Power Level

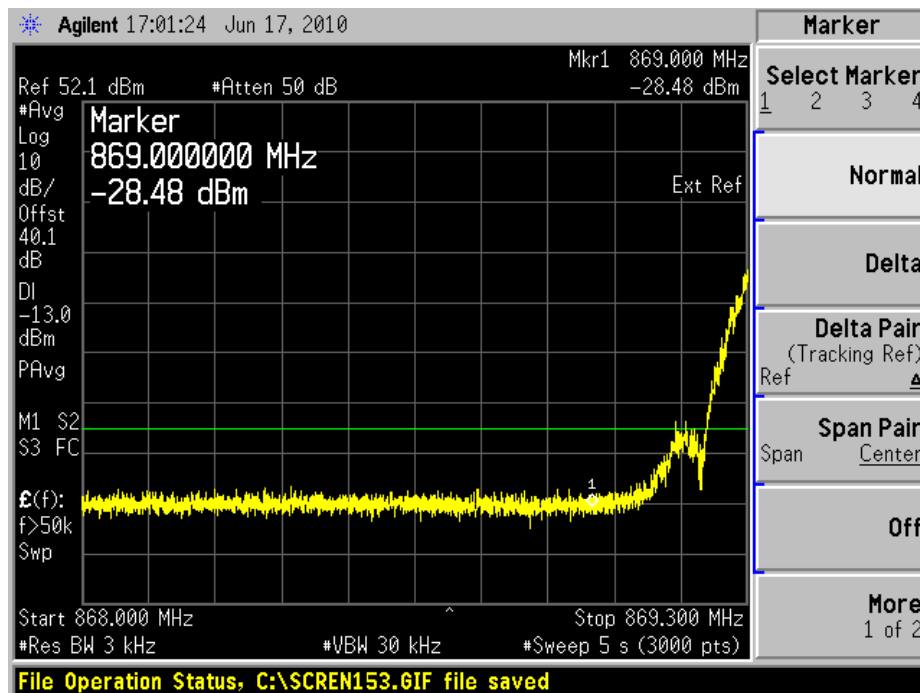



Product Service

Configuration 3 - Mode 5

GMSK - Edge Measurement with EUT Transmitting on P0 Power Level

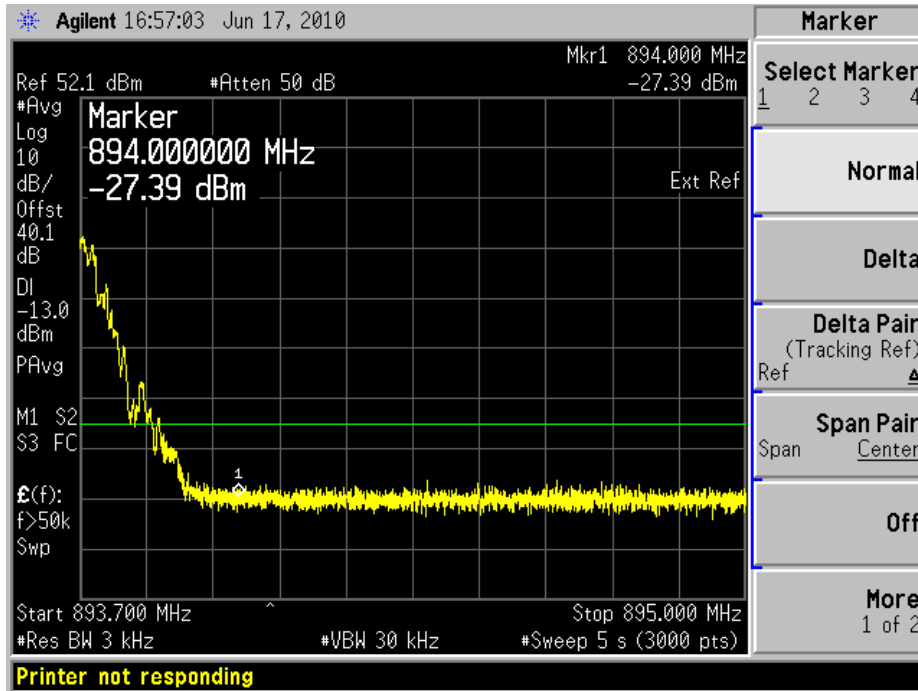

8PSK - Edge Measurement with EUT Transmitting on P0 Power Level

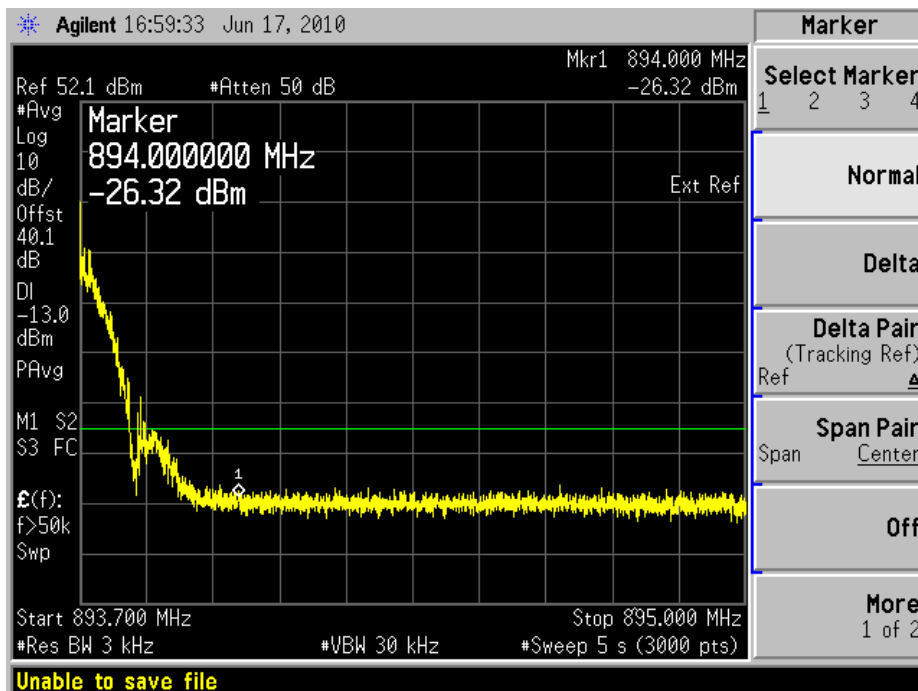

Limit	-13dBm
-------	--------



Product Service

2.5 RADIATED SPURIOUS EMISSIONS

2.5.1 Specification Reference

FCC CFR 47 Part 2: 2009, Clause 2.1053
FCC CFR 47 Part 22, 22.917(a)
Industry Canada RSS-132, Clause 4.5

2.5.2 Equipment Under Test

RUG 11 B5, S/N: CB4C986602

2.5.3 Date of Test and Modification State

21 May 2010 – Modification State 0

2.5.4 Test Equipment Used

The major items of test equipment used for the above tests are identified in Section 3.1.

2.5.5 Test Method and Operating Modes

The test was applied in accordance with the test method requirements of FCC CFR 47 Part 2 and Part 22 and Industry Canada RSS-132.

A preliminary profile of the Spurious Radiated Emissions was obtained by operating the EUT on a remotely controlled turntable within the chamber. Measurements of emissions from the EUT were obtained with the Measurement Antenna in both Horizontal and Vertical Polarisation.

Emissions identified within the range 30MHz – 1GHz were then formally measured using a Peak detector. Emissions identified within the range 1GHz – 10GHz were then formally measured using Peak and Average Detectors, as appropriate.

In the frequency Range 30MHz – 1GHz, the measurement was performed with a resolution bandwidth of 100kHz, in the frequency Range 1GHz – 10GHz, the measurement was performed with a resolution of 1MHz.

The measurements were performed at a 3m distance unless otherwise stated.

The limits was displayed, showing the -13dBm

The test was performed with the EUT operating on all modes in section 1.4.3 and record the result of the following configurations and modes of operation for worst case:

- Configuration 1 - Mode 1
 - Mode 2
 - Mode 3
- Configuration 2 - Mode 1
 - Mode 2
 - Mode 3
- Configuration 3 - Mode 6
 - Mode 7



Product Service

2.5.6 Environmental Conditions

	21 May 2010
Ambient Temperature	23.4°C
Relative Humidity	36.7%

2.5.7 Test Results

For the period of test the EUT met the requirements of FCC CFR 47 Part 2 & Part 22 and Industry Canada RSS-132 for Radiated Spurious Emissions.

The test results are shown below

GMSK

Configuration 1 - Mode 1

No emissions were detected within 35dB of the limit.

Configuration 1 - Mode 2

No emissions were detected within 35dB of the limit.

Configuration 1 - Mode 3

No emissions were detected within 35dB of the limit.



Configuration 2 - Mode 1

30MHz – 3GHz:

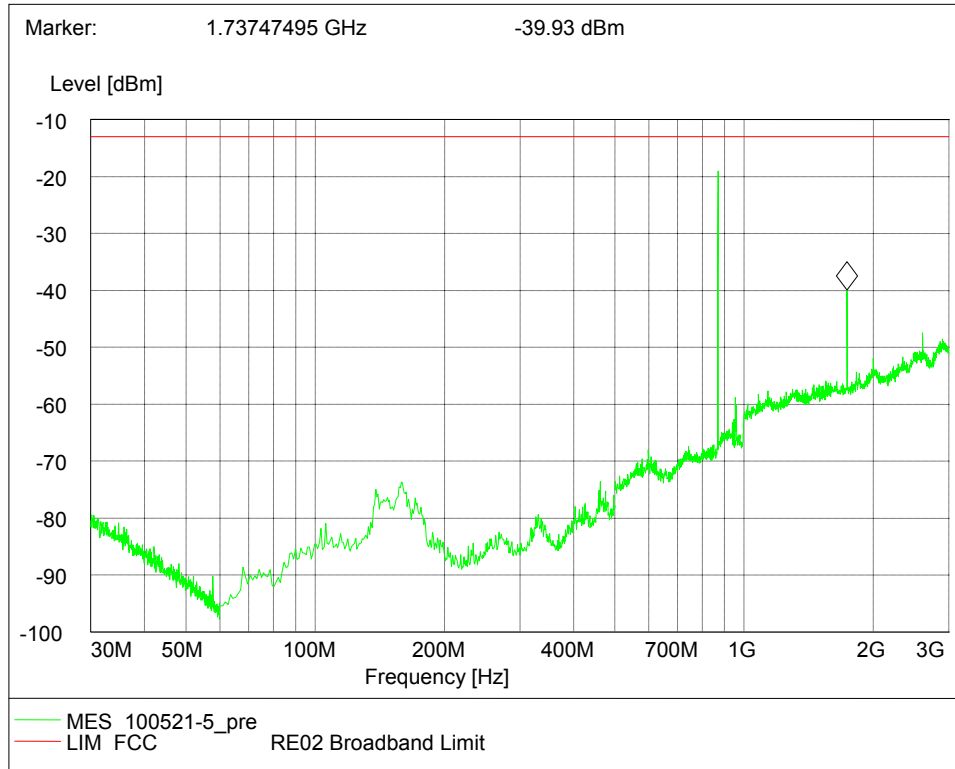

3GHz – 10GHz:

No emissions were detected within 35dB of the limit.



Configuration 2 - Mode 2

30MHz – 3GHz:

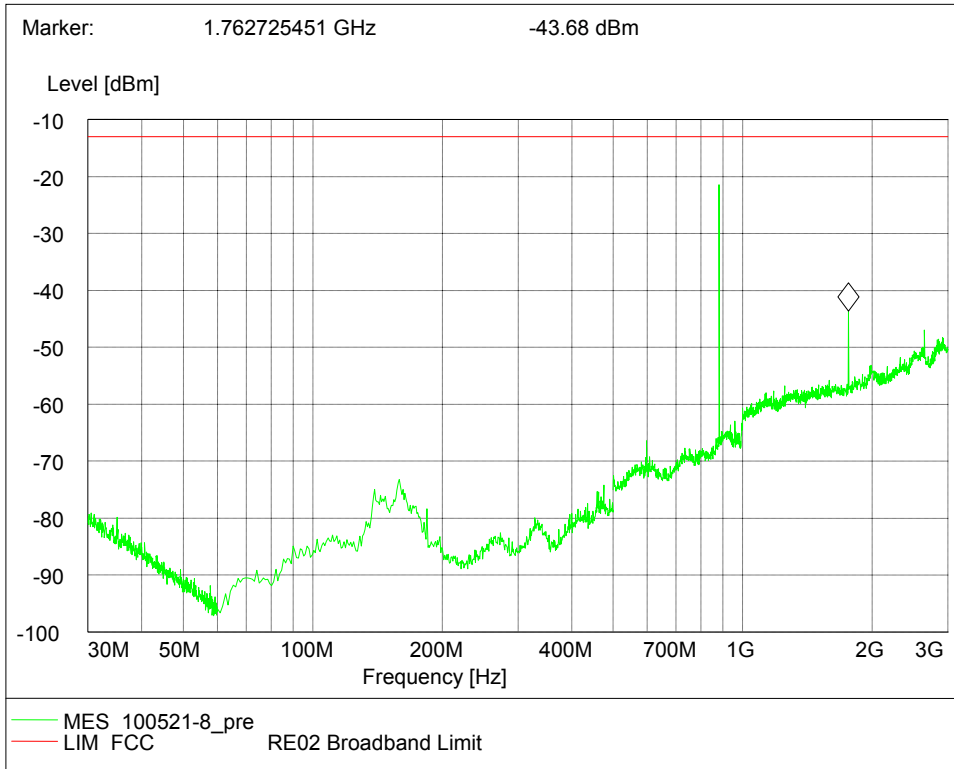

3GHz – 10GHz:

No emissions were detected within 35dB of the limit.



Configuration 2 - Mode 3

30MHz – 3GHz:

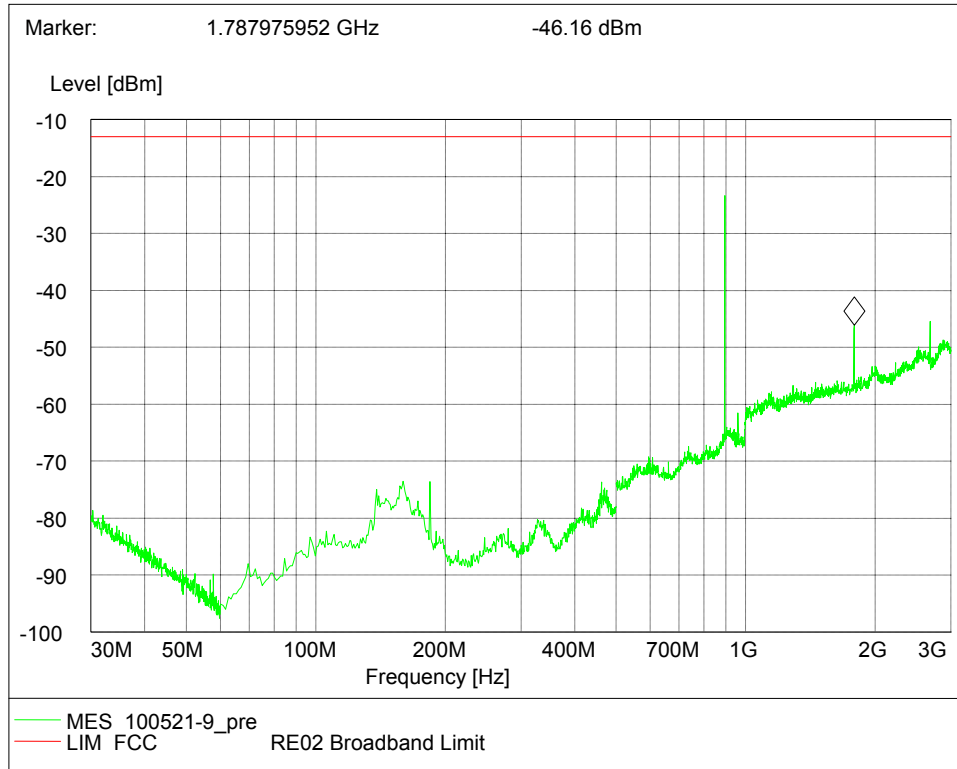

3GHz – 10GHz:

No emissions were detected within 35dB of the limit.



Configuration 3 - Mode 6

30MHz – 3GHz:

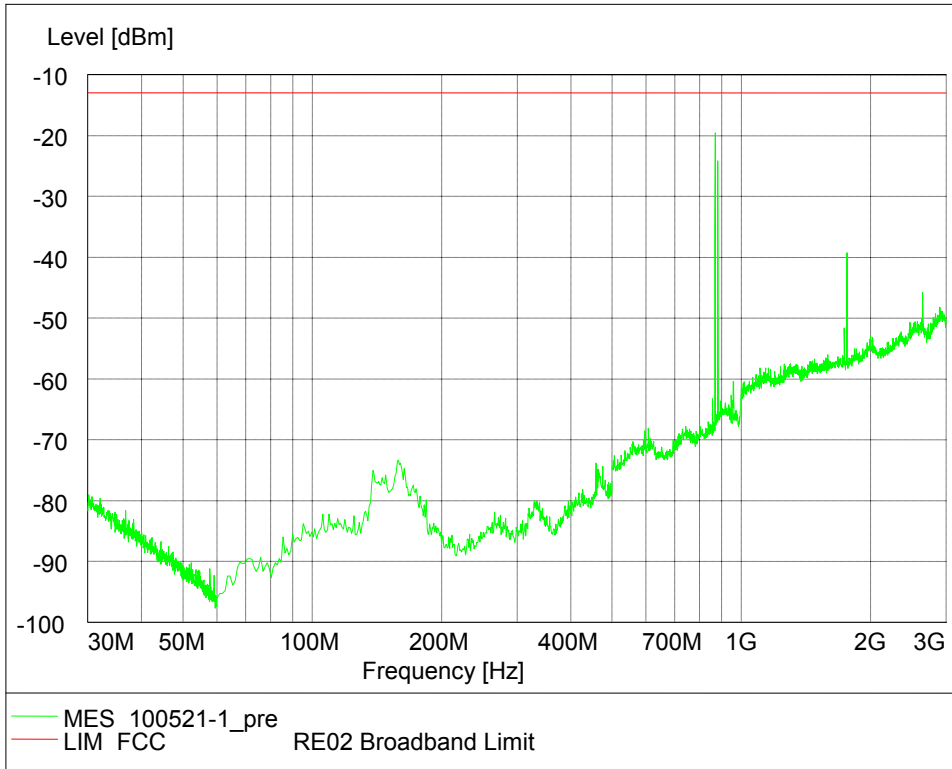

3GHz – 10GHz:

No emissions were detected within 35dB of the limit.



Configuration 3 - Mode 7

30MHz – 3GHz:

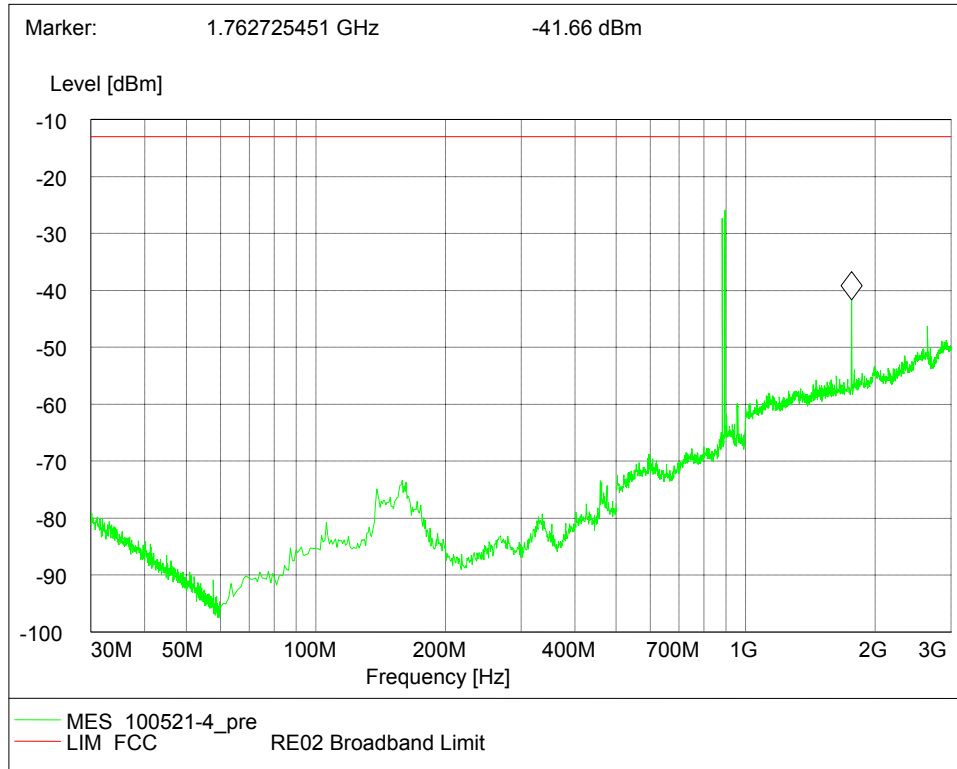

3GHz – 10GHz:

No emissions were detected within 35dB of the limit.



8PSK

Configuration 1 - Mode 1

No emissions were detected within 35dB of the limit.

Configuration 1 - Mode 2

No emissions were detected within 35dB of the limit.

Configuration 1 - Mode 3

No emissions were detected within 35dB of the limit.

Configuration 2 - Mode 1

30MHz – 3GHz:

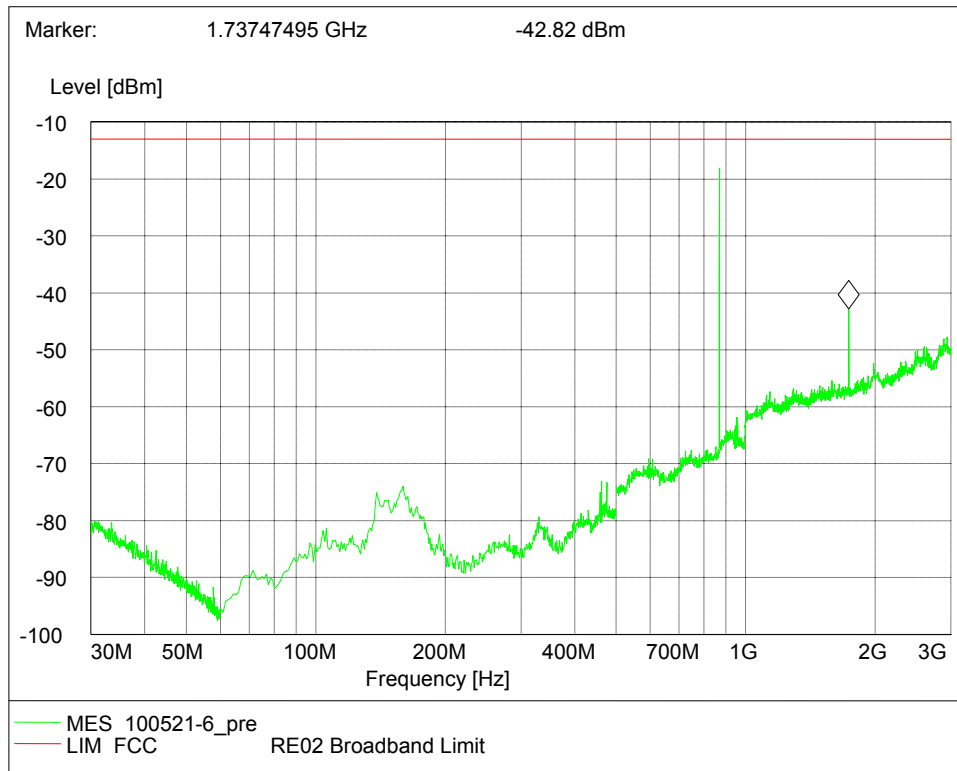

3GHz – 10GHz:

No emissions were detected within 35dB of the limit.



Configuration 2 - Mode 2

30MHz – 3GHz:

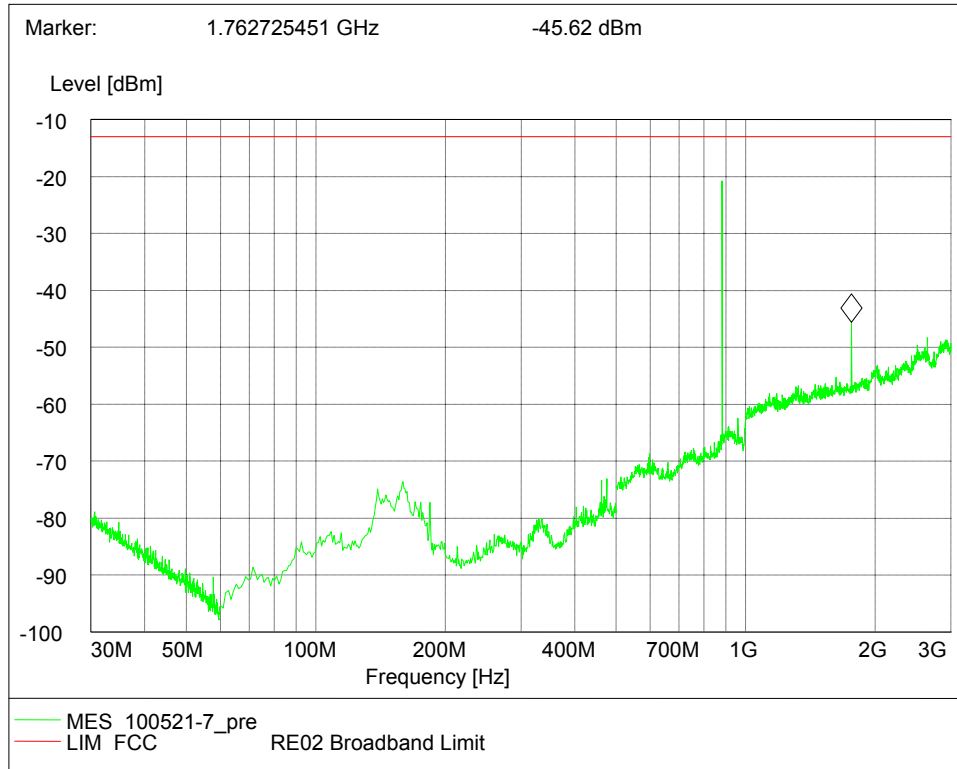

3GHz – 10GHz:

No emissions were detected within 35dB of the limit.



Configuration 2 - Mode 3

30MHz – 3GHz:

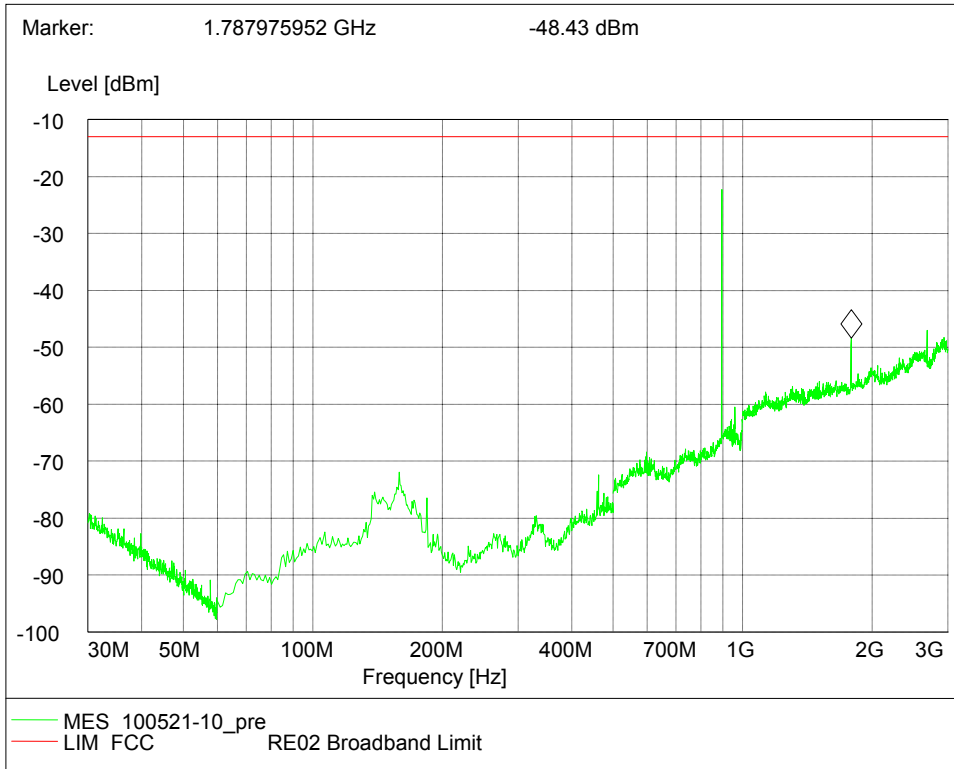

3GHz – 10GHz:

No emissions were detected within 35dB of the limit.



Configuration 3 - Mode 6

30MHz – 3GHz:

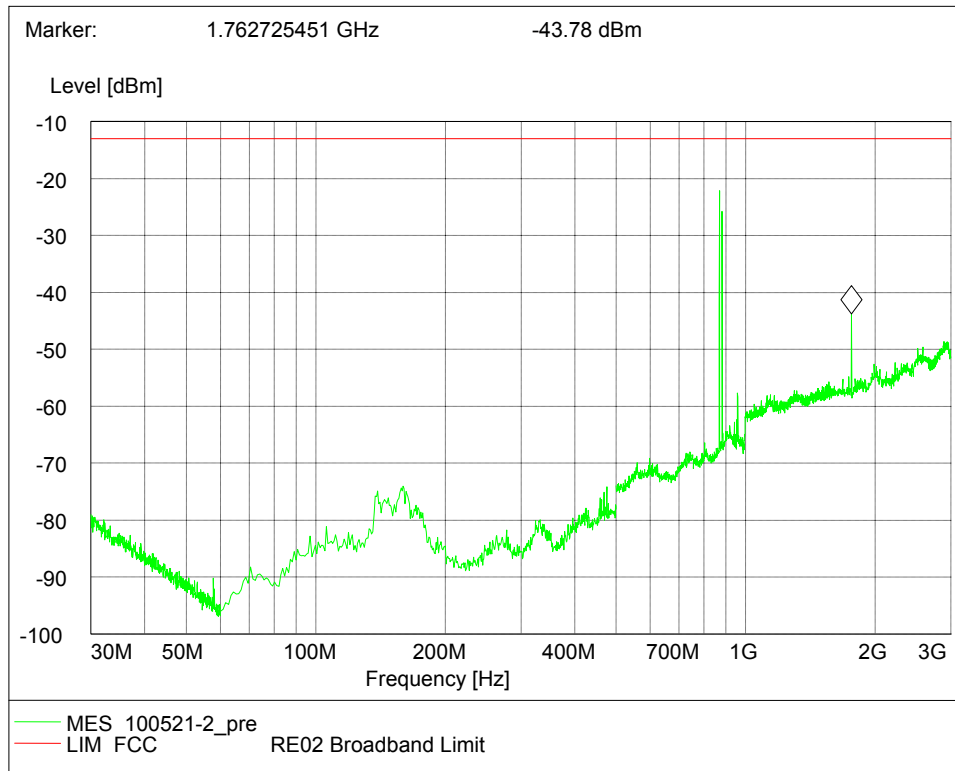

3GHz – 10GHz:

No emissions were detected within 35dB of the limit.



Configuration 3 - Mode 7

30MHz – 3GHz:

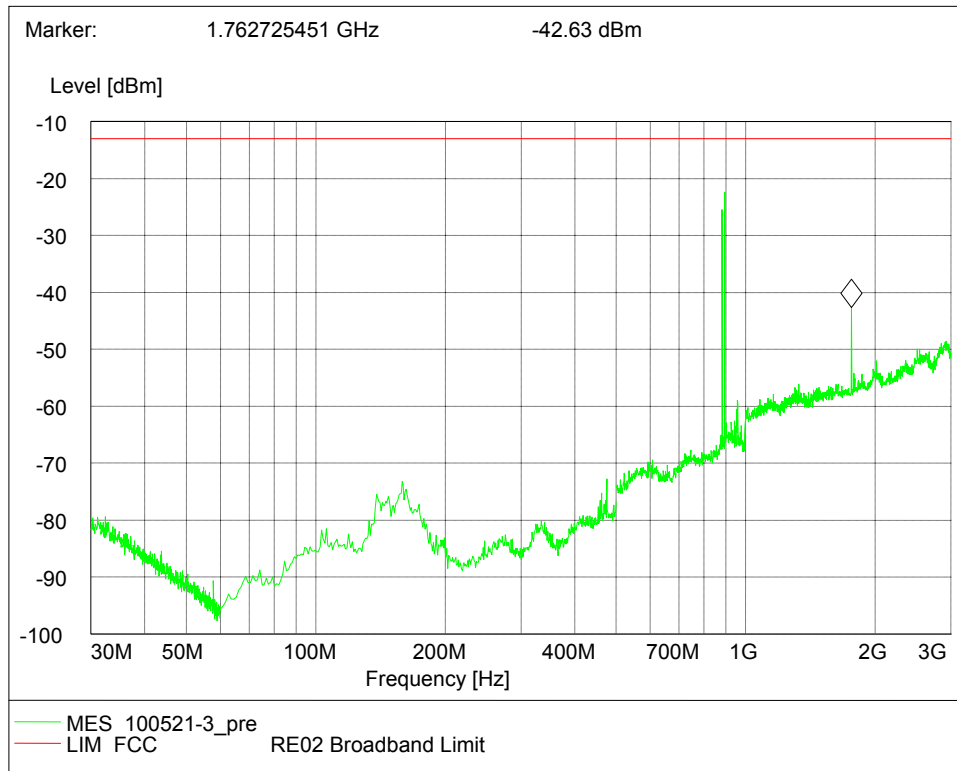

3GHz – 10GHz:

No emissions were detected within 35dB of the limit.

Limit	-13dBm
-------	--------

Remarks

The EUT does not exceed -13dBm at the measured frequencies.



Product Service

2.6 CONDUCTED SPURIOUS EMISSIONS

2.6.1 Specification Reference

FCC CFR 47 Part 2: 2009, Clause 2.1051
FCC CFR 47 Part 22, 22.917(a)
Industry Canada RSS-132, Clause 4.5

2.6.2 Equipment Under Test

RUG 11 B5, S/N: CB4C986602

2.6.3 Date of Test and Modification State

18 and 19 and 20 May 2010 – Modification State 0

2.6.4 Test Equipment Used

The major items of test equipment used for the above tests are identified in Section 3.1.

2.6.5 Test Method and Operating Modes

The test was applied in accordance with the test method requirements of FCC CFR 47 Part 2 and Part 22 and Industry Canada RSS-132.

In accordance with Part 2.1051, the spurious emissions from the antenna terminal were measured. The transmitter output power was attenuated using a combination of a filter and attenuators and the frequency spectrum investigated from 9kHz to 9GHz. The EUT was set to transmit on maximum power. The EUT was tested on Bottom, Middle and Top channels for both modulation types. The resolution was set to 100kHz for 9kHz to 1GHz and 1MHz for 1GHz to 9GHz thus meeting the requirements of Part 22.917(b). The spectrum analyser detector was set to Max Hold.

The maximum path loss across the measurement band was used as the reference level offset to ensure worst case.

In addition, measurements were made up to the 10th harmonic of the fundamental.

The test was performed with the EUT in the following configurations and modes of operation:

- Configuration 1 - Mode 1
 - Mode 2
 - Mode 3
- Configuration 2 - Mode 1
 - Mode 2
 - Mode 3
- Configuration 3 - Mode 6
 - Mode 7



Product Service

2.6.6 Environmental Conditions

	18 May 2010	19 May 2010	20 May 2010
Ambient Temperature	25.8°C	25.0°C	25.2°C
Relative Humidity	37.6%	37.1%	37.9%

2.6.7 Test Results

For the period of test the EUT met the requirements of FCC CFR 47 Part 2 and Part 22 and Industry Canada RSS-132 for Radiated Spurious Emissions.

The test results are shown below

Remark:

The emissions at 9kHz on the plots was not generated by the test object. A complementary measruement with a smaller RBW showed that it was related to the LO feedthrough.



GMSK

Configuration 1 - Mode 1

9kHz to 1GHz

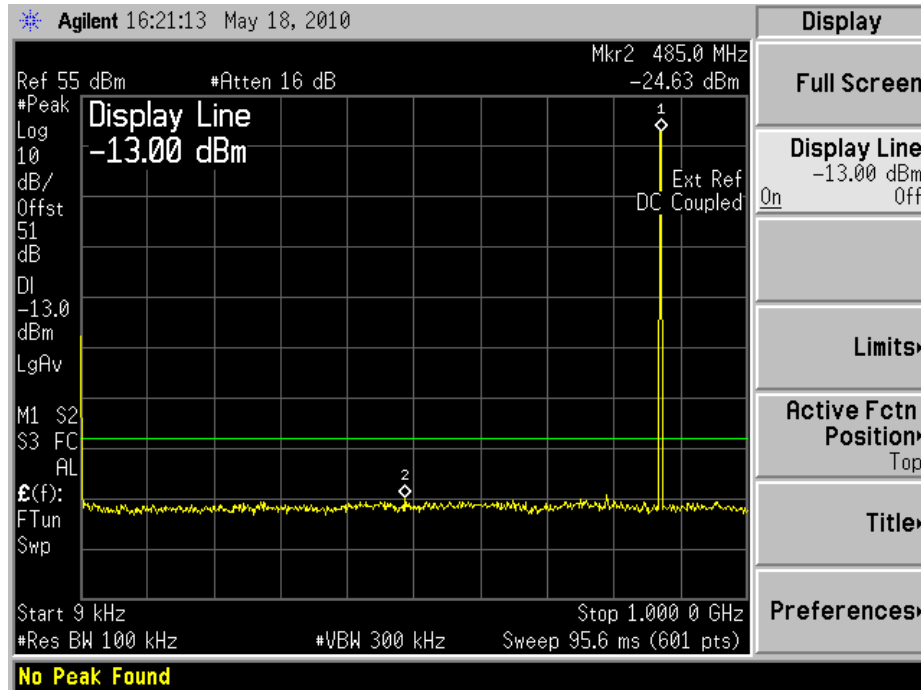

Note: The emission beyond the limit is the operating frequency.

1GHz to 1.4GHz

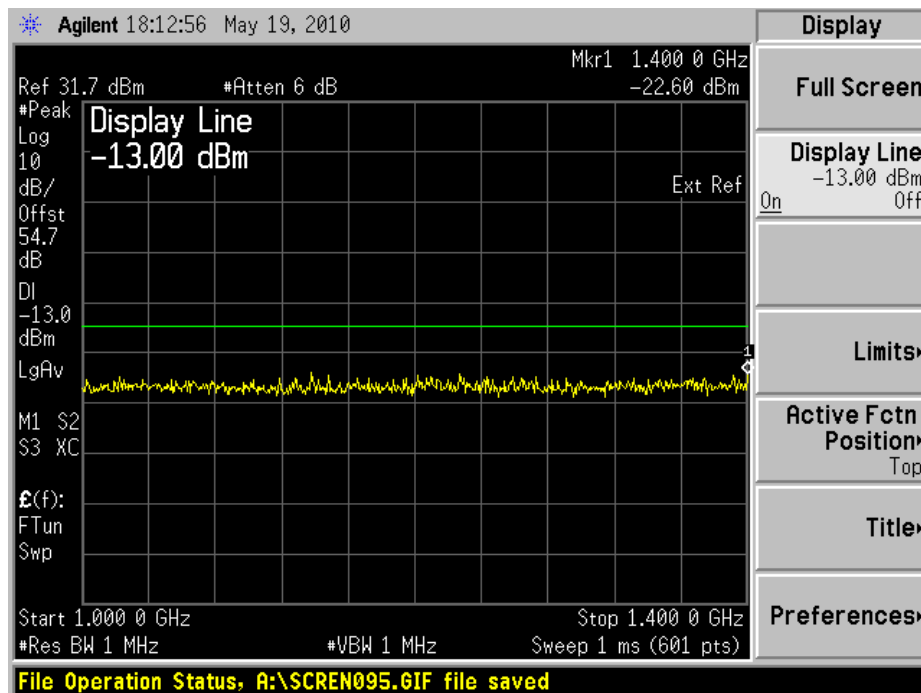



1.4GHz to 9GHz

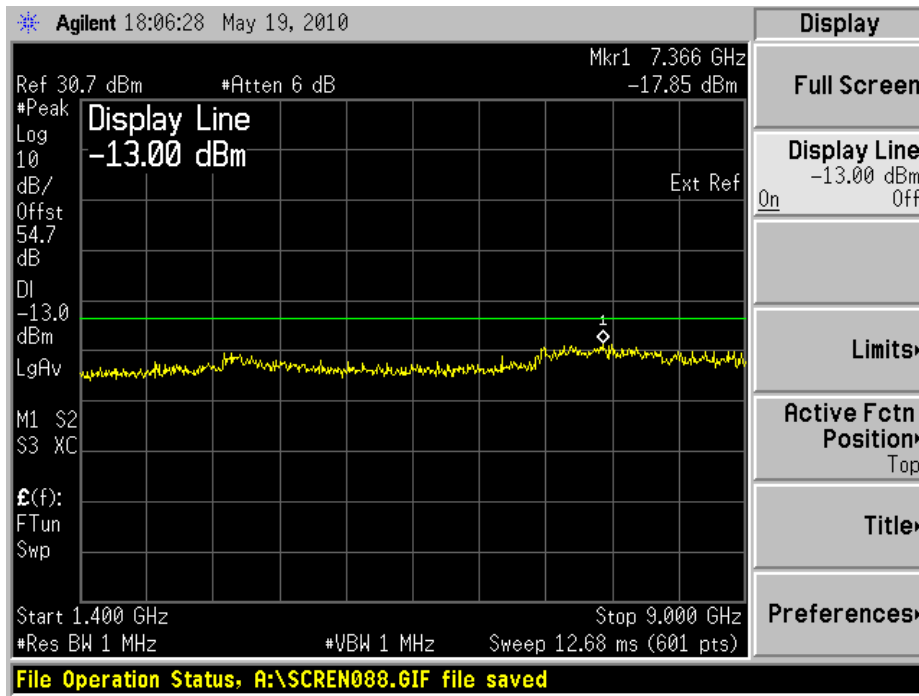

Configuration 1 - Mode 2

9kHz to 1GHz

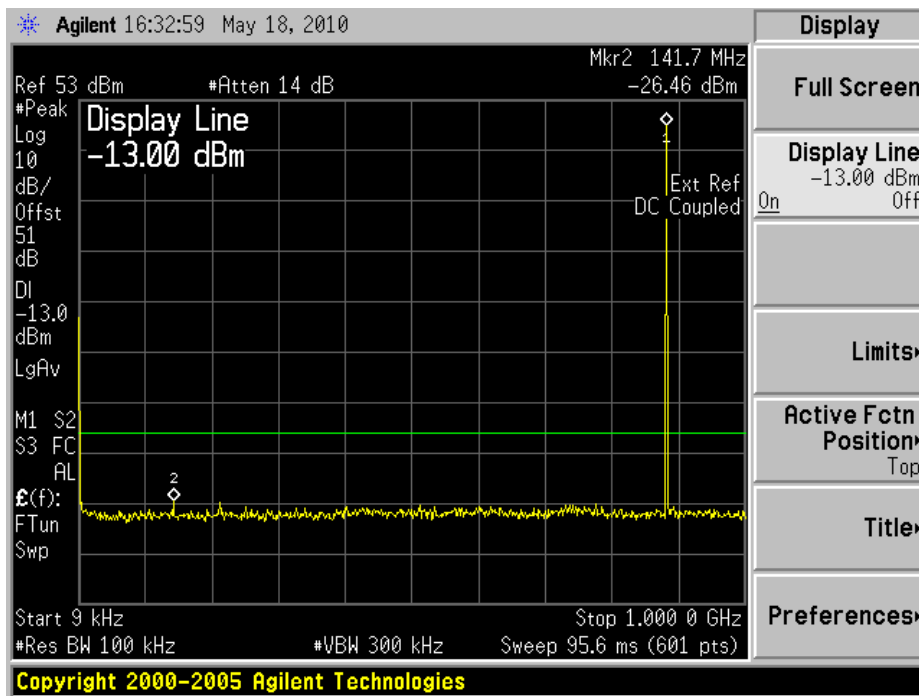

Note: The emission beyond the limit is the operating frequency.



1GHz to 1.4GHz

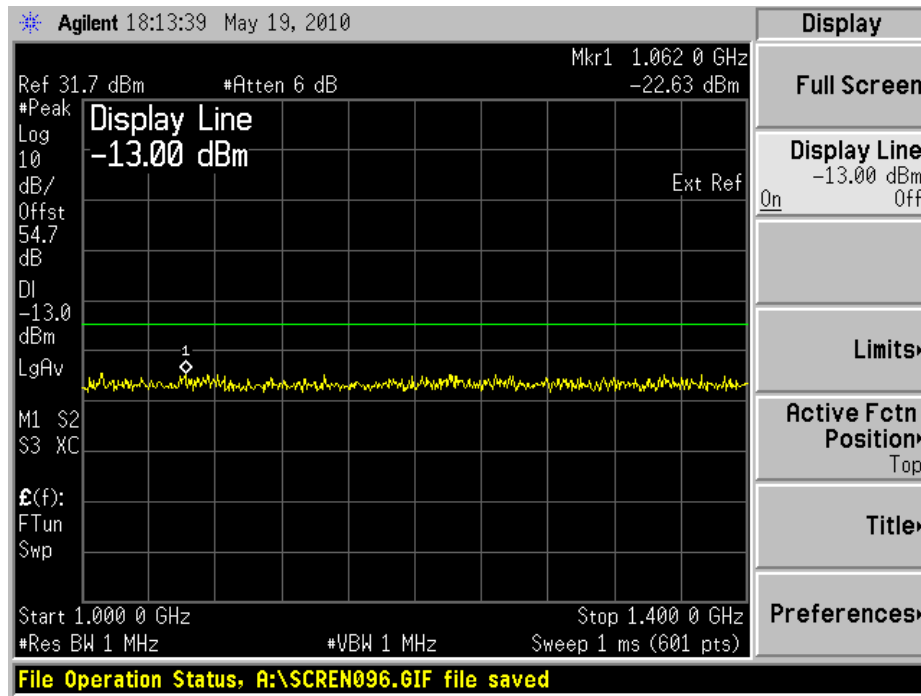

1.4GHz to 9GHz

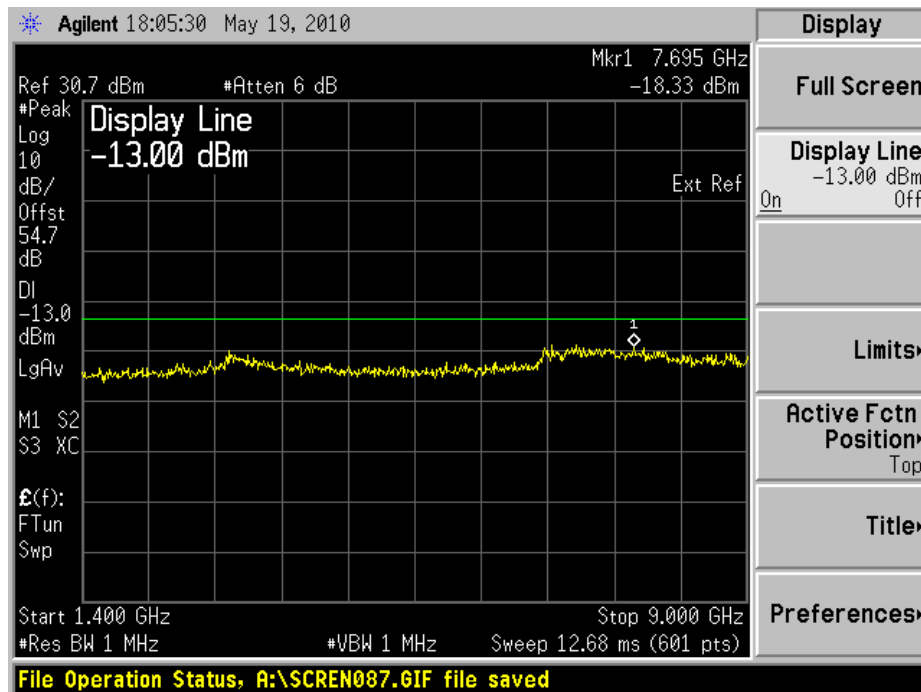



Configuration 1 - Mode 3

9kHz to 1GHz

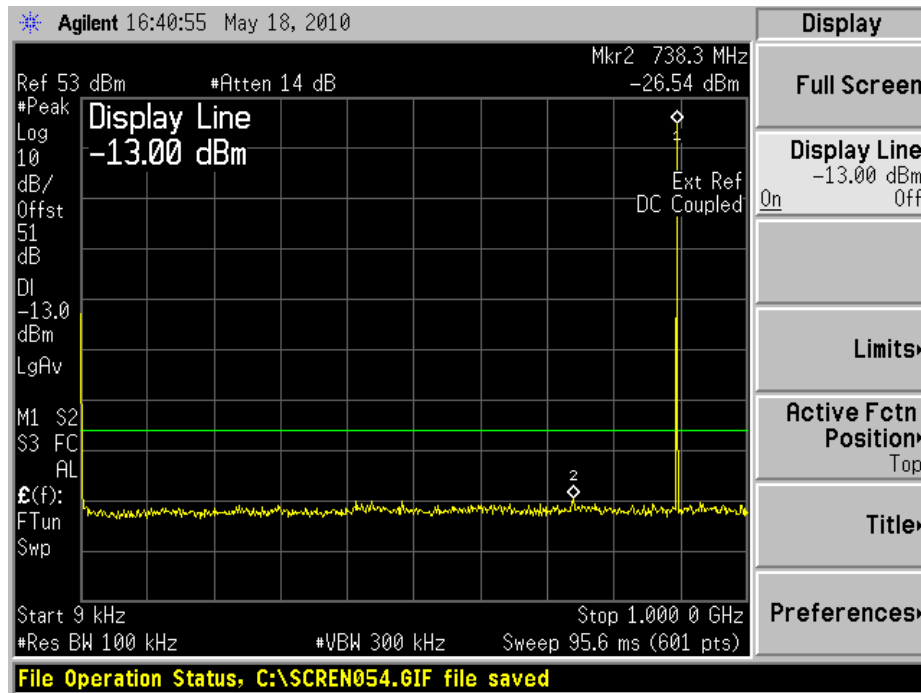

Note: The emission beyond the limit is the operating frequency.

1GHz to 1.4GHz

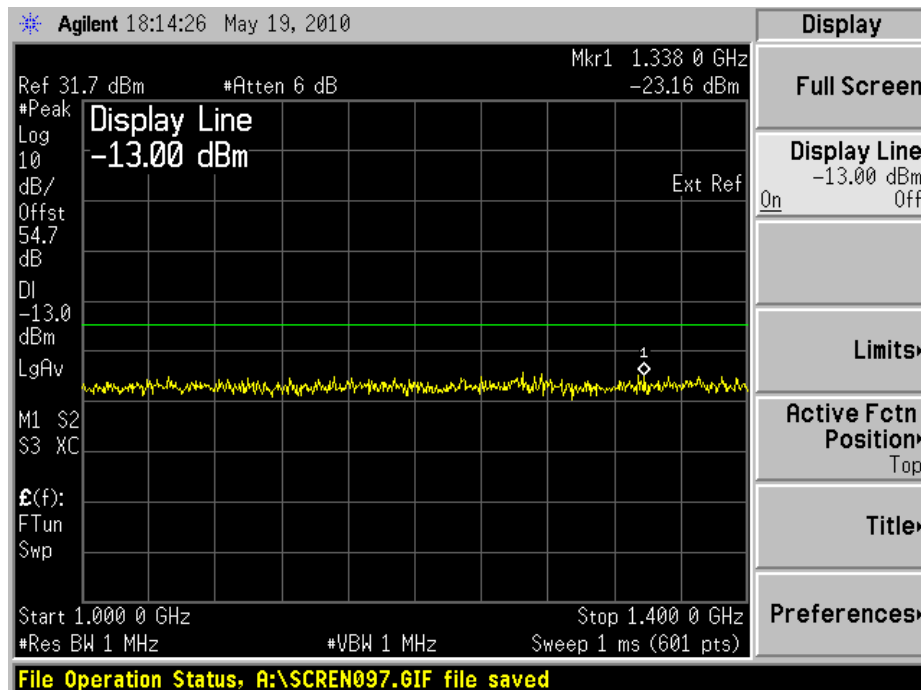



Product Service

1.4GHz to 9GHz

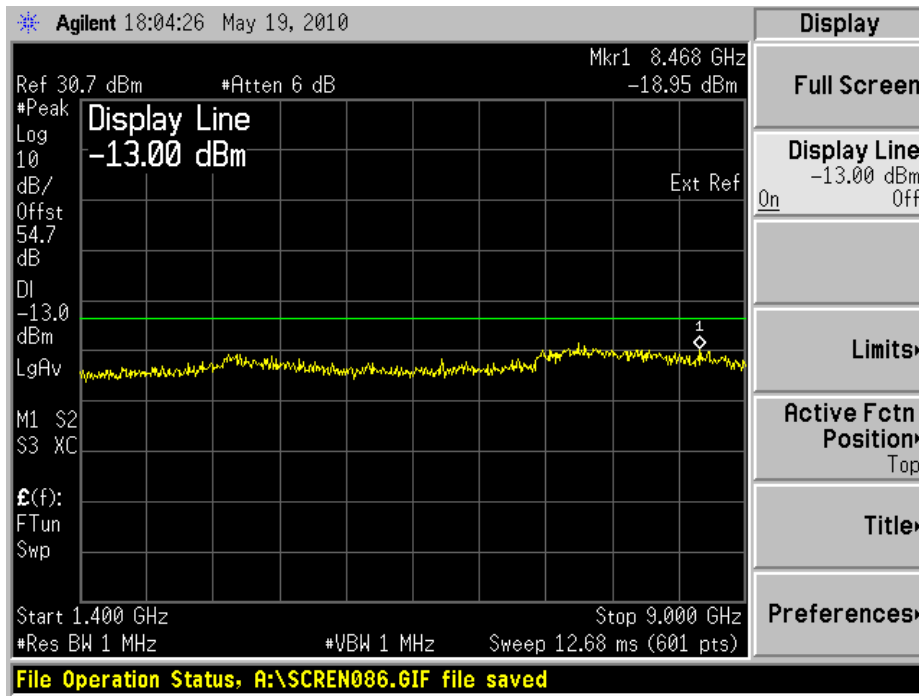

Configuration 2 - Mode 1

9kHz to 1GHz

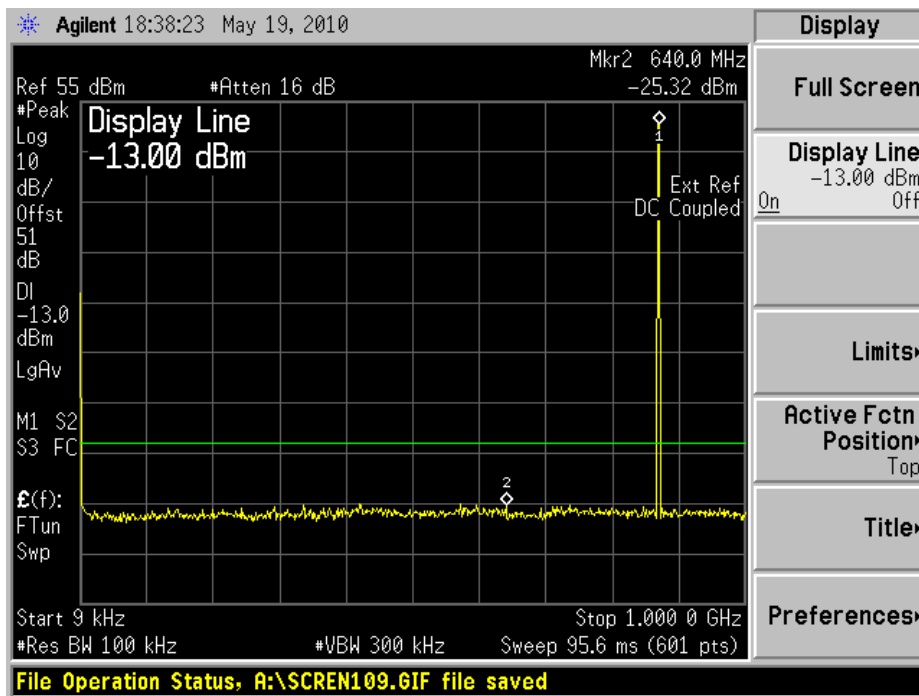

Note: The emission beyond the limit is the operating frequency.



1GHz to 1.4GHz

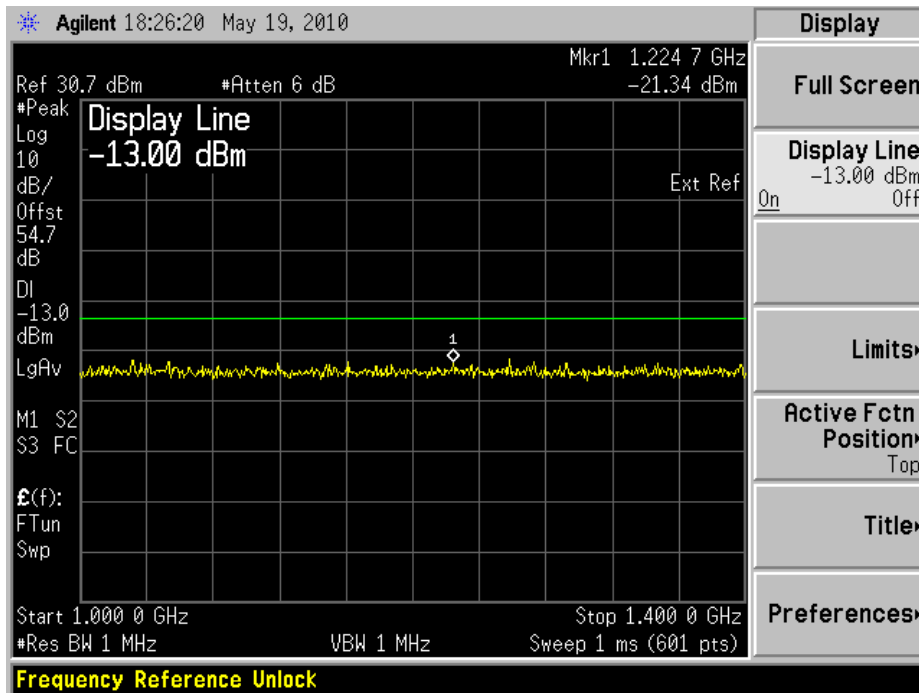

1.4GHz to 9GHz

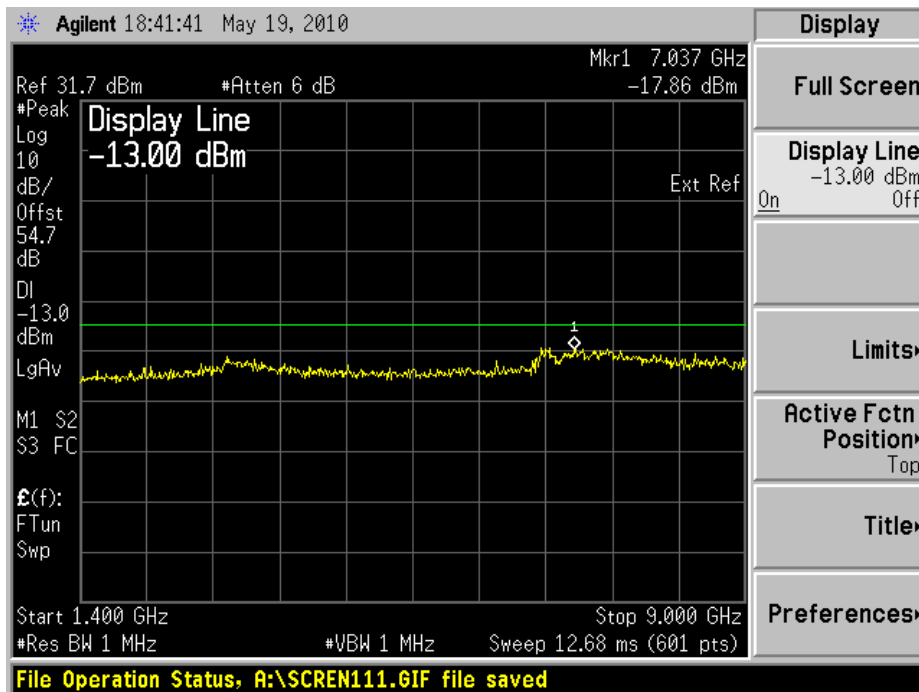



Configuration 2 - Mode 2

9kHz to 1GHz

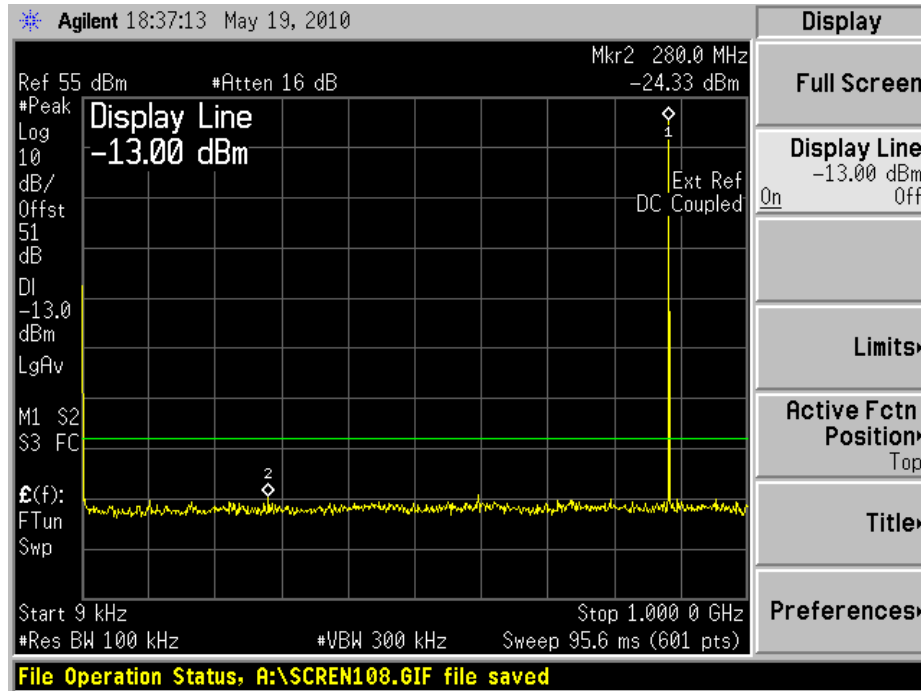

Note: The emission beyond the limit is the operating frequency.

1GHz to 1.4GHz

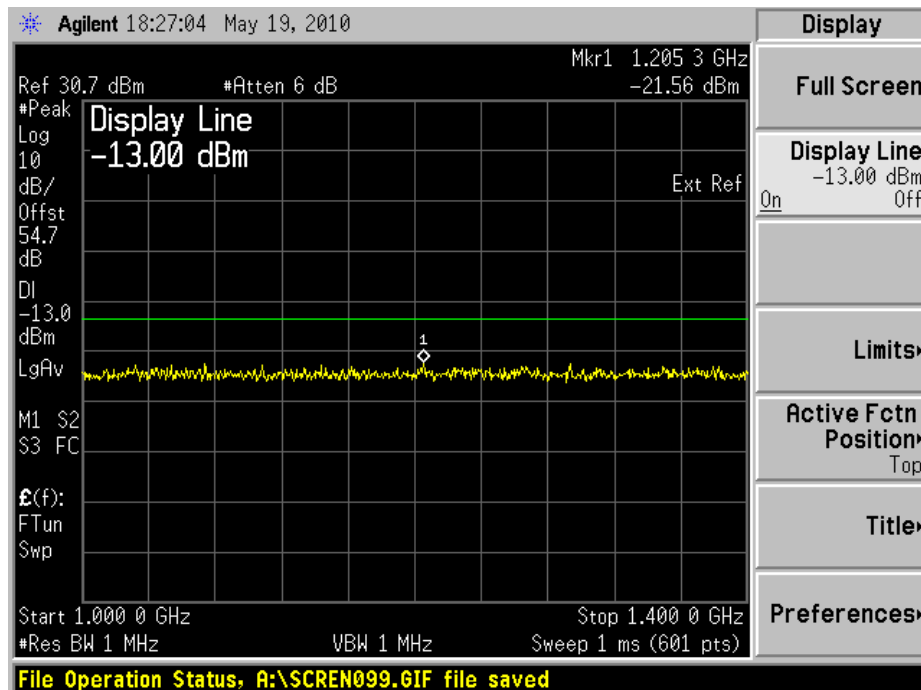



1.4GHz to 9GHz

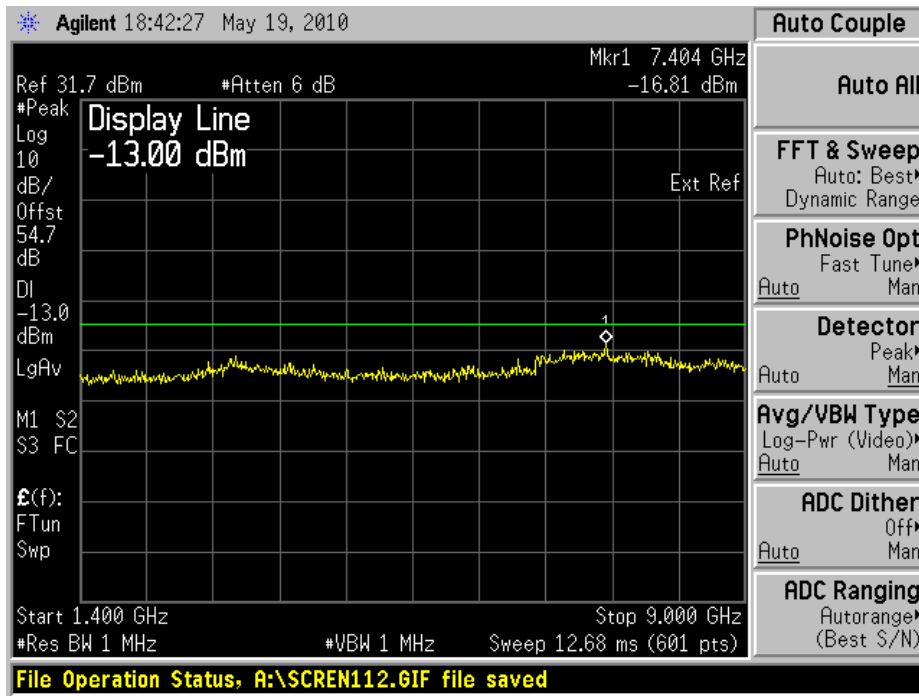

Configuration 2 - Mode 3

9kHz to 1GHz

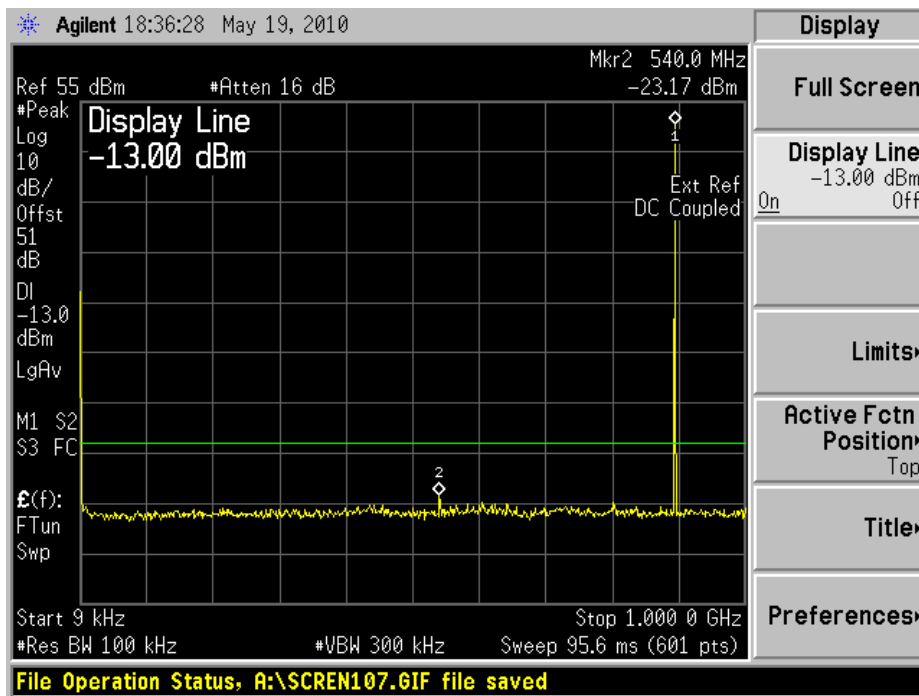

Note: The emission beyond the limit is the operating frequency.



Product Service

1GHz to 1.4GHz

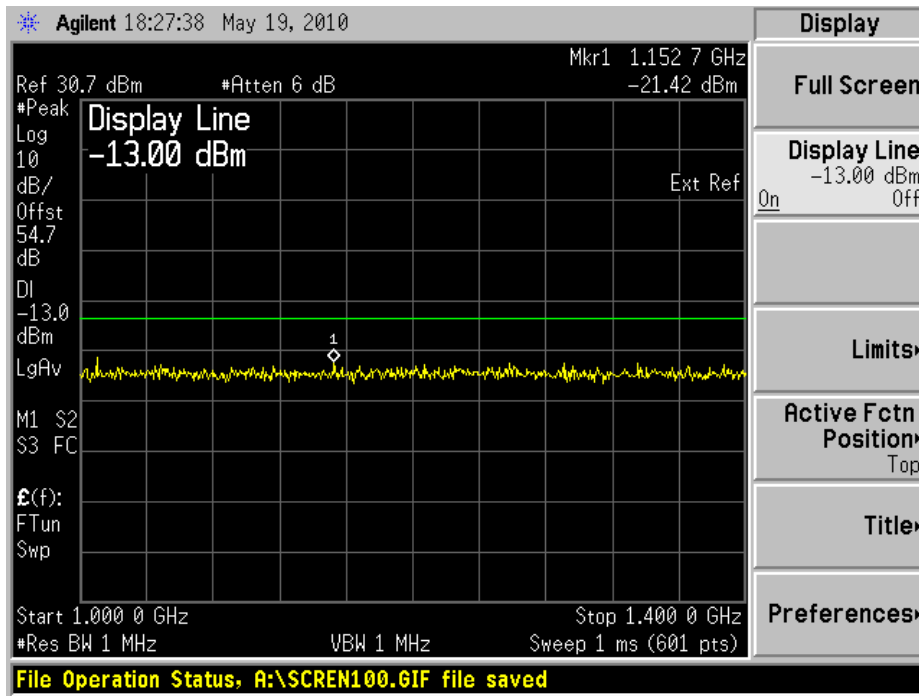

1.4GHz to 9GHz

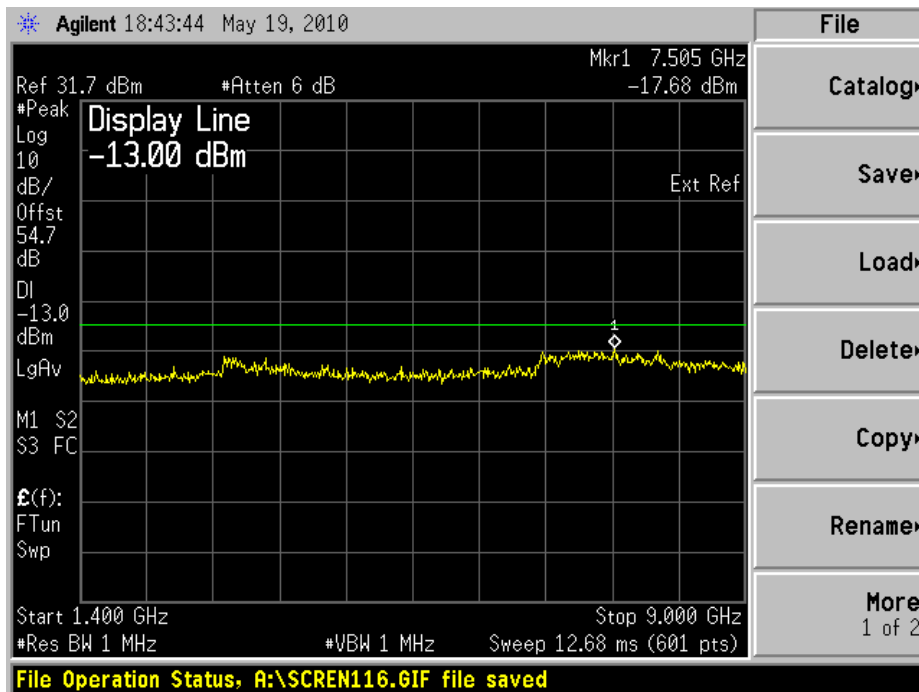



Configuration 3 - Mode 6

9kHz to 1GHz

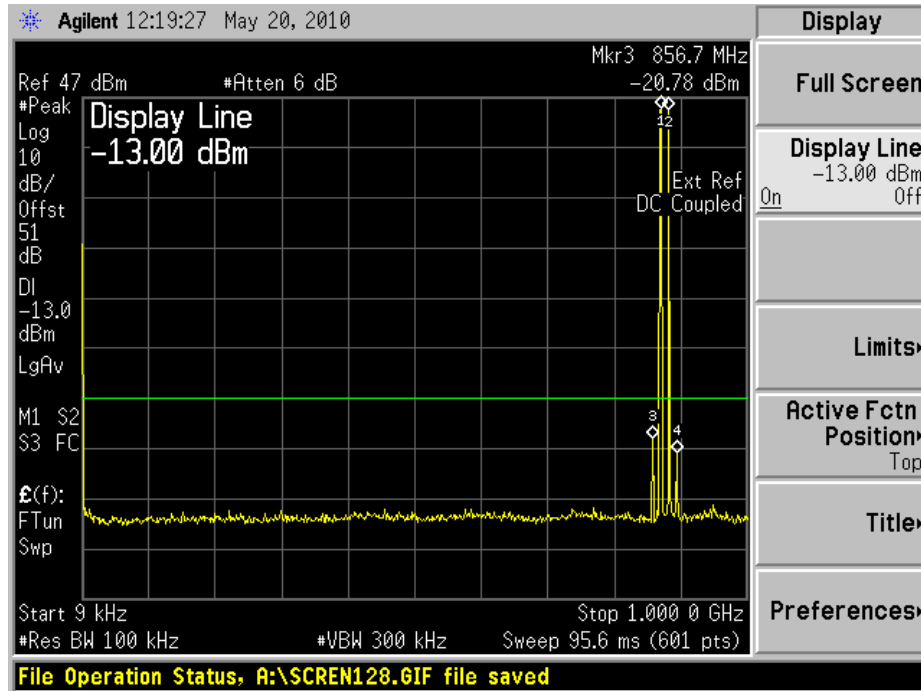

Note: The emissions beyond the limit are the operating frequencies.

1GHz to 1.4GHz

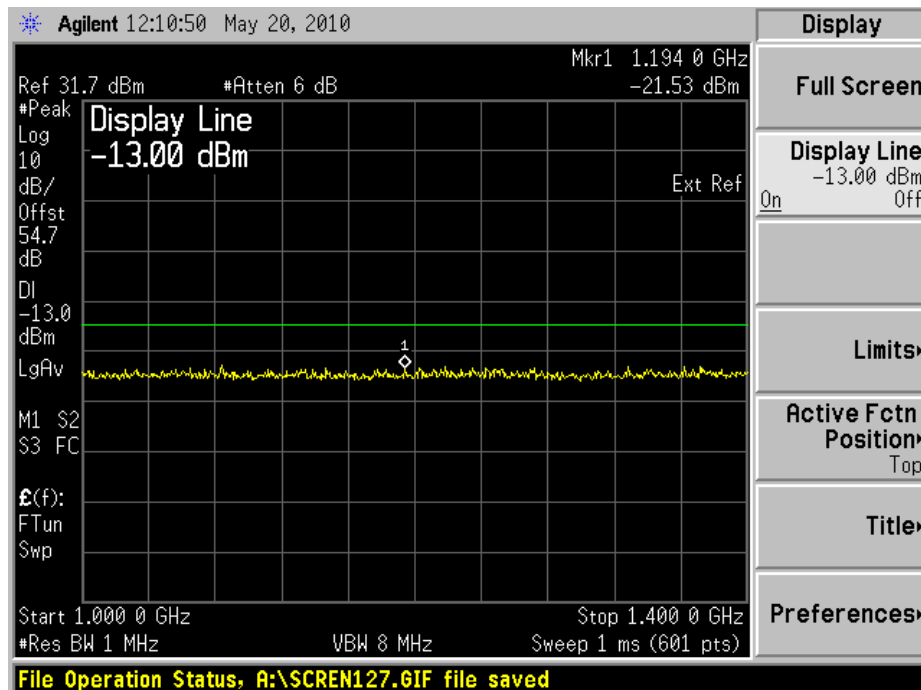



1.4GHz to 9GHz

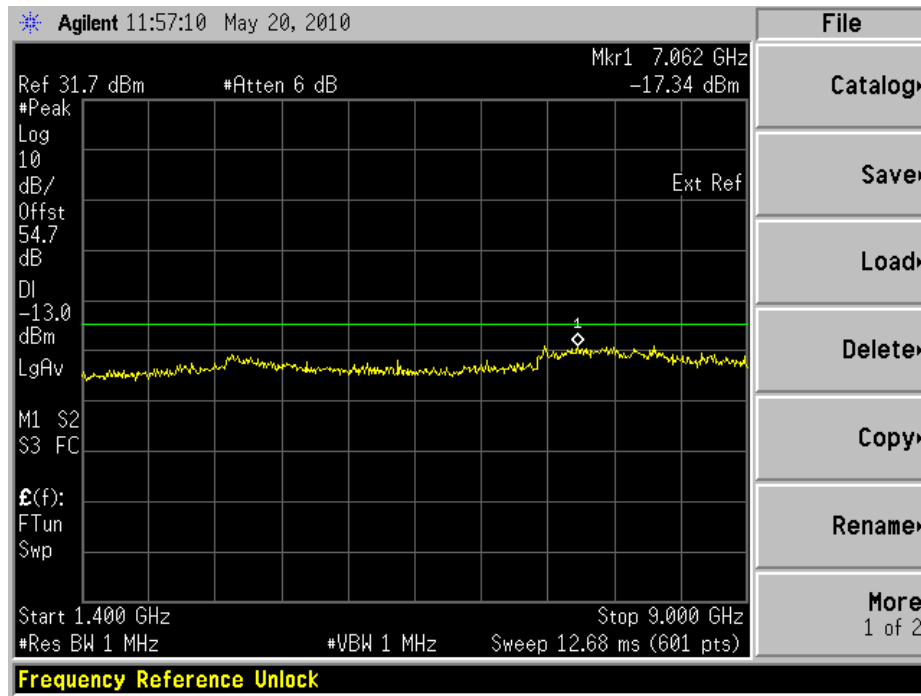

Configuration 3 - Mode 7

9kHz to 1GHz

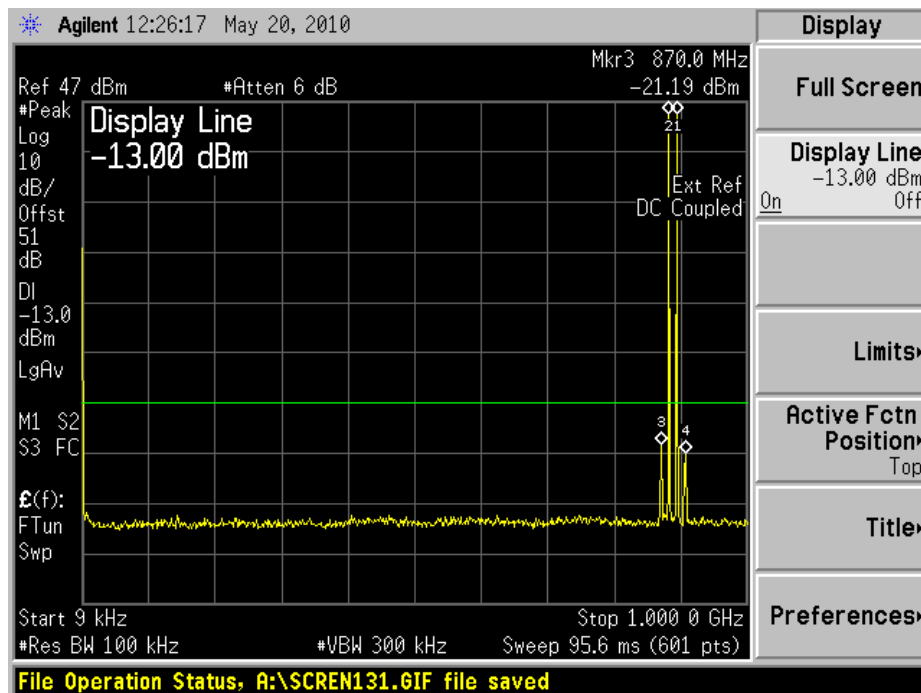

Note: The emissions beyond the limit are the operating frequencies.



1GHz to 1.4GHz

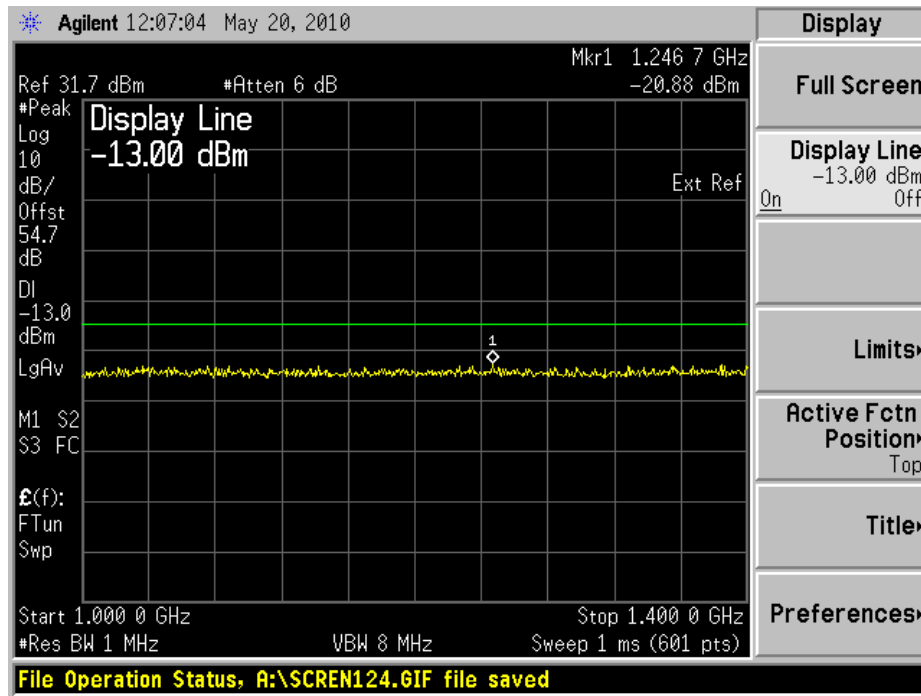

1.4GHz to 9GHz

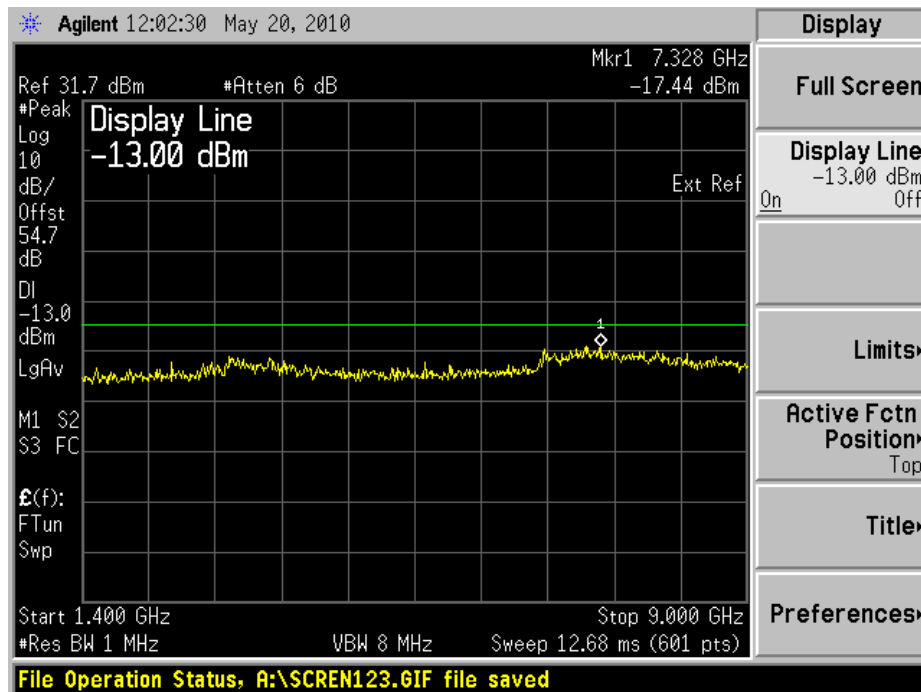



8PSK

Configuration 1 - Mode 1

9kHz to 1GHz

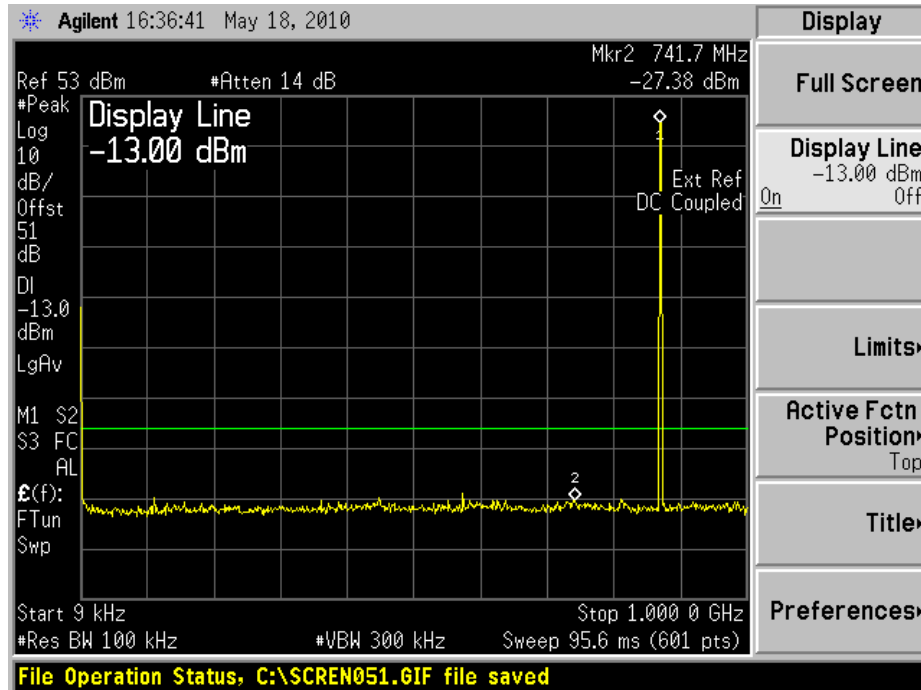

Note: The emission beyond the limit is the operating frequency.

1GHz to 1.4GHz

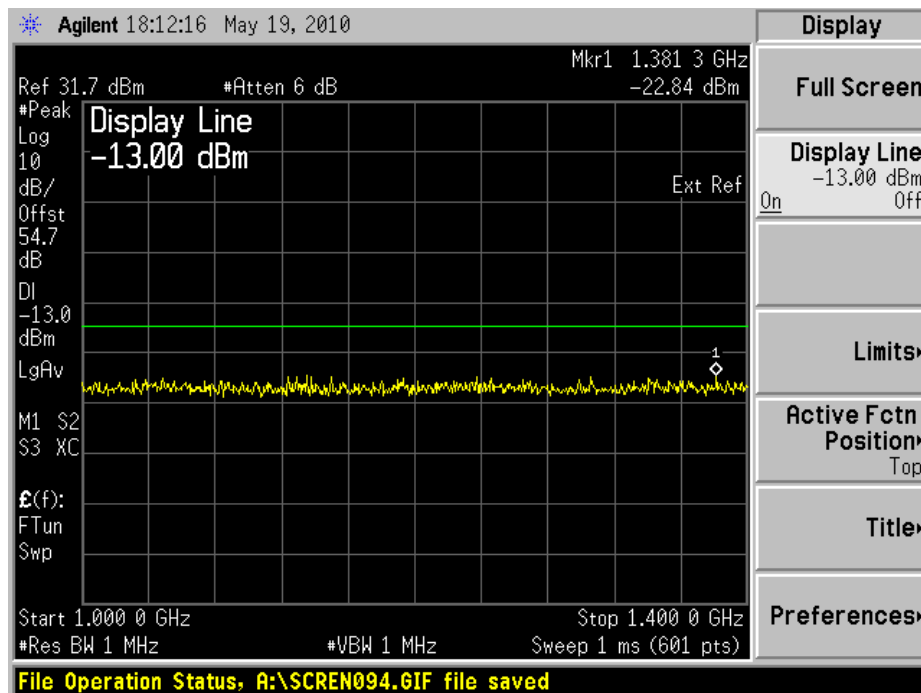



Product Service

1.4GHz to 9GHz

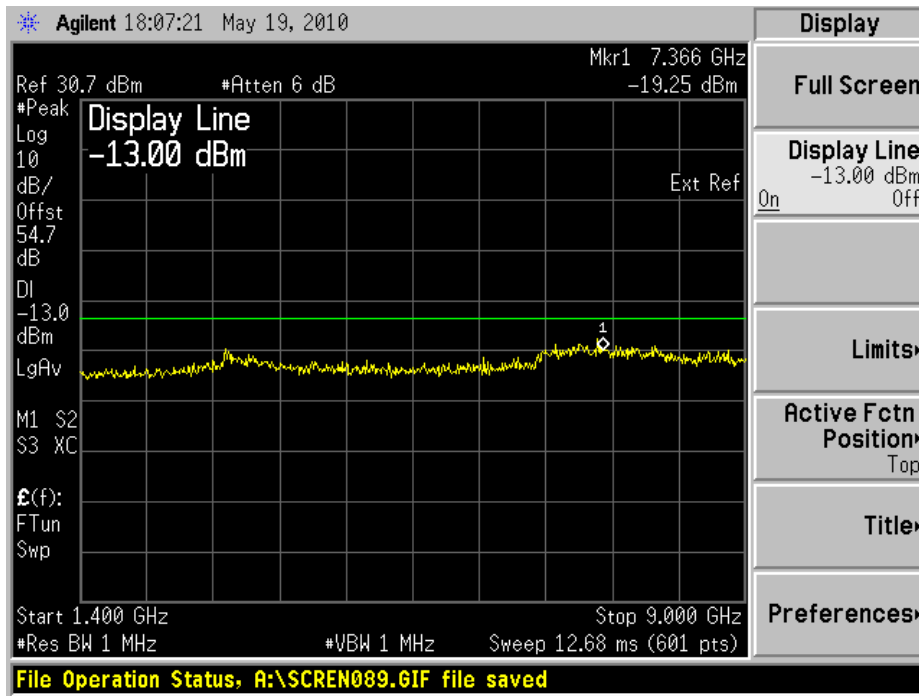

Configuration 1 - Mode 2

9kHz to 1GHz

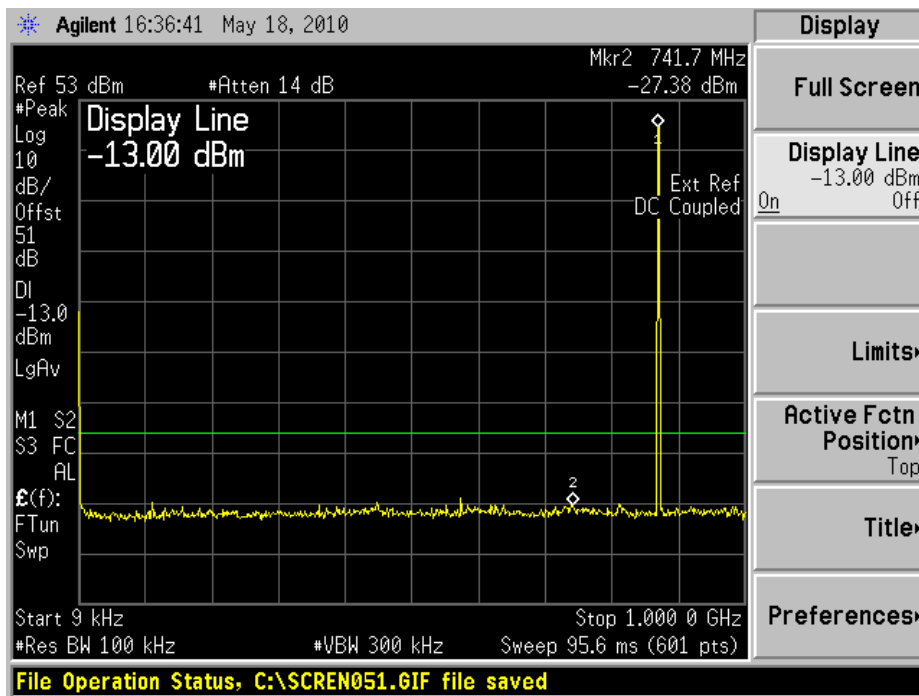

Note: The emission beyond the limit is the operating frequency.



1GHz to 1.4GHz

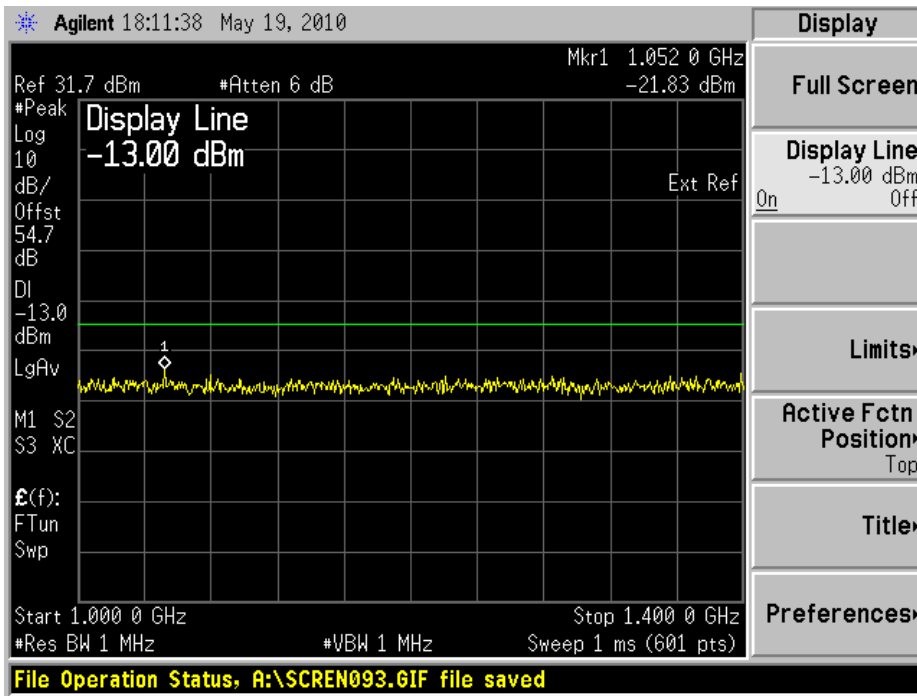

1.4GHz to 9GHz

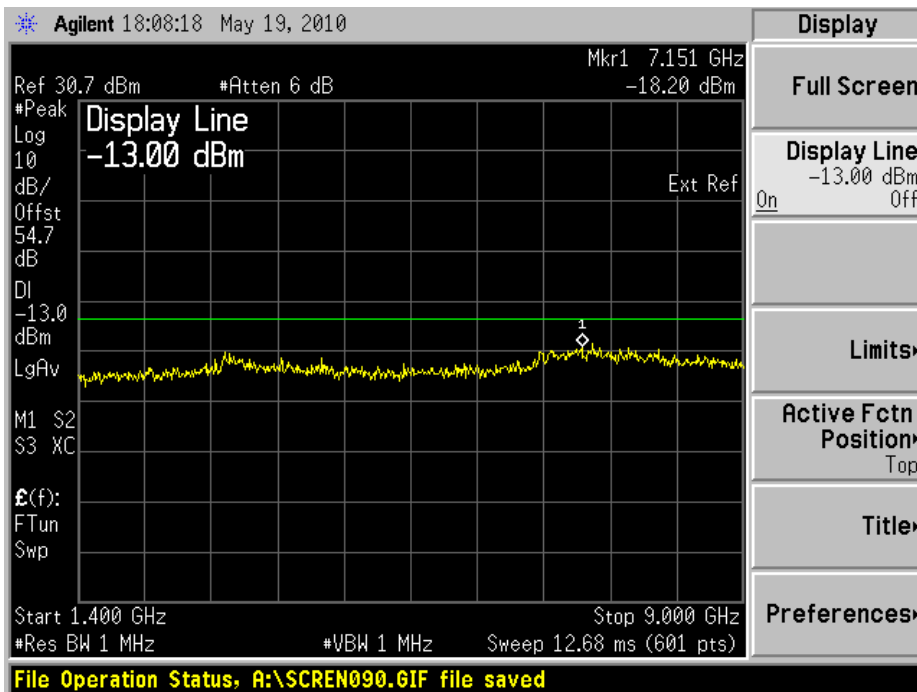



Configuration 1 - Mode 3

9kHz to 1GHz

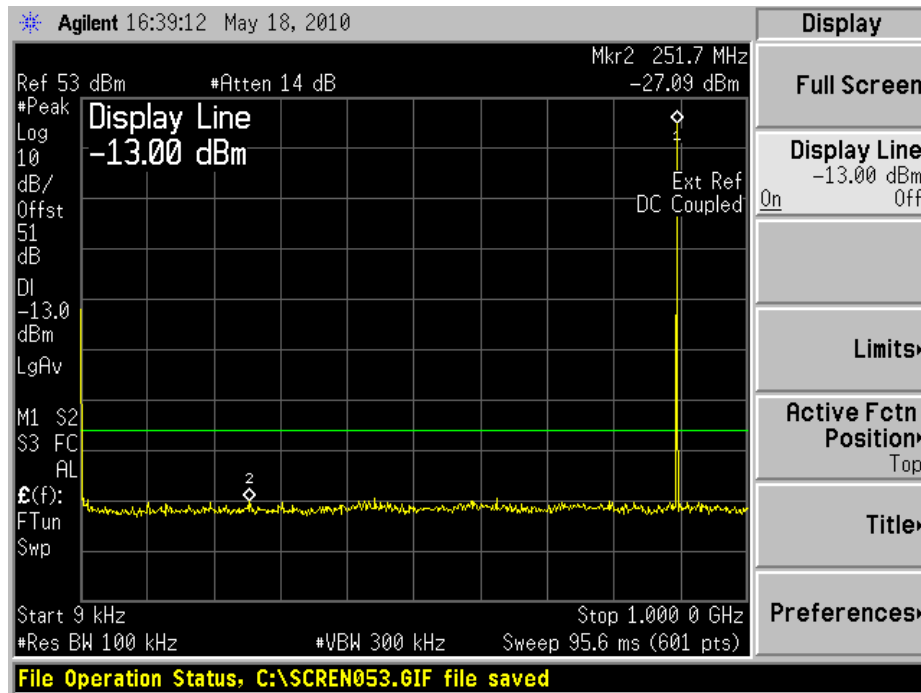

Note: The emission beyond the limit is the operating frequency.

1GHz to 1.4GHz

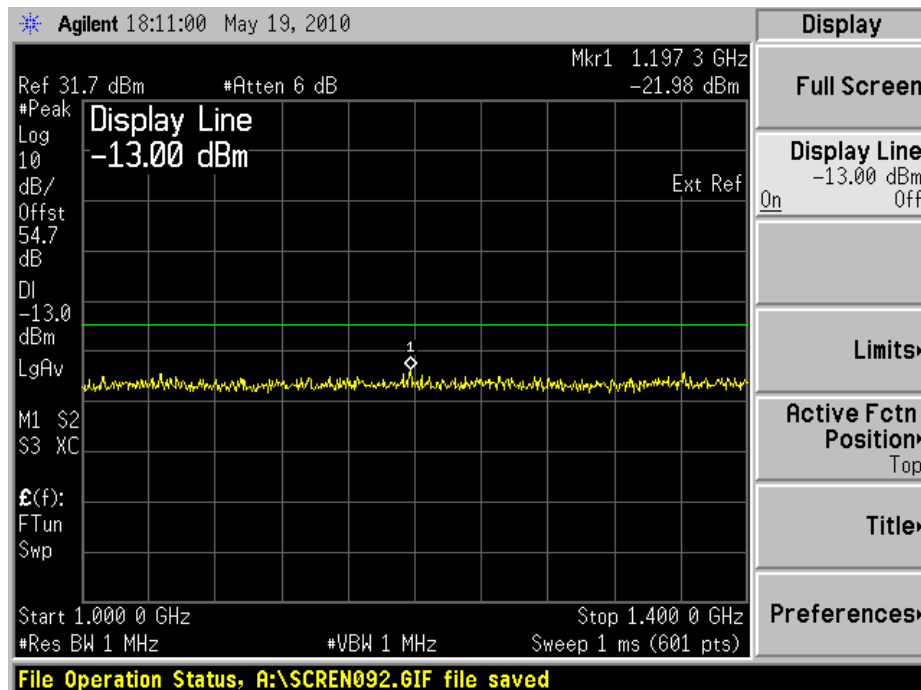



1.4GHz to 9GHz

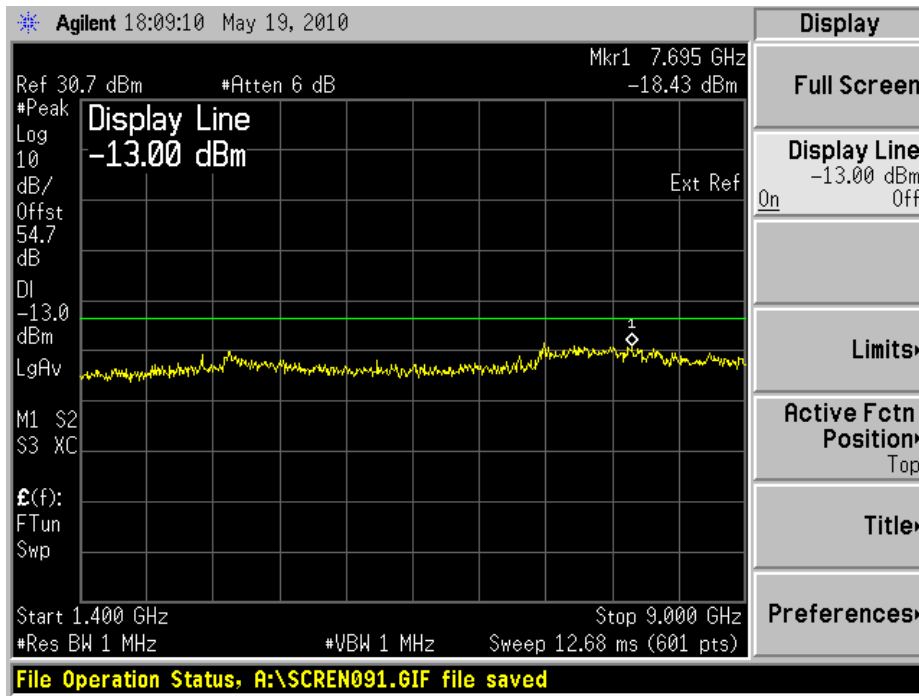

Configuration 2 - Mode 1

9kHz to 1GHz

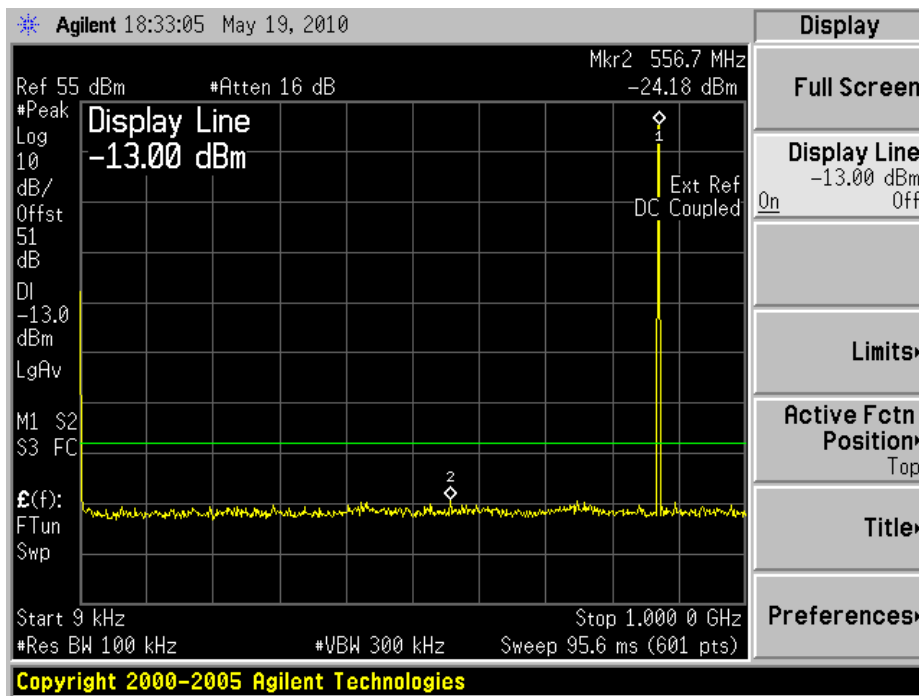

Note: The emission beyond the limit is the operating frequency.



Product Service

1GHz to 1.4GHz

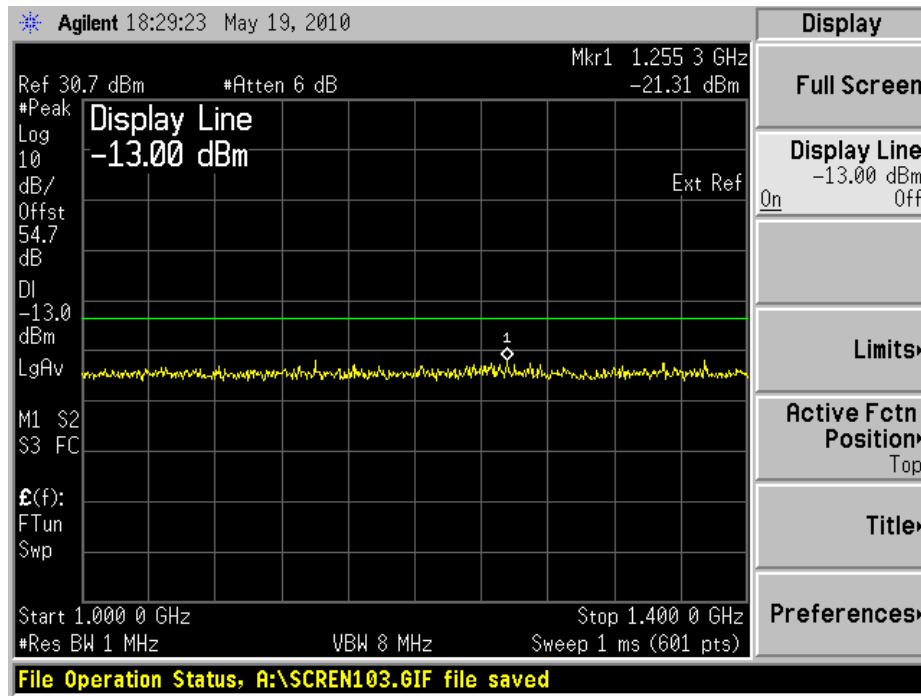

1.4GHz to 9GHz

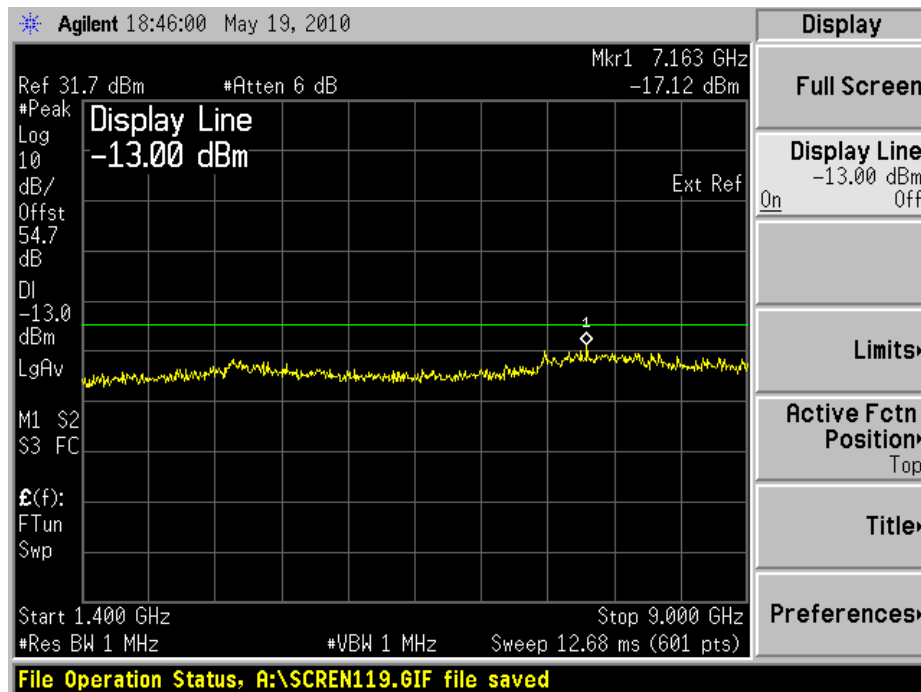



Configuration 2 - Mode 2

9kHz to 1GHz

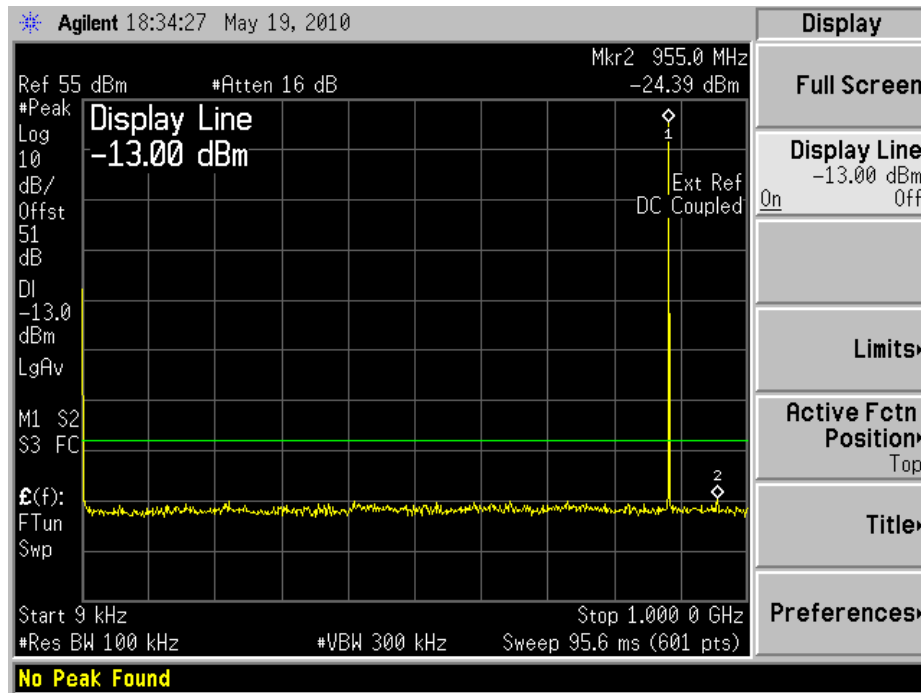

Note: The emission beyond the limit is the operating frequency.

1GHz to 1.4GHz

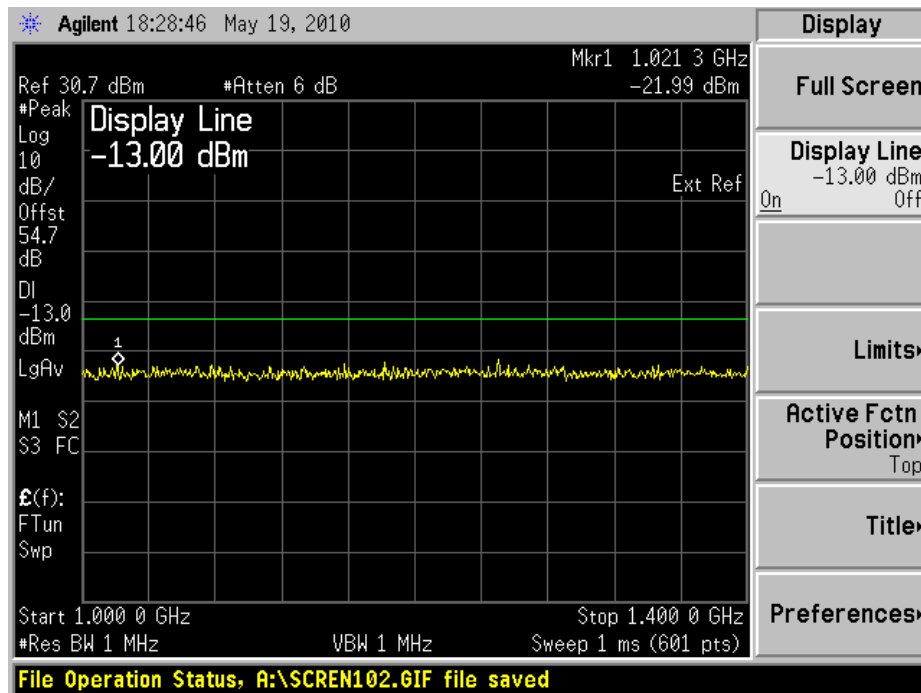



Product Service

1.4GHz to 9GHz

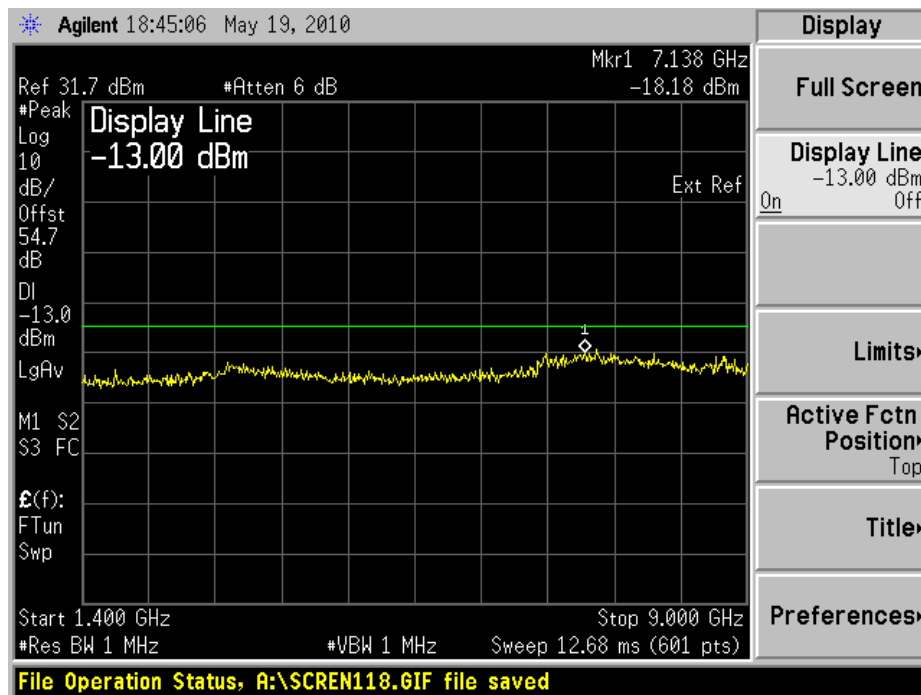

Configuration 2 - Mode 3

9kHz to 1GHz

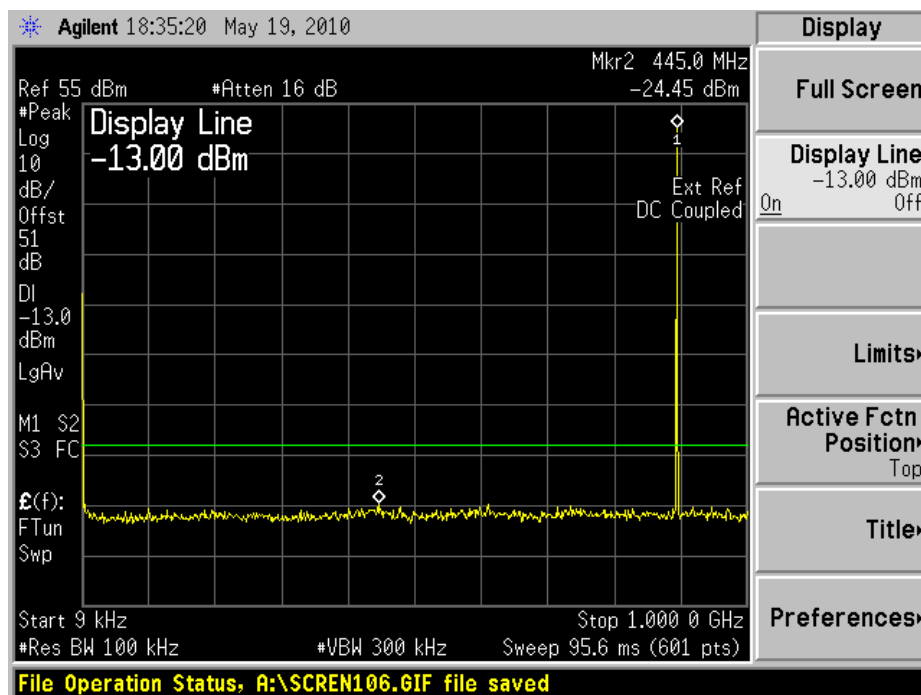

Note: The emission beyond the limit is the operating frequency.



1GHz to 1.4GHz

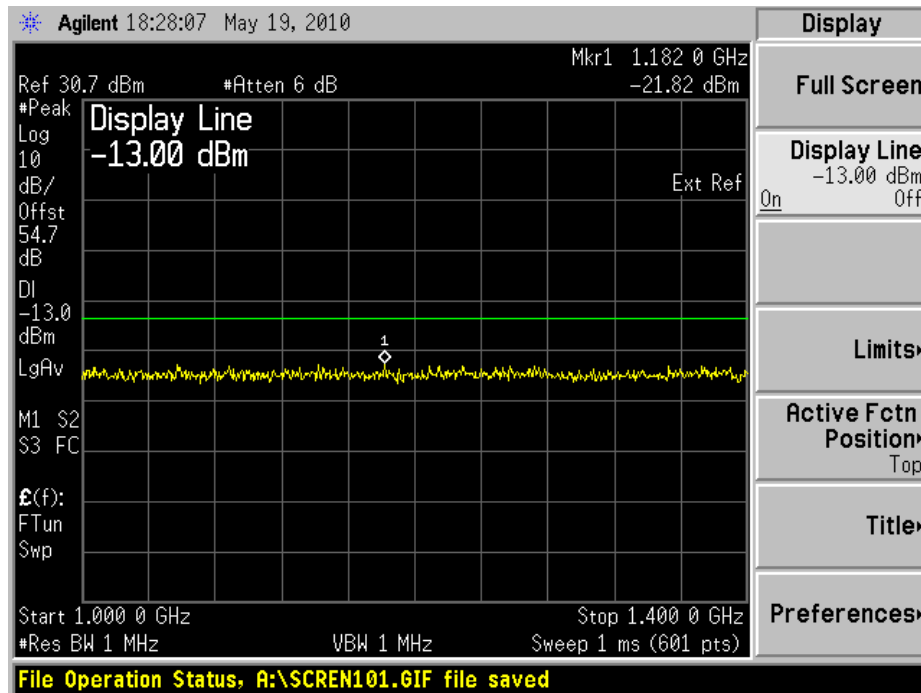

1.4GHz to 9GHz

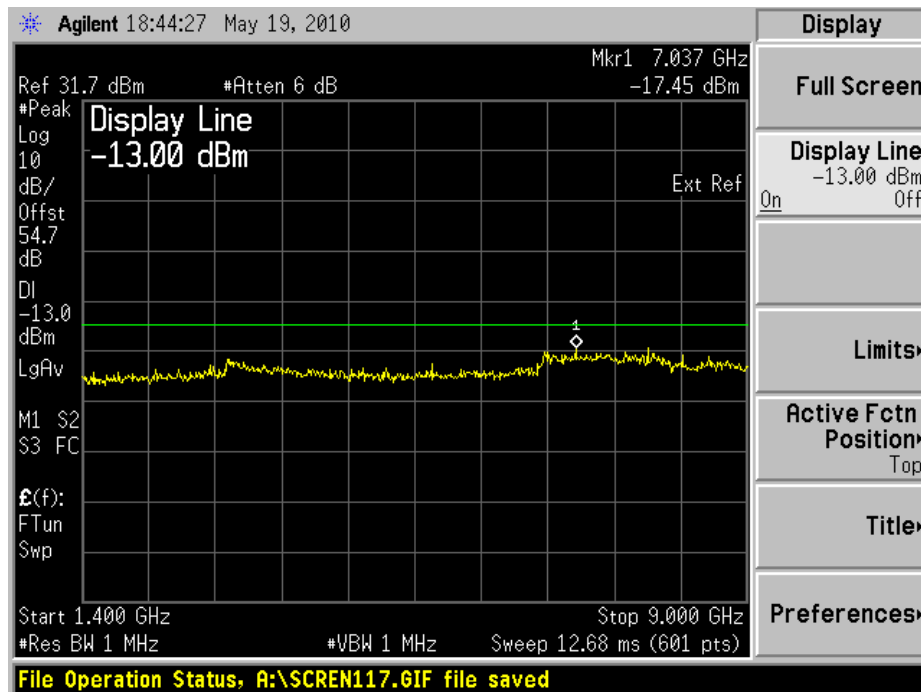



Configuration 3 - Mode 6

9kHz to 1GHz

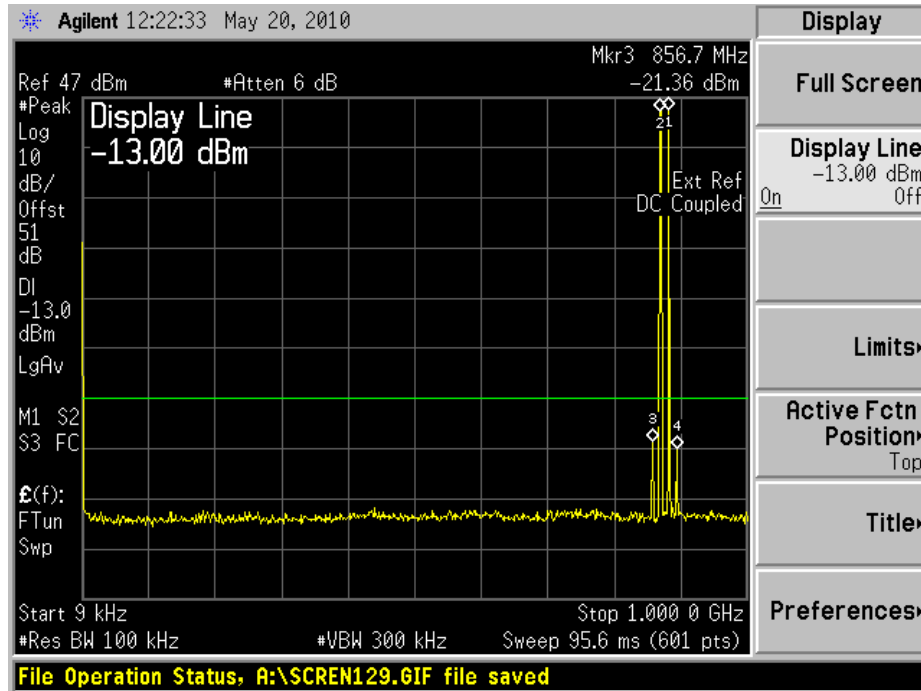

Note: The emissions beyond the limit are the operating frequencies.

1GHz to 1.4GHz

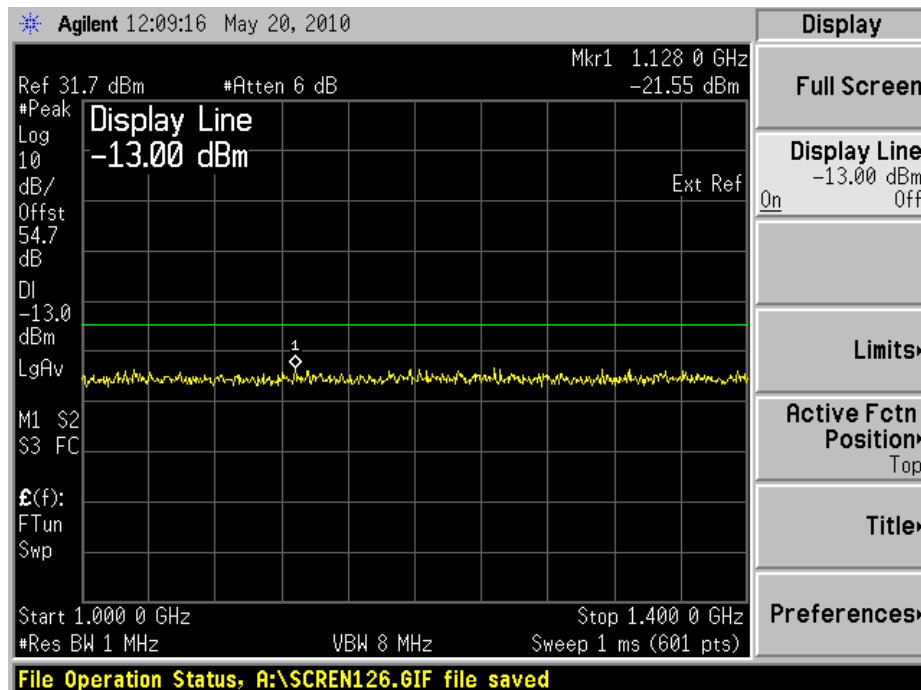



Product Service

1.4GHz to 9GHz

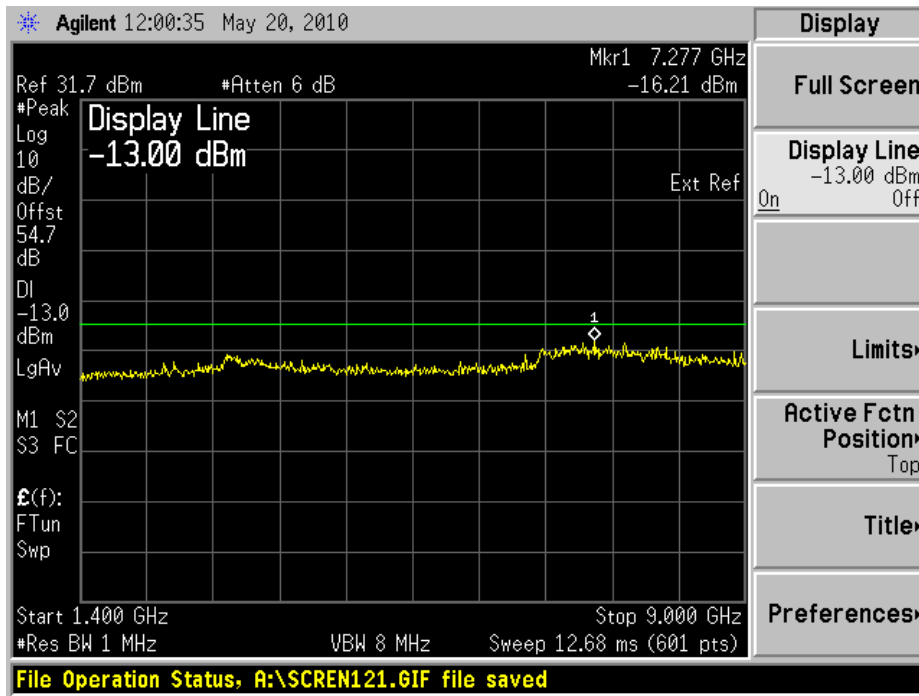

Configuration 3 - Mode 7

9kHz to 1GHz

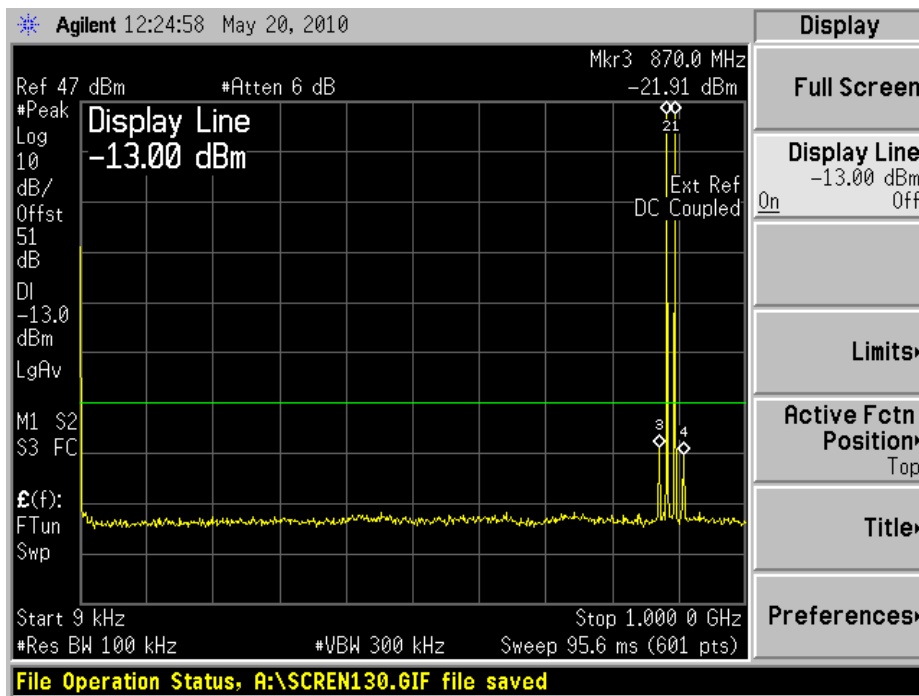

Note: The emissions beyond the limit are the operating frequencies.



Product Service

1GHz to 1.4GHz

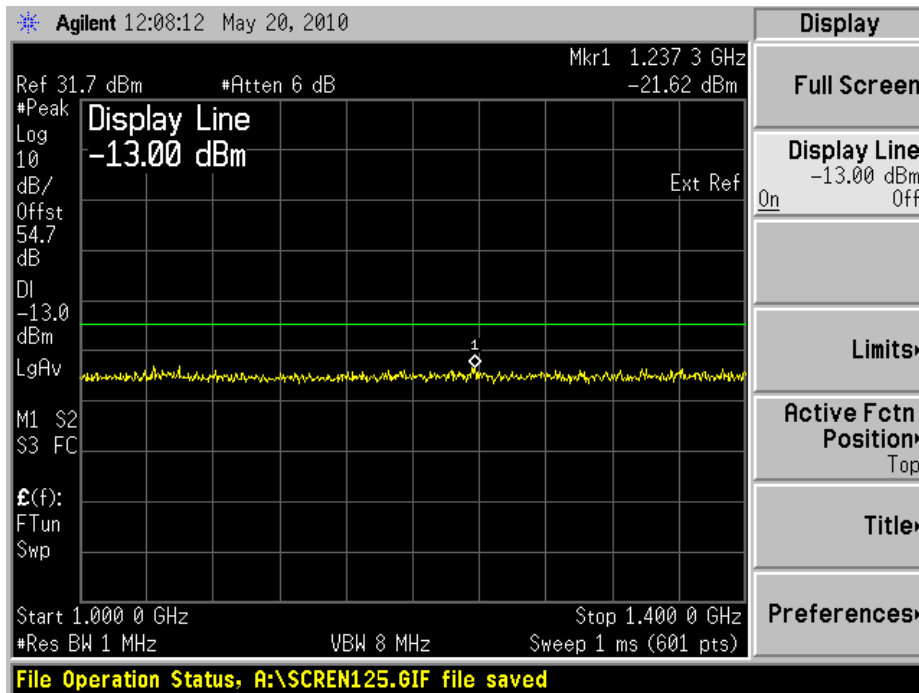

1.4GHz to 9GHz

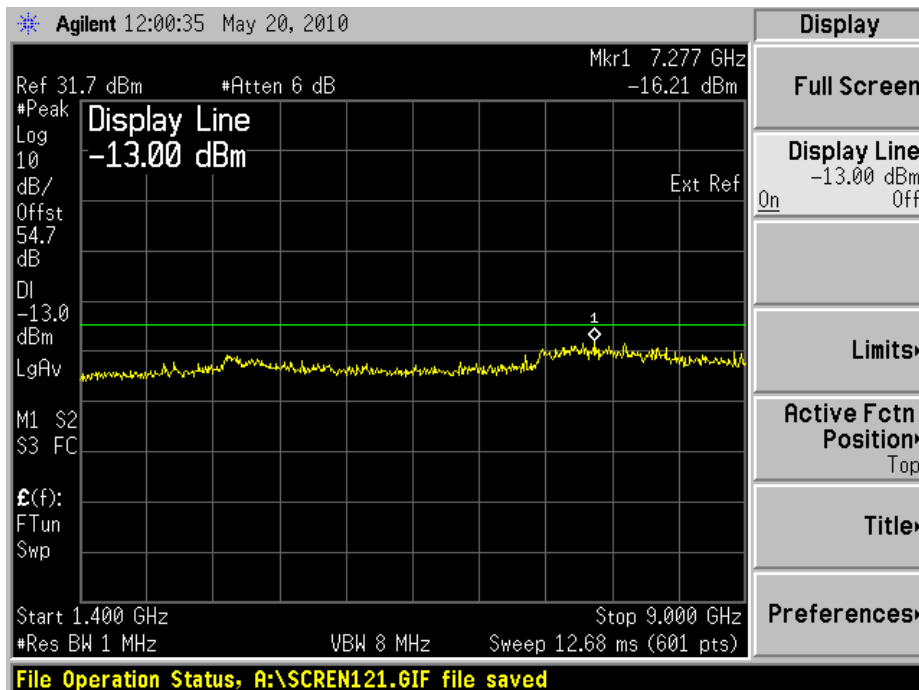

Limit	-13dBm
-------	--------



Product Service

2.7 FREQUENCY STABILITY UNDER TEMPERATURE VARIATIONS

2.7.1 Specification Reference

FCC CFR 47 Part 2, Clause 2.1055
FCC CFR 47 Part 22, Clause 22.355
Industry Canada RSS-132, Clause 4.3

2.7.2 Equipment Under Test

RUG 11 B5, S/N: CB4C986602

2.7.3 Date of Test and Modification State

19 May 2010 – Modification State 0

2.7.4 Test Equipment Used

The major items of test equipment used for the above tests are identified in Section 3.1.

2.7.5 Test Method and Operating Modes

The test was applied in accordance with the test method requirements of FCC CFR 47 Part 2 and Part 22 and Industry Canada RSS-132.

The EUT was set to transmit on maximum power with all timeslots active. A Spectrum Analyser was used to measure the frequency error. The average result was taken over 200 bursts. The temperature was adjusted between -30°C and $+50^{\circ}\text{C}$ in 10° steps as per 2.1055.

The test was performed with the EUT in the following configurations and modes of operation:

Configuration 1 - Mode 2

2.7.6 Environmental Conditions

	19 May 2010
Ambient Temperature	25.0°C
Relative Humidity	37.1%



Product Service

2.7.7 Test Results

For the period of test the EUT met the requirements of FCC CFR 47 Part 22 and Industry Canada RSS-132 for Frequency Stability Under Temperature Variations.

The test results are shown below

Power Supply: -48V DC

GMSK

Configuration 1 - Mode 2

Temperature Interval (°C)	Deviation (Hz)
-30	9.05
-20	8.58
-10	-6.08
0	-9.35
+10	-10.11
+20	5.21
+30	7.32
+40	5.89
+50	-5.47

8PSK

Configuration 1 - Mode 2

Temperature Interval (°C)	Deviation (Hz)
-30	9.30
-20	10.43
-10	-7.37
0	-10.72
+10	-10.39
+20	7.54
+30	7.28
+40	-5.95
+50	6.41

Limit	±1.5 ppm or ±1.322 kHz
-------	------------------------

Remarks

The frequency stability of the EUT is sufficient to keep it within the authorised frequency ranges at any temperature interval across the measured range.



Product Service

2.8 FREQUENCY STABILITY UNDER VOLTAGE VARIATIONS

2.8.1 Specification Reference

FCC CFR 47 Part 2, Clause 2.1055
FCC CFR 47 Part 22, Clause 22.355
Industry Canada RSS-132, Clause 4.3

2.8.2 Equipment Under Test

RUG 11 B5, S/N: CB4C986602

2.8.3 Date of Test and Modification State

19 May 2010 – Modification State 0

2.8.4 Test Equipment Used

The major items of test equipment used for the above tests are identified in Section 3.1.

2.8.5 Test Method and Operating Modes

The test was applied in accordance with the test method requirements of FCC CFR 47 Part 2 and Part 22 and Industry Canada RSS-132.

The EUT was set to transmit on maximum power on timeslot 3. A Spectrum Analyser was used to measure the frequency error. The average result was taken over 200 bursts. The supplied voltage was varied from 85 to 115 percent of the nominal value.

The test was performed with the EUT in the following configurations and modes of operation:

Configuration 1 - Mode 2

2.8.6 Environmental Conditions

	19 May 2010
Ambient Temperature	25.0°C
Relative Humidity	37.1%



Product Service

2.8.7 Test Results

For the period of test the EUT met the requirements of FCC CFR 47 Part 22 and Industry Canada RSS-132 for Frequency Stability Under Voltage Variations.

The test results are shown below

Temperature: 20°C

GMSK

Configuration 1 - Mode 2

DC Voltage (V)	Deviation (Hz)
-40.0	7.20
-48.0	5.21
-57.6	6.53

8PSK

Configuration 1 - Mode 2

DC Voltage (V)	Deviation (Hz)
-40.0	6.84
-48.0	7.54
-57.6	7.68

Limit	± 1.5 ppm or ± 1.322 kHz
-------	----------------------------------

Remarks

The frequency stability of the EUT is sufficient to keep it within the authorised frequency ranges under voltage variations across the measured range.



Product Service

SECTION 3

TEST EQUIPMENT USED



3.1 TEST EQUIPMENT USED

List of absolute measuring and other principal items of test equipment.

Instrument	Manufacturer	Type No.	Serial No.	Calibration Due
Section 2.1, 2.2, 2.3, 2.4 2.5, 2.7 and 2.8 – Maximum Conducted Output Power, Modulation Characteristics, Occupied Bandwidth, Spurious Emissions at Antenna Terminals (± 1MHz), Conducted Spurious Emissions and Receiver Spurious Emissions.				
Spectrum Analyser	Agilent	E4440A	MY46186610	2010/07/19
Power Metre	Rohde & Schwarz	NRP	101202	2011/04/27
AVG Power Sensor	Rohde & Schwarz	NRP-Z21	100868	2011/01/26
Network Analyzer	Agilent	8720D	US38431317	2010/10/26
40dB Attenuator	SHX	DTS100	04051204	O/P MON
10dB Attenuator	SHX	DTS150	05112234	O/P MON
High Pass Filter	K&L	5PH1-1400 / U12750	7	O/P MON
Power Supply	Dahua	DH1716-5D	4001375	O/P MON
Power Supply	Dahua	SM70-45D	--	O/P MON
Digital Multi-meter	FLUKE	179	91820401	2011/01/03
Thermo-hygrometer	AZ Instruments	8705	9151655	2010/12/16
Section 2.6 – Radiated Spurious Emissions				
Power Supply	Dahua	DH1716-5D	4001375	O/P MON
EMI Receiver	Rohde & Schwarz	ESI 40	100015	2010/08/19
Ultra log test antenna	Rohde & Schwarz	HL562	100167	2010/08/19
Double-Ridged Waveguide Horn Antenna	Rohde & Schwarz	HF 906	100029	2010/08/19
Antenna master	Frankonia	MA 260	-	2010/08/19
Relay Switch Unit	Rohde & Schwarz	331.1601.31	338965002	TU
Anechoic Chamber	Frankonia	9.08m \times 5.255m \times e.525m	-	2010/08/19
Digital Multimeter	FLUKE	179	91820401	2010/12/02
Thermo-hygrometer	AZ Instruments	8705	9151655	2010/12/07
Section 2.9 and 2.10 – Frequency Stability Under Temperature and Voltage Variations				
Spectrum Analyser	Agilent	E4440A	MY46186610	2010/07/19
Network Analyzer	Agilent	8720D	US38431317	2010/10/26
40dB Attenuator	SHX	DTS100	04051204	O/P MON
Temperature Chamber	Zungdar	ZTH100U	10080065	O/P MON
Power Supply	Dahua	DH1716-5D	4001375	O/P MON
Power Supply	Dahua	SM70-45D	--	O/P MON
Digital Multimeter	FLUKE	179	91820401	2010/12/02
Thermo-hygrometer	AZ Instruments	8705	9151655	2010/12/07

O/P MON Output monitored with calibration equipment
 TU Traceability Unscheduled



Product Service

3.2 MEASUREMENT UNCERTAINTY

For a 95% confidence level, the measurement uncertainties for defined systems are:-

Test Discipline	Frequency / Parameter	MU
Conducted Maximum Peak Output Power	30MHz to 10GHz Amplitude	0.5dB*
Conducted Emissions	30MHz to 40GHz Amplitude	3.0dB*
Frequency Stability	30MHz to 2GHz Amplitude	$<1 \times 10^{-7}$
Radiated Emissions, Bilog Antenna, AOATS	30MHz to 1GHz Amplitude	5.1dB*
Radiated Emissions, Horn Antenna, AOATS	1GHz to 40GHz Amplitude	6.3dB*
Worst case error for both Time and Frequency measurement 12 parts in 10^6		

* In accordance with CISPR 16-4



Product Service

SECTION 4

ACCREDITATION, DISCLAIMERS AND COPYRIGHT



Product Service

4.1 ACCREDITATION, DISCLAIMERS AND COPYRIGHT



This report relates only to the actual item/items tested.

Our UKAS Accreditation does not cover opinions and interpretations and any expressed are outside the scope of our UKAS Accreditation.

Results of tests not covered by our UKAS Accreditation Schedule are marked NUA (Not UKAS Accredited).

This report must not be reproduced, except in its entirety, without the written permission of TÜV Product Service Limited

© 2010 TÜV Product Service Limited