



Product Service

**Choose certainty.
Add value.**

Report On

Limited FCC and Industry Canada Testing of the
Ericsson AB
RRU22 21IV40 / KRC 161 134/4

COMMERCIAL-IN-CONFIDENCE

FCC ID: TA8AKRC161134-4
IC ID: 287AB-AW1611344

Document 75911835 Report 01 Issue 1

December 2010



Product Service

TÜV Product Service Ltd, Octagon House, Concorde Way, Segensworth North,
Fareham, Hampshire, United Kingdom, PO15 5RL
Tel: +44 (0) 1489 558100. Website: www.tuvps.co.uk

COMMERCIAL-IN-CONFIDENCE

REPORT ON

Limited FCC and Industry Canada Testing of the
Ericsson AB
RRU22 21V40 / KRC 161 134/4

Document 75911835 Report 01 Issue 1

December 2010

PREPARED FOR

Ericsson AB
Torshamnsgatan 23
S-164 80
Stockholm
Sweden

PREPARED BY



X Zhang
Test Engineer

APPROVED BY

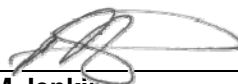

M Jenkins
Authorised Signatory

DATED

13 December 2010

ENGINEERING STATEMENT

The measurements shown in this report were made in accordance with the procedures described on test pages. All reported testing was carried out on a sample equipment to demonstrate limited compliance with FCC CFR 47 Part 2 and 27 and Industry Canada RSS-139 and RSS-GEN. The sample tested was found to comply with the requirements defined in the applied rules.

Test Engineer(s);



X Zhang



C Zhang





CONTENTS

Section	Page No
1	REPORT SUMMARY 3
1.1	Introduction 4
1.2	Brief Summary of Results 5
1.3	Declaration of Build Status 7
1.4	Product Information 8
1.5	Test Conditions 13
1.6	Deviations From the Standard 13
1.7	Modification Record 13
1.8	Alternative Test Site 13
2	TEST DETAILS 14
2.1	Maximum Peak Output Power - Conducted 15
2.2	Peak – Average Ratio 18
2.3	Occupied Bandwidth 29
2.4	Spurious Emissions at Antenna Terminals (± 1 MHz) 36
2.5	Radiated Spurious Emissions 50
2.6	Conducted Spurious Emissions 54
2.7	Receiver Spurious Emissions 74
3	TEST EQUIPMENT USED 82
3.1	Test Equipment Used 83
3.2	Measurement Uncertainty 84
4	ACCREDITATION, DISCLAIMERS AND COPYRIGHT 85
4.1	Accreditation, Disclaimers and Copyright 86



SECTION 1

REPORT SUMMARY

Limited FCC and Industry Canada Testing of the
Ericsson AB
RRU22 21IV40 / KRC 161 134/4



1.1 INTRODUCTION

The information contained in this report is intended to show verification of the Ericsson AB RRU22 21IV40 / KRC 161 134/4 to the requirements of FCC CFR 47 Part 2 and 27 and Industry Canada RSS-139 and RSS-GEN.

Testing was carried out in support of a C2PC application for Grant of RRU22 21IV40 / KRC 161 134/4 for the hardware update.

Objective	To perform FCC and Industry Canada Testing to determine the Equipment Under Test's (EUT's) compliance with the Test Specification, for the series of tests carried out.
Manufacturer	Ericsson AB
Product Name	RRU22 21IV40
Part Number	KRC 161 134/4
IC Model Name	AW1611344
Serial Number(s)	CB4E788284
Software Version	CXP9012183%7_R9YL
Hardware Version	R2C
Number of Samples Tested	1
Test Specification/Issue/Date	FCC CFR 47 Part 2: 2009 FCC CFR 47 Part 27: 2009 Industry Canada RSS-139: 2009 Industry Canada RSS-GEN Issue 2: 2007
Incoming Release Date	Declaration of Build Status 09 November 2010
Order Number Date	PTP 19 November 2010
Start of Test	09 November 2010
Finish of Test	03 December 2010
Name of Engineer(s)	X Zhang C Zhang
Related Document(s)	ANSI C63.4: 2003



1.2 BRIEF SUMMARY OF RESULTS

A brief summary of results in accordance with FCC CFR 47 Part 2 and 27 and Industry Canada RSS-139 and RSS-GEN, is shown below.

Configuration – Base Station							
Section	Spec Clause		Test Description	Mode	Mod State	Result	Comments
	FCC Part 2 and 27	RSS-139 and RSS-GEN					
	27.50 (d)(1)	6.4	Effective Radiated Power	2112.4MHz		N/A	No integral antenna.
				2132.4MHz		N/A	
				2152.6MHz		N/A	
				2112.4MHz + 2132.4MHz		N/A	
				2127.4MHz + 2137.4MHz		N/A	
				2142.6MHz + 2152.6MHz		N/A	
2.1	2.1046, 27.50 (d)(1)	6.4	Maximum Peak Output Power - Conducted	2112.4MHz	0	Pass	-
				2132.4MHz	0	Pass	
				2152.6MHz	0	Pass	
				2112.4MHz + 2122.4MHz	0	Pass	
				2127.4MHz + 2137.4MHz	0	Pass	
				2142.6MHz + 2152.6MHz	0	Pass	
2.2	27.50 (i)	-	Peak – Average Ratio	2112.4MHz	0	Pass	-
				2132.4MHz	0	Pass	
				2152.6MHz	0	Pass	
				2112.4MHz + 2122.4MHz	0	Pass	
				2127.4MHz + 2137.4MHz	0	Pass	
				2142.6MHz + 2152.6MHz	0	Pass	
2.3	2.1049, 27.53 (h)	RSS-Gen 4.6.1	Occupied Bandwidth	2112.4MHz	0	Pass	-
				2132.4MHz	0	Pass	
				2152.6MHz	0	Pass	
				2112.4MHz + 2122.4MHz		N/A	
				2127.4MHz + 2137.4MHz		N/A	
				2142.6MHz + 2152.6MHz		N/A	
2.4	2.1051, 27.53 (h)	6.5	Spurious Emissions at Antenna Terminals (±1MHz)	2112.4MHz	0	Pass	-
				2132.4MHz		N/A	
				2152.6MHz	0	Pass	
				2112.4MHz + 2122.4MHz	0	Pass	
				2127.4MHz + 2137.4MHz		N/A	
				2142.6MHz + 2152.6MHz	0	Pass	



Configuration – Base Station							
Section	Spec Clause		Test Description	Mode	Mod State	Result	Comments
	FCC Part 2 and 27	RSS-139 and RSS-GEN					
2.5	2.1053, 27.53 (h)	6.5	Radiated Spurious Emissions	2112.4MHz	0	Pass	-
				2132.4MHz	0	Pass	
				2152.6MHz	0	Pass	
				2112.4MHz + 2122.4MHz	0	Pass	
				2127.4MHz + 2137.4MHz	0	Pass	
				2142.6MHz + 2152.6MHz	0	Pass	
2.6	2.1051, 27.53 (h)	6.5	Conducted Spurious Emissions	2112.4MHz	0	Pass	-
				2132.4MHz	0	Pass	
				2152.6MHz	0	Pass	
				2112.4MHz + 2122.4MHz	0	Pass	
				2127.4MHz + 2137.4MHz	0	Pass	
				2142.6MHz + 2152.6MHz	0	Pass	
	2.1055, 27.54	6.3	Frequency Stability Under Temperature Variations	2112.4MHz		N/T	Not tested ¹
				2132.4MHz		N/T	
				2152.6MHz		N/T	
				2112.4MHz + 2122.4MHz		N/T	
				2127.4MHz + 2137.4MHz		N/T	
				2142.6MHz + 2152.6MHz		N/T	
	2.1055, 27.54	6.3	Frequency Stability Under Voltage Variations	2112.4MHz		N/T	Not tested ¹
				2132.4MHz		N/T	
				2152.6MHz		N/T	
				2112.4MHz + 2122.4MHz		N/T	
				2127.4MHz + 2137.4MHz		N/T	
				2142.6MHz + 2152.6MHz		N/T	
2.7	-	6.6	Receiver Spurious Emissions	2112.4MHz		N/A	-
				2132.4MHz	0	Pass	
				2152.6MHz		N/A	
				2112.4MHz + 2122.4MHz		N/A	
				2127.4MHz + 2137.4MHz	0	Pass	
				2142.6MHz + 2152.6MHz		N/A	

N/A – Not Applicable

Note¹ – Limited testing has been performed as this report is to be used as justification for a Class II Permissive Change. See section 1.6.



Product Service

1.3 DECLARATION OF BUILD STATUS

MAIN EUT	
MANUFACTURING DESCRIPTION	Radio Equipment
MANUFACTURER	Ericsson AB
PRODUCT NAME	RRU22 21IV40
PART NUMBER	KRC 161 134/4
IC Model Name	AW1611344
SERIAL NUMBER	CB4E788284
HARDWARE VERSION	R2C
SOFTWARE VERSION	CXP9012183%7_R9YL
TRANSMITTER OPERATING RANGE	TX: 2112.4MHz - 2152.6MHz RX: 1712.4MHz - 1752.6MHz
MODULATIONS	QPSK, 16QAM, 64QAM
INTERMEDIATE FREQUENCIES	--
ITU DESIGNATION OF EMISSION	4M17F9W
OUTPUT POWER (RMS) (W or dBm)	Single Carrier: 1 x 46dBm (1 x 40W) Multi Carrier: 2 x 43dBm (2 x 20W)
FCC ID	TA8AKRC161134-4
IC ID	287AB-AW1611344
TECHNICAL DESCRIPTION (a brief description of the intended use and operation)	The equipment is the Radio Part of WCDMA Base Station.

Signature

Date

30 November 2010

D of B S Serial No

75911835 /01

No responsibility will be accepted by TÜV Product Service as to the accuracy of the information declared in this document by the manufacturer.



1.4 PRODUCT INFORMATION

1.4.1 Technical Description

The Equipment Under Test (EUT) RRU22 21V40 / KRC 161 134/4 is an Ericsson AB Radio Equipment working in the public mobile service 2100MHz band which provides communication connections to WCDMA2100 network. The RRU22 21V40 / KRC 161 134/4 operates from a -48V DC volt supply.

The Equipment Under Test (EUT) is shown in the photograph below. A full technical description can be found in the Manufacturers documentation.



Equipment Under Test



Product Service

1.4.2 Test Configuration

Configuration 1: Radio Unit

The EUT was configured in accordance with FCC CFR 47 Part 27 and Industry Canada RSS-139.

The RRU22 21V40 / KRC 161 134/4 supports Test Models TM1, TM5 and TM6 at 2100MHz defined in 3GPP TS 25.141. Test Model 1 (TM1) uses the QPSK modulation only, Test Model 5 (TM5) includes 16QAM modulation and Test Model 6 (TM6) includes 64QAM modulation as follows:

Single carrier:

Test Model 1 (TM1): 64 DPCHs at 30 ksps (SF=128)

Test Model 5 (TM5): 30 DPCHs at 30 ksps (SF=128) and 8 HS-PDSCHs at 240 ksps (SF=16)

Test Model 6 (TM6): 30 DPCHs at 30 ksps (SF=128) and 8 HS-PDSCHs at 240 ksps (SF=16)

Multi carrier:

Test model 1 (TM1): 32 DPCHs at 30 ksps (SF=128)

Test model 5 (TM5): 30 DPCHs at 30 ksps (SF=128) and 8 HS-PDSCHs at 240 ksps (SF=16)

Test model 6 (TM6): 30 DPCHs at 30 ksps (SF=128) and 8 HS-PDSCHs at 240 ksps (SF=16)

The EUT can be configured to transmit with 2100MHz single or multi carrier at the RF output connector. All Tx Testing was performed on the combined Tx / Rx output connector ANT1 and the Rx testing was performed on the Rx connector ANT2 of the EUT. The complete testing was performed with the EUT transmitting at maximum RF power unless otherwise stated. The EUT was powered by a -48V DC Power supply.



Test Setup, Conducted Measurement:

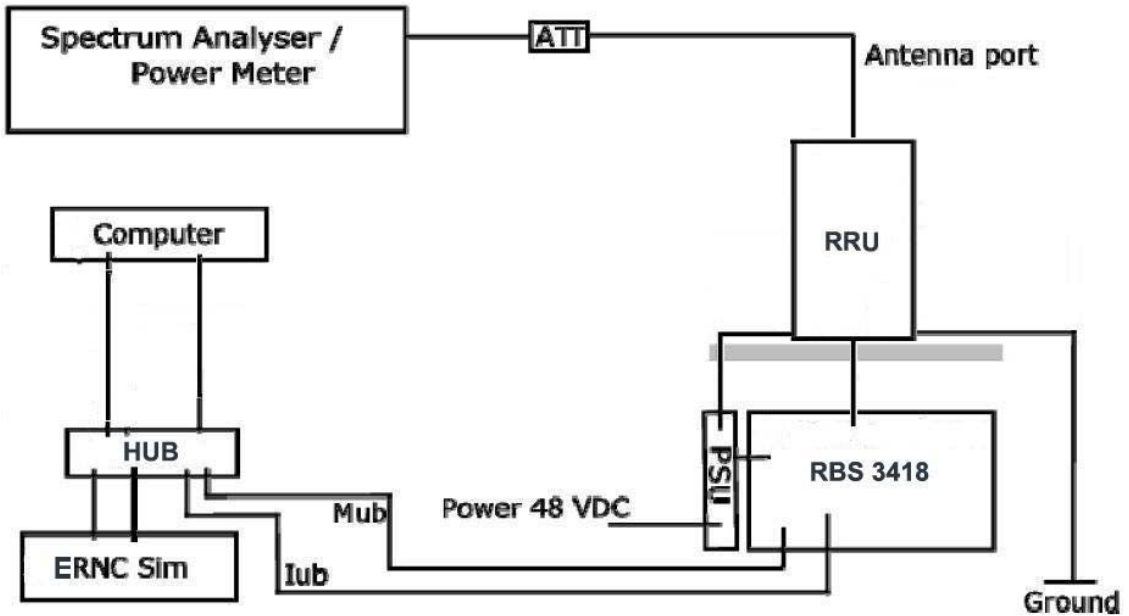

Test Object	Part Number	Version	Serial Number
Radio Part	RRU22 21IV40 / KRC 161 134/4	R2C	CB4E788284

Auxiliary Equipment	Part Number / Model Type	Version	Serial Number
Computer	SunBlade 1500	--	MT41130005
RBS 3418	1/BFE 401 1019	R1C	TA64037772
HUB	10 BASE-T Ethernet HUB	--	--
ERNC Sim	ROJ 119 2106/53	R4E	TU8GH19419
AC PSU	BML 901 192/1	R1B	K7093423964W0
ACCU	BMG 907 040/1	RIB	BV61146267
Power Metre	Rohde & Schwarz NRP	--	17-294752
Thermal Power Sensor	Rohde & Schwarz NRP-Z51	--	20-295642
Spectrum Analyzer	FSQ26	--	20-300542



Test Setup, Radiated Measurement:

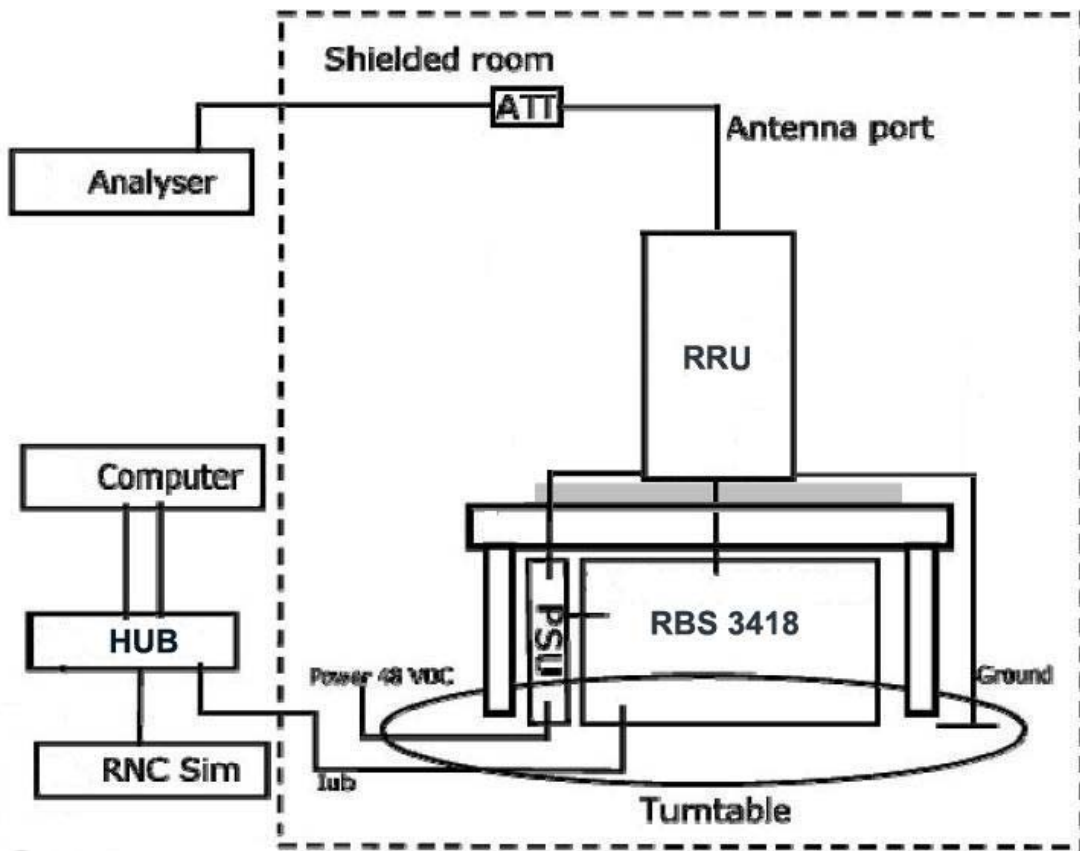

Test Object	Part Number	Version	Serial Number
Radio Part	RRU22 21IV40 / KRC 161 134/4	R2C	CB4E788284

Auxiliary Equipment	Part Number / Model Type	Version	Serial Number
Computer	SunBlade 1500	--	MT41130005
RBS 3418	1/BFE 401 1019	R1C	TA64037772
HUB	10 BASE-T Ethernet HUB	--	--
RNC Sim	4780A	REV:AAA	0208
Power Supply	DH1716-5D	--	--
EMI Receiver	Rohde & Schwarz ESI 40	--	100015



Product Service

1.4.3 Modes of Operation

Modes of operation of each EUT during testing were as follows:

Mode 1 - ARFCN 1537: 2112.4MHz (Bottom Channel)

Mode 2 - ARFCN 1637: 2132.4MHz (Middle Channel)

Mode 3 - ARFCN 1738: 2152.6MHz (Top Channel)

Mode 4 - ARFCN 1537 + 1587: 2112.4MHz + 2122.4MHz

Mode 5 - ARFCN 1612 + 1662: 2127.4MHz + 2137.4MHz

Mode 6 - ARFCN 1688 + 1738: 2142.6MHz + 2152.6MHz

Information on the specific test modes utilised are detailed in the test procedure for each individual test.



Product Service

1.5 TEST CONDITIONS

For all tests the EUT was set up in accordance with the relevant test standard and to represent typical operating conditions. Tests were applied with the EUT situated in a wooden frame, test laboratories or a chamber as appropriate.

The EUT was powered from a -48V DC supply.

1.6 DEVIATIONS FROM THE STANDARD

Full testing has not been carried out in accordance with the specifications because this report is to be used as justification for a Class II Permissive Change to the EUT for the hardware update. This report verifies maintained performance of the EUT for the affected characteristics according to the FCC CFR 47 Part 2.1043 by re-testing the updated equipment as described in section 1.4.2.

1.7 MODIFICATION RECORD

No modifications were made to the EUT during testing.

1.8 ALTERNATIVE TEST SITE

Testing has been performed under the following site registrations:

FCC Accreditation 910917:

The State Radio Monitoring Centre, No.80 Beilishi Road Xicheng District Beijing, China.

Industry Canada Accreditation 7308A:

The State Radio Monitoring Centre, No.80 Beilishi Road Xicheng District Beijing, China.



Product Service

SECTION 2

TEST DETAILS

Limited FCC and Industry Canada Testing of the
Ericsson AB
RRU22 21IV40 / KRC 161 134/4



Product Service

2.1 MAXIMUM PEAK OUTPUT POWER - CONDUCTED

2.1.1 Specification Reference

FCC CFR 47 Part 2, Clause 2.1046
 FCC CFR 47 Part 27, Clause 27.50 (d)(1)
 Industry Canada RSS-139, Clause 6.4

2.1.2 Equipment Under Test

RRU22 21V40 / KRC 161 134/4, S/N: CB4E788284

2.1.3 Date of Test and Modification State

12 and 15 November 2010 – Modification State 0

2.1.4 Test Equipment Used

The major items of test equipment used for the above tests are identified in Section 3.1.

2.1.5 Test Method and Operating Modes

The test was applied in accordance with the test method requirements of FCC CFR 47 Part 2 and Part 27 and Industry Canada RSS-139.

Using a power meter and attenuator(s), the output power of the EUT was measured at the antenna terminal. The carrier power was measured with QPSK, 16QAM and 64QAM using the test model described.

The path loss was measured and entered as a reference level offset.

The test was performed with the EUT in the following configurations and modes of operation:

Configuration 1 - Mode 1
 - Mode 2
 - Mode 3
 - Mode 4
 - Mode 5
 - Mode 6

2.1.6 Environmental Conditions

	12 November 2010	15 November 2010
Ambient Temperature	19.8°C	21.1°C
Relative Humidity	26.4%	22.0%



2.1.7 Test Results

For the period of test the EUT met the requirements of FCC CFR 47 Part 2 and Part 27 and Industry Canada RSS-139 for Maximum Peak Output Power.

The test results are shown below

Single Carrier

Configuration 1 - Mode 1, 2 and 3

TM1

UARFCN	Frequency (MHz)	Path Loss (dB)	Result (dBm) RMS	Result (W) RMS
1537 (Bottom)	2112.4	41.2	45.97	39.54
1637 (Middle)	2132.4	41.2	45.97	39.54
1738 (Top)	2152.6	41.2	45.88	38.73

TM5

UARFCN	Frequency (MHz)	Path Loss (dB)	Result (dBm) RMS	Result (W) RMS
1537 (Bottom)	2112.4	41.2	45.98	39.63
1637 (Middle)	2132.4	41.2	45.96	39.45
1738 (Top)	2152.6	41.2	45.88	38.73

TM6

UARFCN	Frequency (MHz)	Path Loss (dB)	Result (dBm) RMS	Result (W) RMS
1537 (Bottom)	2112.4	41.2	45.72	37.33
1637 (Middle)	2132.4	41.2	45.69	37.07
1738 (Top)	2152.6	41.2	45.69	37.07



Multi Carrier

Configuration 1 - Mode 4, 5 and 6

TM1

UARFCN	Frequency (MHz)	Path Loss (dB)	Result (dBm) RMS	Result (W) RMS
1537 & 1587	2112.4 & 2122.4	41.2	45.87	38.64
1612 & 1662	2127.4 & 2137.4	41.2	45.93	39.17
1688 & 1738	2142.6 & 2152.6	41.2	45.90	38.90

TM5

UARFCN	Frequency (MHz)	Path Loss (dB)	Result (dBm) RMS	Result (W) RMS
1537 & 1587	2112.4 & 2122.4	41.2	45.87	38.64
1612 & 1662	2127.4 & 2137.4	41.2	45.92	39.08
1688 & 1738	2142.6 & 2152.6	41.2	45.90	38.90

TM6

UARFCN	Frequency (MHz)	Path Loss (dB)	Result (dBm) RMS	Result (W) RMS
1537 & 1587	2112.4 & 2122.4	41.2	45.63	36.56
1612 & 1662	2127.4 & 2137.4	41.2	45.67	36.90
1688 & 1738	2142.6 & 2152.6	41.2	45.69	37.07

Limit	≤3280W or ≤65.2dBm
-------	--------------------

Remarks

The EUT does not exceed 3280W or 65.2dBm at the measured frequencies.



Product Service

2.2 PEAK – AVERAGE RATIO

2.2.1 Specification Reference

FCC CFR 47 Part 27, Clause 27.50 (i)

2.2.2 Equipment Under Test

RRU22 21IV40 / KRC 161 134/4, S/N: CB4E788284

2.2.3 Date of Test and Modification State

12, 15 and 30 November 2010 – Modification State 0

2.2.4 Test Equipment Used

The major items of test equipment used for the above tests are identified in Section 3.1.

2.2.5 Test Method and Operating Modes

The test was applied in accordance with the test method requirements of FCC CFR 47 Part 27.

A peak to average ratio measurement is performed at the conducted port of the EUT. The spectrum analyzers Complementary Cumulative Distribution Function (CCDF) measurement profile is used to determine the largest deviation between the average and the peak power of the EUT in given bandwidth. The CCDF curve shows how much time the peak waveform spends at or above a given average power level. The percent of time the signal spends at or above the level defines the probability for that particular power level.

The spectrum analyzer Measurement bandwidth was set to 10MHz for single carrier and 20MHz for multi carrier and the path loss measured and entered as a reference level offset.

The test was performed with the EUT operating on all modes in section 1.4.3 and record the result of following configurations and modes of operation for worst case:

Configuration 1 - Mode 1
 - Mode 2
 - Mode 3
 - Mode 4
 - Mode 5
 - Mode 6

2.2.6 Environmental Conditions

	12 November 2010	15 November 2010	30 November 2010
Ambient Temperature	19.8°C	21.1°C	22.0°C
Relative Humidity	26.4%	22.0%	24.7%



2.2.7 Test Results

For the period of test the EUT met the requirements of FCC CFR 47 Part 27 Peak – Average Ratio.

The test results are shown below.

Single Carrier

Configuration 1 - Mode 1

TM1

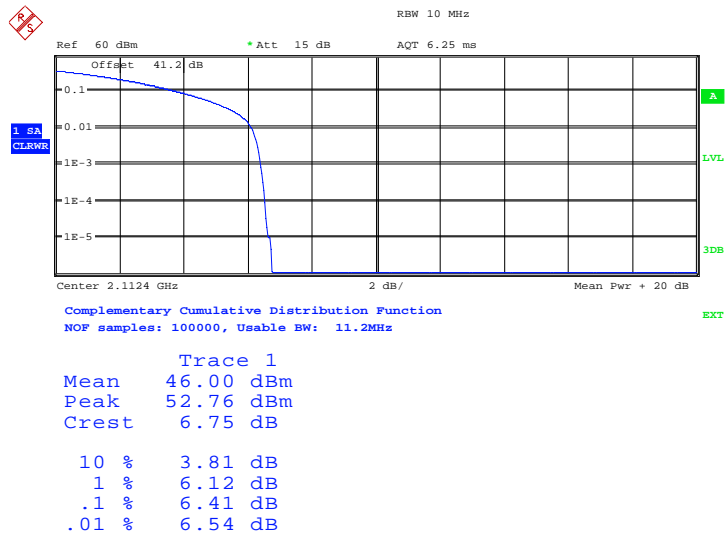

Date: 12.NOV.2010 03:33:31



Product Service

TM5

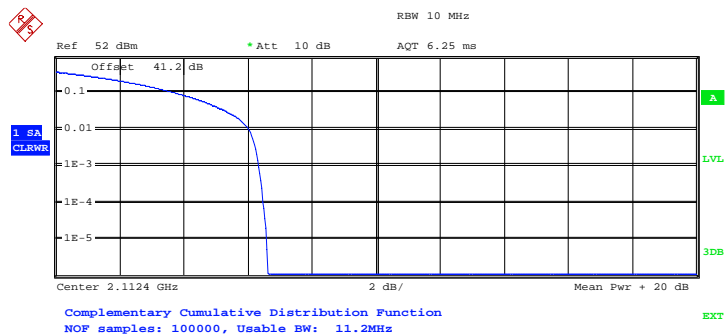

Trace 1
Mean 45.92 dBm
Peak 52.53 dBm
Crest 6.60 dB

10 % 3.75 dB
1 % 6.03 dB
.1 % 6.35 dB
.01 % 6.47 dB

Date: 12.NOV.2010 07:08:36

TM6

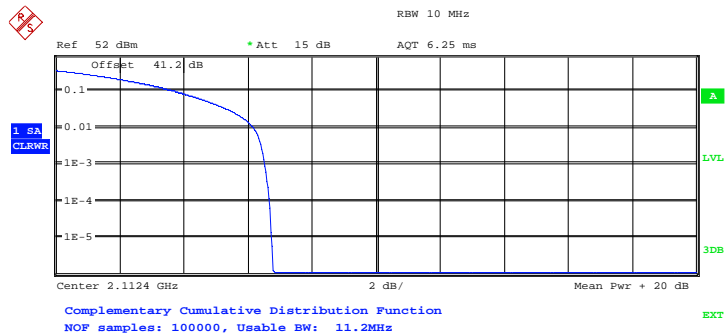

Trace 1
Mean 45.69 dBm
Peak 52.48 dBm
Crest 6.79 dB

10 % 3.75 dB
1 % 6.15 dB
.1 % 6.54 dB
.01 % 6.67 dB

Date: 12.NOV.2010 07:16:11



Product Service

Configuration 1 - Mode 2

TM1

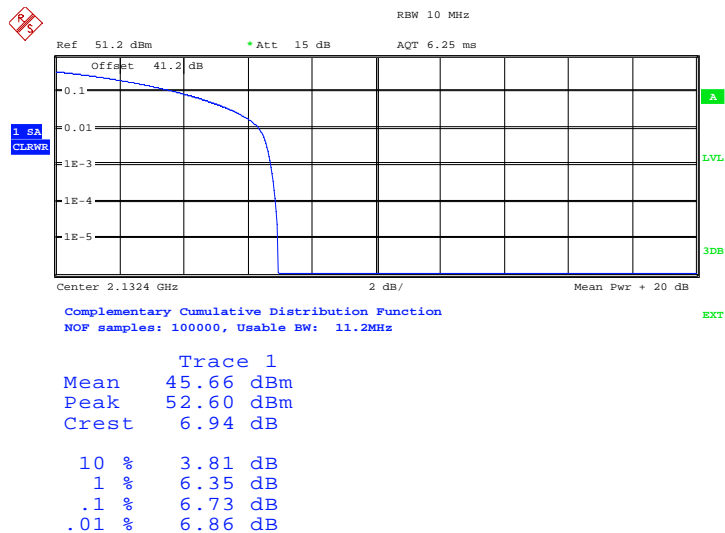

Date: 15.NOV.2010 04:18:00

TM5

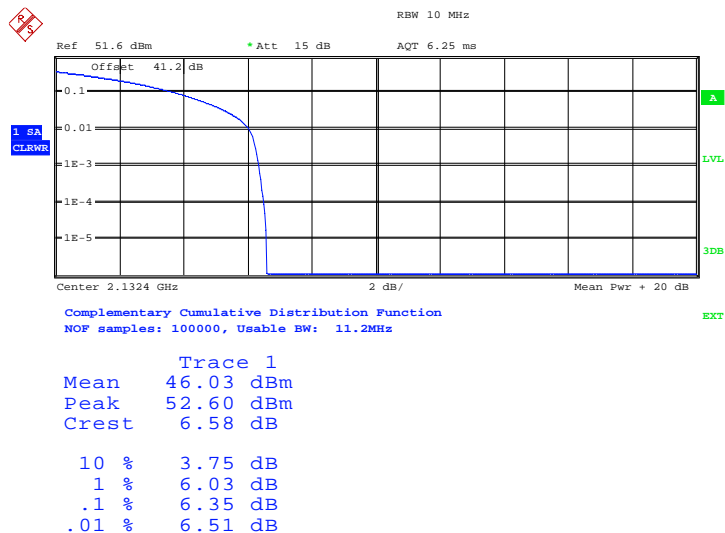

Date: 15.NOV.2010 03:50:54



Product Service

TM6

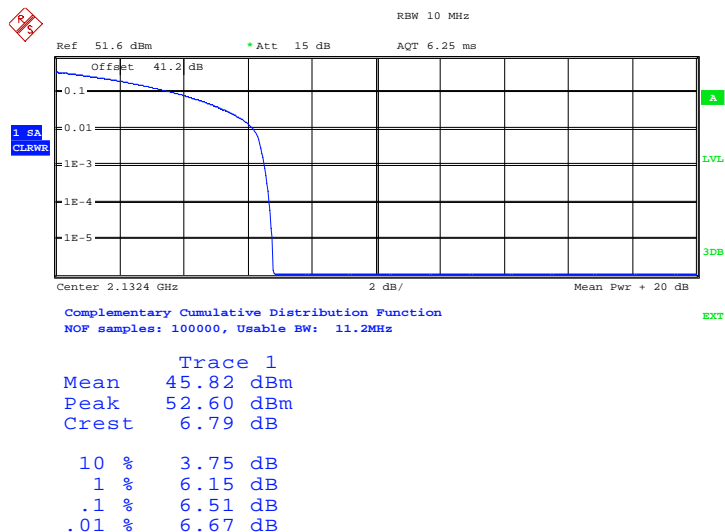

Date: 15.NOV.2010 03:38:46

Configuration 1 - Mode 3

TM1

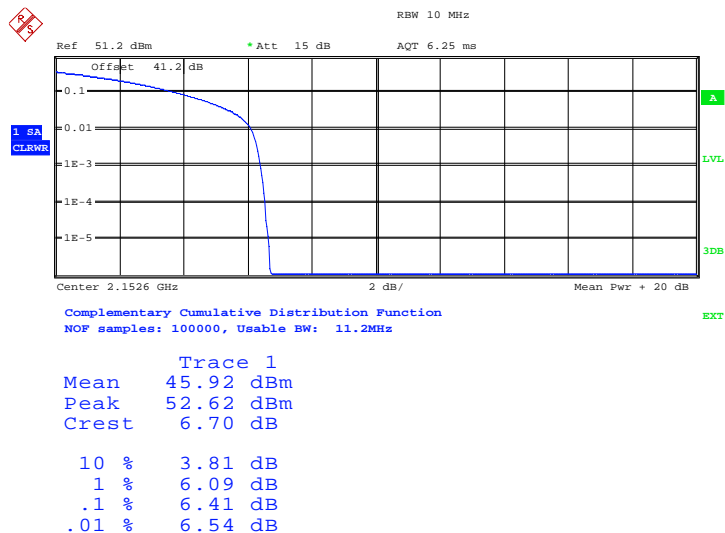

Date: 12.NOV.2010 08:30:34



Product Service

TM5

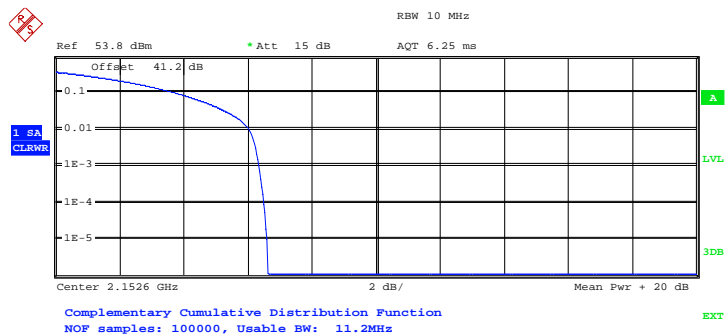

Trace 1

Mean	45.58 dBm
Peak	52.20 dBm
Crest	6.63 dB
10 %	3.75 dB
1 %	6.03 dB
.1 %	6.35 dB
.01 %	6.51 dB

Date: 30.NOV.2010 03:15:28

TM6

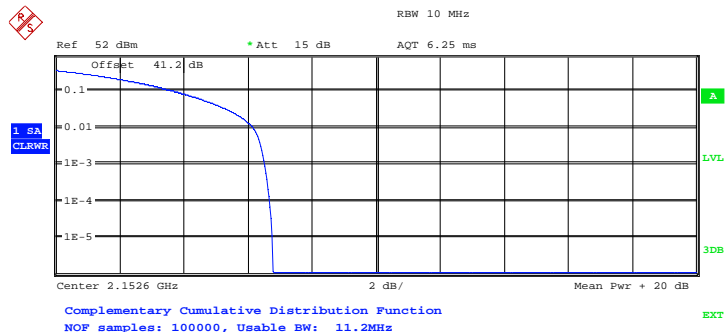

Trace 1

Mean	45.72 dBm
Peak	52.49 dBm
Crest	6.77 dB
10 %	3.72 dB
1 %	6.15 dB
.1 %	6.54 dB
.01 %	6.67 dB

Date: 15.NOV.2010 03:16:45



Product Service

Multi Carrier

Configuration 1 - Mode 4

TM1

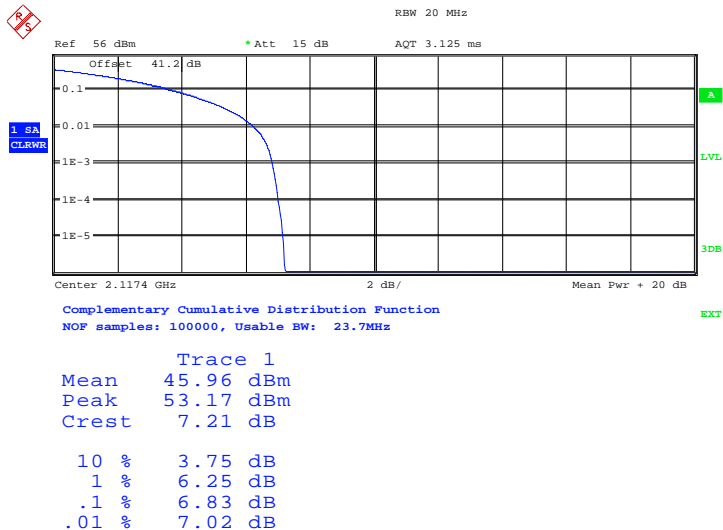

Date: 15.NOV.2010 07:26:27

TM5

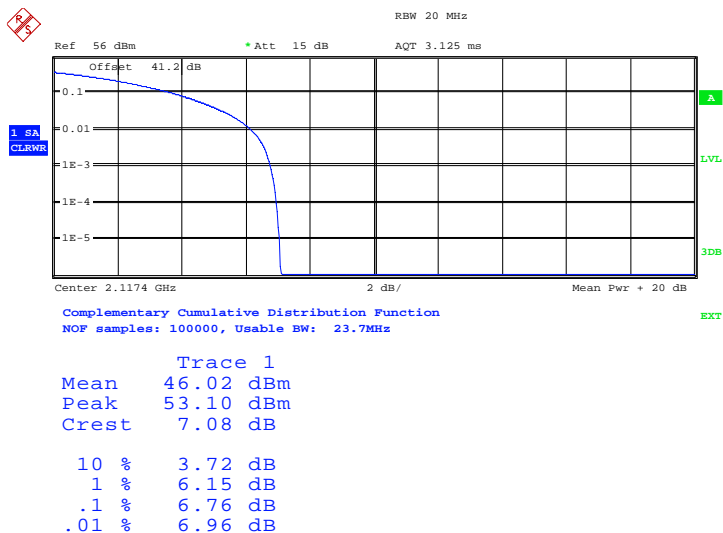

Date: 15.NOV.2010 09:08:29



TM6

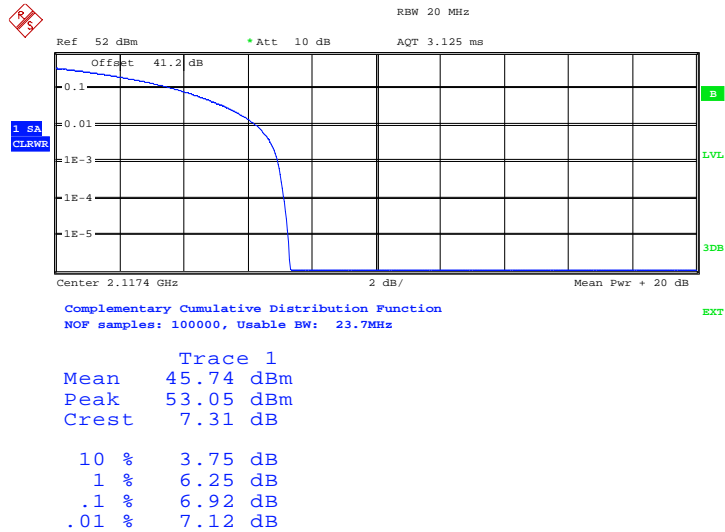

Date: 15.NOV.2010 09:37:18

Configuration 1 - Mode 5

TM1

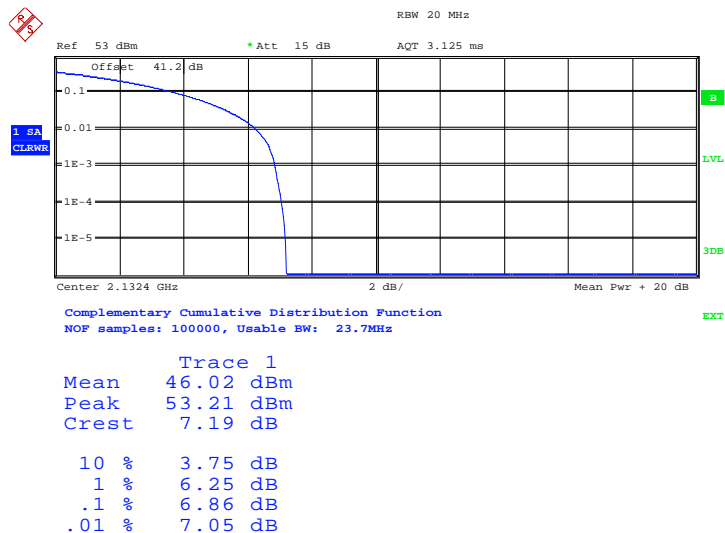

Date: 15.NOV.2010 07:06:28



Product Service

TM5

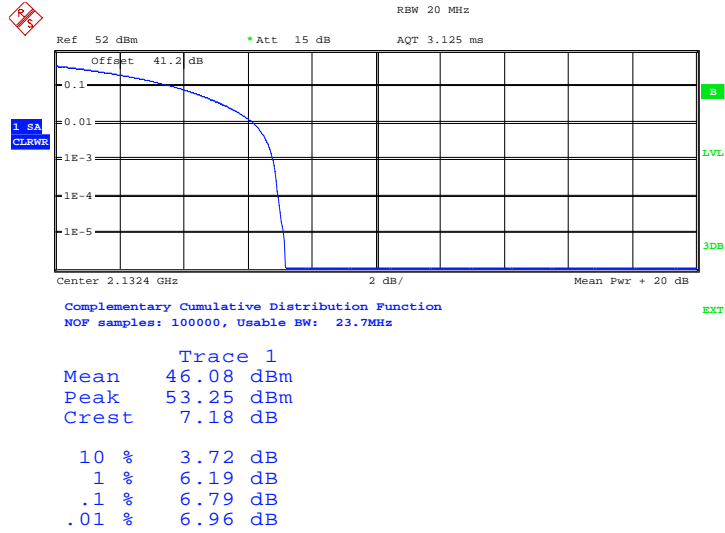

Date: 15.NOV.2010 06:57:57

TM6

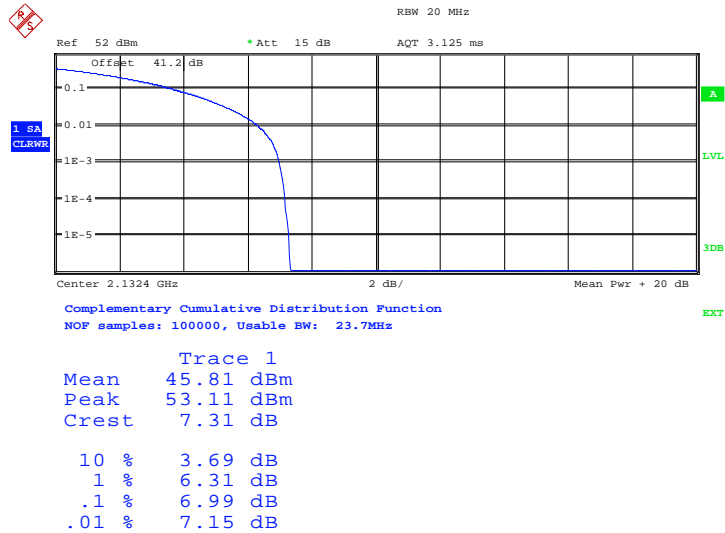

Date: 15.NOV.2010 06:42:45



Product Service

Configuration 1 - Mode 6

TM1

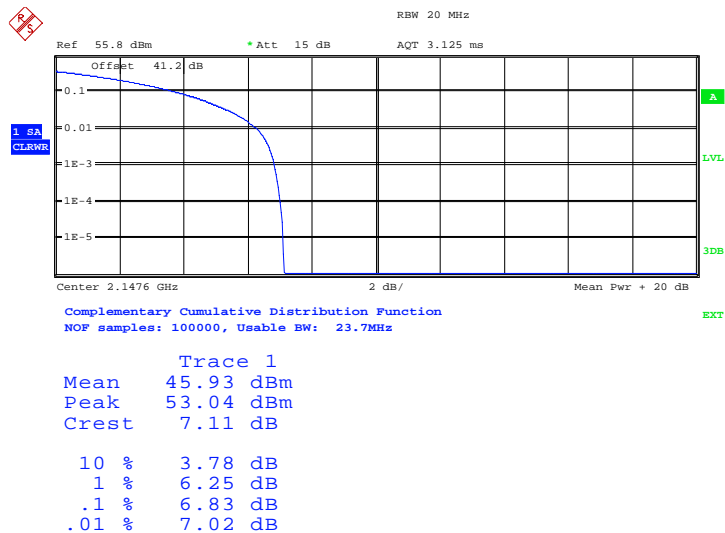

Date: 15.NOV.2010 10:21:40

TM5

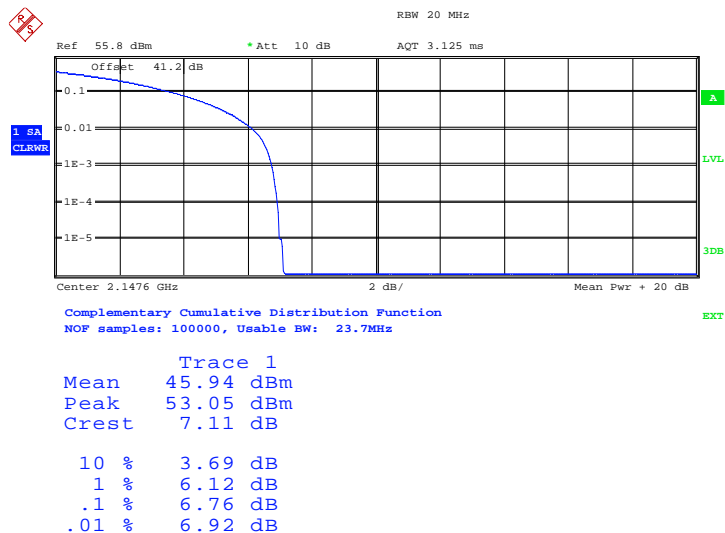

Date: 15.NOV.2010 10:09:49



Product Service

TM6

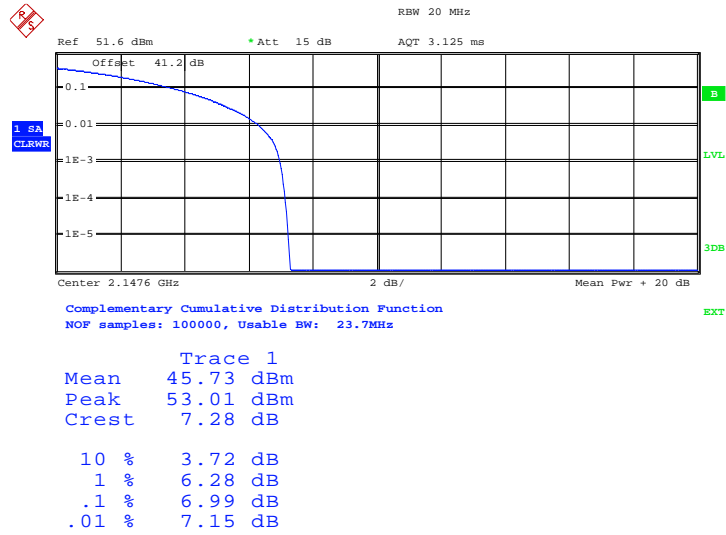

Date: 15.NOV.2010 09:48:52

Limit	13dB
-------	------

Remarks

The Peak – Average ratio does not exceed 13dB at the measured frequencies.



Product Service

2.3 OCCUPIED BANDWIDTH

2.3.1 Specification Reference

FCC CFR 47 Part 2, Clause 2.1049 (h)
 FCC CFR 47 Part 27, Clause 27.53 (h)
 Industry Canada RSS-GEN, Clause 4.6.1

2.3.2 Equipment Under Test

RRU22 21IV40 / KRC 161 134/4, S/N: CB4E788284

2.3.3 Date of Test and Modification State

12, 15 November and 03 December 2010 – Modification State 0

2.3.4 Test Equipment Used

The major items of test equipment used for the above tests are identified in Section 3.1.

2.3.5 Test Method and Operating Modes

The test was applied in accordance with the test method requirements of FCC CFR 47 Part 2 and Part 27 and Industry Canada RSS-GEN.

The EUT was transmitting at maximum power, modulated using the test model described. Using a resolution bandwidth of 50kHz and a video bandwidth of 500kHz. The occupied bandwidth, that is the frequency bandwidth such that, below its lower and above its upper frequency limits, the mean powers radiated are each equal to 0.5 percent of the total mean power radiated by a given emission. The -26dBc points were also established and the emission bandwidth determined.

The test was performed with the EUT in the following configurations and modes of operation:

Configuration 1 - Mode 1
 - Mode 2
 - Mode 3

2.3.6 Environmental Conditions

	12 November 2010	15 November 2010	03 December 2010
Ambient Temperature	19.8°C	21.1°C	22.3°C
Relative Humidity	26.4%	22.0%	22.1%



Product Service

TM5

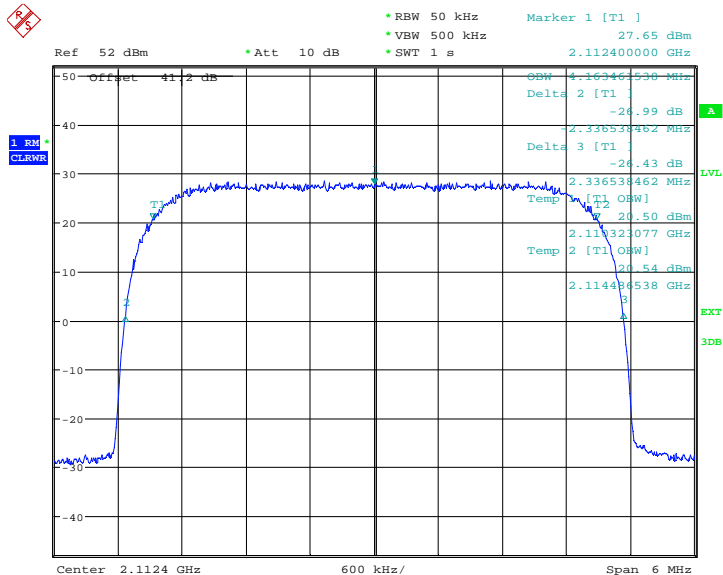

Date: 12.NOV.2010 07:06:36

TM6

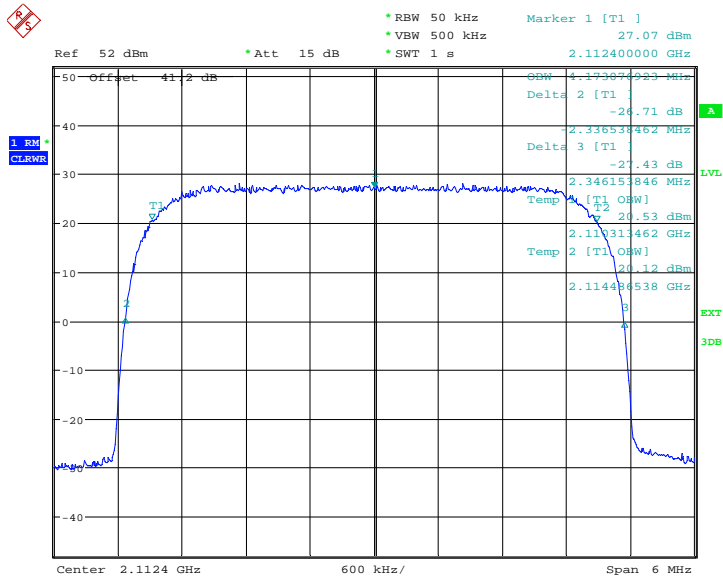

Date: 12.NOV.2010 07:18:25



Configuration 1 - Mode 2

TM1

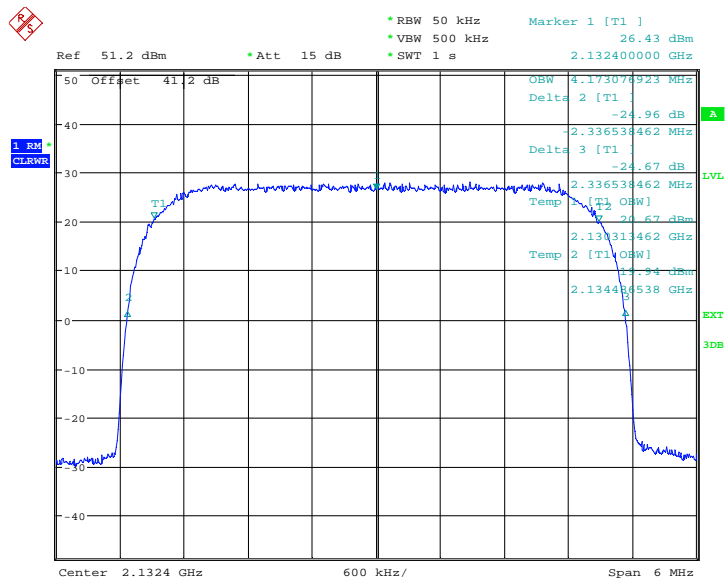

Date: 15.NOV.2010 04:19:24

TM5

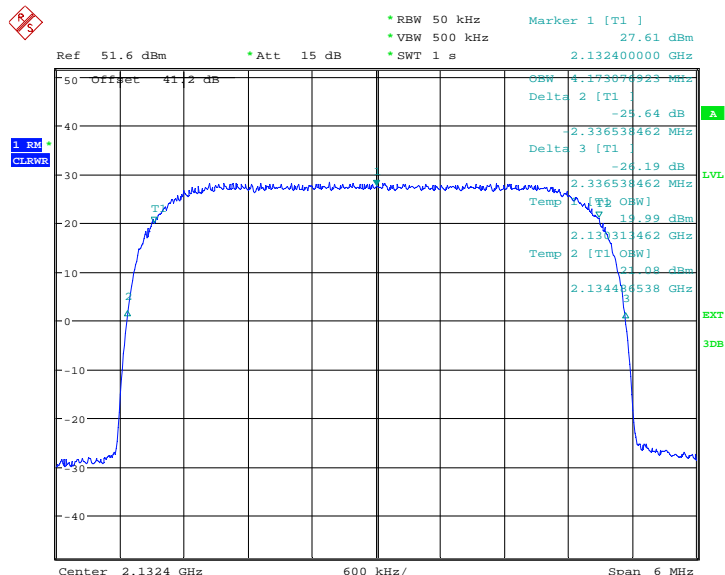

Date: 15.NOV.2010 03:54:15



Product Service

TM6

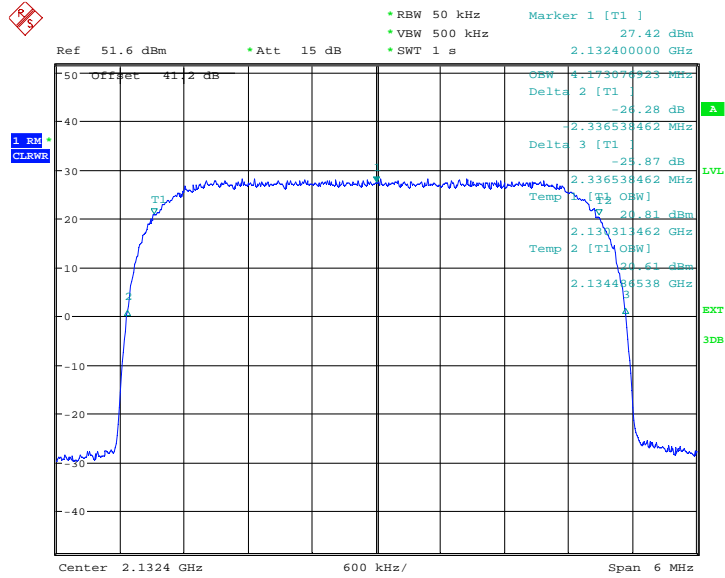

Date: 15.NOV.2010 03:39:14

Configuration 1 - Mode 3

TM1

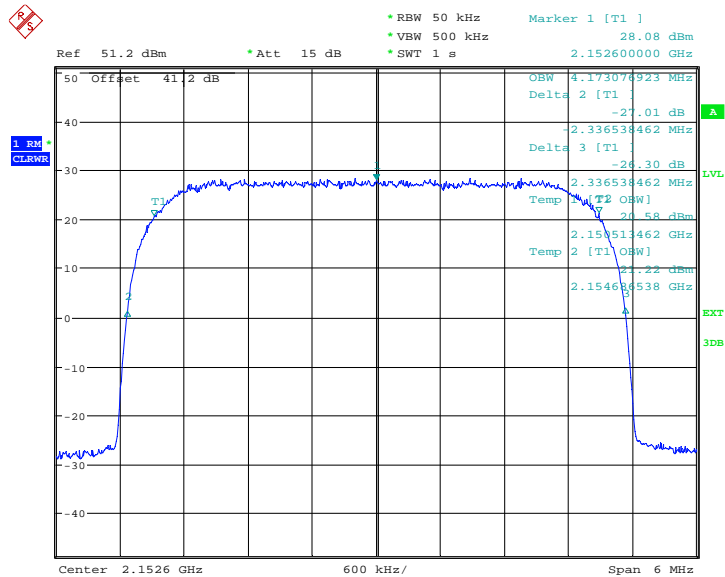

Date: 12.NOV.2010 08:32:31



Product Service

TM5

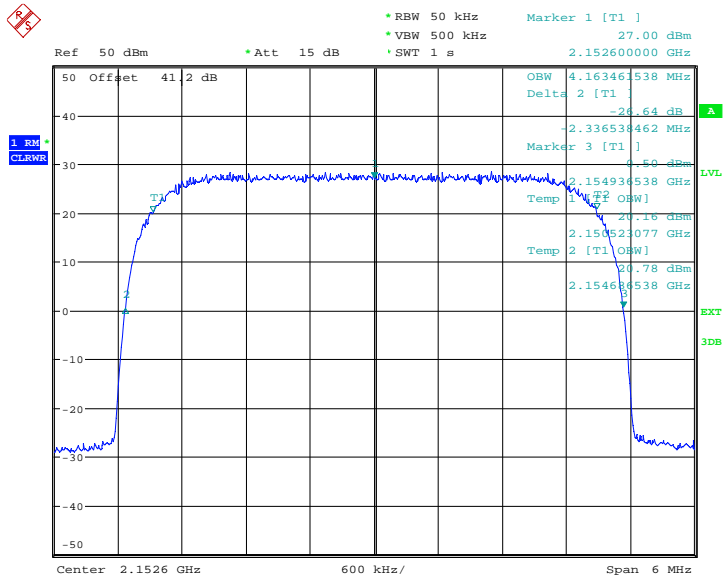

Date: 12.NOV.2010 09:02:47

TM6

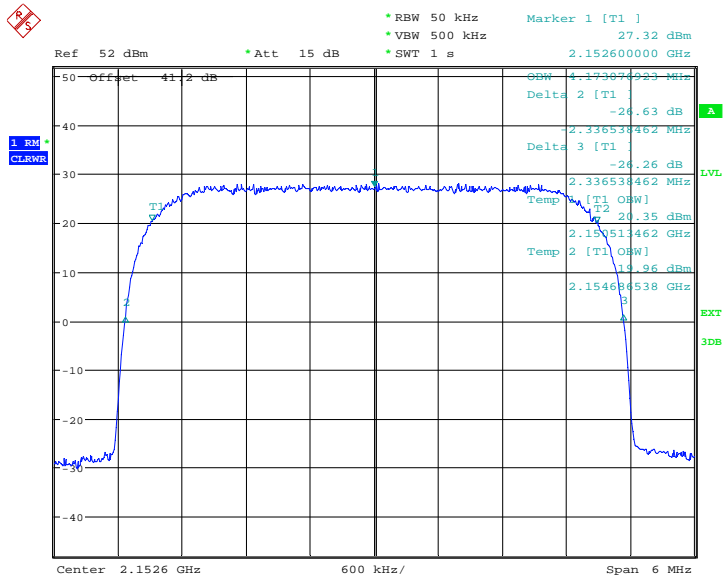

Date: 15.NOV.2010 03:18:17



Product Service

-26dBc Bandwidth

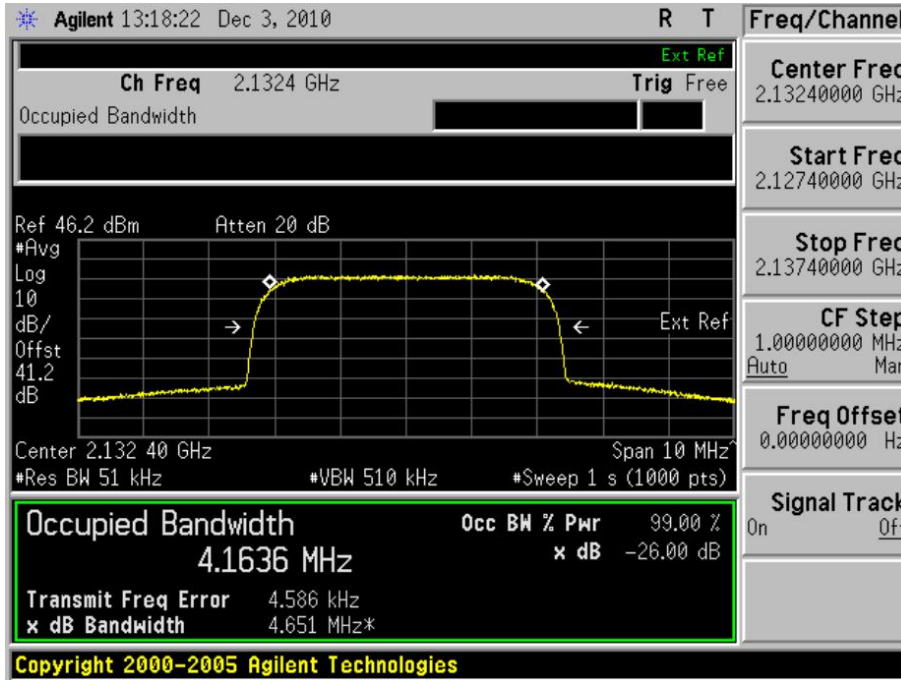



Product Service

2.4 SPURIOUS EMISSIONS AT ANTENNA TERMINALS (± 1 MHz)

2.4.1 Specification Reference

FCC CFR 47 Part 2, Clause 2.1051
 FCC CFR 47 Part 27, Clause 27.53 (h)
 Industry Canada RSS-139 Clause 6.5

2.4.2 Equipment Under Test

RRU22 21V40 / KRC 161 134/4, S/N: CB4E788284

2.4.3 Date of Test and Modification State

12, 15 and 30 November 2010 – Modification State 0

2.4.4 Test Equipment Used

The major items of test equipment used for the above tests are identified in Section 3.1.

2.4.5 Test Method and Operating Modes

The test was applied in accordance with the test method requirements of FCC CFR 47 Part 2 and Part 27 and Industry Canada RSS-139.

In accordance with 27.53(h), at least 1% of the 26dB bandwidth was used for the resolution and video bandwidths up to 1MHz away from the block edge. A resolution bandwidth of 50kHz was used between 1MHz to 5MHz away from the band edge. As the FCC rules specify a RBW of 1MHz for measurements of emissions > 1MHz away from the band edges, the limit was adjusted with -13dB to -26dBm to compensate for the reduce measurement bandwidth. Spectrum analyser detector was set as RMS.

The path loss measured and entered as a reference level offset.

The EUT was tested at it's maximum power level.

The test was performed with the EUT in the following configurations and modes of operation:

Configuration 1 - Mode 1
 - Mode 3
 - Mode 4
 - Mode 6

2.4.6 Environmental Conditions

	12 November 2010	15 November 2010	30 November 2010
Ambient Temperature	19.8°C	21.1°C	22.0°C
Relative Humidity	26.4%	22.0%	24.7%



Product Service

2.4.7 Test Results

For the period of test the EUT met the requirements of FCC CFR 47 Part 2 and Part 27 and Industry Canada RSS-139 for Spurious Emissions Antenna Terminals (± 1 MHz)

Below are the Frequencies the EUT was tested against along with the tested channels.

Single Carrier

Configuration 1 - Modes 1 and 3

TM1, TM5 and TM6

Band Edge Frequency	Edge Test with QPSK modulation Channel No./Frequencies	Edge Test with 16QAM modulation Channel No./Frequencies	Edge Test with 64QAM modulation Channel No./Frequencies
Bottom 2110 MHz	Channel: 1537 Frequency: 2112.4 MHz	Channel: 1537 Frequency: 2112.4 MHz	Channel: 1537 Frequency: 2112.4 MHz
Top 2155 MHz	Channel: 1738 Frequency : 2152.6 MHz	Channel: 1738 Frequency : 2152.6 MHz	Channel: 1738 Frequency : 2152.6 MHz

Multi Carrier

Configuration 1 - Modes 4 and 6

TM1, TM5 and TM6

Band Edge Frequency	Edge Test with QPSK modulation Channel No./Frequencies	Edge Test with 16QAM modulation Channel No./Frequencies	Edge Test with 64QAM modulation Channel No./Frequencies
2110 MHz	Channel: 1537 & 1587 Frequency: 2112.4 & 2122.4 MHz	Channel: 1537 & 1587 Frequency: 2112.4 & 2122.4 MHz	Channel: 1537 & 1587 Frequency: 2112.4 & 2122.4 MHz
2155 MHz	Channel: 1688 & 1738 Frequency : 2142.6 & 2152.6 MHz	Channel: 1688 & 1738 Frequency : 2142.6 & 2152.6 MHz	Channel: 1688 & 1738 Frequency : 2142.6 & 2152.6 MHz

The channels shown in the table above are the minimum and maximum channels that can be used in the authorised frequency ranges to maintain compliance.



Product Service

Single Carrier

Configuration 1 - Mode 1

TM1

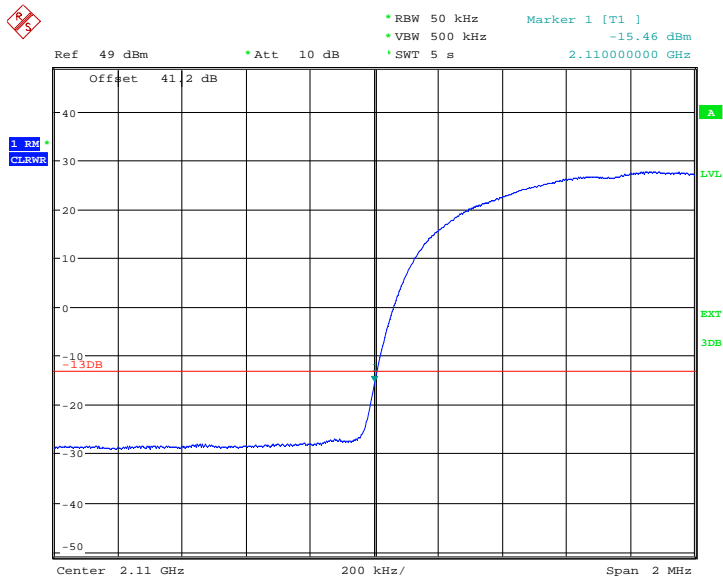

Date: 12.NOV.2010 03:40:58

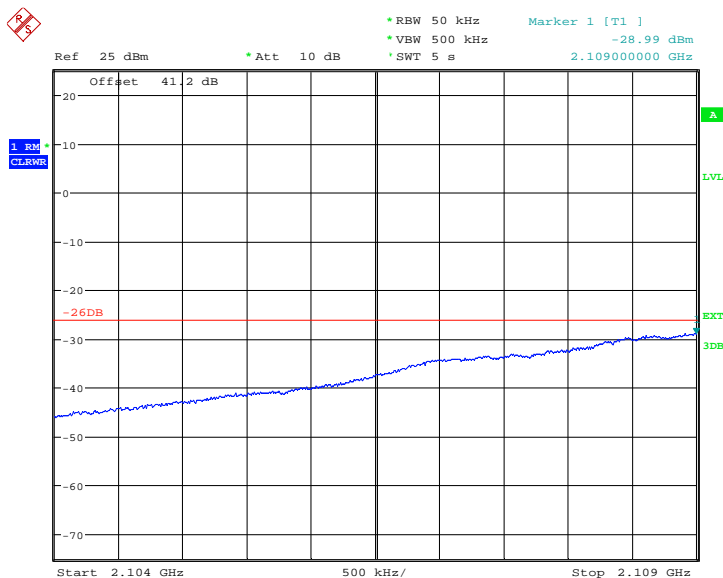

Date: 12.NOV.2010 03:46:47



Product Service

TM5

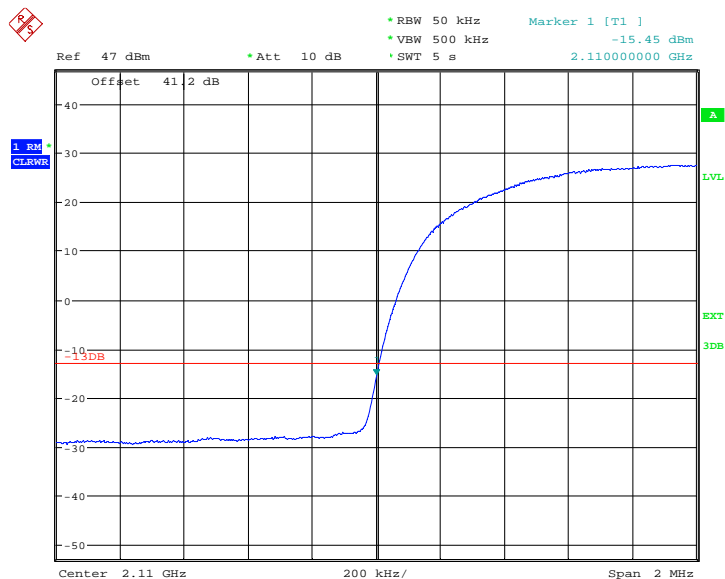

Date: 12.NOV.2010 06:50:16

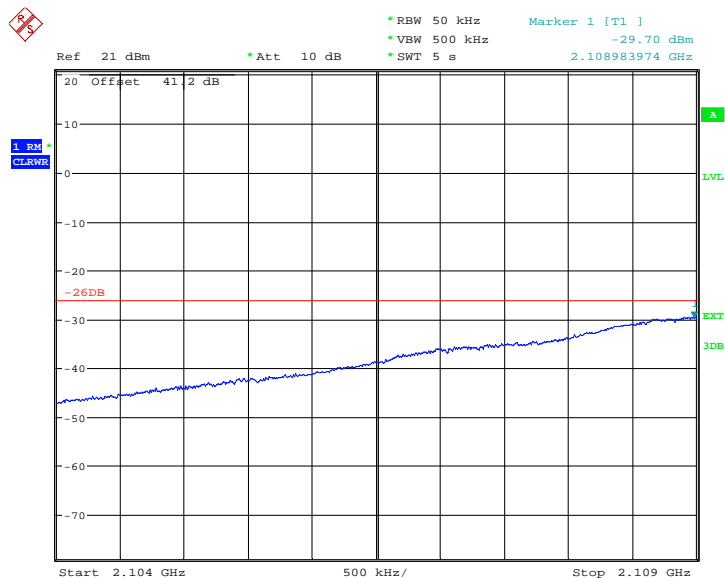

Date: 12.NOV.2010 06:59:39



TM6

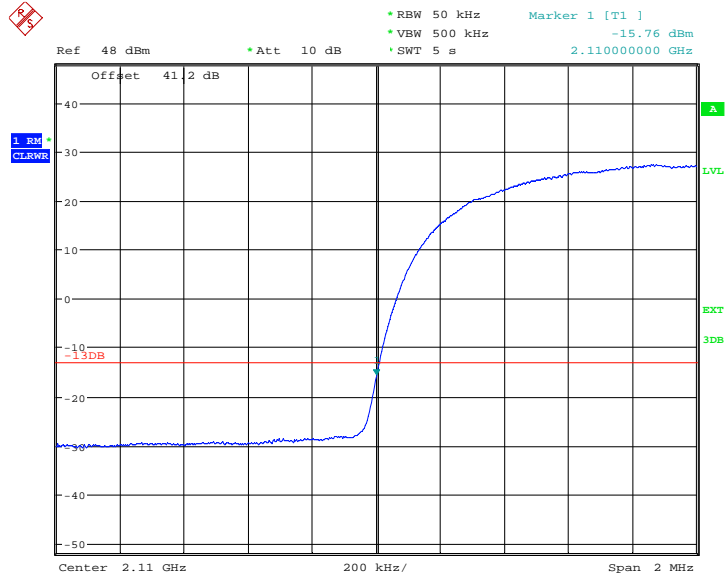

Date: 12.NOV.2010 07:22:30

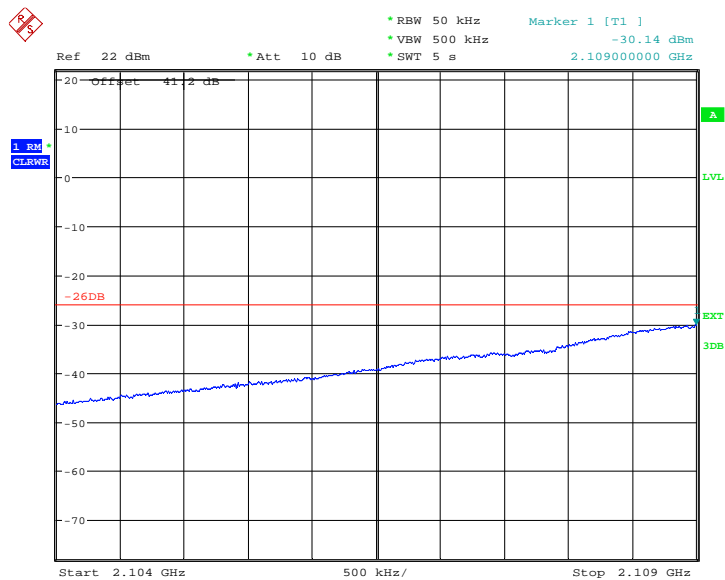

Date: 12.NOV.2010 07:25:07



Product Service

Configuration 1 - Mode 3

TM1

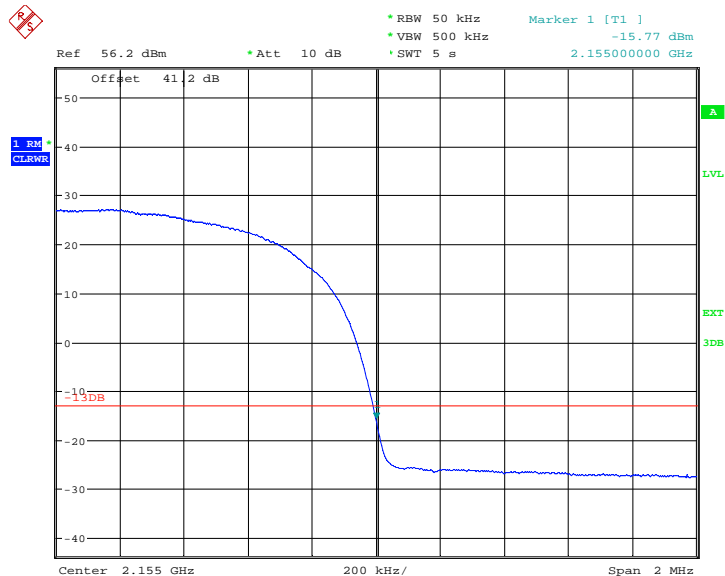

Date: 30.NOV.2010 03:35:21

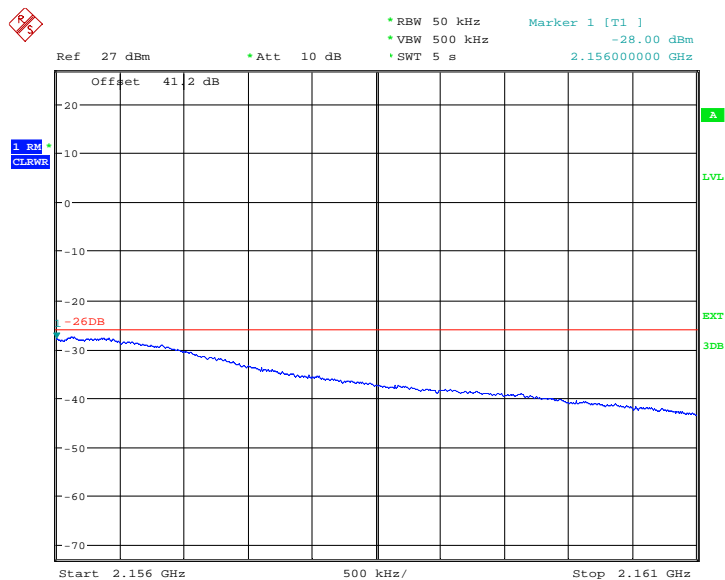

Date: 12.NOV.2010 08:36:08



Product Service

TM5

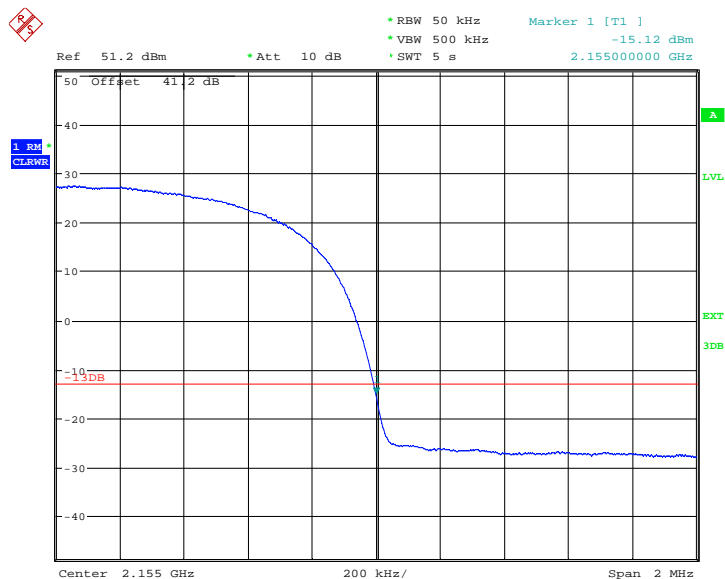

Date: 12.NOV.2010 08:51:42

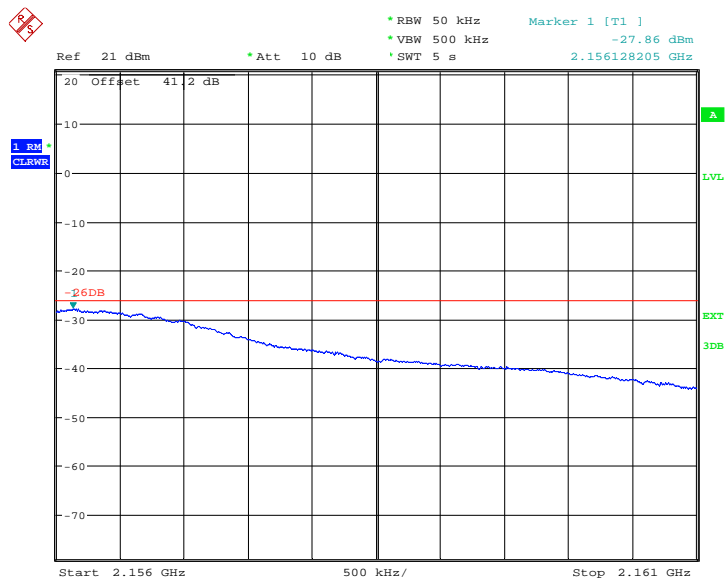

Date: 12.NOV.2010 08:56:01



Product Service

TM6

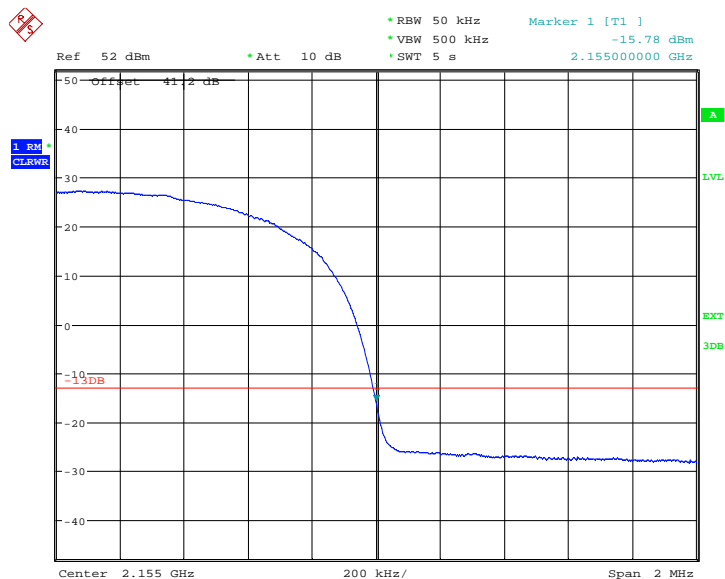

Date: 15.NOV.2010 03:19:43

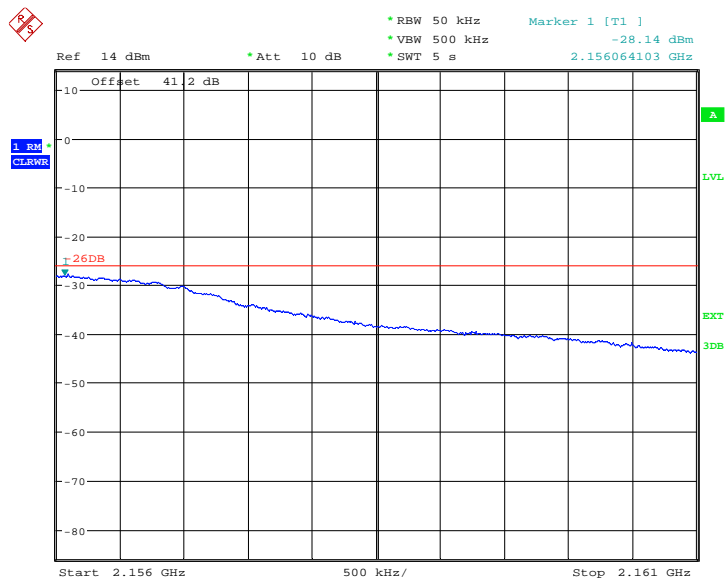

Date: 15.NOV.2010 03:22:47



Multi Carrier

Configuration 1 - Mode 4

TM1

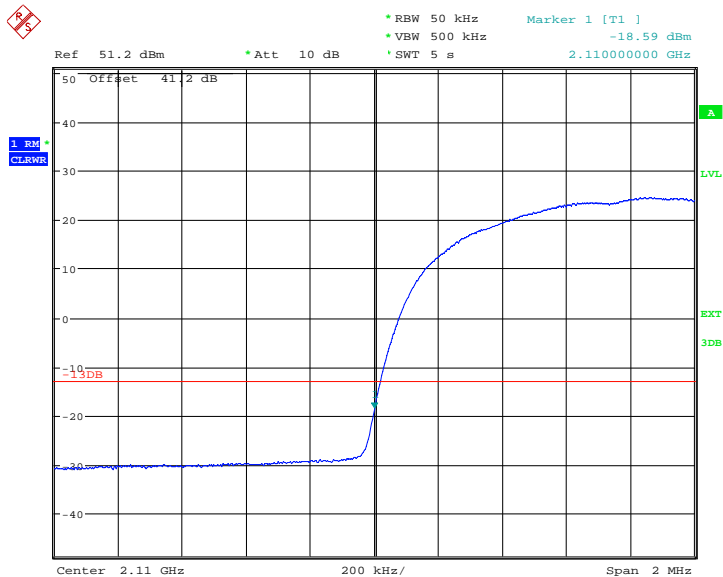

Date: 15.NOV.2010 07:21:58

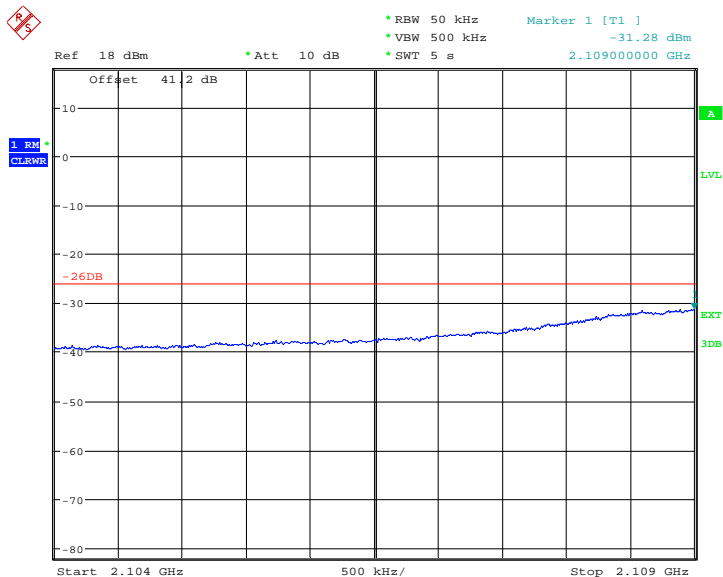

Date: 15.NOV.2010 07:23:39



TM5

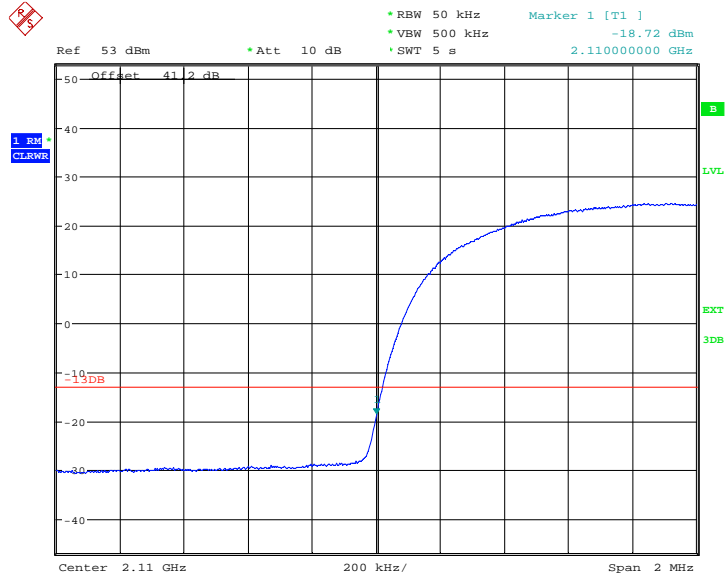

Date: 15.NOV.2010 09:10:57

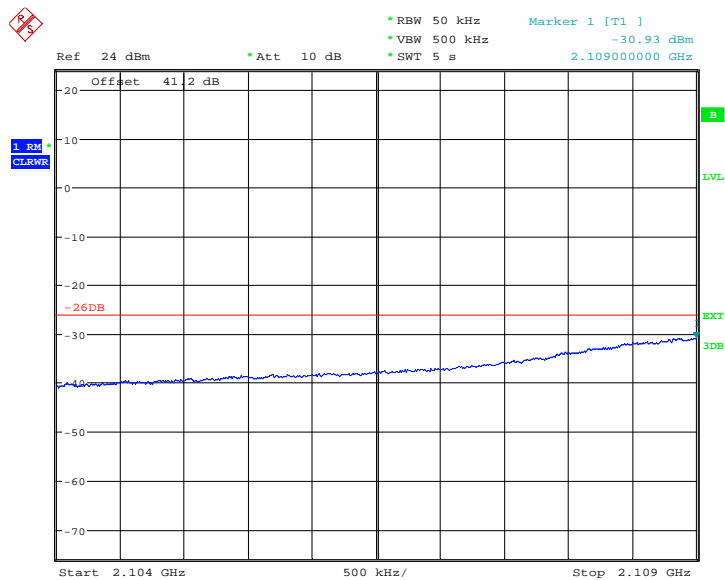

Date: 15.NOV.2010 09:13:50



TM6

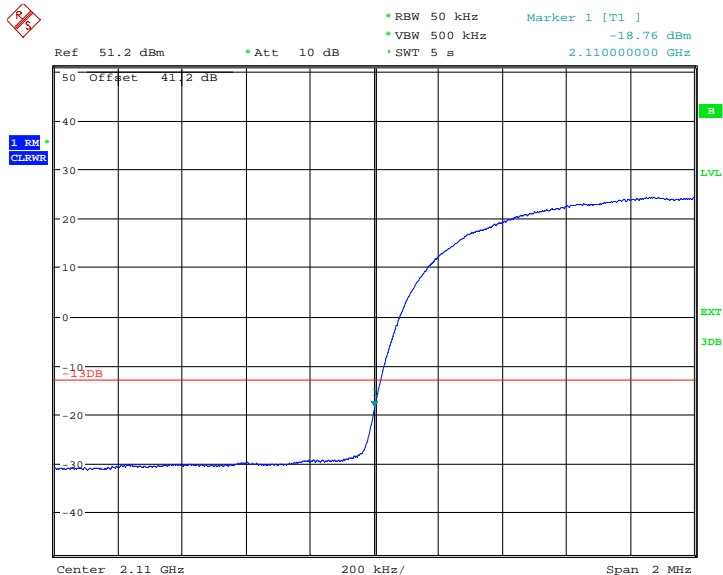

Date: 15.NOV.2010 09:31:51

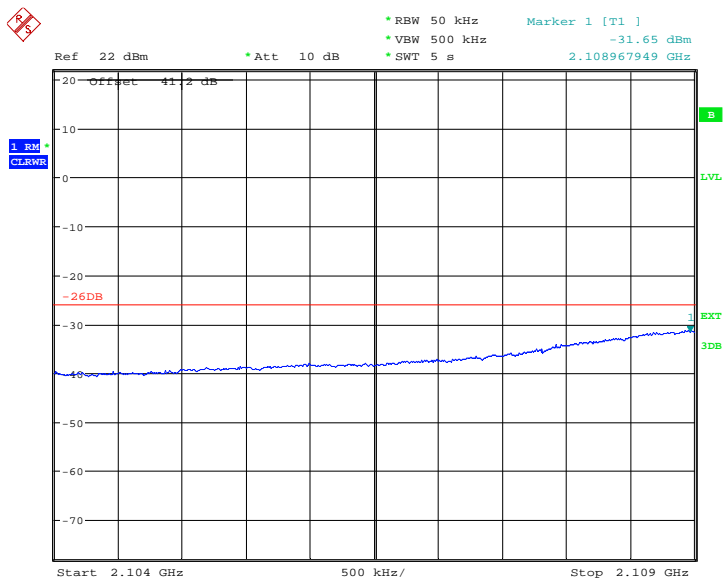

Date: 15.NOV.2010 09:33:07



Product Service

TM5

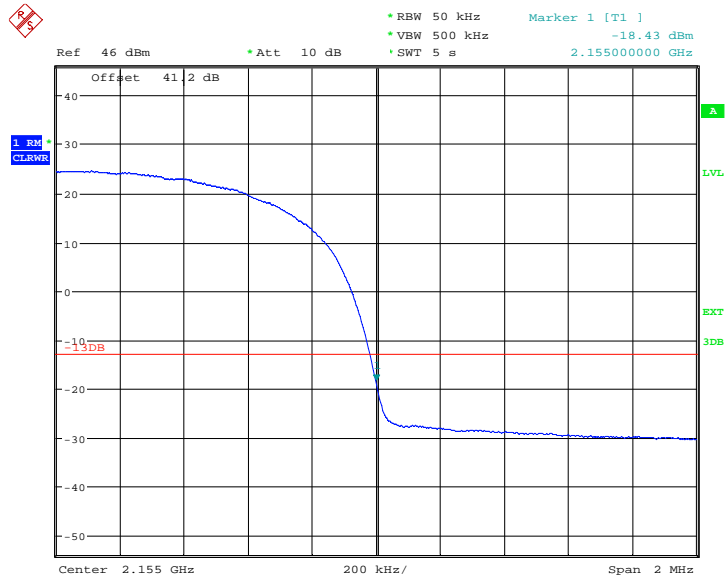

Date: 15.NOV.2010 10:06:32

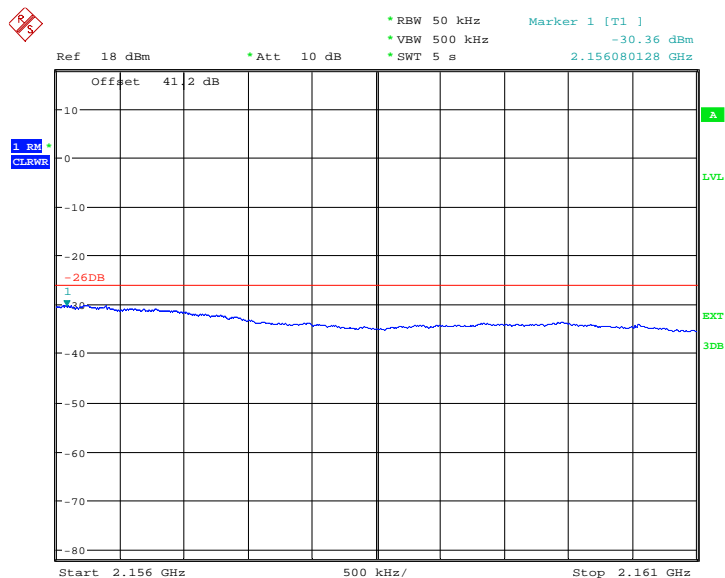

Date: 15.NOV.2010 10:08:00



Product Service

TM6

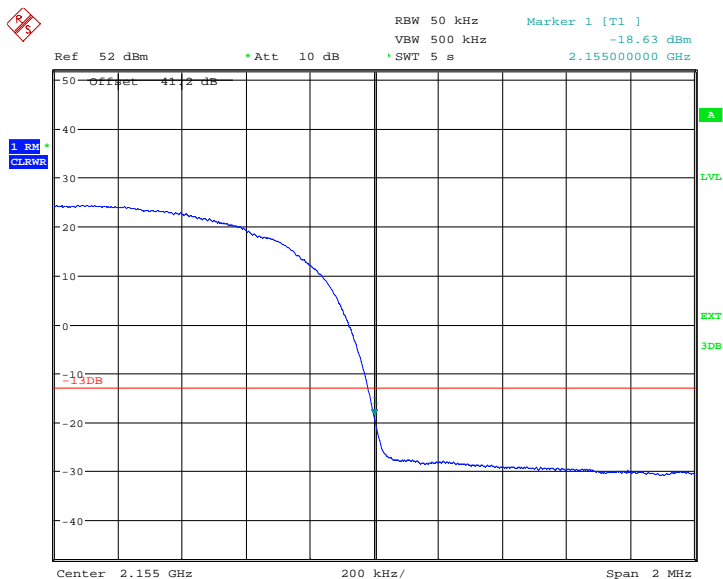

Date: 15.NOV.2010 09:50:34

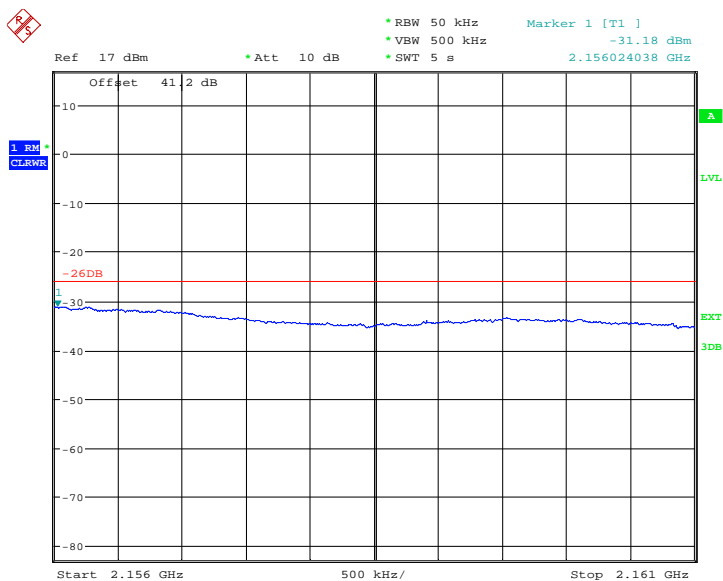

Date: 15.NOV.2010 09:52:39

Limit

The power of any emission outside the frequency band shall be attenuated below the transmitter power (P) by at least $43 + 10\log P$ dB.



Product Service

2.5 RADIATED SPURIOUS EMISSIONS

2.5.1 Specification Reference

FCC CFR 47 Part 2, Clause 2.1053
FCC CFR 47 Part 27, Clause 27.53 (h)
Industry Canada RSS-139, Clause 6.5

2.5.2 Equipment Under Test

RRU22 21IV40 / KRC 161 134/4, S/N: CB4E788284

2.5.3 Date of Test and Modification State

09 and 10 November 2010 – Modification State 0

2.5.4 Test Equipment Used

The major items of test equipment used for the above tests are identified in Section 3.1.

2.5.5 Test Method and Operating Modes

The test was applied in accordance with the test method requirements of FCC CFR 47 Part 2 and Part 27 and Industry Canada RSS-139.

A preliminary profile of the Spurious Radiated Emissions was obtained by operating the EUT on a remotely controlled turntable within the chamber. Measurements of emissions from the EUT were obtained with the Measurement Antenna in both Horizontal and Vertical Polarisations.

Emissions identified within the range 30MHz – 22GHz were then formally measured using a Peak detector as the worst case.

In the frequency Range 30MHz – 22GHz, the measurement was performed with a resolution bandwidth of 1MHz.

The measurements were performed at a 3m distance unless otherwise stated.

The limits was displayed, showing the -13dBm

The test was performed with the EUT operating on all modes in section 1.4.3 and record the result of the following configurations and modes of operation for worst case:

Configuration 1 - Mode 1
 - Mode 2
 - Mode 3
 - Mode 4
 - Mode 5
 - Mode 6



Product Service

2.5.6 Environmental Conditions

	09 November 2010	10 November 2010
Ambient Temperature	18.5°C	17.1°C
Relative Humidity	31.8%	31.8%

2.5.7 Test Results

For the period of test the EUT met the requirements of FCC CFR 47 Part 2 & Part 27 and Industry Canada RSS-139 for Radiated Spurious Emissions.

The test results are shown below

Note: Only the worst case results plots have been included as all of the emissions are greater than 20dB below the limit. A set of plots have been included to show the measurement system noise floor



Single Carrier

Configuration 1 - Mode 1

TM1

30MHz to 3GHz

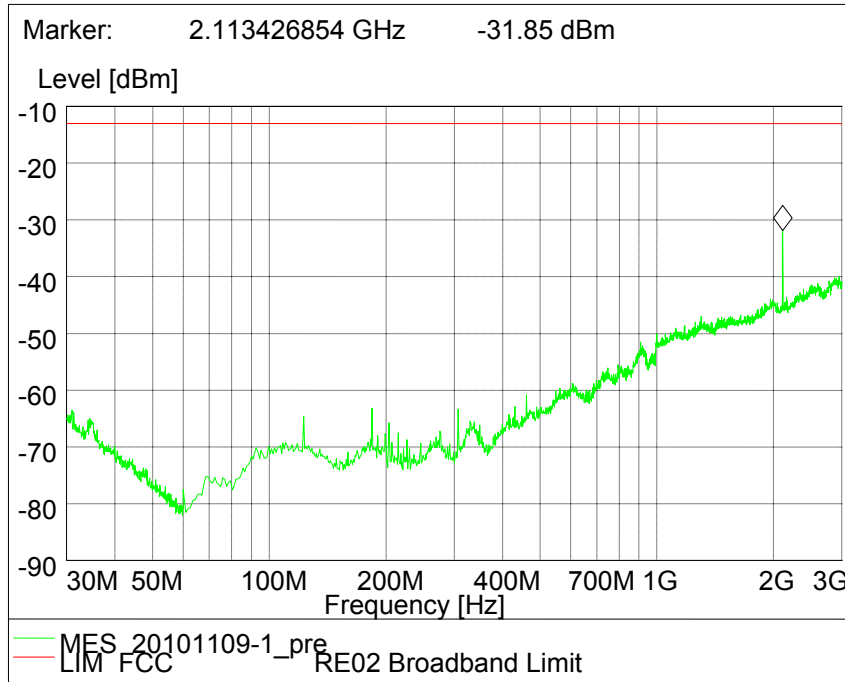

3GHz to 22GHz

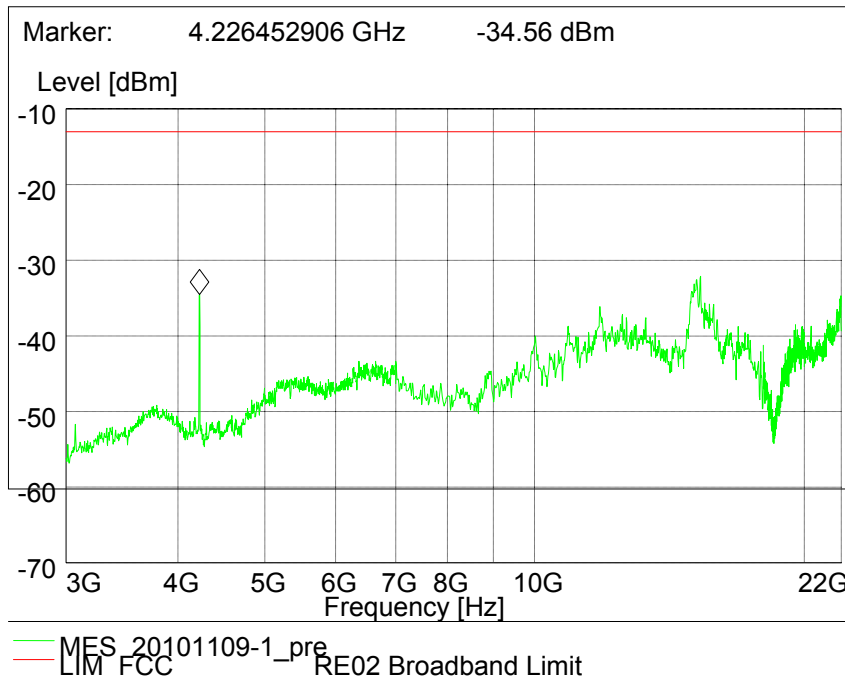



Product Service

Configuration 1 - Mode 2

TM1, TM5 and TM6

No emissions were detected within 20dB of the limit.

Configuration 1 – Mode 3

TM1, TM5 and TM6

No emissions were detected within 20dB of the limit.

Multi Carrier

Configuration 1 - Mode 4

TM1, TM5 and TM6

No emissions were detected within 20dB of the limit.

Configuration 1 - Mode 5

TM1, TM5 and TM6

No emissions were detected within 20dB of the limit.

Configuration 1 - Mode 6

TM1, TM5 and TM6

No emissions were detected within 20dB of the limit.

Limit	-13dBm
-------	--------

Remarks

The EUT does not exceed -13dBm at the measured frequencies.



Product Service

2.6 CONDUCTED SPURIOUS EMISSIONS

2.6.1 Specification Reference

FCC CFR 47 Part 2, Clause 2.1051
FCC CFR 47 Part 27, Clause 27.53 (h)
Industry Canada RSS-139, Clause 6.5

2.6.2 Equipment Under Test

RRU22 21V40 / KRC 161 134/4, S/N: CB4E788284

2.6.3 Date of Test and Modification State

12, 15, 30 November and 02 December 2010 – Modification State 0

2.6.4 Test Equipment Used

The major items of test equipment used for the above tests are identified in Section 3.1.

2.6.5 Test Method and Operating Modes

The test was applied in accordance with the test method requirements of FCC CFR 47 Part 2 and Part 27 and Industry Canada RSS-139.

In accordance with Part 2.1051, the spurious emissions from the antenna terminal were measured. The transmitter output power was attenuated using an attenuator and the frequency spectrum investigated from 9kHz to 22GHz. The EUT was set to transmit on maximum power. The EUT was tested on Bottom, Middle and Top channels for QPSK, 16QAM and 64QAM modulation types. The resolution was set to 1MHz for 9kHz to 22GHz thus meeting the requirements of Part 27.53(h). The spectrum analyser detector was set to peak and trace was kept on Max Hold.

The maximum path loss across the measurement band was used as the reference level offset to ensure worst case.

In addition, measurements were made up to the 10th harmonic of the fundamental.

The test was performed with the EUT in the following configurations and modes of operation:

Configuration 1 - Mode 1
 - Mode 2
 - Mode 3
 - Mode 4
 - Mode 5
 - Mode 6



Product Service

2.6.6 Environmental Conditions

	12 Nov. 2010	15 Nov. 2010	30 Nov. 2010	02 Dec. 2010
Ambient Temperature	19.8°C	21.1°C	22.0°C	22.2°C
Relative Humidity	26.4%	22.0%	24.7%	22.1%

2.6.7 Test Results

For the period of test the EUT met the requirements of FCC CFR 47 Part 2 and Part 27 and Industry Canada RSS-139 for Radiated Spurious Emissions.

The test results are shown below

The emissions at 9kHz on the plots was not generated by the test object. A complementary measruement with a smaller Span showed that it was related to the LO feedthrough.

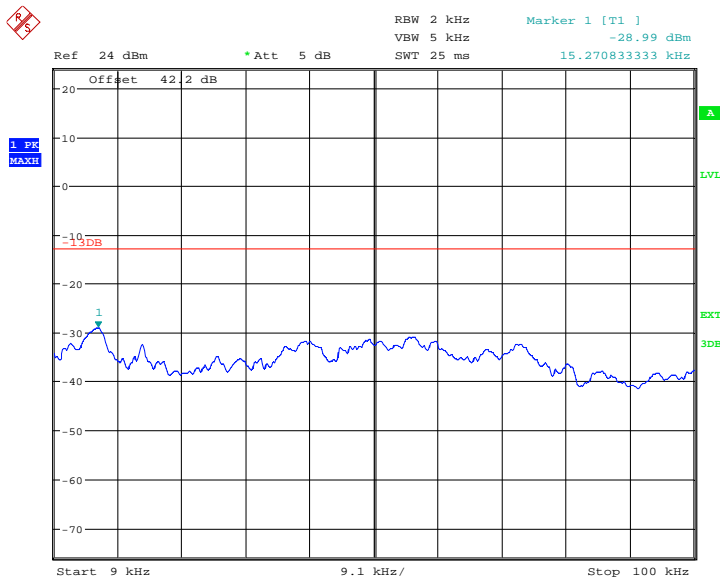

Date: 12.NOV.2010 03:52:49



Single Carrier

Configuration 1 - Mode 1

TM1

9kHz to 3GHz

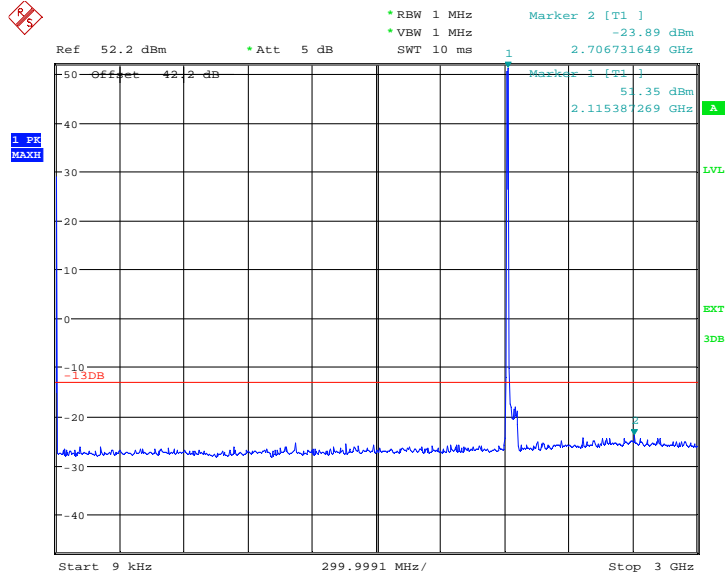

Date: 12.NOV.2010 03:51:37

Note: The emission beyond the limit is the operating frequency.

3GHz to 22GHz

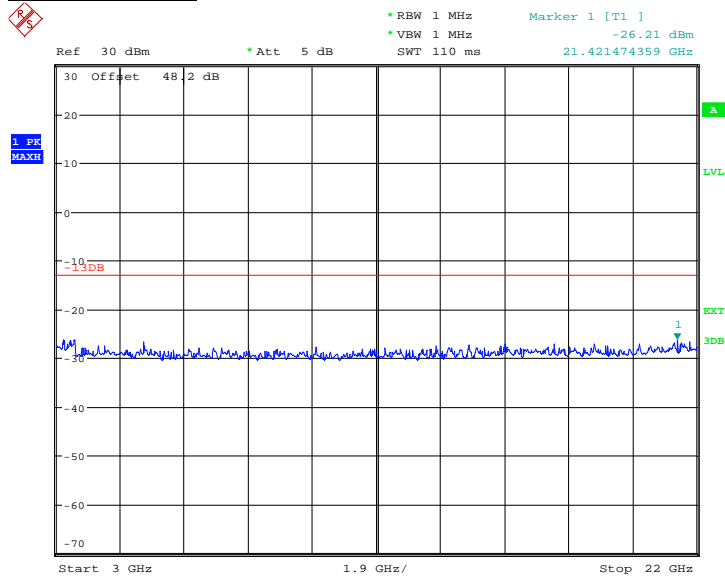

Date: 12.NOV.2010 03:53:50



TM5

9kHz to 3GHz

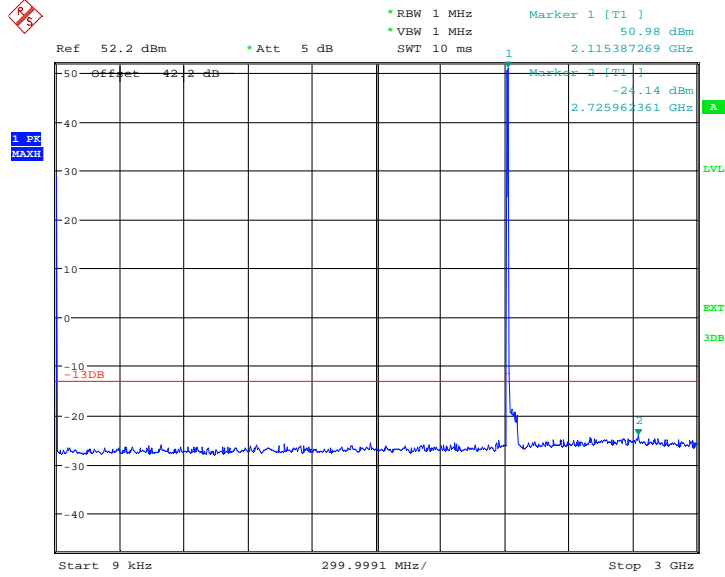

Date: 30.NOV.2010 03:27:35

Note: The emission beyond the limit is the operating frequency.

3GHz to 22GHz

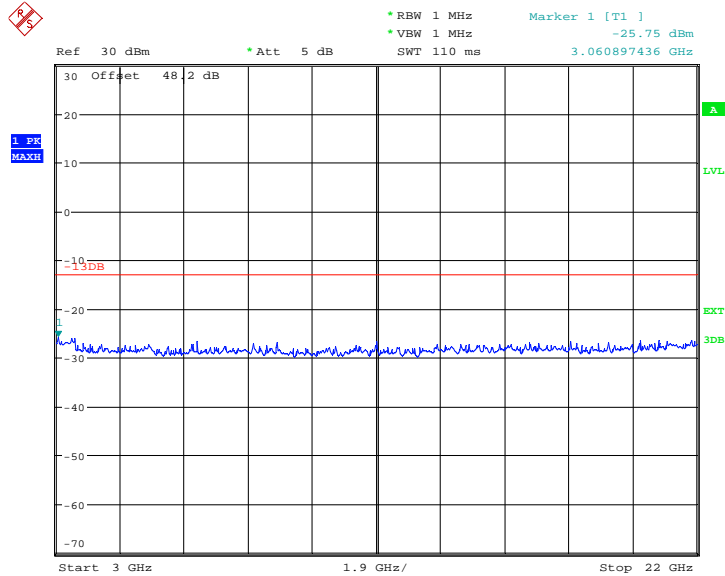

Date: 12.NOV.2010 06:32:12



Product Service

TM6

9kHz to 3GHz

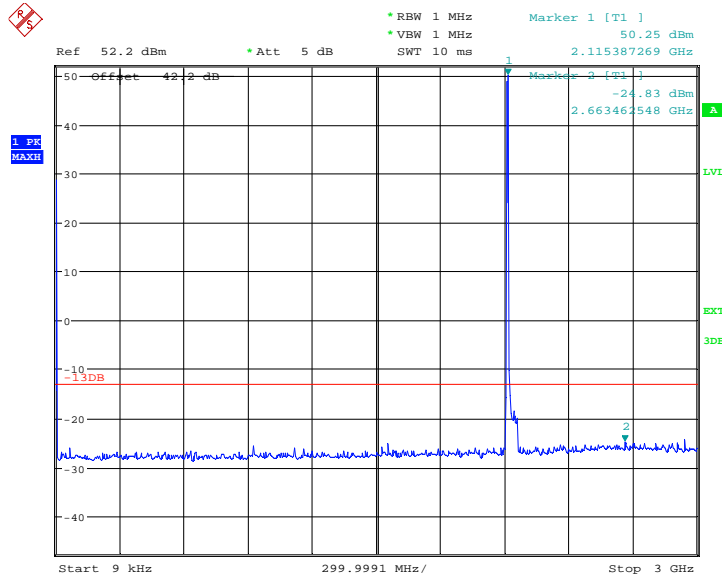

Date: 2.DEC.2010 06:13:31

Note: The emission beyond the limit is the operating frequency.

3GHz to 22GHz

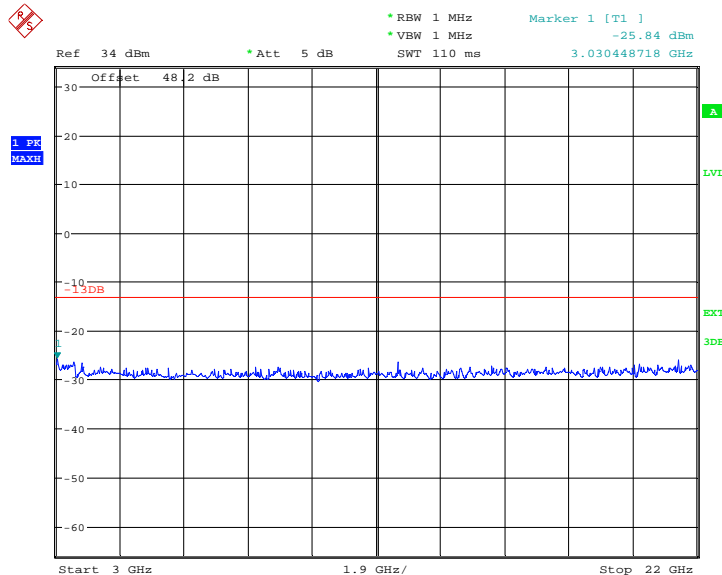

Date: 2.DEC.2010 06:38:45



Configuration 1 - Mode 2

TM1

9kHz to 3GHz

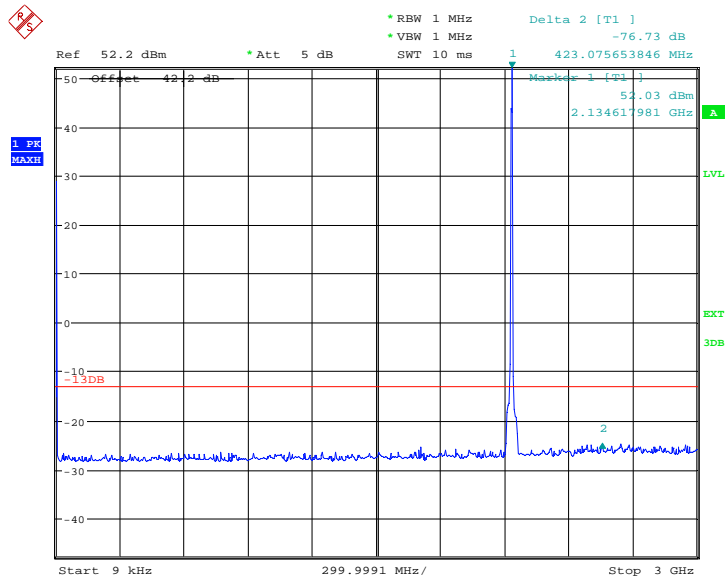

Date: 15.NOV.2010 04:20:48

Note: The emission beyond the limit is the operating frequency.

3GHz to 22GHz

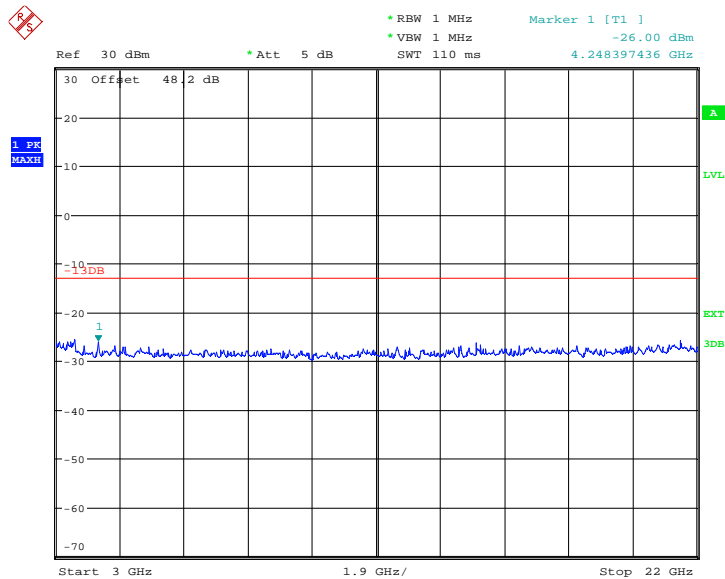

Date: 15.NOV.2010 04:23:13



TM5

9kHz to 3GHz

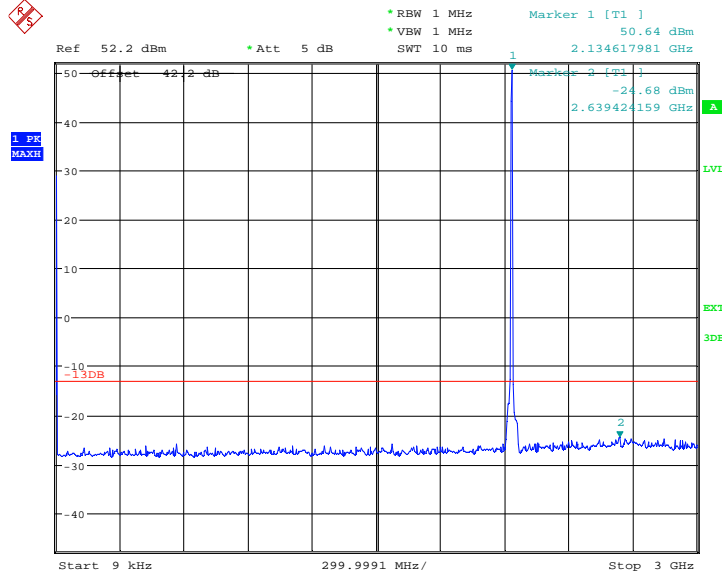

Date: 15.NOV.2010 03:57:27

Note: The emission beyond the limit is the operating frequency.

3GHz to 22GHz

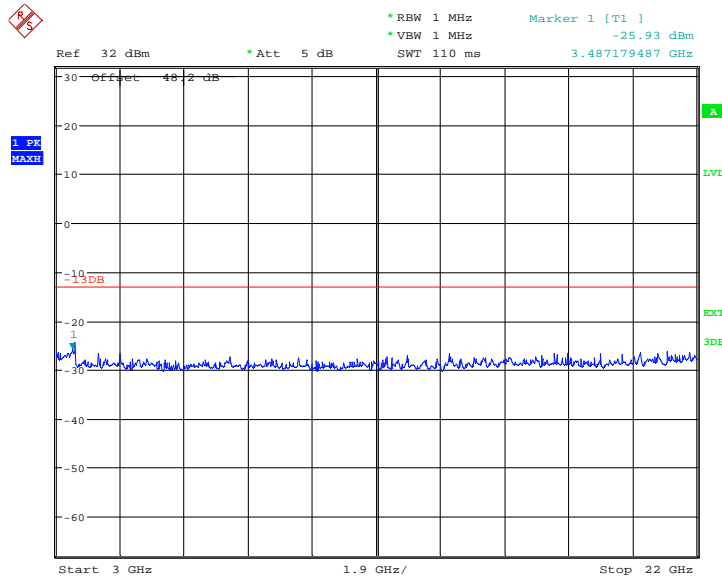

Date: 15.NOV.2010 03:59:00



Product Service

TM6

9kHz to 3GHz

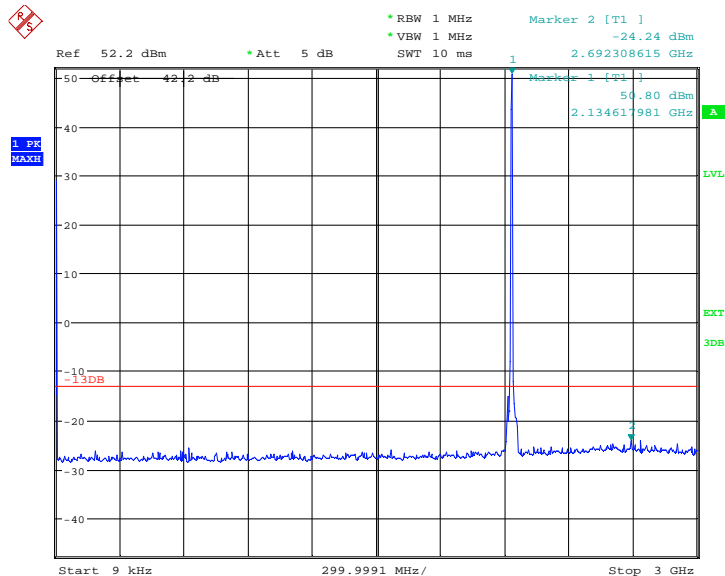

Date: 15.NOV.2010 03:35:35

Note: The emission beyond the limit is the operating frequency.

3GHz to 22GHz

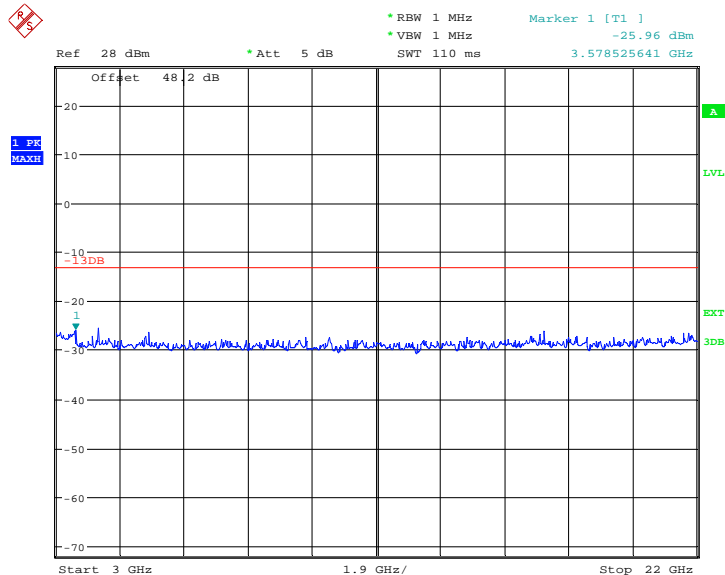

Date: 15.NOV.2010 03:34:22



Product Service

Configuration 1 - Mode 3

TM1

9kHz to 3GHz

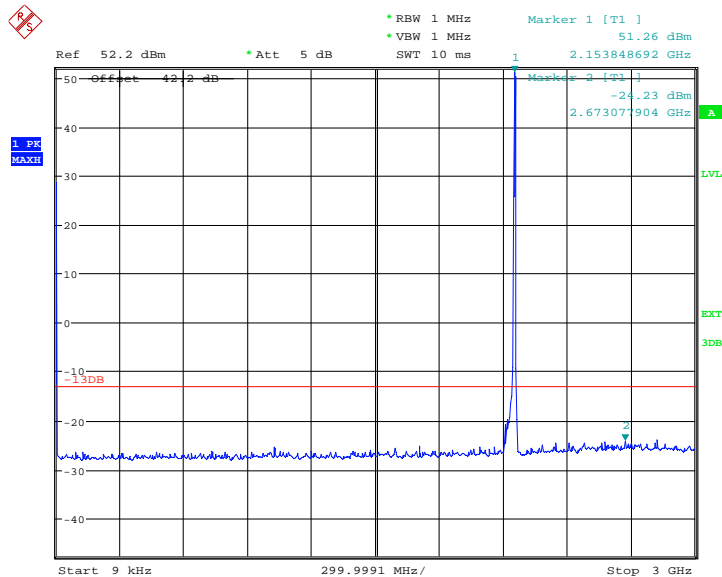

Date: 2.DEC.2010 06:03:16

Note: The emission beyond the limit is the operating frequency.

3GHz to 22GHz

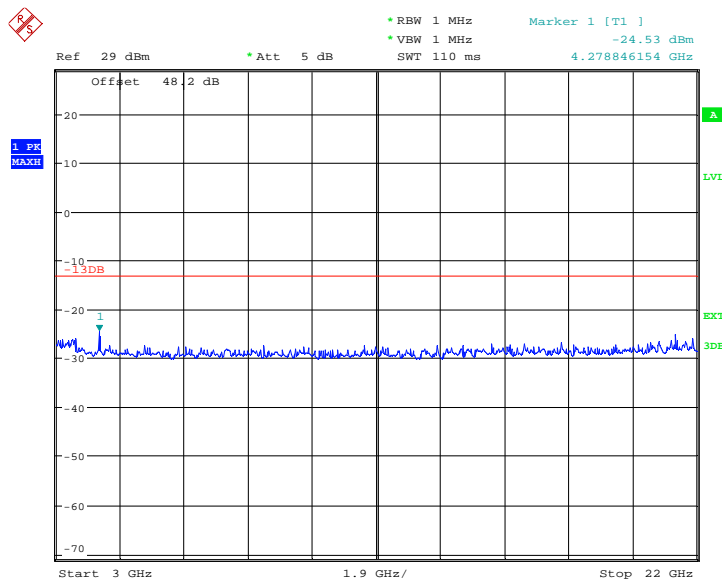

Date: 12.NOV.2010 08:40:33



TM5

9kHz to 3GHz

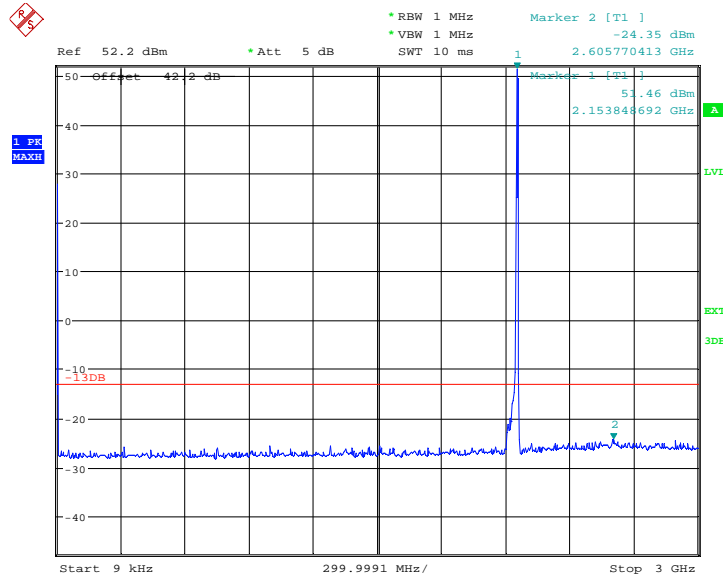

Date: 12.NOV.2010 08:48:17

Note: The emission beyond the limit is the operating frequency.

3GHz to 22GHz

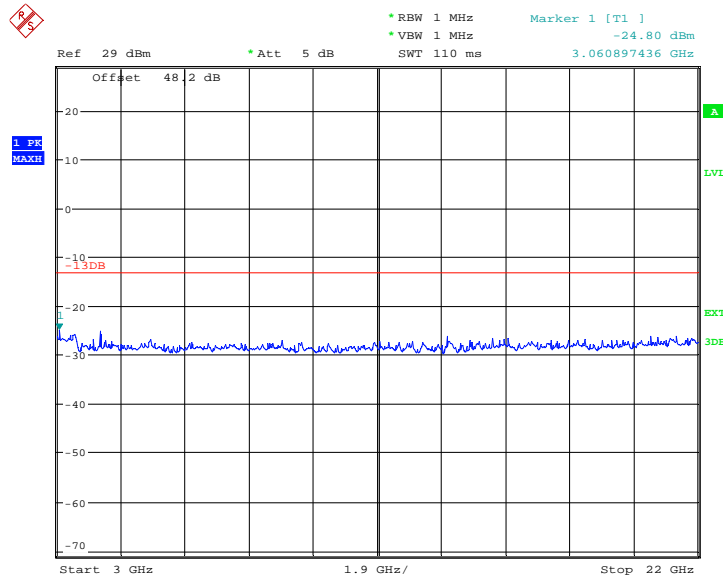

Date: 12.NOV.2010 08:45:54



Product Service

TM6

9kHz to 3GHz

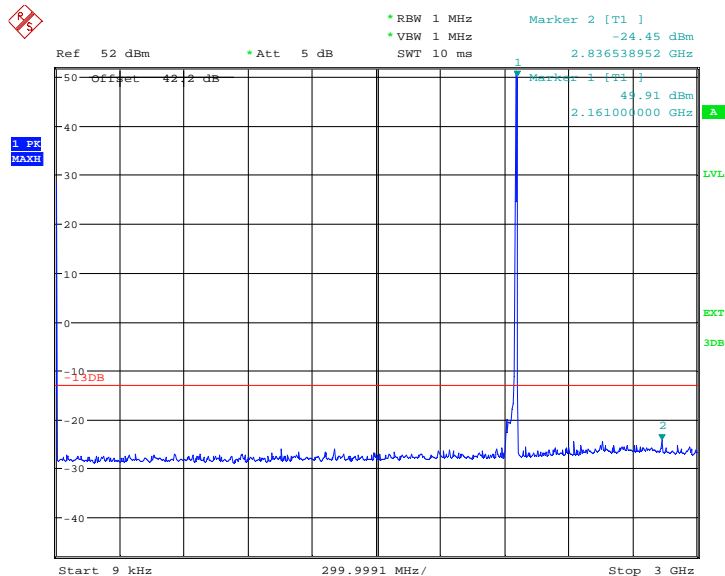

Date: 15.NOV.2010 03:26:01

Note: The emission beyond the limit is the operating frequency.

3GHz to 22GHz

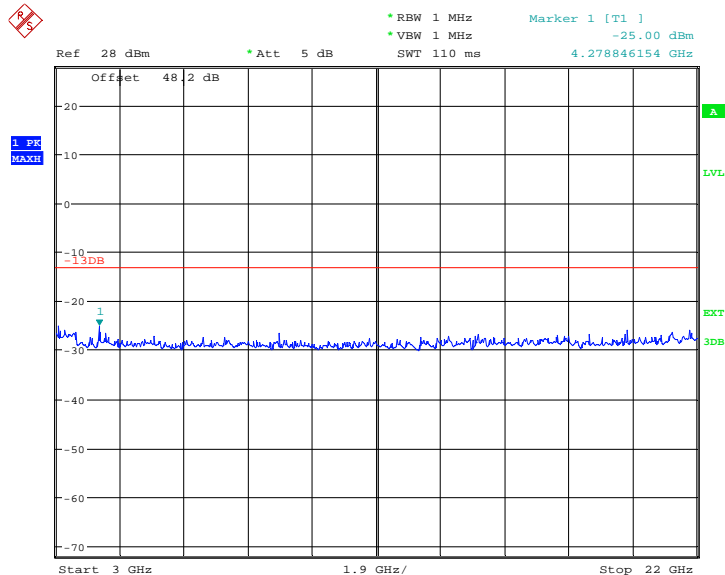

Date: 15.NOV.2010 03:28:17



Product Service

Multi Carrier

Configuration 1 - Mode 4

TM1

9kHz to 3GHz

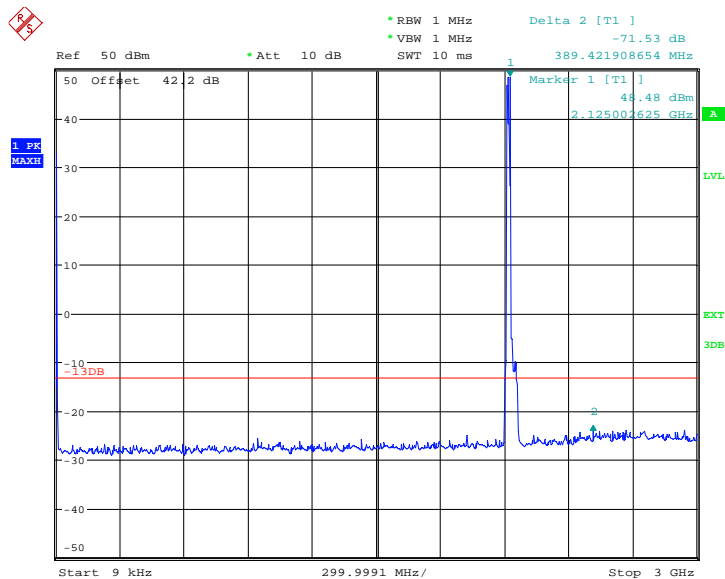

Date: 15.NOV.2010 07:18:11

Note: The emissions beyond the limit are the operating frequencies.

3GHz to 22GHz

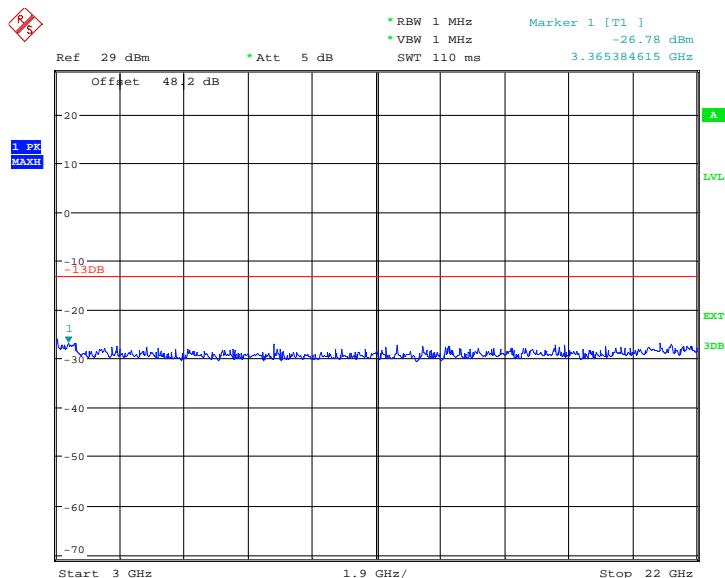

Date: 15.NOV.2010 07:16:11



TM5

9kHz to 3GHz

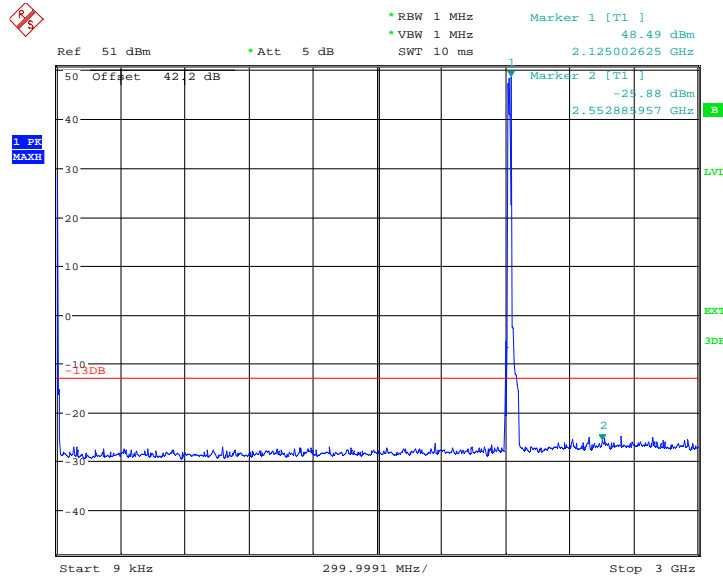

Date: 15.NOV.2010 09:17:32

Note: The emissions beyond the limit are the operating frequencies.

3GHz to 22GHz

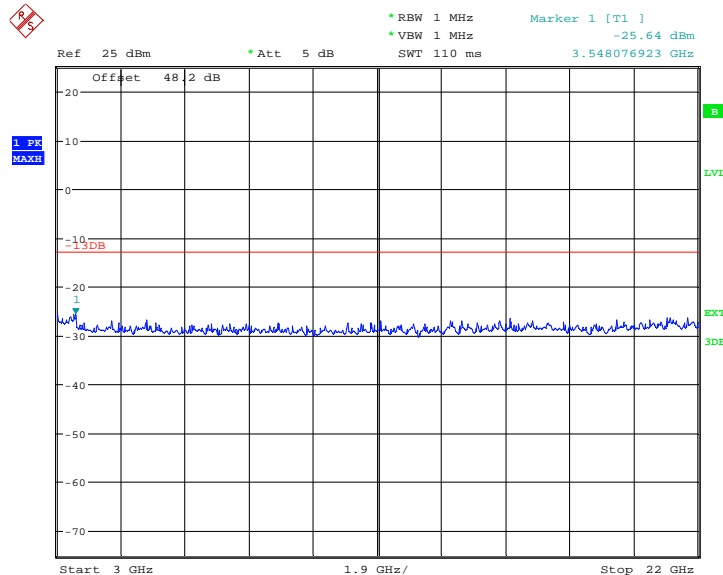

Date: 15.NOV.2010 09:20:03



Product Service

TM6

9kHz to 3GHz

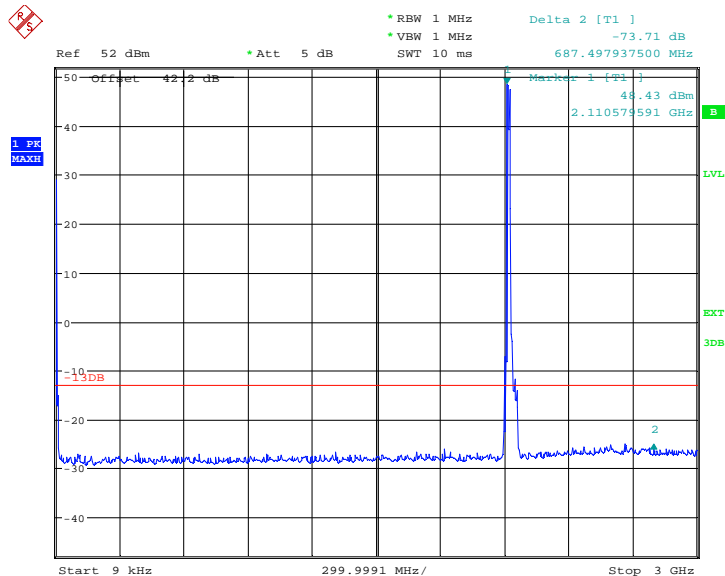

Date: 15.NOV.2010 09:28:28

Note: The emissions beyond the limit are the operating frequencies.

3GHz to 22GHz

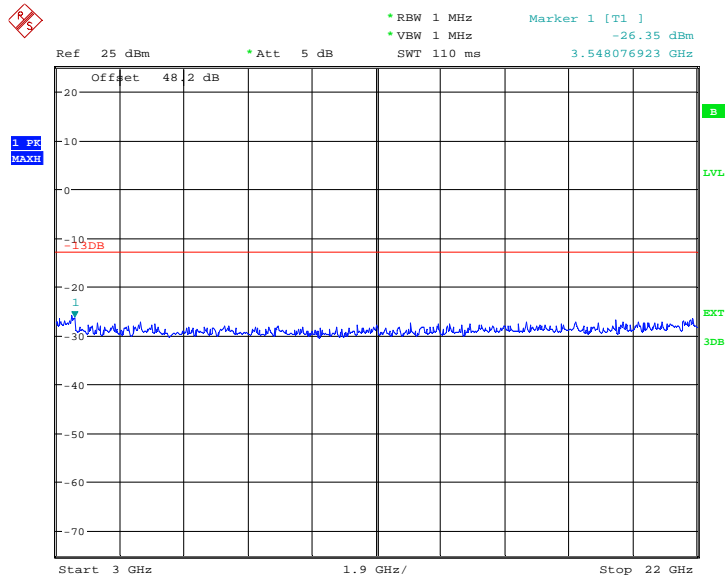

Date: 15.NOV.2010 09:27:29



Product Service

Configuration 1 - Mode 5

TM1

9kHz to 3GHz

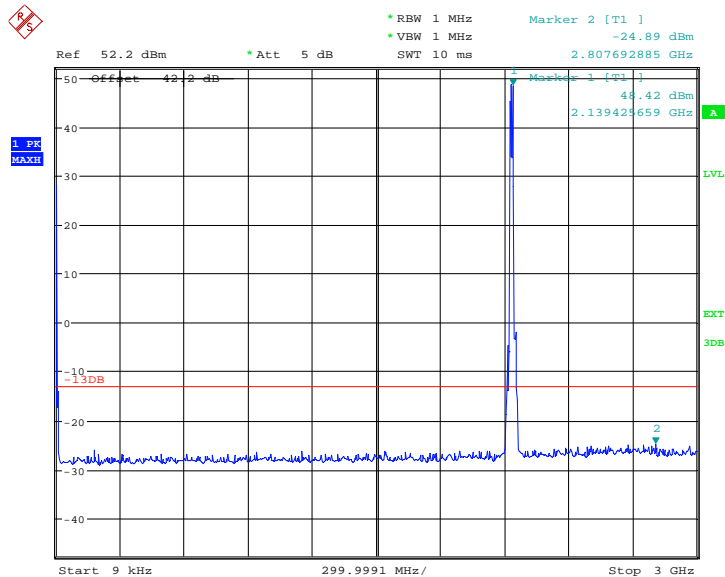

Date: 15.NOV.2010 07:09:12

Note: The emissions beyond the limit are the operating frequencies.

3GHz to 22GHz

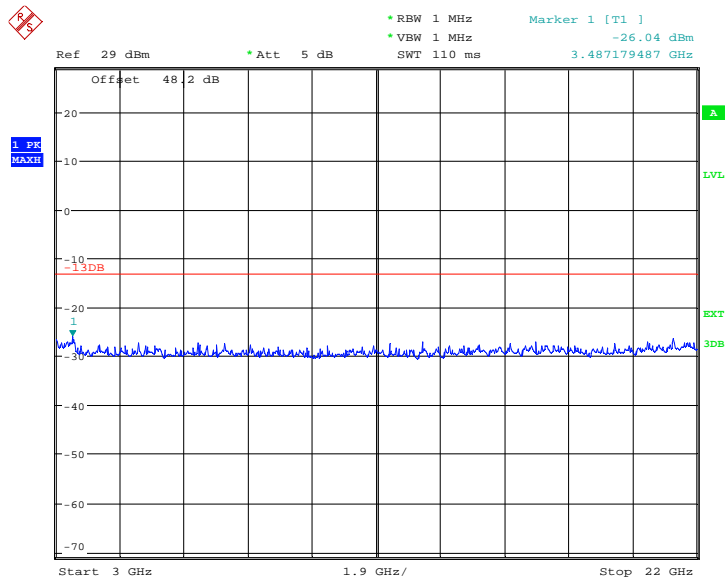

Date: 15.NOV.2010 07:10:40



Product Service

TM5

9kHz to 3GHz

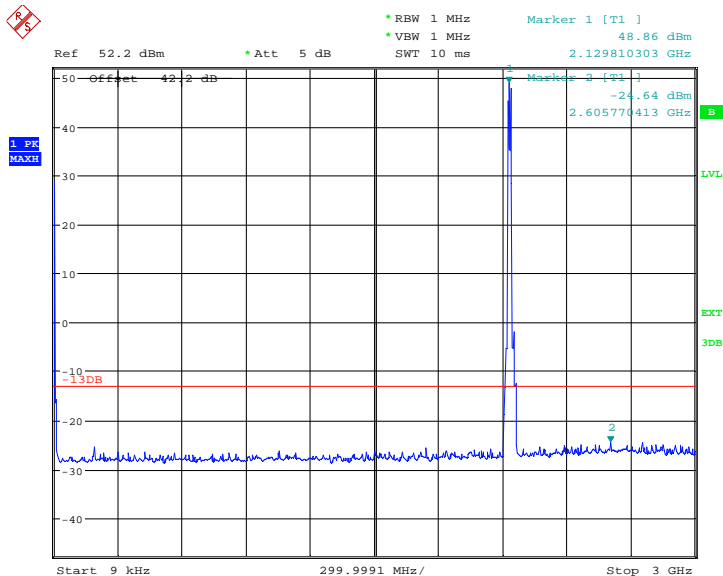

Date: 15.NOV.2010 06:55:42

Note: The emissions beyond the limit are the operating frequencies.

3GHz to 22GHz

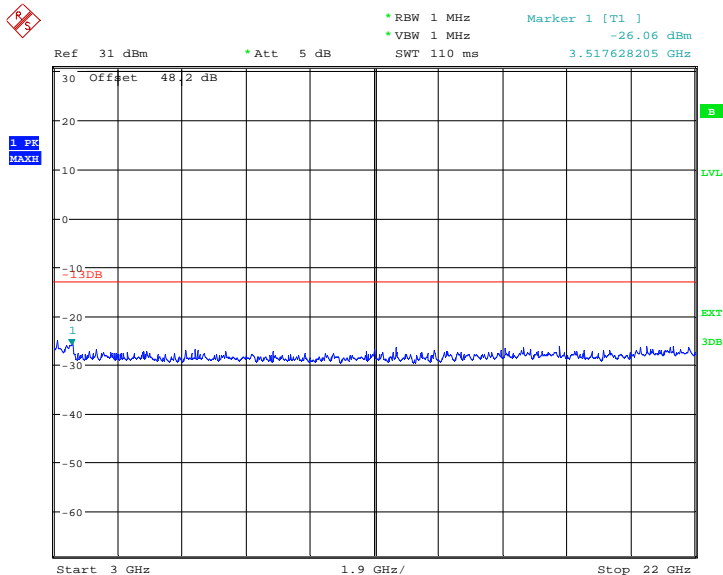

Date: 15.NOV.2010 06:54:14



Product Service

TM6

9kHz to 3GHz

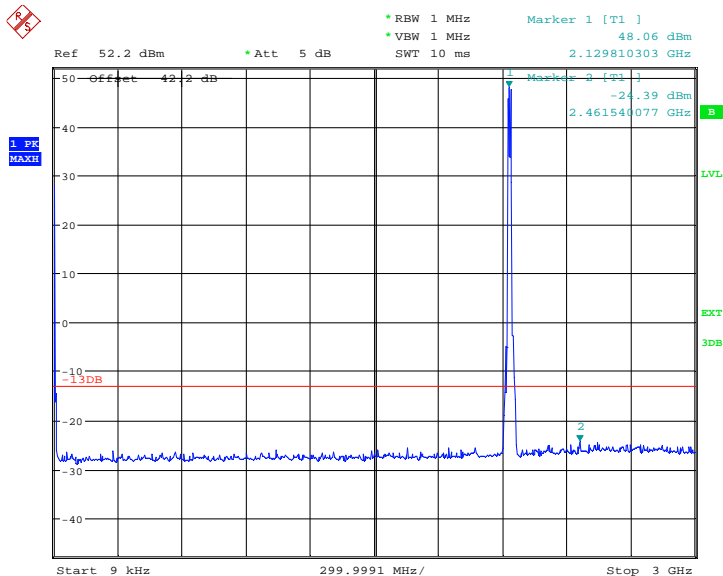

Date: 15.NOV.2010 06:45:05

Note: The emissions beyond the limit are the operating frequencies.

3GHz to 22GHz

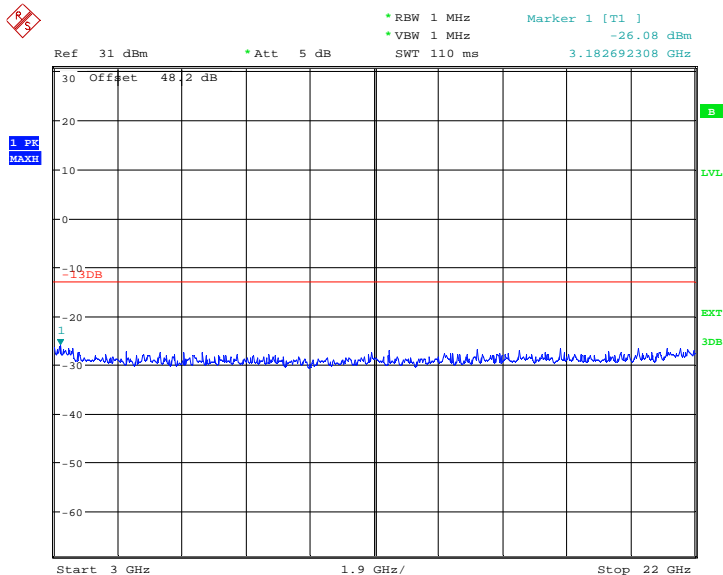

Date: 15.NOV.2010 06:46:01



Configuration 1 - Mode 6

TM1

9kHz to 3GHz

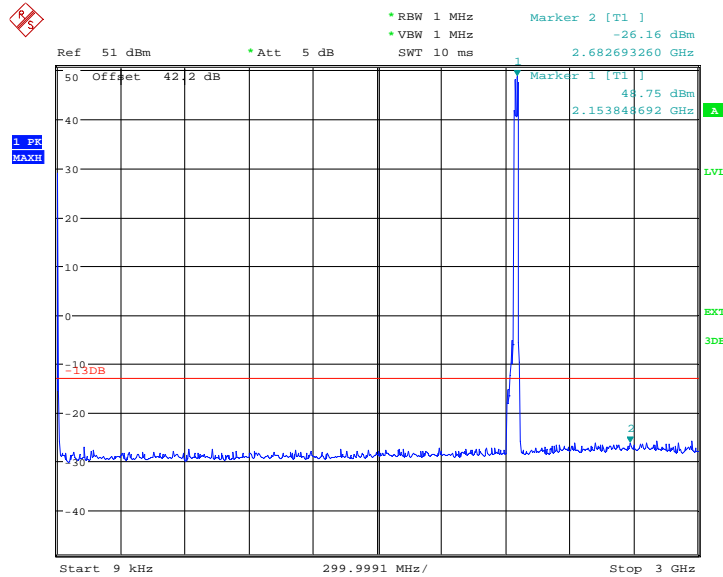

Date: 15.NOV.2010 10:27:58

Note: The emissions beyond the limit are the operating frequencies.

3GHz to 22GHz

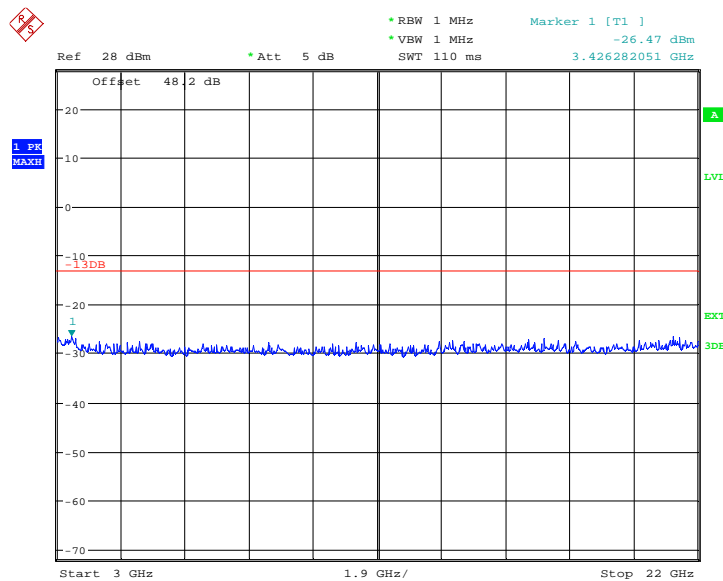

Date: 15.NOV.2010 10:29:17



TM5

9kHz to 3GHz

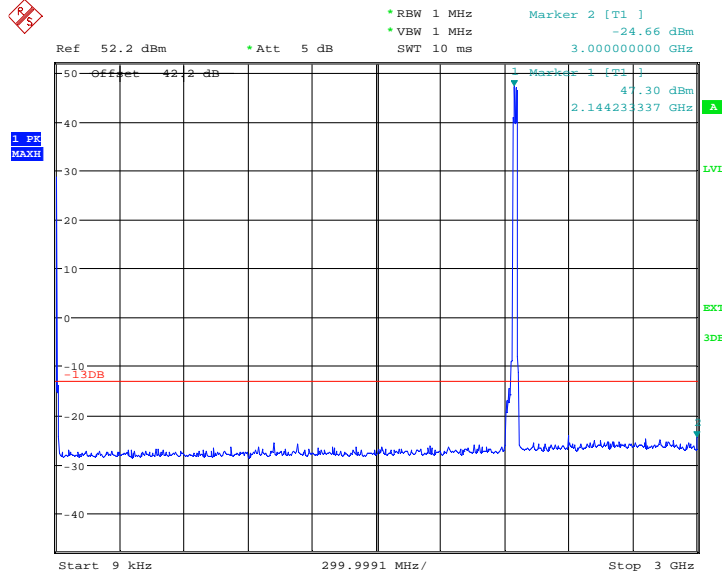

Date: 2.DEC.2010 06:55:22

Note: The emissions beyond the limit are the operating frequencies.

3GHz to 22GHz

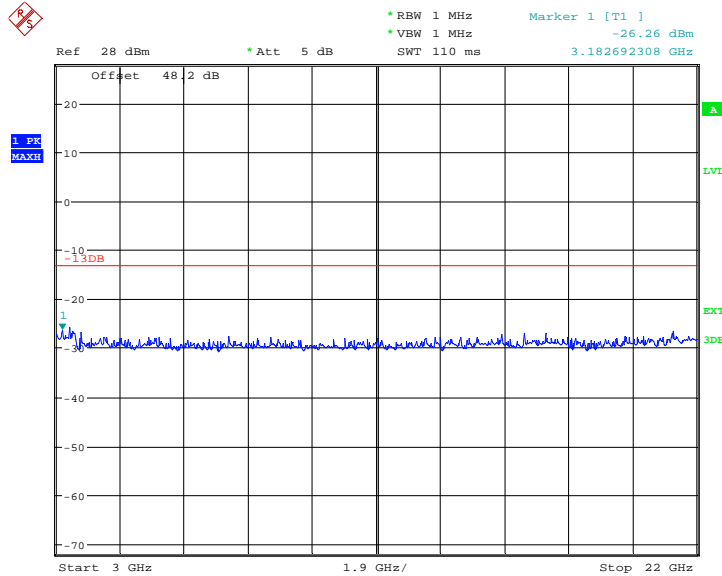

Date: 15.NOV.2010 10:03:29



Product Service

TM6

9kHz to 3GHz

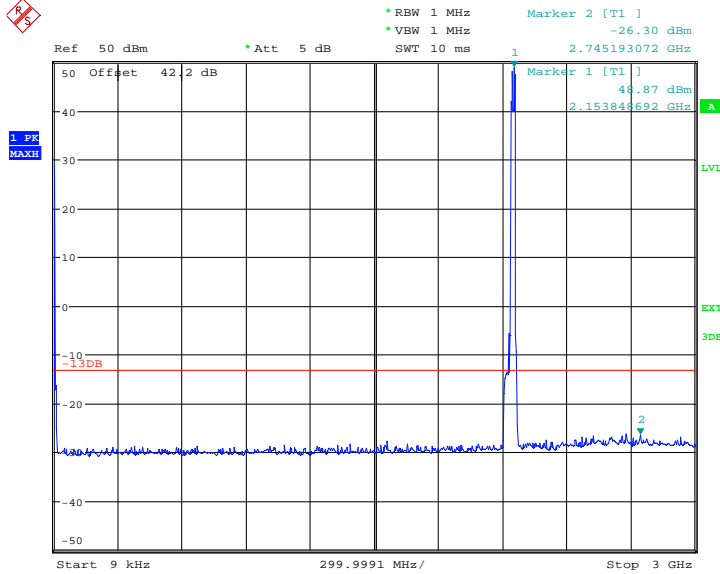

Date: 15.NOV.2010 09:55:15

Note: The emissions beyond the limit are the operating frequencies.

3GHz to 22GHz

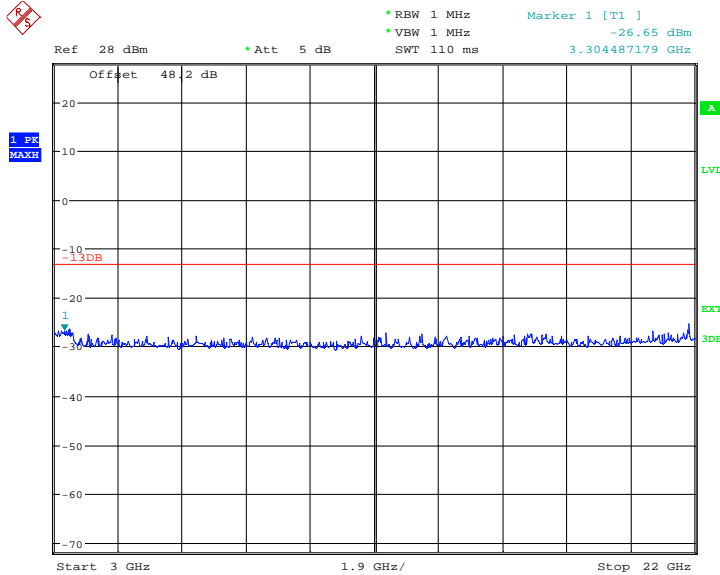

Date: 15.NOV.2010 09:56:40

Limit	-13dBm
-------	--------

Remarks

The EUT does not exceed -13dBm at the frequency range of 9kHz to 22GHz.



Product Service

2.7 RECEIVER SPURIOUS EMISSIONS

2.7.1 Specification Reference

Industry Canada RSS 139, Clause 6.6

2.7.2 Equipment Under Test

RRU22 21V40 / KRC 161 134/4, S/N: CB4E788284

2.7.3 Date of Test and Modification State

16 November 2010 – Modification State 0

2.7.4 Test Equipment Used

The major items of test equipment used for the above tests are identified in Section 3.1.

2.7.5 Test Method and Operating Modes

The test was applied in accordance with the test method requirements of Industry Canada RSS 139.

In accordance with RSS-Gen Clause 6(b), the receiver spurious emissions from the antenna terminal were measured. Measurements were performed on the receiver antenna connector Ant B. The EUT was set to transmitter mode on the TX connector Ant A and during the measurement the Ant A was terminated with match load, (50 Ohm).

The resolution was set to 1MHz in the frequency range 9kHz to 11GHz thus meeting the requirements of RSS-Gen Clause 6(b), the spectrum analyser detector was set to peak and trace was kept on Max Hold to give the worst case. The limit line was displayed, showing the -57dBm, 2 nanowatts in band 9kHz to 1GHz and above 1GHz, -53dBm, 5 nanowatts.

The maximum path loss across the measurement band was used as the reference level offset to ensure worst case.

In addition, measurements were made from 9kHz up to the 5th harmonic of the fundamental.

The test was performed with the EUT in the following configurations and modes of operation as the worst cases:

Configuration 1 - Mode 2
- Mode 5

2.7.6 Environmental Conditions

	16 November 2010
Ambient Temperature	21.8°C
Relative Humidity	27.9%



2.7.7 Test Results

For the period of test the EUT met the requirements of Industry Canada RSS 139 for Receiver Spurious Emissions.

The test results are shown below

The emissions at 9kHz on the plots was not generated by the test object. A complementary measurement with a smaller Span showed that it was related to the LO feedthrough.

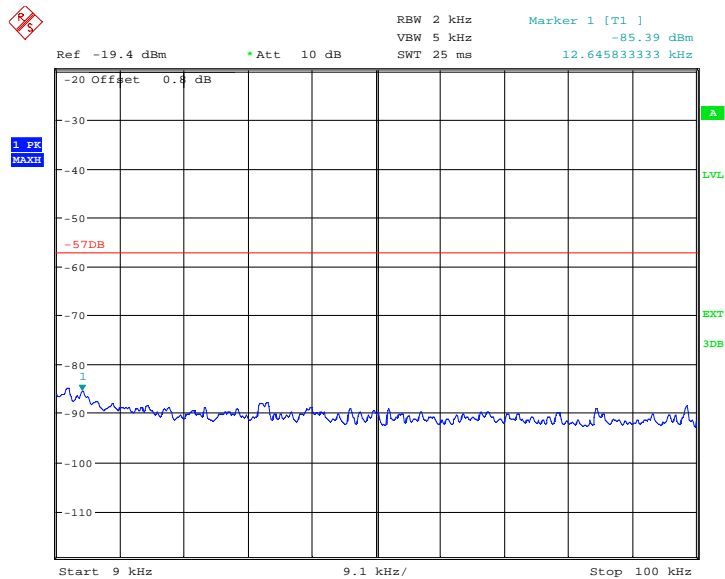

Date: 16.NOV.2010 02:44:05



Product Service

Single Carrier

Configuration 1 - Mode 2

TM1

9kHz to 1GHz

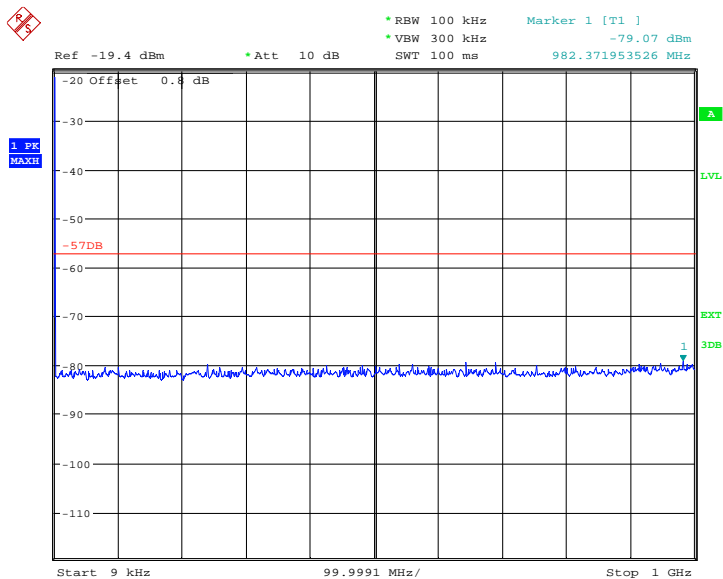

Date: 16.NOV.2010 02:39:55

1GHz to 11GHz

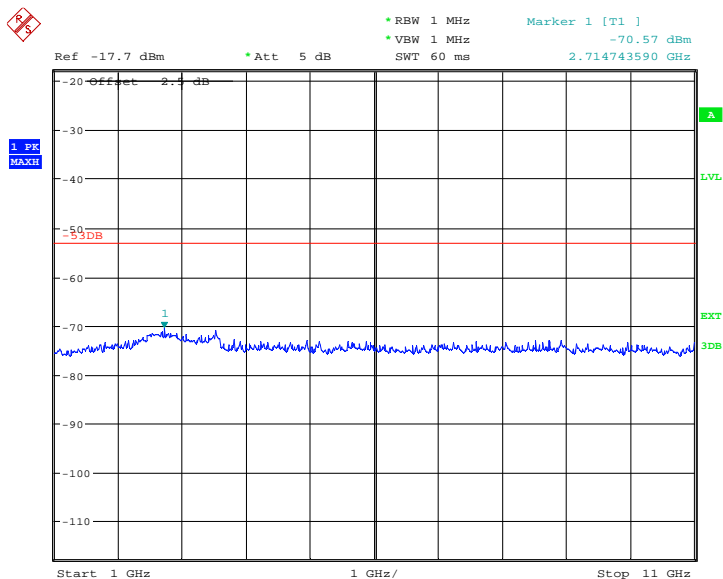

Date: 16.NOV.2010 02:41:33



Product Service

TM5

9kHz to 1GHz

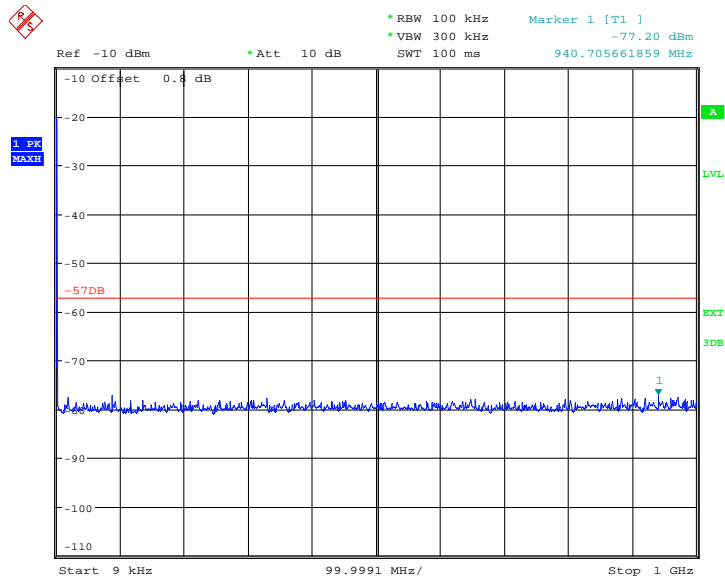

Date: 16.NOV.2010 03:05:16

1GHz to 11GHz

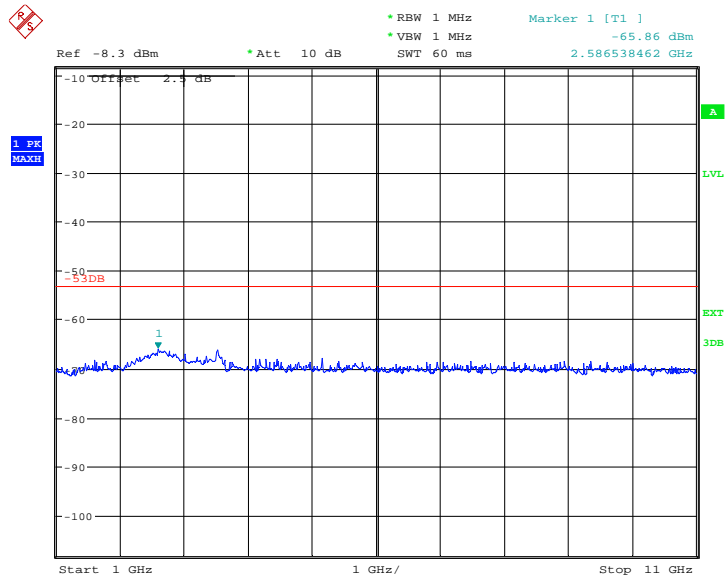

Date: 16.NOV.2010 03:06:01



Product Service

TM6

9kHz to 1GHz

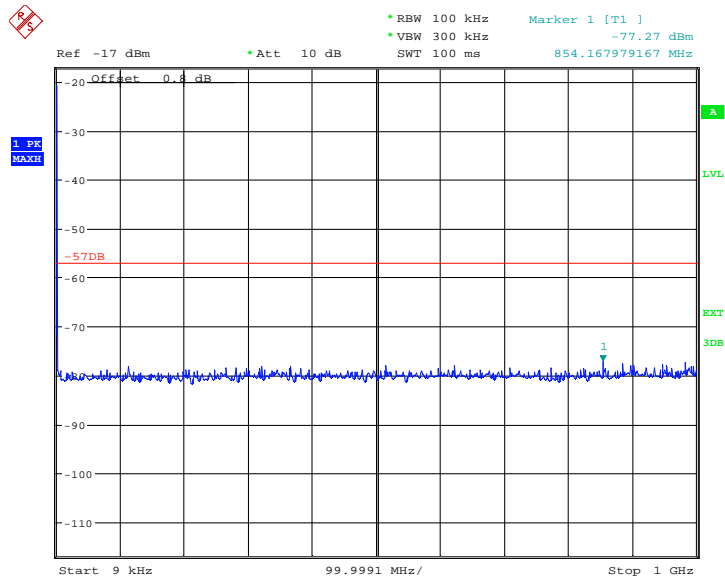

Date: 16.NOV.2010 03:29:14

1GHz to 11GHz

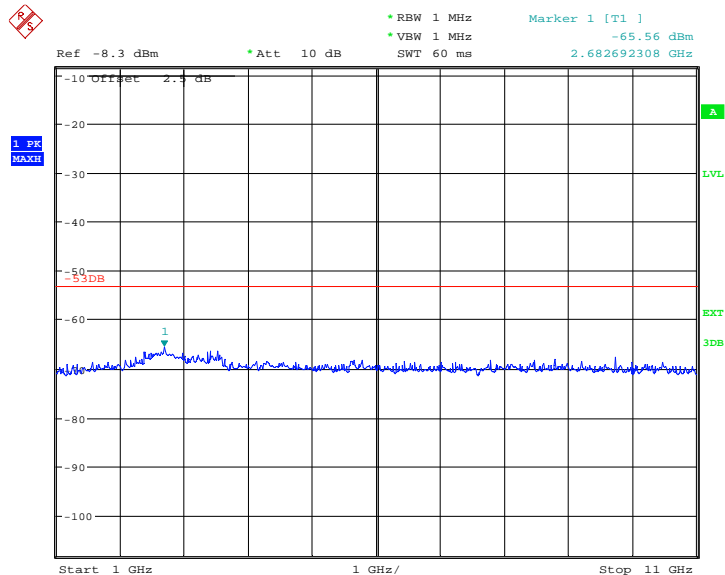

Date: 16.NOV.2010 03:28:01



Multi Carrier

Configuration 1- Mode 5

TM1

9kHz to 1GHz

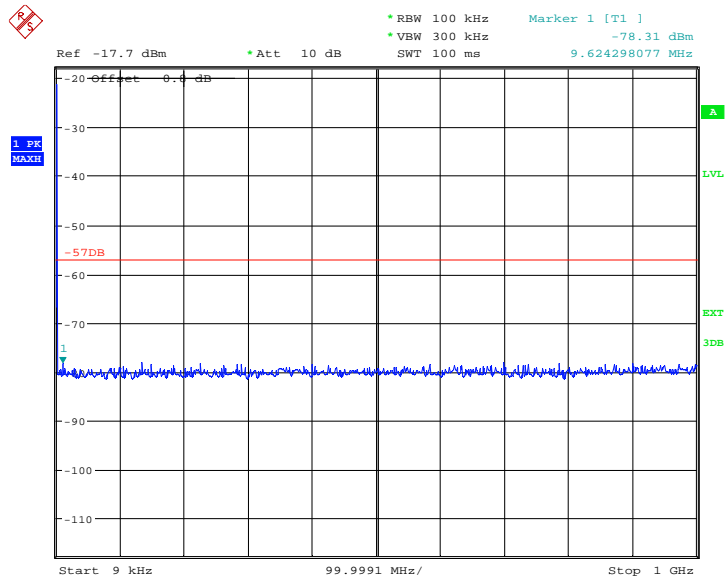

Date: 16.NOV.2010 04:35:31

1GHz to 11GHz

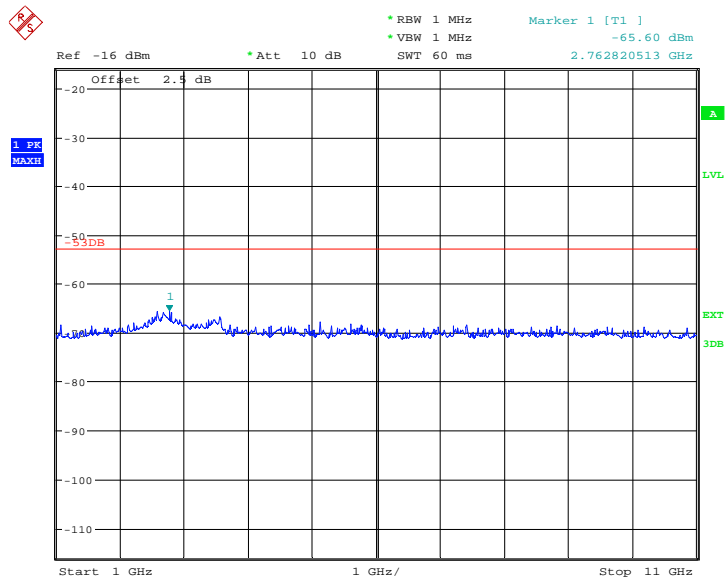

Date: 16.NOV.2010 04:34:25



Product Service

TM5

9kHz to 1GHz

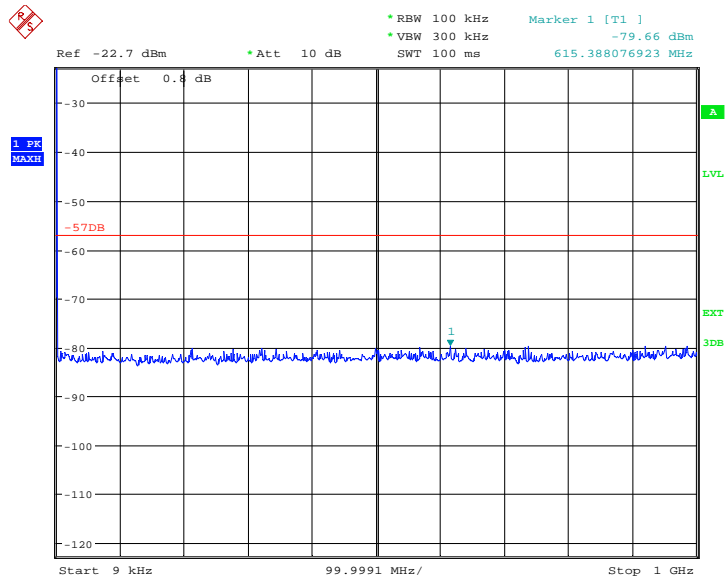

Date: 16.NOV.2010 04:27:21

1GHz to 11GHz

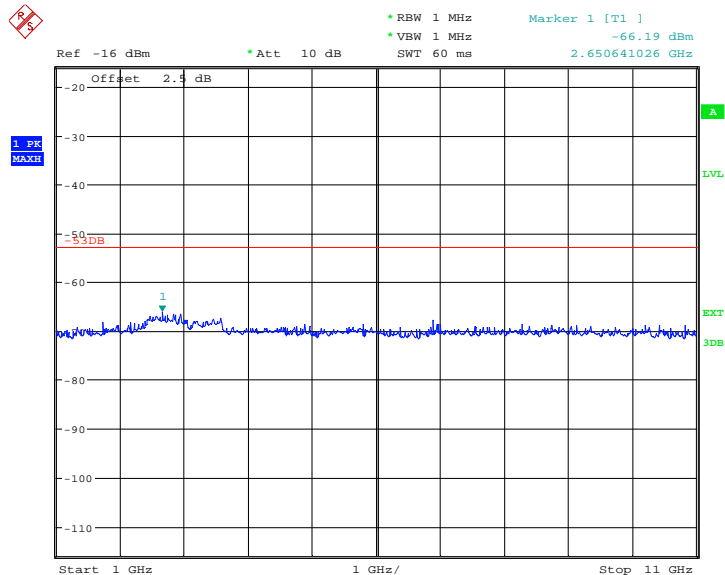

Date: 16.NOV.2010 04:27:59



TM6

9kHz to 1GHz

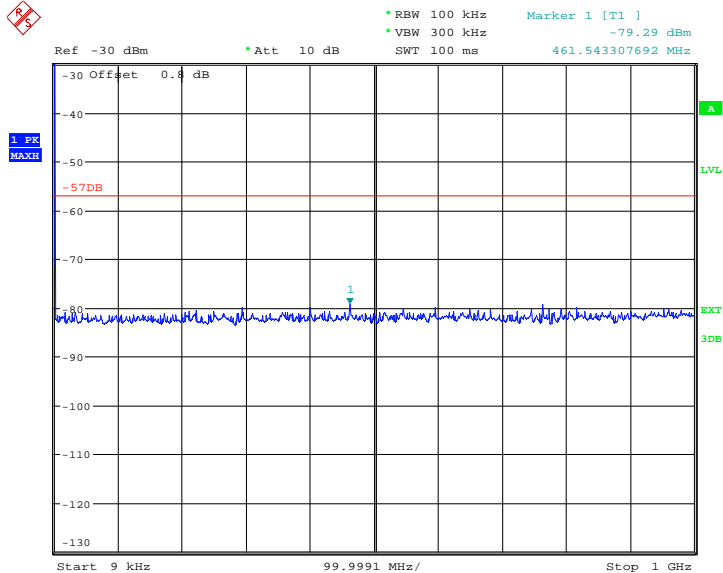

Date: 16.NOV.2010 04:08:10

1GHz to 11GHz

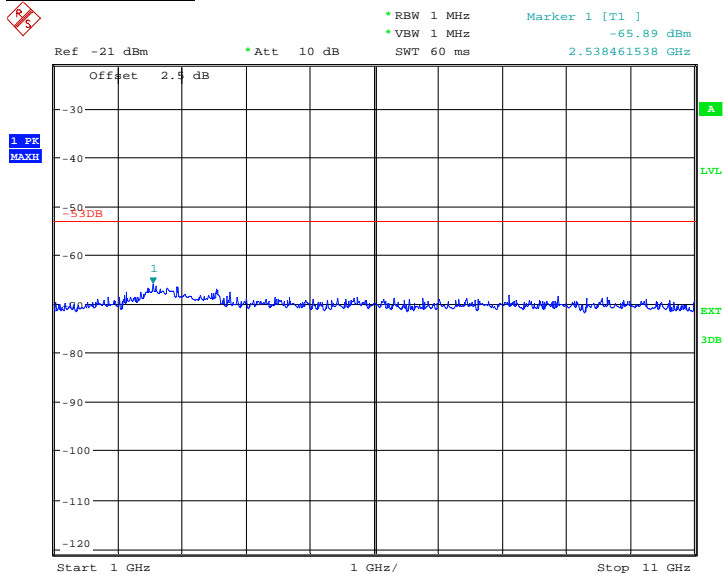

Date: 16.NOV.2010 04:09:03

Limit	-57dBm (30MHz-1GHz) and -53dBm (above 1GHz)
-------	---

Remarks

The EUT does not exceed -57dBm at the frequency range of 9kHz to 1GHz and does not exceed -53dBm at the frequency range of 1GHz to 11GHz.



Product Service

SECTION 3

TEST EQUIPMENT USED



3.1 TEST EQUIPMENT USED

List of absolute measuring and other principal items of test equipment.

Instrument	Manufacturer	Type No.	Serial No.	Calibration Due
Section 2.1, 2.2, 2.3, 2.4, 2.6 and 2.7 – Maximum Conducted Output Power, Peak – Average Ratio, Occupied Bandwidth, Spurious Emissions at Antenna Terminals (± 1MHz), Conducted Spurious Emissions and Receiver Spurious Emissions.				
Spectrum Analyser	Rohde & Schwarz	FSQ26	20-300542	25-Jul-2011
Spectrum Analyser	Agilent	E4440A	MY45304523	26-Apr-2011
Power Metre	Rohde & Schwarz	NRP	17-294752	26-May-2011
Thermal Power Sensor	Rohde & Schwarz	NRP-Z51	20-295642	07-Jun-2011
Network Analyzer	Agilent	8720D	US38431317	24-Aug-2011
40dB Attenuator	SHX	DTS100G	08011720	O/P MON
Load	Shanghai Huaxiang	TF100	09121648	O/P MON
Load	Shanghai Huaxiang	TF100	08011705	O/P MON
Digital Multi-meter	FLUKE	179	91820401	03-Jan-2011
Thermo-hygrometer	AZ Instruments	8705	9151655	16-Dec-2010
Section 2.5 – Radiated Spurious Emissions				
EMI Receiver	Rohde & Schwarz	ESI 40	100015	19-Aug-2011
Ultra log test antenna	Rohde & Schwarz	HL562	100167	19-Aug-2011
Double-Ridged Waveguide Horn Antenna	Rohde & Schwarz	HF 906	100029	19-Aug-2011
Antenna master	Frankonia	MA 260	-	19-Aug-2011
Relay Switch Unit	Rohde & Schwarz	331.1601.31	338965002	N/A
Full Anechoic Chamber	Frankonia	12.65m \times 8.03m \times 7.50m	-	19-Aug-2011
Power Supply	Dahua	DH1716-5D	-	O/P MON
Digital Multimeter	FLUKE	179	91820401	03-Jan-2011
Thermo-hygrometer	AZ Instruments	8705	9151655	16-Dec-2010

O/P MON Output monitored with calibration equipment



Product Service

3.2 MEASUREMENT UNCERTAINTY

For a 95% confidence level, the measurement uncertainties for defined systems are:-

Test Discipline	Frequency / Parameter	MU
Conducted Maximum Peak Output Power	30MHz to 10GHz Amplitude	0.5dB*
Conducted Emissions	30MHz to 40GHz Amplitude	3.0dB*
Frequency Stability	30MHz to 2GHz Amplitude	$<1 \times 10^{-7}$
Radiated Emissions, Bilog Antenna, AOATS	30MHz to 1GHz Amplitude	5.1dB*
Radiated Emissions, Horn Antenna, AOATS	1GHz to 40GHz Amplitude	6.3dB*
Worst case error for both Time and Frequency measurement 12 parts in 10^6		

* In accordance with CISPR 16-4



Product Service

SECTION 4

ACCREDITATION, DISCLAIMERS AND COPYRIGHT



Product Service

4.1 ACCREDITATION, DISCLAIMERS AND COPYRIGHT



This report relates only to the actual item/items tested.

Our UKAS Accreditation does not cover opinions and interpretations and any expressed are outside the scope of our UKAS Accreditation.

Results of tests not covered by our UKAS Accreditation Schedule are marked NUA
(Not UKAS Accredited).

This report must not be reproduced, except in its entirety, without the written permission of
TÜV Product Service Limited

© 2010 TÜV Product Service Limited