



Product Service

Choose certainty.
Add value.



Report On

FCC and IC Testing of the
Ericsson LTE and NB-IoT RRUS 01 B2 (1900 MHz), KRC 118 74/1,
KRC 118 74/2, Base Station in accordance with FCC CFR 47 Part 2,
FCC CFR 47 Part 24, Industry Canada RSS-GEN and Industry Canada
RSS-133

COMMERCIAL-IN-CONFIDENCE

FCC ID: TA8AKRC11874-1 and TA8AKRC11874-2

IC ID: 287AB-AS118741 and 287AB-AS118742

PREPARED BY

Maggie Whiting
Key Account Manager

APPROVED BY

Steve Scarfe
Authorised Signatory

DATED

05 April 2018

Document 75941045 Report 05 Issue 1

April 2018



Product Service

CONTENTS

Section	Page No
1	REPORT INFORMATION 2
1.1	Report Details 3
1.2	Brief Summary of Results 4
1.3	Configuration Description 5
1.4	Declaration of Build Status 6
1.5	Product Information 7
1.6	Test Setup 8
1.7	Test Conditions 9
1.8	Deviation From The Standard 9
1.9	Modification Record 9
1.10	Additional Information 9
2	TEST DETAILS 10
2.1	Maximum Peak Output Power and Peak to Average Ratio - Conducted 11
2.2	Occupied Bandwidth 18
2.3	Band Edge 24
2.4	Transmitter Spurious Emissions 30
2.5	Radiated Spurious Emissions 39
3	TEST EQUIPMENT USED 59
3.1	Test Equipment Used 60
3.2	Measurement Uncertainty 62
4	ACCREDITATION, DISCLAIMERS AND COPYRIGHT 63
4.1	Accreditation, Disclaimers and Copyright 64
ANNEX A	Module Lists A.2



Product Service

SECTION 1

REPORT INFORMATION



Product Service

1.1 REPORT DETAILS

Manufacturer	Ericsson
Address	Torshamnsgatan 23 Kista SE-16480 Stockholm Sweden
Product Name	RRUS 01 B2
Product Number	KRC 118 74/2
IC Model Name	AS118742
Serial Number(s)	D16q993637
Software Version	xrus_app-CXP9013268_6-R66AM.xlf (based on CXP9013268/6 R66BM)
Hardware Version	R1G
Non- Tested Variant	KRC 118 74/2
Non-Tested Variant IC Model Name	AS118741
Test Specification/Issue/Date	FCC CFR 47 Part 2: 2017 FCC CFR 47 Part 24: 2017 Industry Canada RSS-GEN: Issue 4: 2014 Industry Canada RSS-133: Issue 6: 2013
Start of Test	06 February 2018
Finish of Test	13 February 2018
Name of Engineer(s)	Raj Kumar Kallem Jack Tuckwell
Related Document(s)	KDB 971168 D01 v02r02 KDB 662911 D01 v02r01



Product Service

1.2 BRIEF SUMMARY OF RESULTS

A brief summary of results for each configuration, in accordance with FCC CFR 47 Part 2, FCC CFR 47 Part 24, Industry Canada RSS-GEN and Industry Canada RSS-133 is shown below.

Section	Specification Clause				Test Description	Result
	FCC CFR 47 Part 2	FCC CFR 47 Part 24	RSS-GEN	RSS-133		
2.1	2.1046	24.232 (a)	-	6.4	Maximum Peak Output Power and Peak to Average Ratio - Conducted	Pass
2.2	2.1049	24.238 (b)	6.6	-	Occupied Bandwidth	Pass
2.3	2.1051	24.238 (b)	-	6.5	Band Edge	Pass
2.4	2.1051	24.238 (a)	-	6.5	Transmitter Spurious Emissions	Pass
2.5	2.1053	24.238	-	6.5	Radiated Spurious Emissions	Pass



Product Service

1.3 CONFIGURATION DESCRIPTION

Configuration	RAT	No. Of carriers	Carrier Bandwidth	Carrier Frequency Configuration (MHz)		
				Bottom	Middle	Top
A	LTE+NB IoT GB	1	10 MHz	1935.0	-	1985.0
A	LTE+NB IoT GB	1	15 MHz	1937.5	-	1982.5
A	LTE+NB IoT GB	1	20 MHz	1940.0	-	1980.0
B	NB IoT SA	1	0.18 MHz	1960.0	1930.2	1989.8



Product Service

1.4 DECLARATION OF BUILD STATUS

MAIN EUT		
MANUFACTURING DESCRIPTION	Remote Radio Unit	
MANUFACTURER	Ericsson AB	
PRODUCT NAME	RRUS 01 B2	
PART NUMBER	KRC 118 74/1	KRC 118 74/2
IC Model Name	AS118741	AS118742
SERIAL NUMBER	-	D16q993637
HARDWARE VERSION	-	R1G
SOFTWARE VERSION	xrus_app-CXP9013268_6-R66AM.xlf (based on CXP9013268/6 R66BM)	
TRANSMITTER OPERATING RANGE	1930 to 1990 MHz	
MODULATIONS	LTE: QPSK, 16QAM, 64QAM, 256QAM	LTE: QPSK, 16QAM, 64QAM, 256QAM
	WCDMA: QPSK, 16QAM, 64QAM	WCDMA: QPSK, 16QAM, 64QAM
	GSM: GMSK, 8-PSK, AQPSK, 16QAM, 32QAM	GSM: GMSK, 8-PSK, AQPSK, 16QAM, 32QAM
INTERMEDIATE FREQUENCIES	-	-
ITU DESIGNATION OF EMISSION	GSM: 210KGXW	GSM: 210KGXW
	WCDMA: 3M90F9W, 4M20F9W	WCDMA: 3M90F9W, 4M20F9W
	1,4 MHz BW channel: 1M30F9W	1,4 MHz BW channel: 1M30F9W
	3 MHz BW channel: 2M95F9W	3 MHz BW channel: 2M95F9W
	5 MHz BW channel: 4M90F9W	5 MHz BW channel: 4M90F9W
	10 MHz BW channel ¹ : 9M45F9W	10 MHz BW channel ¹ : 9M45F9W
	15 MHz BW channel ¹ : 14M2F9W	15 MHz BW channel ¹ : 14M2F9W
	20 MHz BW channel ¹ : 18M8F9W	20 MHz BW channel ¹ : 18M8F9W
	NB-IoT SA 200 kHz BW channel: 210KW7D	NB-IoT SA 200 kHz BW channel: 210KW7D
OUTPUT POWER (RMS) (W or dBm)	KRC 118 74/1: 1x60W ¹	KRC 118 74/2: 1x80W ¹
	NB-IoT SA 1x20W	NB-IoT SA 1x20W
FCC ID	TA8AKRC11874-1	TA8AKRC11874-2
IC ID	287AB-AS118741	287AB-AS118742
TECHNICAL DESCRIPTION (a brief description of the intended use and operation)	Base station radio	

¹ Including 2 NB-IoT GB carriers.

Signature

Linda Grell

Date

2018-03-05

No responsibility will be accepted by TÜV SÜD Product Service UK Limited as to the accuracy of the information declared in this document by the manufacturer.

1.5 PRODUCT INFORMATION

1.5.1 Technical Description

The Equipment Under Test (EUT) KRC 118 74/2 is an Ericsson AB Radio Unit working in the public mobile service 1900 band which provides communication connections to 1900 network. The KRC 118 66/2 and KRC 118 74/2 operates from a -48V DC supply.

The Equipment Under Test (EUT) is shown in the photograph below. A full technical description can be found in the Manufacturer's documentation.

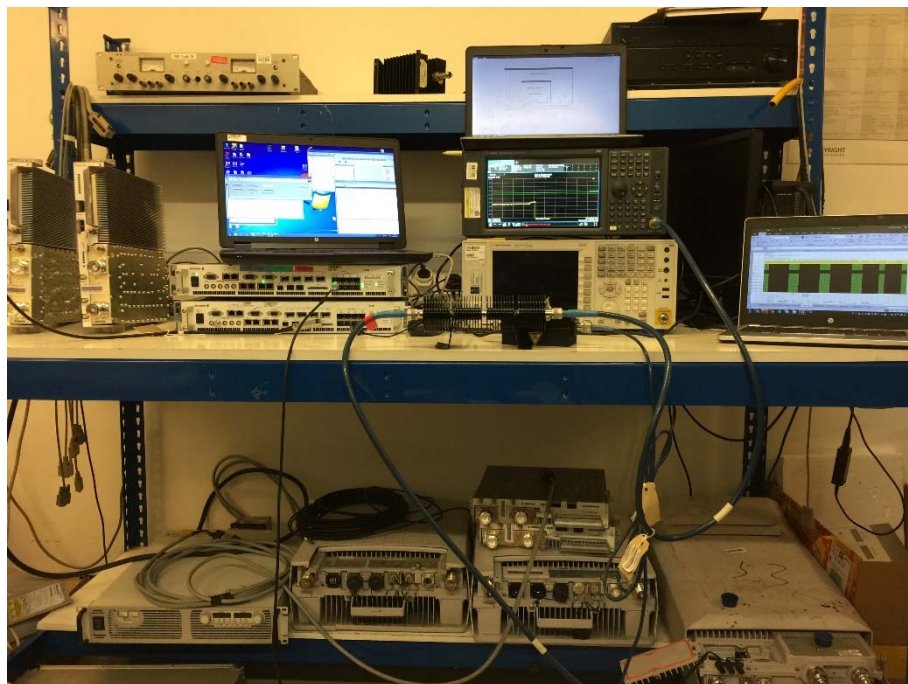

Equipment Under Test

1.6 TEST SETUP

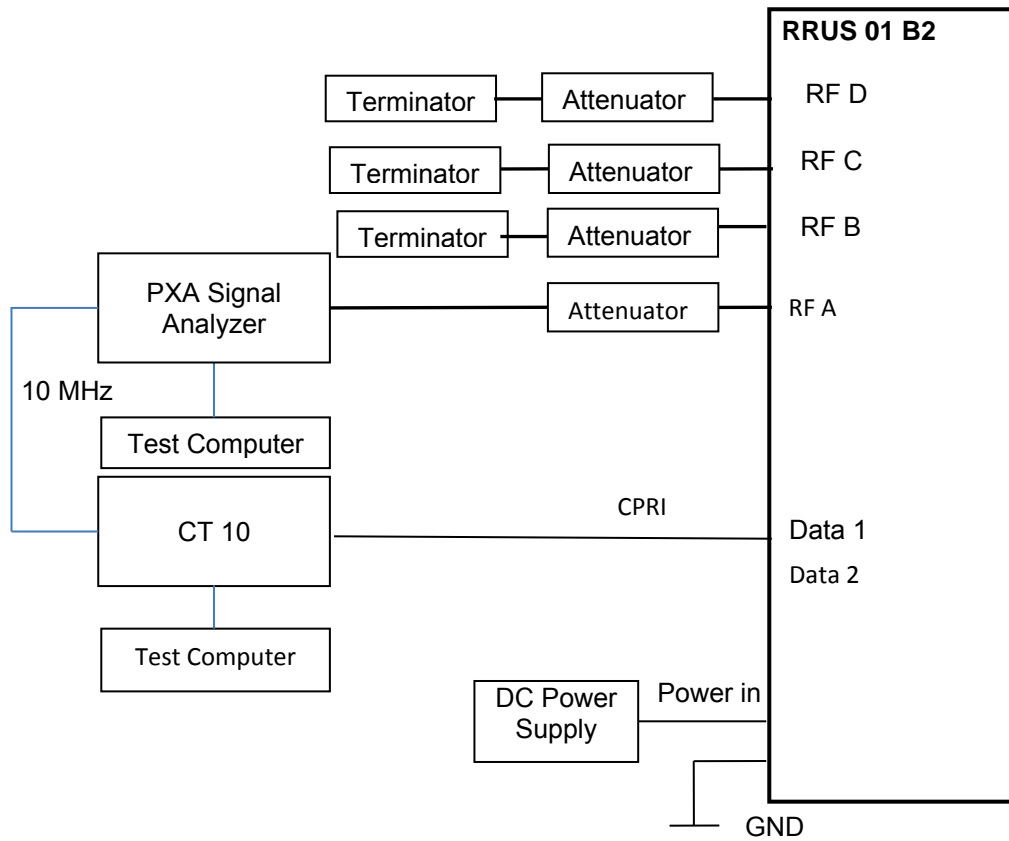

Figure 1, Block diagram of RRUS 01 B2 with cables and auxiliary equipment



Product Service

1.7 TEST CONDITIONS

For all tests the EUT was set up in accordance with the relevant test standard and to represent typical operating conditions. Tests were applied with the EUT situated in a shielded enclosure, test laboratories or a chamber as appropriate.

The EUT was powered from a -48V DC supply.

FCC Measurement Facility Registration Number
90987 Octagon House, Fareham Test Laboratory

1.8 DEVIATION FROM THE STANDARD

No deviations from the applicable test standards or test plan were made during testing.

1.9 MODIFICATION RECORD

No modifications were made to the EUT during testing.

1.10 ADDITIONAL INFORMATION

The test results relate only to the item(s) tested RRUS 01 B2 KRC 118 74/2
The KRC 118 74/1 is a low power version of the KRC 118 74/2, it has the same Hardware but the output power is 60W and so can also be considered as compliant too.



Product Service

SECTION 2

TEST DETAILS



Product Service

2.1 MAXIMUM PEAK OUTPUT POWER AND PEAK TO AVERAGE RATIO - CONDUCTED

2.1.1 Specification Reference

FCC CFR 47 Part 2, Clause 2.1046
FCC CFR 47 Part 24, Clause 24.232 (a)
Industry Canada RSS-133, Clause 6.4

2.1.2 Date of Test and Modification State

13 February 2018 - Modification State 0

2.1.3 Test Equipment Used

The major items of test equipment used for the above tests are identified in Section 3.1.

2.1.4 Environmental Conditions

Ambient Temperature 21.8°C
Relative Humidity 31.3%

2.1.5 Test Method

All measurements were made in accordance with FCC KDB 971168 D01, clause 5.2.1 and summed in accordance with FCC KDB 662911 D01.

2.1.6 Test Results

Configuration A

Maximum Output Power 47.8/49 dBm

Antenna	LTE Modulation	LTE Carrier Bandwidth	Peak to Average Ratio (PAR) / Output Power		
			Channel Position B		
			PAR (dB)	Average Power	
dBm	dBm/MHz				
A	64QAM	10.0 MHz	6.68	48.46	-
A	64QAM	15.0 MHz	6.77	48.64	-
A	64QAM	20.0 MHz	6.87	48.58	-



Product Service

Antenna A - LTE Modulation 64QAM - LTE Carrier Bandwidth 10.0 MHz - Channel Position B

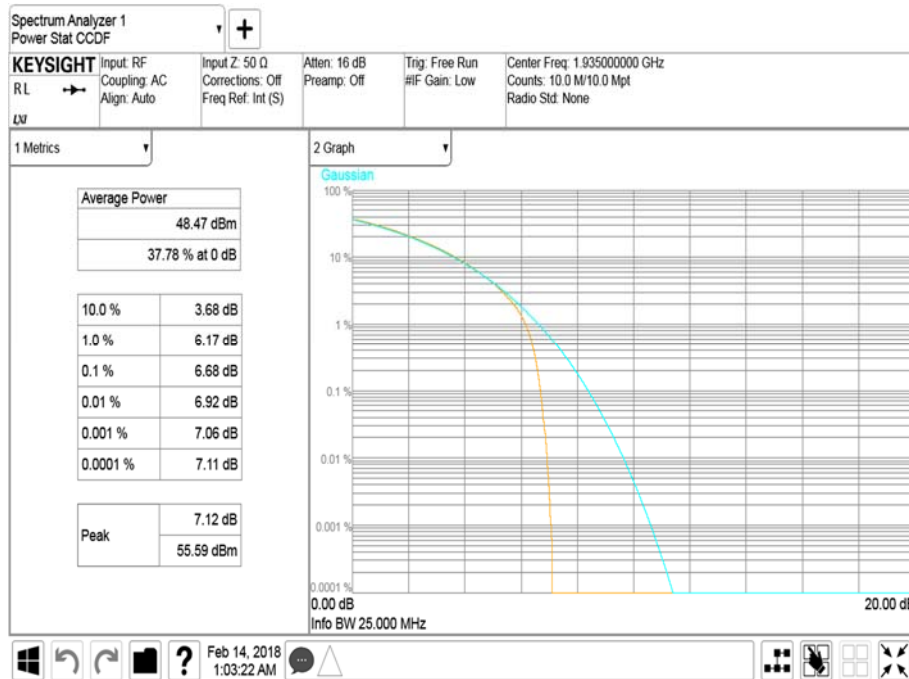

Antenna A - LTE Modulation 64QAM - LTE Carrier Bandwidth 15.0 MHz - Channel Position B

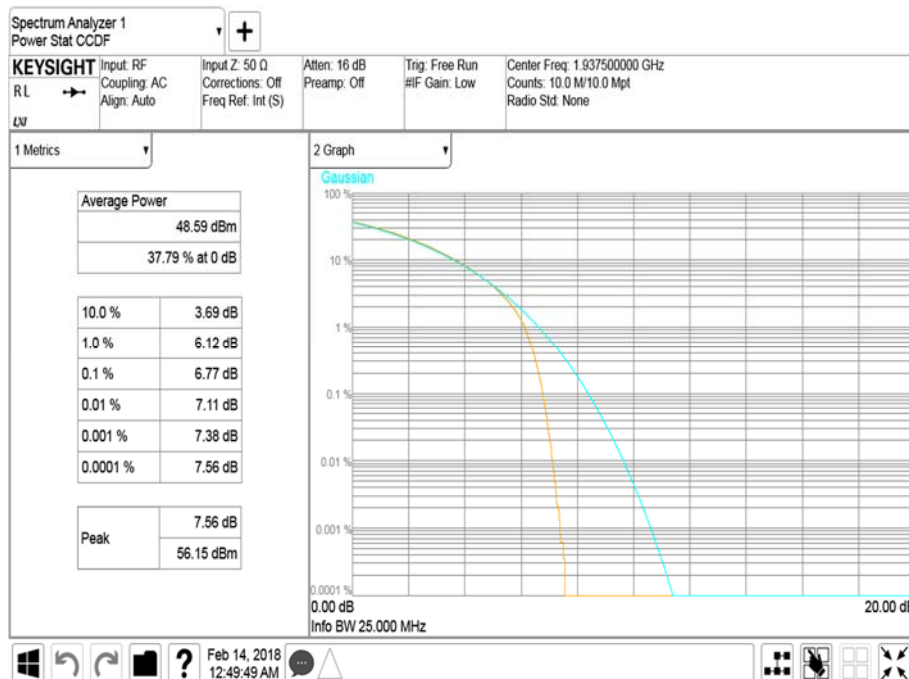



Product Service

Antenna A - LTE Modulation 64QAM - LTE Carrier Bandwidth 20.0 MHz - Channel Position B

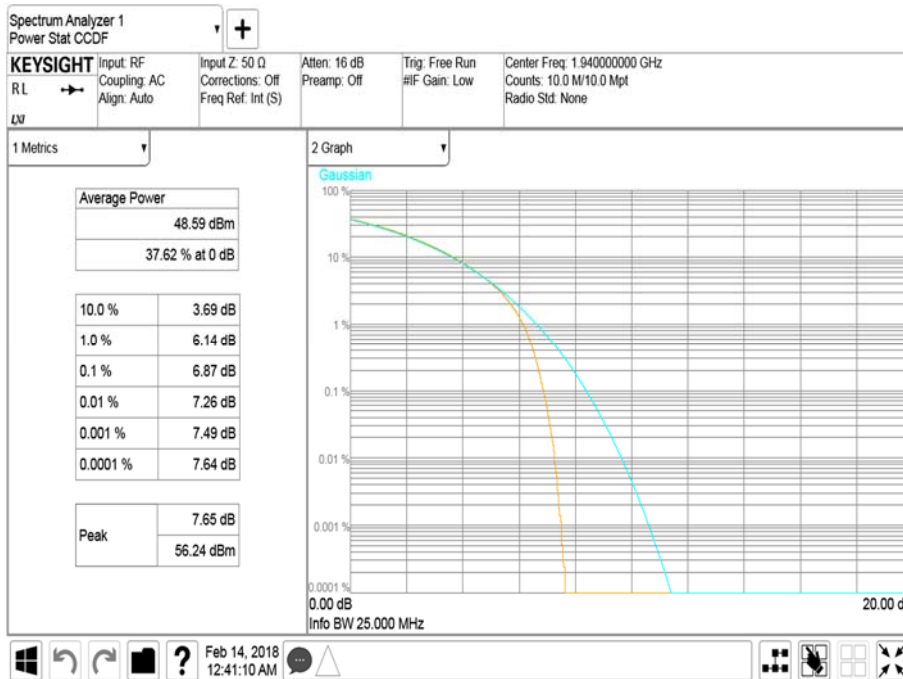

Configuration A

Maximum Output Power 47.8/49 dBm

Antenna	LTE Modulation	LTE Carrier Bandwidth	Peak to Average Ratio (PAR) / Output Power		
			Channel Position T		
			PAR (dB)	Average Power	
dBm	dBm/MHz				
A	64QAM	10.0 MHz	6.61	48.44	-
A	64QAM	15.0 MHz	6.64	48.54	-
A	64QAM	20.0 MHz	6.70	48.60	-



Product Service

Antenna A - LTE Modulation 64QAM - LTE Carrier Bandwidth 10.0 MHz - Channel Position T

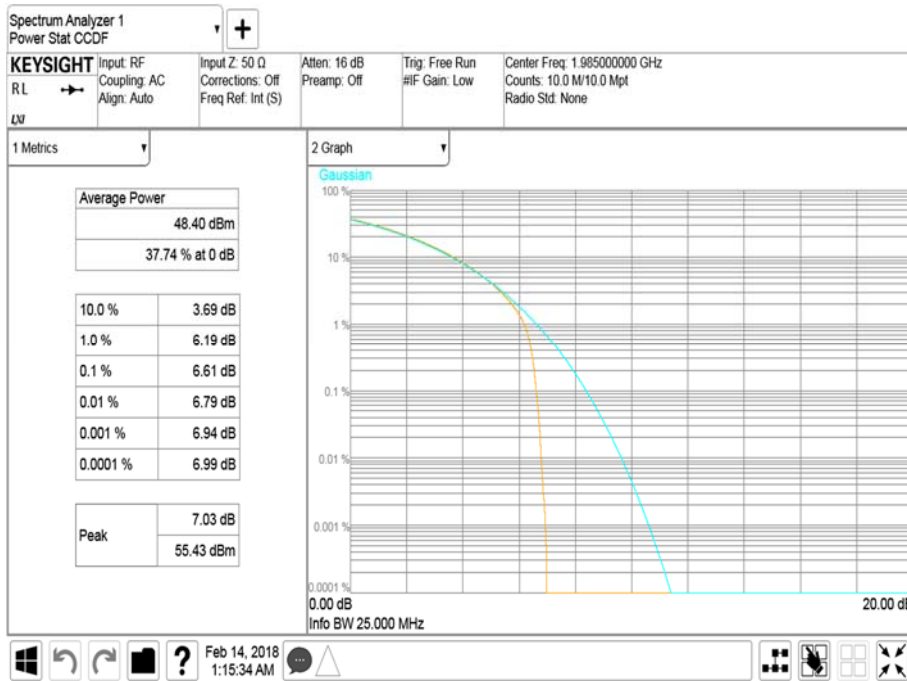

Antenna A - LTE Modulation 64QAM - LTE Carrier Bandwidth 15.0 MHz - Channel Position T

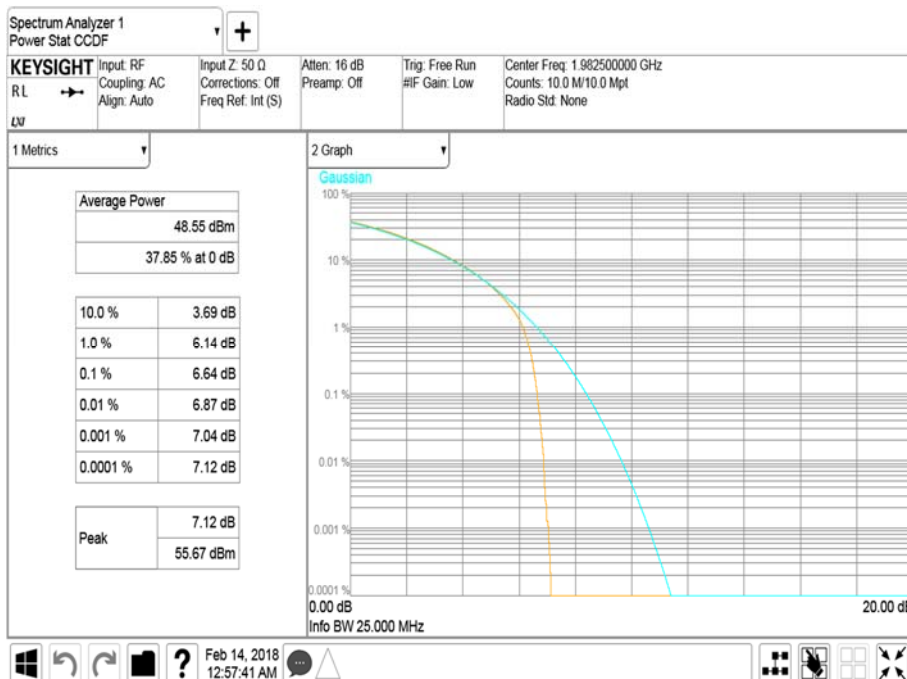



Product Service

Antenna A - LTE Modulation 64QAM - LTE Carrier Bandwidth 20.0 MHz - Channel Position T

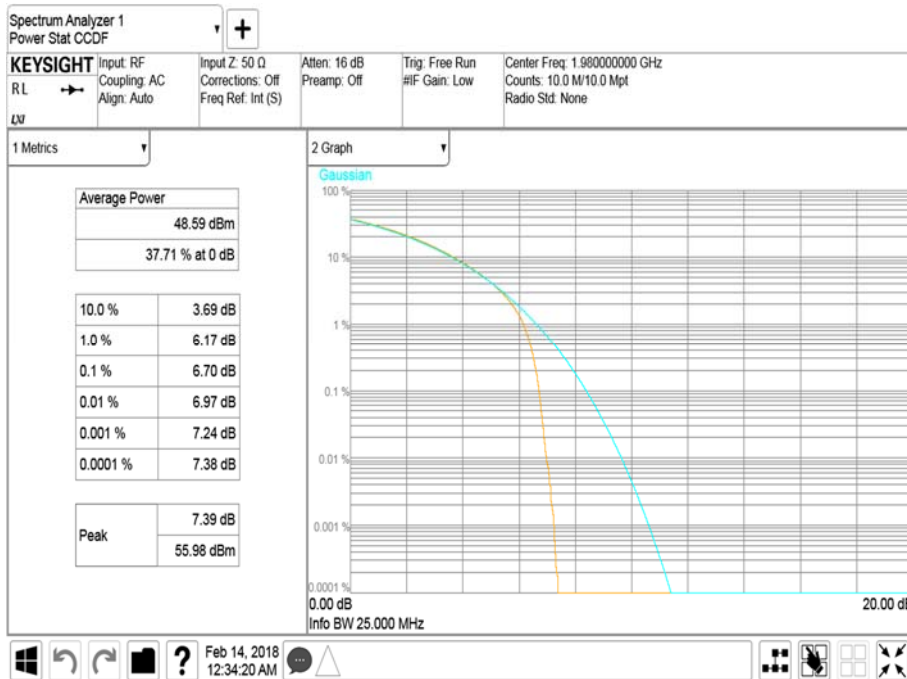

Configuration B

Maximum Output Power 47.8/49 dBm

Antenna	NB IoT Modulation	NB IoT Carrier Bandwidth	Peak to Average Ratio (PAR) / Output Power		
			Channel Position B		
			PAR (dB)	Average Power	
dBm	dBm/MHz				
A	QPSK	0.2 MHz	4.08	41.93	-



Product Service

Antenna A - NB IoT Modulation QPSK - NB IoT Carrier Bandwidth 0.2 MHz - Channel Position B

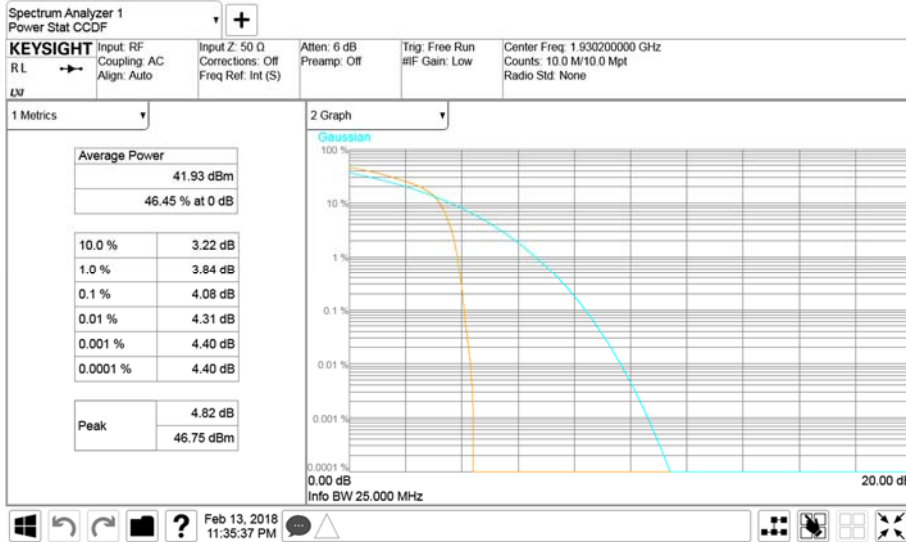

Configuration B

Maximum Output Power 47.8/49 dBm

Antenna	NB IoT Modulation	NB IoT Carrier Bandwidth	Peak to Average Ratio (PAR) / Output Power		
			Channel Position M		
			PAR (dB)	Average Power	
dBm	dBm/MHz				
A	QPSK	0.2 MHz	4.02	42.18	-

Antenna A - NB IoT Modulation QPSK - NB IoT Carrier Bandwidth 0.2 MHz - Channel Position M

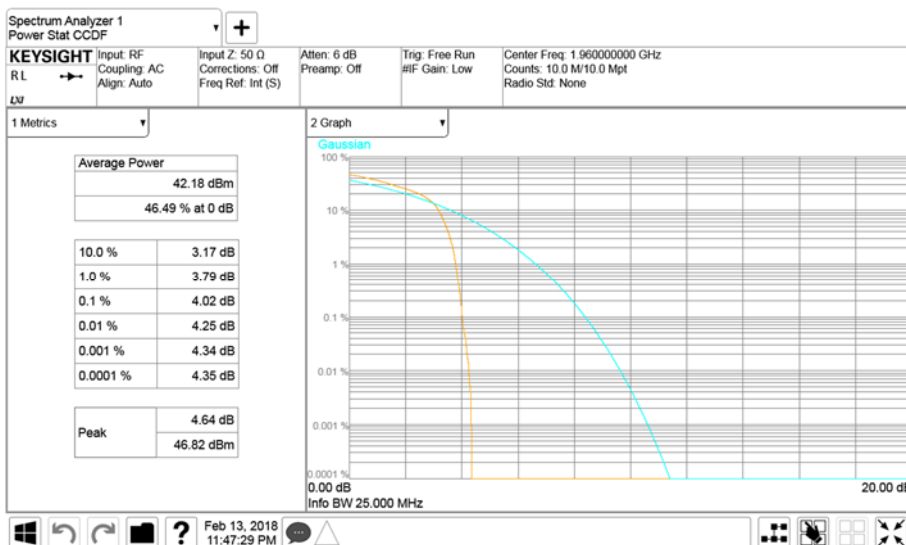



Product Service

Configuration B

Maximum Output Power 47.8/49 dBm

Antenna	NB IoT Modulation	NB IoT Carrier Bandwidth	Peak to Average Ratio (PAR) / Output Power		
			Channel Position T		
			PAR (dB)	Average Power	
dBm	dBm/MHz				
A	QPSK	0.2 MHz	4.08	42.13	-

Antenna A - NB IoT Modulation QPSK - NB IoT Carrier Bandwidth 0.2 MHz - Channel Position T

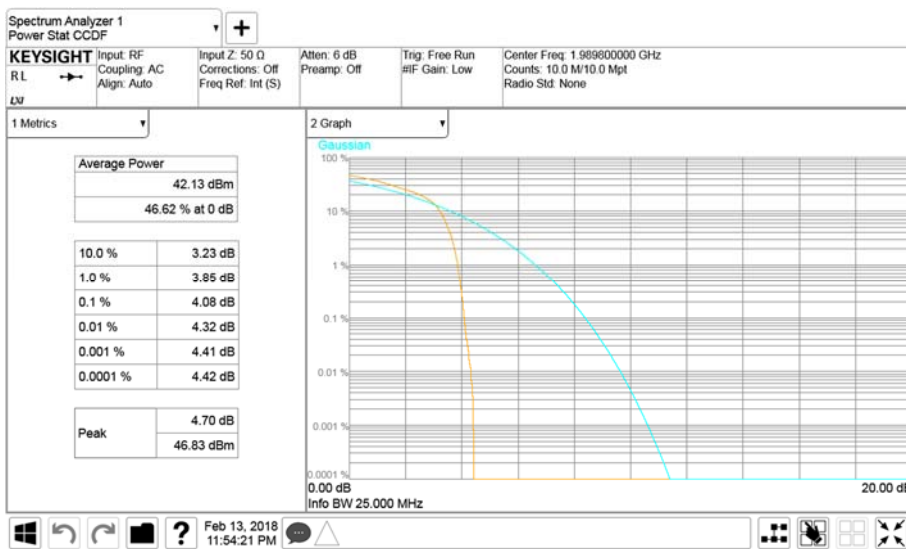

Limit	
Peak Power	≤500 W or ≤+57 dBm
Peak to Average Ratio	13 dB



2.2 OCCUPIED BANDWIDTH

2.2.1 Specification Reference

FCC CFR 47 Part 2, Clause 2.1049
FCC CFR 47 Part 24, Clause 24.238 (b)
Industry Canada RSS-GEN, Clause 6.6

2.2.2 Date of Test and Modification State

13 February 2018 - Modification State 0

2.2.3 Test Equipment Used

The major items of test equipment used for the above tests are identified in Section 3.1.

2.2.4 Environmental Conditions

Ambient Temperature 21.8°C
Relative Humidity 31.3%

2.2.5 Test Method

All measurements were made in accordance with FCC KDB 971168 D01.

2.2.6 Test Results

Configuration A

Maximum Output Power 47.8/49 dBm

Antenna	LTE Modulation	LTE Carrier Bandwidth	Result (KHz)					
			Channel Position B		Channel Position M		Channel Position T	
			Occupied Bandwidth	-26 dB Bandwidth	Occupied Bandwidth	-26 dB Bandwidth	Occupied Bandwidth	-26 dB Bandwidth
A	64QAM	10.0 MHz	9,413.49	9,763.37	-	-	9,414.90	9,783.06
A	64QAM	15.0 MHz	14,041.83	14,674.01	-	-	14,041.30	14,736.32
A	64QAM	20.0 MHz	18,441.72	19,573.43	-	-	18,448.24	19,509.83



Product Service

Antenna A - LTE Modulation 64QAM - LTE Carrier Bandwidth 10.0 MHz - Channel Position B

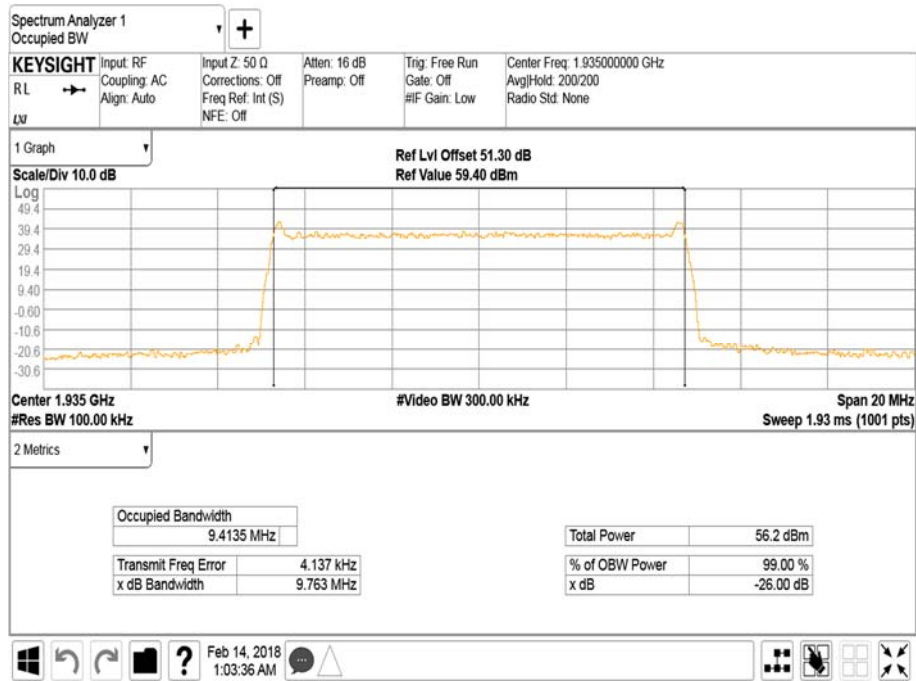

Antenna A - LTE Modulation 64QAM - LTE Carrier Bandwidth 10.0 MHz - Channel Position T

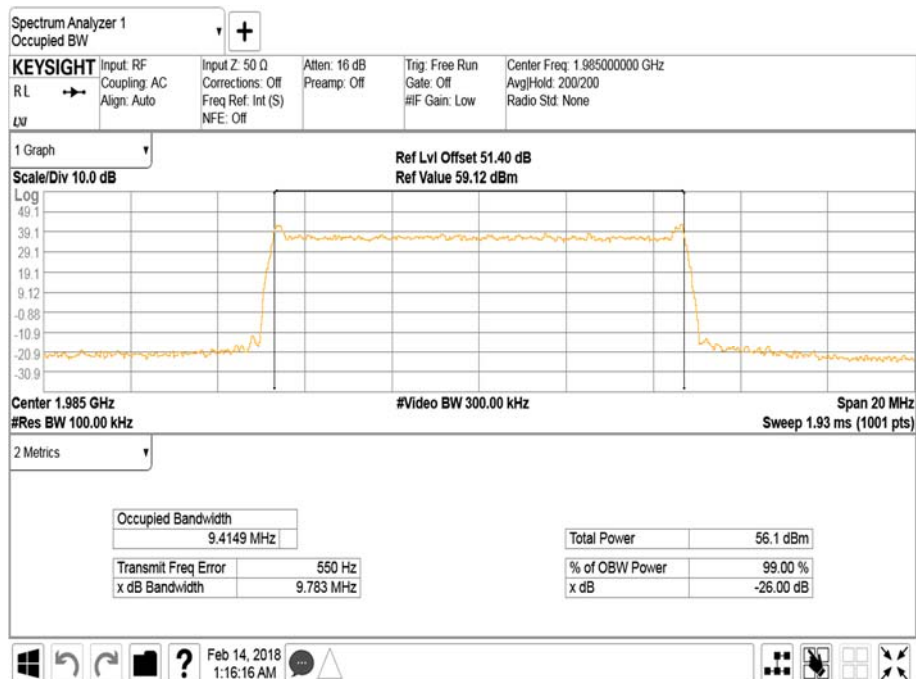



Product Service

Antenna A - LTE Modulation 64QAM - LTE Carrier Bandwidth 15.0 MHz - Channel Position B

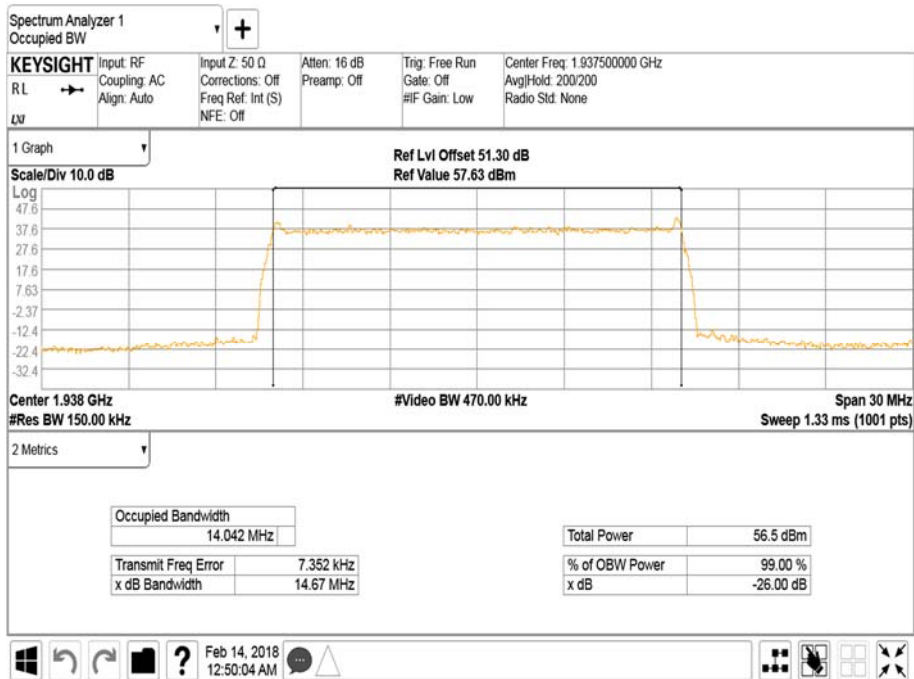

Antenna A - LTE Modulation 64QAM - LTE Carrier Bandwidth 15.0 MHz - Channel Position T

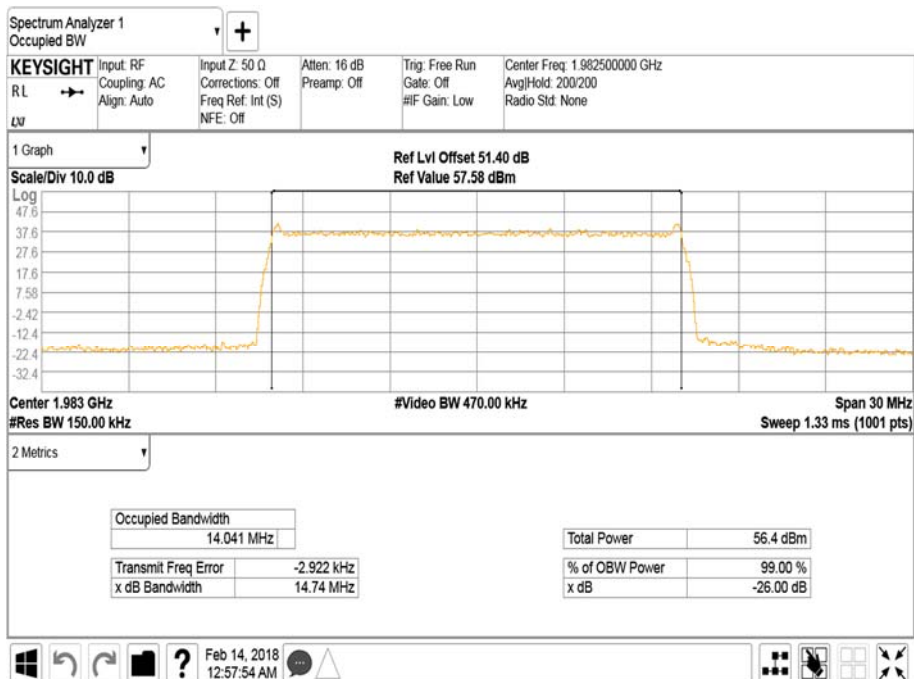



Product Service

Antenna A - LTE Modulation 64QAM - LTE Carrier Bandwidth 20.0 MHz - Channel Position B



Antenna A - LTE Modulation 64QAM - LTE Carrier Bandwidth 20.0 MHz - Channel Position T

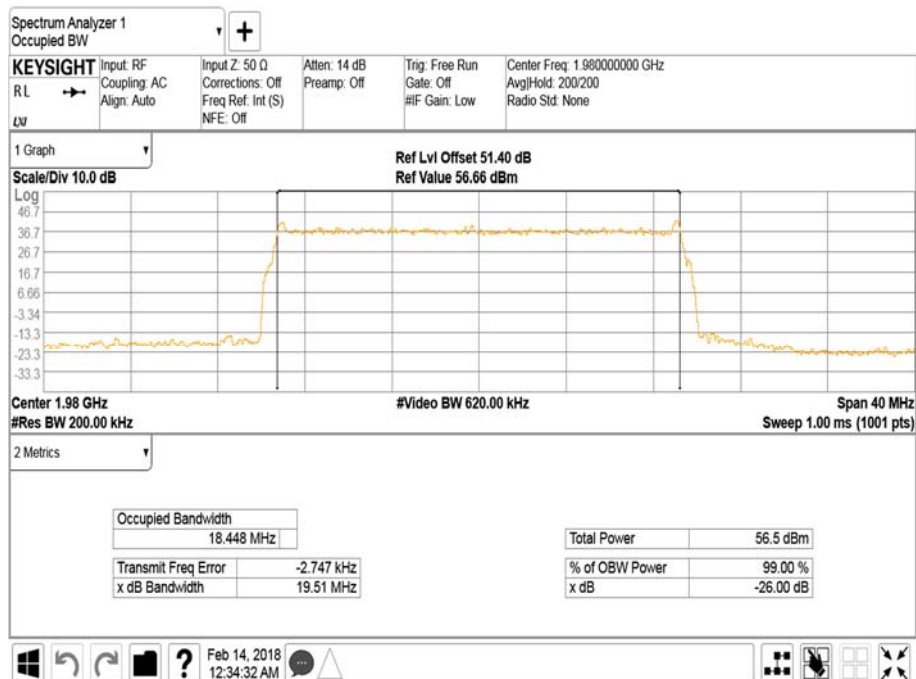



Product Service

Configuration B

Maximum Output Power 47.8/49 dBm

Antenna	NB IoT Modulation	NB IoT Carrier Bandwidth	Result (KHz)					
			Channel Position B		Channel Position M		Channel Position T	
			Occupied Bandwidth	-26 dB Bandwidth	Occupied Bandwidth	-26 dB Bandwidth	Occupied Bandwidth	-26 dB Bandwidth
A	QPSK	0.2 MHz	209.42	318.30	209.49	318.30	209.45	318.30

Antenna A - NB IoT Modulation QPSK - NB IoT Carrier Bandwidth 0.2 MHz - Channel Position B

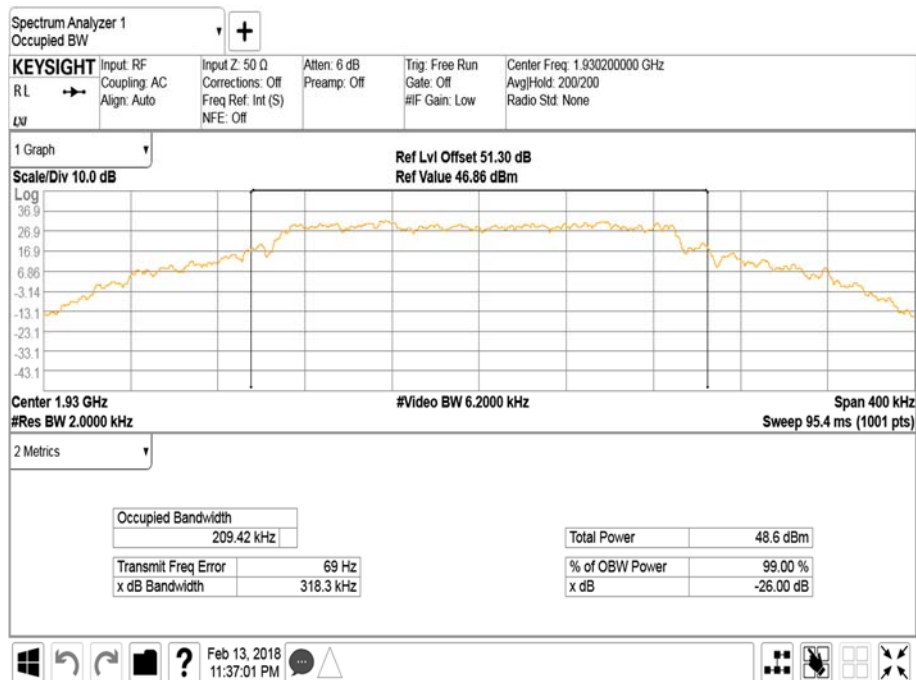



Product Service

Antenna A - NB IoT Modulation QPSK - NB IoT Carrier Bandwidth 0.2 MHz - Channel Position M

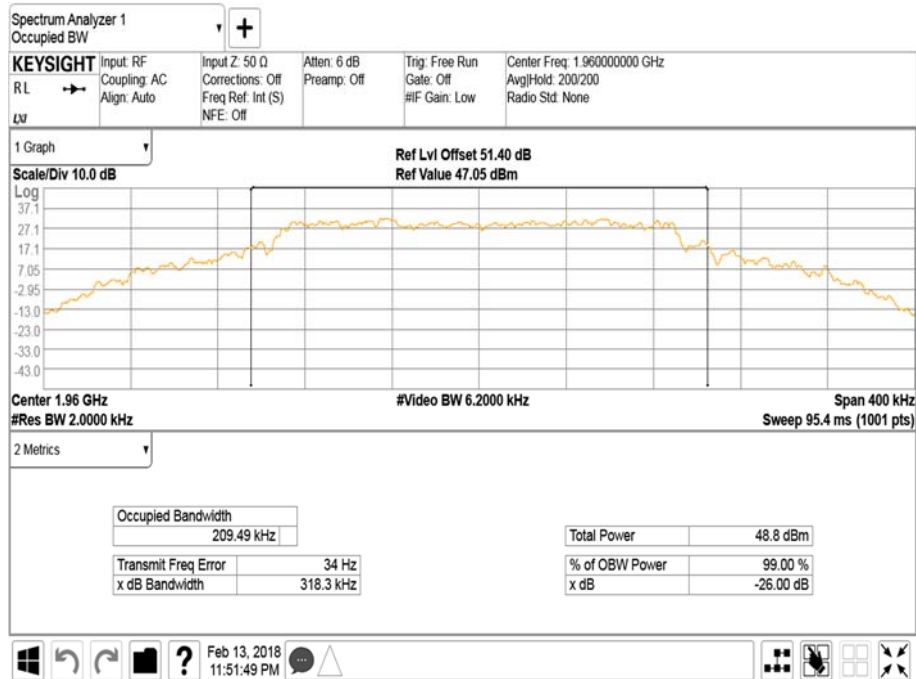

Antenna A - NB IoT Modulation QPSK - NB IoT Carrier Bandwidth 0.2 MHz - Channel Position T

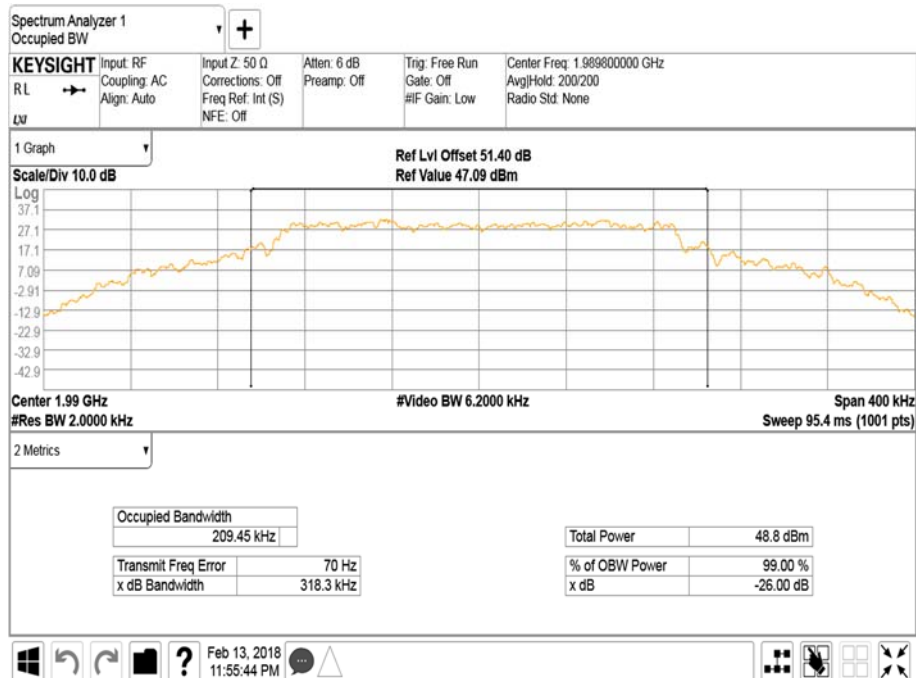



2.3 BAND EDGE

2.3.1 Specification Reference

FCC CFR 47 Part 2, Clause 2.1051
FCC CFR 47 Part 24, Clause 24.238 (b)
Industry Canada RSS-133, Clause 6.5

2.3.2 Date of Test and Modification State

13 February 2018 - Modification State 0

2.3.3 Test Equipment Used

The major items of test equipment used for the above tests are identified in Section 3.1.

2.3.4 Environmental Conditions

Ambient Temperature 21.8°C
Relative Humidity 31.3%

2.3.5 Test Method

All measurements were made in accordance with FCC KDB 971168 D01.

Each antenna port has been declared as being equivalent, therefore measurements were made on one antenna port only. To account for this, the limit was tightened by $10 * \text{Log}(N)$, where N is equal to the number of MIMO antenna ports.

For single carrier, the limit was calculated as being $-13 \text{ dBm} - 10 * \text{Log}(4) = -19 \text{ dBm}$.

For dual carrier, the limit was calculated as being $-13 \text{ dBm} - 10 * \text{Log}(2) = -16 \text{ dBm}$.

2.3.6 Test Results

Configuration A

Maximum Output Power 47.8/49 dBm

Antenna	LTE Modulation	LTE Carrier Bandwidth	Band Edge (MHz)	
			Channel Position B	Channel Position T
A	64QAM	10.0 MHz	1,935.0	1,985.0
A	64QAM	15.0 MHz	1,937.5	1,982.5
A	64QAM	20.0 MHz	1,940.0	1,980.0



Product Service

Antenna A - LTE Modulation 64QAM - LTE Carrier Bandwidth 10.0 MHz - Channel Position B

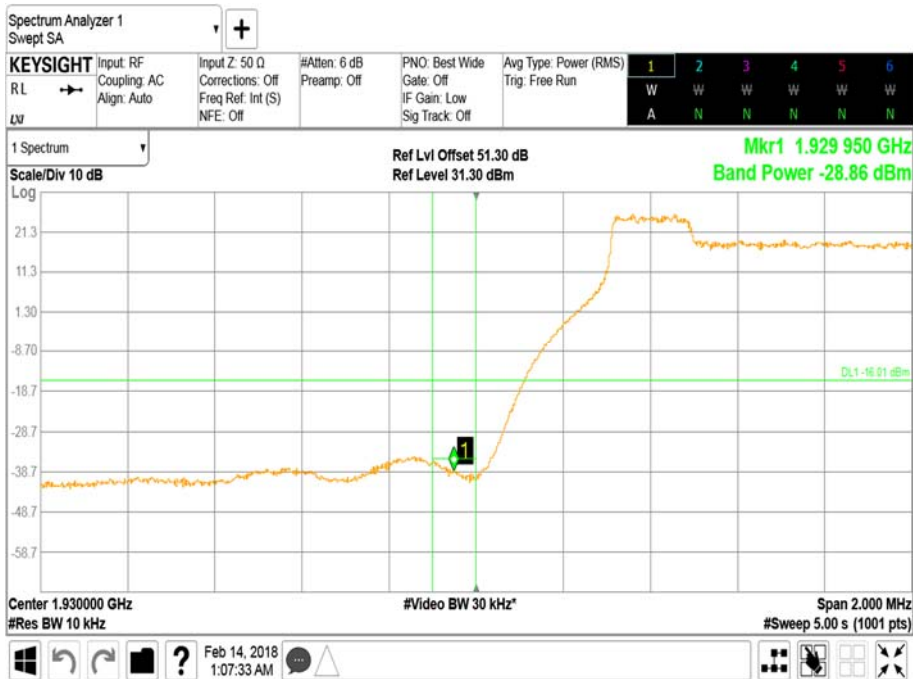

Antenna A - LTE Modulation 64QAM - LTE Carrier Bandwidth 10.0 MHz - Channel Position T

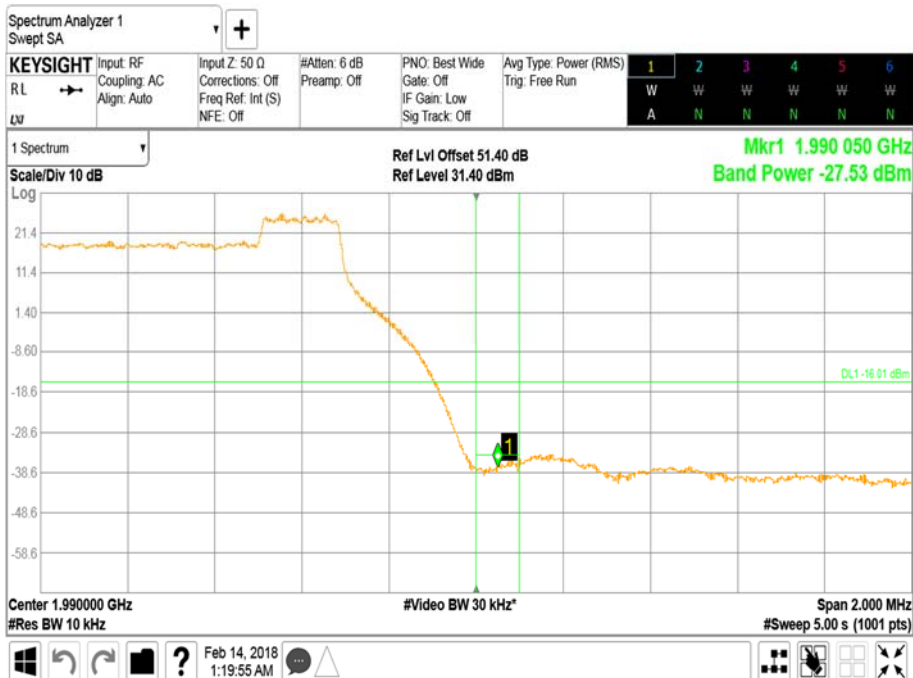



Product Service

Antenna A - LTE Modulation 64QAM - LTE Carrier Bandwidth 15.0 MHz - Channel Position B



Antenna A - LTE Modulation 64QAM - LTE Carrier Bandwidth 15.0 MHz - Channel Position T





Product Service

Antenna A - LTE Modulation 64QAM - LTE Carrier Bandwidth 20.0 MHz - Channel Position B



Antenna A - LTE Modulation 64QAM - LTE Carrier Bandwidth 20.0 MHz - Channel Position T

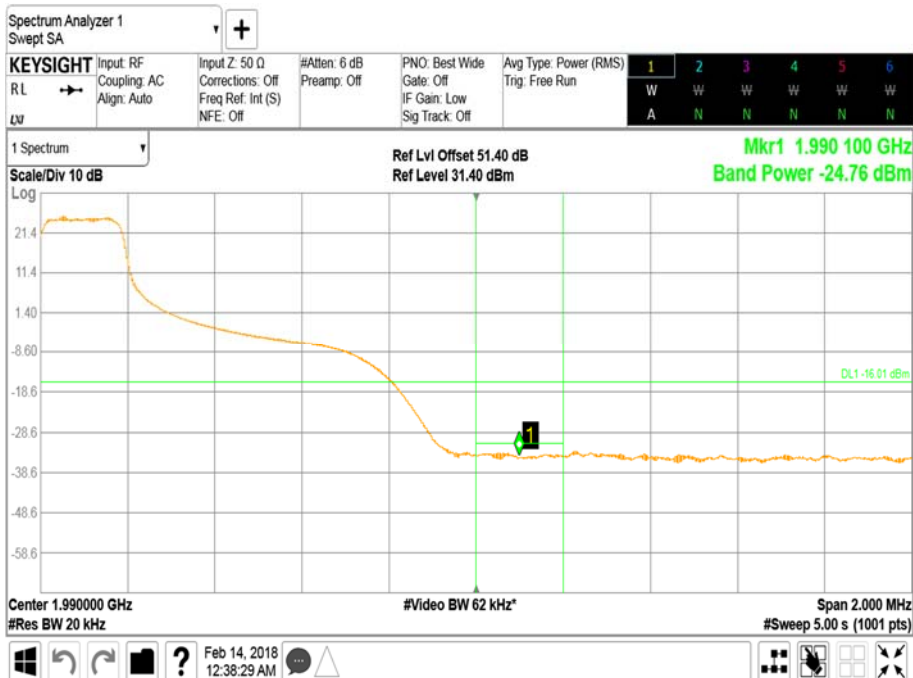



Product Service

Configuration B

Maximum Output Power 47.8/49 dBm

Antenna	NB IoT Modulation	NB IoT Carrier Bandwidth	Band Edge (MHz)	
			Channel Position B	Channel Position T
A	QPSK	0.2 MHz	1,930.0	1,990.0

Antenna A - NB IoT Modulation QPSK - NB IoT Carrier Bandwidth 0.2 MHz - Channel Position B

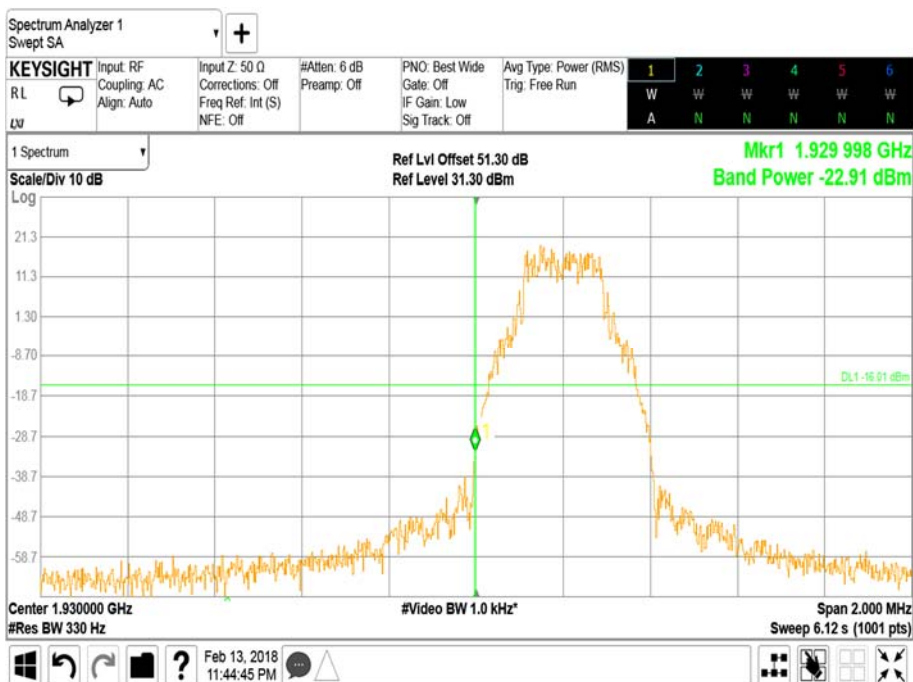



Product Service

Antenna A - NB IoT Modulation QPSK - NB IoT Carrier Bandwidth 0.2 MHz - Channel Position T

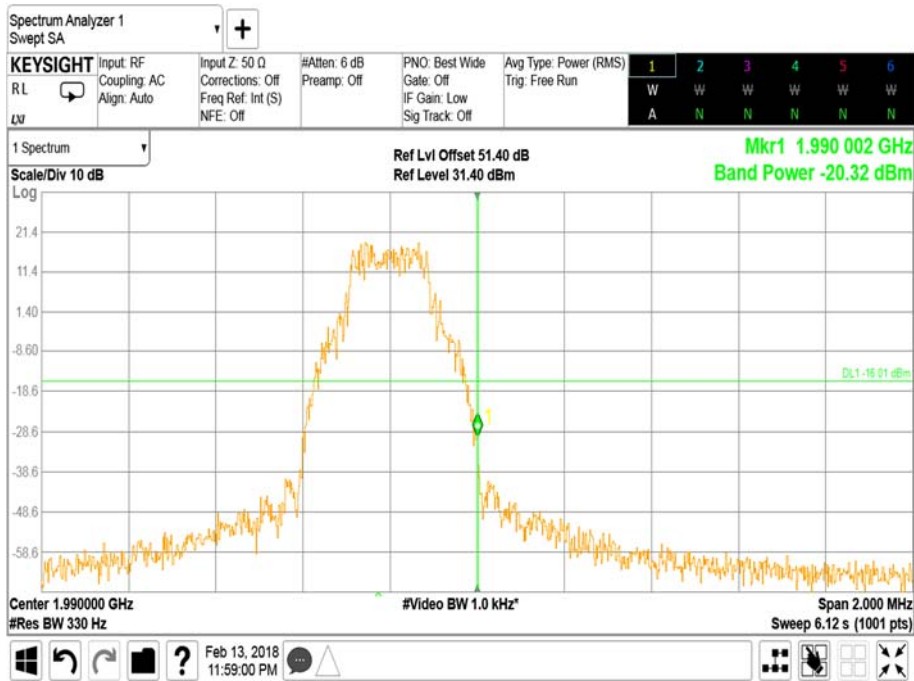

Limit MIMO	-16dBm
------------	--------



Product Service

2.4 TRANSMITTER SPURIOUS EMISSIONS

2.4.1 Specification Reference

FCC CFR 47 Part 2, Clause 2.1051
FCC CFR 47 Part 24, Clause 24.238 (a)
Industry Canada RSS-133, Clause 6.5

2.4.2 Date of Test and Modification State

13 February 2018 - Modification State 0

2.4.3 Test Equipment Used

The major items of test equipment used for the above tests are identified in Section 3.1.

2.4.4 Environmental Conditions

Ambient Temperature	21.8°C
Relative Humidity	31.3%

2.4.5 Test Method

All measurements were made in accordance with FCC KDB 971168 D01.

Each antenna port has been declared as being equivalent, therefore measurements were made on one antenna port only. To account for this, the limit was tightened by $10 * \text{Log}(N)$, where N is equal to the number of MIMO antenna ports.

For single carrier, the limit was calculated as being $-13 \text{ dBm} - 10 * \text{Log}(1) = -13 \text{ dBm}$.

For dual carrier, the limit was calculated as being $-13 \text{ dBm} - 10 * \text{Log}(2) = -16 \text{ dBm}$.

2.4.6 Test Results

Configuration A

Maximum Output Power 47.8/49 dBm



Product Service

Antenna A - LTE Modulation 64QAM - LTE Carrier Bandwidth 10.0 MHz - Channel Position B - Band 1 - Range 0.009 to 3000 MHz



Antenna A - LTE Modulation 64QAM - LTE Carrier Bandwidth 10.0 MHz - Channel Position T - Band 1 - Range 0.009 to 3000 MHz

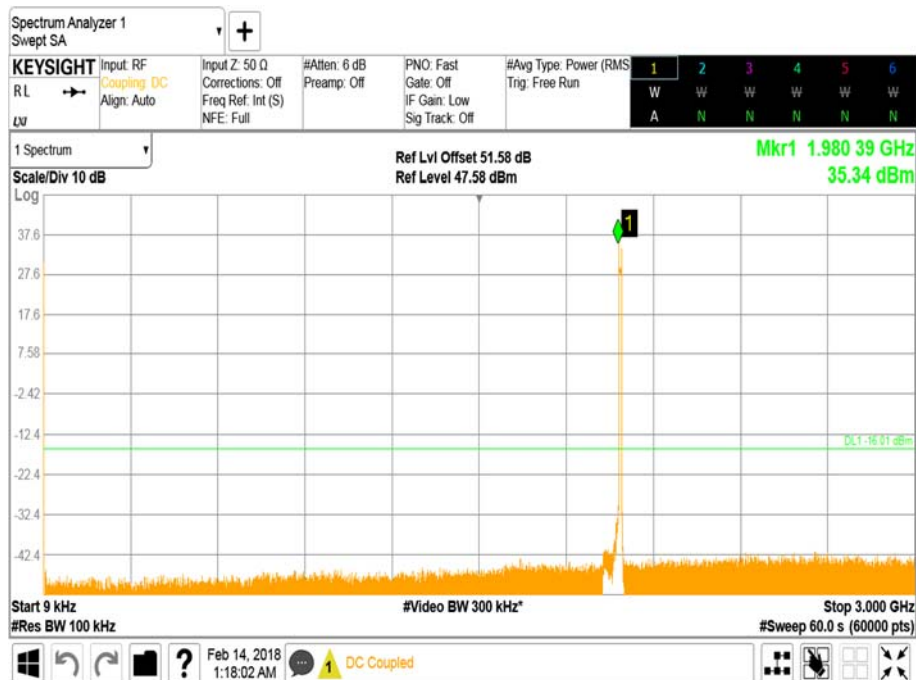



Product Service

Antenna A - LTE Modulation 64QAM - LTE Carrier Bandwidth 15.0 MHz - Channel Position B - Band 1 - Range 0.009 to 3000 MHz

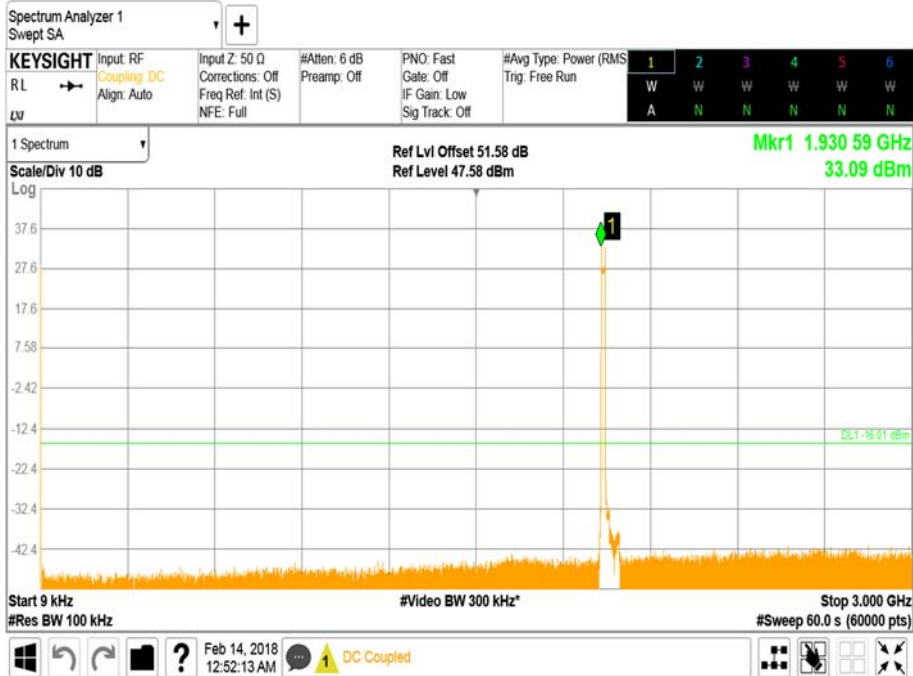

Antenna A - LTE Modulation 64QAM - LTE Carrier Bandwidth 15.0 MHz - Channel Position T - Band 1 - Range 0.009 to 3000 MHz

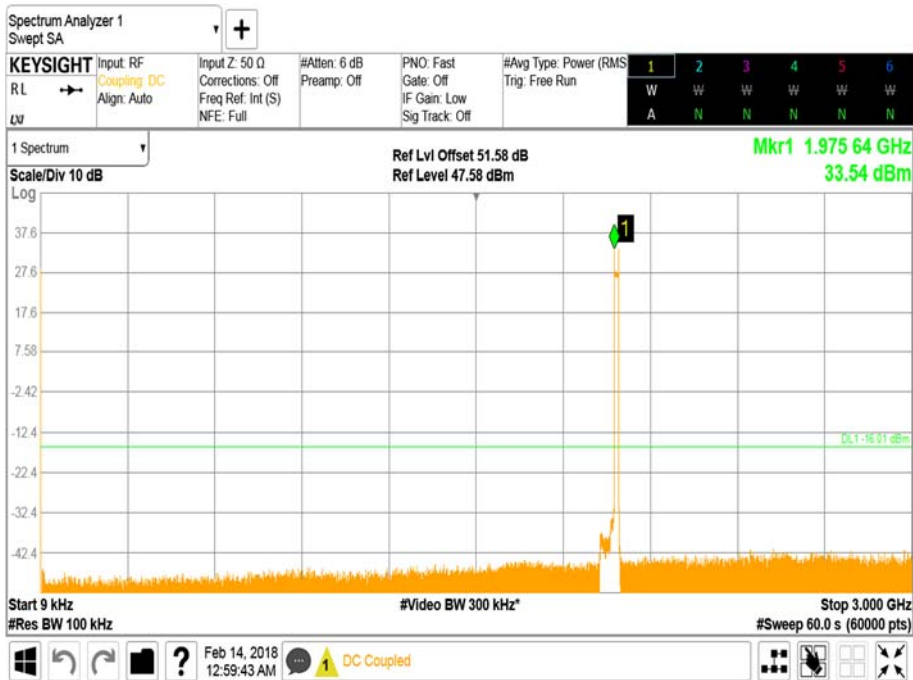



Product Service

Antenna A - LTE Modulation 64QAM - LTE Carrier Bandwidth 20.0 MHz - Channel Position B - Band 1 - Range 0.009 to 3000 MHz

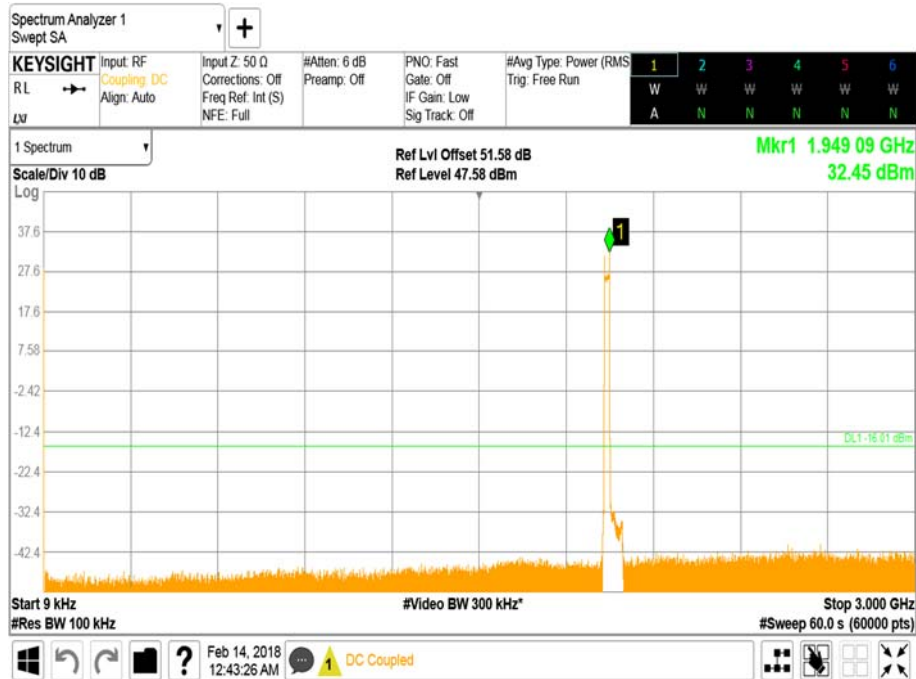

Antenna A - LTE Modulation 64QAM - LTE Carrier Bandwidth 20.0 MHz - Channel Position B - Band 2 - Range 3000 to 10000 MHz

Antenna A - LTE Modulation 64QAM - LTE Carrier Bandwidth 20.0 MHz - Channel Position B - Band 3 - Range 10000 to 20000 MHz

Antenna A - LTE Modulation 64QAM - LTE Carrier Bandwidth 20.0 MHz - Channel Position T - Band 1 - Range 0.009 to 3000 MHz

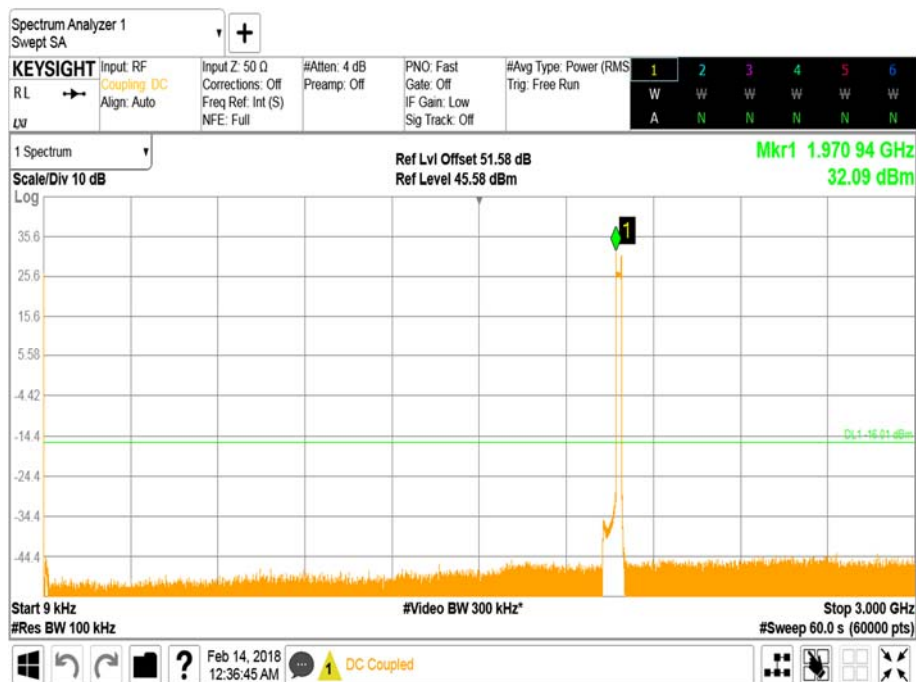



Product Service

Configuration B

Maximum Output Power 47.8/49 dBm

Antenna A - NB IoT Modulation QPSK - NB IoT Carrier Bandwidth 0.2 MHz - Channel Position B - Band 1 - Range 0.009 to 3000 MHz

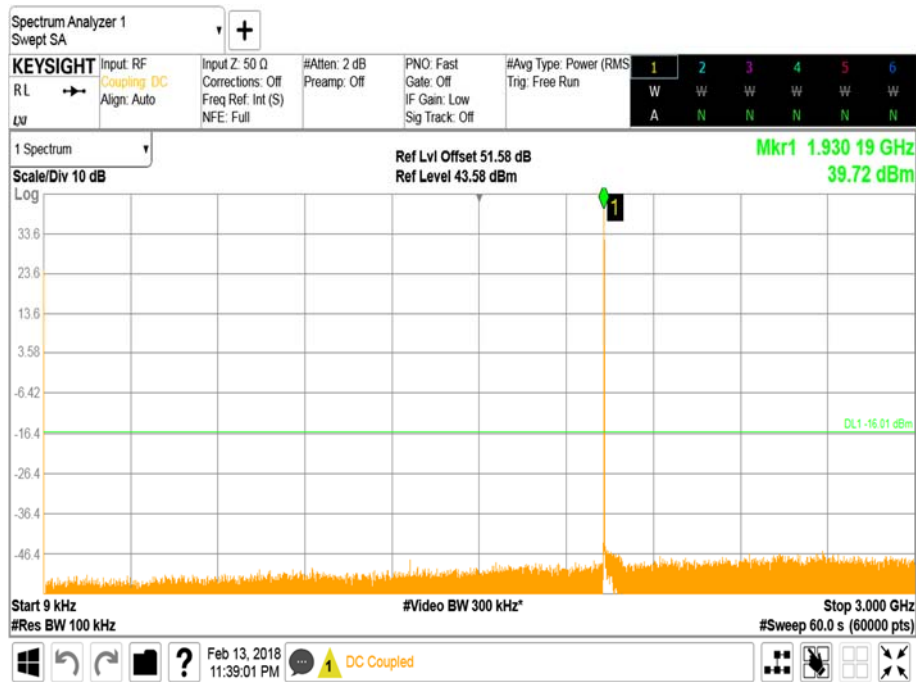

Antenna A - NB IoT Modulation QPSK - NB IoT Carrier Bandwidth 0.2 MHz - Channel Position B - Band 2 - Range 3000 to 1000 MHz

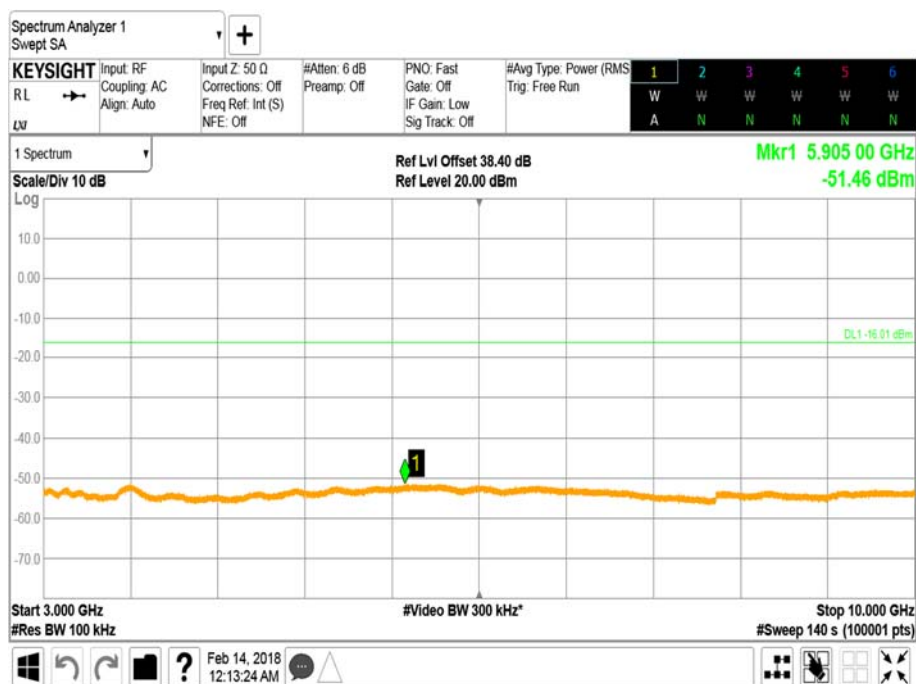



Product Service

Antenna A - NB IoT Modulation QPSK - NB IoT Carrier Bandwidth 0.2 MHz - Channel Position B - Band 3 - Range 10000 to 2000 MHz

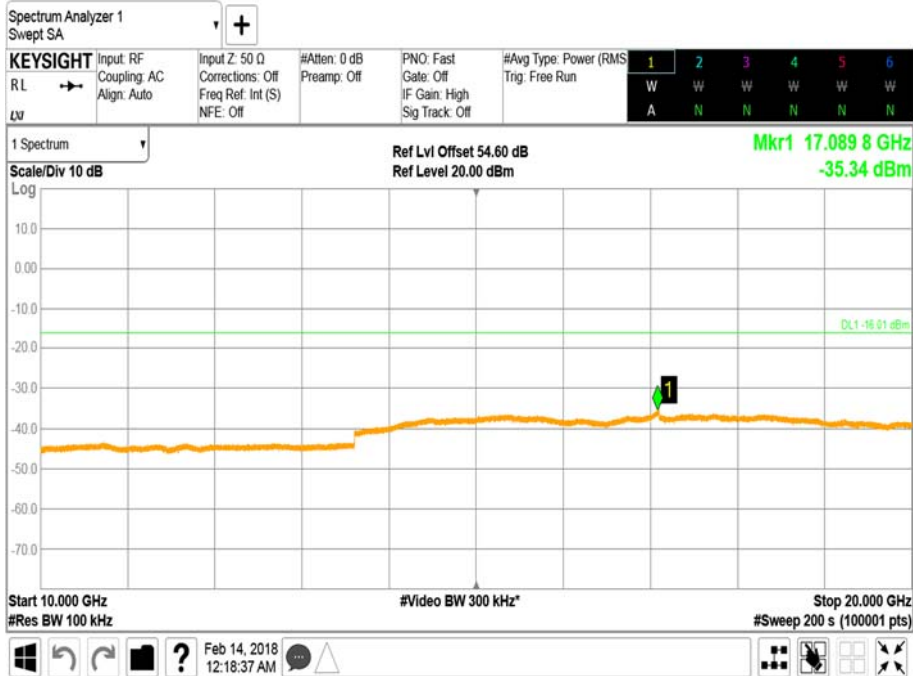

Antenna A - NB IoT Modulation QPSK - NB IoT Carrier Bandwidth 0.2 MHz - Channel Position M - Band 1 - Range 0.009 to 3000 MHz





Product Service

Antenna A - NB IoT Modulation QPSK - NB IoT Carrier Bandwidth 0.2 MHz - Channel Position M - Band 2 - Range 3000 to 1000 MHz

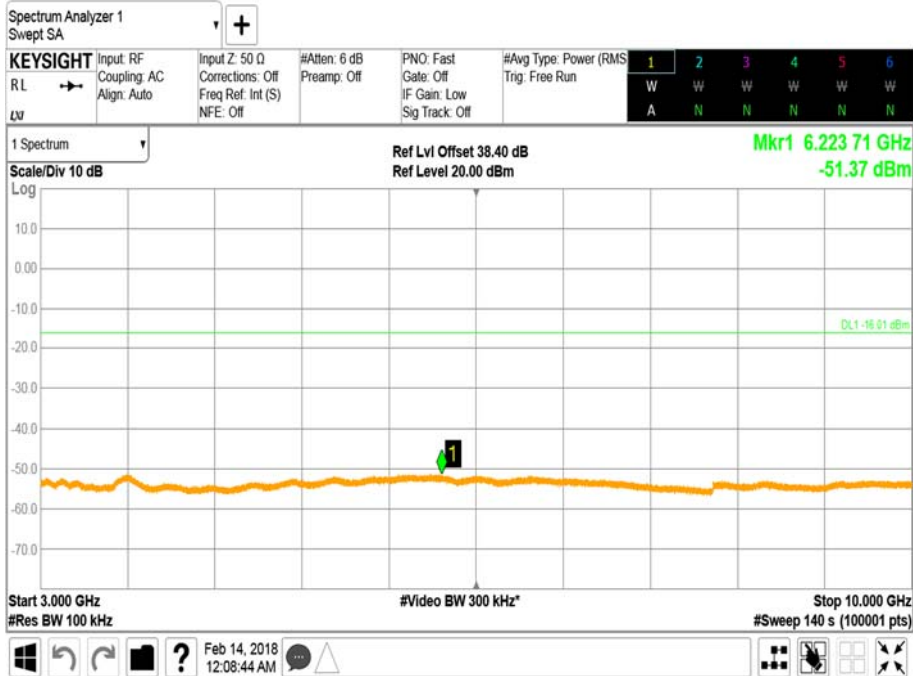

Antenna A - NB IoT Modulation QPSK - NB IoT Carrier Bandwidth 0.2 MHz - Channel Position M - Band 3 - Range 10000 to 20000 MHz

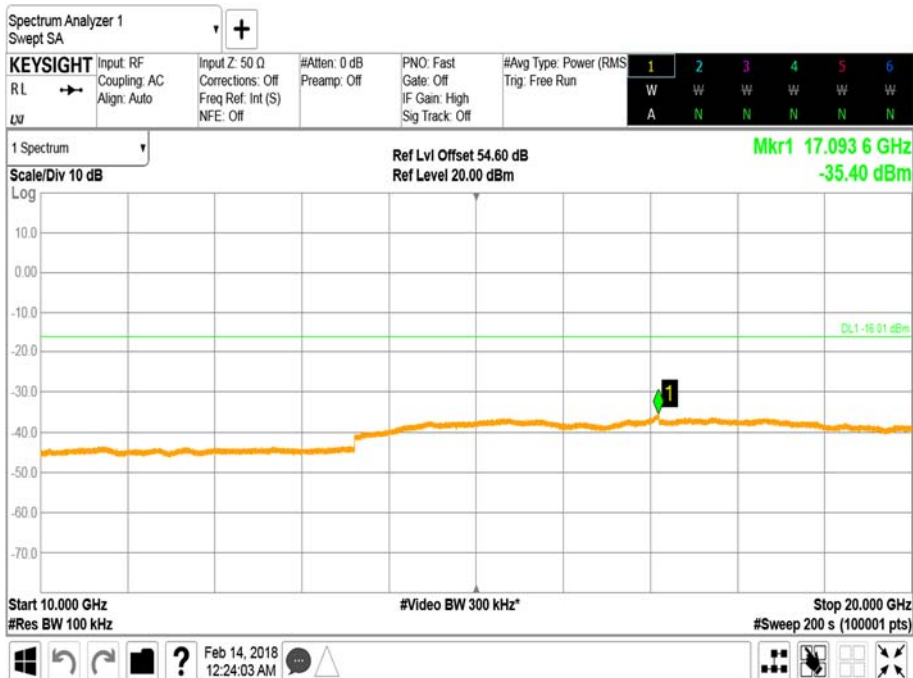



Product Service

Antenna A - NB IoT Modulation QPSK - NB IoT Carrier Bandwidth 0.2 MHz - Channel Position T - Band 1 - Range 0.009 to 3000 MHz



Antenna A - NB IoT Modulation QPSK - NB IoT Carrier Bandwidth 0.2 MHz - Channel Position T - Band 2 - Range 3000 to 1000 MHz

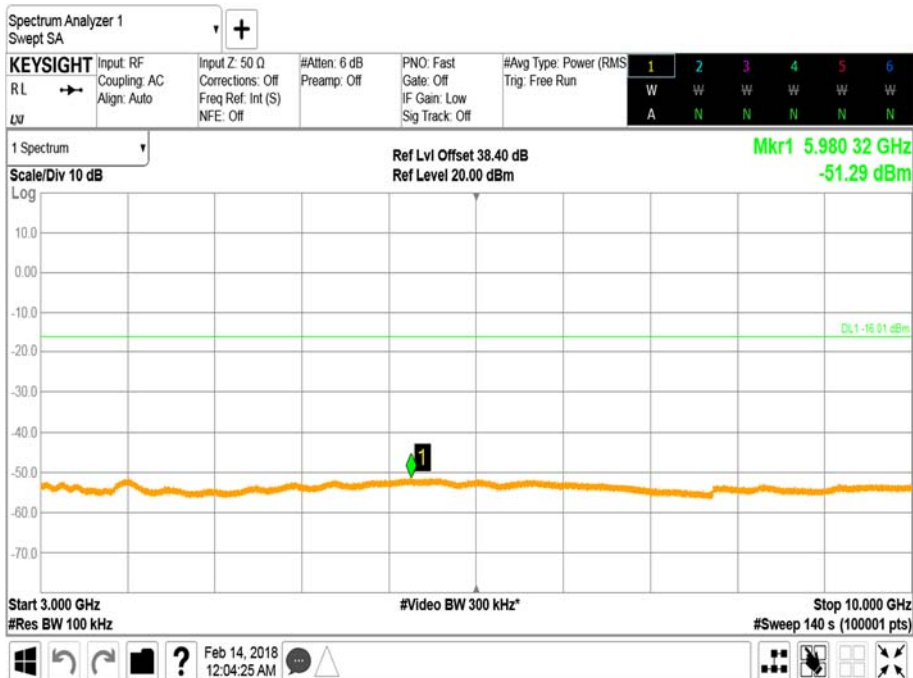



Product Service

Antenna A - NB IoT Modulation QPSK - NB IoT Carrier Bandwidth 0.2 MHz - Channel Position T - Band 3 - Range 10000 to 2000 MHz

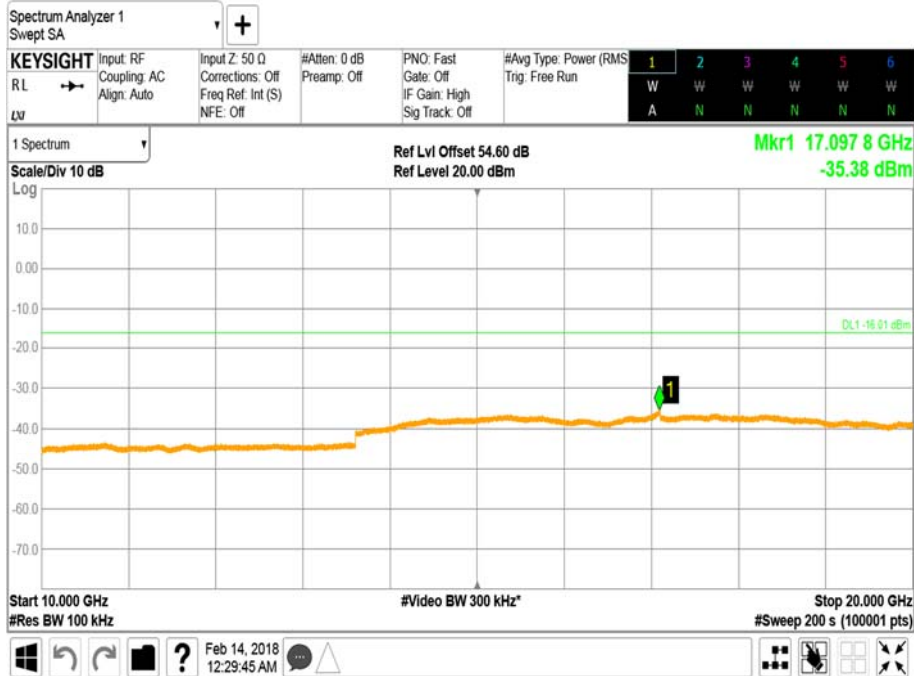

Limit MIMO	-16dBm
------------	--------



Product Service

2.5 RADIATED SPURIOUS EMISSIONS

2.5.1 Specification Reference

FCC CFR 47 Part 2, Clause 2.1053
FCC CFR 47 Part 24, Clause 24.238

2.5.2 Date of Test and Modification State

06 February 2018 - Modification State 0

2.5.3 Test Equipment Used

The major items of test equipment used for the above tests are identified in Section 3.1.

2.5.4 Environmental Conditions

Ambient Temperature 21.8°C
Relative Humidity 31.3%

2.5.5 Test Method

The test was applied in accordance with test method requirements of ANSI/TIA-603-C-2004.

A preliminary profile of the Spurious Radiated Emissions was obtained by operating the EUT on a remotely controlled turntable within the chamber. Measurements of emissions from the EUT were obtained with the Measurement Antenna in both Horizontal and Vertical Polarisations.

The Applicant declared that the highest internally generated frequency would be up to 2000MHz and so the upper limit for measurement was calculated at 10 times this, which is 20GHz.

Emissions identified within the range 30MHz – 20GHz were then formally measured using a Peak detector as the worst case.

In the frequency Range 30MHz – 1GHz, the measurement was performed with a resolution bandwidth of 100kHz.

In the frequency Range 1GHz – 20GHz, the measurement was performed with a resolution bandwidth of 1MHz.

The measurements were performed at a 3m distance unless otherwise stated.

The limits for Spurious Emissions have been calculated, as shown below using the following formula:

Field Strength of Carrier - $(43 + 10\text{Log}(P))$ dB

Where:

Field Strength is measured in dB μ V/m

P is measured Transmitter Power in Watts



Product Service

Determination of Spurious Emission Limit

As the EUT does not have an integral antenna, the field strength of the carrier has been calculated assuming that the power is to be fed to a half-wave tuned dipole as per 2.1053 (a).

$$E_{(v/m)} = (30 \times G_i \times P_o)^{0.5} / d$$

Where G_i is the antenna gain of an ideal half-wave dipole,
 P_o is the power out of the transceiver in W,
 d is the measurement distance in meter.

Therefore at 3m measurement distance the field strength using the lowest transceiver output power would be:

$$E_{(v/m)} = (30 \times 1.64 \times 60)^{0.5} / 3 = 9.84V/m = 139.86dB\mu V/m$$

As per 27.53 (c)(1)) the spurious emission must be attenuated by $43 + 10\log(P_o)$ dB this gives:

$$43 + 10\log(60) = 60.78dB$$

Therefore the limit at 3m measurement distance is:

$$139.86 - 60.78 = 79.08 \text{ dB}\mu V/m$$

This limit has been used to determine Pass or Fail for the harmonics measured and detailed in the following results.

2.5.6 Test Results

Configuration A

Maximum Output Power 47.8/49 dBm, LTE + NB-IoT Bandwidth 10.0MHz



Product Service

Channel Position B – 64QAM / Bandwidth 10.0MHz – 30MHz – 1GHz

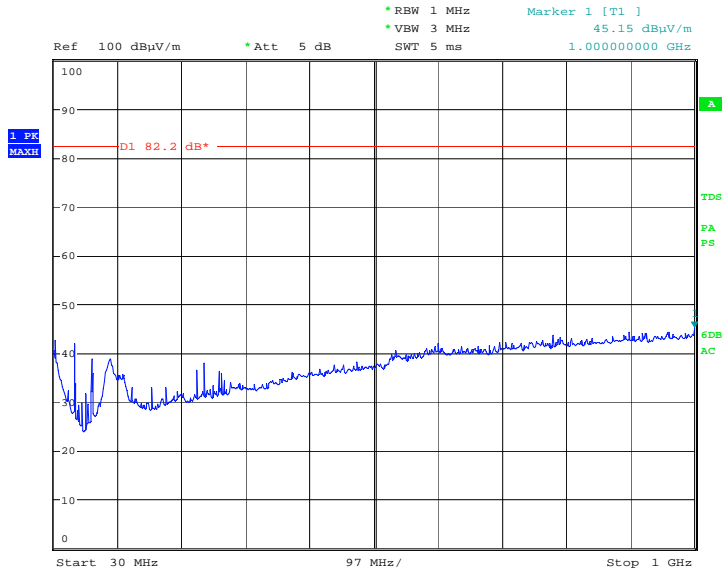

Date: 6.FEB.2018 22:42:28

Channel Position T – 64QAM / Bandwidth 10.0MHz – 30MHz – 1GHz

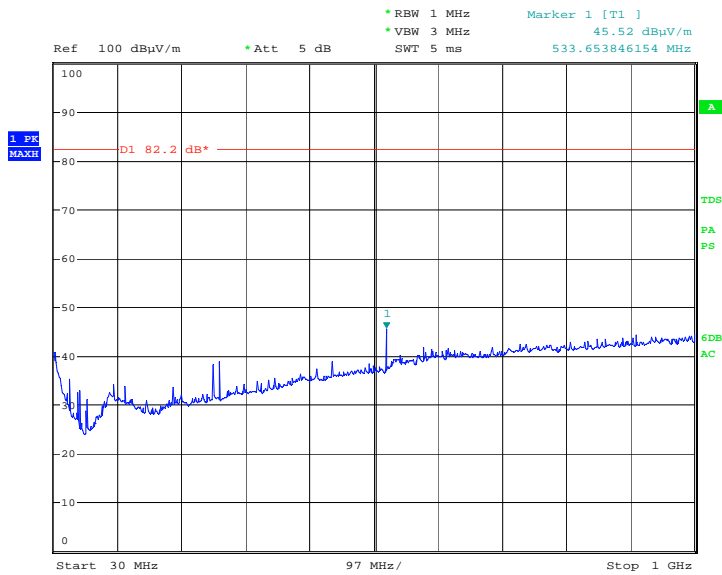

Date: 6.FEB.2018 22:45:21



Product Service

Channel Position B – 64QAM / Bandwidth 15.0MHz – 30MHz – 1GHz

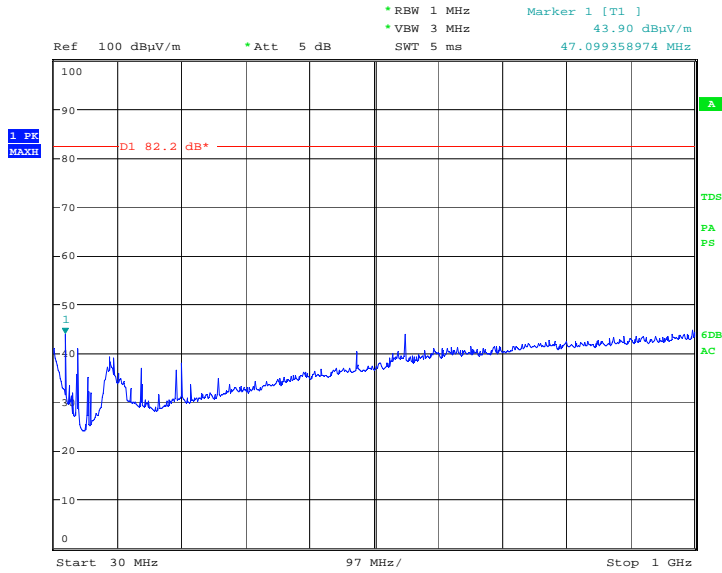

Date: 6.FEB.2018 22:35:00

Channel Position T – 64QAM / Bandwidth 15.0MHz – 30MHz – 1GHz

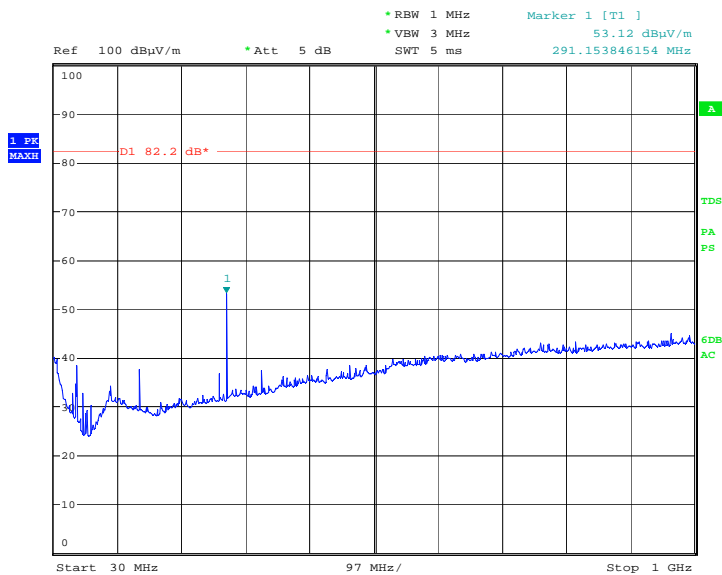

Date: 6.FEB.2018 22:29:47



Product Service

Channel Position B – 64QAM / Bandwidth 20.0MHz – 30MHz – 1GHz

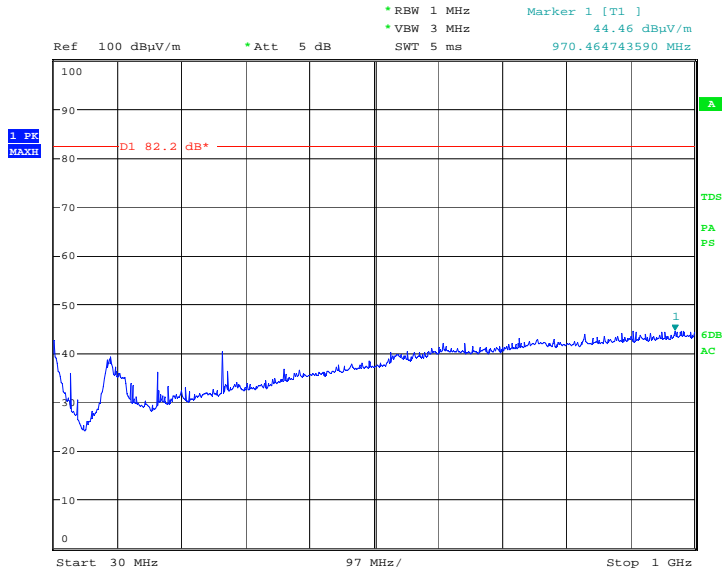

Date: 6.FEB.2018 22:23:52

Channel Position T – 64QAM / Bandwidth 20.0MHz – 30MHz – 1GHz

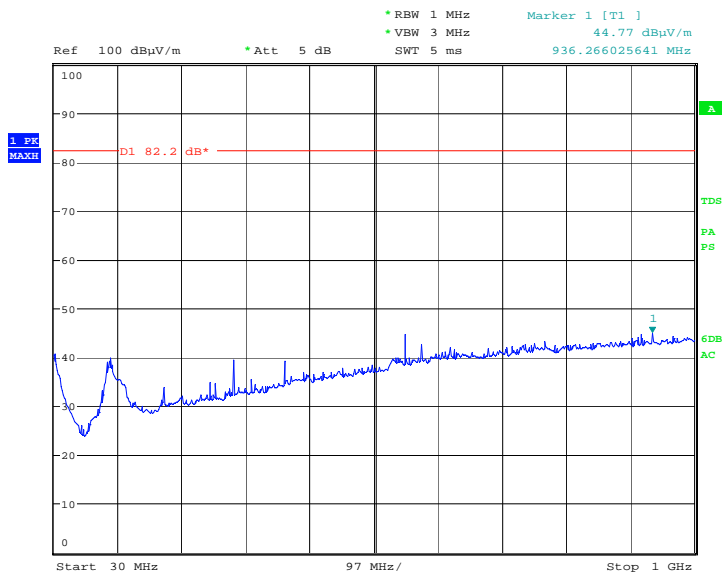

Date: 6.FEB.2018 22:19:15



Product Service

Channel Position B – 64QAM / Bandwidth 10.0MHz – 1GHz -8GHz

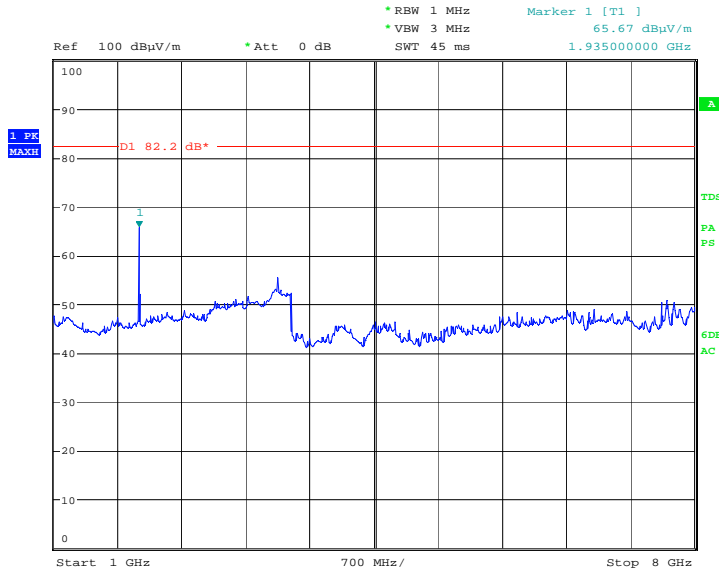

Date: 6.FEB.2018 20:51:57

Channel Position T – 64QAM / Bandwidth 10.0MHz – 1GHz -8GHz

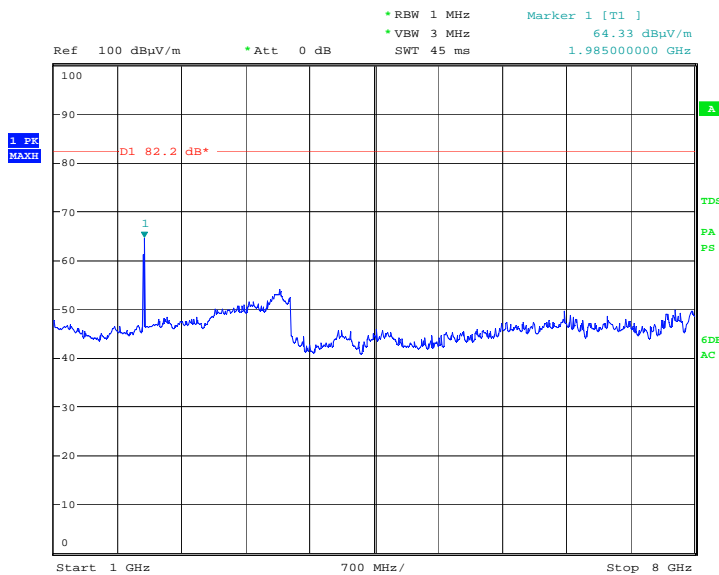

Date: 6.FEB.2018 20:55:25



Product Service

Channel Position B – 64QAM / Bandwidth 15.0MHz – 1GHz -8GHz

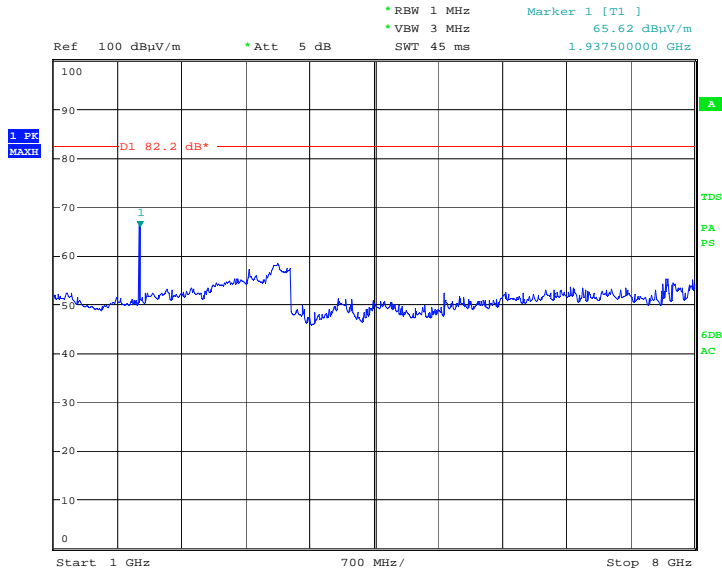

Date: 6.FEB.2018 21:04:57

Channel Position T – 64QAM / Bandwidth 15.0MHz – 1GHz -8GHz

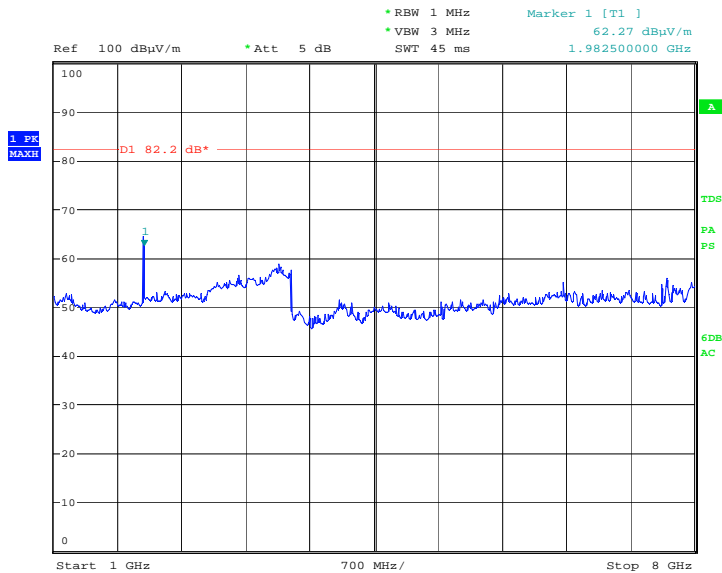

Date: 6.FEB.2018 21:09:46



Product Service

Channel Position B – 64QAM / Bandwidth 20.0MHz – 1GHz -8GHz

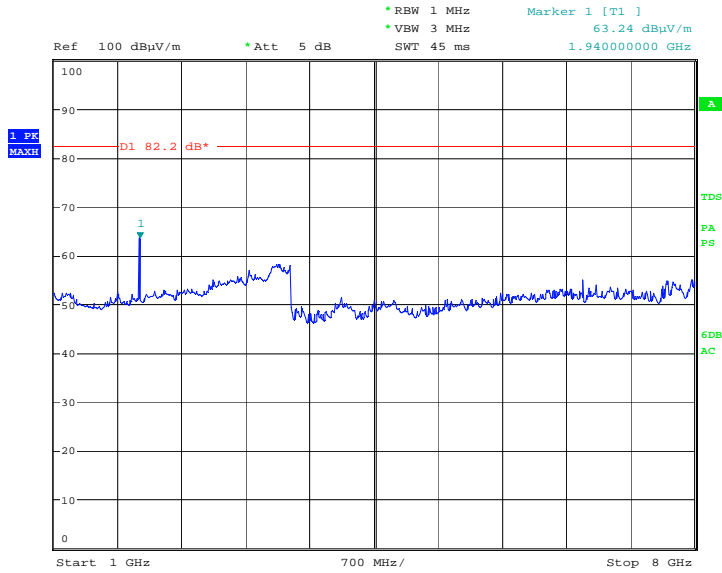

Date: 6.FEB.2018 21:20:17

Channel Position T – 64QAM / Bandwidth 20.0MHz – 1GHz -8GHz

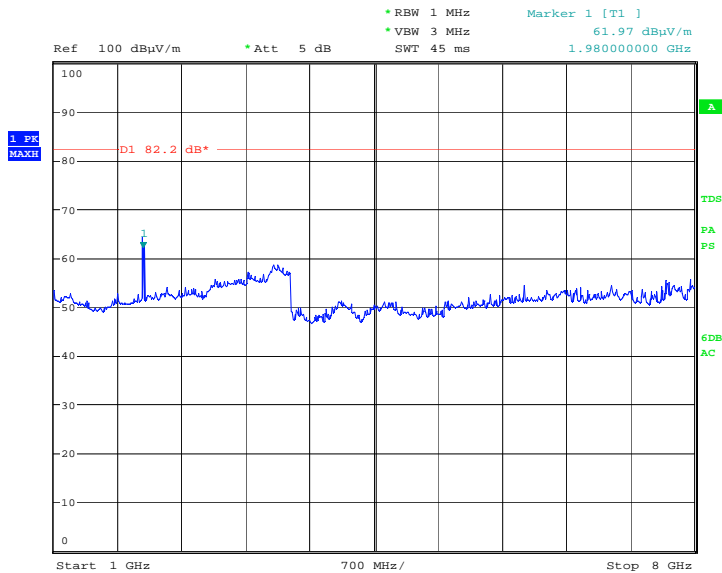

Date: 6.FEB.2018 21:23:39



Product Service

Channel Position B – 64QAM / Bandwidth 10.0MHz – 8GHz - 18GHz

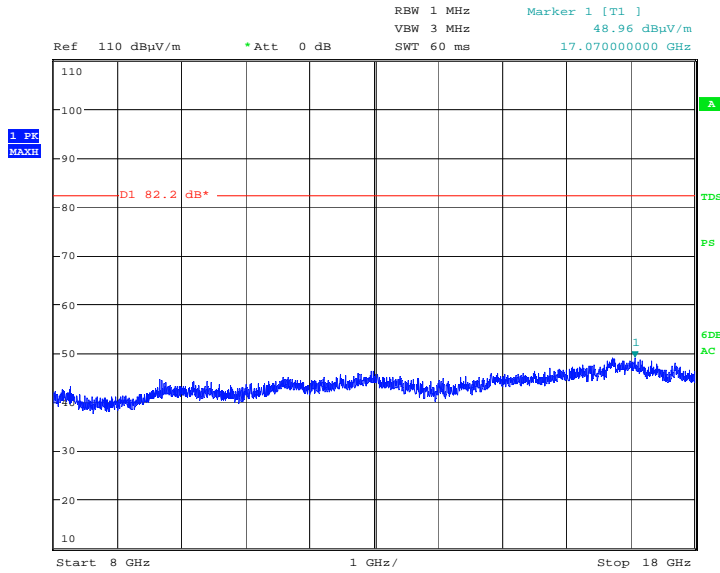

Date: 6.FEB.2018 20:14:09

Channel Position T – 64QAM / Bandwidth 10.0MHz – 8GHz - 18GHz

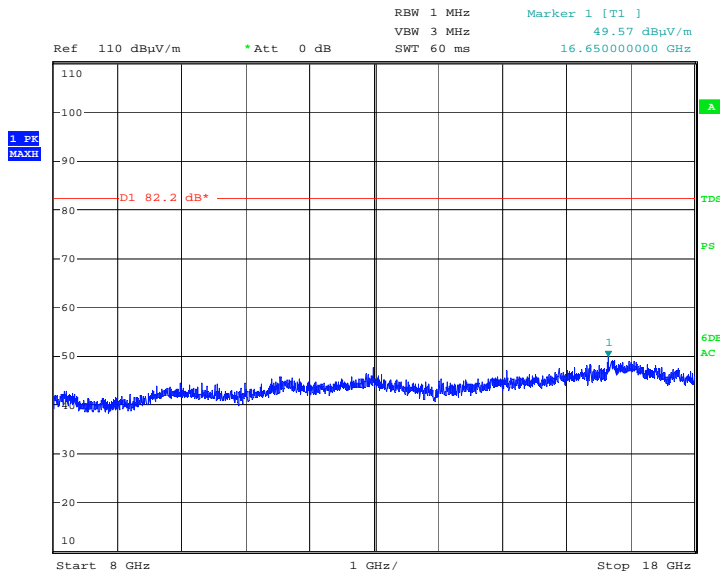

Date: 6.FEB.2018 20:07:25



Product Service

Channel Position B – 64QAM / Bandwidth 15.0MHz – 8GHz - 18GHz

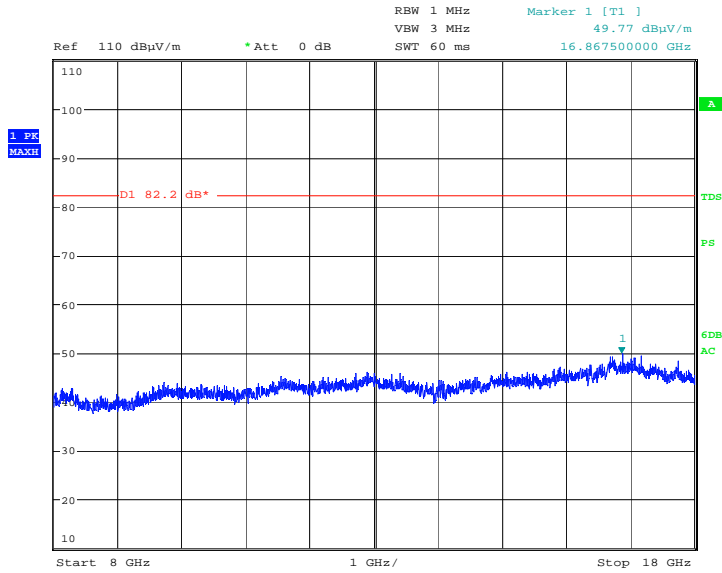

Date: 6.FEB.2018 19:59:53

Channel Position T – 64QAM / Bandwidth 15.0MHz – 8GHz - 18GHz

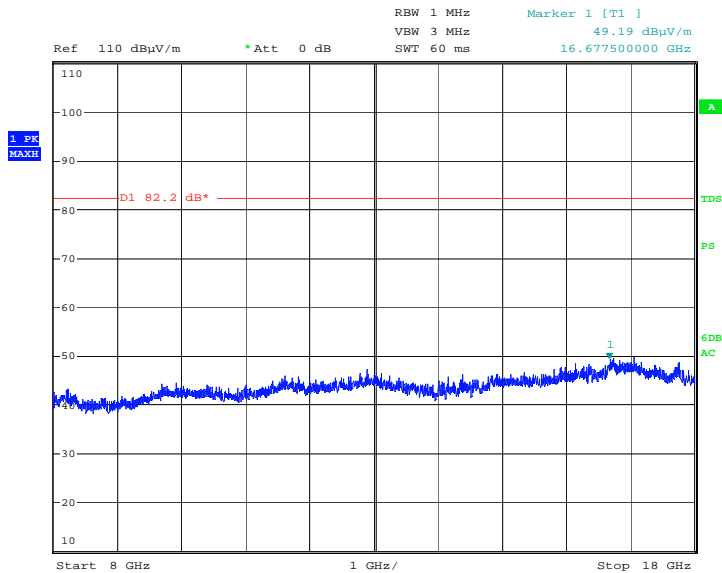

Date: 6.FEB.2018 19:54:44



Product Service

Channel Position B – 64QAM / Bandwidth 20.0MHz – 8GHz - 18GHz

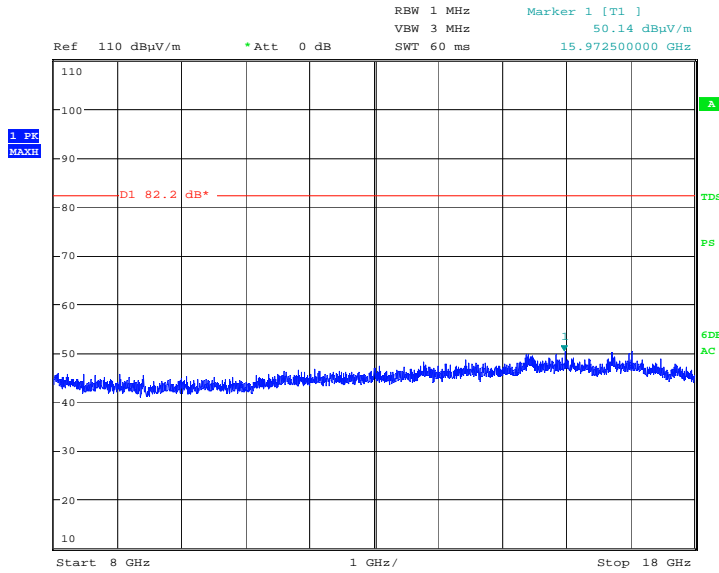

Date: 6.FEB.2018 19:48:33

Channel Position T – 64QAM / Bandwidth 20.0MHz – 8GHz - 18GHz

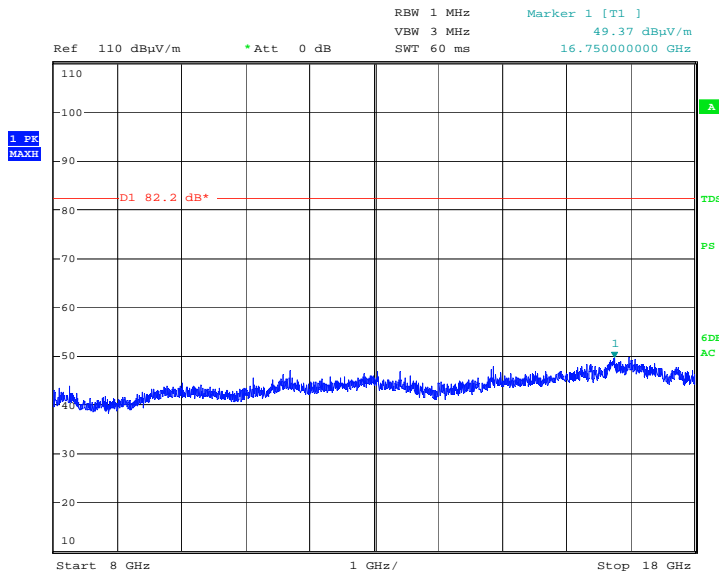

Date: 6.FEB.2018 19:42:45



Product Service

Channel Position B – 64QAM / Bandwidth 10.0MHz – 18GHz - 20GHz

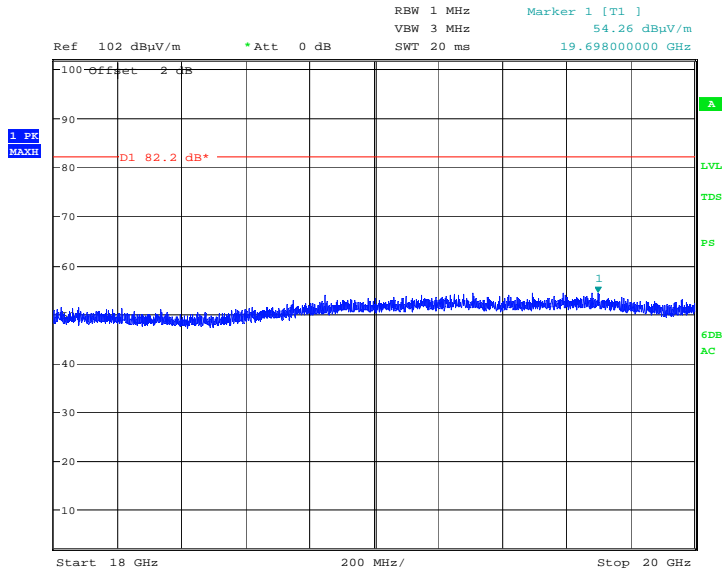

Date: 6.FEB.2018 18:14:07

Channel Position T – 64QAM / Bandwidth 10.0MHz – 18GHz - 20GHz

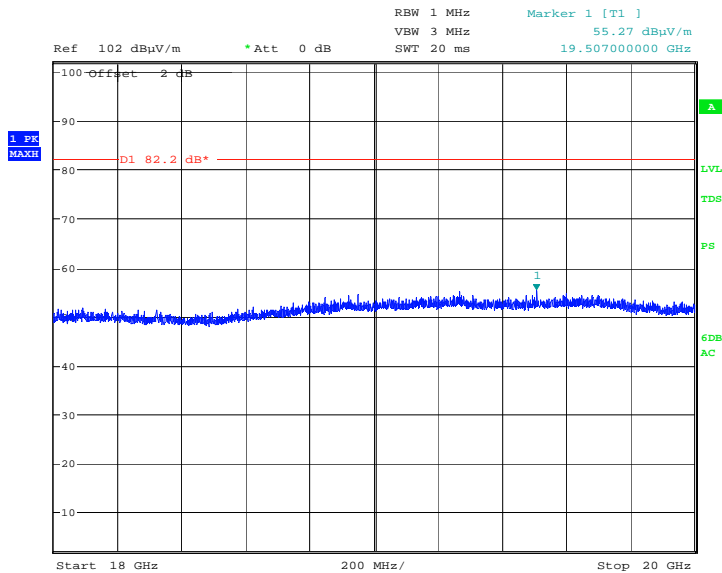

Date: 6.FEB.2018 18:19:37



Product Service

Channel Position B – 64QAM / Bandwidth 15.0MHz – 18GHz - 20GHz

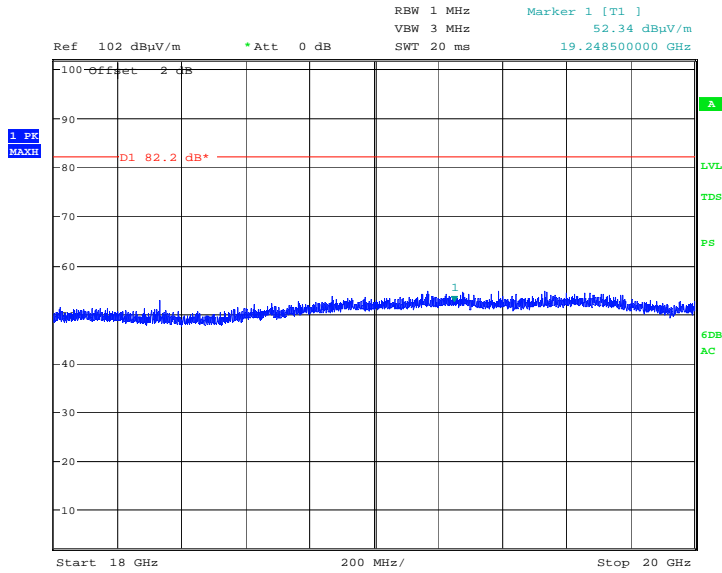

Date: 6.FEB.2018 18:25:57

Channel Position T – 64QAM / Bandwidth 15.0MHz – 18GHz - 20GHz

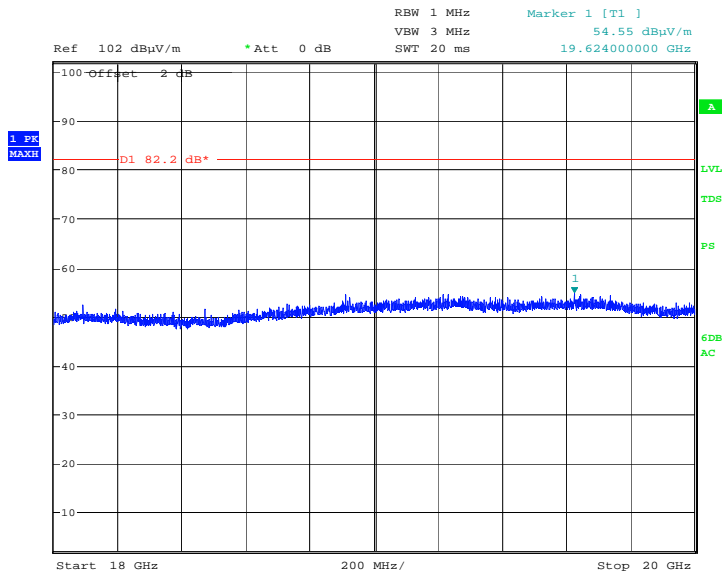

Date: 6.FEB.2018 18:34:53



Product Service

Channel Position B – 64QAM / Bandwidth 20.0MHz – 18GHz - 20GHz

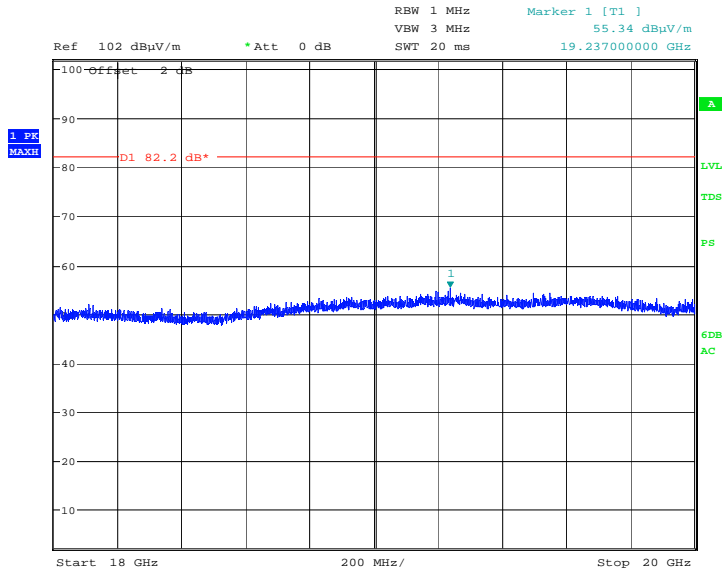

Date: 6.FEB.2018 18:39:31

Channel Position T – 64QAM / Bandwidth 20.0MHz – 18GHz - 20GHz

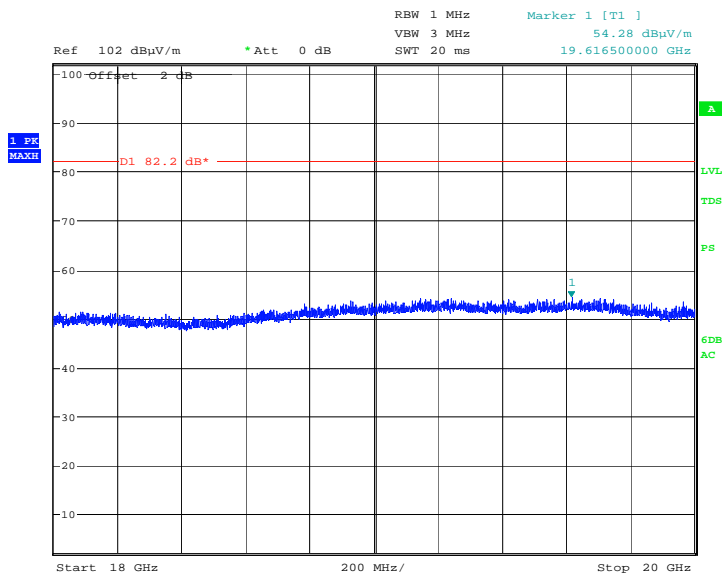

Date: 6.FEB.2018 18:48:48



Product Service

Configuration B

Maximum Output Power 47.8/49 dBm NB-IoT SA Bandwidth 0.20MHz

Channel Position B – QPSK / Bandwidth 0.2MHz – 30MHz – 1GHz

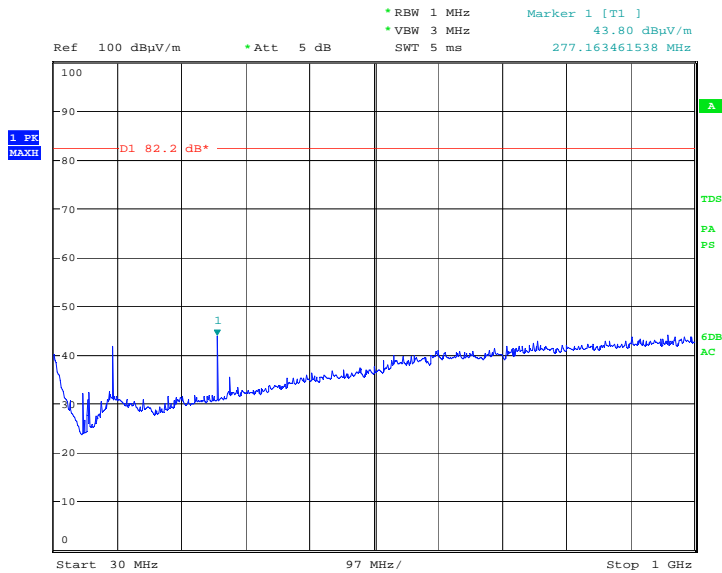

Date: 6.FEB.2018 22:14:51

Channel Position M – QPSK / Bandwidth 0.2MHz – 30MHz – 1GHz

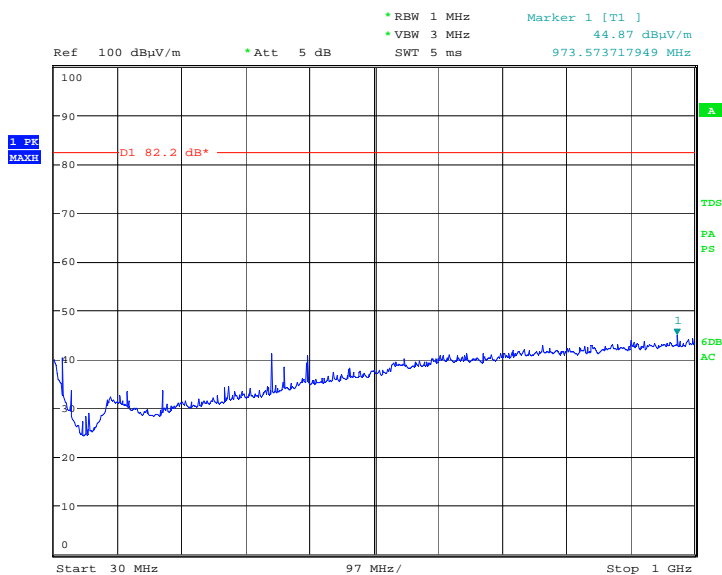

Date: 6.FEB.2018 22:12:45



Product Service

Channel Position T – QPSK / Bandwidth 0.2MHz – 30MHz – 1GHz

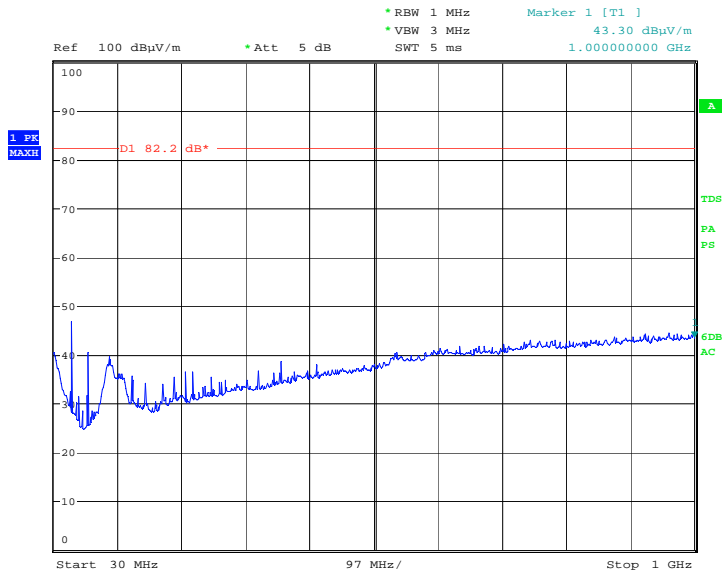

Date: 6.FEB.2018 22:10:23

Channel Position B – QPSK / Bandwidth 0.2MHz – 1GHz -8GHz

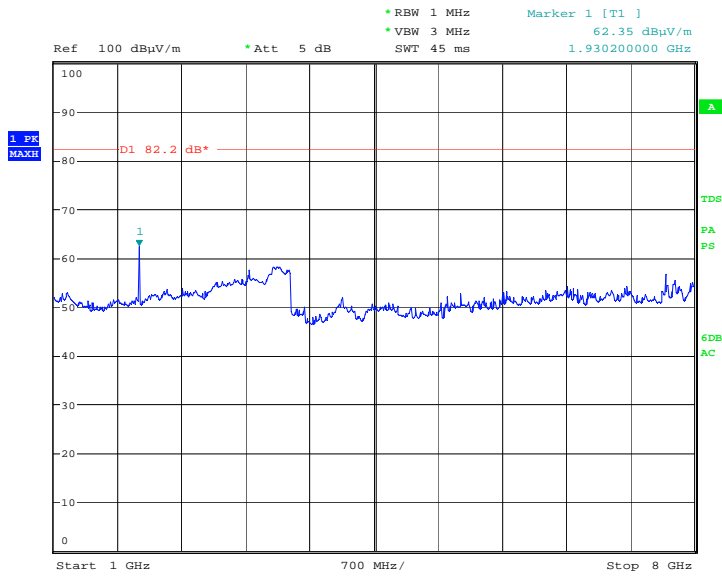

Date: 6.FEB.2018 21:31:01



Product Service

Channel Position M – QPSK / Bandwidth 0.2MHz – 1GHz -8GHz

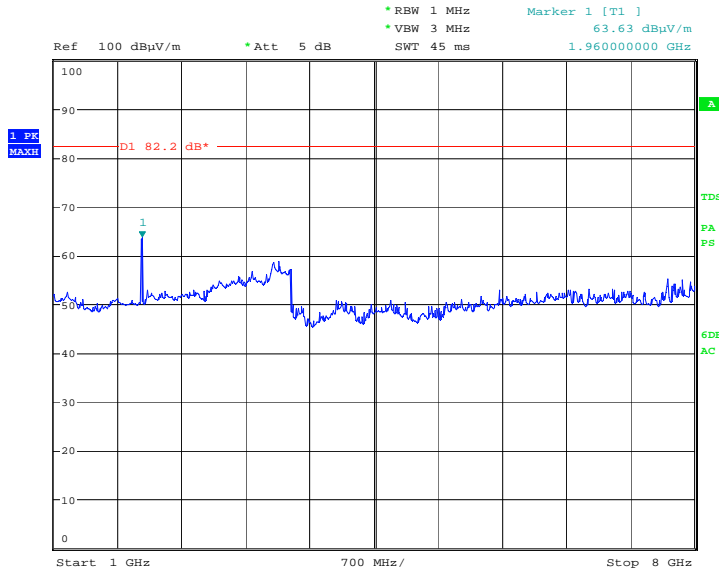

Date: 6.FEB.2018 21:34:04

Channel Position T – QPSK / Bandwidth 0.2MHz – 1GHz -8GHz

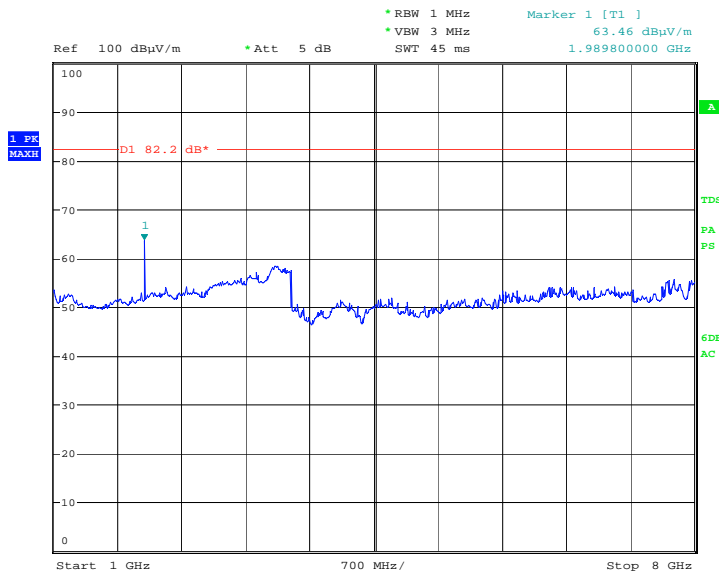

Date: 6.FEB.2018 21:37:18



Product Service

Channel Position B – QPSK / Bandwidth 0.2MHz – 8GHz - 18GHz

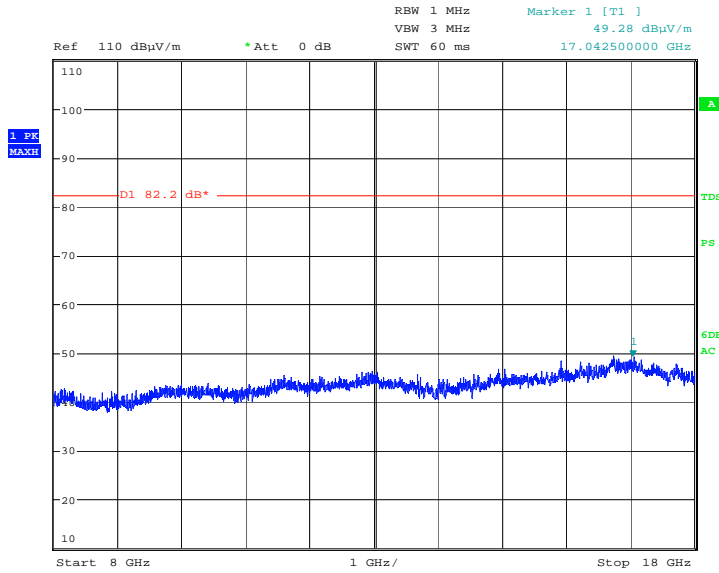

Date: 6.FEB.2018 19:34:28

Channel Position M – QPSK / Bandwidth 0.2MHz – 8GHz - 18GHz

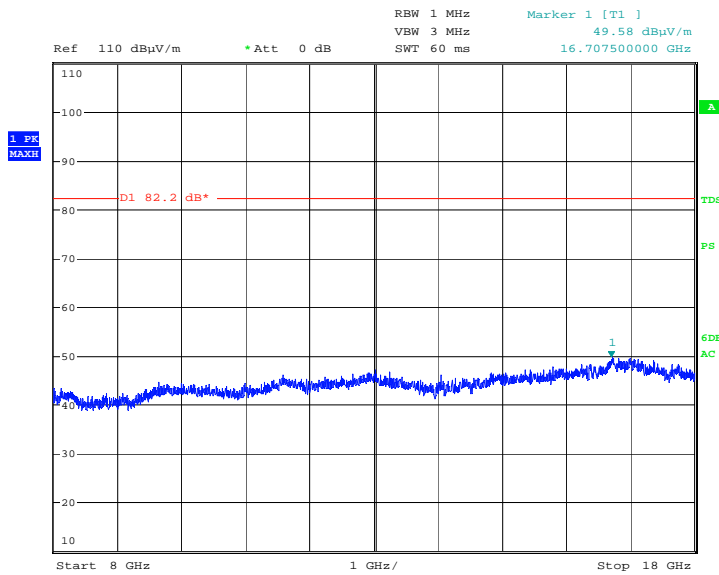

Date: 6.FEB.2018 19:29:34



Product Service

Channel Position T – QPSK / Bandwidth 0.2MHz – 8GHz - 18GHz

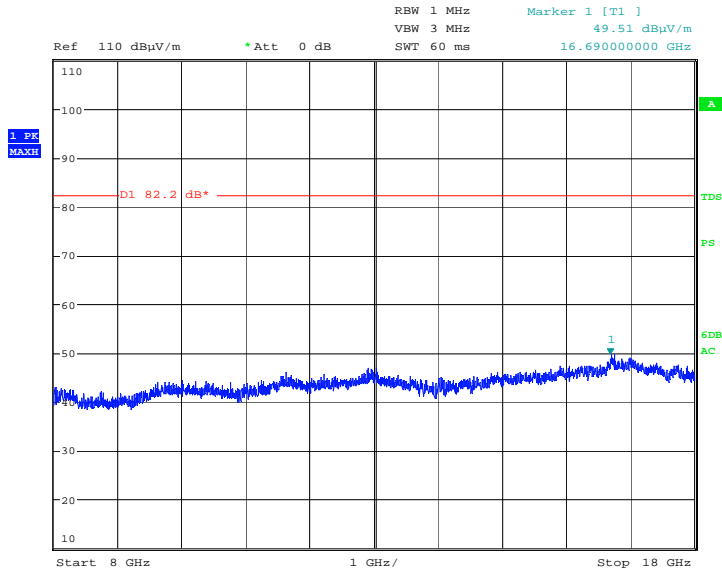

Date: 6.FEB.2018 19:18:27

Channel Position B – QPSK / Bandwidth 0.2MHz – 18GHz - 20GHz

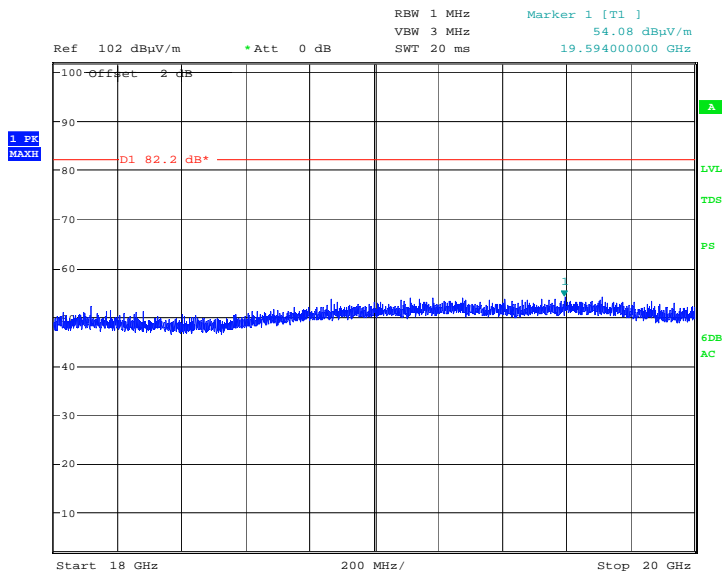

Date: 6.FEB.2018 18:04:00



Product Service

Channel Position M – QPSK / Bandwidth 0.2MHz – 18GHz - 20GHz

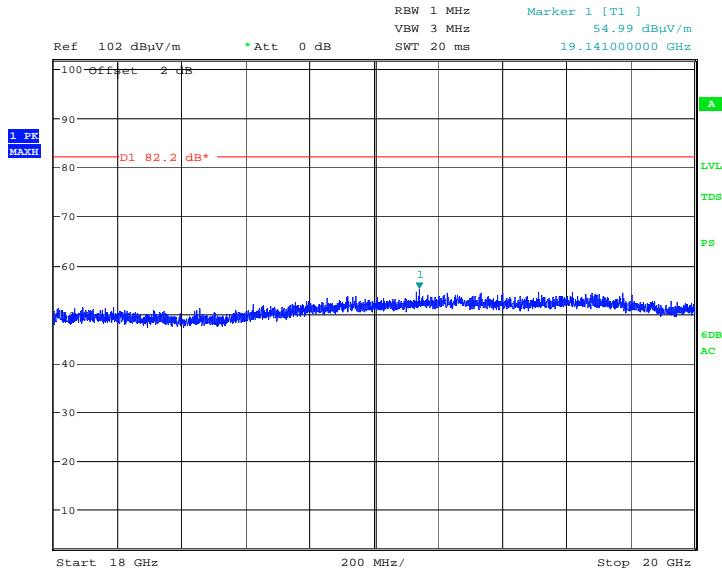

Date: 6.FEB.2018 18:06:21

Channel Position T – QPSK / Bandwidth 0.2MHz – 18GHz - 20GHz

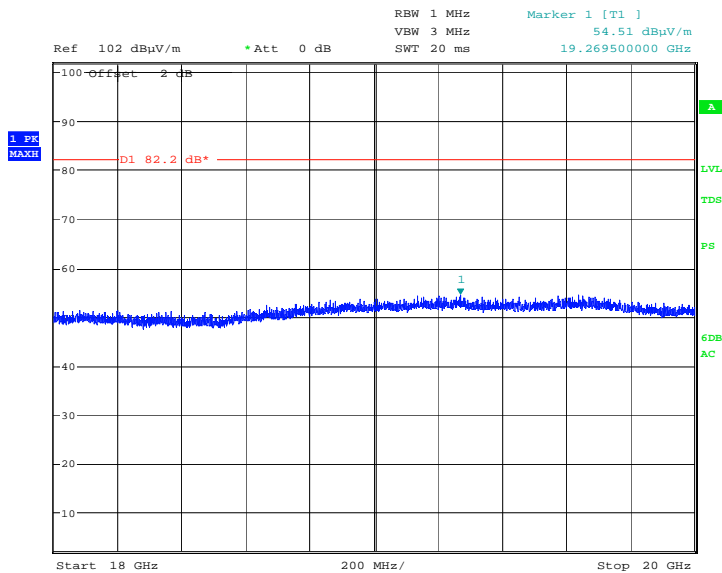

Date: 6.FEB.2018 18:10:04

Remarks

Limit	-13dBm / 82.2 dBµV/m
-------	----------------------

The EUT does not exceed -13dBm / 82.2dBµV/m at the measured frequencies.



Product Service

SECTION 3

TEST EQUIPMENT USED



3.1 TEST EQUIPMENT USED

List of absolute measuring and other principal items of test equipment.

Instrument	Manufacturer	Type No.	TE No.	Calibration Period (months)	Calibration Due
Maximum Peak Output Power and Peak to Average Ratio - Conducted					
Spectrum Analyser	Keysight	PXA	MY49430624	12	30-Jun-2018
Spectrum Analyser	Keysight	PXA	MY49430624	12	30-Jun-2018
Network Analyser	Rhode&Shwarz	ZVA40	TE3548	12	02-Oct-2018
Calibration unit	Rhode&Shwarz	ZV-Z54	TE4368	12	19-Sep-2018
Power Meter	Rhode&Shwarz	NRP2	BAMS100151736	12	18-May-2018
Attenuator	Narda	769-10	TE33368	12	31-May-2018
Attenuator	Narda	769-20	TE3367	12	31-May-2018
Attenuator	Narda	769-30	TE3369	12	31-May-2018
RF Load	Weinschel	WA1425/12-DC	N/A	N/A	OP MON
Attenuator	Weinschel	56-3	T4390	N/A	OP MON
Power Supply	Agilent	N8738A	BAMS1001518021	N/A	OP MON
Hygromer	RS	TE3220	0427452	12	30-Aug-2018
Digital Volt Meter	White gold	WG022	TE00190	12	24-Nov-2018
Band Edge					
Spectrum Analyser	Keysight	PXA	MY49430624	12	30-Jun-2018
Spectrum Analyser	Keysight	PXA	MY49430624	12	30-Jun-2018
Network Analyser	Agilent	N5230A	MY45000737	12	16-May-2018
Power Meter	Rohde&Schwarz	NRP2	BAMS100151736	12	18-May-2018
Attenuator	Weinschel	68-34-20-11	QM935	N/A	OP MON
Attenuator	Weinschel	68-34-20-11	QC181	N/A	OP MON
Attenuator	Weinschel	WA49-40-33	A1067	N/A	OP MON
RF Load	Weinschel	WA1425/12-DC	N/A	N/A	OP MON
Attenuator	Weinschel	56-3	T4390	N/A	OP MON
Attenuator	Weinschel	56-10	T3515	N/A	OP MON
High Pass Filter	Wainwright	WHNX3.8/26.5G-6SS	8	N/A	OP MON
Power Supply	Agilent	N8738A	BAMS1001518021	N/A	OP MON
Hygromer	RS	TE4410	0421742	12	04-May-2018
Digital Volt Meter	Fluke	79 III	TE0411	12	02-Oct-2018
Transmitter Spurious Emissions					
Spectrum Analyser	Keysight	PXA	MY49430624	12	30-Jun-2018
Spectrum Analyser	Keysight	PXA	MY49430624	12	30-Jun-2018
Network Analyser	Agilent	N5230A	MY49430624	12	16-May-2018
Power Meter	Rohde&Schwarz	NRP2	BAMS100151736	12	18-May-2018
Attenuator	Weinschel	68-34-20-11	QM935	N/A	OP MON
Attenuator	Weinschel	68-34-20-11	QC181	N/A	OP MON
Attenuator	Weinschel	WA49-40-33	A1067	N/A	OP MON
RF Load	Weinschel	WA1425/12-DC	N/A	N/A	OP MON
Attenuator	Weinschel	56-3	T4390	N/A	OP MON
Attenuator	Weinschel	56-10	T3515	N/A	OP MON
High Pass Filter	Wainwright	WHNX3.8/26.5G-6SS	8	N/A	OP MON
Power Supply	Agilent	N8738A	BAMS1001518021	N/A	OP MON
Hygromer	RS	TE4410	0421742	12	04-May-2018
Digital Volt Meter	Fluke	79 III	TE0411	12	02-Oct-2018



Product Service

Instrument	Manufacturer	Type No.	TE No.	Calibration Period (months)	Calibration Due
Radiated Emissions					
Antenna (Bilog)	Schaffner	CBL6143	287	24	18-Apr-2018
Filter (High Pass)	Lorch	SHP7-7000-SR	566	12	05-Apr-2018
Signal Generator (10MHz to 40GHz)	Rohde & Schwarz	SMR40	1002	12	20-Oct-2018
Power Supply Unit	Farnell	H 60/50	1095	0	TU
Antenna 18-40GHz (Double Ridge Guide)	Q-Par Angus Ltd	QSH 180K	1511	24	07-Dec-2018
Pre-Amplifier	Phase One	PS04-0086	1533	12	12-Jan-2019
18GHz - 40GHz Pre-Amplifier	Phase One	PS04-0087	1534	12	27-Feb-2018
Screened Room (5)	Rainford	Rainford	1545	36	O/P Mon
Turntable Controller	Inn-Co GmbH	CO 1000	1606	0	TU
Multimeter	Iso-tech	IDM 101	2118	12	07-Feb-2018
Cable (N-N, 8m)	Rhophase	NPS-2302-8000-NPS	3248	12	02-May-2018
EMI Test Receiver	Rohde & Schwarz	ESU40	3506	12	22-Nov-2018
Tilt Antenna Mast	matur GmbH	TAM 4.0-P	3916	0	TU
Mast Controller	matur GmbH	NCD	3917	0	TU
1 Metre SMA Cable	Rhophase	3PS-1801A-1000-3PS	4099	12	19-Sep-2018
Cable 1503 2M 2.92(P)m 2.92(P)m	Rhophase	KPS-1503A-2000-KPS	4293	12	27-Feb-2018
Digital thermo Hygrometer	Radio Spares	1260	4300	12	30-Aug-2018
Cable (Rx, Km-Km 2m)	Scott Cables	KPS-1501-2000-KPS	4526	6	22-May-2018
Double Ridged Waveguide Horn Antenna	ETS-Lindgren	3117	4722	12	17-Feb-2018
Double Ridge Broadband Horn Antenna	Schwarzbeck	BBHA 9120 B	4848	12	17-Feb-2018

N/A – Not Applicable

O/P Mon – Output Monitored with Calibrated Equipment



Product Service

3.2 MEASUREMENT UNCERTAINTY

For a 95% confidence level, the measurement uncertainties for defined systems are:-

Test Discipline	Frequency / Parameter	MU
Conducted Maximum Peak Output Power	30 MHz to 20 GHz Amplitude	± 0.1 dB
Conducted Emissions	30 MHz to 20 GHz Amplitude	± 2.3 dB
Frequency Stability	30 MHz to 2 GHz	± 5.0 Hz
Occupied Bandwidth	Up to 20 MHz Bandwidth	± 1.1 Hz
Band Edge	30 MHz to 20 GHz Amplitude	± 2.3 dB
Radiated Emissions, Bilog Antenna, AOATS	30MHz to 1GHz Amplitude	5.1dB*
Radiated Emissions, Horn Antenna, AOATS	1GHz to 40GHz Amplitude	6.3dB*
Worst case error for both Time and Frequency measurement 12 parts in 10 ⁶		



Product Service

SECTION 5

ACCREDITATION, DISCLAIMERS AND COPYRIGHT



Product Service

4.1 ACCREDITATION, DISCLAIMERS AND COPYRIGHT



This report relates only to the actual item/items tested.

Our UKAS Accreditation does not cover opinions and interpretations and any expressed are outside the scope of our UKAS Accreditation.

Results of tests not covered by our UKAS Accreditation Schedule are marked NUA (Not UKAS Accredited).

© 2018 TÜV SÜD Product Service



Product Service

ANNEX A

MODULE LIST



Product Service

Configuration A			
Product	Product No	R-State	Serial No
CT 10	LPC 10248B7/1	R1C	TO1F410050
RRUS01 B2	KRC 118 74/2	R1G	D16q993637
Software Version:	xrus_app-CXP9013268_6-R66AM.xif (based on CXP9013268/6 R66BM)		