

Ericsson AB
 Mats Falk
 PDU HW
 Lindholmspiren 11
 417 56 Göteborg

Radio measurements on RRUS 01 B2 1900 MHz radio equipment with FCC ID: TA8AKRC11874-2 and IC: 287AB-AS118742

(5 appendices)

Test object

Product name: RRUS 01 B2
 Product number: KRC 118 74/2

Summary

See appendix 1 for general information and appendix 5 for external photos.

Standard	Compliant	Appendix
FCC CFR 47 / IC RSS-133 ISSUE 6		
2.1046 / RSS-133 6.4 RF power output	Yes	2
2.1051 / RSS-133 6.5 Spurious emission at antenna terminals	Yes	3
2.1053 / RSS-133 6.5 Field strength of spurious radiation	Yes	4

Note: Above RSS-133 items are given as cross-reference only. Measurements were performed according to ANSI procedures referenced by FCC and covered by SP's accreditation.

SP Technical Research Institute of Sweden

Electronics – EMC

Performed by

Examined by

Jörgen Wassholm

Anders Nordlöf

SP Technical Research Institute of Sweden

Postal address
 SP
 Box 857
 SE-501 15 BORÅS
 Sweden

Office location
 Västeråsen
 Brinellgatan 4
 SE-504 62 BORÅS

Phone / Fax / E-mail
 +46 10 516 50 00
 +46 33 13 55 02
 info@sp.se

Laboratories are accredited by the Swedish Board for Accreditation and Conformity Assessment (SWEDAC) under the terms of Swedish legislation. This report may not be reproduced other than in full, except with the prior written approval of the issuing laboratory.

Table of contents

Description of the test object	Appendix 1
Purpose of test	Appendix 1
Operation modes during measurements	Appendix 1
RF power output	Appendix 2
Spurious emission at antenna terminals	Appendix 3
Field strength of spurious radiation	Appendix 4
External photos	Appendix 5

Appendix 1

Description of the test object

Radio equipment	RRUS 01 B2 (MR) GSM + LTE Product number KRC 118 74/2 Hardware version: R1F FCC ID: TA8AKRC11874-2 IC: 287AB-AS118742 IC MODEL NO: AS118742
Operating bands:	TX: 1930 – 1990 MHz RX: 1850 – 1910 MHz Note: All RX frequencies were configured 80 MHz below the corresponding TX frequency according the applicable duplex offset for the operating band.
Antenna ports:	1 TX/RX port 1 RX port
RF configurations:	Multi RAT (MR) LTE+GSM TX diversity and MIMO 2x2 (TX diversity and MIMO only LTE)
Nominal output power per antenna port:	1-2 LTE + 1-3 GSM (Total power 49 dBm, 80W) Note: See carrier configurations below for nominal output power levels.
Carrier configurations per antenna port:	RRUS 01 B2 (MR) L + G supports a maximum of up to four carriers and uses the following configurations: 2 GSM + 1 LTE 5 MHz (BW), nominal output power 47.8 dBm 3 GSM + 1 LTE 5 or 10 MHz (BW), nominal output power 49.0 dBm 2 GSM + 2 LTE 5 MHz (BW), nominal output power 49.0 dBm 1 GSM + 1 LTE 5, 10 or 15 MHz (BW), nominal output power 49.0 dBm 1 GSM + 2 LTE 5 MHz (BW), nominal output power 49.0 dBm
Antenna:	No dedicated antenna, handled during licensing
LTE Modulations:	QPSK, 16QAM and 64QAM
Channel bandwidth:	5 MHz, 10 MHz and 15 MHz
GSM modulations:	GMSK, 16QAM, 32QAM, AQPSK and 8PSK
Nominal supply voltage:	-48VDC

Appendix 1

Purpose of test

The purpose of the tests is to verify compliance to the performance characteristics specified in applicable items of FCC CFR 47, IC RSS-133 and IC RSS-Gen.

Operation modes during measurements

MR, LTE +GSM

LTE measurements were performed with the test object transmitting test models as defined in 3GPP TS 36.141. Test model E-TM1.1 represent QPSK modulation, test model E-TM3.2 represent 16QAM modulation and test model E-TM3.1 represent 64QAM modulation.

GSM measurements were performed with the test object transmitting pseudorandom data in all timeslots and settings for maximum transmitter output power applicable for each configuration. For AQPSK modulation the SCPIR is 0 dB

The settings below were deemed representative for all traffic scenarios when settings with different modulations, channel bandwidths, number of carriers and RF configurations has been tested to find the worst case setting. All measurements were performed with the test object configured for maximum transmit power. The settings below were used for all measurements if not otherwise noted.

LTE MIMO mode
E-TM1.1

GSM: GMSK modulation

Conducted measurements

The test object was supplied with -48 VDC by an external power supply. Additional connections are documented in the set-up drawings below.

The measurements were performed on the test object 1 (described in the Test setup diagram), running in primary and secondary mode .

Radiated measurements

Test object was powered with -48 VDC. Additional connections are documented in the setup drawings.

References

Measurements were done according to relevant parts of the following standards:

ANSI 63.4-2009

ANSI/TIA/EIA-603-C-2004

CFR 47 part 2, October 1st, 2013

CFR 47 part 24, October 1st, 2013

3GPP TS 36.141, version 11.4.0

3GPP TS 37.141, version 11.3.0

RSS-Gen Issue 3

RSS-133 Issue 6

Appendix 1

Measurement equipment

	Calibration Due	SP number
Test site Tesla	2017-01	503 881
R&S ESU 26	2015-05	901 553
R&S ESI 26	2015-07	503 292
R&S FSQ 40	2015-07	504 143
R&S FSW 43	2015-07	902 073
R&S FSIQ 40	2015-07	503 738
Control computer with R&S software EMC32 version 8.52.0	-	503 899
High pass filter	2015-01	BX40074
High pass filter	2015-07	901 501
High pass filter	2015-07	901 502
High pass filter	2015-07	504 199
High pass filter	2015-07	901 373
High pass filter	2016-07	503 739
High pass filter	2015-07	503 740
RF attenuator	2016-07	503 248
RF attenuator	2016-06	503 249
RF attenuator	2015-08	504 159
RF attenuator	2015-07	900 233
RF attenuator	2015-06	901 384
RF attenuator	2014-11	901 508
Chase Bilog Antenna CBL 6111A	2014-10	503 182
EMCO Horn Antenna 3115	2016-09	502 175
µComp Nordic, Low Noise Amplifier	2015-01	901 545
Flann STD Gain Horn Antenna 16240-25	-	503 939
Flann STD Gain Horn Antenna 18240-25	-	503 900
Flann STD Gain Horn Antenna 20240-20	-	503 674
Miteq, Low Noise Amplifier	2015-08	503 285
Schwarzbeck preamplifier BBV 9742	2015-01	504 085
Temperature and humidity meter, Testo 635	2015-03	504 203
Temperature and humidity meter, Testo 625	2015-06	504 188
Temperature Chamber	-	503 360
Multimeter Fluke 87	2015-08	502 190

Appendix 1

Uncertainties

Measurement and test instrument uncertainties are described in the quality assurance documentation "SP-QD 10885". The uncertainties are calculated with a coverage factor $k=2$ (95% level of confidence).

Compliance evaluation is based on a shared risk principle with respect to the measurement uncertainty.

Reservation

The test results in this report apply only to the particular test object as declared in the report.

Delivery of test object

The test object was delivered 2014-08-12

Manufacturer's representative

Christer Gustavsson, Ericsson AB.

Test engineers

Jörgen Wassholm, Maulo Rivera, Patric Augustsson and Tomas Isbring, SP.

Test participant

None.

Appendix 1

Test Configurations used for conducted measurements

Configuration 1:

GSM			LTE BW 5MHz
RU Carrier Pwr/ port	Test object running in Primary& Secondary mode, 2x43dBm	Ancillary RRUS running in Primary& Secondary mode, 2x43dBm	Running in MIMO mode 1x46dBm
Downlink	513 (1930.4 MHz)	515 (1930.8 MHz)	(1947.5 MHz) ch 775
Downlink	521 (1932.0 MHz)	523 (1932.4 MHz)	
Modulation	GMSK	GMSK	QPSK (E-TM1.1)

Configuration 2:

GSM			LTE BW 10MHz
RU Carrier Pwr/ port	Test object running in Primary& Secondary mode, 2x43dBm	Ancillary RRUS running in Primary& Secondary mode, 2x43dBm	Running in MIMO mode 1x46dBm
Downlink	513 (1930.4 MHz)	515 (1930.8 MHz)	(1945.0 MHz) Ch 750
Downlink	521 (1932.0 MHz)	523 (1932.4 MHz)	
Modulation	GMSK	GMSK	QPSK (E-TM1.1)

Configuration 3:

GSM			LTE BW 15MHz
RU Carrier Pwr/ port	Test object running in Primary& Secondary mode, 1x46dBm	Ancillary RRUS running in Primary& Secondary mode, 1x46dBm	Running in MIMO mode 1x46dBm
Downlink	513 (1930.4 MHz)	515 (1930.8 MHz)	(1942.5 MHz) Ch 725
Modulation	GMSK	GMSK	QPSK (E-TM1.1)

Configuration 4:

GSM			LTE BW 5MHz
RU Carrier Pwr/ port	Test object running in Primary& Secondary mode, 2x43dBm	Ancillary RRUS running in Primary& Secondary mode, 2x43dBm	Running in MIMO mode 1x46dBm
Downlink	801 (1988.0 MHz)	799 (1987.6 MHz)	(1972.5 MHz) Ch 1025
Downlink	809 (1989.6 MHz)	807 (1989.2 MHz)	
Modulation	GMSK	GMSK	QPSK (E-TM1.1)

Configuration 5:

GSM			LTE BW 10MHz
RU Carrier Pwr/ port	Test object running in Primary& Secondary mode, 2x43dBm	Ancillary RRUS running in Primary& Secondary mode, 2x43dBm	Running in MIMO mode 1x46dBm
Downlink	801 (1988.0 MHz)	799 (1987.6 MHz)	(1975.0 MHz) Ch 1050
Downlink	809 (1989.6 MHz)	807 (1989.2 MHz)	
Modulation	GMSK	GMSK	QPSK (E-TM1.1)

Configuration 6:

GSM			LTE BW 5MHz
RU Carrier Pwr/ port	Test object running in Primary& Secondary mode, 2x43dBm	Ancillary RRUS running in Primary& Secondary mode, 2x43dBm	Running in MIMO mode 2x43dBm
Downlink	513 (1930.4 MHz)	515 (1930.8 MHz)	(1947.5 MHz) ch 775
Downlink	521 (1932.0 MHz)	523 (1932.4 MHz)	(1940.0 MHz) ch 700
Modulation	GMSK	GMSK	QPSK (E-TM1.1)

Appendix 1

Configuration 7:

GSM			LTE BW 5MHz
RU Carrier Pwr/ port	Test object running in Primary& Secondary mode, 2x43dBm	Ancillary RRUS running in Primary& Secondary mode, 2x43dBm	Running in MIMO mode 2x43dBm
Downlink	801 (1988.0 MHz)	799 (1987.6 MHz)	(1972.5 MHz) Ch 1025
Downlink	809 (1989.6 MHz)	807 (1989.2 MHz)	(1980.0 MHz) Ch 1100
Modulation	GMSK	GMSK	QPSK (E-TM1.1)

Configuration 8:

GSM			LTE BW 5MHz
RU Carrier Pwr/ port	Test object running in Primary& Secondary mode, 3x41dBm	Ancillary RRUS running in Primary& Secondary mode, 3x41dBm	Running in MIMO mode 1x46dBm
Downlink	513 (1930.4 MHz)	515 (1930.8 MHz)	(1947.5 MHz) ch 775
Downlink	521 (1932.0 MHz)	523 (1932.4 MHz)	
Downlink	529 (1933.6 MHz)	531 (1934.0 MHz)	
Modulation	GMSK	GMSK	QPSK (E-TM1.1)

Configuration 9:

GSM			LTE BW 5MHz
RU Carrier Pwr/ port	Test object running in Primary& Secondary mode, 3x41dBm	Ancillary RRUS running in Primary& Secondary mode, 3x41dBm	Running in MIMO mode 1x46dBm
Downlink	793 (1986.4 MHz)	791 (1986.0 MHz)	(1972.5 MHz) Ch 1025
Downlink	801 (1988.0 MHz)	799 (1987.6 MHz)	
Downlink	809 (1989.6 MHz)	807 (1989.2 MHz)	
Modulation	GMSK	GMSK	QPSK (E-TM1.1)

Appendix 1

Test Configurations used for radiated measurements:

Configuration 1a:

GSM			LTE BW 5MHz
RU Carrier Pwr/ port	Test object running in Primary mode 2x43dBm	Acillary RRUS running in Secondary mode 2x43dBm	Running in MIMO mode 1x46dBm
Downlink	513 (1930.4 MHz)	515 (1930.8 MHz)	(1947.5 MHz) ch 775
Downlink	521 (1932 MHz)	523 (1932.4 MHz)	
Modulation	GMSK	GMSK	QPSK (E-TM1.1)

Configuration 1b:

GSM			LTE BW 5MHz
RU Carrier Pwr/ port	Test object running in Secondary mode 2x43dBm	Acillary RRUS running in Primary mode 2x43dBm	Running in MIMO mode 1x46dBm
Downlink	513 (1930.4 MHz)	515 (1930.8 MHz)	(1947.5 MHz) ch 775
Downlink	521 (1932 MHz)	523 (1932.4 MHz)	
Modulation	GMSK	GMSK	QPSK (E-TM1.1)

Configuration 2:

GSM			LTE BW 10 MHz
RU Carrier Pwr/ port	Test object running in Primary mode 2x43dBm	Acillary RRUS running in Secondary mode 2x43dBm	Running in MIMO mode 1x46dBm
Downlink	513 (1930.4 MHz)	515 (1930.8 MHz)	(1945.0 MHz) Ch 750
Downlink	521 (1932 MHz)	523 (1932.4 MHz)	
Modulation	GMSK	GMSK	QPSK (E-TM1.1)

Configuration 3:

GSM			LTE BW 15MHz
RU Carrier Pwr/ port	Test object running in Primary mode 1x46dBm	Acillary RRUS running in Secondary mode 1x46dBm	Running in MIMO mode 1x46dBm
Downlink	513 (1930.4 MHz)	515 (1930.8 MHz)	(1942.5 MHz) Ch 725
Modulation	GMSK	GMSK	QPSK (E-TM1.1)

Configuration 4:

GSM			LTE BW 5MHz
RU Carrier Pwr/ port	Test object running in Primary mode 2x43dBm	Acillary RRUS running in Secondary mode 2x43dBm	Running in MIMO mode 1x46dBm
Downlink	801 (1988.0 MHz)	799 (1987.6 MHz)	(1972.5 MHz) Ch 1025
Downlink	809 (1989.6 MHz)	807 (1989.4 MHz)	
Modulation	GMSK	GMSK	QPSK (E-TM1.1)

Configuration 5:

GSM			LTE BW 5MHz
RU Carrier Pwr/ port	Test object running in Primary mode 2x43dBm	Acillary RRUS running in Secondary mode 2x43dBm	Running in MIMO mode 2x43dBm
Downlink	801 (1988.0 MHz)	799 (1987.6 MHz)	(1972.5 MHz) Ch 1025
Downlink	809 (1989.6 MHz)	807 (1989.4 MHz)	(1980.0 MHz) Ch 1100
Modulation	GMSK	GMSK	QPSK (E-TM1.1)

Appendix 1

Configuration 6:

GSM			LTE BW 5MHz
RU Carrier Pwr/ port	Test object running in Primary mode 3x41dBm	Acillary RRUS running in Secondary mode 3x41dBm	Running in MIMO mode 1x46dBm
Downlink	793 (1986.4 MHz)	791 (1986.0 MHz)	(1972.5 MHz) Ch 1025
Downlink	801 (1988.0 MHz)	799 (1987.6 MHz)	
Downlink	809 (1989.6 MHz)	807 (1989.4 MHz)	
Modulation	GMSK	GMSK	QPSK (E-TM1.1)

Appendix 1

Test set-up conducted measurements MR LTE+GSM

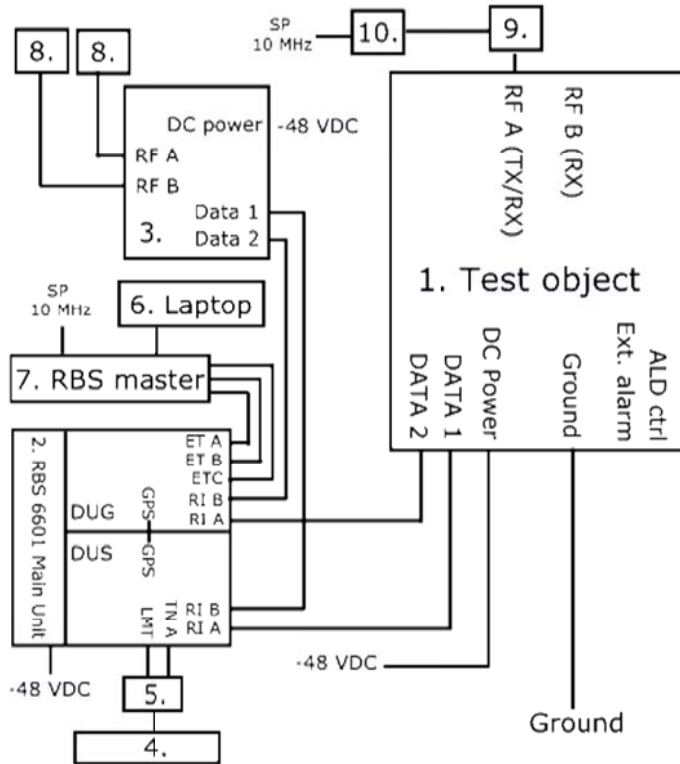

Test object:

1.	RRUS 01 B2, KRC 118 74/2, rev. R1F, s/n: D16E296105, running in primary & secondary mode. working software CXP 901 3268/6, rev. R54EG with FCC ID: TA8AKRC11874-2 and IC: 287AB-AS118742
----	--

Ancillary equipment:

2.	RBS 6601 Main Unit: SUP 6601, 1/ BFL 901 009/4, rev: R1E, s/n: BR88258944 DUG 20 01, KDU 137 569/1, rev: R2B, s/n: C824149297 SUP 6601, 1/ BFL 901 009/4, rev: R1E, s/n: BR88258854 DUS 41 01, KDU 137 624/1, rev: R5A, s/n: D168382181 DC power via Power Supply SM 70-22, BAMS – 1000994645
3.	RRUS 01 B2, KRC 118 74/2, rev. R1F, s/n: D16E296105

Functional test equipment:

4.	Sun microsystems Ultra 27, BAMS – 1000861874 Switch Neatgear GSM 7212, BAMS – 1000850754
5.	Switch Neatgear GSM 7224, BAMS – 1001252309 Symmetricom SyncServer S250, BAMS – 1000690719 Symmetricom 8040 Rubidium Frequency Standard, BAMS – 1000645316
6.	Laptop HP EliteBook 6930p
7.	RBS Master, 2E LPY 107 1007/3, BAMS – 1000875937
8.	Terminator
9.	SP test instrument according measurement equipment list
10.	SP test instrument according measurement equipment list

Appendix 1

Test setup radiated measurements MR LTE+GSM

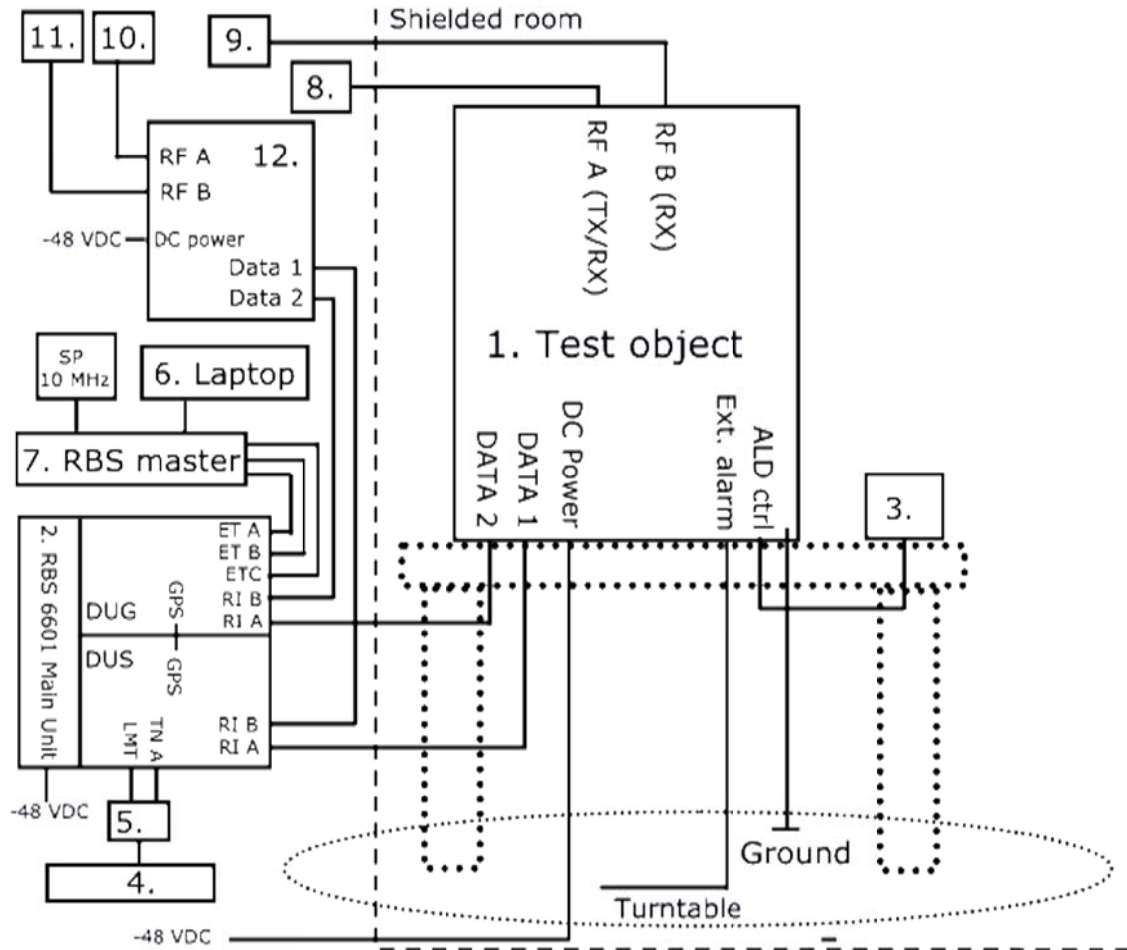

Test object:

1.	RRUS 01 B2, KRC 118 74/2, rev. R1F, s/n: D16E296105, running in primary & secondary mode. working software CXP 901 3268/6, rev. R54EG with FCC ID: TA8AKRC11874-2 and IC: 287AB-AS118742
----	--

Ancillary equipment:

2.	RBS 6601 Main Unit: SUP 6601, 1/ BFL 901 009/4, rev: R1E, s/n: BR88258944 DUG 20 01, KDU 137 569/1, rev: R2B, s/n: C824149297 SUP 6601, 1/ BFL 901 009/4, rev: R1E, s/n: BR88258854 DUS 41 01, KDU 137 624/1, rev: R5A, s/n: D168382181 DC power via Power Supply SM 70-22, BAMS – 1000994645
3.	RET, KRY 121 67/2, rev: R1G, BAMS – 1000601140
12.	RRUS 01 B2, KRC 118 74/2, rev. R1F, s/n: D16E296105

Appendix 1

Functional test equipment:

4.	Sun microsystems Ultra 27, BAMS – 1000861874 Switch Neatgear GSM 7212, BAMS – 1000850754
5.	Switch Neatgear GSM 7224, BAMS – 1001252309 Symmetricom SyncServer S250, BAMS – 1000690719 Symmetricom 8040 Rubidium Frequency Standard, BAMS – 1000645316
6.	Laptop HP EliteBook 6930p
7.	RBS Master, 2E LPY 107 1007/3, BAMS – 1000875937
8.	ESI 26, SP number: 503 292, for supervision purpose only
9.	Terminator
10.	Terminator
11.	Terminator

Interfaces:

Type of port:

Power: -48 VDC	DC Power
Antenna port (A), 7/16 connector, combined TX/RX	Antenna
Antenna port (B), 7/16 connector, only RX	Antenna
Data 1, optical interface	Signal
Data 2, optical interface	Signal
RX A Out, no cable attached	RF
RX A I/O, cross connector, no cable attached	RF
RX B I/O, cross connector, no cable attached	RF
ALD ctrl	Signal
Ext. alarm	Signal
Ground wire	Ground

RBS software:

	Product number	Revision
LTE	CXP 102 051/19	R40AM
GSM	CXP 104 0013/10	R73F

Appendix 2

RF power output measurements according to CFR 47 §2.1046 / IC RSS-133 6.4

Date	Temperature	Humidity
2014-08-28	23 °C ± 3 °C	46 % ± 5 %
2014-08-29	23 °C ± 3 °C	43 % ± 5 %

Test set-up and procedure

The test object was connected to a signal analyzer measuring peak and RMS output power in CDF mode. A resolution bandwidth of 50 MHz was used.

Measurement equipment	SP number
Rohde & Schwarz signal analyzer FSQ40	504 143
RF attenuator	901 508
Testo 635 temperature and humidity meter	504 203

Measurement uncertainty: 1.1 dB

Results

Measured output power at RF connector.

Tested configuration	Test object running in primary mode [RMS dBm/ dB PAR ¹⁾]	Test object running in secondary mode [RMS dBm/ dB PAR ¹⁾]	Nominal output power [RMS dBm]
1	47.56/ 6.80	47.53/ 6.83	47.8
2	48.78/ 6.61	48.70/ 6.68	49.0
3	48.75/ 6.61	48.64/ 6.68	49.0
4	47.58/ 6.68	47.53/ 6.73	47.8
5	48.87/ 6.44	48.75/ 6.51	49.0
6	48.25/ 7.28	48.25/ 7.24	49.0
7	48.36/ 7.00	48.40/ 6.95	49.0
8	48.19/ 7.26	48.18/ 7.26	49.0
9	48.17/ 7.16	48.17/ 7.19	49.0

¹⁾: The PAR value is the 0.1 % Peak to Average Ratio

Appendix 2

Remark

This unit is tested without antenna. ERP/EIRP compliance is addressed at the time of licensing, as required by the responsible FCC/IC Bureau(s). Licensee's are required to take into account maximum allowed antenna gain used in combination with above power settings to prevent the radiated output power to exceed the limits.

Limits

§24.232 The maximum output power may not exceed 3280 W/MHz (EIRP).
The Peak to Average Ratio (PAR) may not exceed 13 dB.

RSS-133 Base station transmitters operating in the band 1930-1995 MHz shall not have output power exceeding 100 watts. When the transmitter power is measured in terms of average value, the peak-to-average ratio(PAR) of the power shall not exceed 13 dB

There is no EIRP limit specified for base station equipment in the RSS-133.

EIRP compliance is addressed at the time of licensing, as required by the responsible IC Bureau. Licensee's are required to take into account the antenna gain to get the maximum usable power settings to prevent the radiated output power to exceed the EIRP limits specified in SRSP-510

Complies?	Yes
-----------	-----

Appendix 3

Conducted spurious emission measurements according to CFR 47 §2.1051 / IC RSS-133 6.5

Date	Temperature	Humidity
2014-08-28	23 °C ± 3 °C	46 % ± 5 %
2014-08-29	23 °C ± 3 °C	43 % ± 5 %

Test set-up and procedure

The measurements were made per definition in §24.238. The output was connected to a spectrum analyzer with a RBW setting of 1 MHz and RMS detector activated. The spectrum analyzer was connected to an external 10 MHz reference standard during the measurements.

Before comparing the results to the limit, 3 dB [10 log (2)] should be added according to method E), 3), (iii) “measure and add 10 log(N_{ANT})” of FCC KDB662911 D01 Multiple Transmitter Output v02r01 The 3 dB should not be added to the spurious emissions related to GSM carriers as GSM do not operate in TX diversity/ MIMO mode.

Measurement equipment	SP number
Rohde & Schwarz signal analyzer FSQ40	504 143
RF attenuator	901 508
High pass filter	BX40074
Testo 635 temperature and humidity meter	504 203

Measurement uncertainty: 3.7 dB

Appendix 3

Results

MR LTE + GSM

Diagrams	Configuration	Tested mode
1 a-e	1	Primary
2 a-e	2	Primary
3 a-e	3	Primary
4 a-e	4	Primary
5 a-e	4	Secondary
6 a-e	5	Primary
7 a-e	5	Secondary
8 a-e	6	Primary
9 a-e	7	Primary
10 a-e	8	Primary
11 a-e	9	Primary
12 a-e	9	Secondary

The diagrams are shown on the following pages.

Remarks

The emission at 9 kHz on some of the plots was not generated by the test object. A complementary measurement with a smaller RBW showed that it was related to the LO feed-through. The upper frequency boundary was chosen to cover 10x the highest TX fundamental frequency.

Limits

CFR 47 §24.238 and IC RSS-133 6.5

Outside a licensee's frequency band(s) of operation the power of any emission shall be attenuated below the transmitter power (P) by at least $43 + 10 \log (P)$ dB, resulting in a limit of -13 dBm.

Complies?	Yes
-----------	-----

Appendix 3

Diagram 1 a:

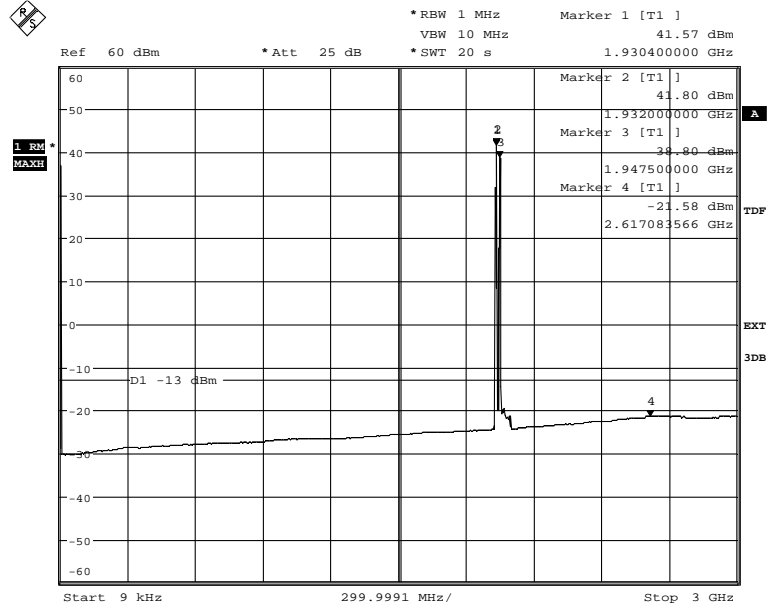

Date: 28.AUG.2014 12:29:24

Diagram 1 b:

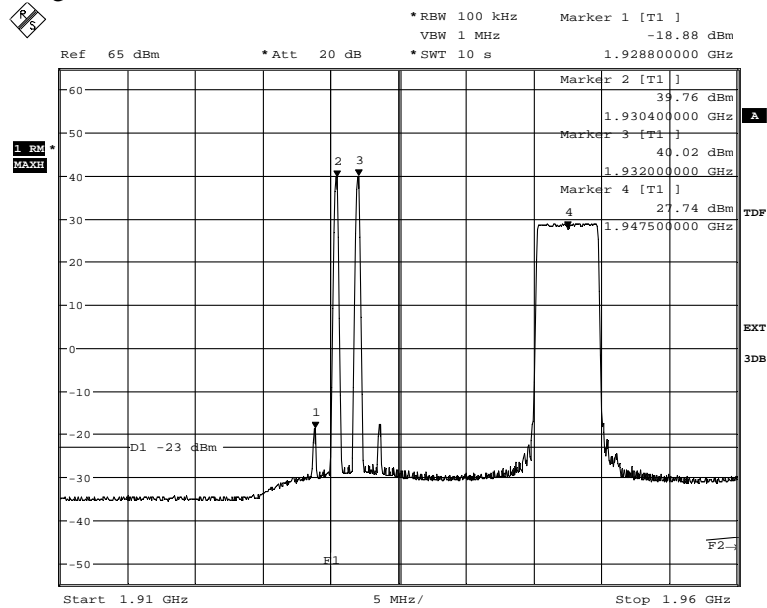

Date: 28.AUG.2014 12:27:34

The emission at 1928.8 MHz was -16.38 dBm, measured with the channel power method with 1 MHz channel bandwidth.

The result should be compared to the limit -13 dBm.

Appendix 3

Diagram 1 c:

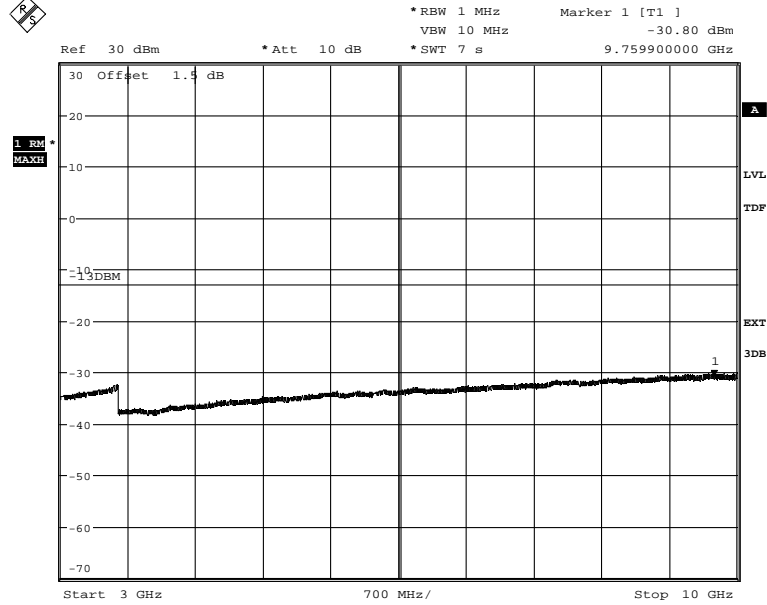

Date: 28.AUG.2014 12:30:51

Diagram 1 d:

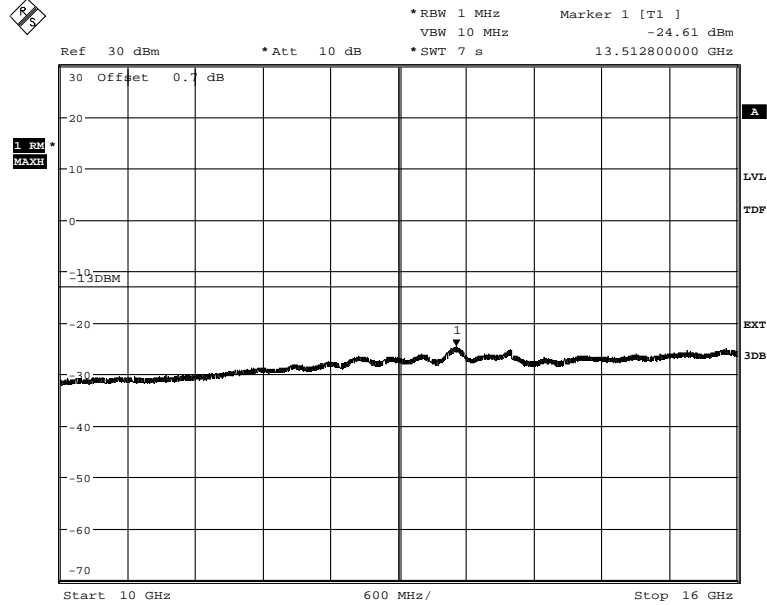

Date: 28.AUG.2014 12:31:55

Appendix 3

Diagram 1 e:

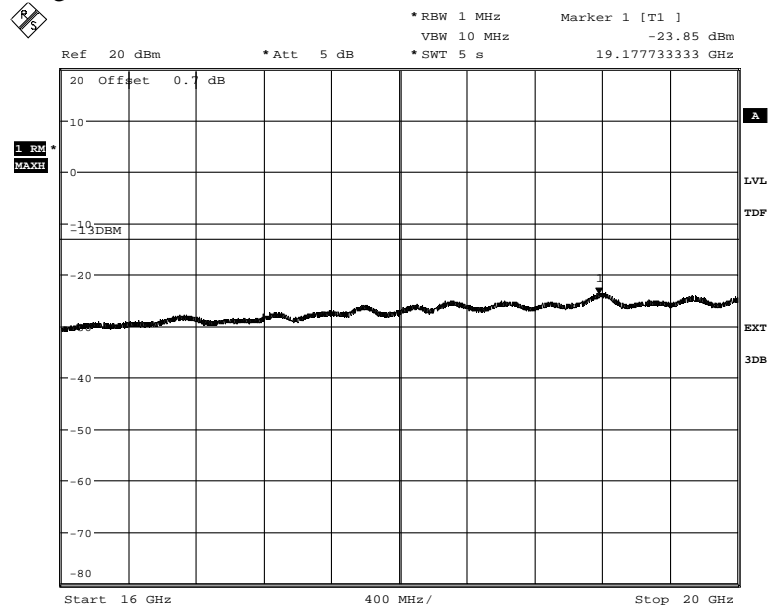

Date: 28.AUG.2014 12:33:12

Appendix 3

Diagram 2 a:

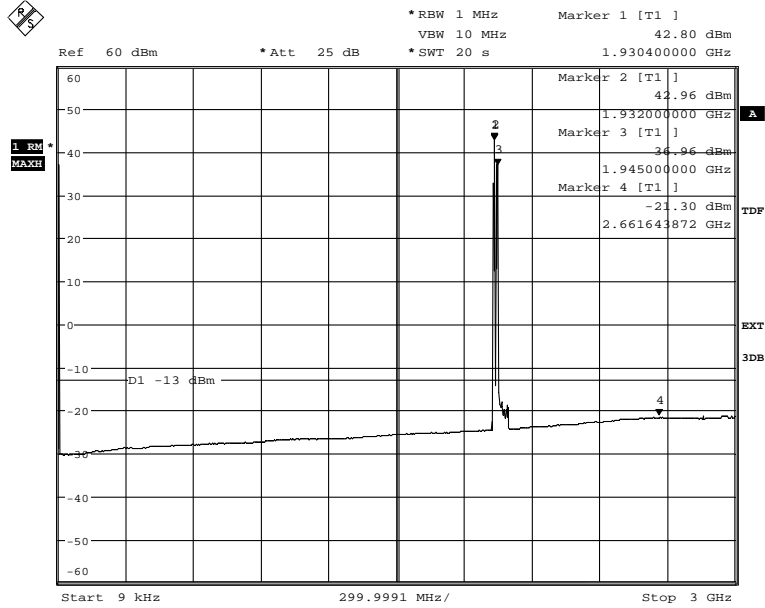

Date: 28.AUG.2014 12:51:45

Diagram 2 b:

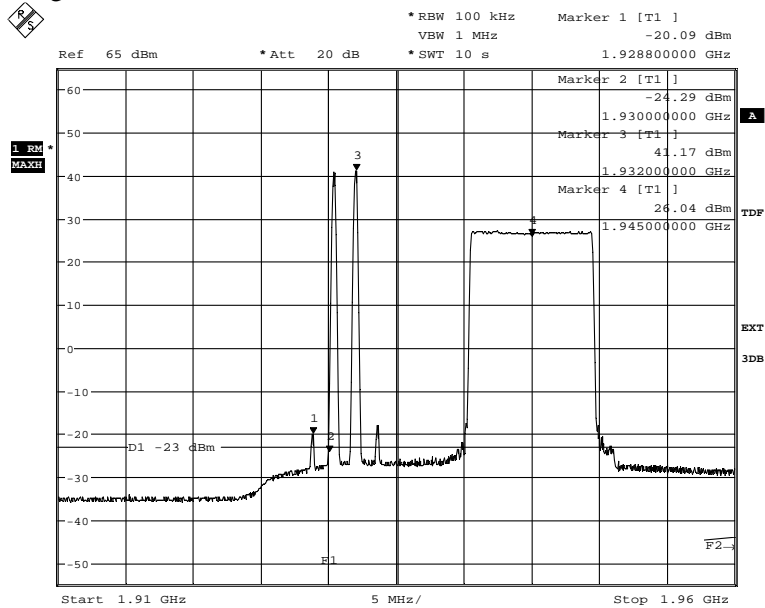

Date: 28.AUG.2014 12:48:24

The emission at 1928.8 MHz was -16.49 dBm, measured with the channel power method with 1 MHz channel bandwidth. The result should be compared to the limit -13 dBm.

Appendix 3

Diagram 2 c

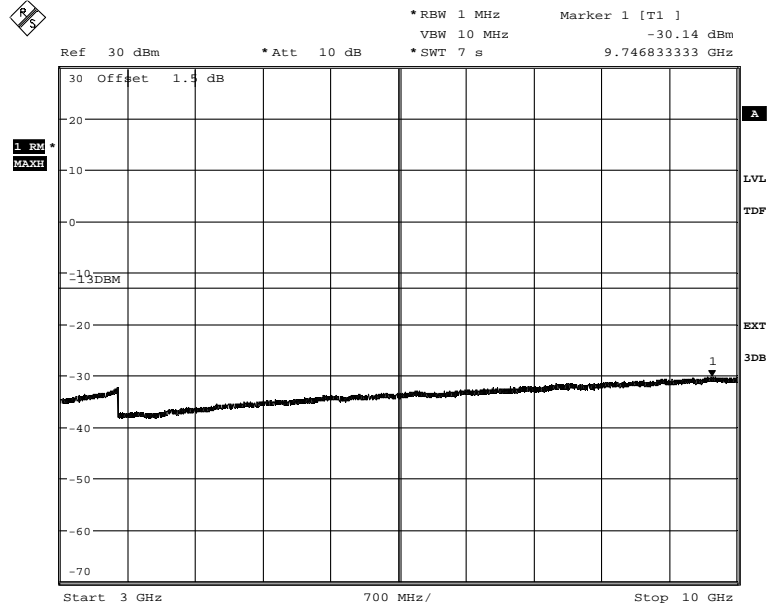

Date: 28.AUG.2014 12:38:31

Diagram 2 d:

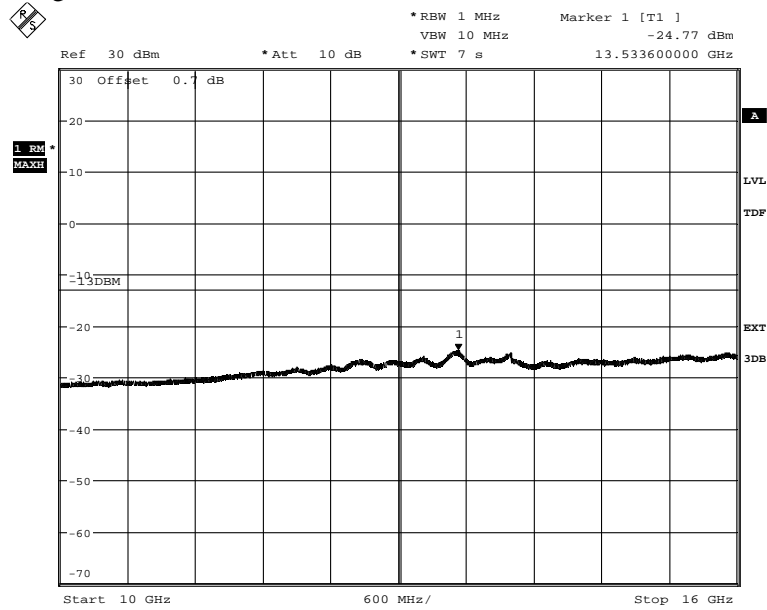

Date: 28.AUG.2014 12:39:31

Appendix 3

Diagram 2 e:

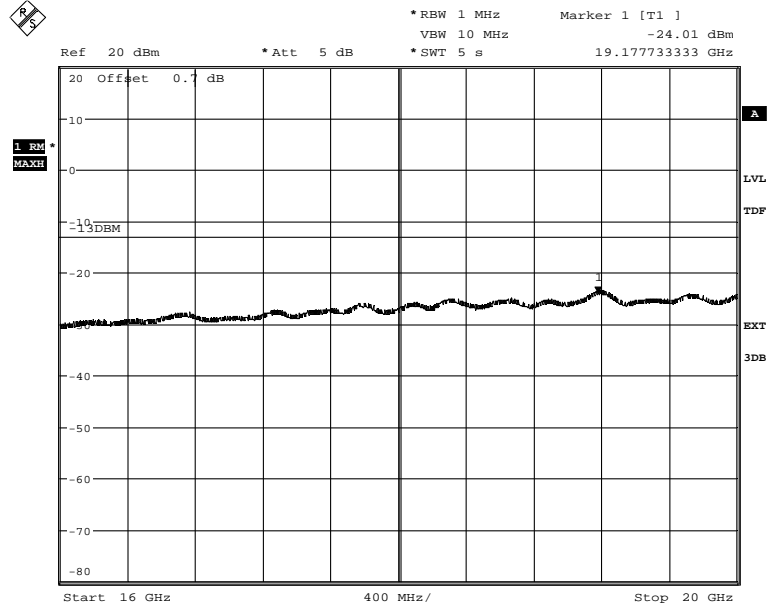

Date: 28.AUG.2014 12:37:26

Appendix 3

Diagram 3 a:

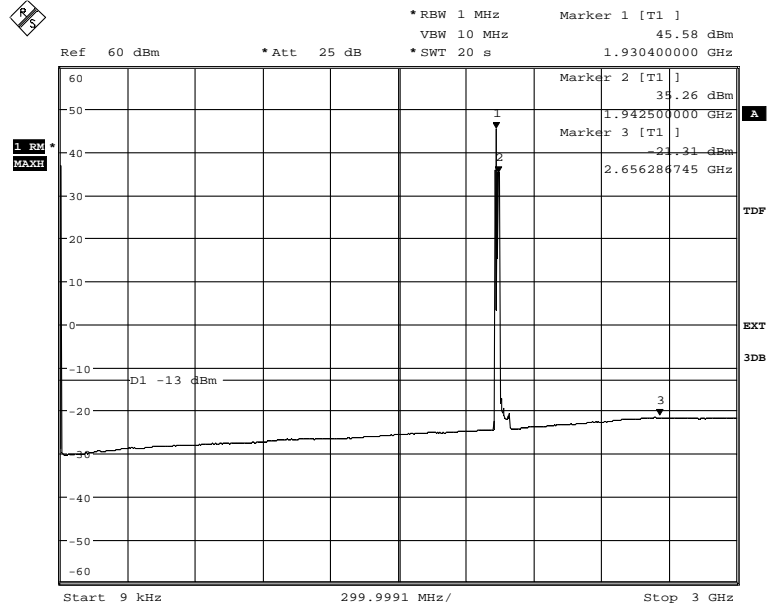

Date: 28.AUG.2014 13:01:37

Diagram 3 b:

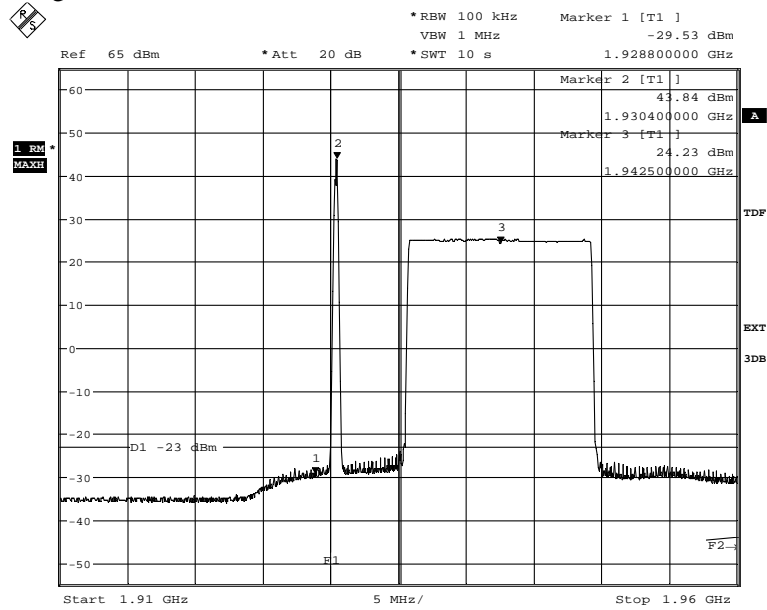

Date: 28.AUG.2014 12:58:57

Appendix 3

Diagram 3 c:

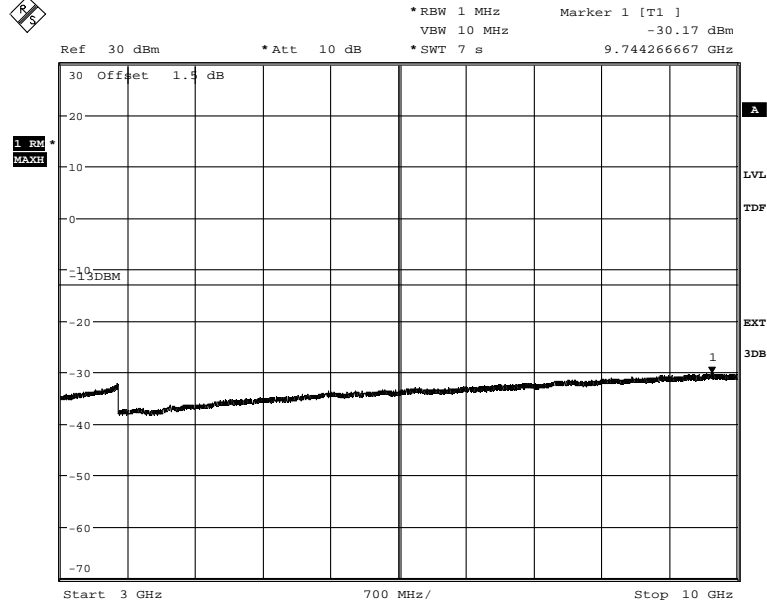

Date: 28.AUG.2014 12:42:30

Diagram 3 d:

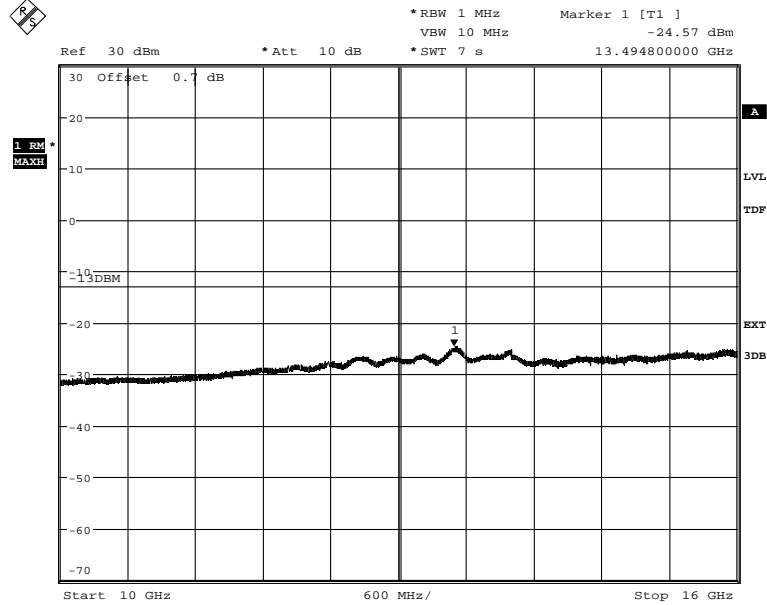

Date: 28.AUG.2014 12:41:33

Appendix 3

Diagram 3 e:

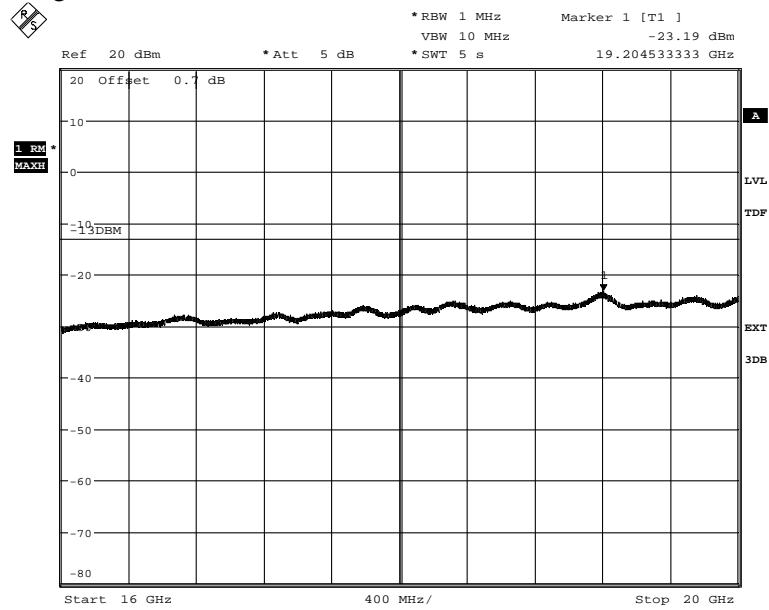

Date: 28.AUG.2014 12:40:50

Appendix 3

Diagram 4 a:

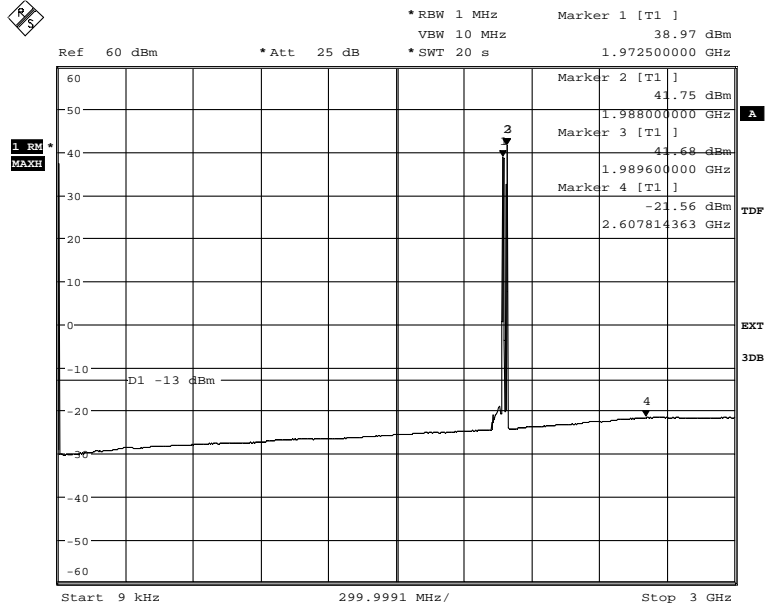

Date: 28.AUG.2014 13:06:39

Diagram 4 b:

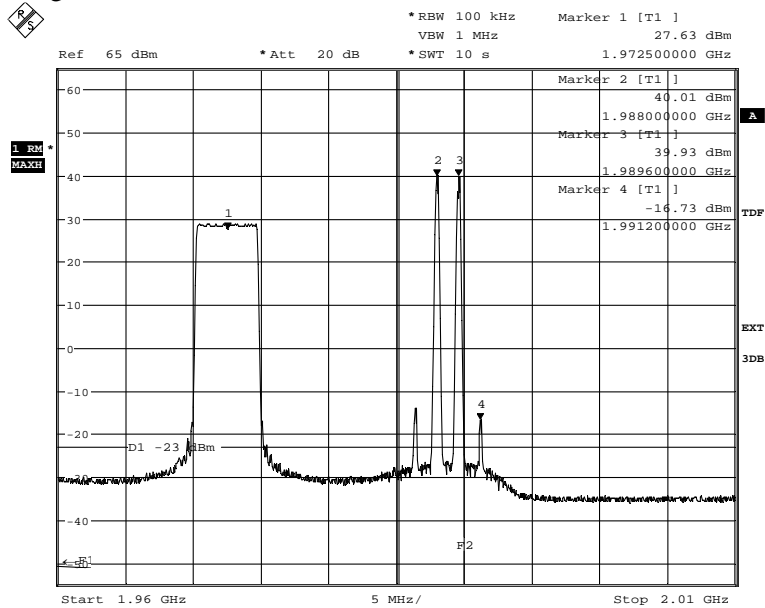

Date: 28.AUG.2014 13:08:36

The emission at 1991.2 MHz was -13.84 dBm, measured with the channel power method with 1 MHz channel bandwidth. The result should be compared to the limit -13 dBm.

Appendix 3

Diagram 4 c:

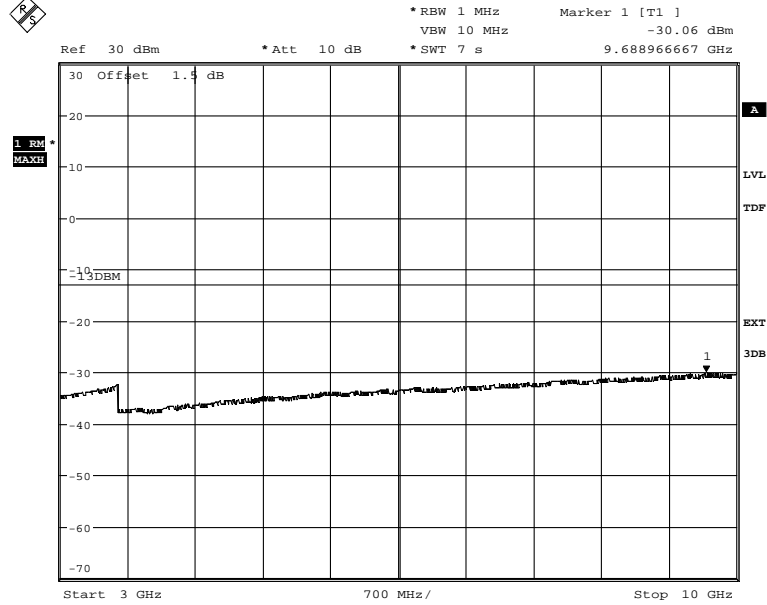

Date: 28.AUG.2014 13:14:32

Diagram 4 d:

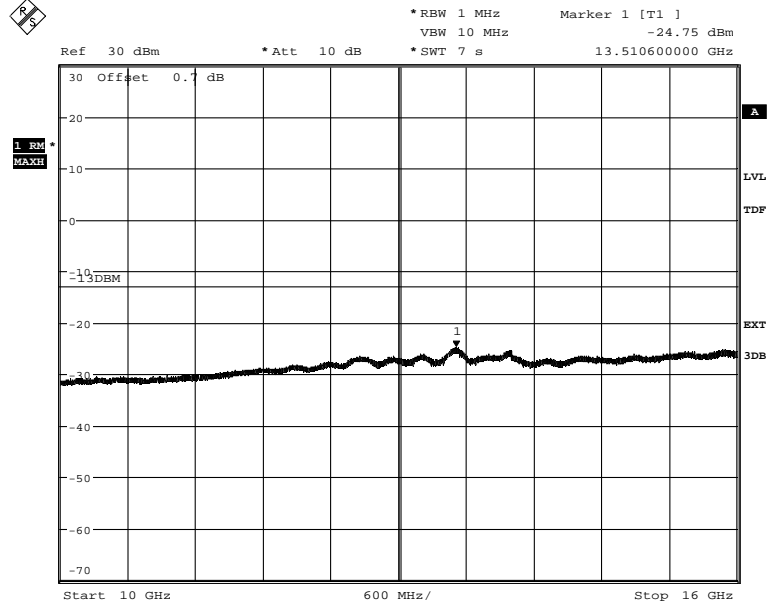

Date: 28.AUG.2014 13:15:52

Appendix 3

Diagram 4 e:

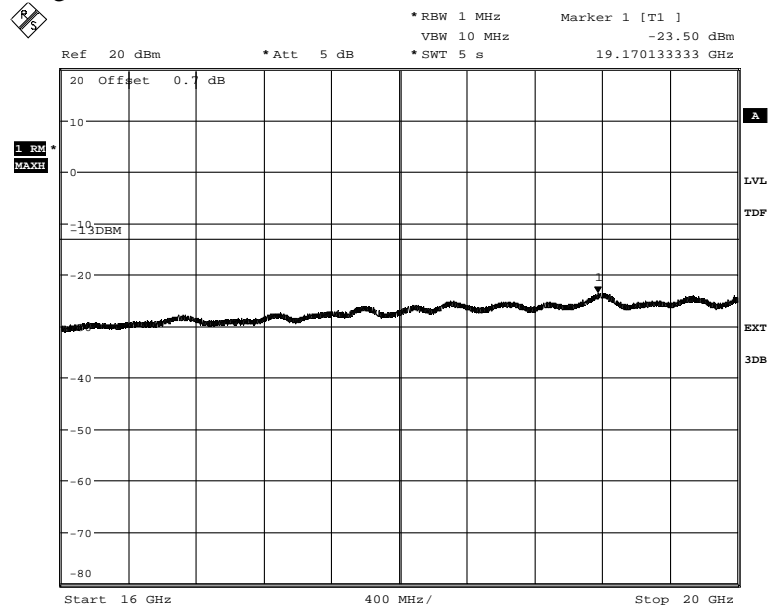

Date: 28.AUG.2014 13:16:53

Appendix 3

Diagram 5 a:

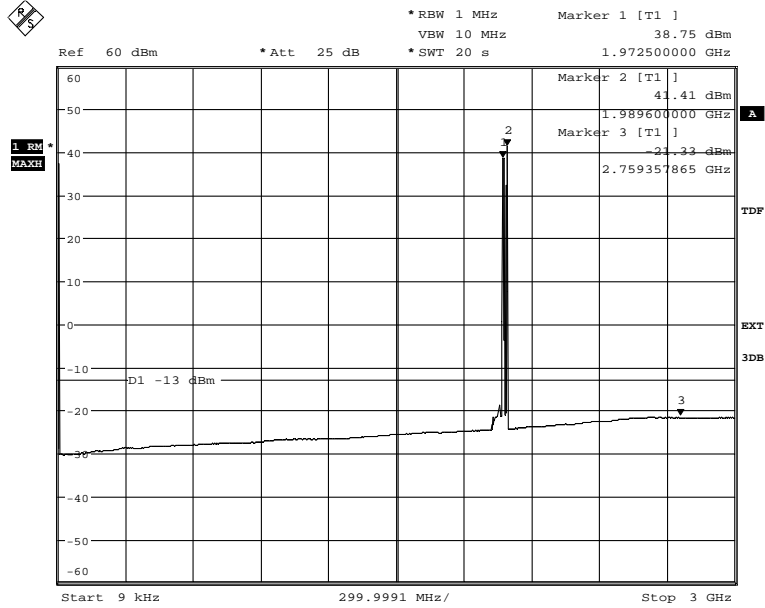

Date: 29.AUG.2014 11:40:37

Diagram 5 b:

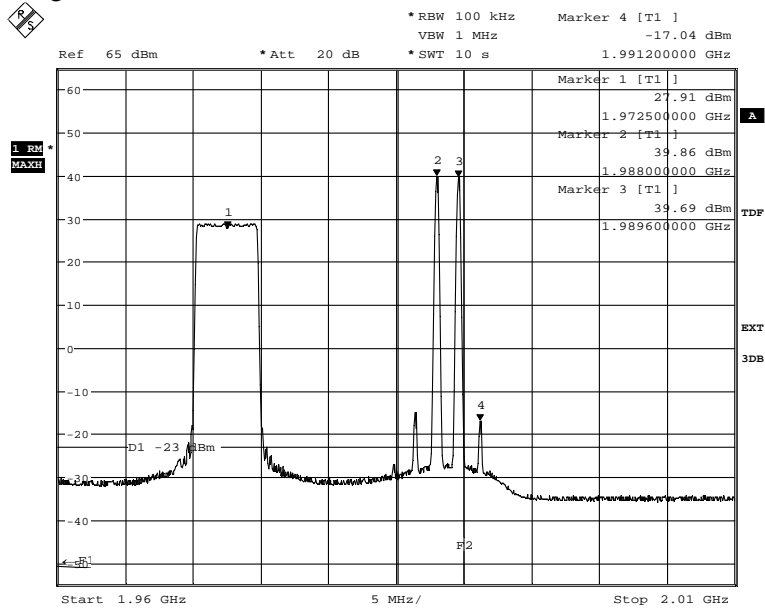

Date: 29.AUG.2014 11:39:10

The emission at 1991.2 MHz was -14.58 dBm, measured with the channel power method with 1 MHz channel bandwidth. The result should be compared to the limit -13 dBm.

Appendix 3

Diagram 5 c:

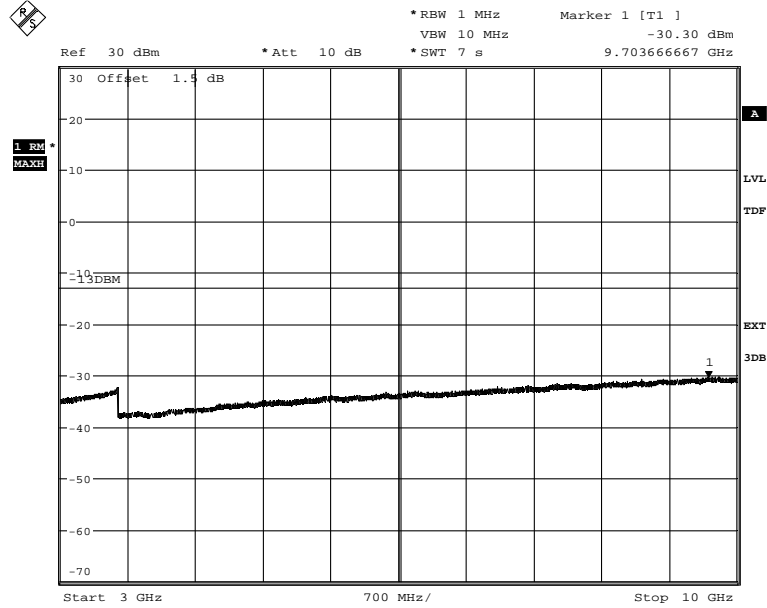

Date: 29.AUG.2014 10:48:05

Diagram 5 d:

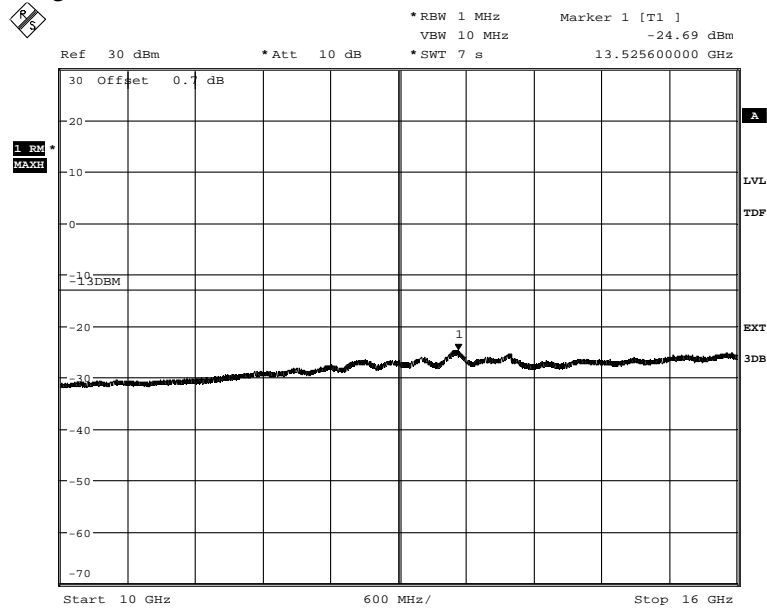

Date: 29.AUG.2014 10:47:23

Appendix 3

Diagram 5 e:

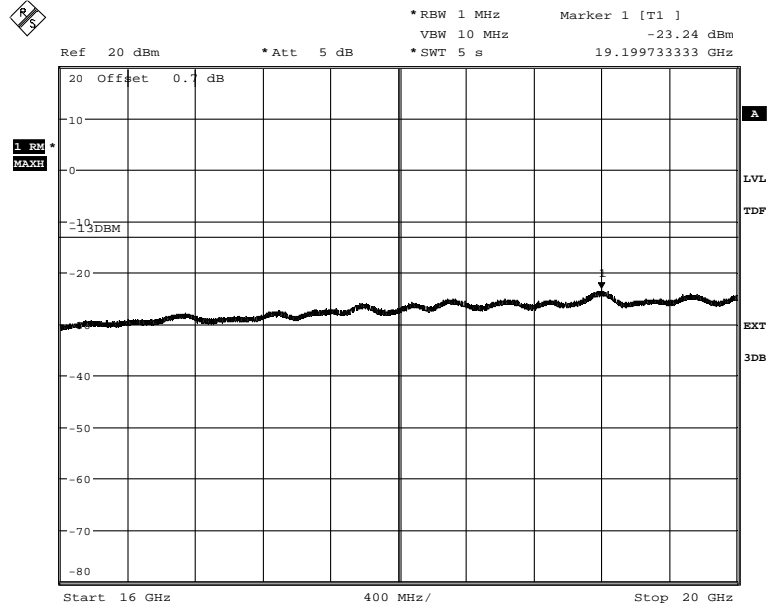

Date: 29.AUG.2014 10:46:28

Appendix 3

Diagram 6 a:

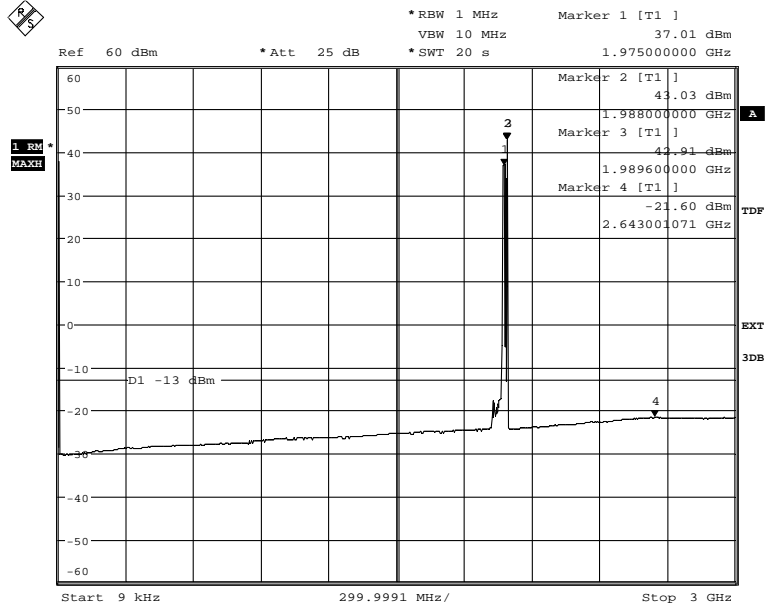

Date: 28.AUG.2014 13:29:47

Diagram 6 b:

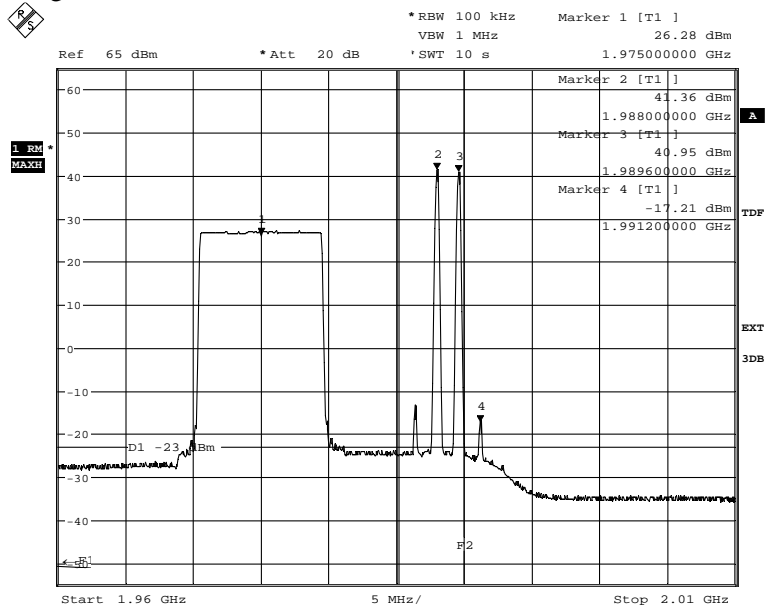

Date: 28.AUG.2014 13:33:18

The emission at 1928.8 MHz was -13.26 dBm, measured with the channel power method with 1 MHz channel bandwidth. The result should be compared to the limit -13 dBm.

Appendix 3

Diagram 6 c:

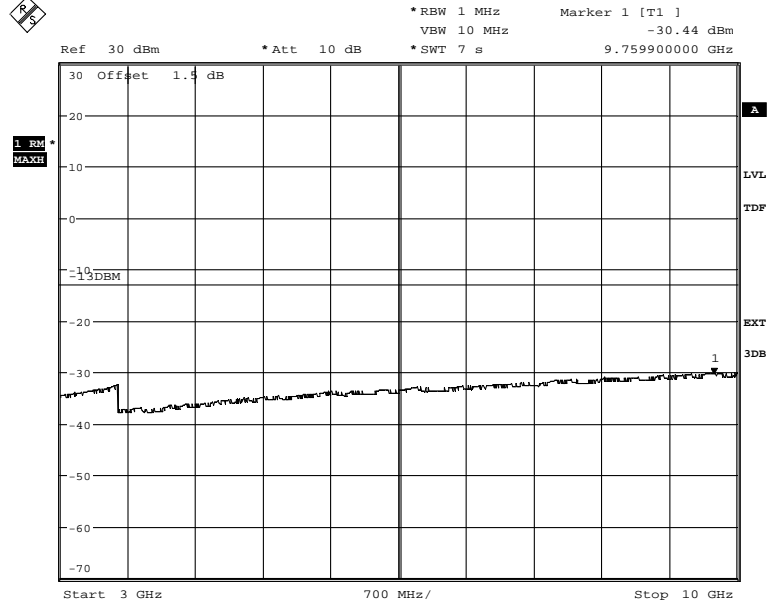

Date: 28.AUG.2014 13:23:38

Diagram 6 d:

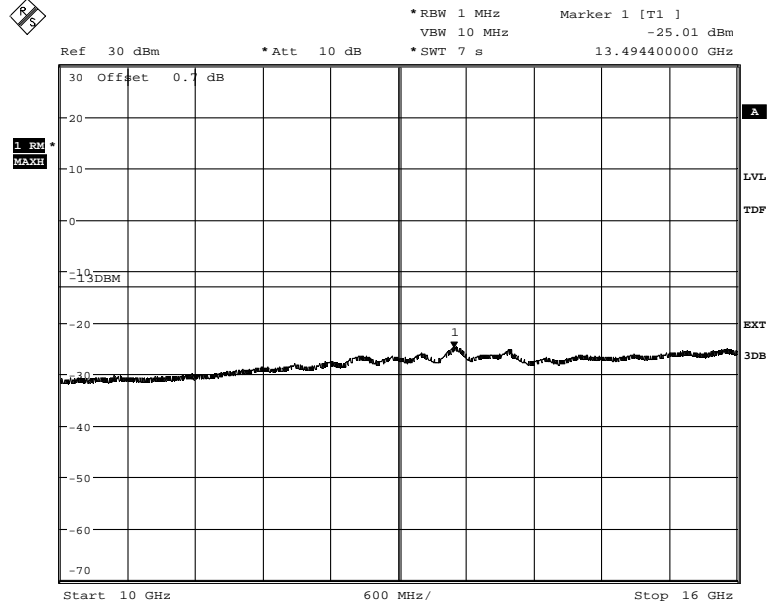

Date: 28.AUG.2014 13:24:39

Appendix 3

Diagram 6 e:

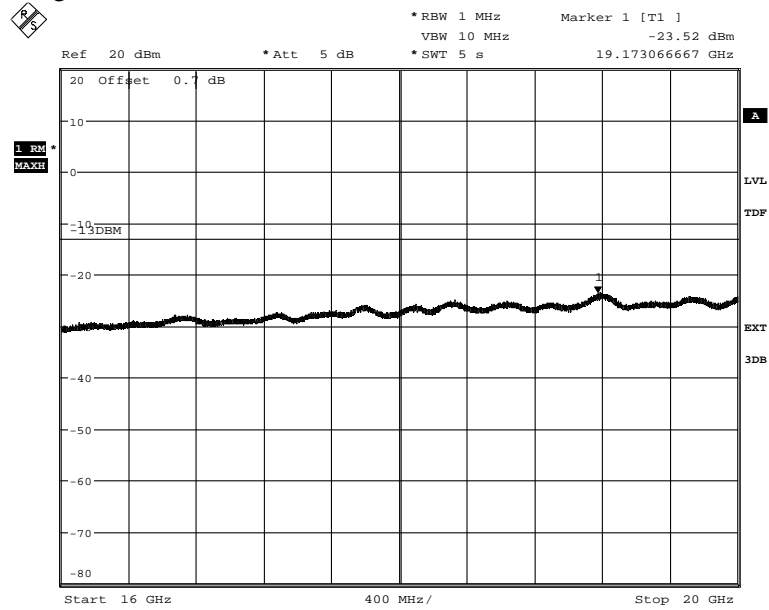

Date: 28.AUG.2014 13:25:34

Appendix 3

Diagram 7 a:

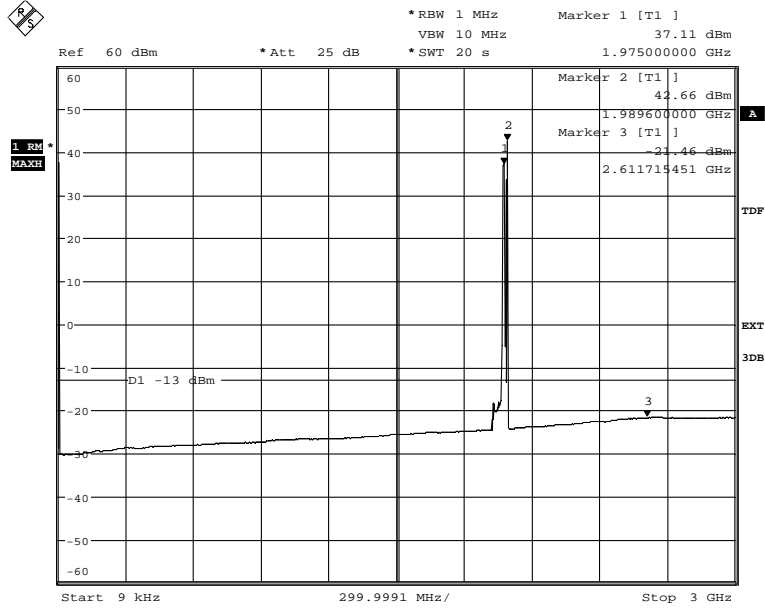

Date: 29.AUG.2014 11:43:37

Diagram 7 b:

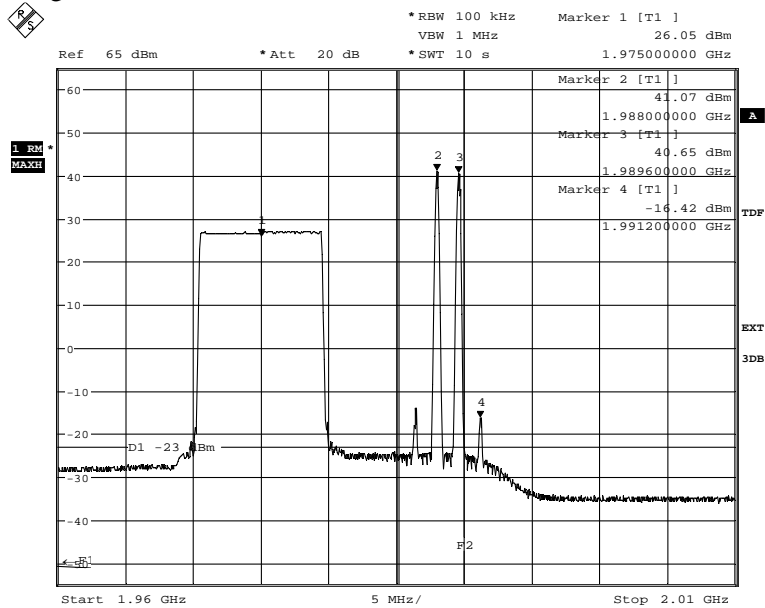

Date: 29.AUG.2014 11:44:33

The emission at 1991.2 MHz was -13.29 dBm, measured with the channel power method with 1 MHz channel bandwidth. The result should be compared to the limit -13 dBm.

Appendix 3

Diagram 7 c:

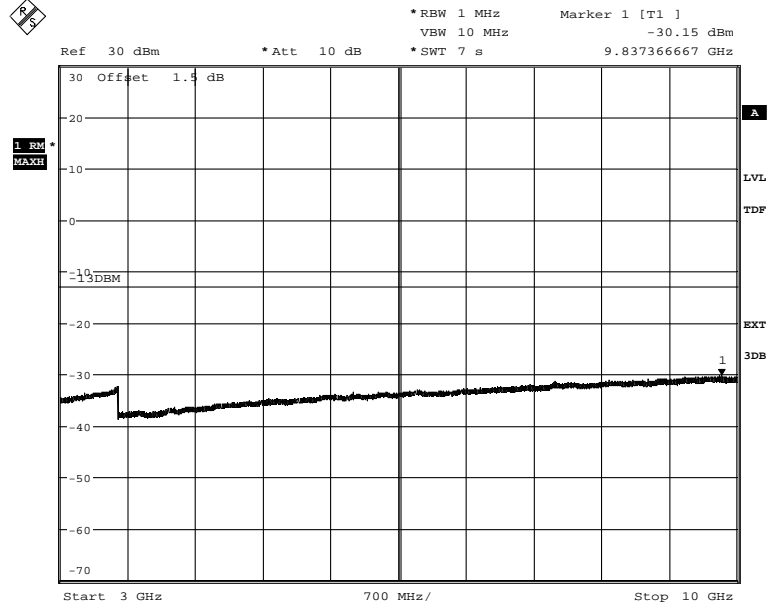

Date: 29.AUG.2014 10:43:15

Diagram 7 d:

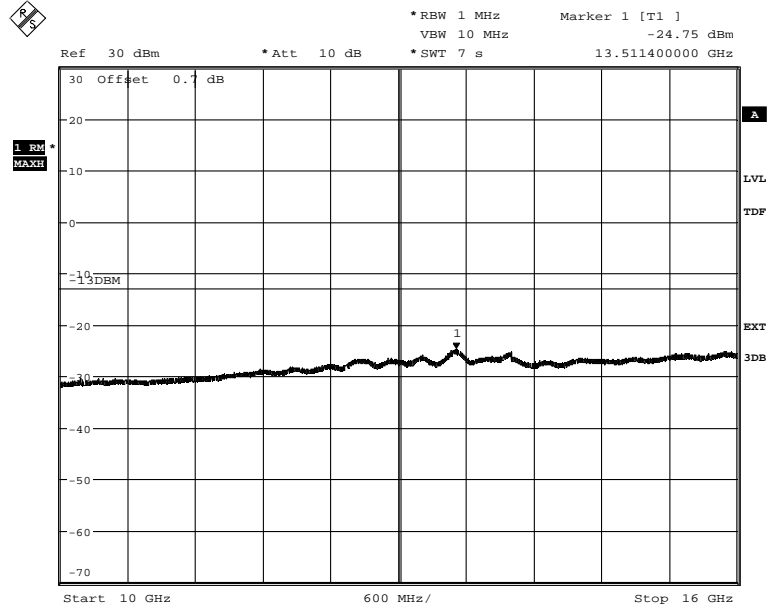

Date: 29.AUG.2014 10:44:03

Appendix 3

Diagram 7 e:

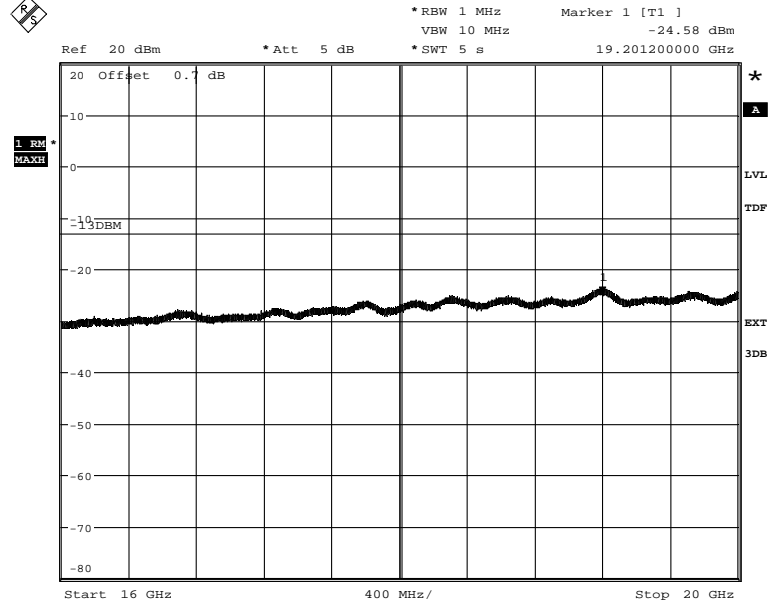

Date: 29.AUG.2014 10:42:24

Appendix 3

Diagram 8 a:

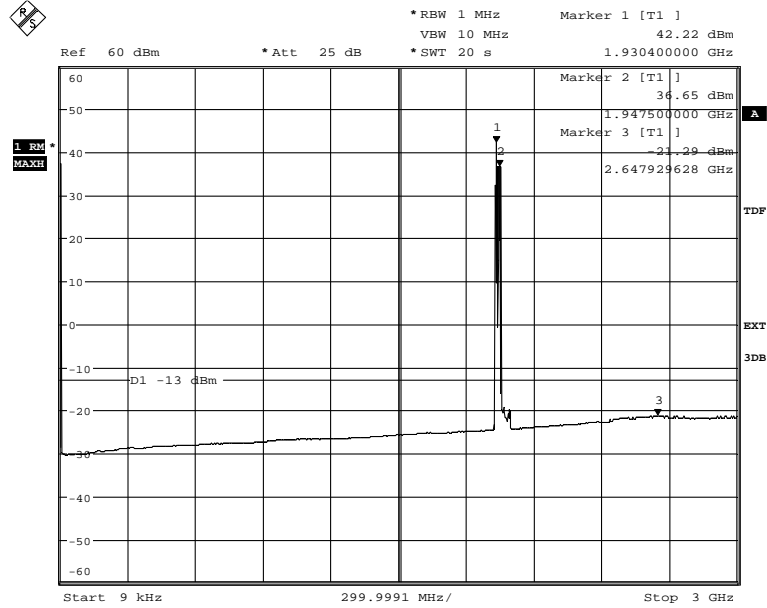

Date: 29.AUG.2014 08:40:17

Diagram 8 b:

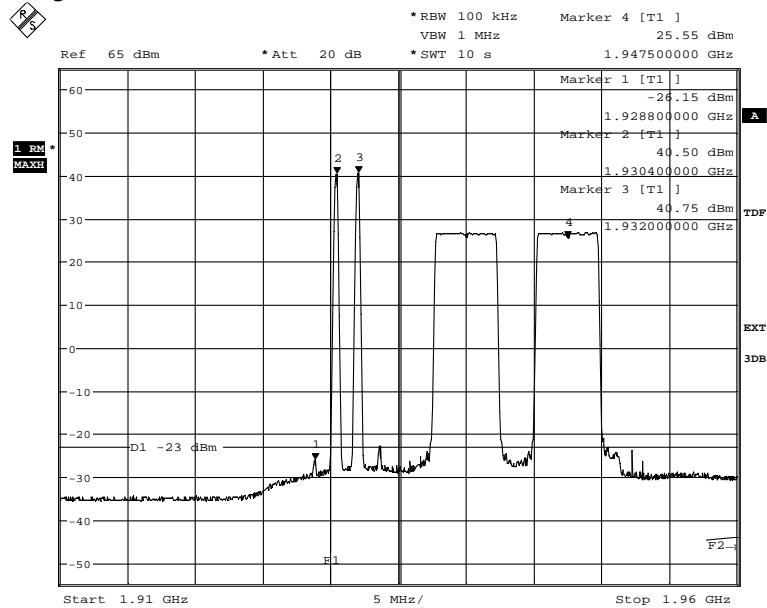

Date: 29.AUG.2014 08:39:21

The emission at 1928.8 MHz was -20.29 dBm, measured with the channel power method with 1 MHz channel bandwidth. The result should be compared to the limit -13 dBm.

Appendix 3

Diagram 8 c:

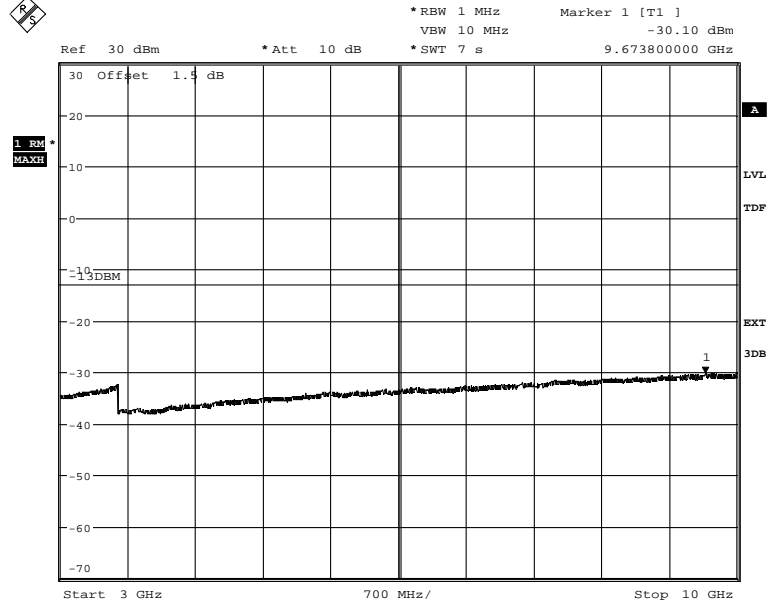

Date: 29.AUG.2014 08:47:36

Diagram 8 d:

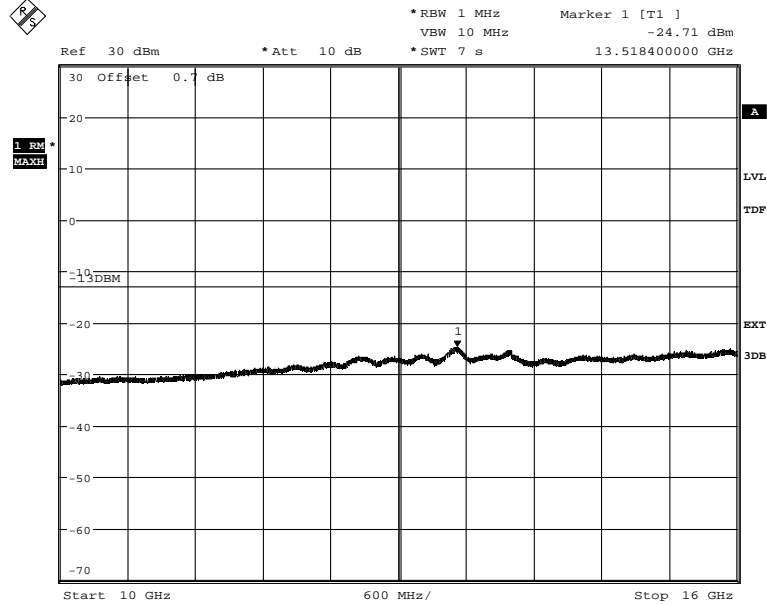

Date: 29.AUG.2014 08:48:59

Appendix 3

Diagram 8 e:

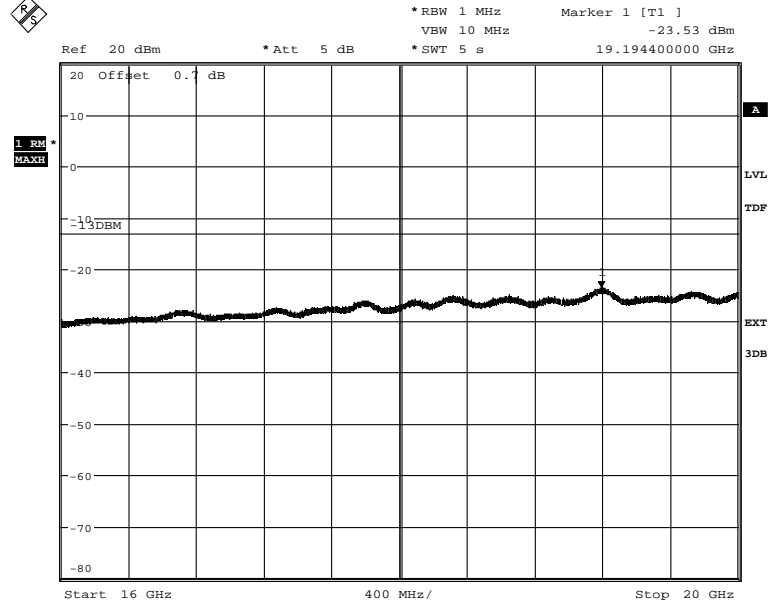

Date: 29.AUG.2014 08:49:53

Appendix 3

Diagram 9 a:

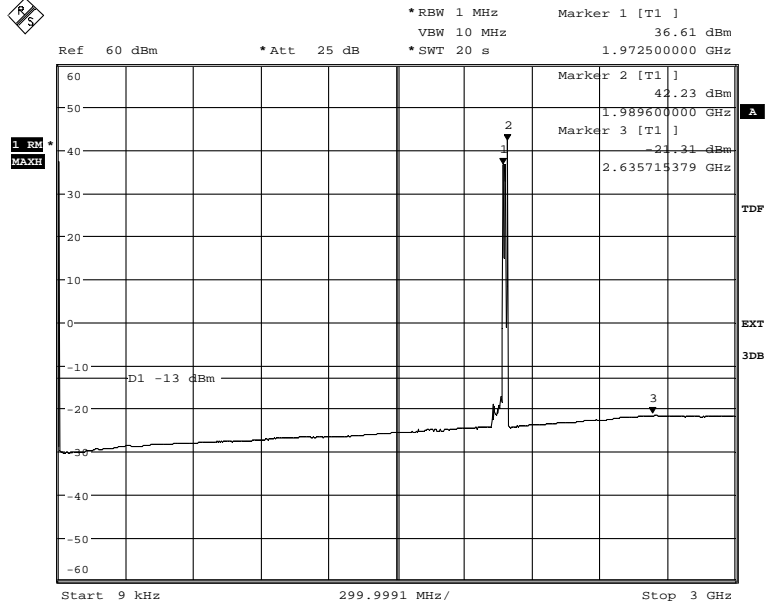

Date: 29.AUG.2014 09:08:25

Diagram 9 b:

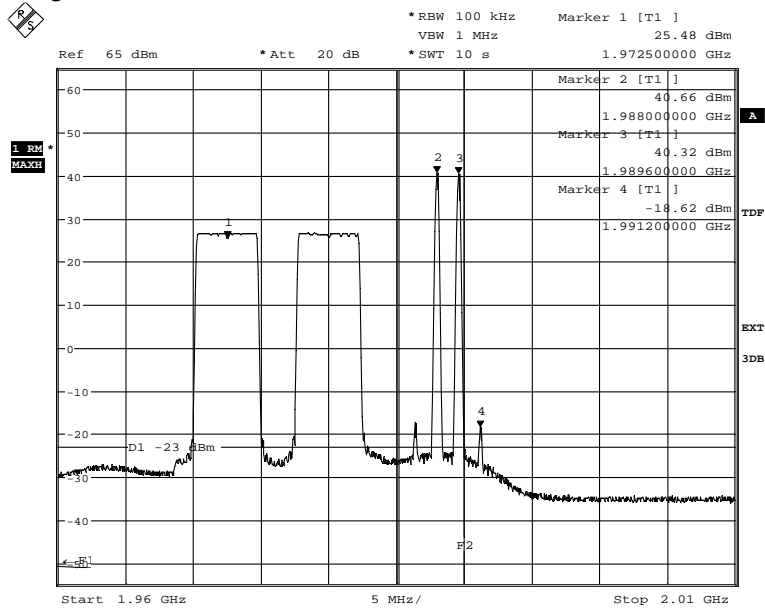

Date: 29.AUG.2014 09:07:12

The emission at 1991.2 MHz was -14.91 dBm, measured with the channel power method with 1 MHz channel bandwidth. The result should be compared to the limit -13 dBm.

Appendix 3

Diagram 9 c:

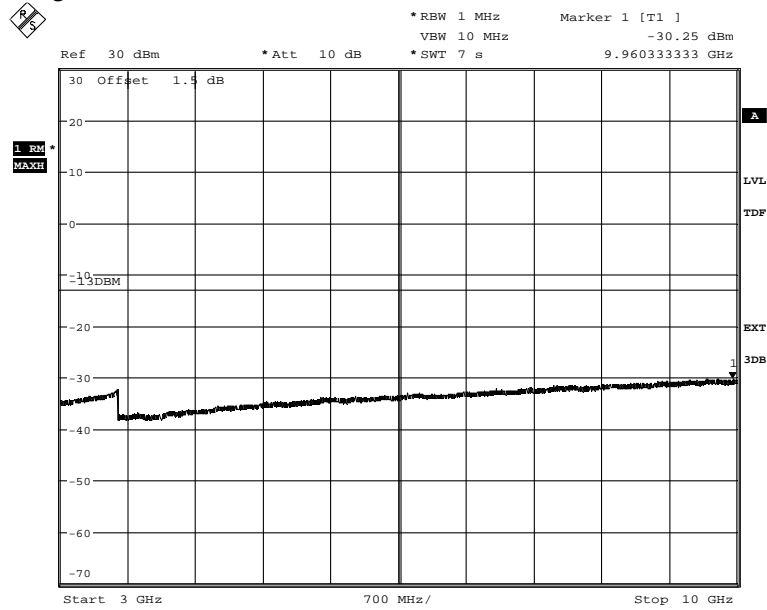

Date: 29.AUG.2014 08:55:18

Diagram 9 d:

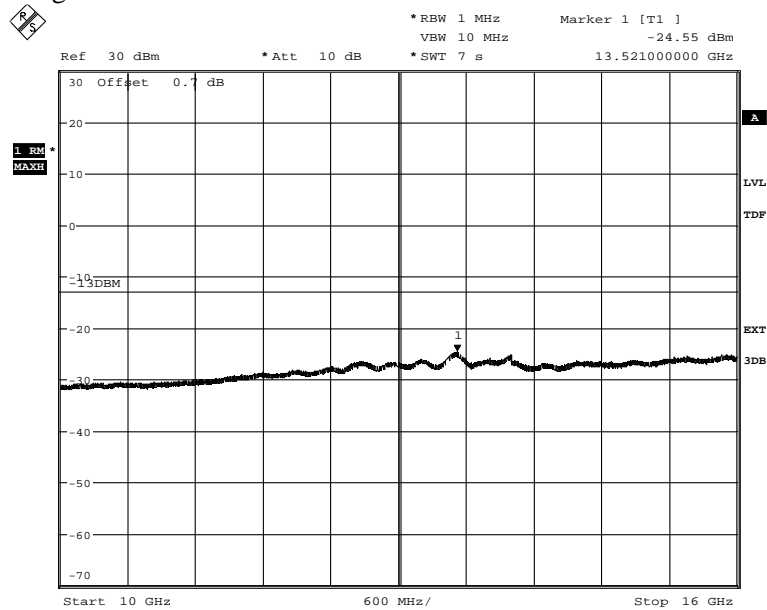

Date: 29.AUG.2014 08:54:21

Appendix 3

Diagram 9 e:

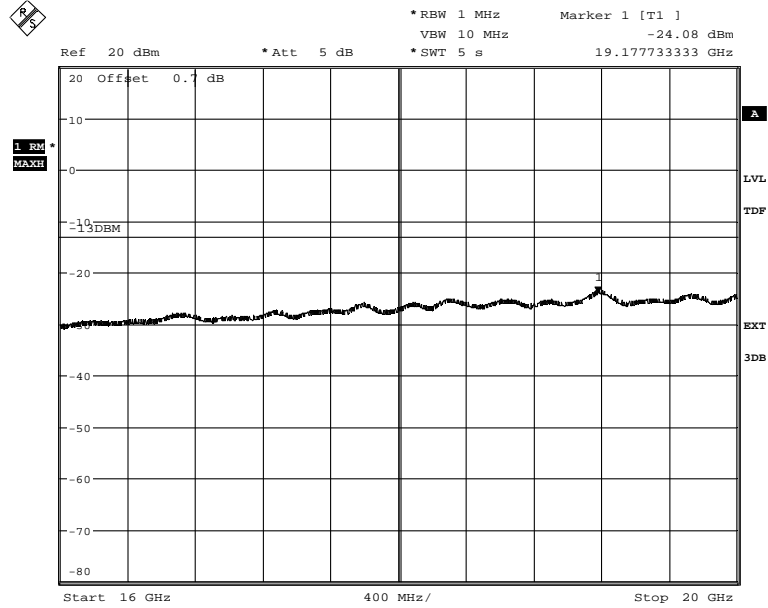

Date: 29.AUG.2014 08:53:13

Appendix 3

Diagram 10 a:

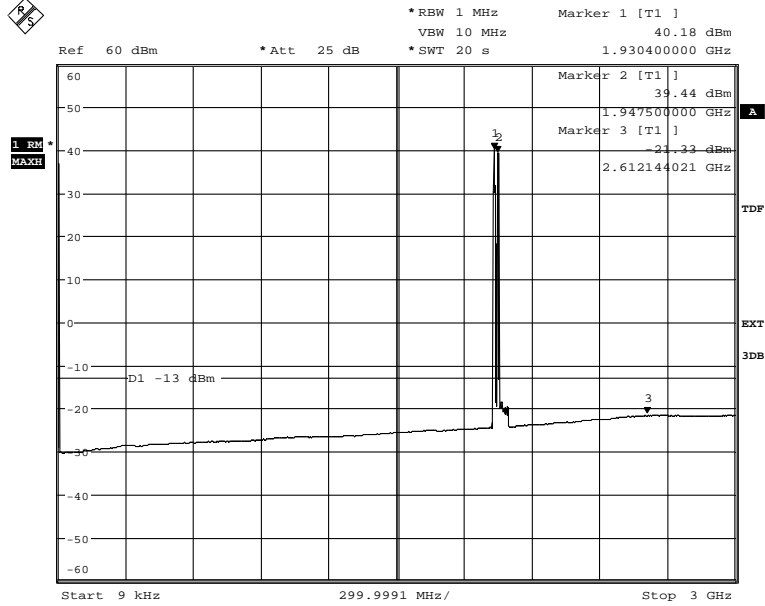

Date: 28.AUG.2014 14:15:54

Diagram 10 b:

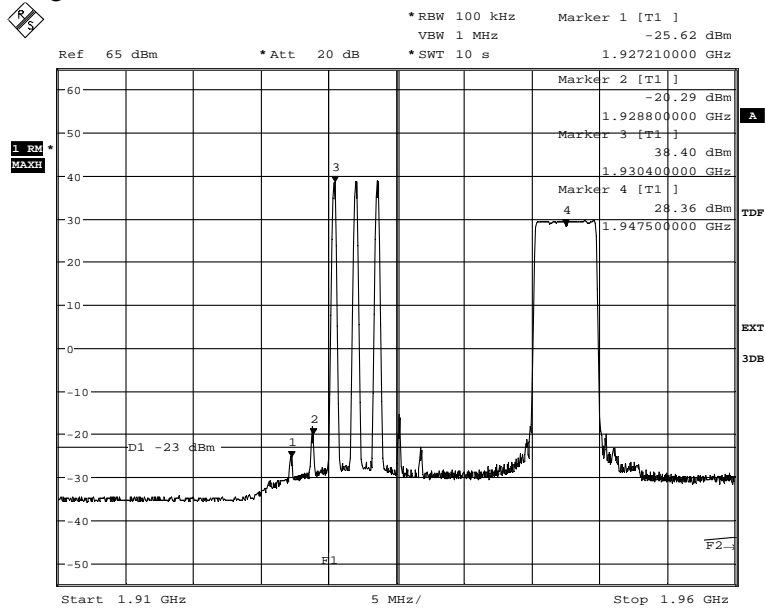

Date: 28.AUG.2014 14:10:55

The emission at 1927.21 MHz was -20.83 dBm and the emission at 1928.8 MHz was -16.09 dBm, measured with the channel power method with 1 MHz channel bandwidth. The result should be compared to the limit -13 dBm.

Appendix 3

Diagram 10 c:

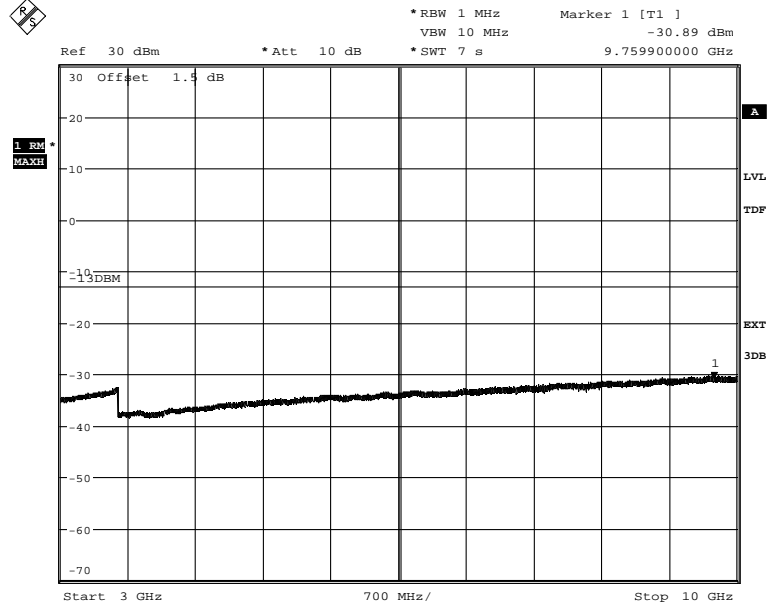

Date: 28.AUG.2014 14:01:06

Diagram 10 d:

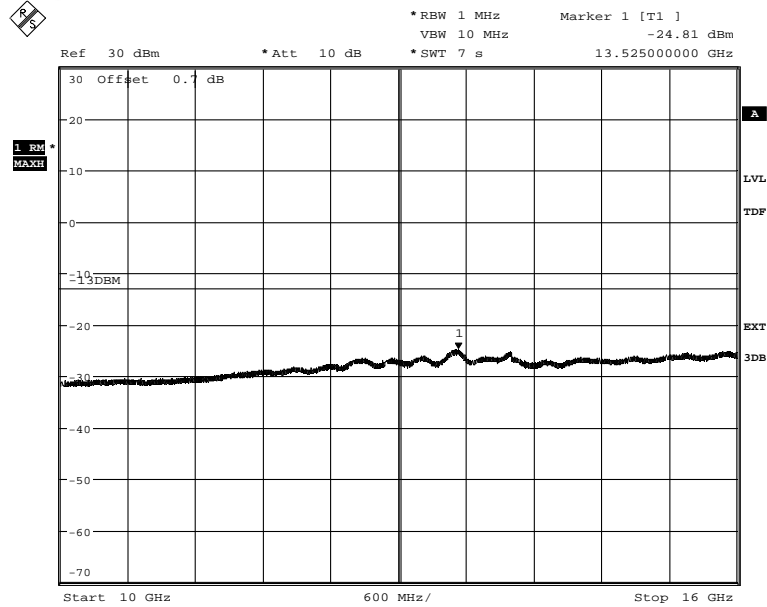

Date: 28.AUG.2014 14:02:10

Appendix 3

Diagram 10 e:

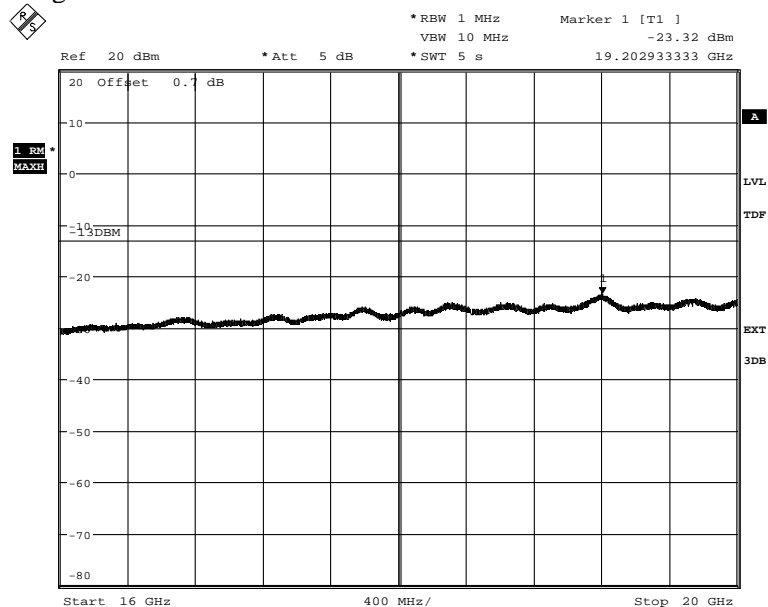

Date: 28.AUG.2014 14:03:06

Appendix 3

Diagram 11 a:

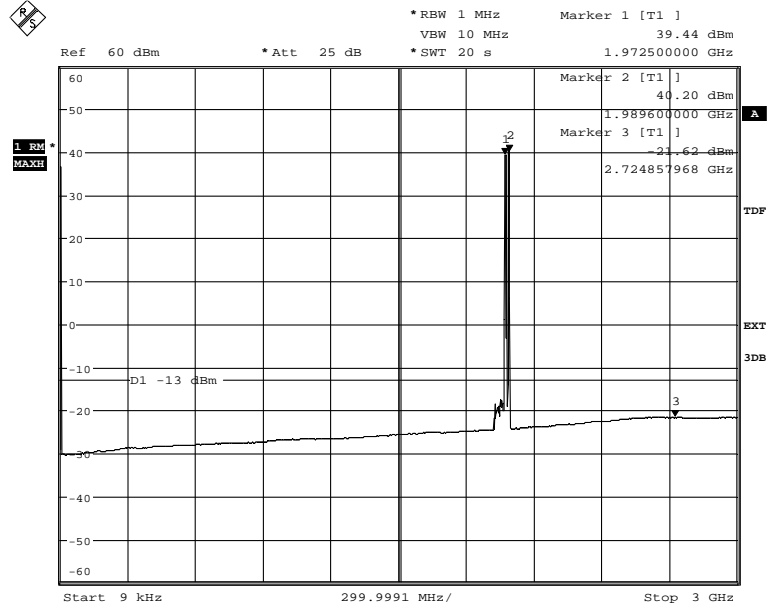

Date: 28.AUG.2014 13:52:22

Diagram 11 b:

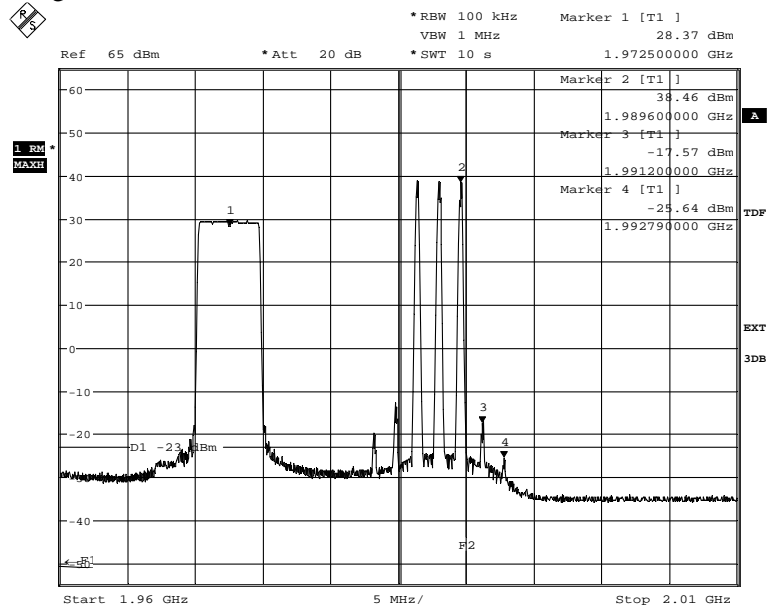

Date: 28.AUG.2014 13:44:01

The emission at 1991.2 MHz was -14.38 dBm and the emission at 1992.79 MHz was -20.62 dBm, measured with the channel power method with 1 MHz channel bandwidth. The result should be compared to the limit -13 dBm.

Appendix 3

Diagram 11 c:

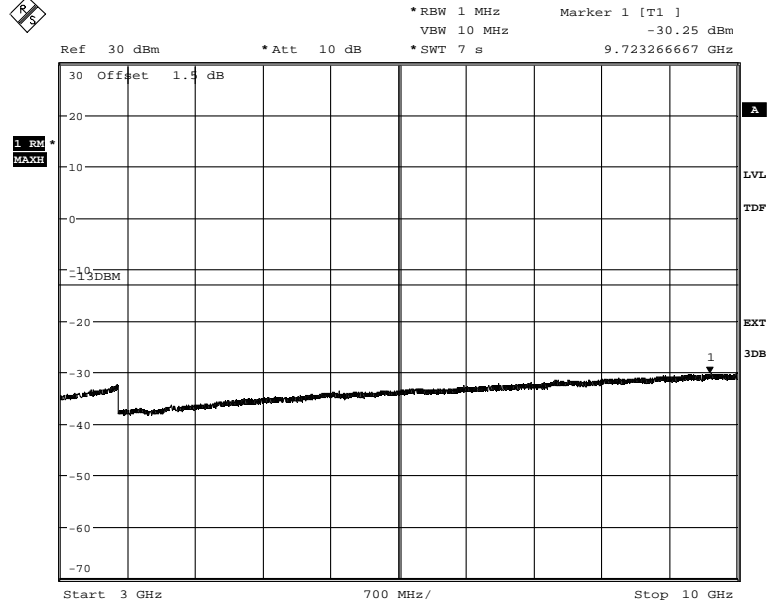

Date: 28.AUG.2014 13:56:17

Diagram 11 d:

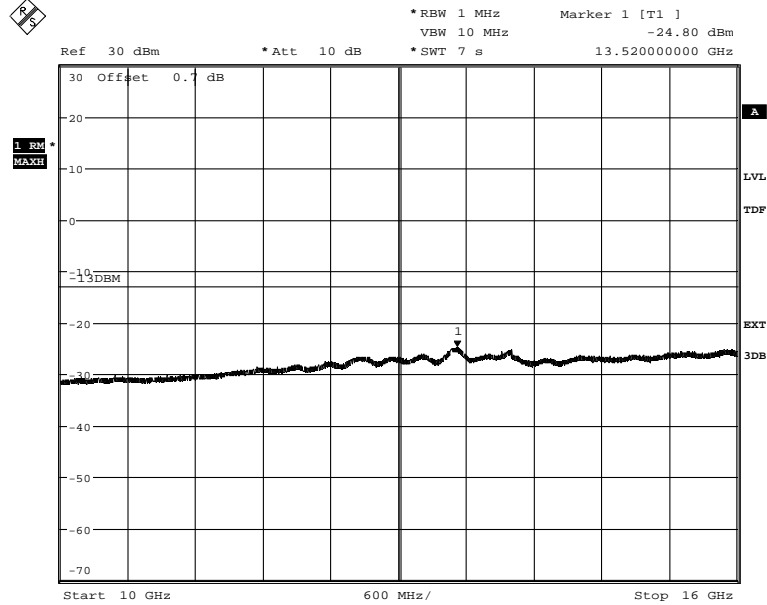

Date: 28.AUG.2014 13:57:11

Appendix 3

Diagram 11 e:

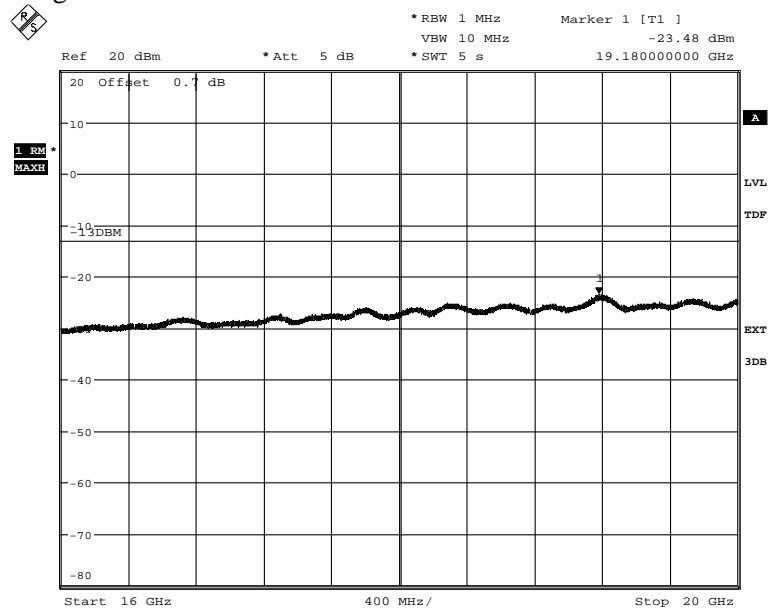

Date: 28.AUG.2014 13:58:04

Appendix 3

Diagram 12 a:

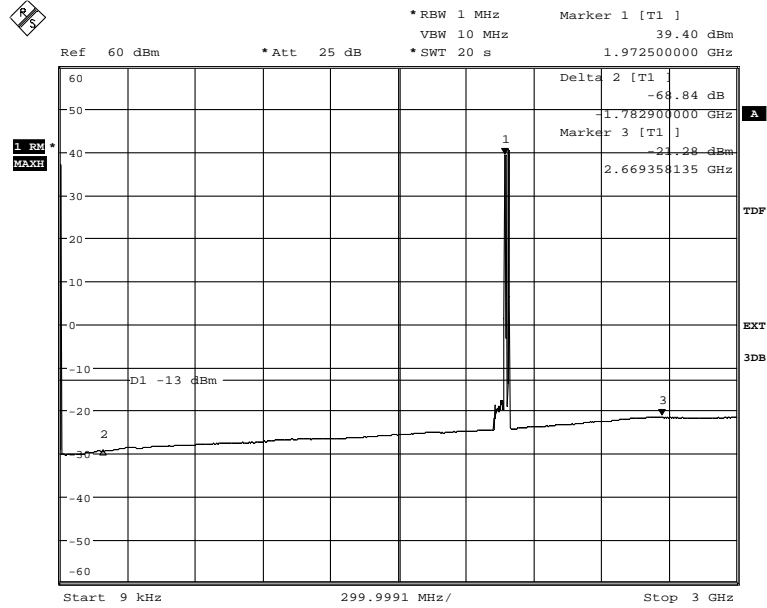

Date: 29.AUG.2014 09:59:25

Diagram 12 b:

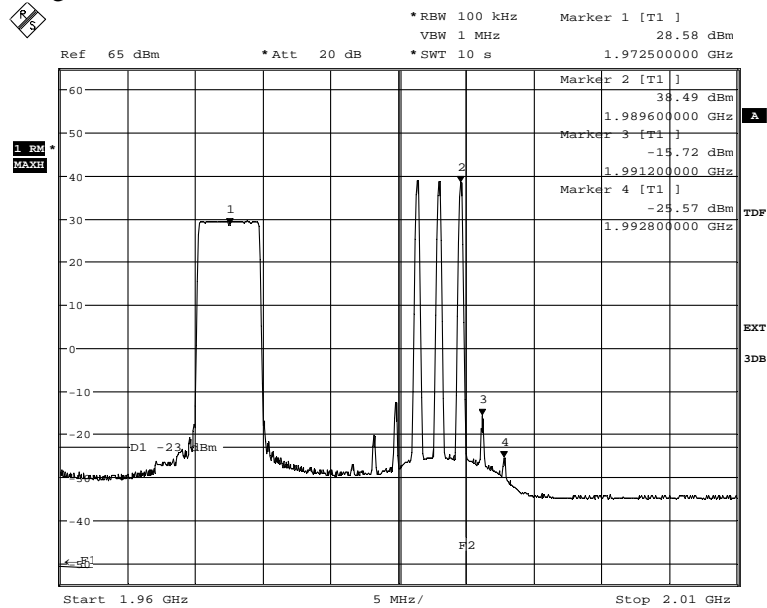

Date: 29.AUG.2014 09:54:31

The emission at 1991.2 MHz was -14.55 dBm and the emission at 1992.8 MHz was -20.56 dBm, measured with the channel power method with 1 MHz channel bandwidth. The result should be compared to the limit -13 dBm.

Appendix 3

Diagram 12 c:

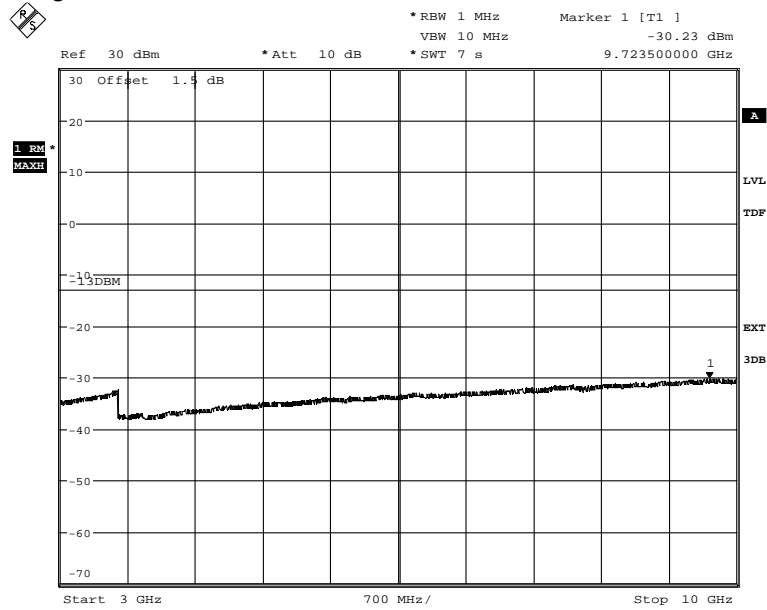

Date: 29.AUG.2014 10:38:51

Diagram 12 d:

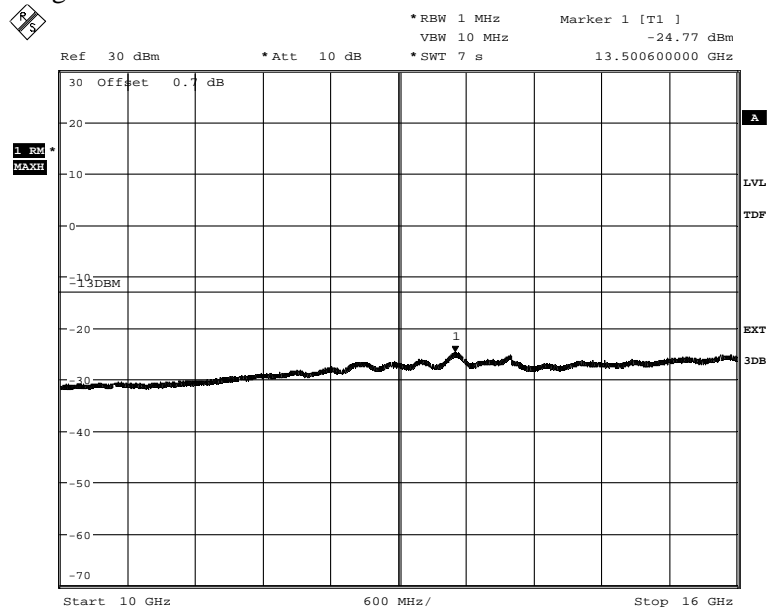

Date: 29.AUG.2014 10:39:59

Appendix 3

Diagram 12 e:

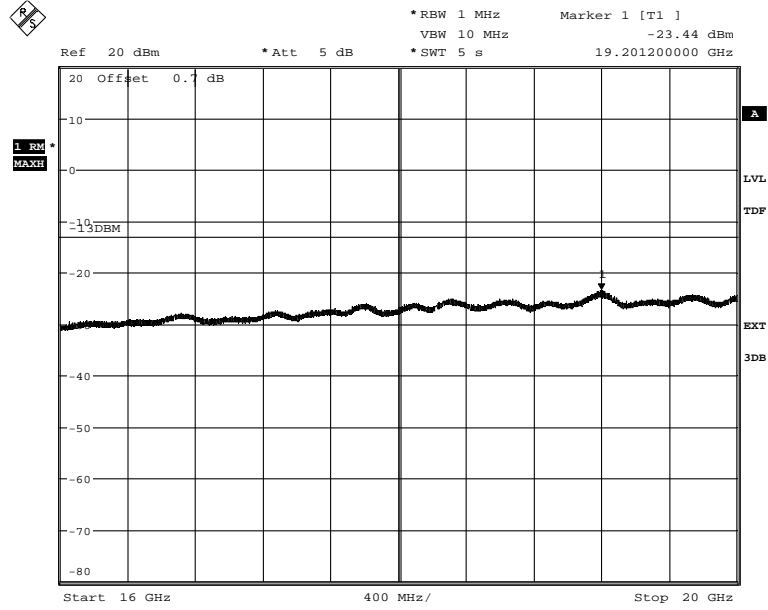

Date: 29.AUG.2014 10:40:53

Appendix 4

Field strength of spurious radiation measurements according to 47 CFR 2.1053 / IC RSS-133 6.5

Date	Temperature	Humidity
2014-08-26	24 °C ± 3 °C	39 % ± 5 %
2014-08-27	24 °C ± 3 °C	41 % ± 5 %

Test set-up and procedure

The test sites are listed at FCC, Columbia with registration number: 93866. The test site complies with RSS-Gen, Industry Canada file no. 3482A-1.

The measurements were performed with both horizontal and vertical polarization of the antenna. The antenna distance was 3 m in the frequency range 30 MHz – 18 GHz and 1m in the frequency range 18 - 20 GHz.

In the frequency range 30 MHz - 20 GHz the measurement was performed in power with a RBW of 1 MHz. A propagation loss in free space was calculated. The used formula was

$$\gamma = 20 \log \left(\frac{4\pi D}{\lambda} \right), \gamma \text{ is the propagation loss and } D \text{ is the antenna distance.}$$

The measurement procedure was as the following:

1. The pre-measurement is performed with peak detector. For measurement < 1 GHz the test object is measured in eight directions with the antenna at three heights, 1.0 m, 1.5 m and 2.0. For measurements > 1 GHz the test object is measured in seventeen directions with the antenna at three heights, 1.0 m, 1.5 m and 2.0.
2. Spurious radiation on frequencies closer than 20 dB to the limit in the pre-measurement is scanned 0-360 degrees and the antenna is scanned 1- 4 m for maximum response. The emission is then measured with the RMS detector and the RMS value is reported. Frequencies closer than 10 dB to the limit when measured with the RMS detector were measured with the substitution method according to the standard.

Appendix 4

The test set-up during the spurious radiation measurements is shown in the picture below:

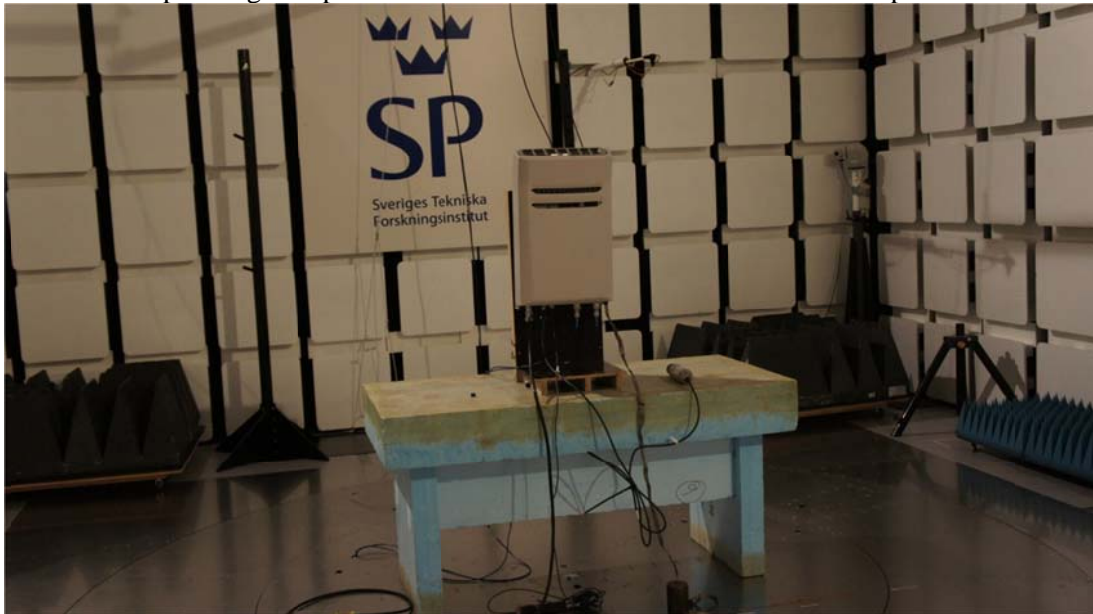

Measurement equipment

Measurement equipment	SP number
Semi anechoic chamber	503 881
R&S ESU 26	901 553
R&S ESIB 26	503 292
EMC 32 ver. 8.52.0	503 899
Chase Bilog Antenna CBL 6111A	503 182
EMCO Horn Antenna 3115	502 175
Flann 20240-20, std gain horn antenna	503 674
High pass filter, RLC Electronics	503 739
Miteq, Low Noise Amplifier	503 285
µComp Nordic, Low Noise Amplifier	901 545
Temperature and humidity meter, Testo 625	504 188

Tested configurations

Symbolic name
Config 1a
Config 1b
Config 2
Config 3
Config 4
Config 5
Config 6

Appendix 4

Results for worst emissions found

Diagram	Symbolic name
1 a-d	Config 6

Before comparing the results to the limit, 3 dB [10 log (2)] should be added according to method E), 3), (iii) “measure and add 10 log(N_{ANT})” of FCC KDB662911 D01 Multiple Transmitter Output v02r01 The 3 dB should not be added to the spurious emissions related to GSM carriers as GSM do not operate in TX diversity/ MIMO mode.

Frequency (MHz)	Spurious emission level (dBm)	
	Vertical	Horizontal
30-20000	All emission > 20 dB below limit	All emission > 20 dB below limit

Measurement uncertainty:

3.2 dB up to 18 GHz, 3.6 dB above 18 GHz

Limits

CFR 47 §24.238 and IC RSS-133 6.5

Outside a licensee's frequency band(s) of operation the power of any emission shall be attenuated below the transmitter power (P) by at least 43 + 10 log (P) dB, resulting in a limit of -13 dBm.

Complies?	Yes
-----------	-----

Appendix 4

Diagram 1 a:

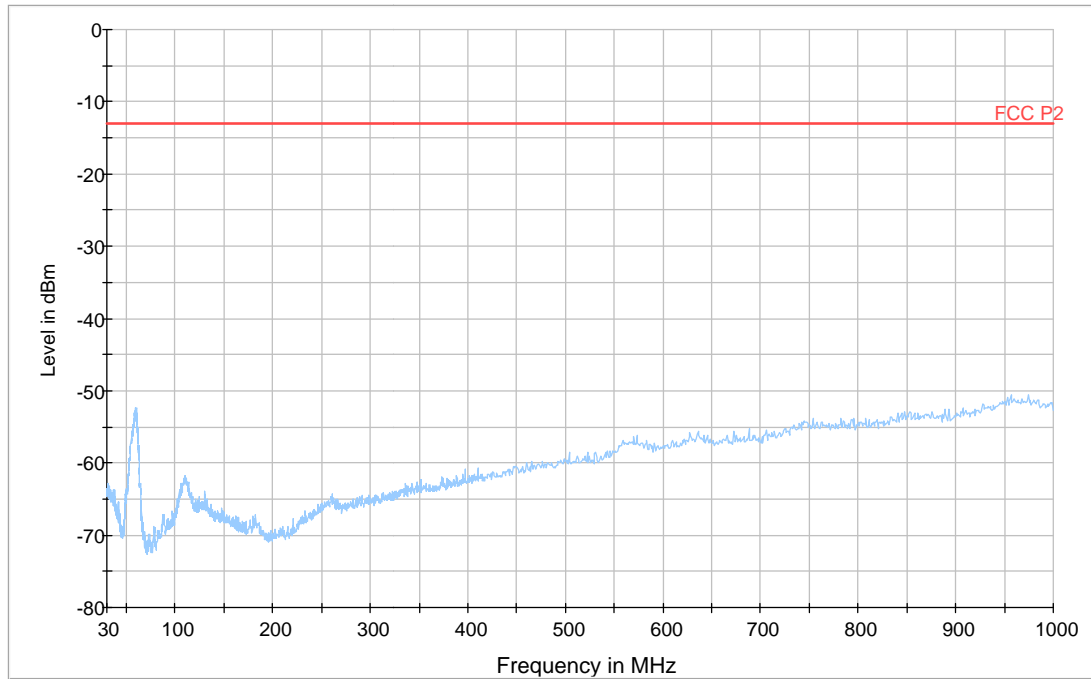
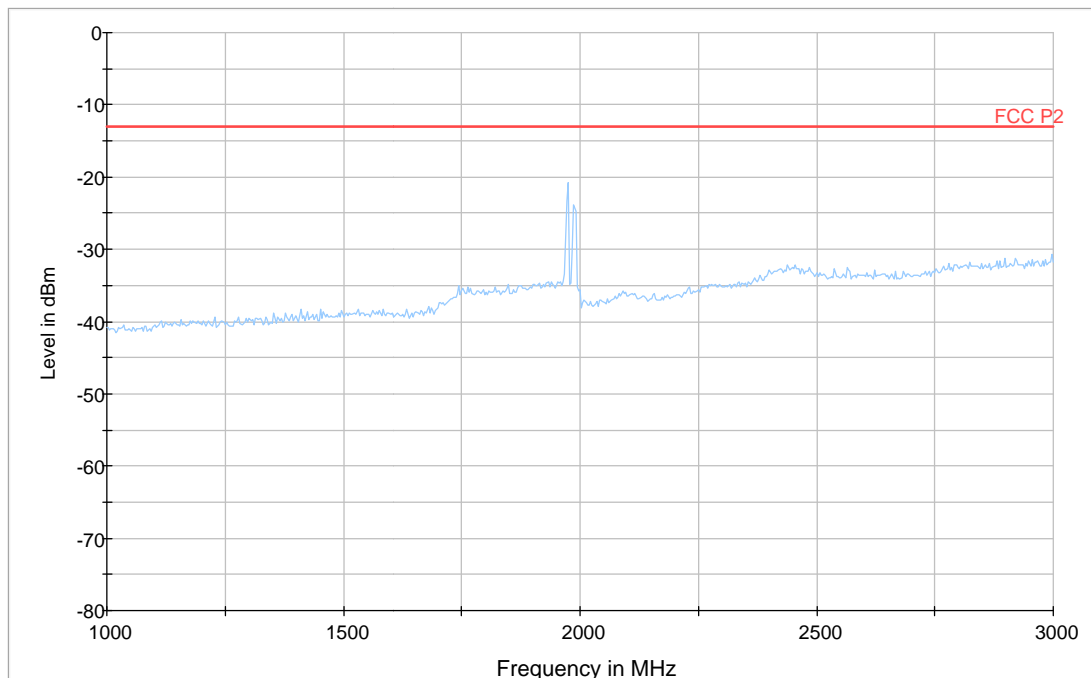

Diagram 1 b:



Note: The emission between 1930 MHz and 1990 MHz are the carrier frequencies and shall be ignored in the context.

Appendix 4

Diagram 1 c:

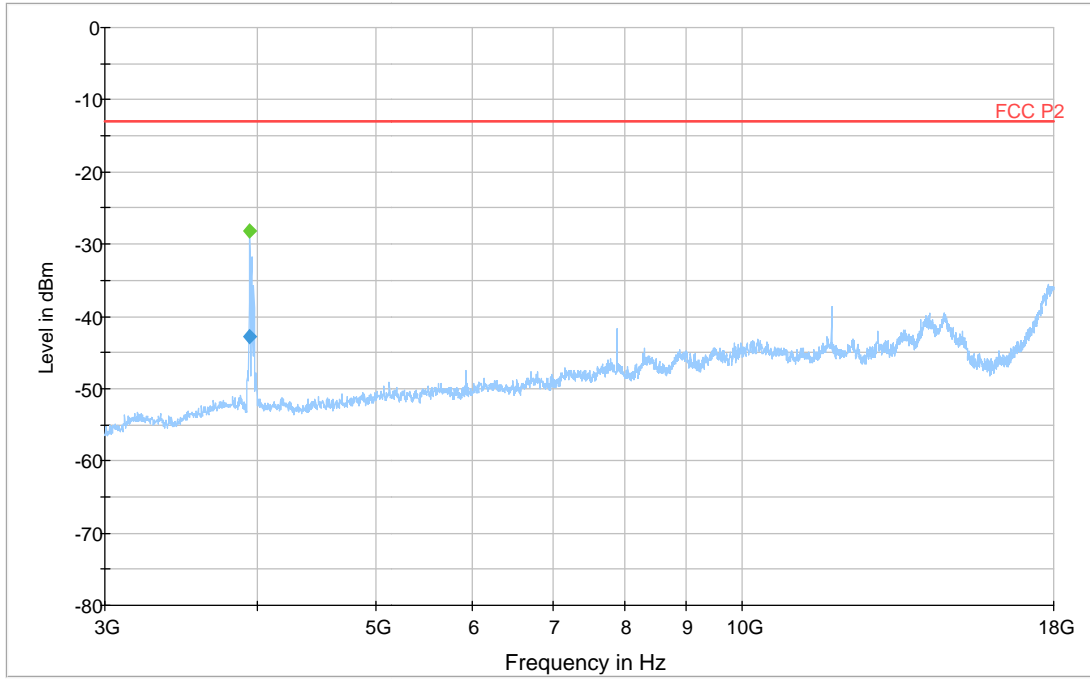

Final RMS Result

Frequency (MHz)	RMS (dBm)	Meas. Time (ms)	Bandwidth (kHz)	Height (cm)	Polarization	Azimuth (deg)	Corr. (dB)	Margin (dB)	Limit (dBm)
3944.778	-42.8	5000.0	1000.000	185.0	H	324.0	-104.3	29.8	-13.0

Appendix 4

Diagram 1 d:

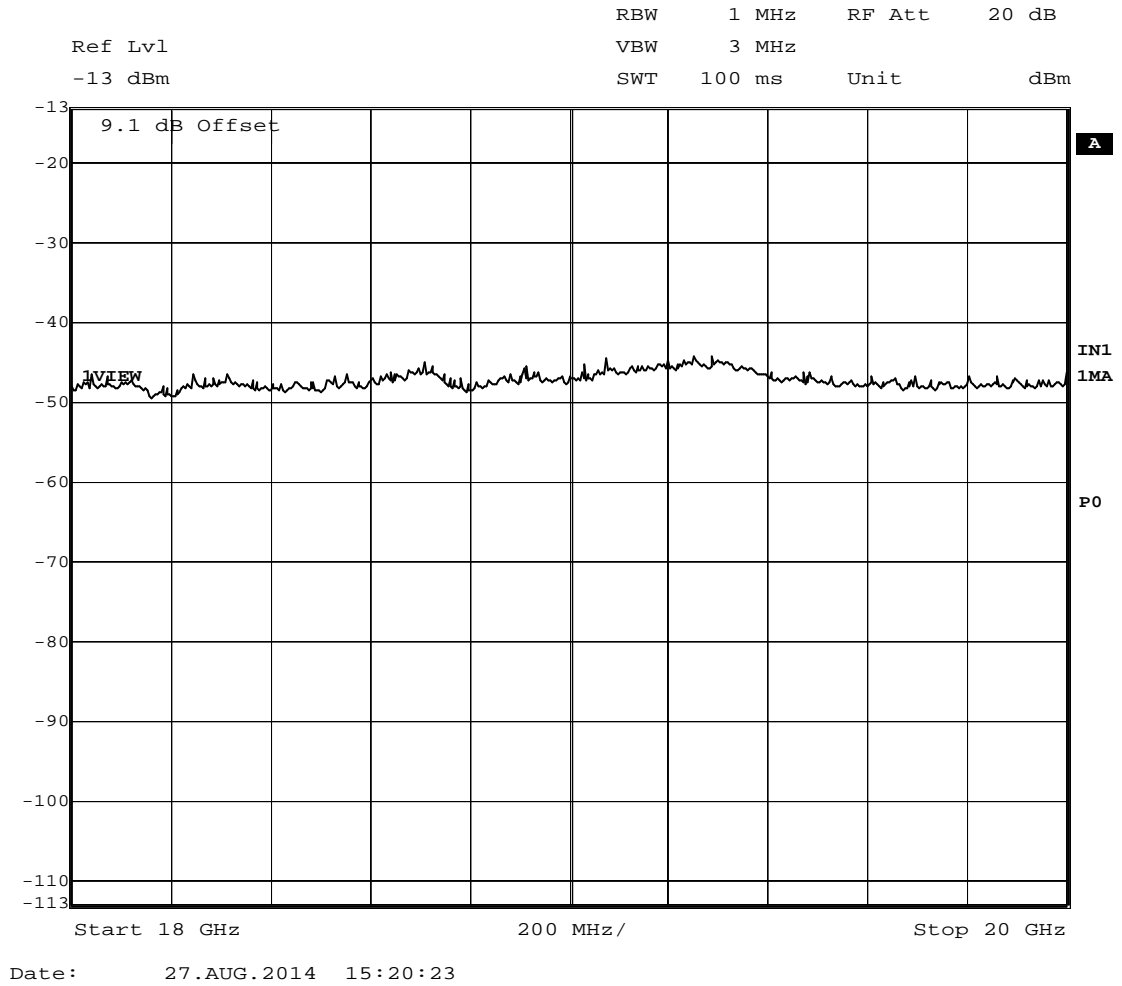

Appendix 5

External photos

Front side:



Back side:



Left side:



Right side:



Appendix 5

Top side:



Bottom side:



Product Label:

