



Product Service

---

**Choose certainty.  
Add value.**

# Report On

FCC and Industry Canada Testing of the  
Ericsson RRUS 01 B2 / KRC 118 74/2

COMMERCIAL-IN-CONFIDENCE

FCC ID: TA8AKRC11874-2

IC ID: 287AB-AS118742

Document 75913966 Report 01 Issue 1

August 2011





Product Service

TÜV SÜD Product Service Ltd, Octagon House, Concorde Way, Segensworth North,  
Fareham, Hampshire, United Kingdom, PO15 5RL  
Tel: +44 (0) 1489 558100. Website: [www.tuvps.co.uk](http://www.tuvps.co.uk)

COMMERCIAL-IN-CONFIDENCE

**REPORT ON**

FCC and Industry Canada Testing of the  
Ericsson RRUS 01 B2 / KRC 118 74/2

Document 75913966 Report 01 Issue 1

August 2011

**PREPARED FOR**

Ericsson AB  
Torshamnsgatan 23  
SE-164 80  
Stockholm  
Sweden

**PREPARED BY**

  
\_\_\_\_\_  
**Q Li**  
Test Engineer

**APPROVED BY**

  
\_\_\_\_\_  
**M J Hardy**  
Authorised Signatory

**DATED**

23 August 2011

---

**ENGINEERING STATEMENT**

The measurements shown in this report were made in accordance with the procedures described on test pages. All reported testing was carried out on a sample equipment to demonstrate compliance with FCC CFR 47: Part 24 and Industry Canada RSS-133. The sample tested was found to comply with the requirements defined in the applied rules.

Test Engineer(s);

  
\_\_\_\_\_  
X Zhang

  
\_\_\_\_\_  
Q Li





## CONTENTS

Section	Page No
<b>1</b>	<b>REPORT SUMMARY ..... 3</b>
1.1	Introduction ..... 4
1.2	Brief Summary of Results ..... 5
1.3	Declaration of Build Status ..... 9
1.4	Product Information ..... 10
1.5	Test Conditions ..... 15
1.6	Deviations From the Standard ..... 15
1.7	Modification Record ..... 15
1.8	Alternative Test Site ..... 15
<b>2</b>	<b>TEST DETAILS ..... 16</b>
2.1	Maximum Peak Output Power - Conducted ..... 17
2.2	Peak – Average Ratio ..... 22
2.3	Modulation Characteristics ..... 46
2.4	Occupied Bandwidth ..... 50
2.5	Spurious Emissions at Antenna Terminals ( $\pm 1$ MHz) ..... 55
2.6	Radiated Spurious Emissions ..... 65
2.7	Conducted Spurious Emissions ..... 71
2.8	Frequency Stability Under Temperature Variations ..... 82
2.9	Frequency Stability Under Voltage Variations ..... 84
2.10	Receiver Spurious Emissions ..... 86
<b>3</b>	<b>TEST EQUIPMENT USED ..... 91</b>
3.1	Test Equipment Used ..... 92
3.2	Measurement Uncertainty ..... 94
<b>4</b>	<b>ACCREDITATION, DISCLAIMERS AND COPYRIGHT ..... 95</b>
4.1	Accreditation, Disclaimers and Copyright ..... 96



## **SECTION 1**

### **REPORT SUMMARY**

FCC and Industry Canada Testing of the  
Ericsson RRUS 01 B2 / KRC 118 74/2



## 1.1 INTRODUCTION

The information contained in this report is intended to show verification of the Ericsson RRUS 01 B2 / KRC 118 74/2 to the requirements of FCC CFR 47 Part 24 and Industry Canada RSS-133.

Testing was carried out in support of an application for Grant of Equipment Authorisation in the name of RRUS 01 B2 / KRC 118 74/2.

Objective	To perform FCC and Industry Canada Testing to determine the Equipment Under Test's (EUT's) compliance with the Test Specification, for the series of tests carried out.
Manufacturer	Ericsson AB
Product Name	RRUS 01 B2
Product Number	KRC 118 74/2
IC Model Number	AS118742
Serial Number(s)	CB4J458260
Software Version	CXP 104 00 13/06 (G12AG7) REV P4BB
Hardware Version	R1A
Number of Samples Tested	1
Test Specification/Issue/Date	FCC CFR 47 Part 24: 2010 Industry Canada RSS-133 Issue 5: 2009
Incoming Release Date	Declaration of Build Status 23 May 2011
Order Number Date	PTP 16 May 2011
Start of Test	10 June 2011
Finish of Test	10 August 2011
Name of Engineer(s)	X Zhang Q Li
Related Document(s)	ANSI C63.4: 2009 FCC CFR 47 Part 2: 2010 Industry Canada RSS-GEN Issue 3: 2010



1.2 BRIEF SUMMARY OF RESULTS

A brief summary of results in accordance with FCC CFR 47 Part 24 and Industry Canada RSS-133, is shown below.

Configuration 1 – Radio Equipment							
Section	Spec Clause		Test Description	Mode	Mod State	Result	Comments
	FCC Part 2 and 24	RSS-133 and RSS-GEN					
	24.232 (a)	6.4	Effective Radiated Power	1930.2MHz		N/A	No integral antenna.
				1960.0MHz		N/A	
				1989.8MHz		N/A	
				1930.2MHz + 1940.0MHz		N/A	
				1960.0MHz + 1969.8MHz		N/A	
				1980.0MHz + 1989.8MHz		N/A	
				1930.2MHz + 1933.2MHz + 1937.2MHz + 1940.0MHz		N/A	
				1957.0MHz + 1960.0MHz + 1964.0MHz + 1966.8MHz		N/A	
1980.0MHz + 1982.8MHz + 1986.8MHz + 1989.8MHz		N/A					
2.1	2.1046, 24.232 (a)	6.4	Maximum Peak Output Power - Conducted	1930.2MHz	0	Pass	-
				1960.0MHz	0	Pass	
				1989.8MHz	0	Pass	
				1930.2MHz + 1940.0MHz	0	Pass	
				1960.0MHz + 1969.8MHz	0	Pass	
				1980.0MHz + 1989.8MHz	0	Pass	
				1930.2MHz + 1933.2MHz + 1937.2MHz + 1940.0MHz	0	Pass	
				1957.0MHz + 1960.0MHz + 1964.0MHz + 1966.8MHz	0	Pass	
1980.0MHz + 1982.8MHz + 1986.8MHz + 1989.8MHz	0	Pass					
2.2	24.232 (d)	-	Peak – Average Ratio	1930.2MHz	0	Pass	-
				1960.0MHz	0	Pass	
				1989.8MHz	0	Pass	
				1930.2MHz + 1940.0MHz	0	Pass	
				1960.0MHz + 1969.8MHz	0	Pass	
				1980.0MHz + 1989.8MHz	0	Pass	
				1930.2MHz + 1933.2MHz + 1937.2MHz + 1940.0MHz	0	Pass	
				1957.0MHz + 1960.0MHz + 1964.0MHz + 1966.8MHz	0	Pass	
1980.0MHz + 1982.8MHz + 1986.8MHz + 1989.8MHz	0	Pass					



Configuration 1 – Radio Equipment							
Section	Spec Clause		Test Description	Mode	Mod State	Result	Comments
	FCC Part 2 and 24	RSS-133 and RSS-GEN					
2.3	2.1047 (d)	6.2	Modulation Characteristics	1930.2MHz		N/A	-
				1960.0MHz	0	Pass	
				1989.8MHz		N/A	
				1930.2MHz + 1940.0MHz		N/A	
				1960.0MHz + 1969.8MHz		N/A	
				1980.0MHz + 1989.8MHz		N/A	
				1930.2MHz + 1933.2MHz + 1937.2MHz + 1940.0MHz		N/A	
				1957.0MHz + 1960.0MHz + 1964.0MHz + 1966.8MHz		N/A	
1980.0MHz + 1982.8MHz + 1986.8MHz + 1989.8MHz		N/A					
2.4	2.1049, 24.238 (b)	RSS-Gen 4.6.1	Occupied Bandwidth	1930.2MHz	0	Pass	-
				1960.0MHz	0	Pass	
				1989.8MHz	0	Pass	
				1930.2MHz + 1940.0MHz		N/A	
				1960.0MHz + 1969.8MHz		N/A	
				1980.0MHz + 1989.8MHz		N/A	
				1930.2MHz + 1933.2MHz + 1937.2MHz + 1940.0MHz		N/A	
				1957.0MHz + 1960.0MHz + 1964.0MHz + 1966.8MHz		N/A	
1980.0MHz + 1982.8MHz + 1986.8MHz + 1989.8MHz		N/A					
2.5	2.1051, 24.238 (b)	6.5	Spurious Emissions at Antenna Terminals (±1MHz)	1930.4MHz	0	Pass	The channel adjacent to the lower and higher band-edge cannot be used. The lowest usable channel is 513 (1930.4MHz), the highest usable channel is 809 (1989.6MHz)
				1960.0MHz		N/A	
				1989.6MHz	0	Pass	
				1930.4MHz + 1930.8MHz	0	Pass	
				1960.0MHz + 1969.8MHz		N/A	
				1989.2MHz + 1989.6MHz	0	Pass	
				1930.4MHz + 1930.8MHz + 1931.2MHz + 1931.6MHz		N/A	
				1957.0MHz + 1960.0MHz + 1964.0MHz + 1966.8MHz		N/A	
1988.4MHz + 1988.8MHz + 1989.2MHz + 1989.6MHz		N/A					



Configuration 1 – Radio Equipment							
Section	Spec Clause		Test Description	Mode	Mod State	Result	Comments
	FCC Part 2 and 24	RSS-133 and RSS-GEN					
2.6	2.1053, 24.238 (a)	6.5	Radiated Spurious Emissions	1930.2MHz		N/A	-
				1960.0MHz	0	Pass	
				1989.8MHz		N/A	
				1930.2MHz + 1940.0MHz	0	Pass	
				1960.0MHz + 1969.8MHz	0	Pass	
				1980.0MHz + 1989.8MHz	0	Pass	
				1930.2MHz + 1933.2MHz + 1937.2MHz + 1940.0MHz		N/A	
				1957.0MHz + 1960.0MHz + 1964.0MHz + 1966.8MHz	0	Pass	
1980.0MHz + 1982.8MHz + 1986.8MHz + 1989.8MHz		N/A					
2.7	2.1051, 24.238 (a)	6.5	Conducted Spurious Emissions	1930.2MHz	0	Pass	-
				1960.0MHz	0	Pass	
				1989.8MHz	0	Pass	
				1930.2MHz + 1940.0MHz		N/A	
				1960.0MHz + 1969.8MHz		N/A	
				1980.0MHz + 1989.8MHz		N/A	
				1930.2MHz + 1933.2MHz + 1937.2MHz + 1940.0MHz		N/A	
				1957.0MHz + 1960.0MHz + 1964.0MHz + 1966.8MHz		N/A	
1980.0MHz + 1982.8MHz + 1986.8MHz + 1989.8MHz		N/A					
2.8	2.1055, 24.235	6.3	Frequency Stability Under Temperature Variations	1930.2MHz		N/A	-
				1960.0MHz	0	Pass	
				1989.8MHz		N/A	
				1930.2MHz + 1940.0MHz		N/A	
				1960.0MHz + 1969.8MHz		N/A	
				1980.0MHz + 1989.8MHz		N/A	
				1930.2MHz + 1933.2MHz + 1937.2MHz + 1940.0MHz		N/A	
				1957.0MHz + 1960.0MHz + 1964.0MHz + 1966.8MHz		N/A	
1980.0MHz + 1982.8MHz + 1986.8MHz + 1989.8MHz		N/A					





Configuration 1 – Radio Equipment							
Section	Spec Clause		Test Description	Mode	Mod State	Result	Comments
	FCC Part 2 and 24	RSS-133 and RSS-GEN					
2.9	2.1055, 24.235	6.3	Frequency Stability Under Voltage Variations	1930.2MHz		N/A	-
				1960.0MHz	0	Pass	
				1989.8MHz		N/A	
				1930.2MHz + 1940.0MHz		N/A	
				1960.0MHz + 1969.8MHz		N/A	
				1980.0MHz + 1989.8MHz		N/A	
				1930.2MHz + 1933.2MHz + 1937.2MHz + 1940.0MHz		N/A	
				1957.0MHz + 1960.0MHz + 1964.0MHz + 1966.8MHz		N/A	
1980.0MHz + 1982.8MHz + 1986.8MHz + 1989.8MHz		N/A					
2.10	-	6.6	Receiver Spurious Emissions	1930.2MHz		N/A	-
				1960.0MHz	0	Pass	
				1989.8MHz		N/A	
				1930.2MHz + 1940.0MHz		N/A	
				1960.0MHz + 1969.8MHz		N/A	
				1980.0MHz + 1989.8MHz		N/A	
				1930.2MHz + 1933.2MHz + 1937.2MHz + 1940.0MHz		N/A	
				1957.0MHz + 1960.0MHz + 1964.0MHz + 1966.8MHz		N/A	
1980.0MHz + 1982.8MHz + 1986.8MHz + 1989.8MHz		N/A					

N/A – Not Applicable



## 1.3 DECLARATION OF BUILD STATUS

MAIN EUT						
MANUFACTURING DESCRIPTION	Radio Equipment					
MANUFACTURER	Ericsson AB					
PRODUCT NUMBER	RRUS 01 B2					
PART NUMBER	KRC 118 74/2					
IC Model NUMBER	AS118742					
SERIAL NUMBER	CB4J458260					
HARDWARE VERSION	R1A					
SOFTWARE VERSION	CXP 104 00 13/06 (G12AG7) REV P4BB					
TRANSMITTER OPERATING RANGE	TX: 1930.4MHz - 1989.6MHz RX: 1850.4MHz - 1909.6MHz					
MODULATIONS	GMSK, 8PSK, 16QAM, 32QAM, AQPSK					
INTERMEDIATE FREQUENCIES	--					
ITU DESIGNATION OF EMISSION	250KGXW 250KG7W					
OUTPUT POWER (RMS) (W or dBm)		GSMK	8PSK	16QAM	32QAM	AQPSK
	Single Carrier:	1x47.8dBm (1x60W)				
	Multi Carrier (x 2):	2x46.0dBm (2x40.0W)	2x46.0dBm (2x40.0W)	2x45.7dBm (2x37.2W)	2x45.3dBm (2x33.9W)	2x46.0dBm (2x40.0W)
	Multi Carrier (x 4):	4x43.0dBm (4 x20.0W)	4x41.1dBm (4 x12.9W)	4x39.7dBm (4 x9.33W)	4x39.3dBm (4 x8.51W)	4x41.0dBm (4 x12.6W)
OUTPUT POWER TOLERANCE	± 1dB					
NUMBER OF ANTENNA PORTS	1 TX/ RX and 1 RX ports					
FCC ID	TA8AKRC11874-2					
IC ID	287AB-AS118742					
TECHNICAL DESCRIPTION (a brief description of the intended use and operation)	The equipment is the Radio Part of GSM Base Station.					

## Signature

Date 18 August 2011  
D of B S Serial No 75913966 /01

No responsibility will be accepted by TÜV SÜD Product Service Ltd as to the accuracy of the information declared in this document by the manufacturer.



## 1.4 PRODUCT INFORMATION

### 1.4.1 Technical Description

The Equipment Under Test (EUT) RRUS 01 B2 / KRC 118 74/2 is an Ericsson Radio Equipment working in the public mobile service 1900MHz band which provides communication connections to GSM1900 network. The RRUS 01 B2 / KRC 118 74/2 operates from a - 48V DC supply.

The Equipment Under Test (EUT) is shown in the photograph below. A full technical description can be found in the Manufacturers documentation.



Equipment Under Test



Product Service

## 1.4.2 Test Configuration

### Configuration 1: Radio Equipment

The EUT was configured in accordance with FCC CFR 47 Part 24 and Industry Canada RSS-133.

The RRUS 01 B2 / KRC 118 74/2 supports GMSK, 8PSK, 16QAM, 32QAM and AQPSK modulations at 1900MHz, the unit includes a TRX port and a RX port. The EUT can be configured to transmit with 1900MHz single or multi carrier at the RF output connector. All Tx Testing was performed on the combined Tx / Rx output connector RF A of the EUT, with RX antenna port RF B terminated, and RX test was performed on the RX connector.

The settings below were found to be representative for all traffic scenarios when several settings with the different modulations were tested to find the worst case setting. The settings were used for all measurements if not otherwise noted:

- GMSK and 8PSK modulations

The complete testing was performed with the EUT transmitting at maximum RF power and the SCPIR is 0dB for AQPSK modulation unless otherwise stated.

The EUT was powered by a -48V DC Power supply.



**Test Setup, Conducted Measurement:**

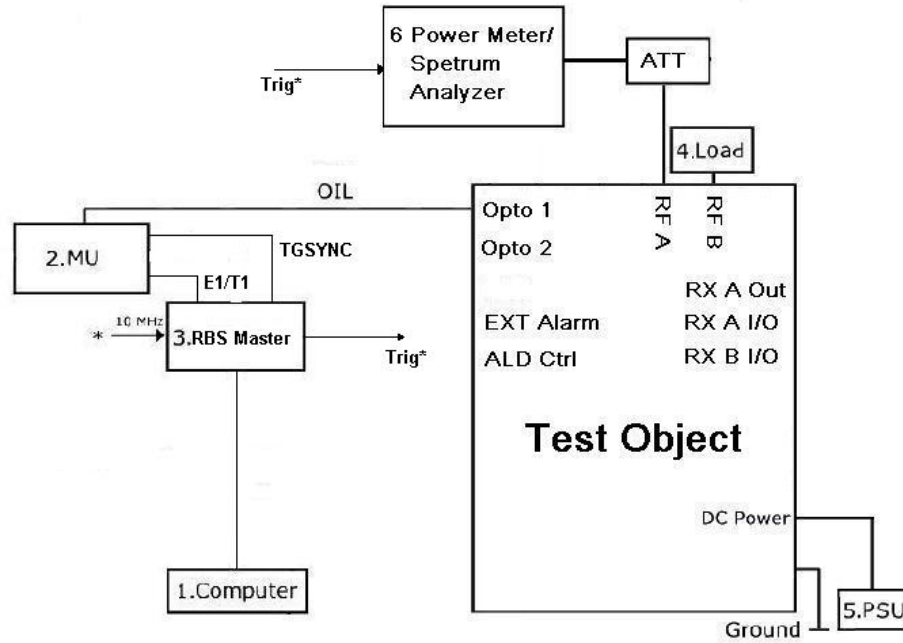

Product Name	Product Number	Version	Serial Number
RRUS 01 B2	KRC 118 74/2	R1A	CB4J458260

No.	Auxiliary Equipment	Part Number / Model Type	Version	Serial Number
1	Computer	Sun Blade 500S	--	0826TFC1VD
2	DUG 20 01( housed in SUP 6601)	KDU 137 569/1	R2B	CB4H322724
3	RBS Master	LPY 1071007/3	R1C	T01E050958
4	Load	TFE150	--	06081402
5	Power Supply	DH1716A-9	--	20070905
	Power Supply	DH1716A-14	--	20080401
6	Power Meter	Rohde & Schwarz NRP	--	102624
	Thermal Power Sensor	Rohde & Schwarz NRP-Z21	--	101644
	Spectrum Analyzer	FSQ26	--	200235
	Signal Analyzer	MXA N9020A	--	MY50200663



**Test Setup, Radiated Measurement:**

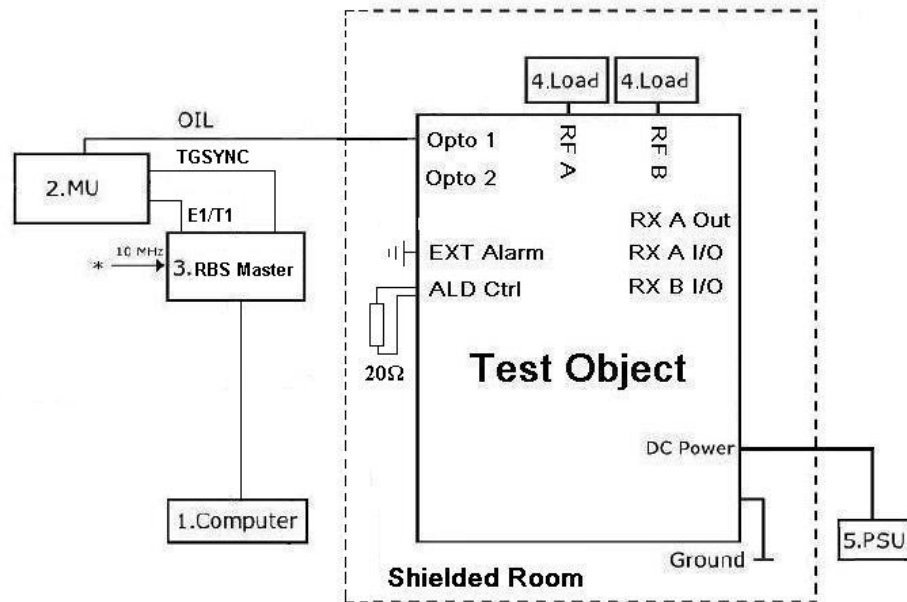

Product Name	Product Number	Version	Serial Number
RRUS 01 B2	KRC 118 74/2	R1A	CB4J458260

No.	Auxiliary Equipment	Part Number / Model Type	Version	Serial Number
1	Computer	Sun Blade 500S	--	0826TFC1VD
2	DUG 20 01( housed in SUP 6601)	KDU 137 569/1	R2B	CB4H322724
3	RBS Master	LPY 1071007/3	R1C	T01E050958
4	Load	TF150	--	06081402
	Load	TFE100-3N	--	09116765
5	Power Supply	DH1716A-9	--	20070905
	Power Supply	DH1716A-14	--	20080401



### 1.4.3 Modes of Operation

Modes of operation of each EUT during testing were as follows:

Mode 1 – ARFCN 512: 1930.2MHz (Bottom Channel)

Mode 2 – ARFCN 661: 1960.0MHz (Middle Channel)

Mode 3 – ARFCN 810: 1989.8MHz (Top Channel)

Mode 4 – ARFCN 512 + 561: 1930.2MHz + 1940.0MHz (B and B+9.8MHz)

Mode 5 – ARFCN 661 + 710: 1960.0MHz + 1969.8MHz (M and M+9.8MHz)

Mode 6 – ARFCN 761 + 810: 1980.0MHz + 1989.8MHz (T-9.8MHz and T)

Mode 7 – ARFCN 512 + 527 + 547 + 561: 1930.2MHz + 1933.2MHz + 1937.2MHz + 1940MHz (B, B+ 3MHz, B+7MHz and B+9.8MHz)

Mode 8 - ARFCN 646 + 661 + 681 + 695:  
1957.0MHz + 1960.0MHz + 1964.0MHz + 1966.8MHz (M-3MHz, M, M+4MHz and M+6.8MHz)

Mode 9 - ARFCN 761 + 775 + 785 + 810:  
1980.0MHz + 1982.8MHz + 1986.8MHz + 1989.8MHz (T-9.8MHz, T-7MHz, T-3MHz and T)

Information on the specific test modes utilised are detailed in the test procedure for each individual test.

For test case Spurious Emissions at Antenna Terminals ( $\pm 1$ MHz), the following modes of operation were used:

Mode 1' – ARFCN 513: 1930.4MHz (B+1 Channel)

Mode 3' – ARFCN 809: 1989.6MHz (T- 1 Channel)

Mode 4' – ARFCN 513 + 515: 1930.4MHz + 1930.8MHz (B +1 and B+3 Channels)

Mode 6' – ARFCN 807 + 809: 1989.2MHz + 1989.6MHz (T-3 and T-1 Channels)

Mode 7' – ARFCN 513 + 515 + 517 + 519:  
1930.4MHz + 1930.8MHz + 1931.2MHz + 1931.6MHz (B+1, B+3, B+5 and B+7 Channels)

Mode 9' – ARFCN 803 + 805 + 807 + 809:  
1988.4MHz + 1988.8MHz + 1989.2MHz + 1989.6MHz (T-7, T-5, T-3 and T-1 Channels)



Product Service

## 1.5 TEST CONDITIONS

For all tests the EUT was set up in accordance with the relevant test standard and to represent typical operating conditions. Tests were applied with the EUT situated in a shielded enclosure, test laboratories or an open test area as appropriate.

The EUT was powered from a -48V DC supply.

## 1.6 DEVIATIONS FROM THE STANDARD

No deviations from the applicable test standards or test plan were made during testing.

## 1.7 MODIFICATION RECORD

No modifications were made to the EUT during testing.

## 1.8 ALTERNATIVE TEST SITE

Testing has been performed under the following site registrations:

FCC Accreditation 910917:

The State Radio Monitoring Centre, No.80 Beilishi Road Xicheng District Beijing, China.

Industry Canada Accreditation 7308A:

The State Radio Monitoring Centre, No.80 Beilishi Road Xicheng District Beijing, China.





Product Service

## **SECTION 2**

### **TEST DETAILS**

FCC and Industry Canada Testing of the  
Ericsson RRUS 01 B2 / KRC 118 74/2



Product Service

## 2.1 MAXIMUM PEAK OUTPUT POWER - CONDUCTED

### 2.1.1 Specification Reference

FCC CFR 47 Part 2.1046  
 FCC CFR 47 Part 24, Clause 24.232 (a)  
 Industry Canada RSS-133, Clause 6.4

### 2.1.2 Equipment Under Test

RRUS 01 B2 / KRC 118 74/2, S/N: CB4J458260

### 2.1.3 Date of Test and Modification State

12 July and 10 August 2011 – Modification State 0

### 2.1.4 Test Equipment Used

The major items of test equipment used for the above tests are identified in Section 3.1.

### 2.1.5 Test Method and Operating Modes

The test was applied in accordance with the test method requirements of FCC CFR 47 Part 2 and Part 24 and Industry Canada RSS-133.

Using a power meter and attenuator(s), the output power of the EUT was measured at the antenna terminal. The carrier power was measured with GMSK, 8PSK, 16QAM, 32QAM and AQPSK modulations.

The path loss was measured and entered as a reference level offset.

The test was performed with the EUT in the following configurations and modes of operation:

Configuration 1 - Mode 1  
 - Mode 2  
 - Mode 3  
 - Mode 4  
 - Mode 5  
 - Mode 6  
 - Mode 7  
 - Mode 8  
 - Mode 9

### 2.1.6 Environmental Conditions

	12 July 2011	10 August 2011
Ambient Temperature	26.3°C	26.4°C
Relative Humidity	59.5%	48.3%



## 2.1.7 Test Results

For the period of test the EUT met the requirements of FCC CFR 47 Part 2 and Part 24 and Industry Canada RSS-133 for Maximum Peak Output Power.

The test results are shown below

### Single Carrier

#### Configuration 1 - Mode 1, 2 and 3

##### GMSK

UARFCN	Frequency (MHz)	Path Loss (dB)	Result (dBm) RMS	Result (W) RMS
512 (Bottom)	1930.2	42.98	47.58	57.28
661 (Middle)	1960.0	42.98	47.90	61.66
810 (Top)	1989.8	42.98	47.40	54.95

##### 8PSK

UARFCN	Frequency (MHz)	Path Loss (dB)	Result (dBm) RMS	Result (W) RMS
512 (Bottom)	1930.2	42.98	47.54	56.75
661 (Middle)	1960.0	42.98	47.82	60.53
810 (Top)	1989.8	42.98	47.61	57.68

##### 16QAM

UARFCN	Frequency (MHz)	Path Loss (dB)	Result (dBm) RMS	Result (W) RMS
512 (Bottom)	1930.2	42.98	47.29	53.58
661 (Middle)	1960.0	42.98	47.58	57.28
810 (Top)	1989.8	42.98	47.23	52.84

##### 32QAM

UARFCN	Frequency (MHz)	Path Loss (dB)	Result (dBm) RMS	Result (W) RMS
512 (Bottom)	1930.2	42.98	47.25	53.09
661 (Middle)	1960.0	42.98	47.53	56.62
810 (Top)	1989.8	42.98	47.29	53.58



Product Service

AQPSK

UARFCN	Frequency (MHz)	Path Loss (dB)	Result (dBm) RMS	Result (W) RMS
512 (Bottom)	1930.2	42.98	47.32	53.95
661 (Middle)	1960.0	42.98	47.65	58.21
810 (Top)	1989.8	42.98	47.35	54.33

**Multi Carrier (1x2)****Configuration 1 - Mode 4, 5 and 6****GMSK**

UARFCN	Frequency (MHz)	Path Loss (dB)	Result (dBm) RMS	Result (W) RMS
512 (Bottom)	1930.2	42.98	45.54	35.81
661 (Middle)	1960.0	42.98	45.80	38.02
810 (Top)	1989.8	42.98	45.53	35.73

**8PSK**

UARFCN	Frequency (MHz)	Path Loss (dB)	Result (dBm) RMS	Result (W) RMS
512 (Bottom)	1930.2	42.98	45.66	36.81
661 (Middle)	1960.0	42.98	45.81	38.11
810 (Top)	1989.8	42.98	45.55	35.89

**16QAM**

UARFCN	Frequency (MHz)	Path Loss (dB)	Result (dBm) RMS	Result (W) RMS
512 (Bottom)	1930.2	42.98	45.15	32.73
661 (Middle)	1960.0	42.98	45.56	35.97
810 (Top)	1989.8	42.98	45.31	33.96

**32QAM**

UARFCN	Frequency (MHz)	Path Loss (dB)	Result (dBm) RMS	Result (W) RMS
512 (Bottom)	1930.2	42.98	44.87	30.69
661 (Middle)	1960.0	42.98	45.10	32.36
810 (Top)	1989.8	42.98	44.83	30.41

**AQPSK**

UARFCN	Frequency (MHz)	Path Loss (dB)	Result (dBm) RMS	Result (W) RMS
512 (Bottom)	1930.2	42.98	45.39	34.59
661 (Middle)	1960.0	42.98	46.06	40.36
810 (Top)	1989.8	42.98	45.49	35.40

**Multi Carrier (1x4)**Configuration 1 - Mode 7, 8 and 9GMSK

UARFCN	Frequency (MHz)	Path Loss (dB)	Result (dBm) RMS	Result (W) RMS
512 (Bottom)	1930.2	42.98	42.61	18.24
661 (Middle)	1960.0	42.98	42.95	19.72
810 (Top)	1989.8	42.98	42.51	17.82

8PSK

UARFCN	Frequency (MHz)	Path Loss (dB)	Result (dBm) RMS	Result (W) RMS
512 (Bottom)	1930.2	42.98	40.75	11.89
661 (Middle)	1960.0	42.98	41.10	12.88
810 (Top)	1989.8	42.98	40.65	11.61

16QAM

UARFCN	Frequency (MHz)	Path Loss (dB)	Result (dBm) RMS	Result (W) RMS
512 (Bottom)	1930.2	42.98	39.45	8.81
661 (Middle)	1960.0	42.98	39.80	9.55
810 (Top)	1989.8	42.98	39.40	8.71

32QAM

UARFCN	Frequency (MHz)	Path Loss (dB)	Result (dBm) RMS	Result (W) RMS
512 (Bottom)	1930.2	42.98	39.01	7.96
661 (Middle)	1960.0	42.98	39.35	8.61
810 (Top)	1989.8	42.98	38.93	7.82

AQPSK

UARFCN	Frequency (MHz)	Path Loss (dB)	Result (dBm) RMS	Result (W) RMS
512 (Bottom)	1930.2	42.98	40.44	11.07
661 (Middle)	1960.0	42.98	40.80	12.02
810 (Top)	1989.8	42.98	40.38	10.91

Limit	≤100W or ≤+50dBm
-------	------------------

Remarks

The EUT does not exceed 100W or 50dBm at the measured frequencies.



Product Service

## **2.2 PEAK – AVERAGE RATIO**

### **2.2.1 Specification Reference**

FCC CFR 47 Part 24, Clause 24.232 (d)

### **2.2.2 Equipment Under Test**

RRUS 01 B2 / KRC 118 74/2, S/N: CB4J458260

### **2.2.3 Date of Test and Modification State**

11 July 2011 – Modification State 0

### **2.2.4 Test Equipment Used**

The major items of test equipment used for the above tests are identified in Section 3.1.

### **2.2.5 Test Method and Operating Modes**

The test was applied in accordance with the test method requirements of FCC CFR 47 Part 24.

A peak to average ratio measurement is performed at the conducted port of the EUT. The spectrum analyzers Complementary Cumulative Distribution Function (CCDF) measurement profile is used to determine the largest deviation between the average and the peak power of the EUT in given bandwidth. The CCDF curve shows how much time the peak waveform spends at or above a given average power level. The percent of time the signal spends at or above the level defines the probability for that particular power level.

The spectrum analyzer measurement bandwidth was set to 300kHz and the path loss measured and entered as a reference level offset.

The test was performed with the EUT in the following configurations and modes of operation:

Configuration 1 - Mode 1  
- Mode 2  
- Mode 3  
- Mode 4  
- Mode 5  
- Mode 6  
- Mode 7  
- Mode 8  
- Mode 9

### **2.2.6 Environmental Conditions**

	11 July 2011
Ambient Temperature	26.5°C
Relative Humidity	54.1%



Product Service

**2.2.7 Test Results**

For the period of test the EUT met the requirements of FCC CFR 47 Part 24 Peak – Average Ratio.

The test results are shown below.

**Single Carrier**

**Configuration 1 - Mode 1**

**GMSK**

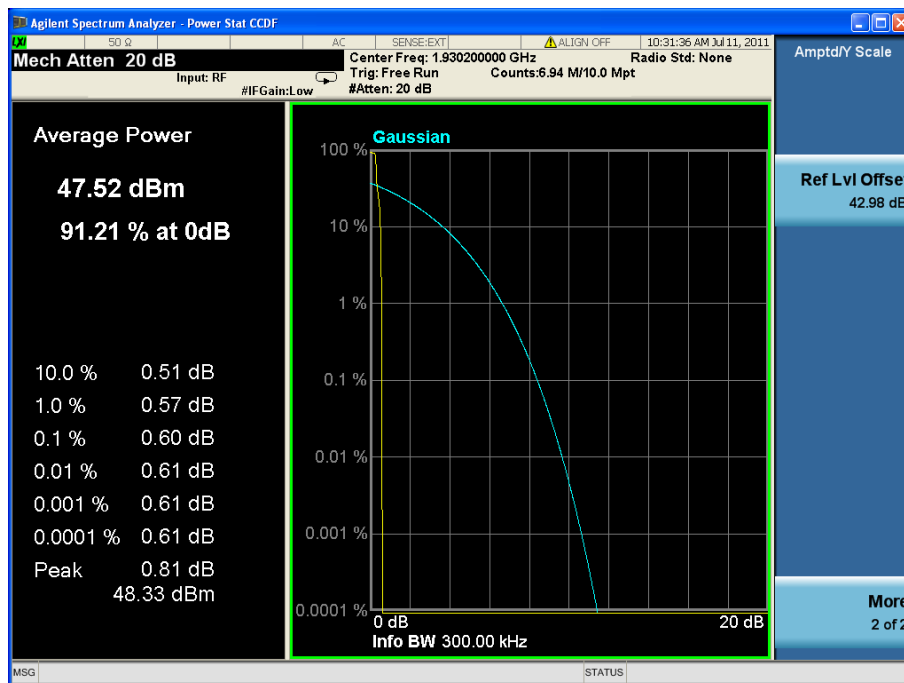





**8PSK**

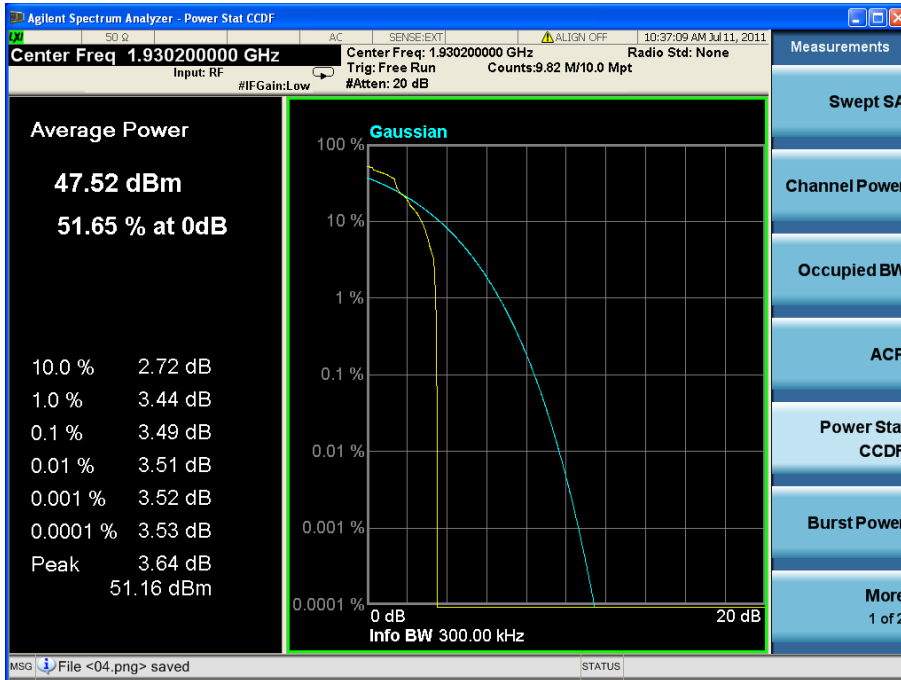

**16QAM**

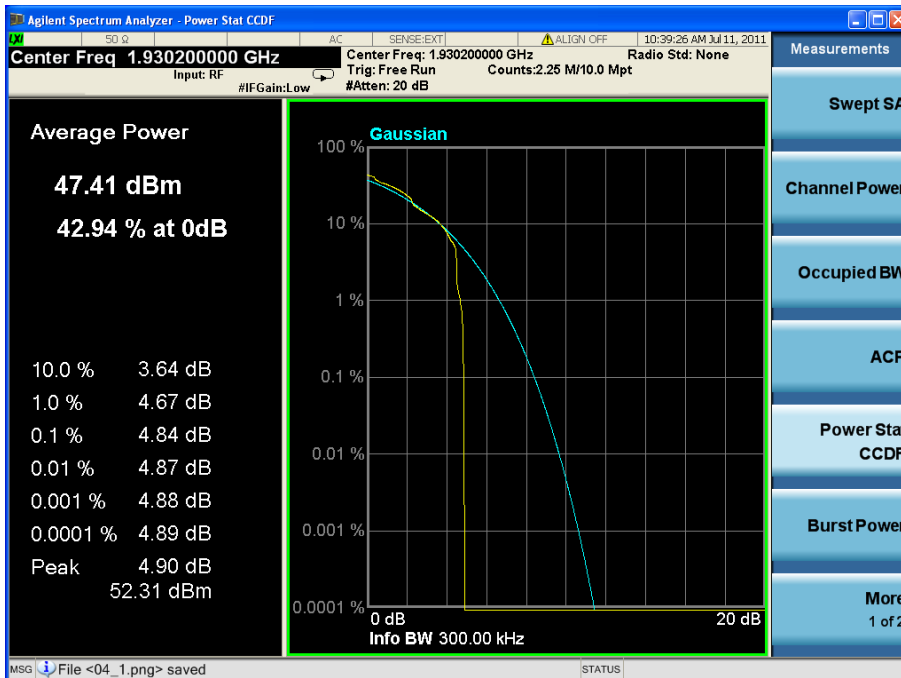



**32QAM**

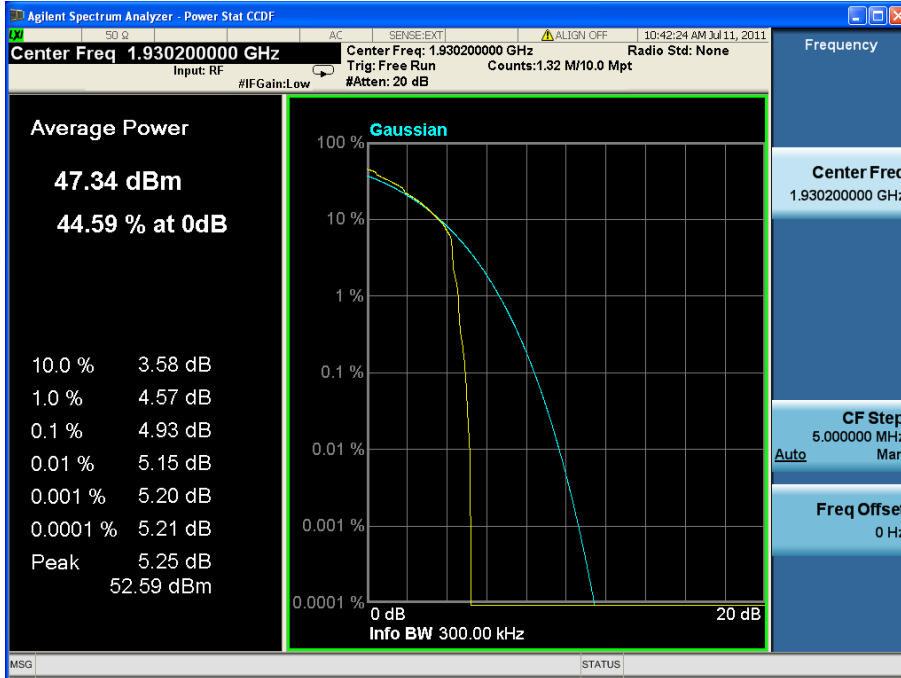

**AQPSK**

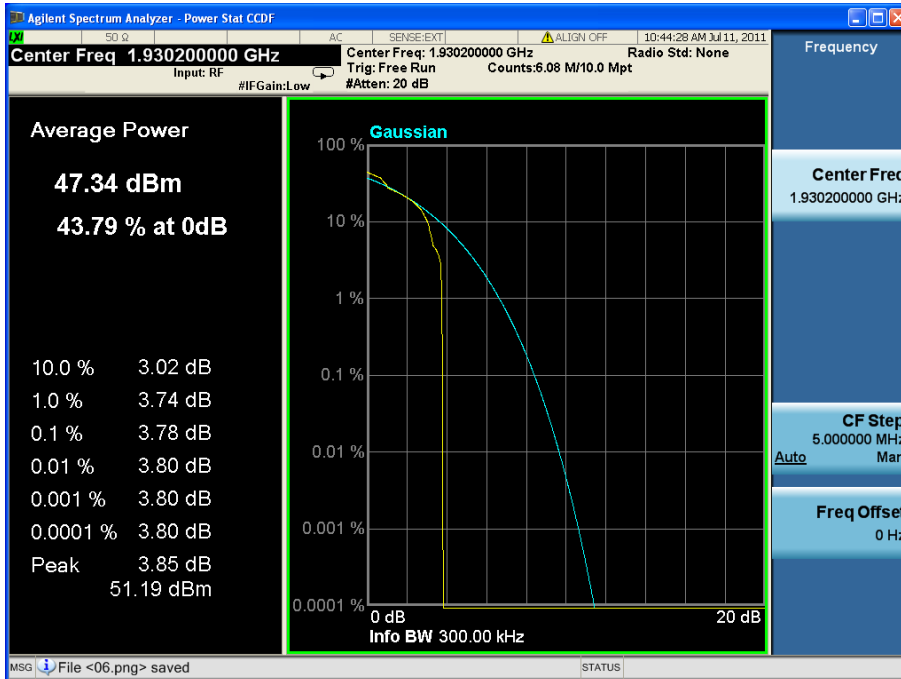



Product Service

Configuration 1 – Mode 2

**GMSK**

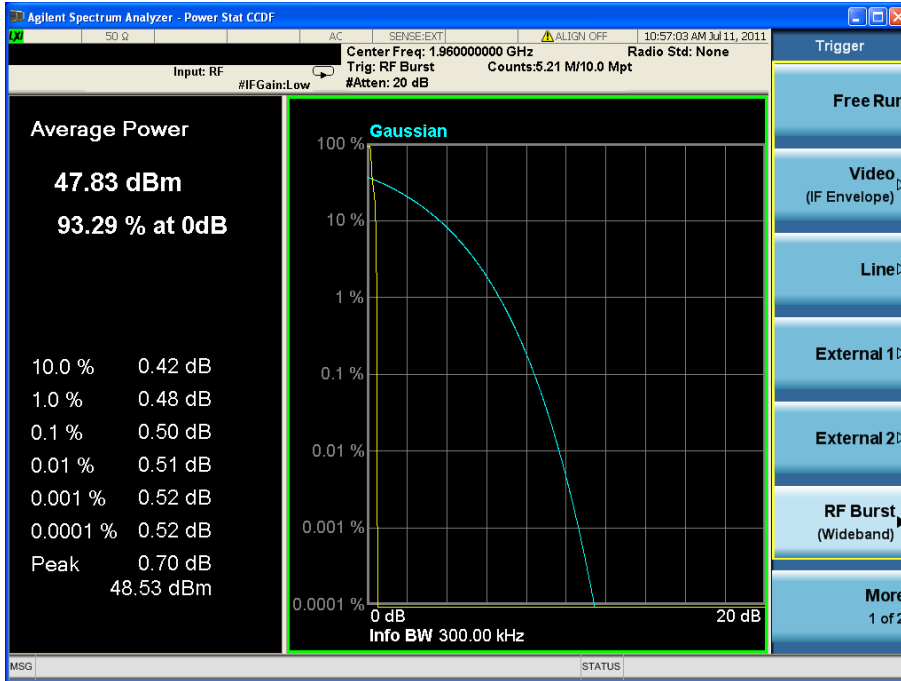

**8PSK**

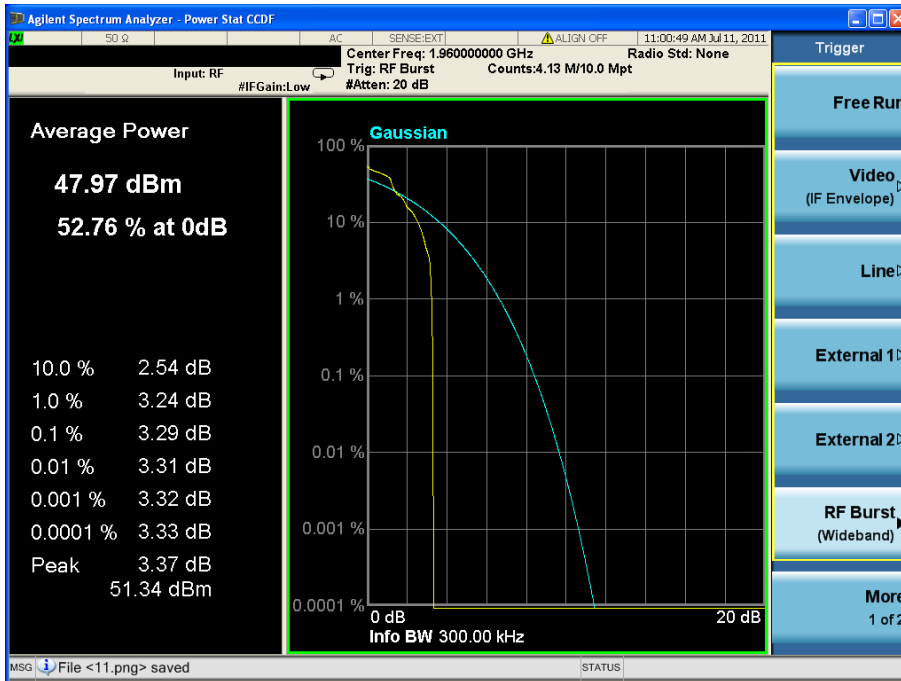



**16QAM**

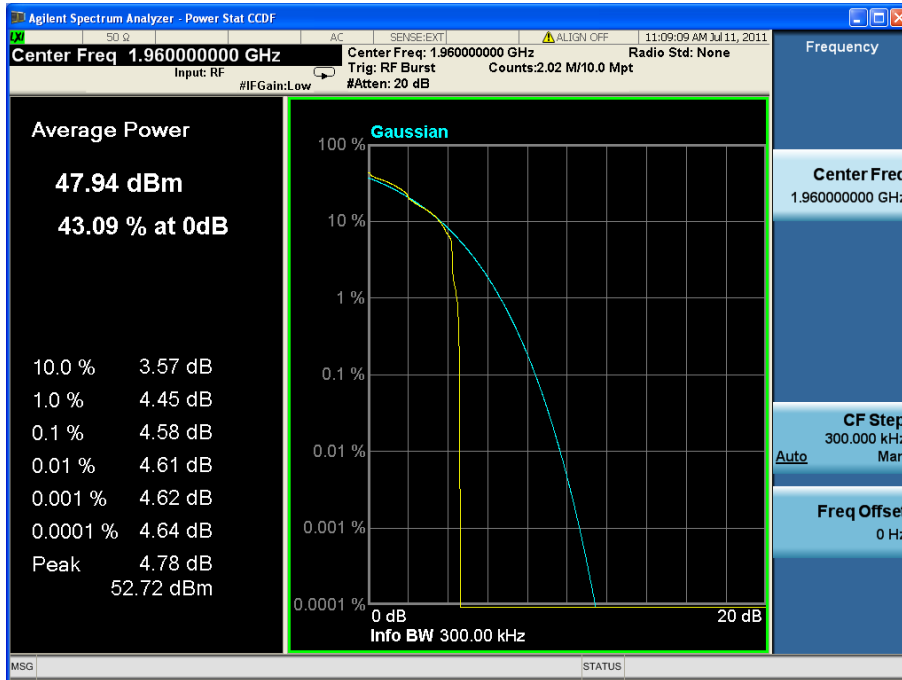

**32QAM**

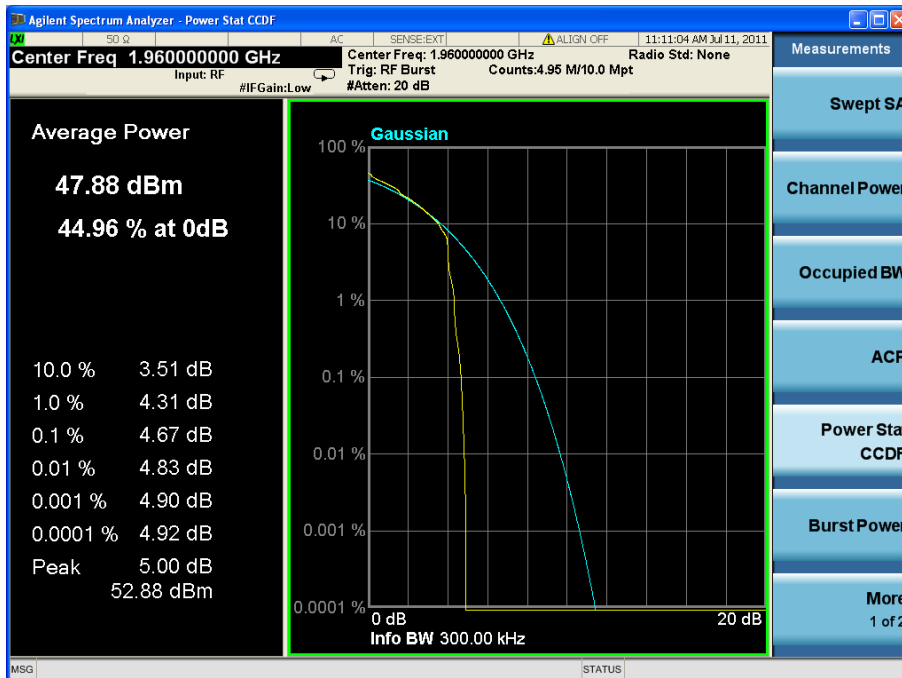



Product Service

**AQPSK**

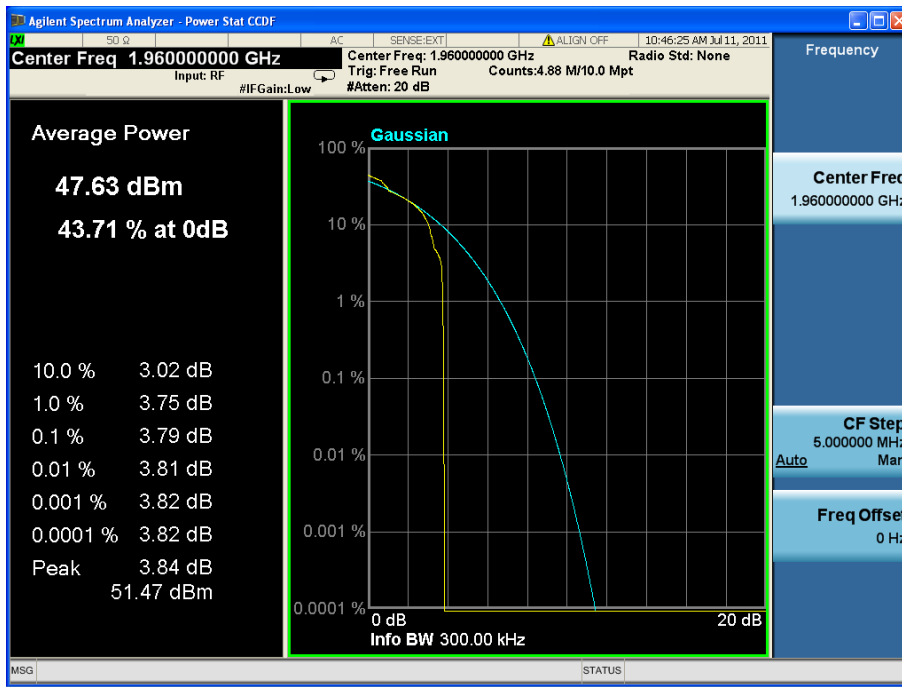

Configuration 1 – Mode 3

**GMSK**

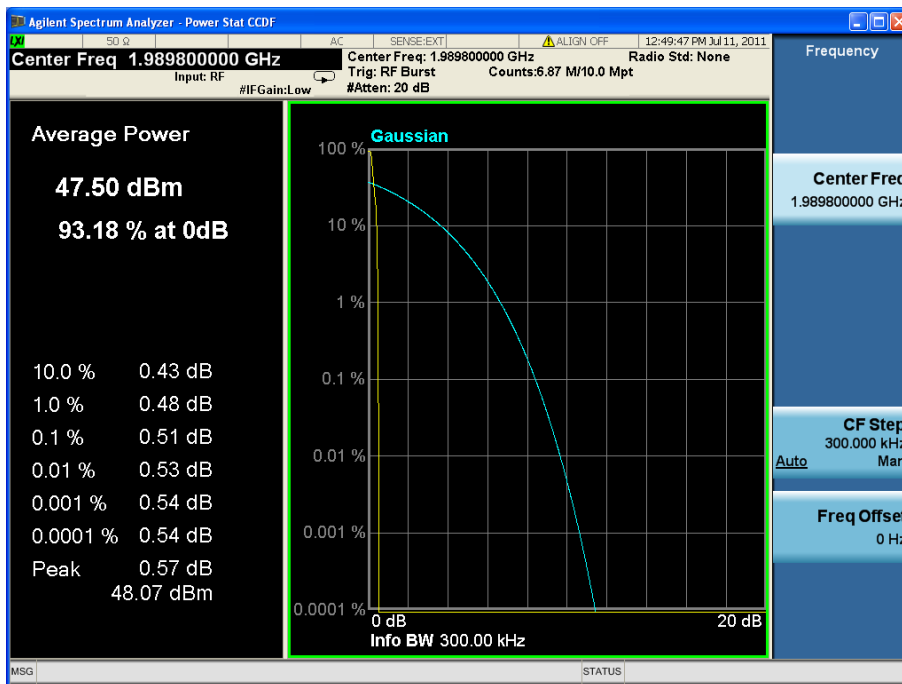



**8PSK**

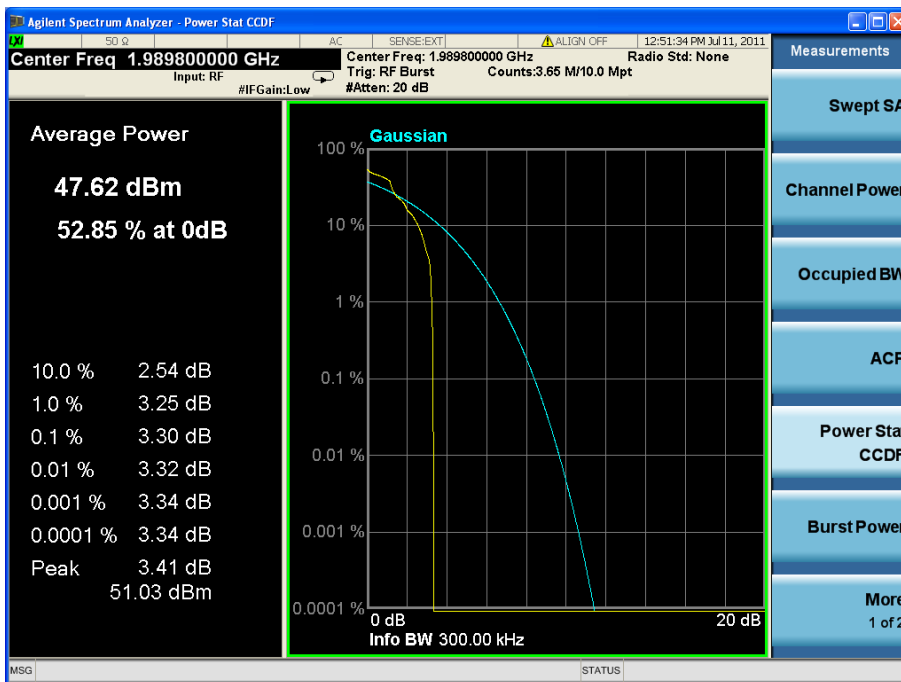

**16QAM**





**32QAM**

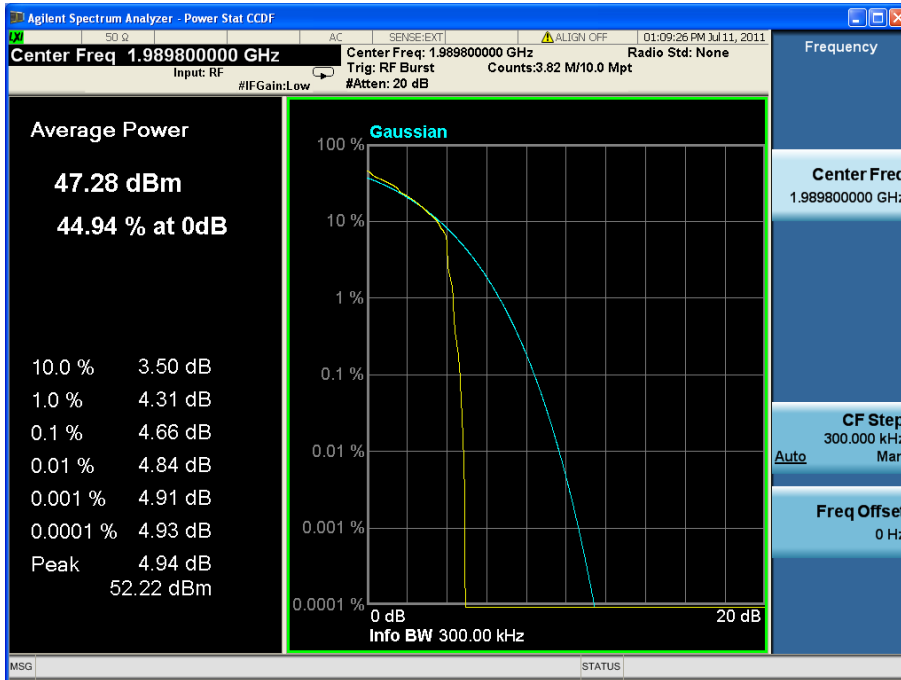

**AQPSK**

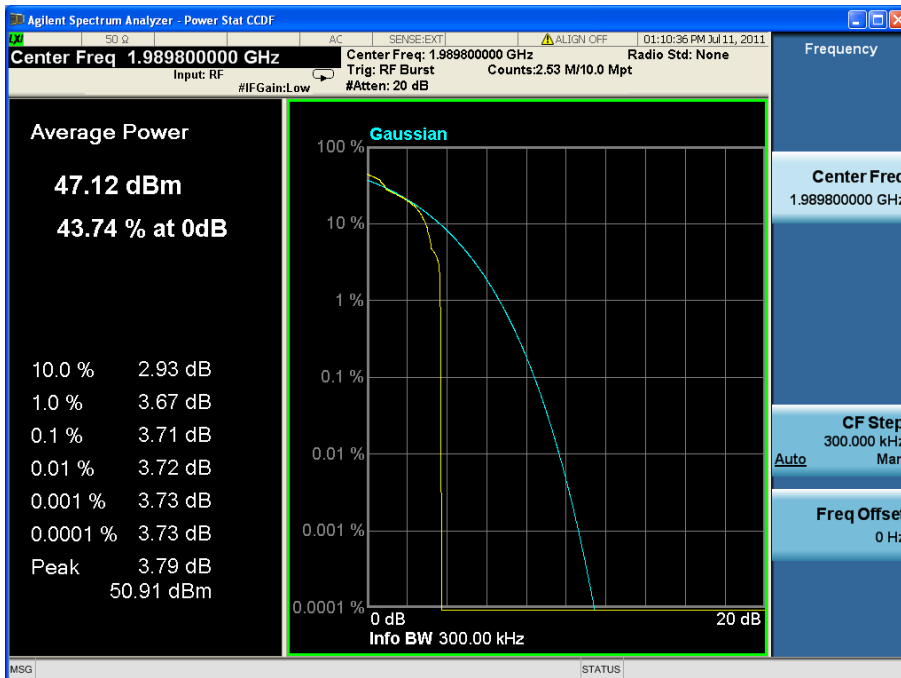



Product Service

**Multi Carrier (1x2)**

**Configuration 1 - Mode 4**

**GMSK**

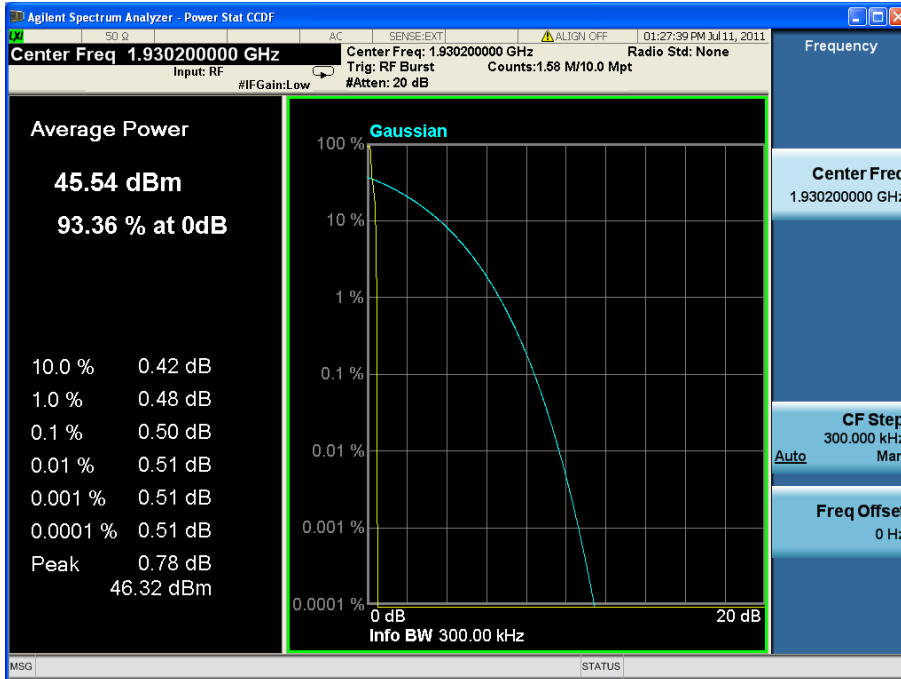

**8PSK**







**16QAM**

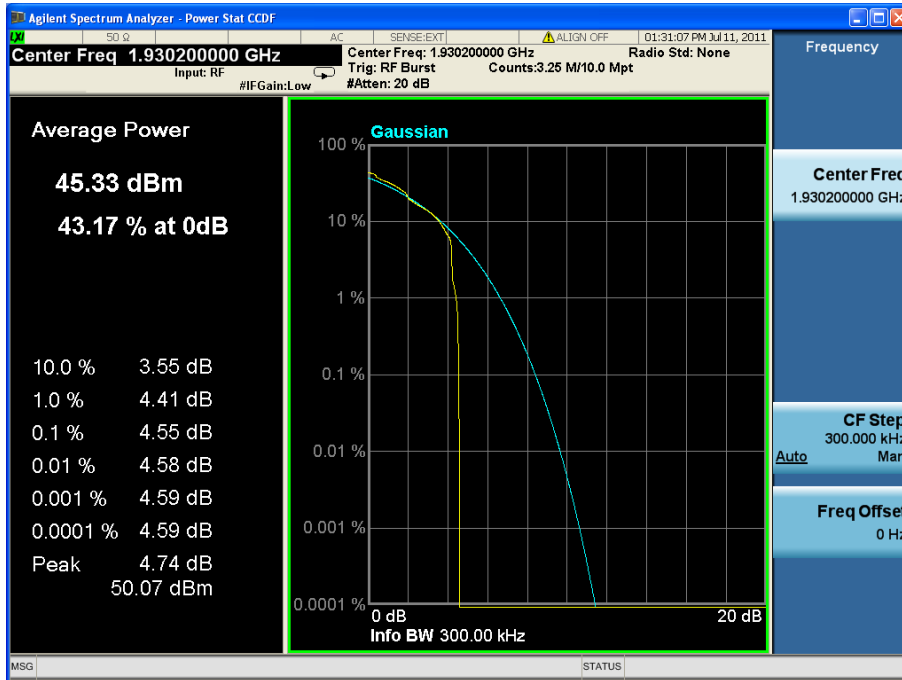

**32QAM**

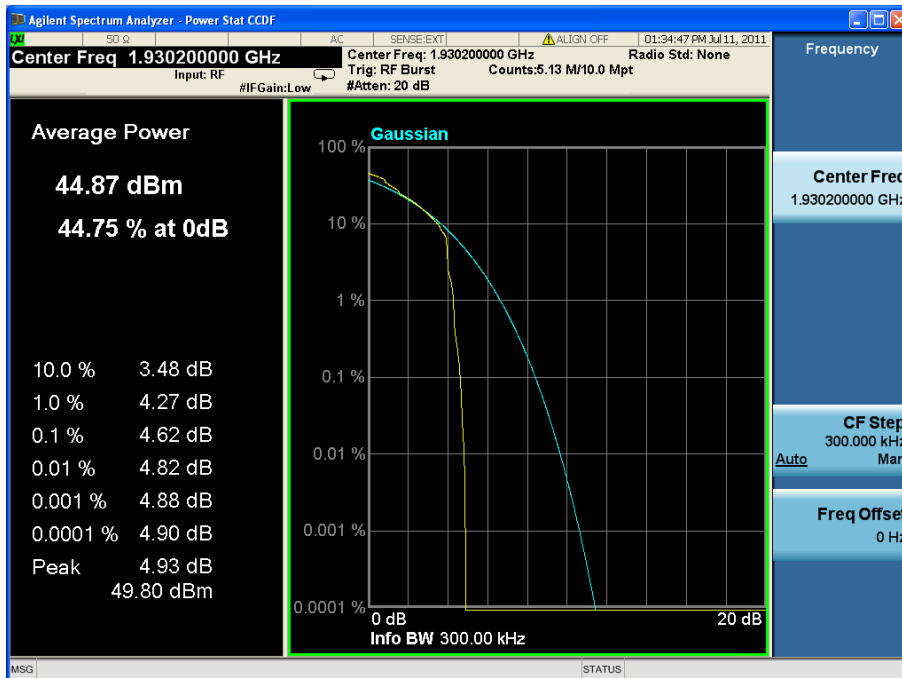



Product Service

**AQPSK**

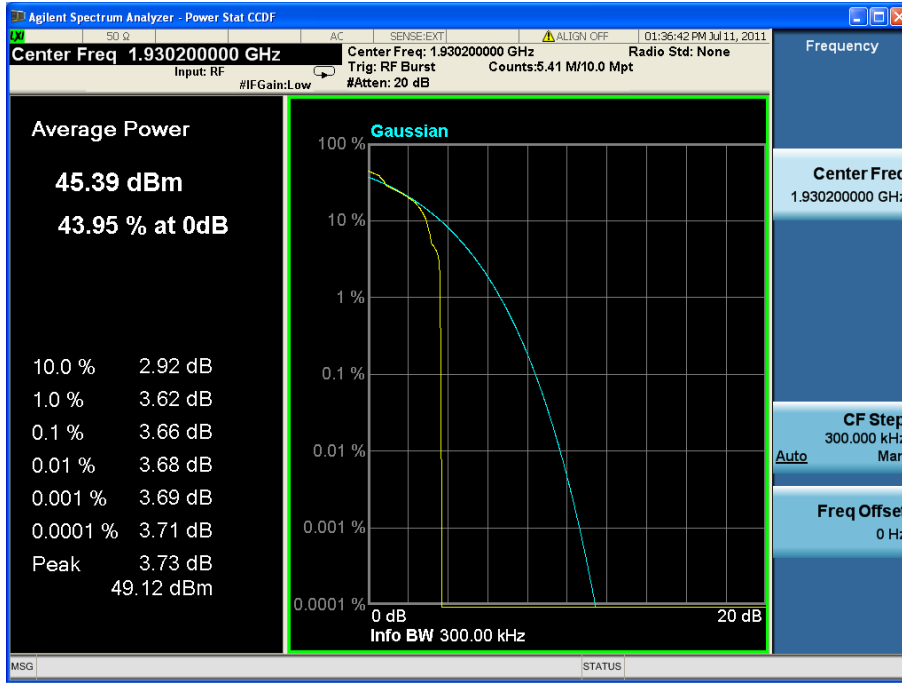

Configuration 1 – Mode 5

**GMSK**

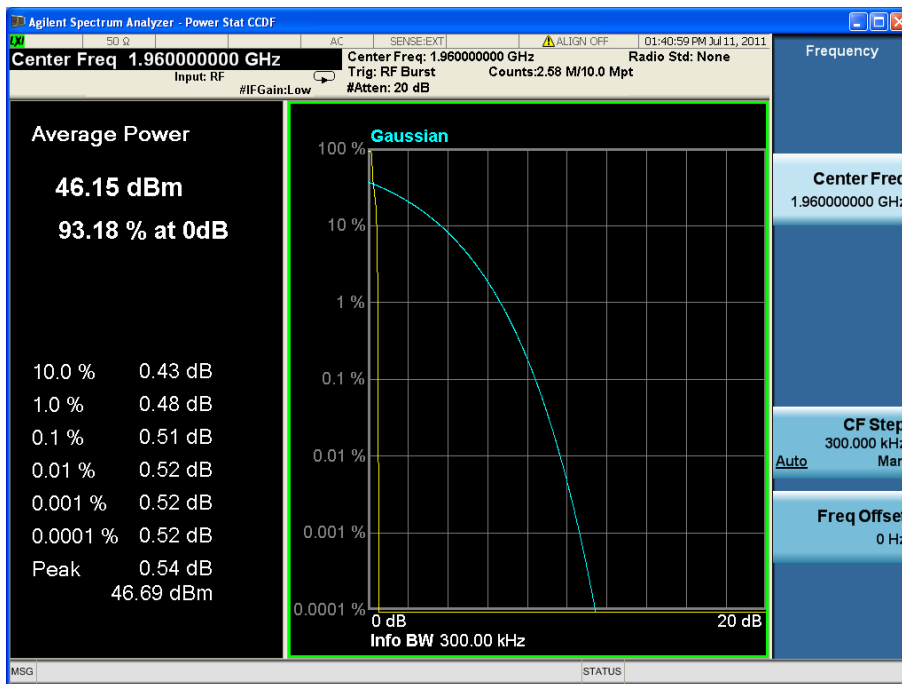



Product Service

**8PSK**



**16QAM**

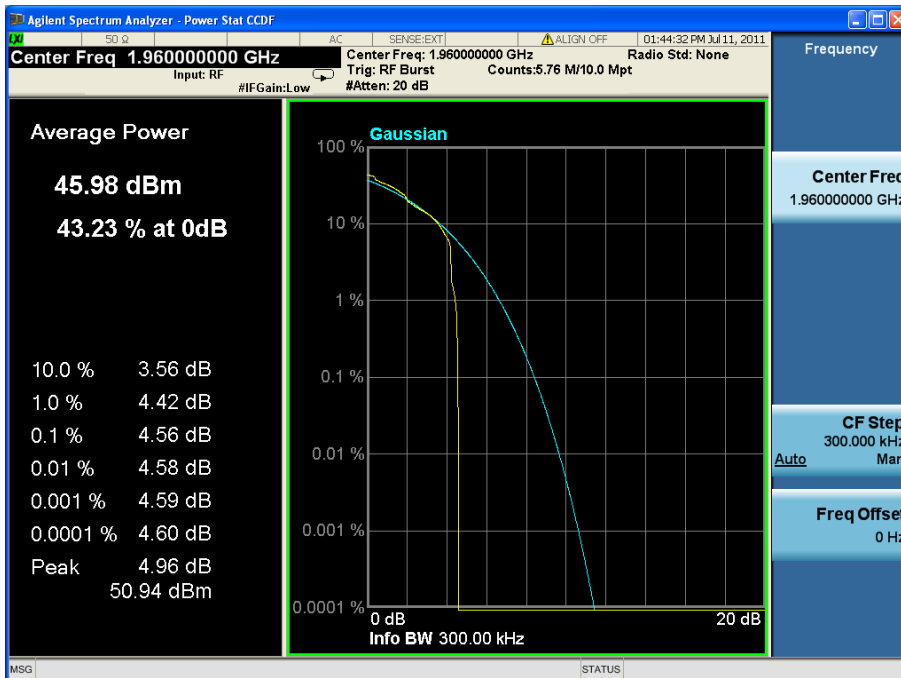



**32QAM**

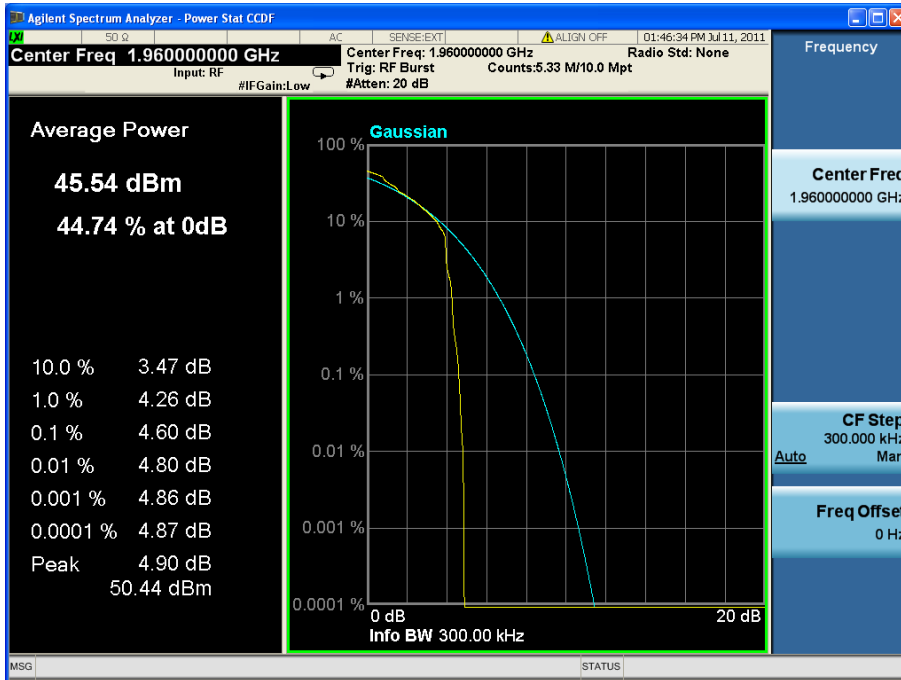

**AQPSK**

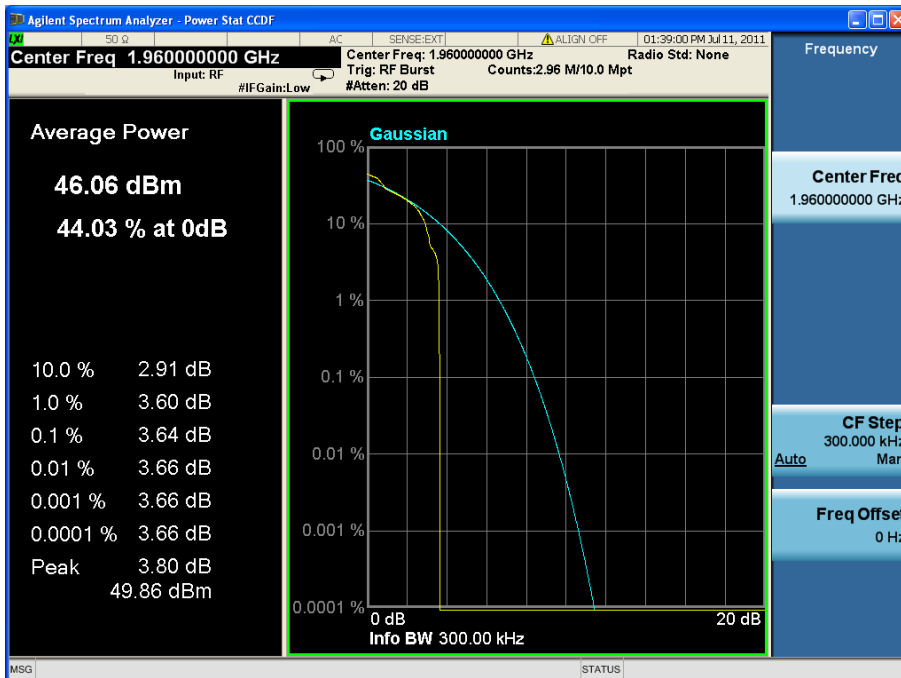



Configuration 1 – Mode 6

**GMSK**

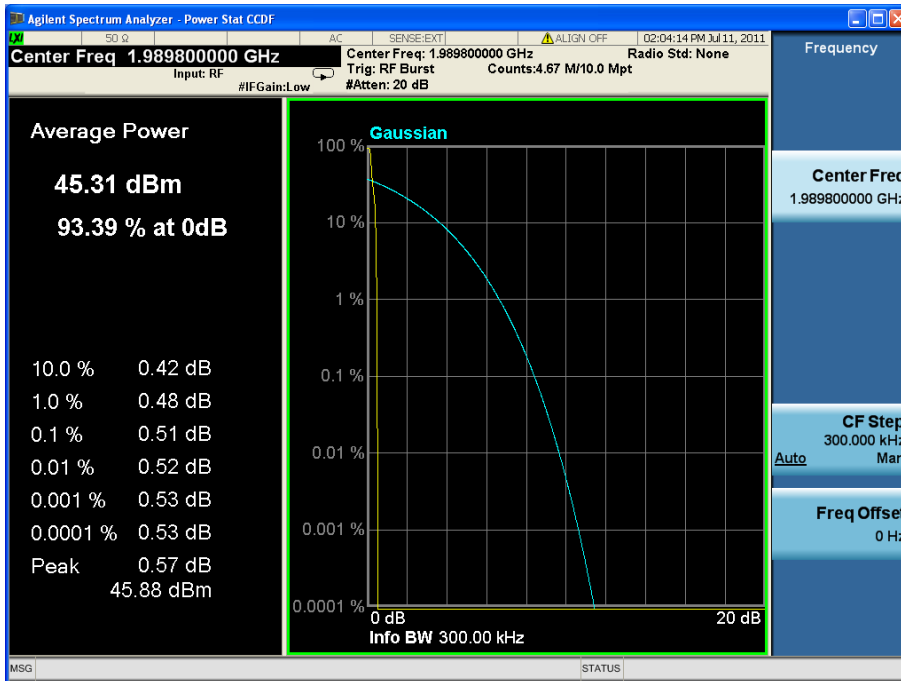

**8PSK**





Product Service

**16QAM**

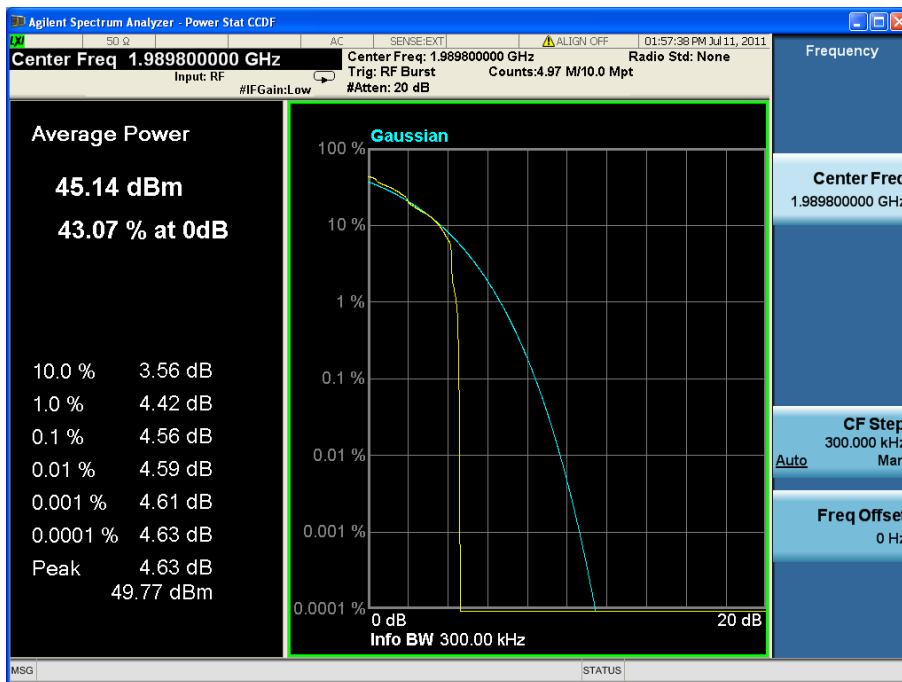

**32QAM**

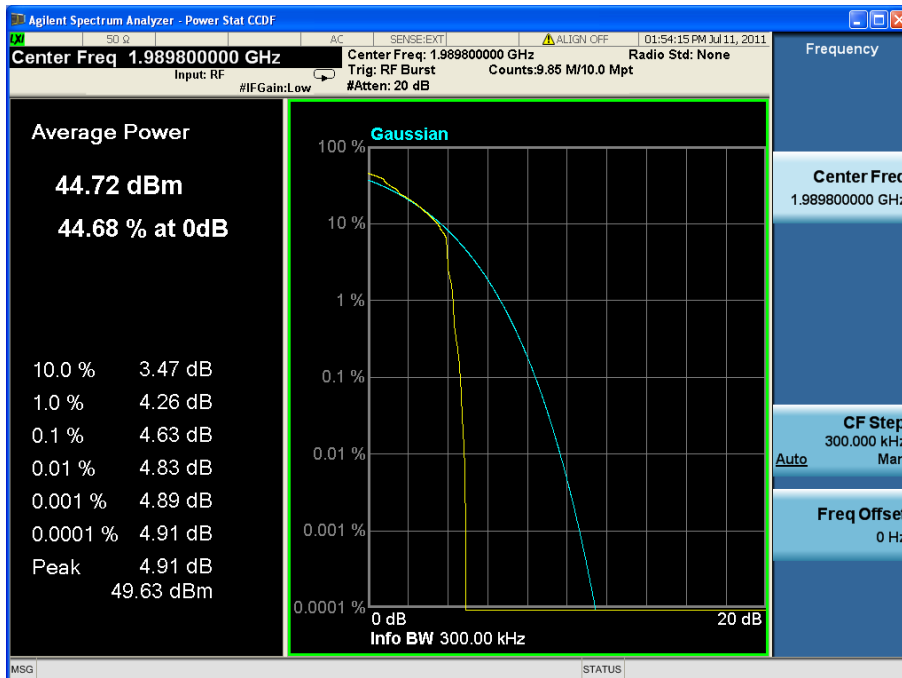



Product Service

**AQPSK**



**Multi Carrier (1x4)**

Configuration 1 – Mode 7

**GMSK**

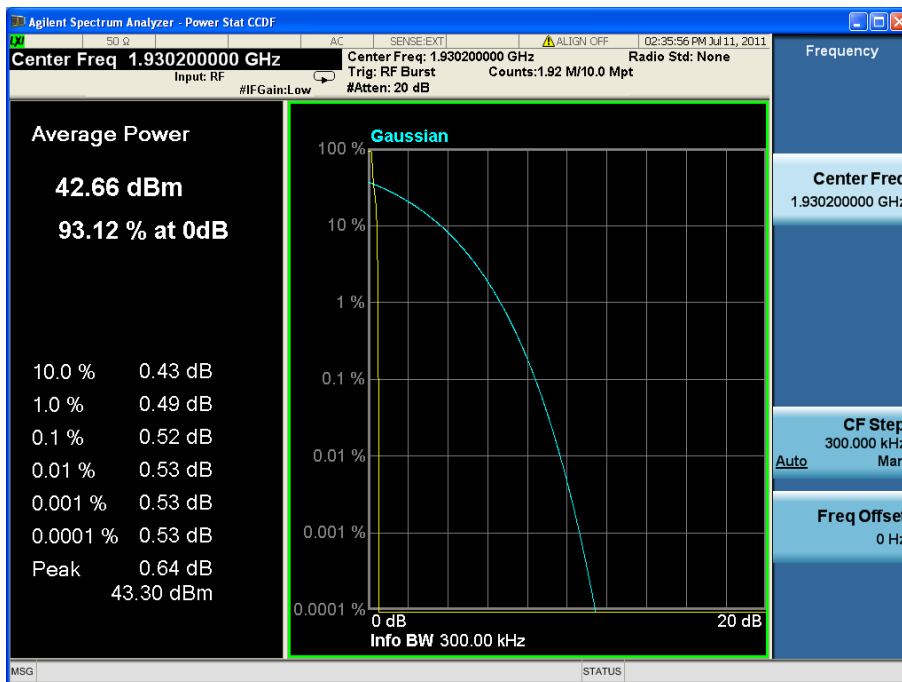



**8PSK**

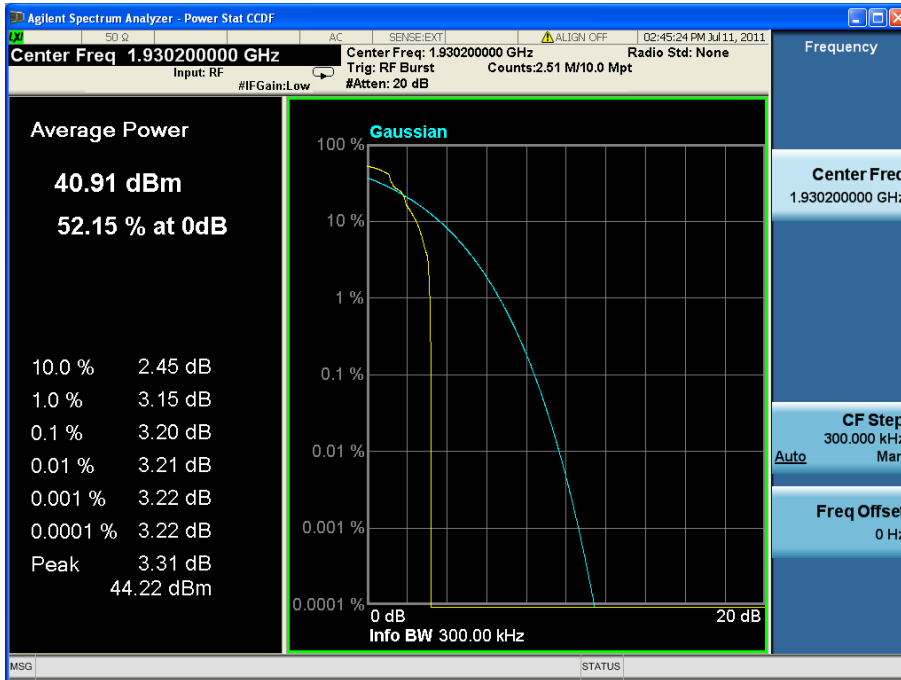

**16QAM**

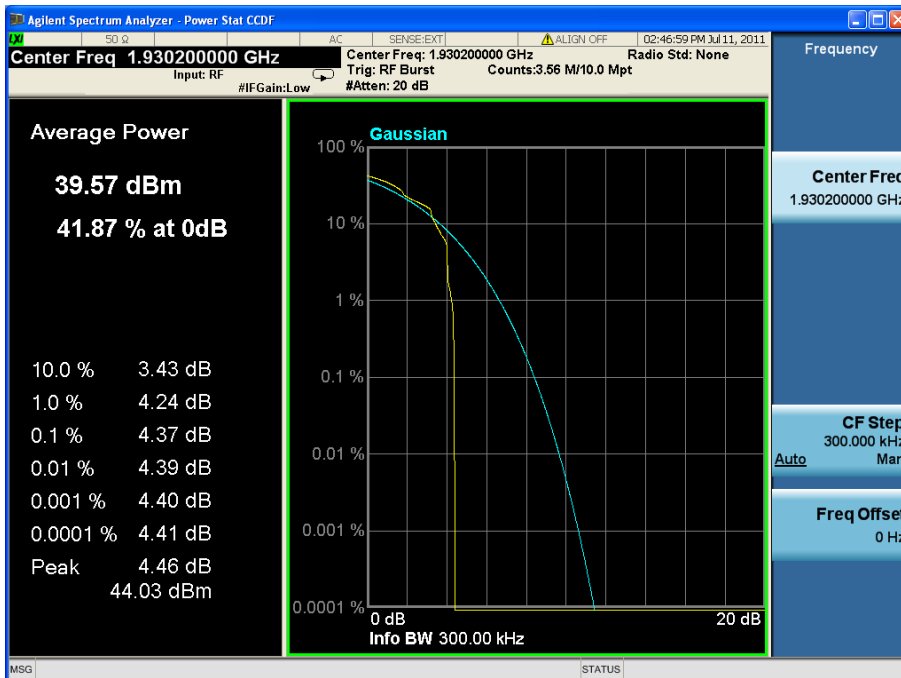





Product Service

**32QAM**

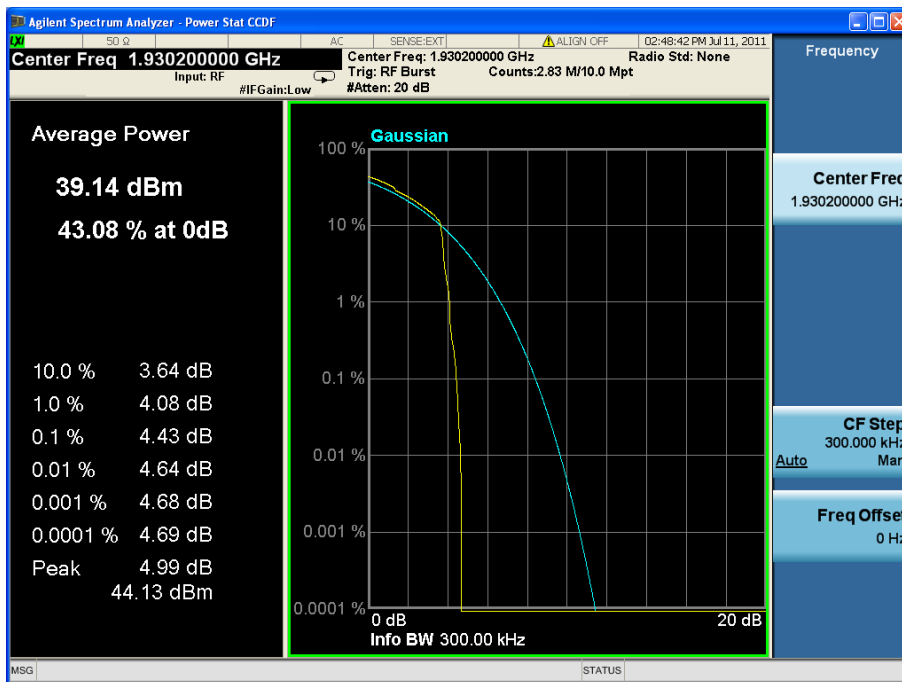

**AQPSK**

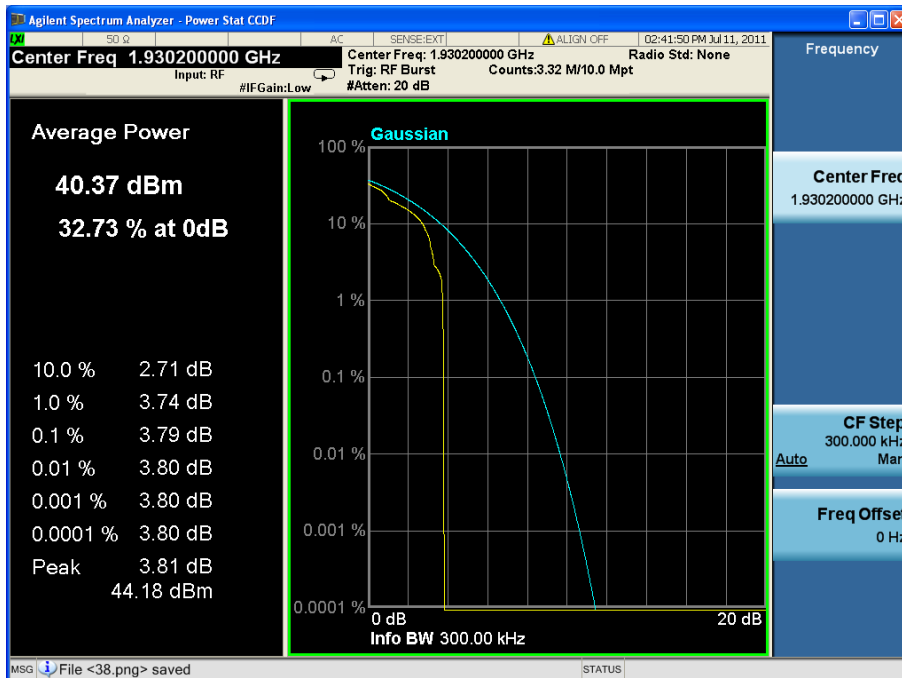



Product Service

Configuration 1 – Mode 8

**GMSK**

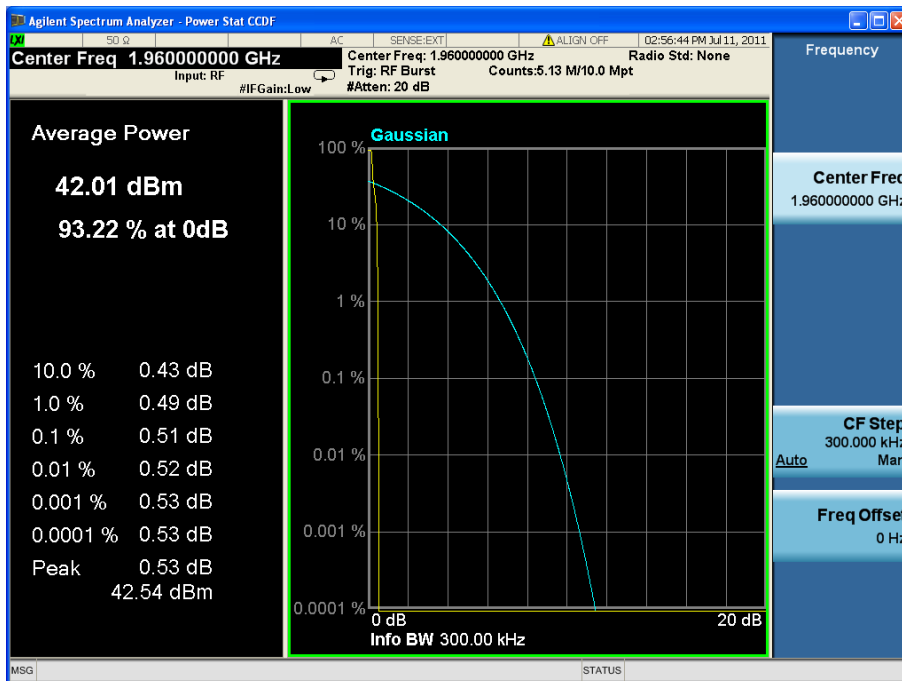

**8PSK**

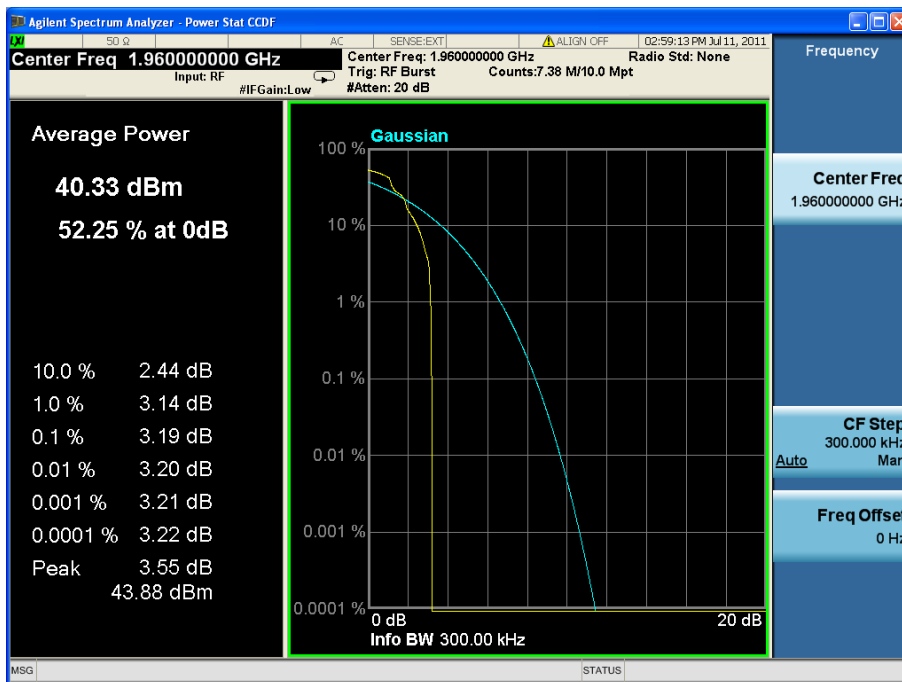



**16QAM**

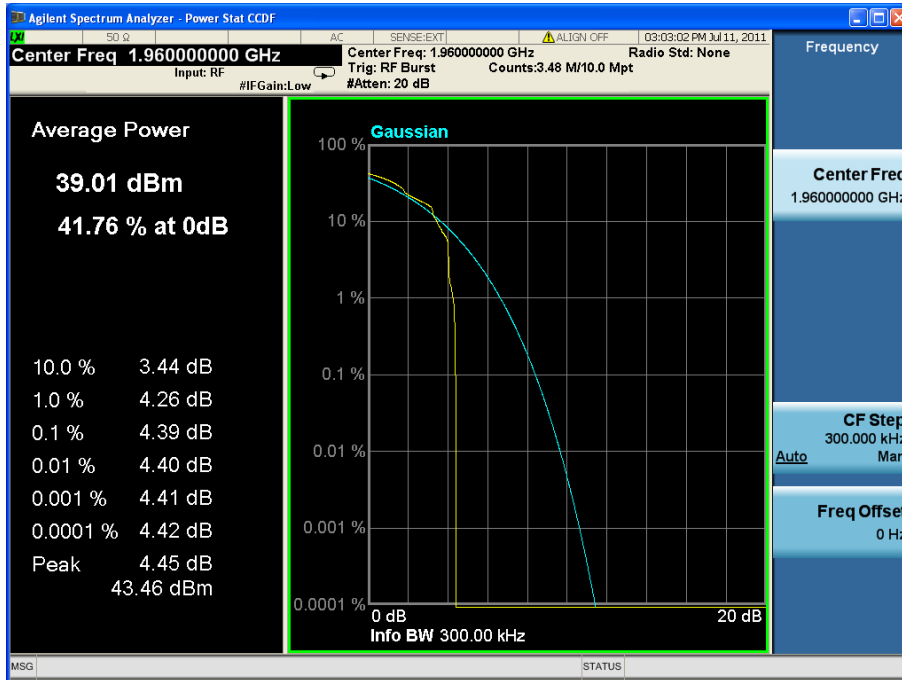

**32QAM**

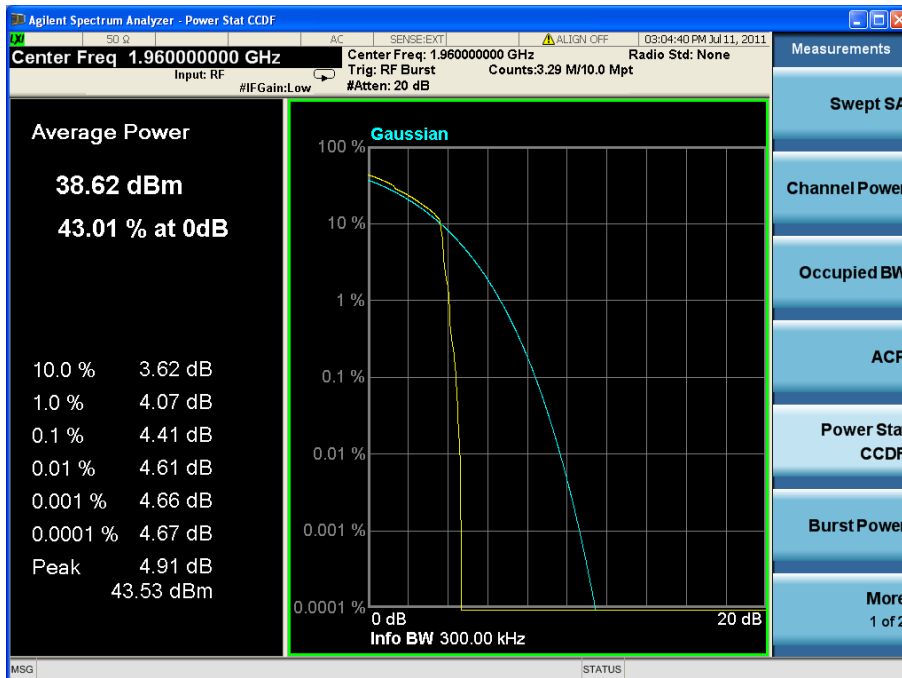



**AQPSK**

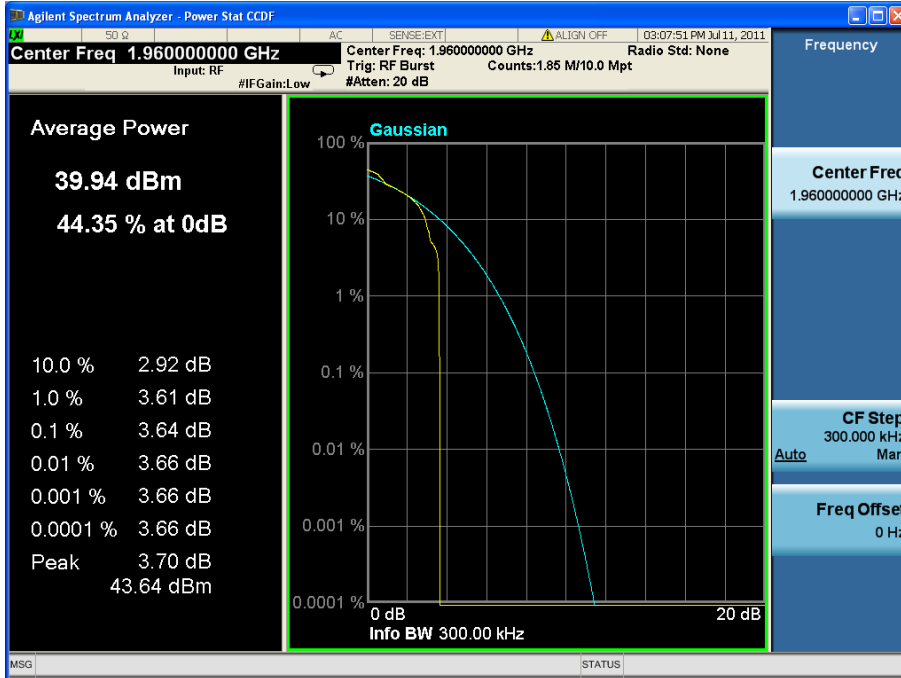

Configuration 1 – Mode 9

**GMSK**

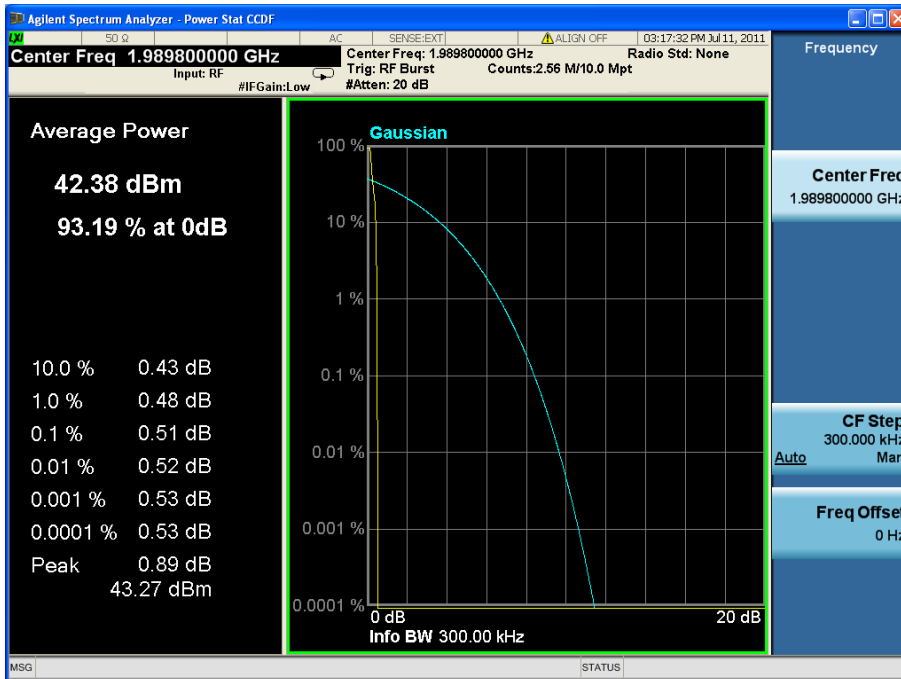



Product Service

**8PSK**

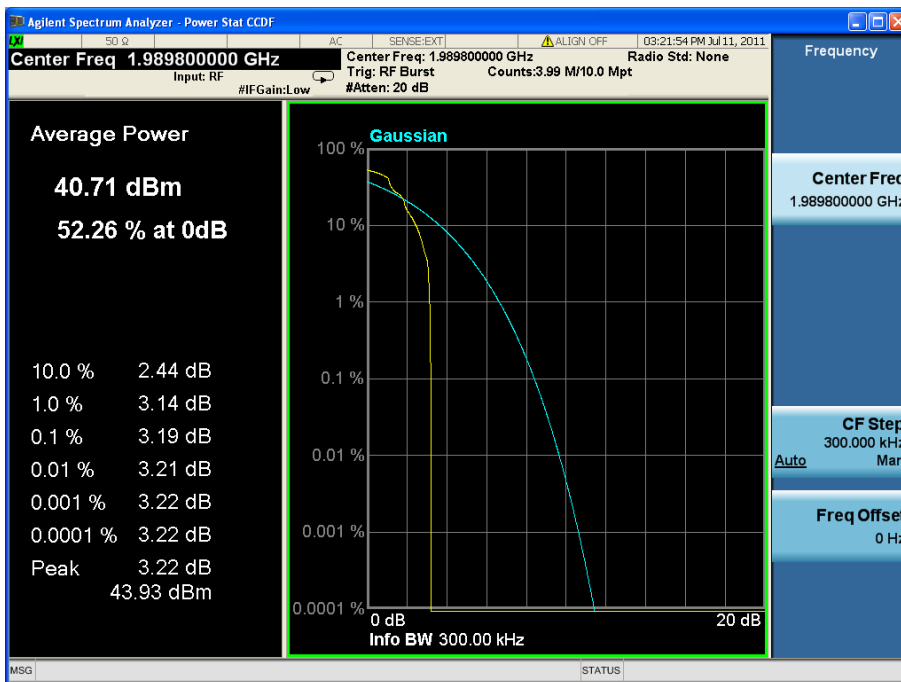

**16QAM**

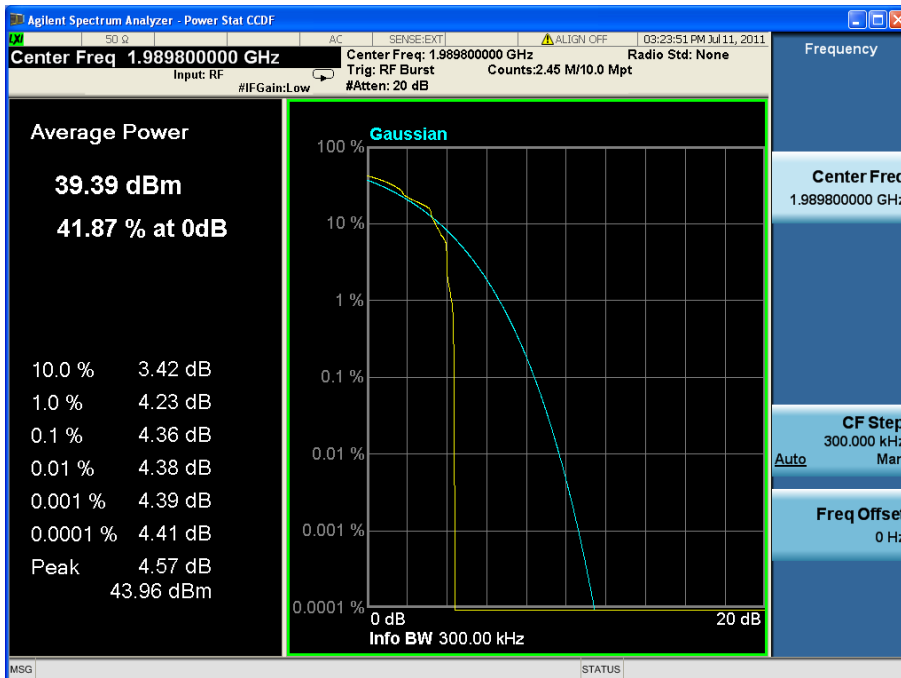



Product Service

**32QAM**

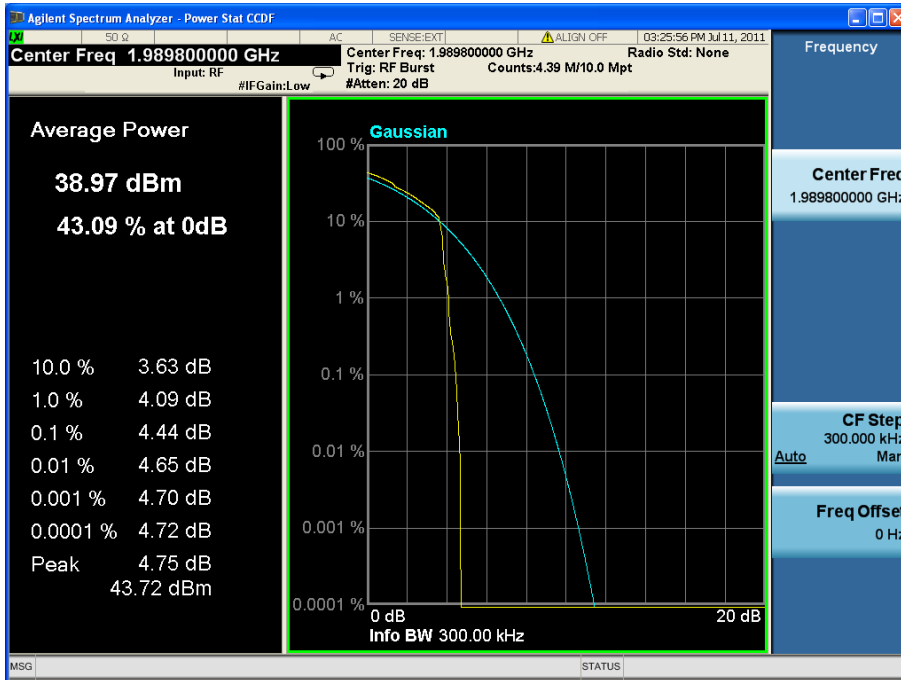

**AQPSK**

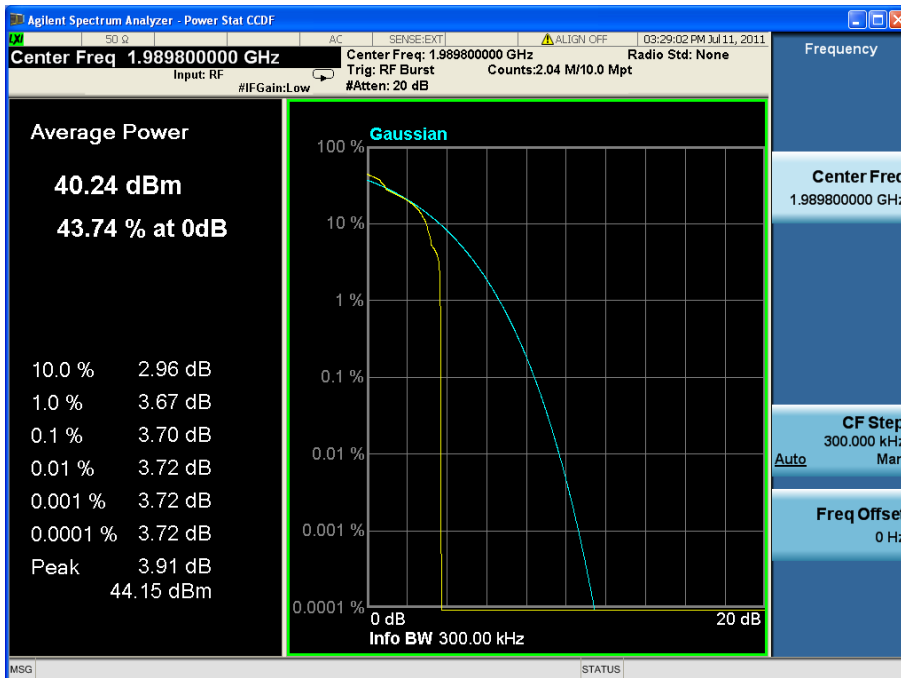

Limit	13dB
-------	------

Remarks

The Peak – Average ratio does not exceed 13dB at the measured frequencies.



Product Service

## **2.3 MODULATION CHARACTERISTICS**

### **2.3.1 Specification Reference**

FCC CFR 47 Part 2, Clause 2.1047 (d)  
Industry Canada RSS-133 Clause 6.2

### **2.3.2 Equipment Under Test**

RRUS 01 B2 / KRC 118 74/2, S/N: CB4J458260

### **2.3.3 Date of Test and Modification State**

14 July 2011 – Modification State 0

### **2.3.4 Test Method and Operating Modes**

The test was applied in accordance with the test method requirements of FCC CFR 47 Part 2 and Industry Canada RSS-133.

The EUT supports GMSK, 8PSK, 16QAM, 32QAM and AQPSK modulations.

The test was performed with the EUT in the following configurations and modes of operation:

Configuration 1 - Mode 2

### **2.3.5 Environmental Conditions**

	14 July 2011
Ambient Temperature	25.2°C
Relative Humidity	58.1%



Product Service

### 2.3.6 Test Results

For the period of test the EUT met the requirements of FCC CFR 47 Part 2 and Industry Canada RSS-133 for Modulation Characteristics.

The test results are shown below

#### Single Carrier

#### Configuration 1 - Mode 2

#### GMSK

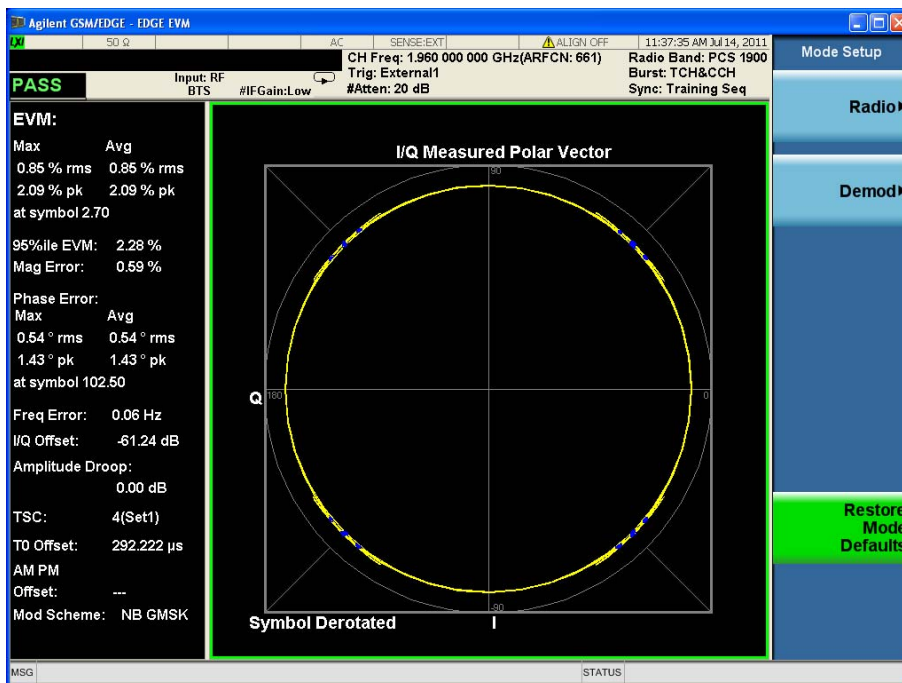





Product Service

### 8PSK

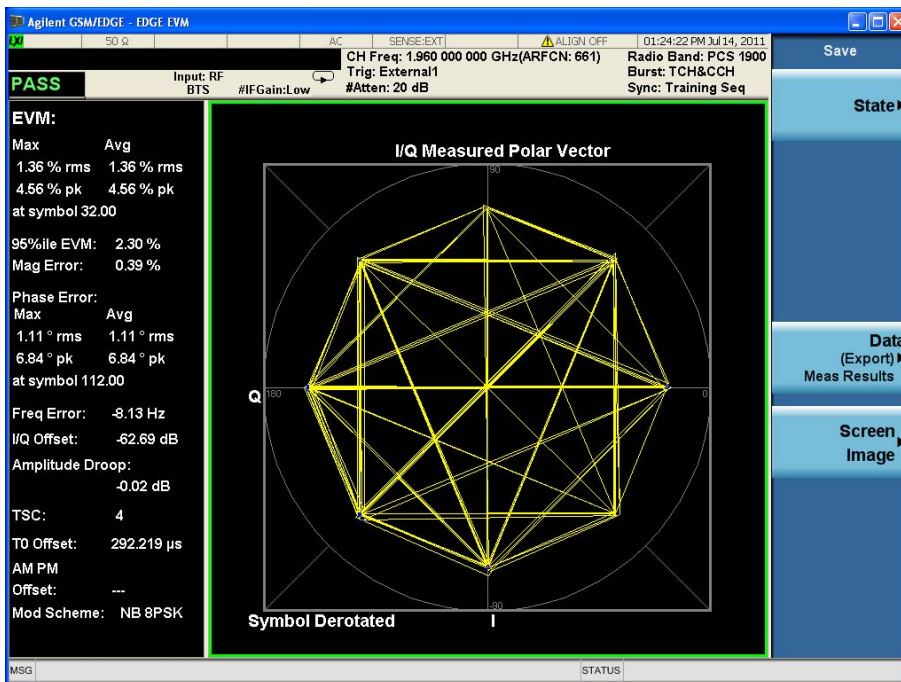

### 16QAM

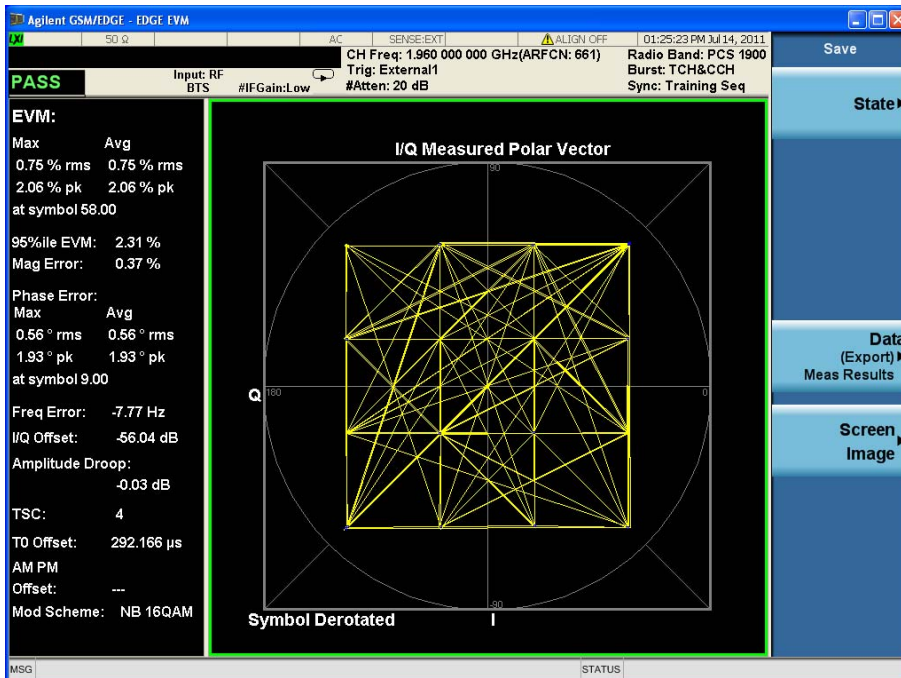



32QAM

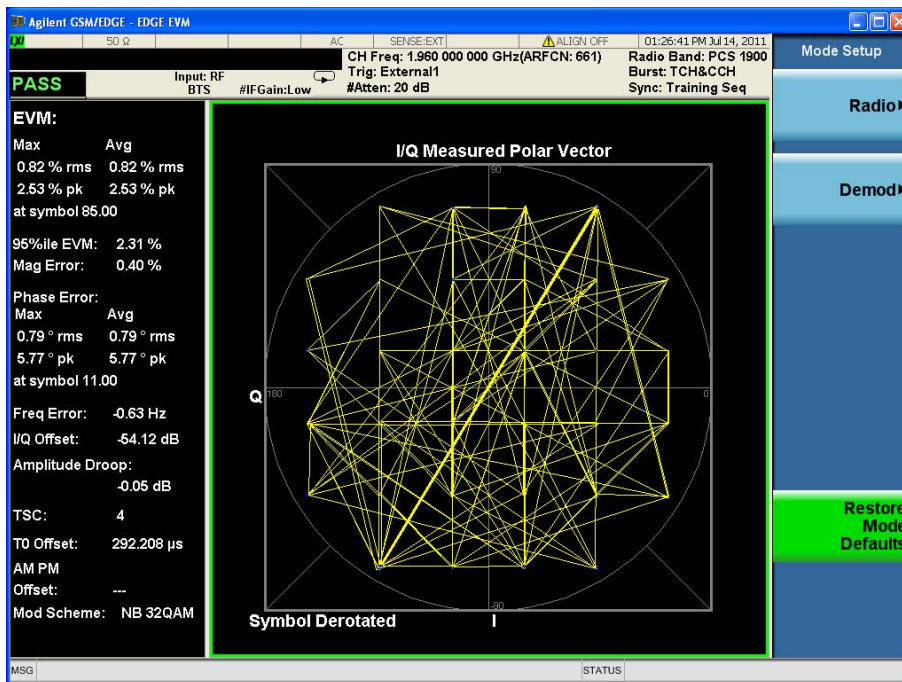

AQPSK

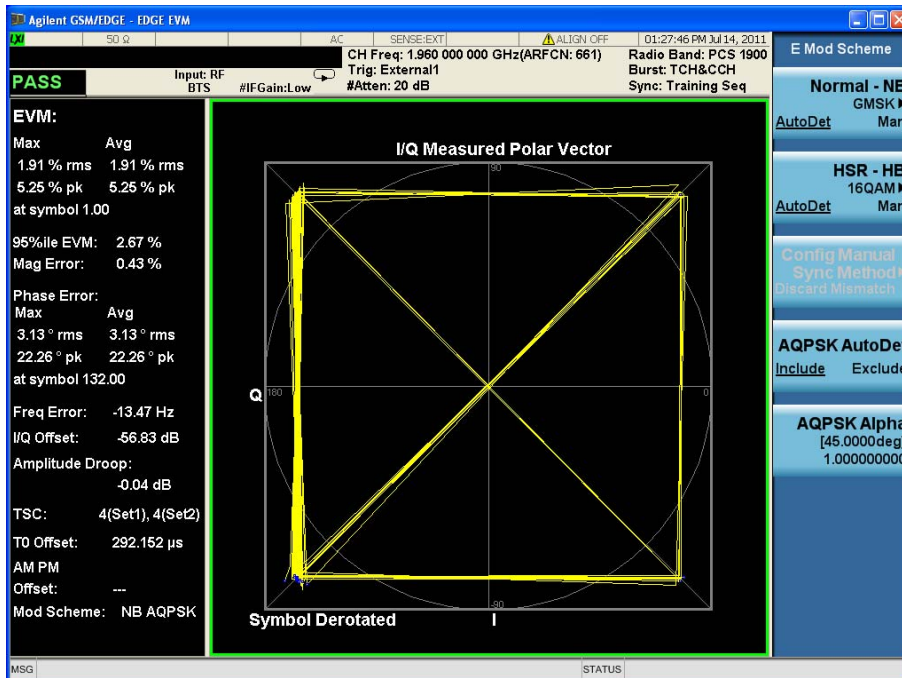



Product Service

## **2.4 OCCUPIED BANDWIDTH**

### **2.4.1 Specification Reference**

FCC CFR 47 Part 2, Clause 2.1049  
FCC CFR 47 Part 24, Clause 24.238 (b)  
Industry Canada RSS-GEN, Clause 4.6.1

### **2.4.2 Equipment Under Test**

RRUS 01 B2 / KRC 118 74/2, S/N: CB4J458260

### **2.4.3 Date of Test and Modification State**

12 July 2011 – Modification State 0

### **2.4.4 Test Equipment Used**

The major items of test equipment used for the above tests are identified in Section 3.1.

### **2.4.5 Test Method and Operating Modes**

The test was applied in accordance with the test method requirements of FCC CFR 47 Part 2 and Part 24 and Industry Canada RSS-GEN.

The EUT was transmitting at maximum power, modulated using the modulations described. Using a resolution bandwidth of 30kHz and a video bandwidth of 300kHz. The occupied bandwidth, that is the frequency bandwidth such that, below its lower and above its upper frequency limits, the mean powers radiated are each equal to 0.5 percent of the total mean power radiated by a given emission.

The test was performed with the EUT in the following configurations and modes of operation:

Configuration 1 - Mode 1  
                          - Mode 2  
                          - Mode 3

### **2.4.6 Environmental Conditions**

  12 July 2011  
Ambient Temperature   26.3°C  
Relative Humidity       59.5%



Product Service

**2.4.7 Test Results**

For the period of test the EUT met the requirements of FCC CFR 47 Part 2 and Part 24 and Industry Canada RSS-GEN for Occupied Bandwidth.

The test results are shown below

**Single Carrier**

**GMSK**

**Configuration 1 - Mode 1**

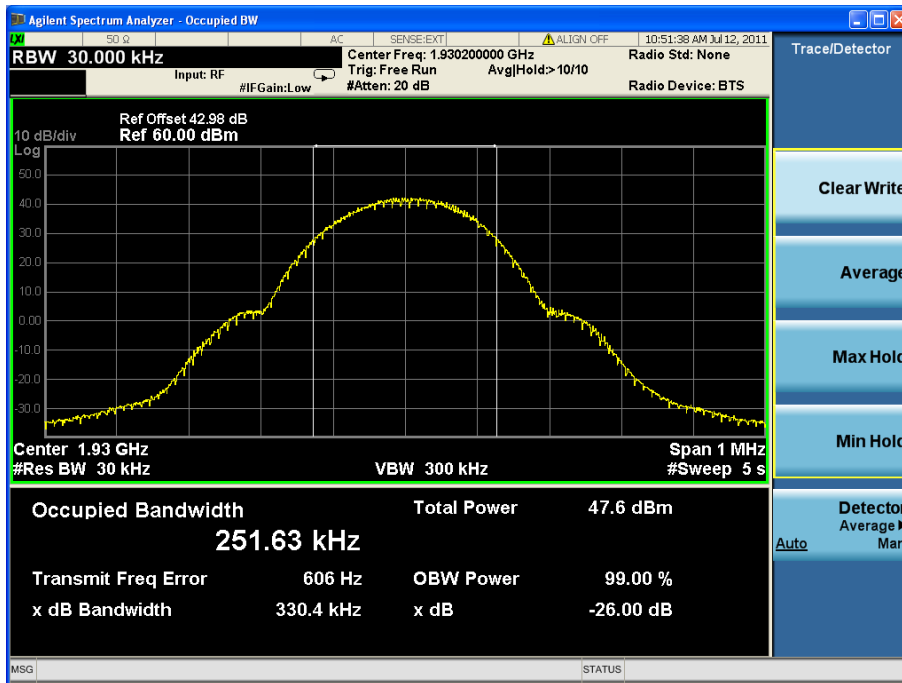



Configuration 1 – Mode 2

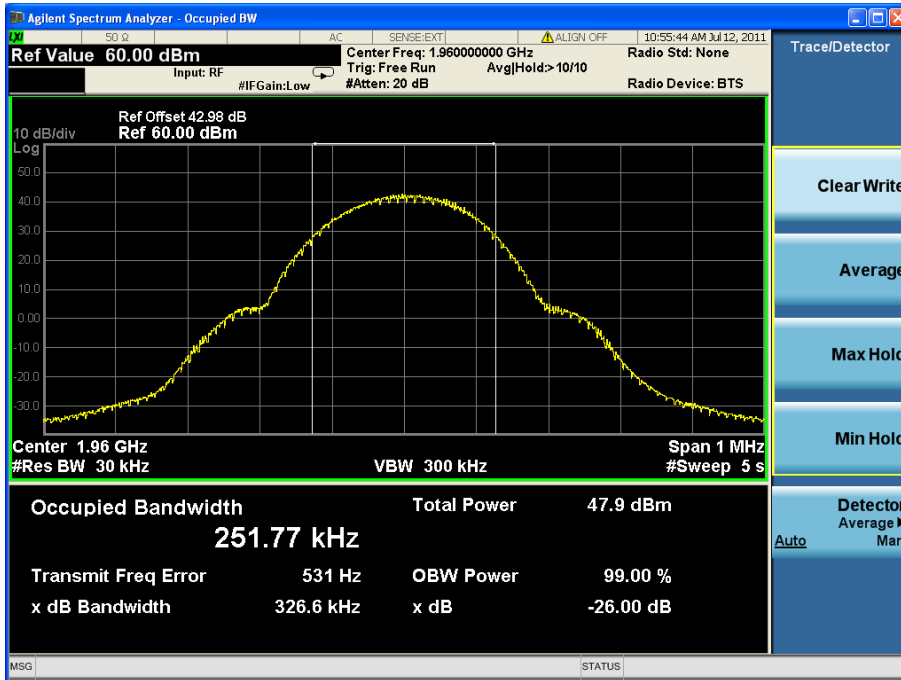

Configuration 1 – Mode 3

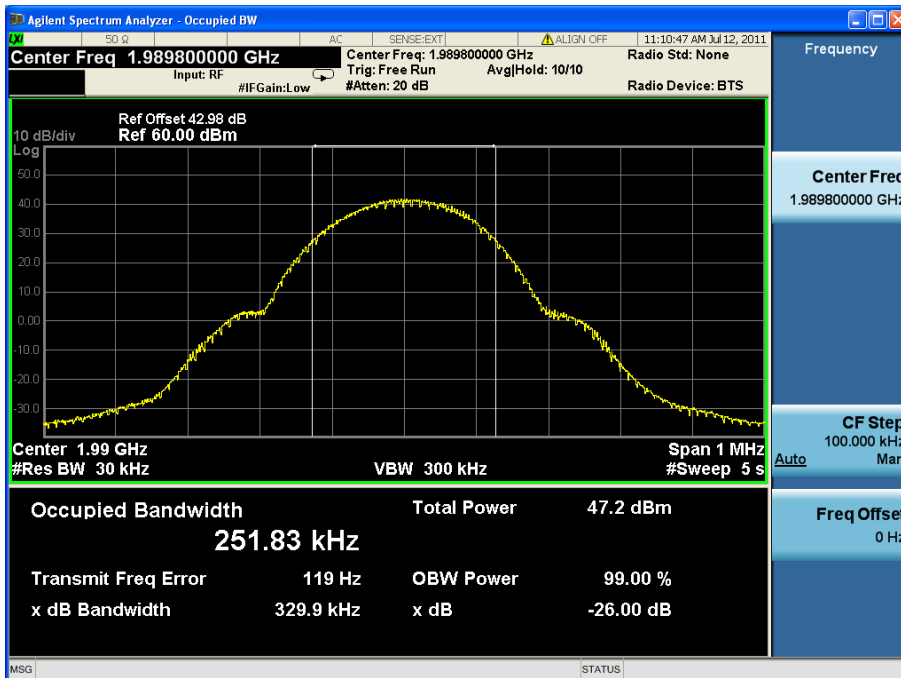



8PSK

Configuration 1 – Mode 1

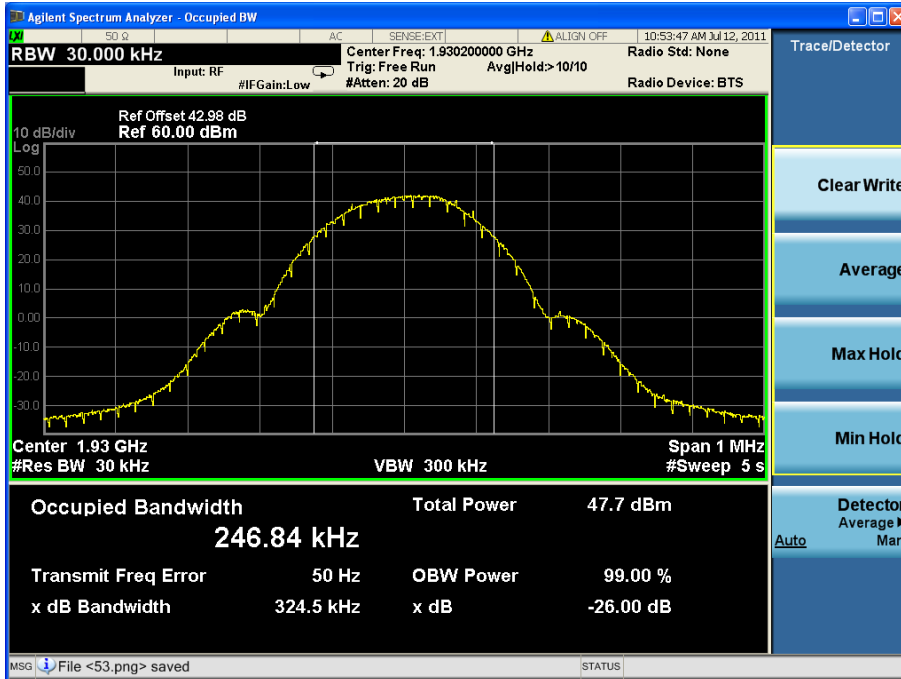

Configuration 1 – Mode 2

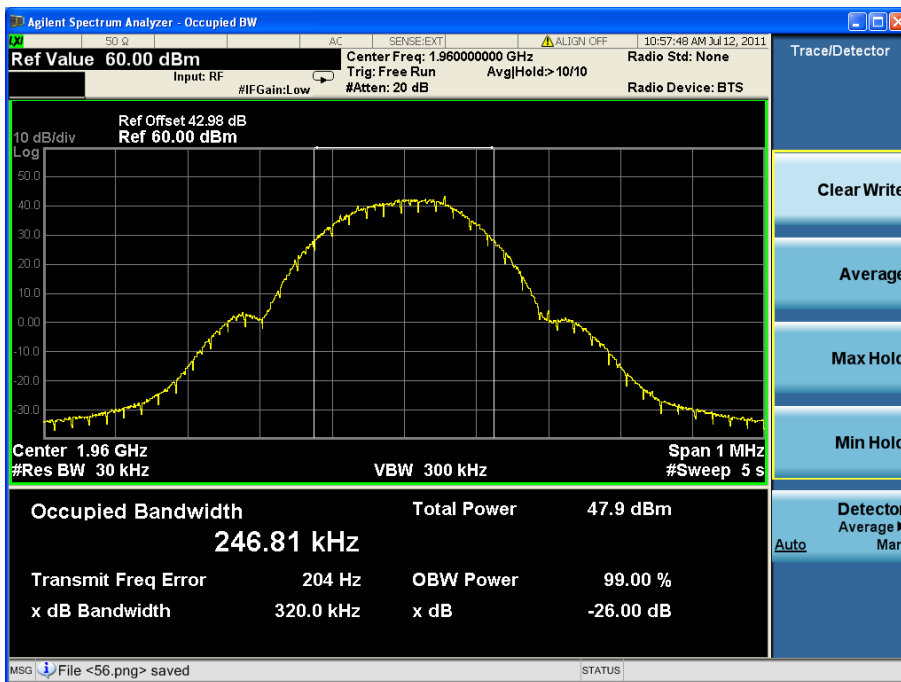



Product Service

Configuration 1 – Mode 3

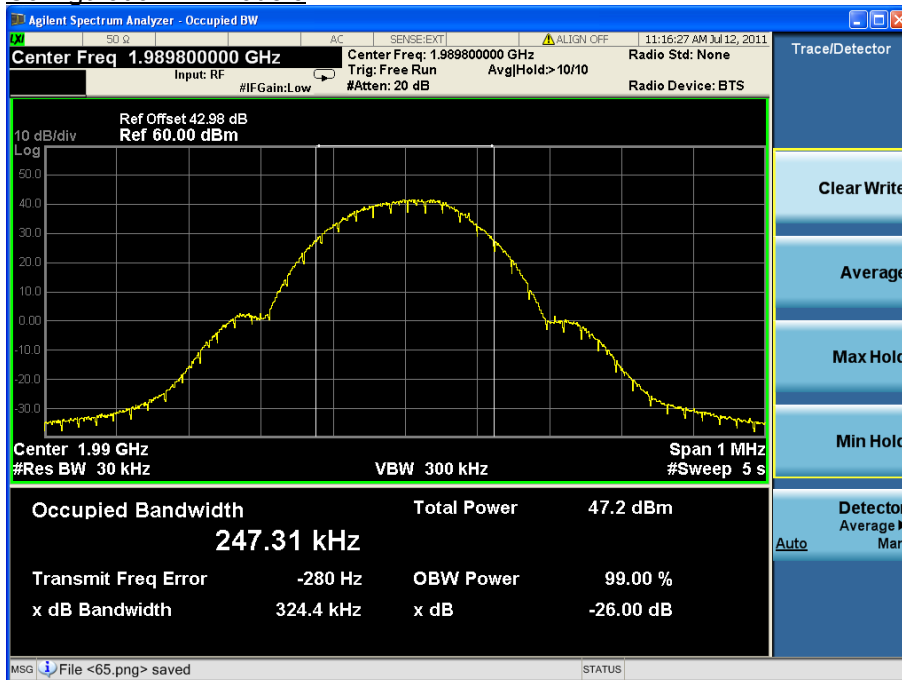



Product Service

## 2.5 SPURIOUS EMISSIONS AT ANTENNA TERMINALS ( $\pm 1$ MHz)

### 2.5.1 Specification Reference

FCC CFR 47 Part 2, Clause 2.1051  
 FCC CFR 47 Part 24, Clause 24.238 (b)  
 Industry Canada RSS-133 Clause 6.5

### 2.5.2 Equipment Under Test

RRUS 01 B2 / KRC 118 74/2, S/N: CB4J458260

### 2.5.3 Date of Test and Modification State

13 July 2011 – Modification State 0

### 2.5.4 Test Equipment Used

The major items of test equipment used for the above tests are identified in Section 3.1.

### 2.5.5 Test Method and Operating Modes

The test was applied in accordance with the test method requirements of FCC CFR 47 Part 2 and Part 24 and Industry Canada RSS-133.

In accordance with 24.238(b), at least 1% of the 26dB bandwidth was used for the resolution and video bandwidths up to 1MHz away from the block edge. A resolution bandwidth of 50kHz was used between 1MHz to 5MHz away from the band edge. As the FCC rules specify a RBW of 1MHz for measurements of emissions > 1MHz away from the band edges, the limit was adjusted with -13dB to -26dBm to compensate for the reduced measurement bandwidth. Spectrum analyser detector was set as RMS.

The path loss measured and entered as a reference level offset.

The EUT was tested at its maximum power level with all timeslots activated.

The test was performed with the EUT in the following configurations and modes of operation as the worst cases:

Configuration 1 - Mode 1'  
                           - Mode 3'  
                           - Mode 4'  
                           - Mode 6'

### 2.5.6 Environmental Conditions

	13 July 2011
Ambient Temperature	26.9°C
Relative Humidity	55.1%





Product Service

**2.5.7 Test Results**

For the period of test the EUT met the requirements of FCC CFR 47 Part 2 and Part 24 and Industry Canada RSS-133 for Spurious Emissions Antenna Terminals ( $\pm 1\text{MHz}$ )

Below are the Frequencies the EUT was tested against along with the tested channels.

Remark:

The channel adjacent to the lower and higher band-edge cannot be used. The lowest usable channel is 513 (1930.4MHz), the highest usable channel is 809 (1989.6MHz)

**Configuration 1 - Mode 1' and 3'**

Band Edge Frequency	Edge Test with GMSK modulation Channel No./Frequencies	Edge Test with 8PSK modulation Channel No./Frequencies
Bottom 1930MHz	Channel: 513 Frequency: 1930.4 MHz	Channel: 513 Frequency: 1930.4 MHz
Top 1990MHz	Channel: 809 Frequency: 1989.6 MHz	Channel: 809 Frequency: 1989.6 MHz

**Configuration 1 - Mode 4' and 6'**

Band Edge Frequency	Edge Test with GMSK modulation Channel No./Frequencies	Edge Test with 8PSK modulation Channel No./Frequencies
Bottom 1930MHz	Channel: 513 & 515 Frequency: 1930.4 MHz & 1930.8MHz	Channel: 513 & 515 Frequency: 1930.4 MHz & 1930.8MHz
Top 1990MHz	Channel: 807 & 809 Frequency: 1989.2MHz & 1989.6 MHz	Channel: 807 & 809 Frequency: 1989.2MHz & 1989.6 MHz

The channels shown in the table above are the minimum and maximum channels that can be used in the authorised frequency ranges to maintain compliance. Channels used outside of those stated and power levels used beyond those stated in the table exceed the specification limits, thus they cannot be used.

The channels outside of those shown in the table above were not tested at lower power levels to determine a level at which compliance would be achieved. Therefore, to maintain compliance, only the channels shown in the table above shall be used.



The test results are shown below

**Single Carrier**

**GMSK**

**Configuration 1 - Mode 1'**

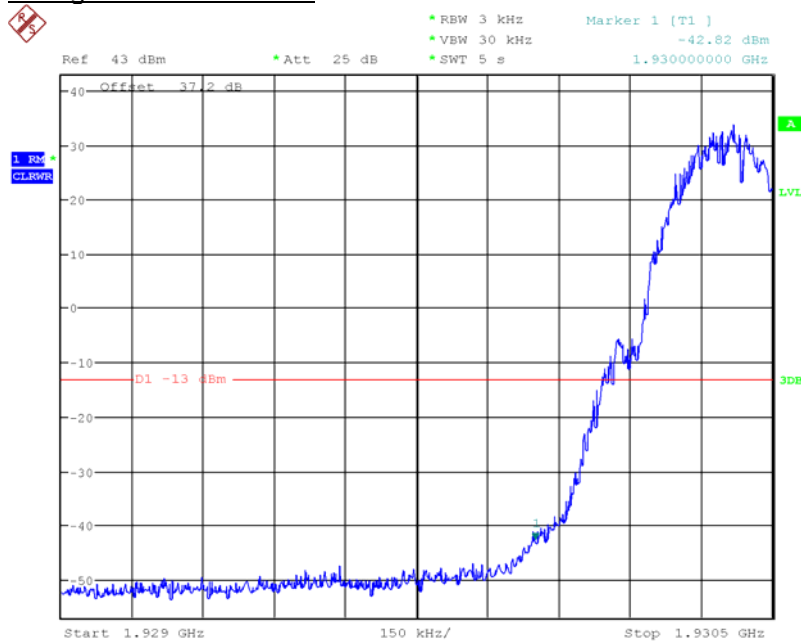

Date: 12.JUL.2011 17:21:23

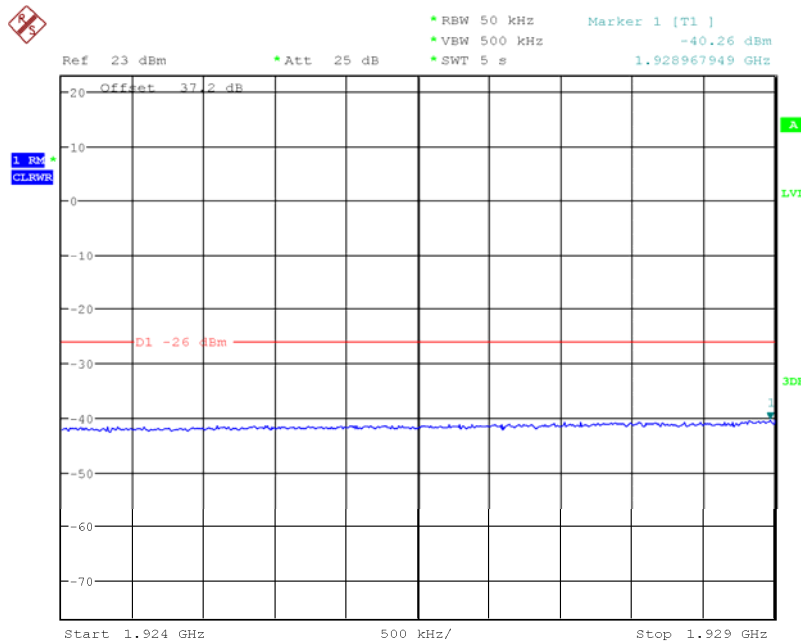

Date: 12.JUL.2011 17:24:23



Configuration 1 – Mode 3'

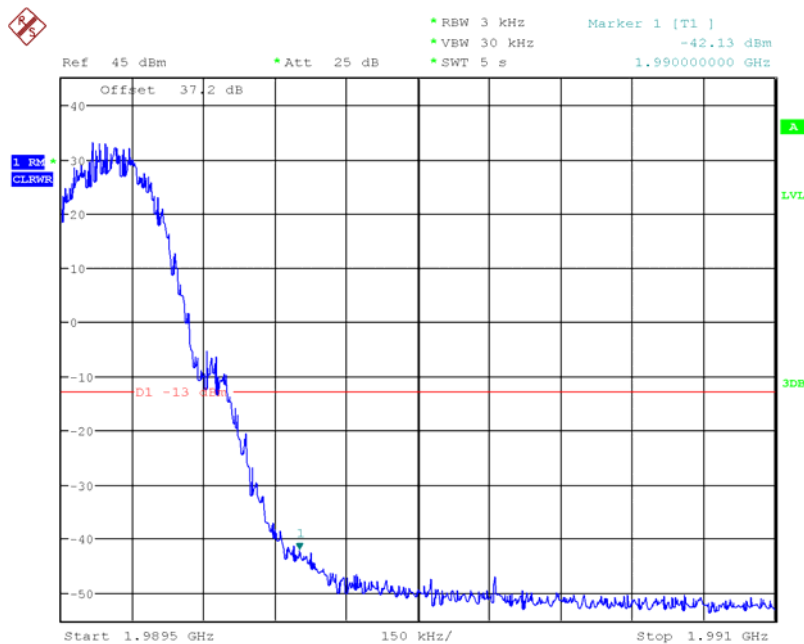

Date: 12.JUL.2011 17:45:33

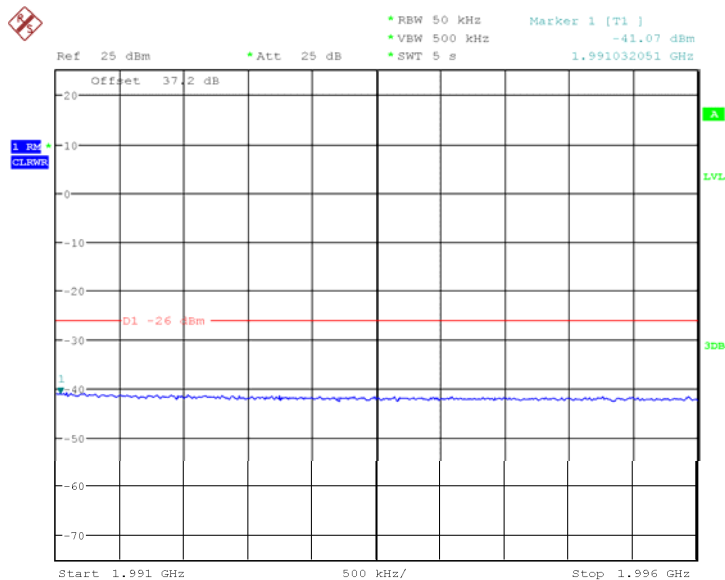

Date: 12.JUL.2011 17:44:15



Product Service

### 8PSK

#### Configuration 1 - Mode 1'

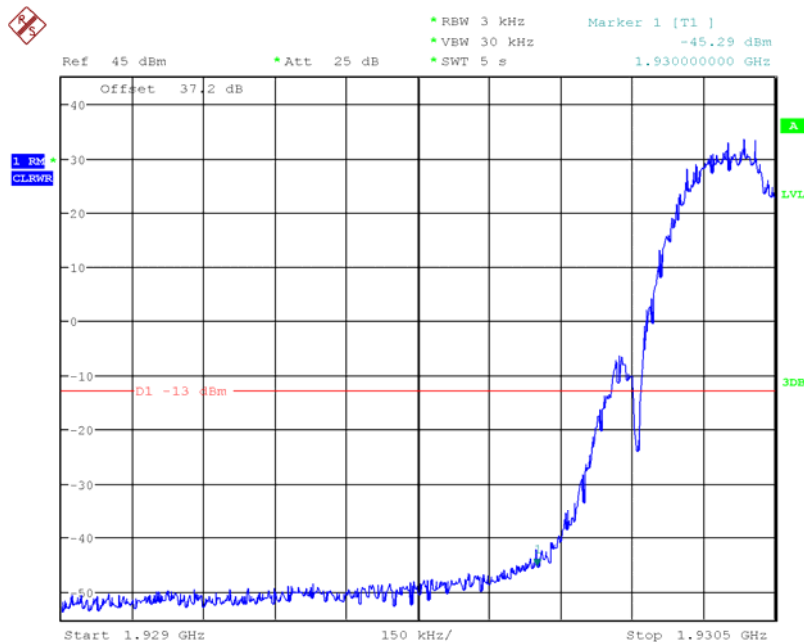

Date: 12.JUL.2011 17:32:45

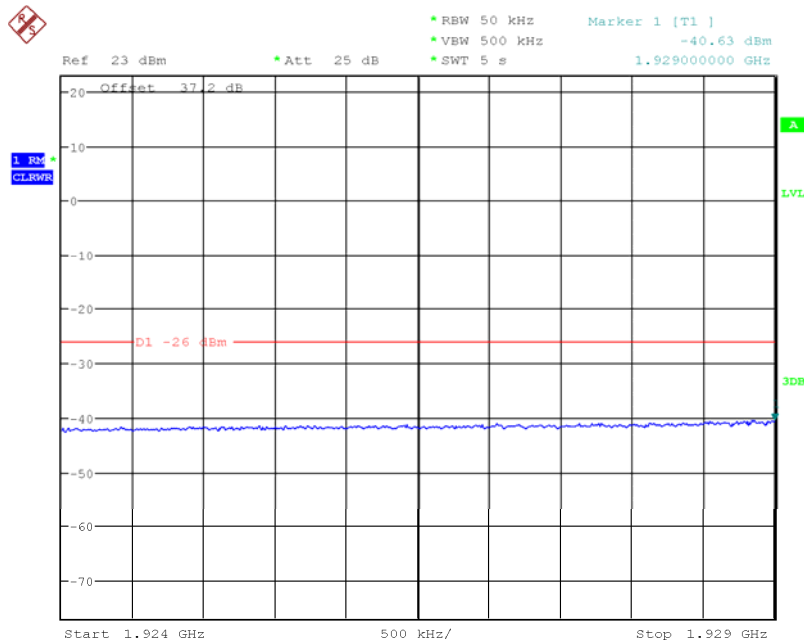

Date: 12.JUL.2011 17:29:17



Configuration 1 - Mode 3'

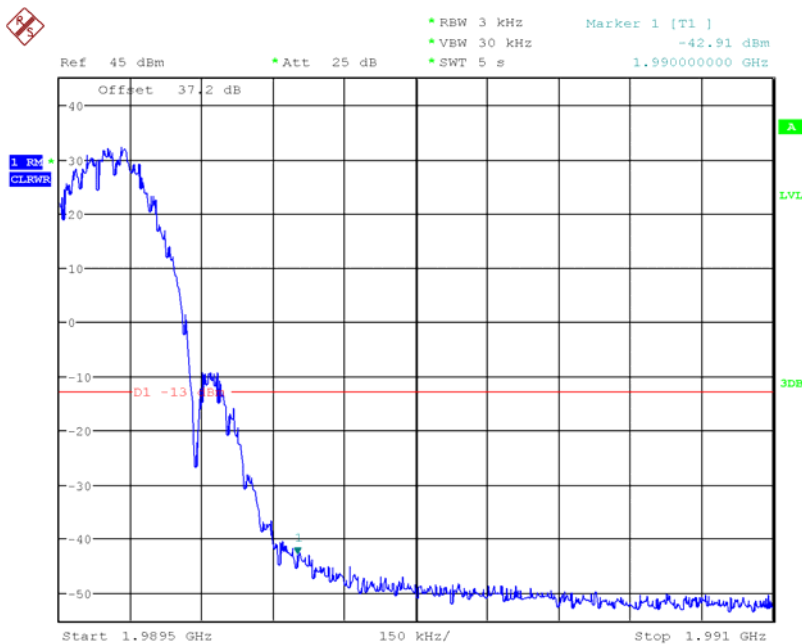

Date: 12.JUL.2011 17:46:41

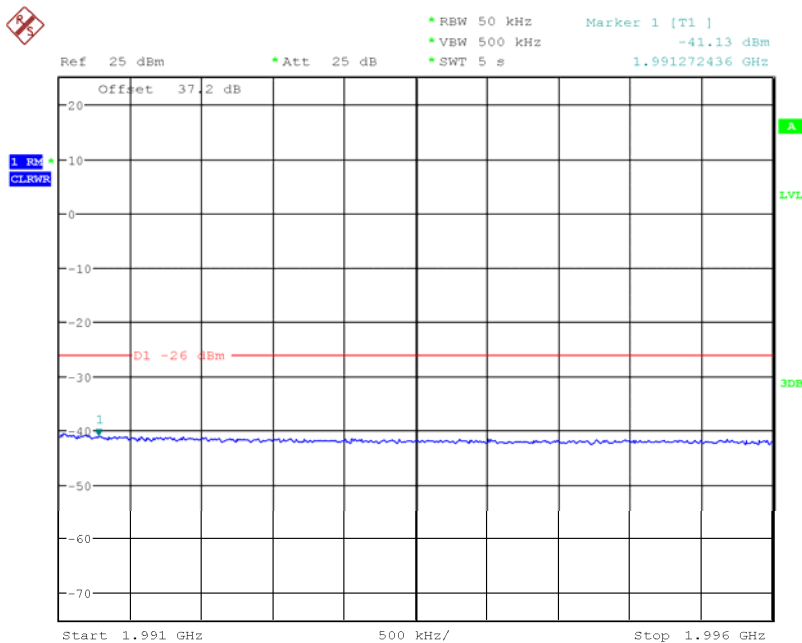

Date: 12.JUL.2011 17:47:54



**Multi Carrier (1x2)**

**GMSK**

**Configuration 1 - Mode 4'**

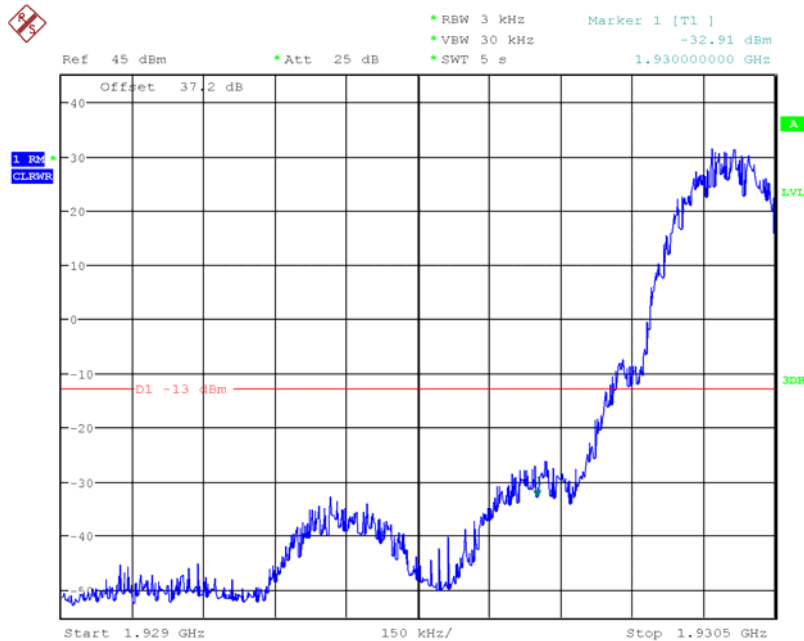

Date: 12.JUL.2011 18:06:02

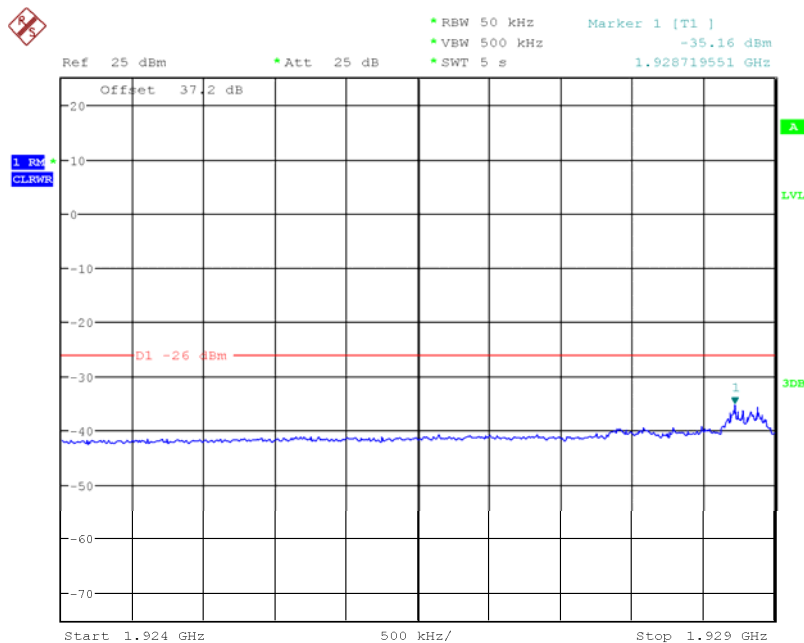

Date: 12.JUL.2011 18:07:33



Configuration 1 - Mode 6'

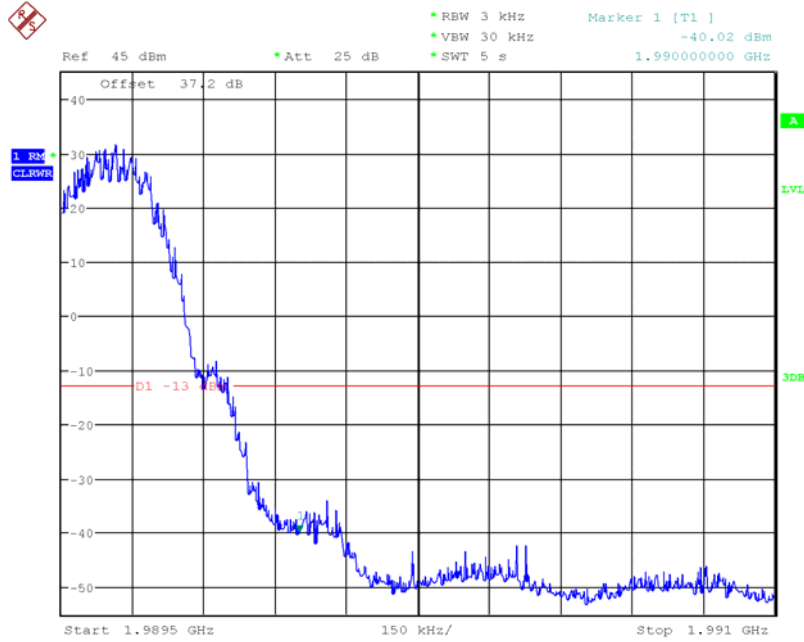

Date: 12.JUL.2011 18:17:10

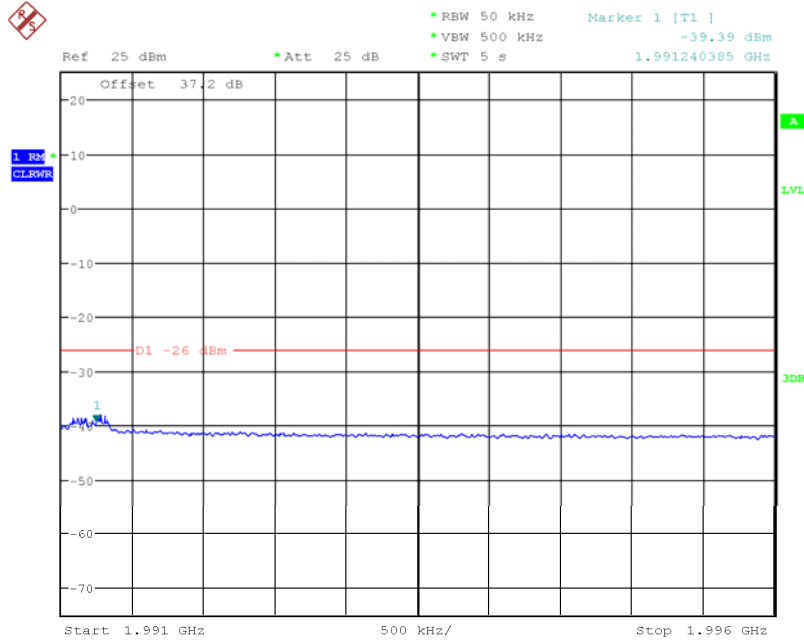

Date: 12.JUL.2011 18:18:20



**8PSK**

**Configuration 1 - Mode 4'**

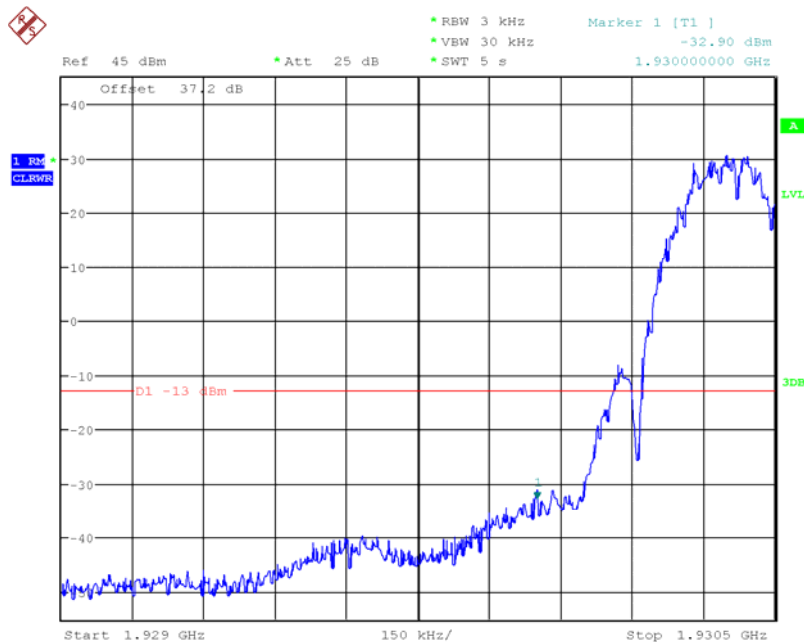

Date: 12.JUL.2011 18:10:54

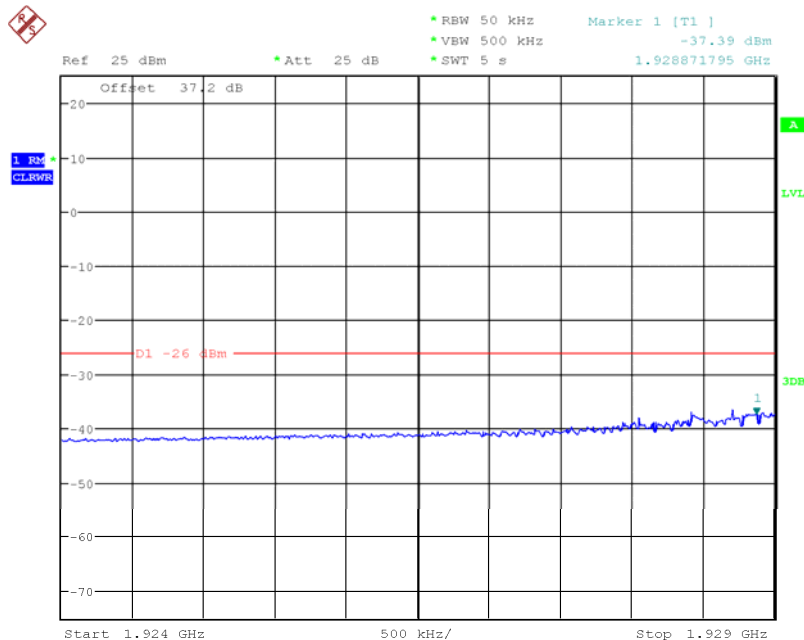

Date: 12.JUL.2011 18:09:20





Configuration 1 - Mode 6'

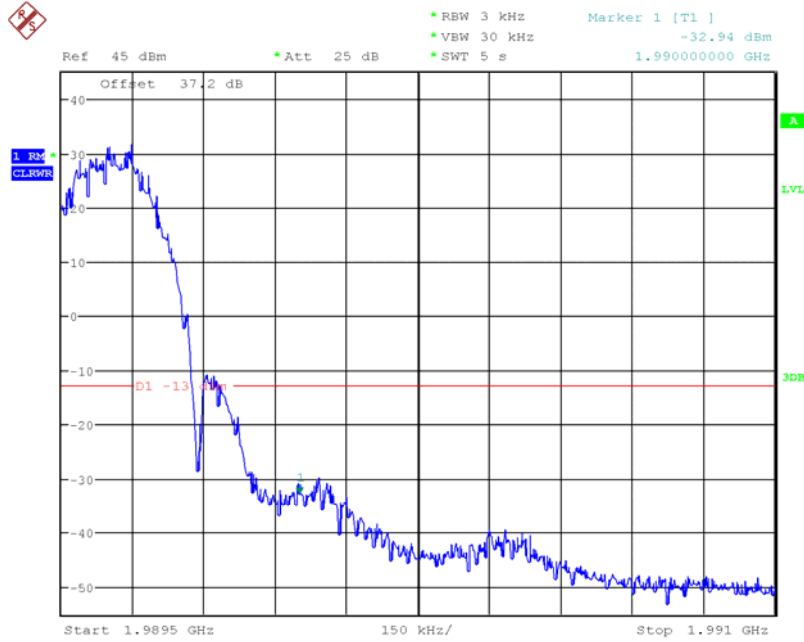

Date: 12.JUL.2011 18:23:14

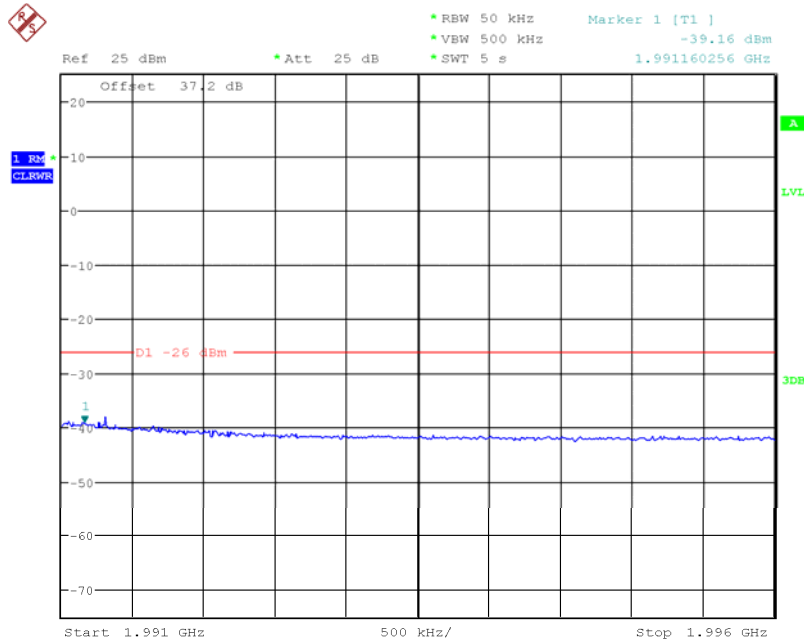

Date: 12.JUL.2011 18:22:10

Limit

The power of any emission outside the frequency band shall be attenuated below the transmitter power (P) by at least  $43 + 10\log P$  dB.



Product Service

## **2.6 RADIATED SPURIOUS EMISSIONS**

### **2.6.1 Specification Reference**

FCC CFR 47 Part 2, Clause 2.1053  
FCC CFR 47 Part 24, 24.238 (a)  
Industry Canada RSS-133, Clause 6.5

### **2.6.2 Equipment Under Test**

RRUS 01 B2 / KRC 118 74/2, S/N: CB4J458260

### **2.6.3 Date of Test and Modification State**

18 to 20 July 2011 – Modification State 0

### **2.6.4 Test Equipment Used**

The major items of test equipment used for the above tests are identified in Section 3.1.

### **2.6.5 Test Method and Operating Modes**

The test was applied in accordance with the test method requirements of FCC CFR 47 Part 2 and Part 24 and Industry Canada RSS-133.

A preliminary profile of the Spurious Radiated Emissions was obtained by operating the EUT on a remotely controlled turntable within the chamber. Measurements of emissions from the EUT were obtained with the Measurement Antenna in both Horizontal and Vertical Polarizations.

Emissions identified within the range 30MHz – 25GHz were then formally measured using a Peak detector as the worst case.

In the frequency Range 30MHz – 25GHz, the measurement was performed with a resolution bandwidth of 1MHz.

The measurements were performed at a 3m distance unless otherwise stated.

The limits for Spurious Emissions have been calculated, as shown below using the following formula:

Field Strength of Carrier -  $(43 + 10\text{Log}(P))$  dB

Where:

Field Strength is measured in dB $\mu$ V/m

P is measured Transmitter Power in Watts



### **Determination of Spurious Emission Limit**

As the EUT does not have an integral antenna, the field strength of the carrier has been calculated assuming that the power is to be fed to a half-wave tuned dipoles as per 2.1053 (a).

$$E_{(v/m)} = (30 \times G_i \times P_o)^{0.5} / d$$

Where  $G_i$  is the antenna gain of ideal half-wave dipoles,  
 $P_o$  is the power out of the transceiver in W,  
 $d$  is the measurement distance in meter.

Therefore at 3m measurement distance the field strength using the lowest transceiver output power would be:

$$E_{(v/m)} = (30 \times 1.64 \times 7.82)^{0.5} / 3 = 6.54V/m = 136.33dB\mu V/m$$

As per 24.238(a) the spurious emission must be attenuated by  $43 + 10\log(P_o)$  dB this gives:

$$43 + 10\log(7.82) = 51.93dB$$

Therefore the limit at 3m measurement distance is:

$$136.33 - 51.93 = 84.4 \text{ dB}\mu V/m$$

This limit has been used to determine Pass or Fail for the harmonics measured and detailed in the following results.

The test was performed with the EUT in the following configurations and modes of operation:

- Configuration 1 - Mode 2  
 - Mode 4  
 - Mode 5  
 - Mode 6  
 - Mode 8

### **2.6.6 Environmental Conditions**

	18 July 2011	19 July 2011	20 July 2011
Ambient Temperature	25.3°C	26.9°C	25.1°C
Relative Humidity	46.5%	46.9%	46.0%



## 2.6.7 Test Results

For the period of test the EUT met the requirements of FCC CFR 47 Part 2 & Part 24 and Industry Canada RSS-133 for Radiated Spurious Emissions.

The test results are shown below

Note: Only the worst case results plots have been included as all of the emissions are greater than 20dB below the limit. A set of plots have been included to show the measurement system noise floor.

### Single Carrier

#### GMSK

Configuration 1 – Mode 2

No emissions were detected within 20dB of the limit.

#### 8PSK

Configuration 1 – Mode 2

No emissions were detected within 20dB of the limit.

#### 16QAM

Configuration 1 – Mode 2

No emissions were detected within 20dB of the limit.

#### 32QAM

Configuration 1 – Mode 2

No emissions were detected within 20dB of the limit.

#### AQPSK

Configuration 1 – Mode 2

No emissions were detected within 20dB of the limit.



Product Service

**Multi Carrier (1x2)**

**16QAM**

Configuration 1 - Mode 4

No emissions were detected within 20dB of the limit.

Configuration 1 – Mode 5

30MHz – 1GHz

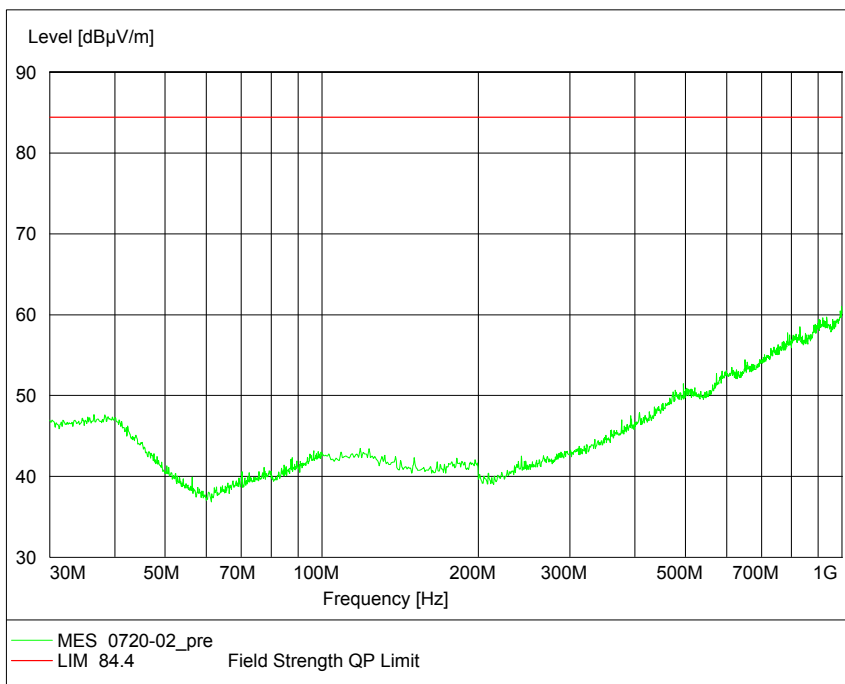



Product Service

1GHz - 18GHz

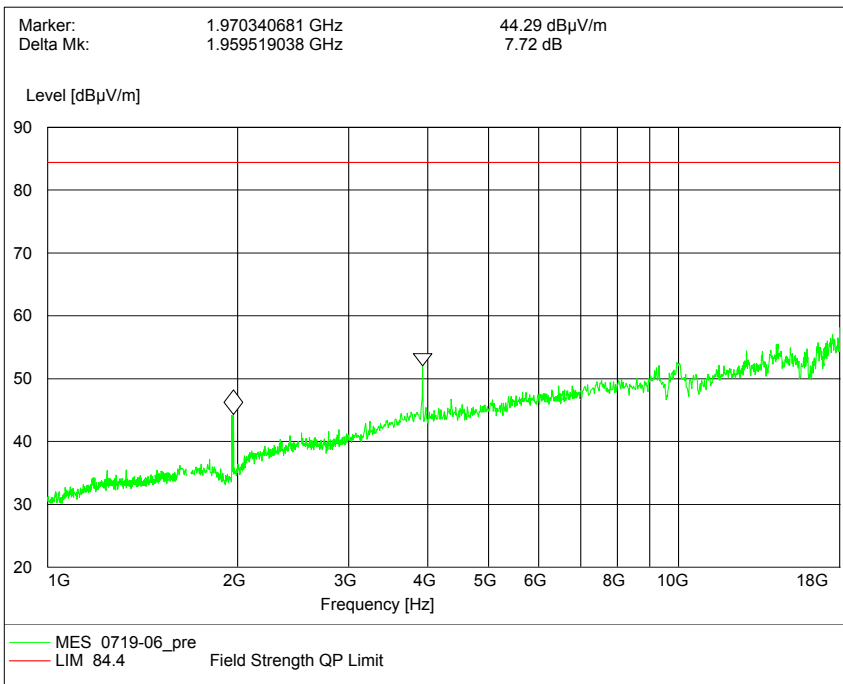

18GHz -25GHz

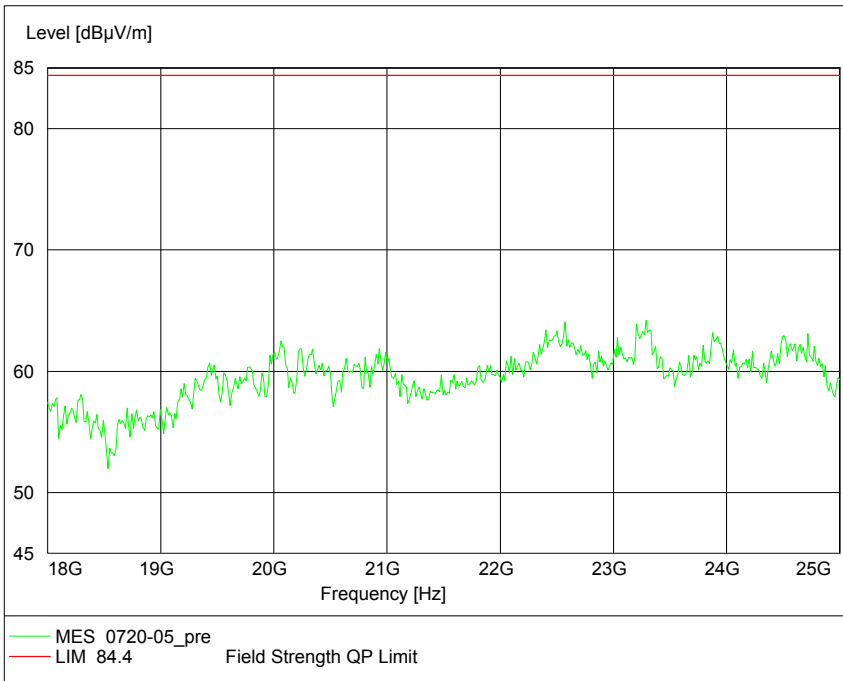



Product Service

Configuration 1 – Mode 6

No emissions were detected within 20dB of the limit.

**Multi Carrier (1x4)**

**16QAM**

Configuration 1 - Mode 8

No emissions were detected within 20dB of the limit.

Limit	-13dBm
-------	--------

Remarks

The EUT does not exceed -13dBm at the measured frequencies.



Product Service

## 2.7 CONDUCTED SPURIOUS EMISSIONS

### 2.7.1 Specification Reference

FCC CFR 47 Part 2, Clause 2.1051  
FCC CFR 47 Part 24, 24.238 (a)  
Industry Canada RSS-133, Clause 6.5

### 2.7.2 Equipment Under Test

RRUS 01 B2 / KRC 118 74/2, S/N: CB4J458260

### 2.7.3 Date of Test and Modification State

15 July 2011 – Modification State 0

### 2.7.4 Test Equipment Used

The major items of test equipment used for the above tests are identified in Section 3.1.

### 2.7.5 Test Method and Operating Modes

The test was applied in accordance with the test method requirements of FCC CFR 47 Part 2 and Part 24 and Industry Canada RSS-133.

In accordance with Part 2.1051, the spurious emissions from the antenna terminal were measured. The transmitter output power was attenuated using an attenuator and the frequency spectrum investigated from 9kHz to 25GHz. The EUT was set to transmit on maximum power. The resolution was set to 1MHz for 9kHz to 25GHz thus meeting the requirements of Part 24.238(b). The spectrum analyser detector was set to peak and trace was kept on Max Hold.

The maximum path loss across the measurement band was used as the reference level offset to ensure worst case.

In addition, measurements were made up to the 10<sup>th</sup> harmonics of the highest internal frequency.

The test was performed with the EUT in the following configurations and modes of operation as the worst cases:

Configuration 1 - Mode 1  
                          - Mode 2  
                          - Mode 3

### 2.7.6 Environmental Conditions

	15 July 2011
Ambient Temperature	25.9°C
Relative Humidity	55.8%





**2.7.7 Test Results**

For the period of test the EUT met the requirements of FCC CFR 47 Part 2 and Part 24 and Industry Canada RSS-133 for Conducted Spurious Emissions.

The test results are shown below

Remark:

The emissions at 9kHz on the plots was not generated by the test object. A complementary measurement with a smaller Span showed that it was related to the LO feedthrough.

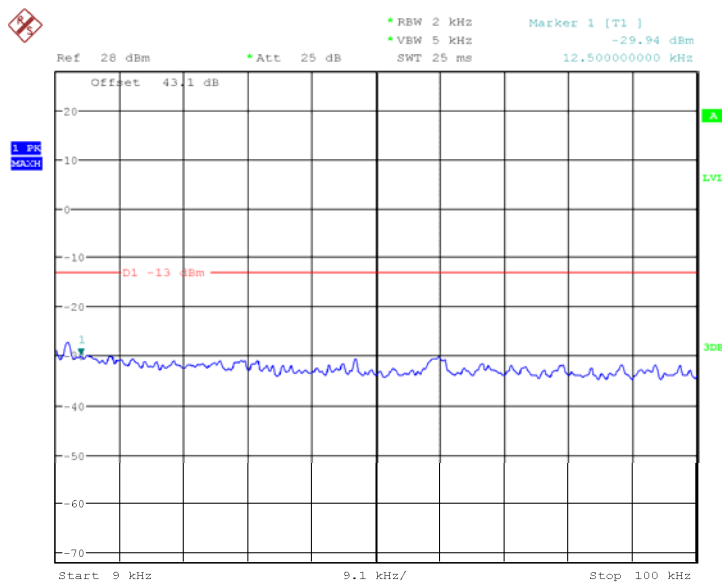

Date: 15.JUL.2011 16:40:53



Product Service

**Single Carrier**

**GMSK**

**Configuration 1 - Mode 1**

**9kHz to 3GHz**

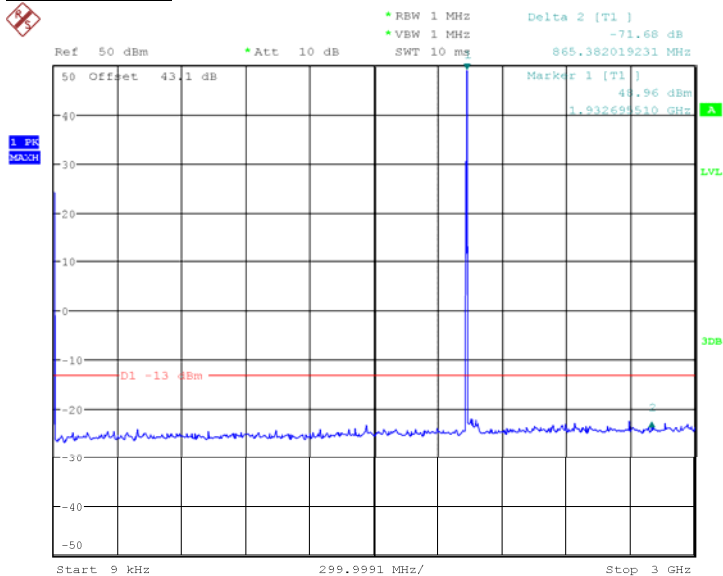

Date: 15.JUL.2011 12:20:14

Note: The emission beyond the limit is the operating frequency.

**3GHz to 10GHz**

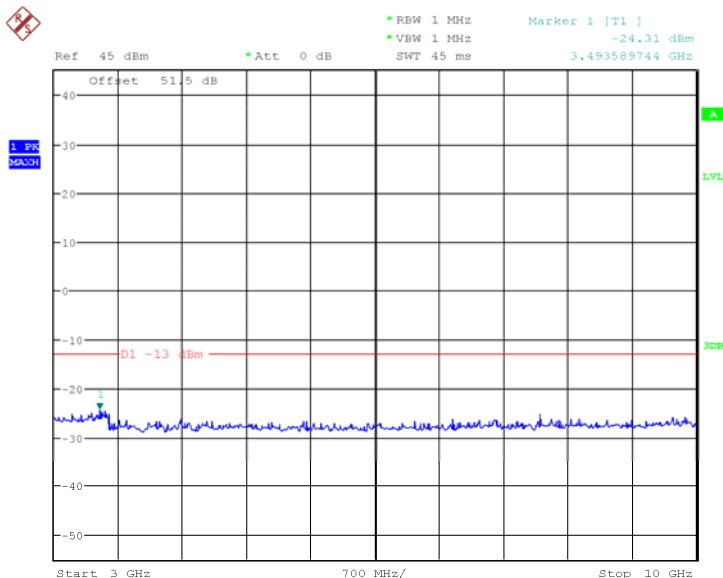

Date: 15.JUL.2011 15:32:40



Product Service

10GHz – 25GHz

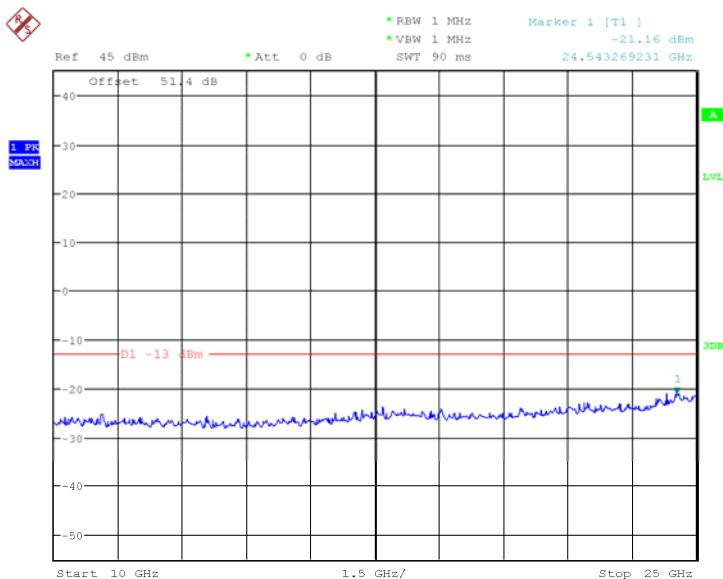

Date: 15.JUL.2011 16:56:04

Configuration 1 - Mode 2

9kHz to 3GHz

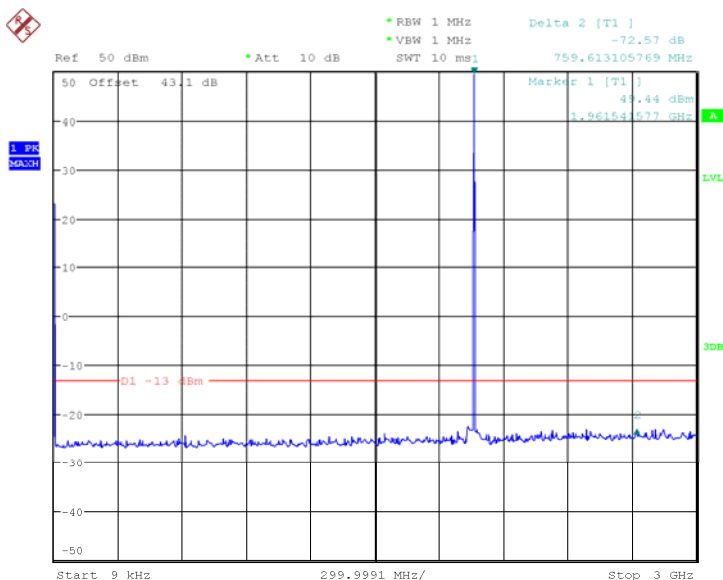

Date: 15.JUL.2011 14:05:53

Note: The emission beyond the limit is the operating frequency.



Product Service

3GHz to 10GHz

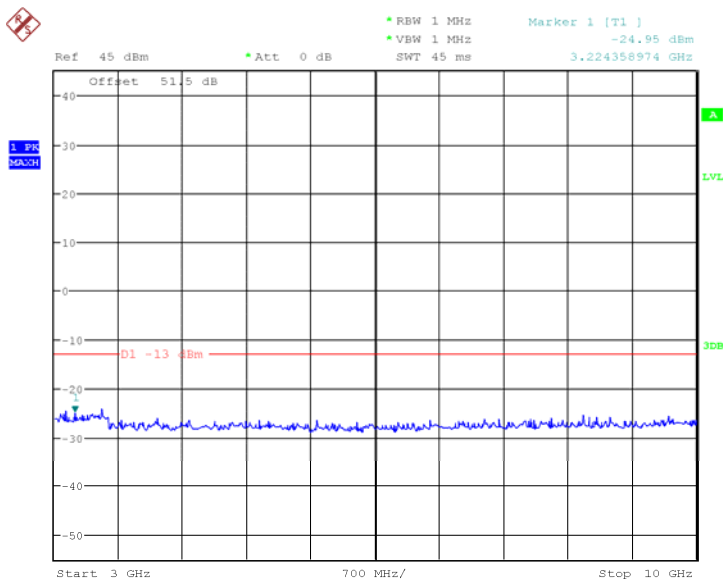

Date: 15.JUL.2011 15:22:34

10GHz to 25GHz

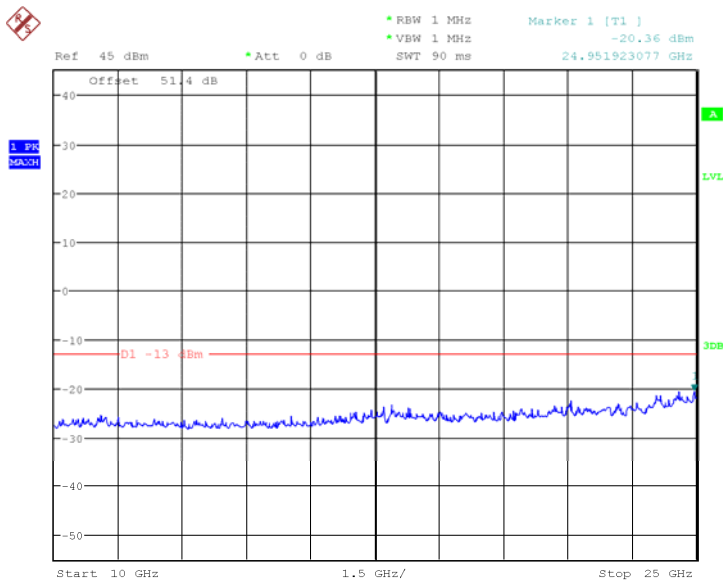

Date: 15.JUL.2011 17:00:22



Product Service

Configuration 1 – Mode 3

9kHz – 3GHz

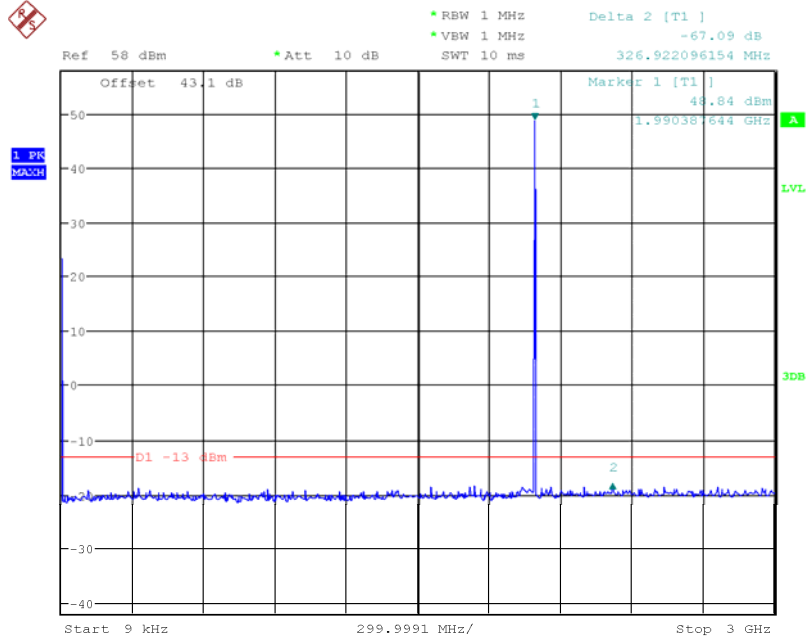

Date: 15.JUL.2011 17:08:02

Note: The emissions beyond the limit are the operating frequencies.

3GHz – 10GHz

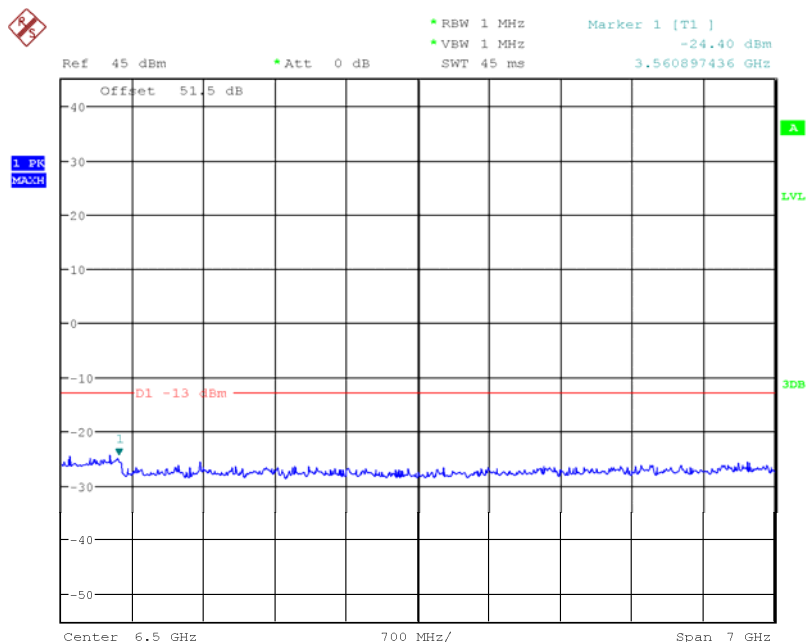

Date: 15.JUL.2011 15:27:01



**10GHz – 25GHz**

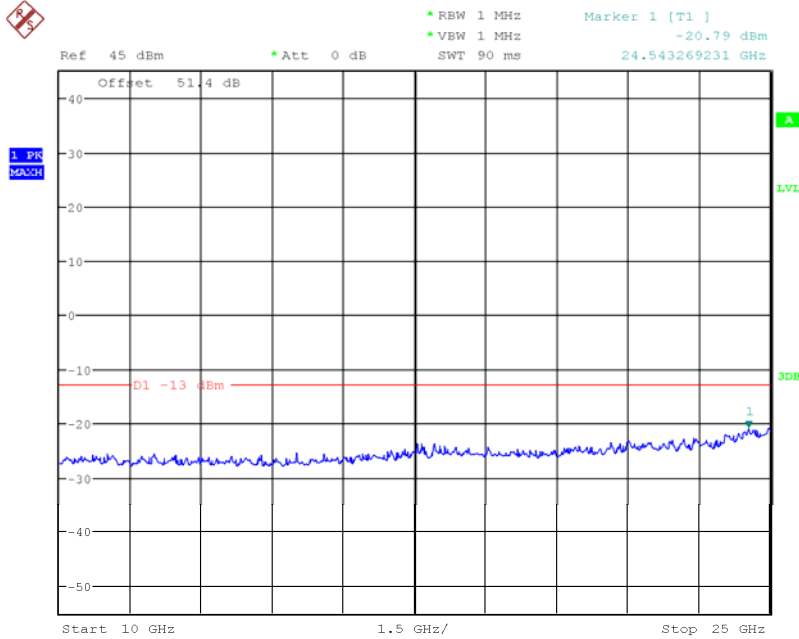

Date: 15.JUL.2011 17:09:32

**8PSK**

**Configuration 1 - Mode 1**

**9kHz to 3GHz**

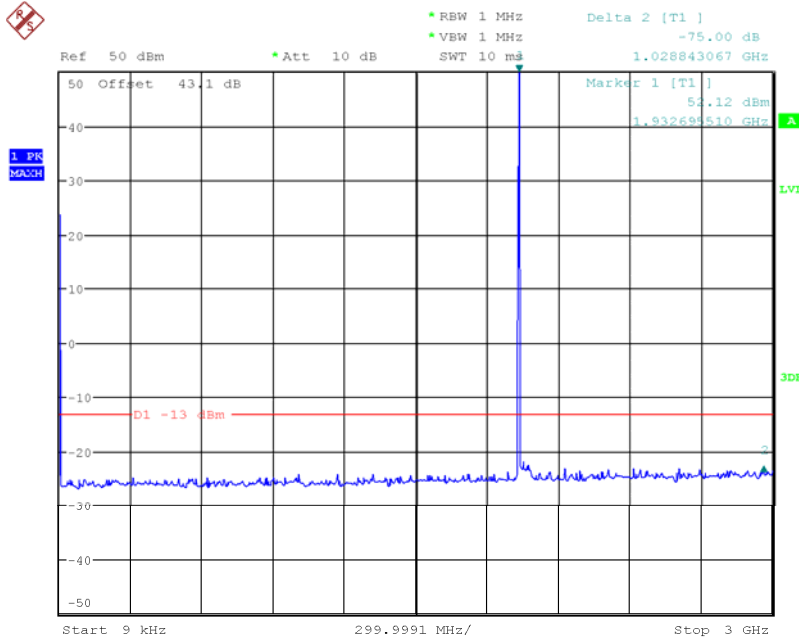

Date: 15.JUL.2011 12:31:48

Note: The emission beyond the limit is the operating frequency.



3GHz to 10GHz

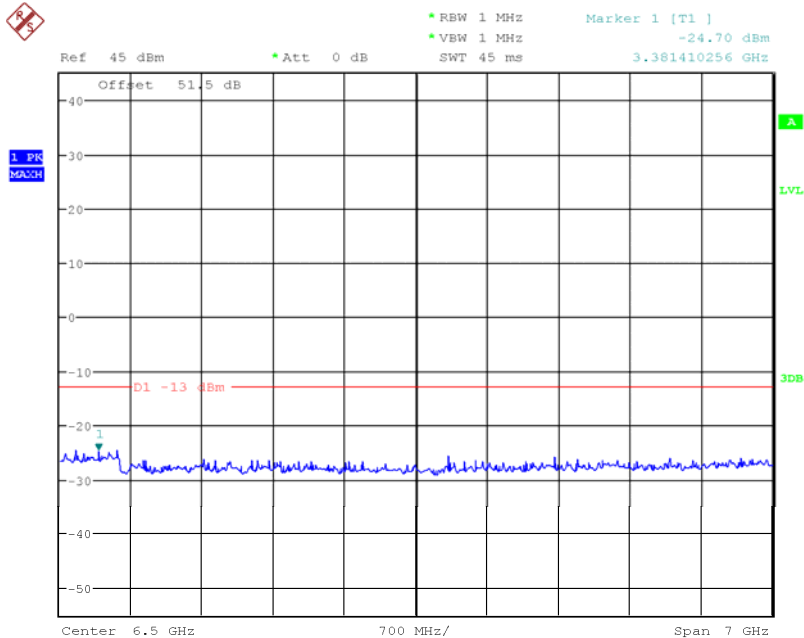

Date: 15.JUL.2011 15:31:07

10GHz – 25GHz

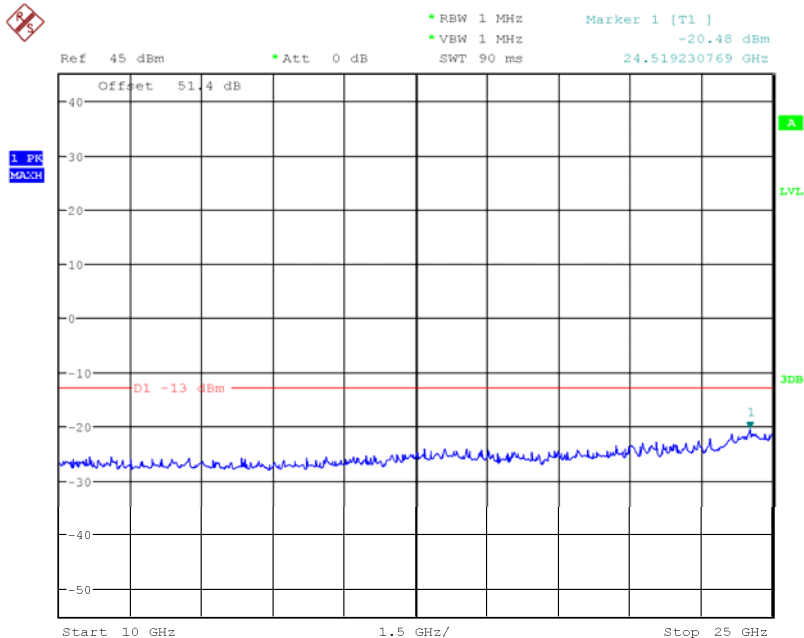

Date: 15.JUL.2011 16:57:40



Configuration 1 - Mode 2

9kHz to 3GHz

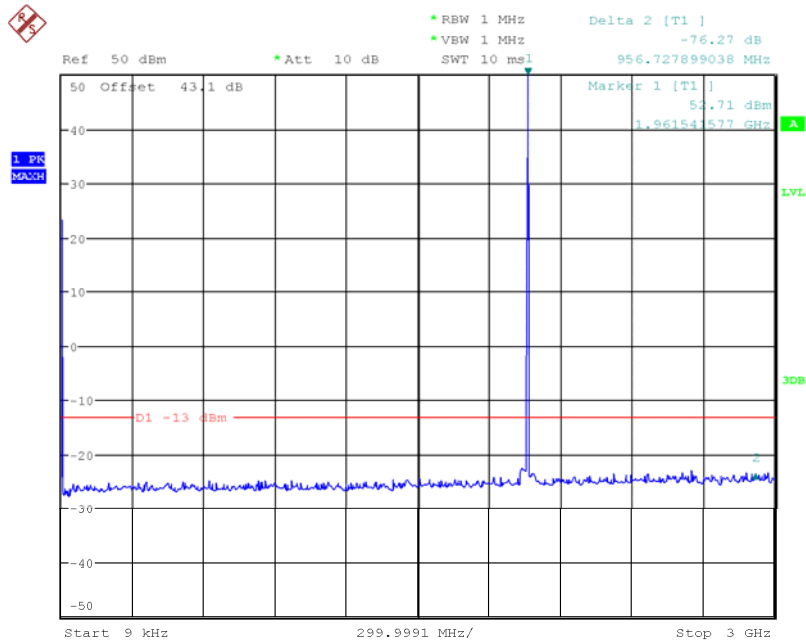

Date: 15.JUL.2011 14:09:07

Note: The emission beyond the limit is the operating frequency.

3GHz to 10GHz

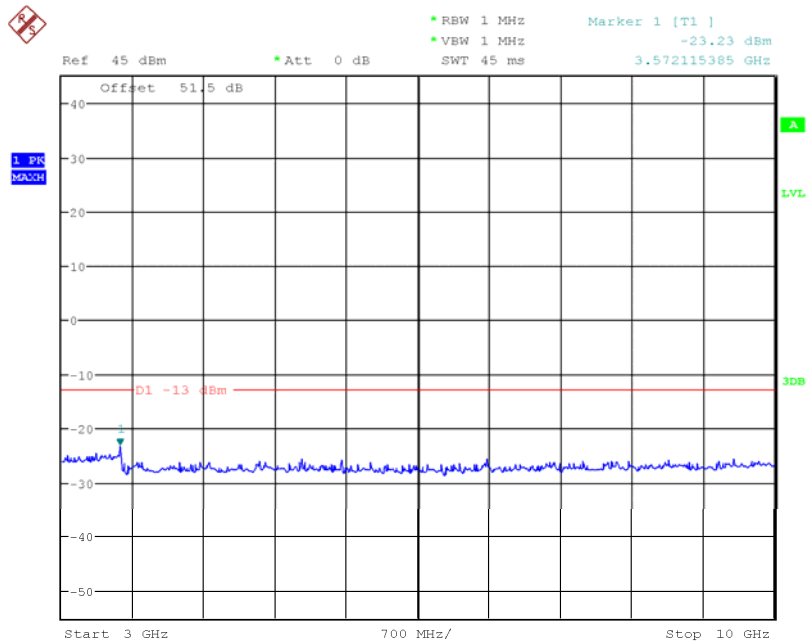

Date: 15.JUL.2011 15:19:01





10GHz to 25GHz

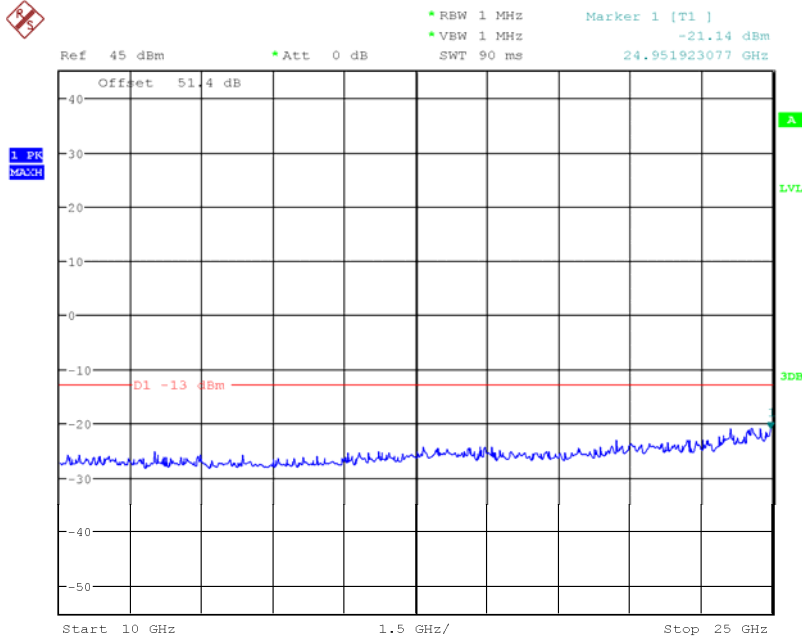

Date: 15.JUL.2011 16:59:17

Configuration 1 – Mode 3

9kHz – 3GHz

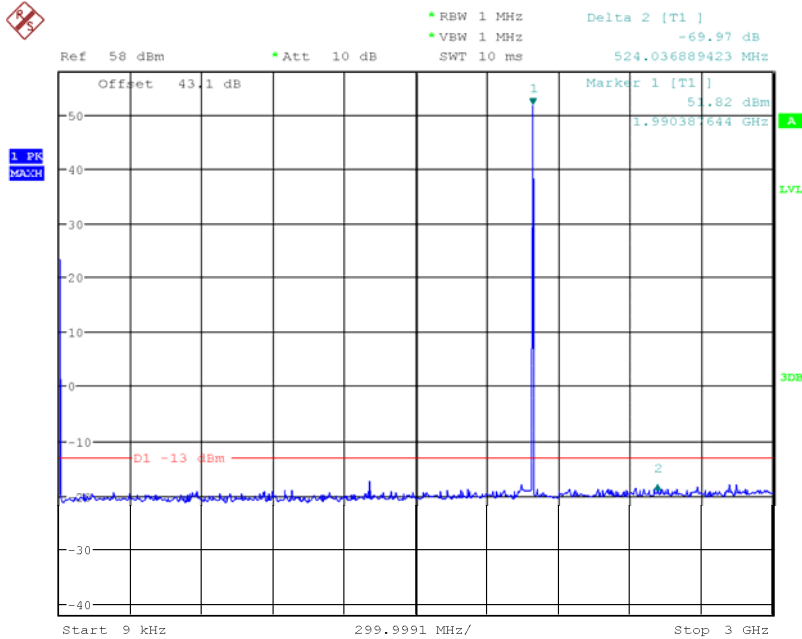

Date: 15.JUL.2011 17:11:44

Note: The emissions beyond the limit are the operating frequencies.



Product Service

3GHz – 10GHz

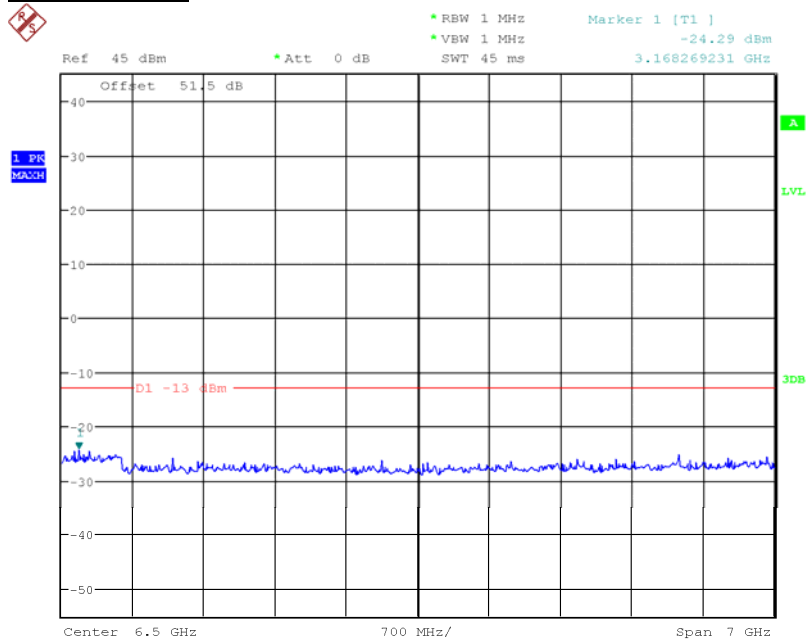

Date: 15.JUL.2011 15:28:07

10GHz – 25GHz

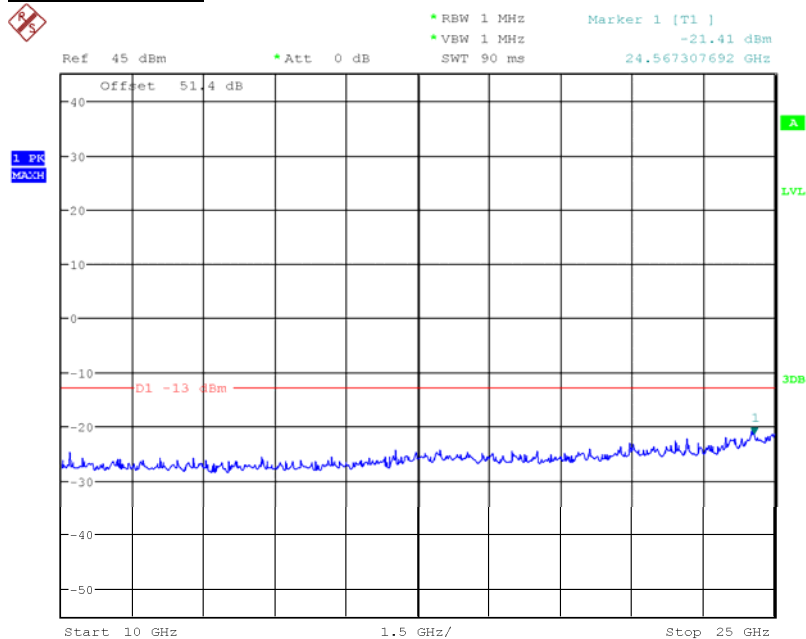

Date: 15.JUL.2011 17:10:27

Limit	-13dBm
-------	--------

Remarks

The EUT does not exceed -13dBm at the frequency range of 9kHz to 25GHz.



Product Service

## **2.8 FREQUENCY STABILITY UNDER TEMPERATURE VARIATIONS**

### **2.8.1 Specification Reference**

FCC CFR 47 Part 2, Clause 2.1055  
FCC CFR 47 Part 24, Clause 24.235  
Industry Canada RSS-133, Clause 6.3

### **2.8.2 Equipment Under Test**

RRUS 01 B2 / KRC 118 74/2, S/N: CB4J458260

### **2.8.3 Date of Test and Modification State**

14 July 2011 – Modification State 0

### **2.8.4 Test Equipment Used**

The major items of test equipment used for the above tests are identified in Section 3.1.

### **2.8.5 Test Method and Operating Modes**

The test was applied in accordance with the test method requirements of FCC CFR 47 Part 2 and Part 24 and Industry Canada RSS-133.

The EUT was set to transmit on maximum power. A Spectrum Analyser was used to measure the frequency error. The temperature was adjusted between -30°C and +50°C in 10°C steps as per 2.1055.

The test was performed with the EUT in the following configurations and modes of operation:

Configuration 1 - Mode 2

### **2.8.6 Environmental Conditions**

	14 July 2011
Ambient Temperature	25.2°C
Relative Humidity	58.1%



Product Service

**2.8.7 Test Results**

For the period of test the EUT met the requirements of FCC CFR 47 Part 2 and Part 24 and Industry Canada RSS-133 for Frequency Stability Under Temperature Variations.

The test results are shown below

Power Supply: -48V DC

**Configuration 1 - Mode 2**

GMSK

Temperature Interval (°C)	Deviation (Hz)
-30	-12.11
-20	-11.08
-10	-10.86
0	-11.84
+10	10.35
<b>+20</b>	<b>9.81</b>
+30	-9.38
+40	-10.19
+50	-10.32

8PSK

Temperature Interval (°C)	Deviation (Hz)
-30	-14.32
-20	-12.36
-10	-11.61
0	-12.33
+10	-14.31
<b>+20</b>	<b>-11.87</b>
+30	11.37
+40	-11.89
+50	11.03

Limit	±1.0 ppm or ±1.96kHz
-------	----------------------

Remarks

The frequency stability of the EUT is sufficient to keep it within the authorised frequency ranges under voltage variations across the measured range.



Product Service

## **2.9 FREQUENCY STABILITY UNDER VOLTAGE VARIATIONS**

### **2.9.1 Specification Reference**

FCC CFR 47 Part 2, Clause 2.1055  
FCC CFR 47 Part 24, Clause 24.235  
Industry Canada RSS-133, Clause 6.3

### **2.9.2 Equipment Under Test**

RRUS 01 B2 / KRC 118 74/2, S/N: CB4J458260

### **2.9.3 Date of Test and Modification State**

14 July 2011 – Modification State 0

### **2.9.4 Test Equipment Used**

The major items of test equipment used for the above tests are identified in Section 3.1.

### **2.9.5 Test Method and Operating Modes**

The test was applied in accordance with the test method requirements of FCC CFR 47 Part 2 and Part 24 and Industry Canada RSS-133.

The EUT was set to transmit on maximum power. A Spectrum Analyser was used to measure the frequency error. The supplied voltage was varied from 85 to 115 percent of the nominal value.

The test was performed with the EUT in the following configurations and modes of operation:

Configuration 1 - Mode 2

### **2.9.6 Environmental Conditions**

	14 July 2011
Ambient Temperature	25.2°C
Relative Humidity	58.1%



## 2.9.7 Test Results

For the period of test the EUT met the requirements of FCC CFR 47 Part 2 and Part 24 and Industry Canada RSS-133 for Frequency Stability Under Voltage Variations.

The test results are shown below

Temperature: 20°C

### Configuration 1 - Mode 2

#### GMSK

DC Voltage (V)	Deviation (Hz)
-40.8	-9.43
<b>-48.0</b>	<b>9.81</b>
-55.2	-10.31

#### 8PSK

DC Voltage (V)	Deviation (Hz)
-40.8	-11.67
<b>-48.0</b>	<b>-11.87</b>
-55.2	-11.89

Limit	±1.0 ppm or ±1.96kHz
-------	----------------------

#### Remarks

The frequency stability of the EUT is sufficient to keep it within the authorised frequency ranges under voltage variations across the measured range.



Product Service

## 2.10 RECEIVER SPURIOUS EMISSIONS

### 2.10.1 Specification Reference

Industry Canada RSS-133, Clause 6.6

### 2.10.2 Equipment Under Test

RRUS 01 B2 / KRC 118 74/2, S/N: CB4J458260

### 2.10.3 Date of Test and Modification State

15 July 2011 – Modification State 0

### 2.10.4 Test Equipment Used

The major items of test equipment used for the above tests are identified in Section 3.1.

### 2.10.5 Test Method and Operating Modes

The test was applied in accordance with the test method requirements of Industry Canada RSS-133.

In accordance with RSS-Gen Clause 6.2, the receiver spurious emissions from the antenna terminal were measured. Measurements were performed on the receiver antenna connector RF B. The EUT was set to transmitter mode on the TX connector RF A and during the measurement the Ant A was terminated with match load, (50 Ohm).

The resolution bandwidth was set to 1MHz in the frequency range 9kHz to 13GHz thus meeting the requirements of RSS-Gen Clause 6.2, the spectrum analyser detector was set to peak and trace was kept on Max Hold to give the worst case. The limit line was displayed, showing -57dBm, 2 nanowatts in band 9kHz to 1GHz and above 1GHz, -53dBm, 5 nanowatts.

The maximum path loss across the measurement band was used as the reference level offset to ensure worst case.

In addition, measurements were made from 9kHz up to the 5<sup>th</sup> harmonic of the highest internal frequency.

The test was performed with the EUT in the following configurations and modes of operation as the worst cases:

Configuration 1 - Mode 2

### 2.10.6 Environmental Conditions

	15 July 2011
Ambient Temperature	25.9°C
Relative Humidity	55.8%



Product Service

### 2.10.7 Test Results

For the period of test the EUT met the requirements of Industry Canada RSS-133 for Receiver Spurious Emissions.

The test results are shown below

Remark:

The emissions at 9kHz on the plots was not generated by the test object. A complementary measurement with a smaller Span showed that it was related to the LO feedthrough.

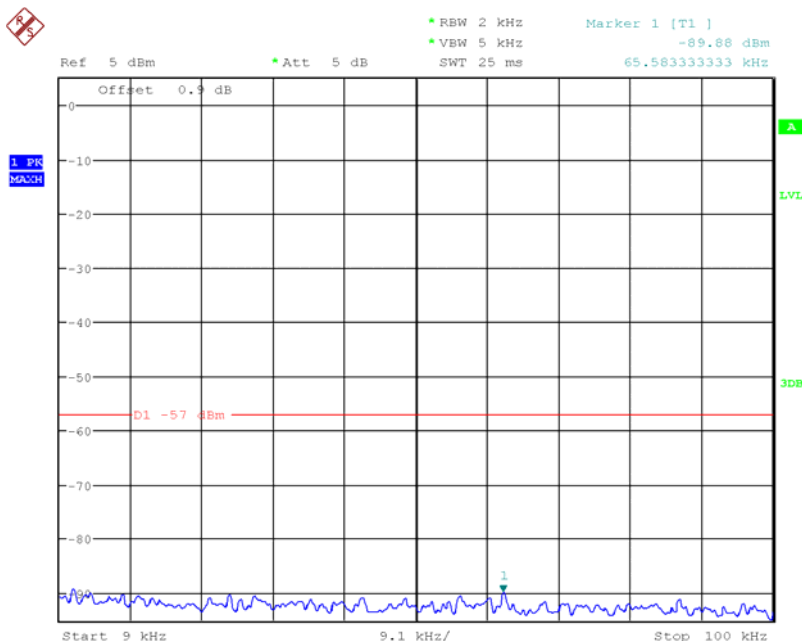

Date: 15.JUL.2011 17:32:28





Product Service

**Configuration 1 - Mode 2**

**Single Carrier**

**GMSK**

**9kHz to 1GHz**

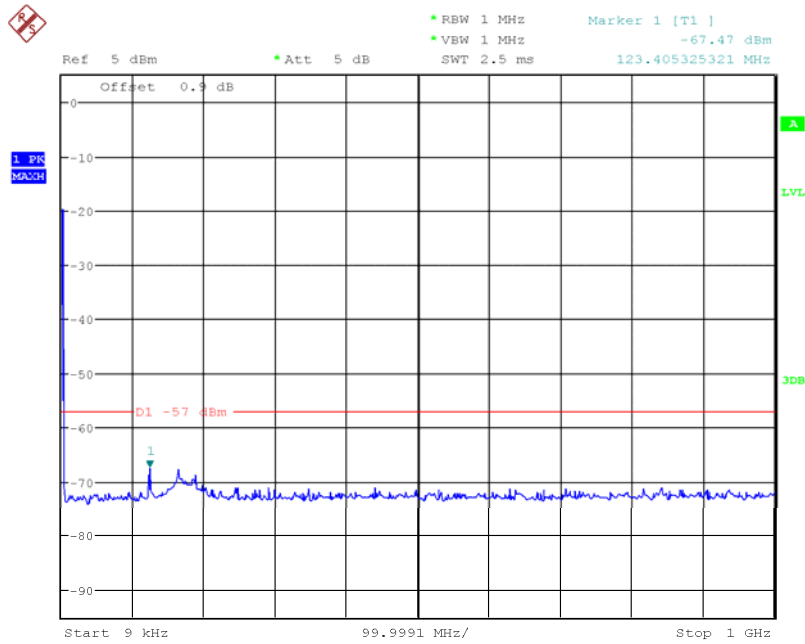

Date: 15.JUL.2011 17:29:33



1GHz to 13GHz

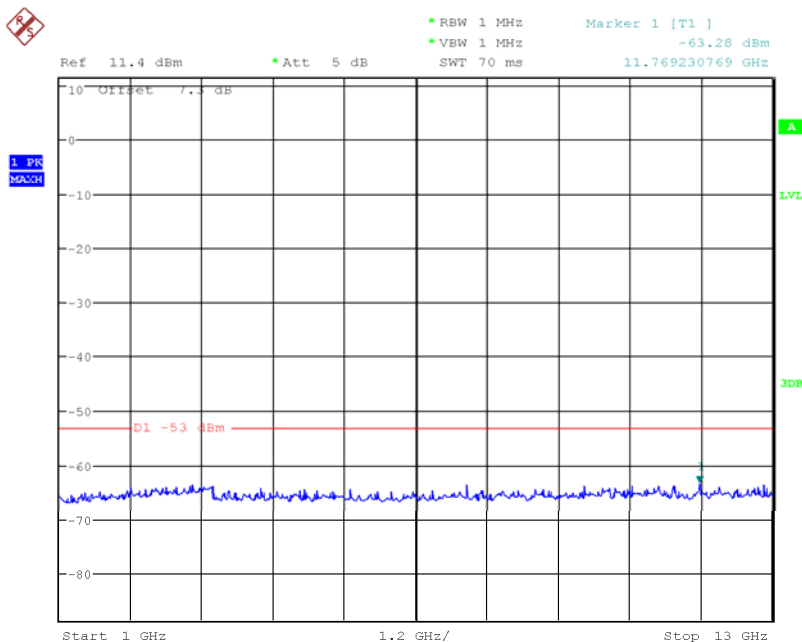

Date: 15.JUL.2011 17:36:18

8PSK

9kHz to 1GHz

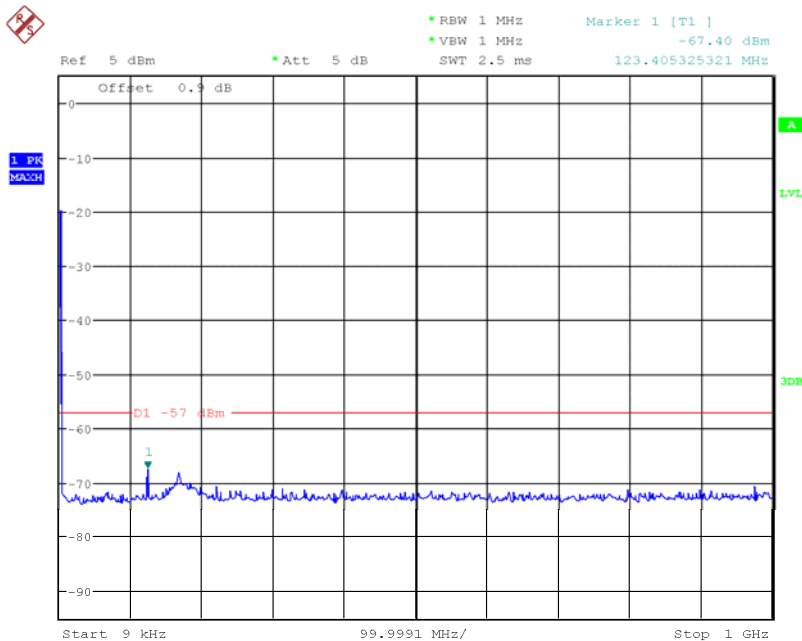

Date: 15.JUL.2011 17:33:50



1GHz to 13GHz

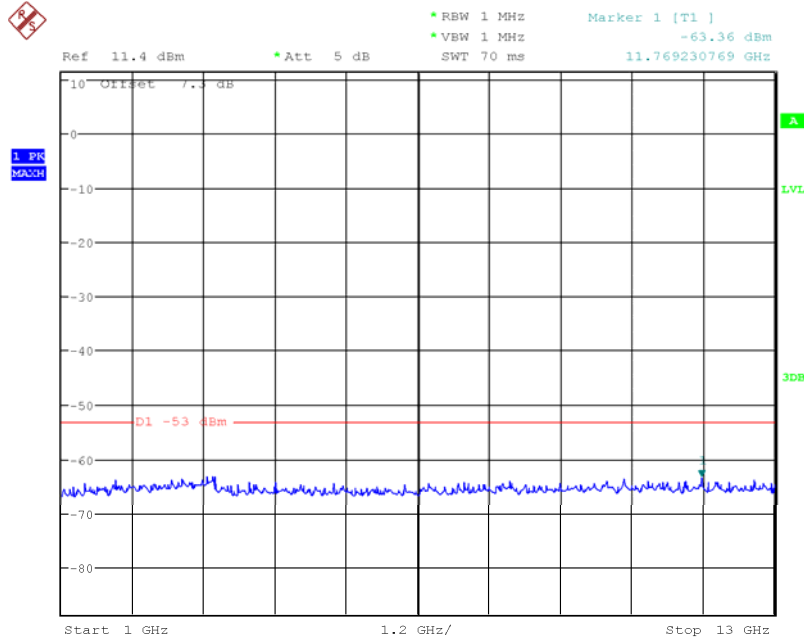

Date: 15.JUL.2011 17:35:30

Limit	-57dBm (30MHz-1GHz) and -53dBm (above 1GHz)
-------	---

Remarks

The EUT does not exceed -57dBm at the frequency range of 9kHz to 1GHz and does not exceed -53dBm at the frequency range of 1GHz to 13GHz.



Product Service

### **SECTION 3**

#### **TEST EQUIPMENT USED**



### 3.1 TEST EQUIPMENT USED

List of absolute measuring and other principal items of test equipment.

Instrument	Manufacturer	Type No.	Serial No.	Calibration Period (months)	Calibration Due
<b>Section 2.1, 2.2, 2.3, 2.4, 2.5, 2.7 and 2.10 – Maximum Conducted Output Power, Peak – Average Ratio, Modulation Characteristics, Occupied Bandwidth, Spurious Emissions at Antenna Terminals (<math>\pm 1</math>MHz), Conducted Spurious Emissions and Receiver Spurious Emissions.</b>					
Spectrum Analyser	Rohde & Schwarz	FSQ26	200235	12	27-Mar-2012
Spectrum Analyser	Agilent	MXA N9020A	MY50200663	12	05-Sep-2011
Power Metre	Rohde & Schwarz	NRP	102432	12	24-Aug-2011
Thermal Power Sensor	Rohde & Schwarz	NRP-Z21	101644	12	27-Mar-2012
Network Analyzer	Agilent	8720D	US38431317	12	24-Aug-2011
6dB Attenuator	Weinschel Corp	48-6-34	BJ2529	-	O/P MON
40dB Attenuator	Aeroflex / Weinschel	48-40-43-LIM	BR5020	-	O/P MON
30dB Attenuator	Lucas Weinschel	48-30-34	BA2851	-	O/P MON
30dB Attenuator	Shanghai Huaxiang	DTS50	06041306	-	O/P MON
10dB Attenuator	Weinschel Corp	48-10-34	BC1574	-	O/P MON
Load	Shanghai Huaxiang	TF100	09121647	-	O/P MON
Power Supply	Dahua	DH1716A-9	20070905	-	O/P MON
Power Supply	Dahua	DH1716A-14	20080401	-	O/P MON
Digital Multi-meter	FLUKE	179	91820401	12	03-Jan-2012
Thermo-hygrometer	AZ Instruments	8705	9151655	12	16-Dec-2011
<b>Section 2.6 – Radiated Spurious Emissions</b>					
Load	Shanghai Huaxiang	TFZ100-3N	09116765	-	O/P MON
Load	Shanghai Huaxiang	TF150	06081402	-	O/P MON
EMI Receiver	Rohde & Schwarz	ESI 40	100015	12	19-Aug-2011
Ultra log test antenna	Rohde & Schwarz	HL562	100167	12	19-Aug-2011
Double-Ridged Waveguide Horn Antenna	Rohde & Schwarz	HF 906	100029	12	19-Aug-2011
Pyramidal Horn Antenna	EMCO	3160-09	-	-	-
Antenna master	Frankonia	MA 260	-	12	19-Aug-2011
Relay Switch Unit	Rohde & Schwarz	331.1601.31	338965002	-	TU
Semi Anechoic Chamber	Frankonia	23.18m×16.88 m×9.60m	-	12	19-Aug-2011
Power Supply	Dahua	DH1716A-9	20070905	-	O/P MON
Power Supply	Dahua	DH1716A-14	20080401	-	O/P MON
Digital Multimeter	FLUKE	179	91820401	12	03-Jan-2012
Thermo-hygrometer	AZ Instruments	8705	9151655	12	16-Dec-2011



Product Service

<b>Section 2.8 and 2.9 – Frequency Stability Under Temperature and Voltage Variations</b>					
Spectrum Analyser	Agilent	MXA N9020A	MY50200663	12	05-Sep-2011
40dB Attenuator	Aeroflex / Weinschel	48-40-43-LIM	BR5020	-	O/P MON
Load	Shanghai Huaxiang	TF100	09121647	-	O/P MON
Temperature Chamber	ZENGDA	WGD/SJ7-10	200505100	-	O/P MON
Power Supply	Dahua	DH1716A-9	20070905	-	O/P MON
Power Supply	Dahua	DH1716A-14	20080401	-	O/P MON
Digital Multimeter	FLUKE	179	91820401	12	03-Jan-2012
Thermo-hygrometer	AZ Instruments	8705	9151655	12	16-Dec-2011

O/P MON      Output monitored with calibration equipment



Product Service

### 3.2 MEASUREMENT UNCERTAINTY

For a 95% confidence level, the measurement uncertainties for defined systems are:-

Test Discipline	Frequency / Parameter	MU
Conducted Maximum Peak Output Power	30MHz to 10GHz Amplitude	0.5dB*
Conducted Emissions	30MHz to 40GHz Amplitude	3.0dB*
Frequency Stability	30MHz to 2GHz Amplitude	$<1 \times 10^{-7}$
Radiated Emissions, Bilog Antenna, AOATS	30MHz to 1GHz Amplitude	5.1dB*
Radiated Emissions, Horn Antenna, AOATS	1GHz to 40GHz Amplitude	6.3dB*
Worst case error for both Time and Frequency measurement 12 parts in $10^6$		

\* In accordance with CISPR 16-4



Product Service

## **SECTION 4**

### **ACCREDITATION, DISCLAIMERS AND COPYRIGHT**





Product Service

#### 4.1 ACCREDITATION, DISCLAIMERS AND COPYRIGHT



This report relates only to the actual item/items tested.

Our UKAS Accreditation does not cover opinions and interpretations and any expressed are outside the scope of our UKAS Accreditation.

Results of tests not covered by our UKAS Accreditation Schedule are marked NUA  
(Not UKAS Accredited).

This report must not be reproduced, except in its entirety, without the written permission of  
TÜV SÜD Product Service Limited

© 2011 TÜV SÜD Product Service Limited