



REPORT

issued by an FCC listed Laboratory Reg. no. 93866.
The test site complies with RSS-Gen, IC file no: 3482A

Date
2011-11-03

Reference
FX108944-F24W 1 (2)

Page



Contact person
Jonas Bremholt
Electronics
+46 10 516 54 38
jonas.bremholt@sp.se

Ericsson AB
Anders Johansson
PDU Radio Base Station
164 80 Stockholm

Radio measurements on RUS 01 B2 1900 MHz radio equipment with FCC ID:TA8AKRC11866-2 and IC:287AB-AS118662

(9 appendices)

Test object

RUS 01 B2, KRC 118 66/2 Rev R1A, serial no: CB4J462261

Summary

Standard	Compliant	Appendix
FCC CFR 47 / IC RSS-133		
2.1046 / RSS-133 6.4 RF power output	Yes	2
2.1049 / RSS-Gen 4.6.1 Occupied bandwidth	Yes	3
2.1051 / RSS-133 6.5 Band edge	Yes	4
2.1051 / RSS-133 6.5 Spurious emission at antenna terminals	Yes	5
2.1053 / RSS-133 6.5 Field strength of spurious radiation	Yes	6
2.1055 / RSS-133 6.3 Frequency stability	Yes	7
Industry Canada RSS-133		
RSS-133 6.6 Receiver spurious emissions	Yes	8

Note: Above RSS-133 items are given as cross-reference only. Measurements were performed according to ANSI procedures referenced by FCC and covered by SP's accreditation.

SP Technical Research Institute of Sweden

Electronics - EMC

Performed by

Jonas Bremholt

Examined by

Christer Karlsson

SP Technical Research Institute of Sweden

Postal address

SP
Box 857
SE-501 15 Borås
SWEDEN

Office location

Västeråsen
Brinellgatan 4
SE-504 62 Borås
SWEDEN

Phone / Fax / E-mail

+46 10 516 50 00
+46 33 13 55 02
info@sp.se

Laboratories are accredited by the Swedish Board for Accreditation and Conformity Assessment (SWEDAC) under the terms of Swedish legislation. This report may not be reproduced other than in full, except with the prior written approval of the issuing laboratory.

Table of contents

Description of the test object	Appendix 1
Operation mode during measurements	Appendix 1
Test setups	Appendix 1
Purpose of test	Appendix 1
RF power output	Appendix 2
Occupied bandwidth	Appendix 3
Band edge	Appendix 4
Spurious emission at antenna terminals	Appendix 5
Field strength of spurious radiation	Appendix 6
Frequency stability	Appendix 7
Receiver spurious emissions	Appendix 8
External photos	Appendix 9

Appendix 1

Description – Test object

Equipment: Radio equipment RUS 01 B2 running in WCDMA mode supporting single and multi carrier.

Antenna ports: 1 TX/RX port and 1 RX port

Frequency bands: TX: 1930 – 1990 MHz
RX: 1850 – 1910 MHz

Modulations: QPSK, 16QAM and 64QAM

Nominal output power: Single carrier: 1x 49.0 dBm (1x 80W)
(Maximum) Multi carrier: 2x 46.0 dBm (2x 40W)
3x 44.3 dBm (3x 26.7W)
4x 43.0 dBm (4x 20W)

Channel bandwidth: 4.2 to 5 MHz (configurable in steps of 100/200 kHz)

Channel spacing: 4.4 to 5 MHz (configurable in steps of 100/200 kHz)

Nominal power voltage: -48 VDC

Tested channels

Channel	Downlink		Uplink	
	Frequency*	UARFCN	Frequency*	UARFCN
B	1932.4	9662	1852.4	9262
B+5	1937.4	9687	1857.4	9287
B+10	1942.4	9712	1862.4	9312
B+15	1947.4	9737	1867.4	9337
M	1960.0	9800	1880.0	9400
T-15	1972.6	9863	1892.6	9463
T-10	1977.6	9888	1897.6	9488
T-5	1982.6	9913	1902.6	9513
T	1987.6	9938	1907.6	9538

* Frequency in MHz

Operation mode during measurements

Measurements were performed with the test object transmitting the Test models which are defined in 3GPP TS 25.141. Test model 1 (TM1) uses the QPSK modulation only, Test model 5 (TM5) includes the 16QAM modulation and Test model 6 (TM6) includes the 64QAM modulation.

The settings below were found to be representative for all traffic scenarios when several settings with the different modulations, channel bandwidths and the number of carriers were tested to find the worst case setting. These settings were used for all measurements if not otherwise noted.

Single carrier

TM1: 64 DPCH:s at 30 ksps (SF=128)

Multi carrier

TM1: 32 DPCH:s at 30 ksps (SF=128) in each carrier (Two carriers activated)

Channel bandwidth 5 MHz

Appendix 1

Conducted measurements

The EUT was mounted into a RBS 6201 cabinet and supplied by the cabinet's internal -48 V DC. All RF conducted measurements were performed with the test object configured for maximum transmit power. All TX measurements were done at the RF A connector and the RX measurements were done on the RF B connector.

Radiated measurements

The test object was powered with -48 VDC. All measurements were performed with the test object configured for maximum transmit power. The configuration represents worst case for radiated spurious emission measurements.

The RF output power port was via a RF attenuator connected to functional test equipment for supervision.

The RUS unit was allocated to the following UARFCN:

Single Carrier: (One carrier configuration)

Cell	1	1	1
Channel	B	M	T

Multi Carrier: (Two carrier configuration)

Cell	1	2
Channel	B	B+10
Channel	T-10	T

Multi Carrier: (Four carrier configuration)

Cell	1	2	3	4
Channel	B	B+5	B+10	B+15
Channel	T	T-5	T-10	T-15

Purpose of test

The purpose of the tests is to verify compliance to the performance characteristics specified in applicable items of FCC CFR 47 and Industry Canada RSS-133 and RSS-Gen.

References

Measurements were done according to relevant parts of the following standards:

- ANSI 63.4-2009
- ANSI/TIA/EIA-603-C-2004
- CFR 47 part 2, October 1st, 2010
- CFR 47 part 24, October 1st, 2010
- 3GPP TS 25.141, version 8.9.0
- RSS-Gen Issue 3
- RSS-133 Issue 5

Appendix 1

Measurement equipment

Measurement equipment	Calibration Due	SP number
Test site Tesla	2012-10	503 881
R&S FSIQ 40	2012-07	503 738
R&S FSQ 40	2012-07	504 143
R&S ESI 26	2012-07	503 292
Control computer with R&S software EMC32 version 8.20.1	-	503 479
High pass filter	2012-07	504 199
High pass filter	2012-07	504 200
High pass filter	2012-07	503 739
High pass filter	2012-07	503 740
RF attenuator	2012-07	504 159
RF attenuator	2012-07	900 233
Boonton RF Peak power meter/analyzer	2011-10	503 144
Boonton Power sensor 56518-S/4	2012-10	503 145
Chase Bilog Antenna CBL 6111A	2011-10	503 182
EMCO Horn Antenna 3115	2014-01	502 175
Std.gain horn FLANN model 20240-20	-	503 674
µComp Nordic, Low Noise Amplifier	2012-07	504 160
MITEQ Low Noise Amplifier	2012-07	503 285
Temperature cabinet	-	503 360
Multimeter Fluke 87	2012-05	502 190
Testo 625, Temperature and humidity meter	2012-06	504 188
Testo 635 Temperature and humidity meter	2012-05	504 203

Uncertainties

Measurement and test instrument uncertainties are described in the quality assurance documentation "SP-QD 10885". The uncertainties are calculated with a coverage factor $k=2$ (95% level of confidence).

Reservation

The test results in this report apply only to the particular test object as declared in the report.

Delivery of test object

The test object was delivered 2011-05-26.

Manufacturer's representative

Christer Gustavsson, Ericsson AB



Appendix 1

Test engineers

Andreas Johnson, Tomas Lennhager, Jörgen Wassholm, and Jonas Bremholt

Test participant(-s)

Anita Qu and Xiang Yue, Ericsson CBC (Partly present)

Appendix 1

Test set-up conducted measurements TX

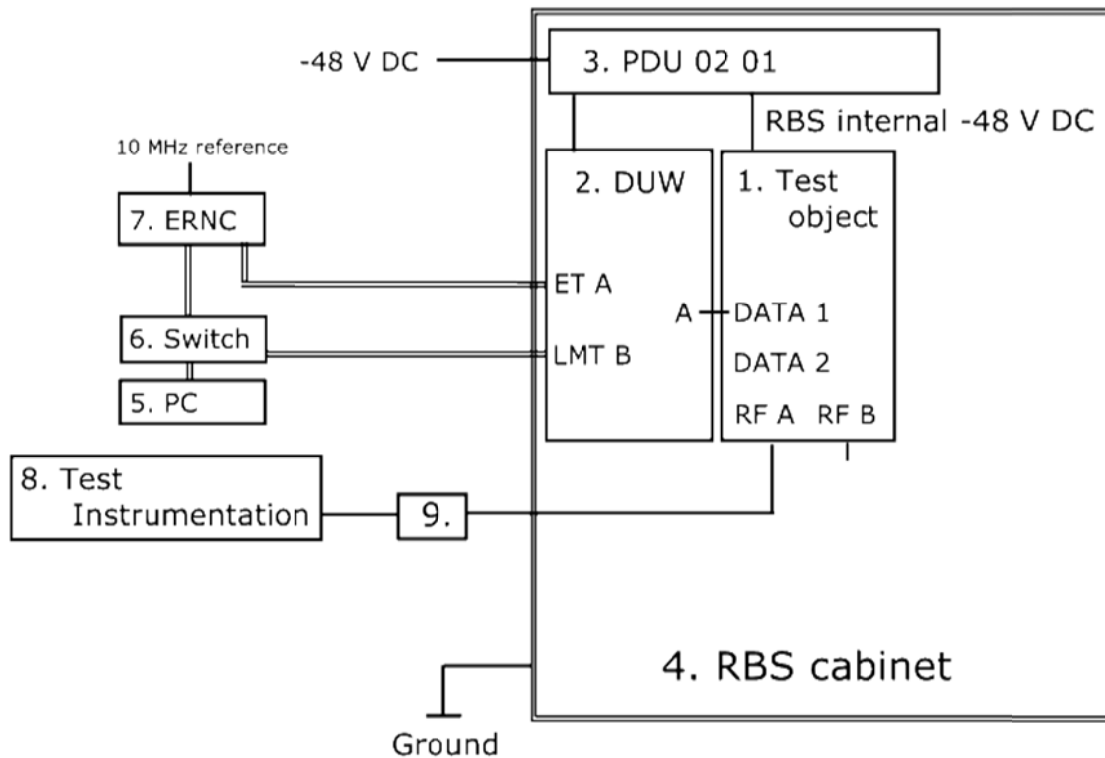

Test object

1. RUS 01 B2, KRC 118 66/2, revision R1A, S/N: CB4J462261 (FCC ID:TA8AKRC11866-2 / IC:287AB-AS118662)

Functional test equipment

2. PDU 02 01, BMG 980336/4, R2A, (S)BJ31528316
3. DU units:
Configuration single carrier (1x1) and multi carrier (1x2)
DU: DUW 30 01 KDU 127 161/3 Rev R4C, S/N: C824599840
Configuration multi carrier (1x4)
DU 1: DUW 30 01 KDU 127 161/3 Rev R4C, S/N: C824599840 and
DU 2: DUW 30 01 KDU 127 161/3 Rev R3C, S/N: C824357268
4. RBS 6201 cabinet, BAMS 1000778792
5. Computer, Sunblade 1500
6. Ethernet switch, Mercury H108M
7. ERNC, BAMS – 1000759880
8. SP test instrument according measurement equipment list
9. RF attenuator

Appendix 1

Test set-up conducted measurements RX

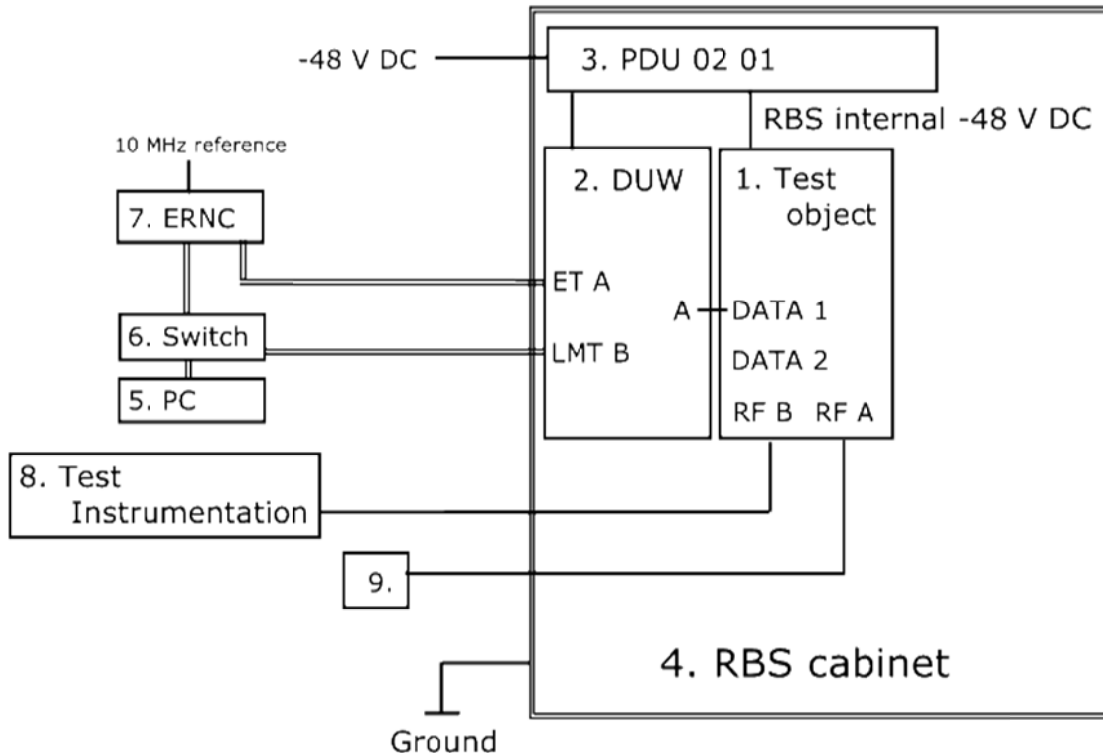

Test object

1. RUS 01 B2, KRC 118 66/2, revision R1A, S/N: CB4J462261 (FCC ID:TA8AKRC11866-2 / IC:287AB-AS118662)

Functional test equipment

2. PDU 02 01, BMG 980336/4, R2A, (S)BJ31528316
3. DU units:
Configuration single carrier (1x1) and multi carrier (1x2)
DU: DUW 30 01 KDU 127 161/3 Rev R4C, S/N: C824599840
Configuration multi carrier (1x4)
DU 1: DUW 30 01 KDU 127 161/3 Rev R4C, S/N: C824599840 and
DU 2: DUW 30 01 KDU 127 161/3 Rev R3C, S/N: C824357268
4. RBS 6201 cabinet, BAMS 1000778792
5. Computer, Sunblade 1500
6. Ethernet switch, Mercury H108M
7. ERNC, BAMS – 1000759880
8. SP test instrument according measurement equipment list
9. RF terminator

Appendix 1

Test set-up radiated measurements

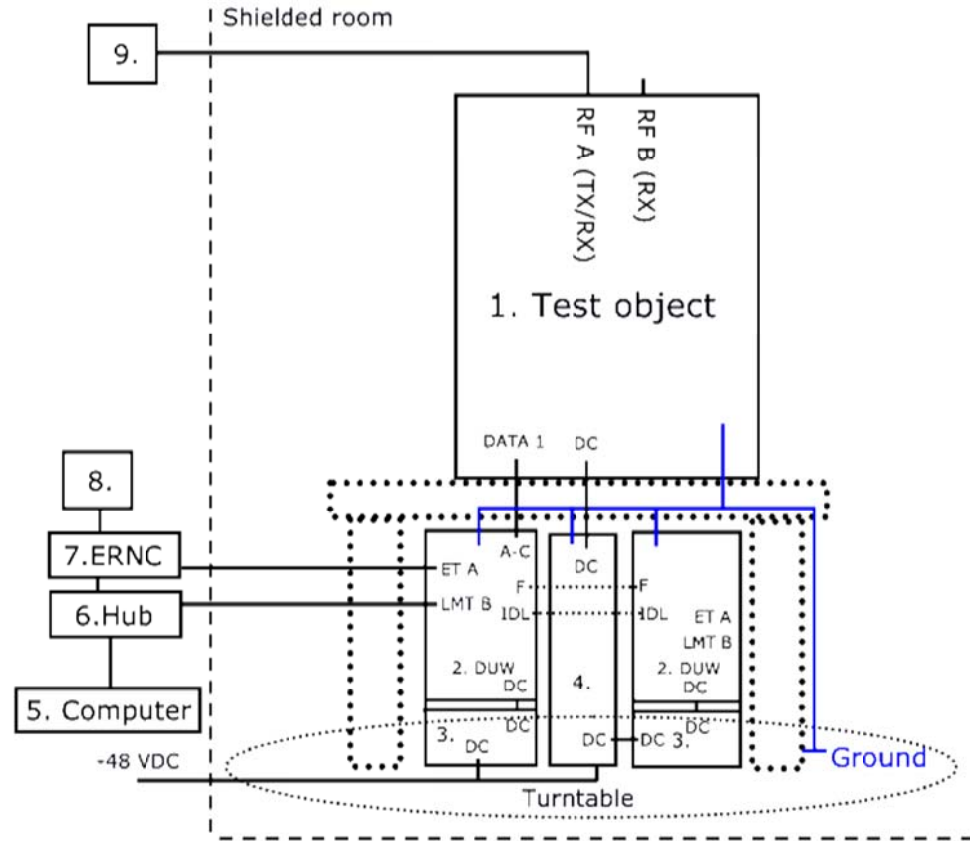

Test object

1. RUS 01 B2, KRC 118 66/2, revision R1A, S/N: CB4J462261 (FCC ID:TA8AKRC11866-2 / IC:287AB-AS118662)

Functional test equipment

2. DU units
Configuration single carrier (1x1) and multi carrier (1x2)
DU: DUW 30 01, KDU 127 161/3, Rev R4C, S/N: C824599840
Configuration multi carrier (1x4)
DU 1: DUW 30 01, KDU 127 161/3, Rev R4C, S/N: C824599840 and
DU 2: DUW 30 01, KDU 127 161/3, Rev R3C, S/N: C824357268
3. SUP 1: SUP 6601, 1/BFL 901 009/1, Rev R3B, S/N: BR81262576
SUP 2: SUP 6601, 1/BFL 901 009/1, Rev R3B, S/N: BR81262561
4. PDU 02 01, BMG 980 336/4, Rev R2A, S/N: BJ31534775
5. Computer Sunblade 1500
6. Mercury mini hub H108M
7. ERNC, BAMS – 1000759880
8. 10 MHz reference
9. Terminator

Appendix 1

Test object interfaces

Type of port:

Power configuration: -48 VDC	DC Power
Ground via RBS frame during conducted measurements, Ground via ground strap during radiated stand-alone measurements	Ground
Antenna port RF A, combined TX/RX, female 7/16 connector	Antenna
Antenna port RF B, RX only, female 7/16 connector	Antenna
Cross connect RX A, not supported, omitted in set-up drawings above	-
Cross connect RX B, not supported, omitted in set-up drawings above	-
RXA CO-site, not supported, omitted in set-up drawings above	-
Data 1, connected to DUW port RI A	Signal
Data 2, not supported	-

RBS software

Software	Revision
CXP 901 8436/1	R2T01

Appendix 2

RF power output measurements according to CFR 47 §24.232 / IC RSS-133 6.4

Date	Temperature	Humidity
2011-06-30	23 °C ± 3 °C	49 % ± 5 %
2011-07-01	24 °C ± 3 °C	52 % ± 5 %
2011-07-04	24 °C ± 3 °C	57 % ± 5 %

Test set-up and procedure

The test object was connected to a power analyzer measuring peak and RMS output power in CDF mode.

Measurement equipment	SP number
Boonton RF Peak power meter/analyzer	503 144
Boonton Power sensor 56518-S/4	503 146
RF attenuator	504 159
Testo 635, temperature and humidity meter	504 203

Measurement uncertainty: 0.7 dB

Results

Single carrier: Rated output power level at RF A connector (maximum): 1x 49 dBm

Transmitter power (dBm / dB) RMS / PAR		
B	M	T
48.6/ 6.9	48.7/ 7.5	48.6/ 6.7

Multi carrier: Rated output power level at RF A connector (maximum): 2x 46 dBm/ carrier

Transmitter power (dBm / dB) RMS / PAR		
B	M	T
45.8/ 9.5	45.8/ 9.3	45.7/ 9.4

Multi carrier: Rated output power level at RF A connector (maximum): 2x 46 dBm/ carrier

Combined Transmitter power (dBm / dB) RMS / PAR		
B+(B+5)	M+(M+5)	(T-5) +T
48.7/ 7.4	48.7/ 6.6	48.7/ 6.8

Appendix 2

Multi carrier: Rated output power level at RF A connector (maximum): 4x 43 dBm/ carrier

Transmitter power (dBm / dB) RMS / PAR		
B	M	T
42.7/ 10.5	42.8/ 9.8	42.8/ 10.0

Multi carrier: Rated output power level at RF A connector (maximum): 4x 43 dBm/ carrier

Combined Transmitter power (dBm / dB) RMS / PAR		
B+(B+5)+(B+10)+(B+15)	(M-5) + M+ (M+5) +(M+10)	(T-15) +(T-10) +(T-5) +T
48.3/ 7.1	48.5/ 6.5	48.5/ 6.8

Limits

§24.232 Federal Register / Vol. 73, No. 86

The maximum output power may not exceed 1640 W (EIRP).

The Peak to Average Ratio (PAR) may not exceed 13 dB.

RSS-133: The average equivalent isotropically radiated power (e.i.r.p.) for transmitters shall not exceed the limits given in SRSP-510. Moreover, base station transmitters operating in the band 1930-1995 MHz shall not have output power exceeding 100 watts.

In addition, when the transmitter power is measured in terms of average value, the peak-to-average ratio of the power shall not exceed 13 dB.

Complies?	Yes
-----------	-----

Appendix 3

Occupied bandwidth measurements according to 47 CFR 2.1049 / RSS-Gen 4.6.1

Date	Temperature	Humidity
2011-06-30	23 °C ± 3 °C	49 % ± 5 %
2011-07-01	24 °C ± 3 °C	52 % ± 5 %

Test set-up and procedure

The measurements were made per definition in §2.1049. The output was connected to a signal analyzer with the RMS detector activated. The signal analyzer was connected to an external 10 MHz reference standard during the measurements.

Measurement equipment	SP number
Rohde & Schwarz signal analyzer FSQ40	504 143
RF attenuator	504 159
Testo 615 temperature and humidity meter	503 498

Measurement uncertainty: 3.7 dB

Results

Diagram	BW configuration	Tested frequency	Occupied BW (99%) [MHz]
1	5.0 MHz	B	4.17
2	5.0 MHz	M	4.17
3	5.0 MHz	T	4.17
4	4.2 MHz	B	3.85
5	4.2 MHz	M	3.85
6	4.2 MHz	T	3.85

Appendix 3

Diagram 1

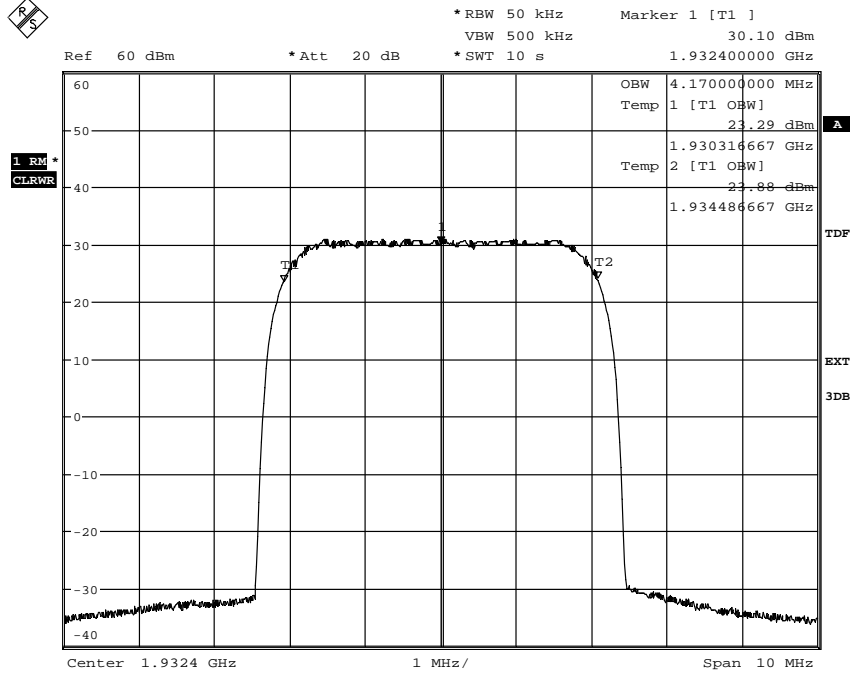

Date: 30.JUN.2011 14:23:47

Diagram 2

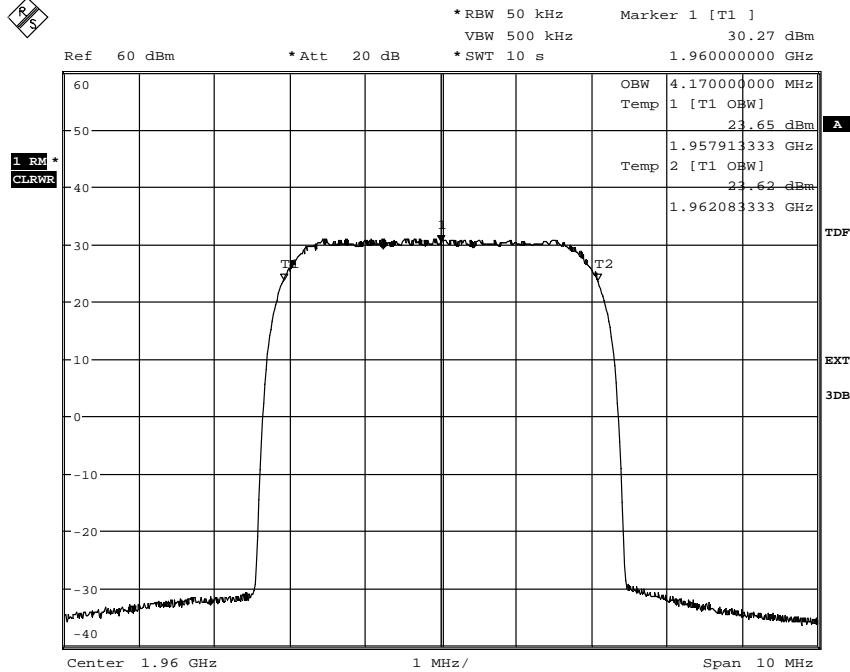

Date: 30.JUN.2011 13:32:46

Appendix 3

Diagram 3

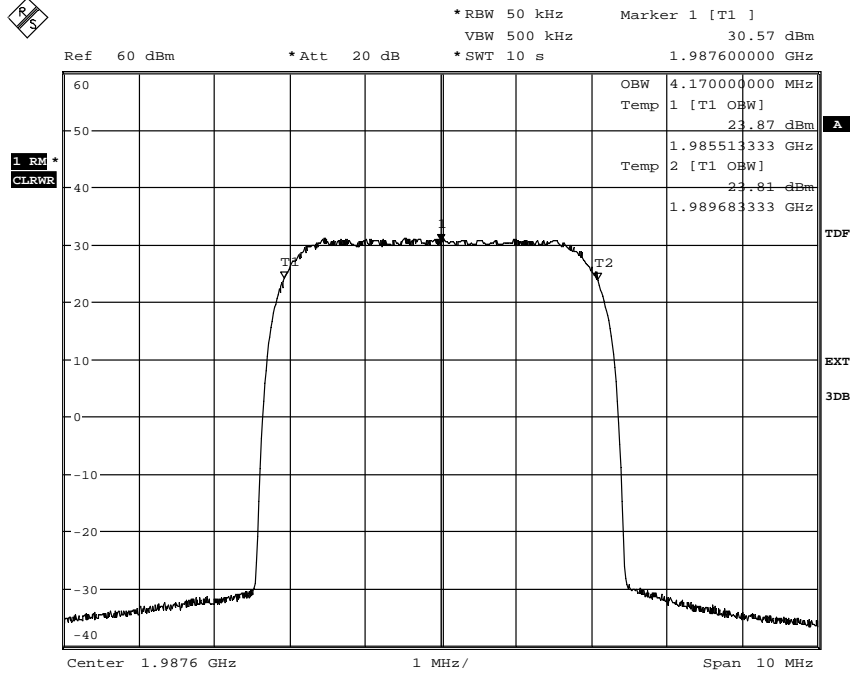

Date: 1.JUL.2011 10:23:16

Diagram 4

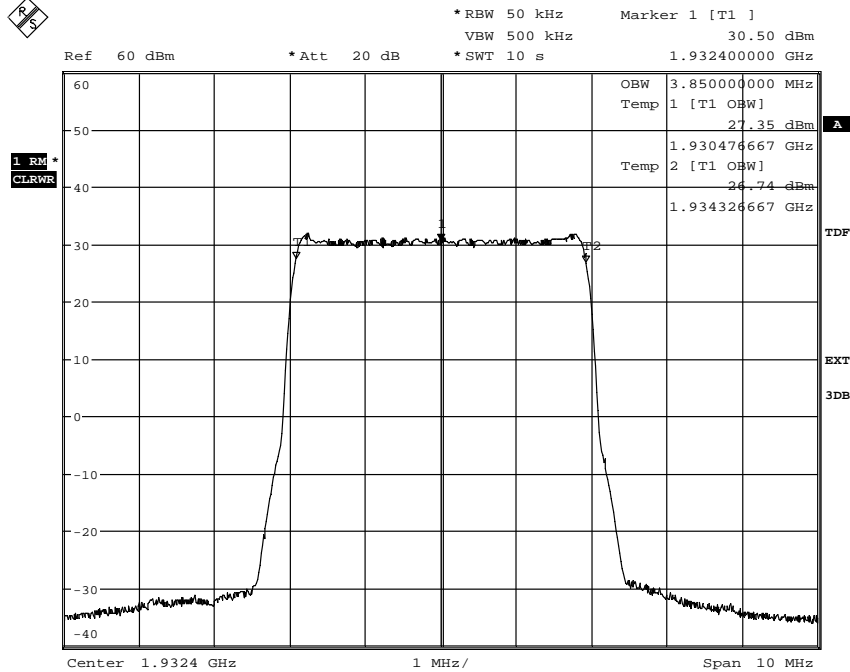

Date: 1.JUL.2011 09:36:31

Appendix 3

Diagram 5

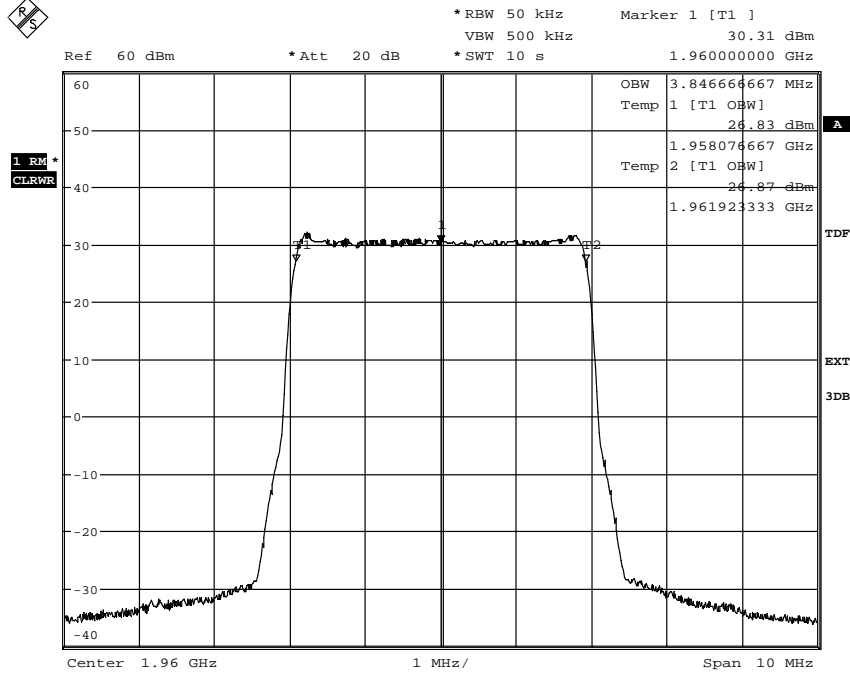

Date: 5.JUL.2011 08:01:27

Diagram 6

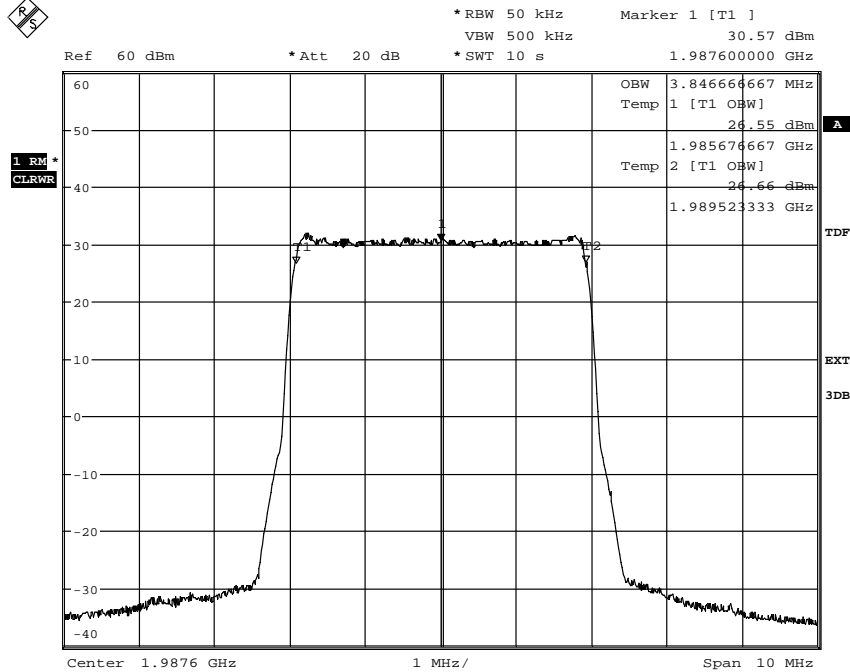

Date: 1.JUL.2011 09:16:16

Appendix 4

Band edge measurements according to CFR 47 §24.238 / IC RSS-133 6.5

Date	Temperature	Humidity
2011-06-30	23 °C ± 3 °C	49 % ± 5 %
2011-07-01	24 °C ± 3 °C	52 % ± 5 %
2011-07-04	24 °C ± 3 °C	57 % ± 5 %

Test set-up and procedure

The measurements were made per definition in §24.238. The output was connected to a spectrum analyzer with the RMS detector activated. The spectrum analyzer was connected to an external 10 MHz reference standard during the measurements. A resolution bandwidth of 20 kHz was used up to 1 MHz away from the band edges. 20 kHz is <1% of the Emission BW (4.37 MHz between the 26 dB points for 5 MHz nominal BW setting). To compensate for the reduced resolution bandwidth, the limit was adjusted with 3.39 dB to -16.39 dBm. A resolution bandwidth of 200 kHz was used 1 MHz to 6 MHz away from the band edges, to compensate for the reduced resolution bandwidth the limit was adjusted by 7 dB to -20 dBm.

Measurement equipment	SP number
R&S FSQ	504 143
RF attenuator	504 159
Testo 635, temperature and humidity meter	504 203

Measurement uncertainty: 3.7 dB

Results

Single carrier:

Diagram 1 a-c: B
Diagram 2 a-c: T

Multi carrier:

Diagram 3 a-c: B+(B+5)
Diagram 4 a-c: T+(T-5)

Limits

CFR 47 §24.238 and RSS-133 6.5

Outside a licensee's frequency band(s) of operation the power of any emission shall be attenuated below the transmitter power (P) by at least $43 + 10 \log (P)$ dB, resulting in a limit of -13 dBm.

Complies?	Yes
-----------	-----

Appendix 4

Diagram 1a:

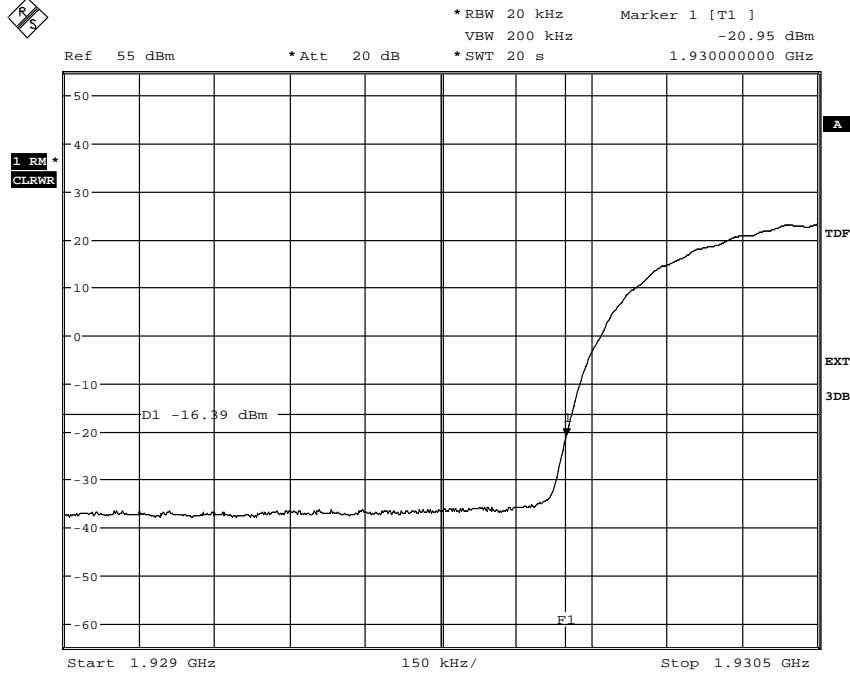

Date: 30.JUN.2011 14:33:17

Diagram 1b:

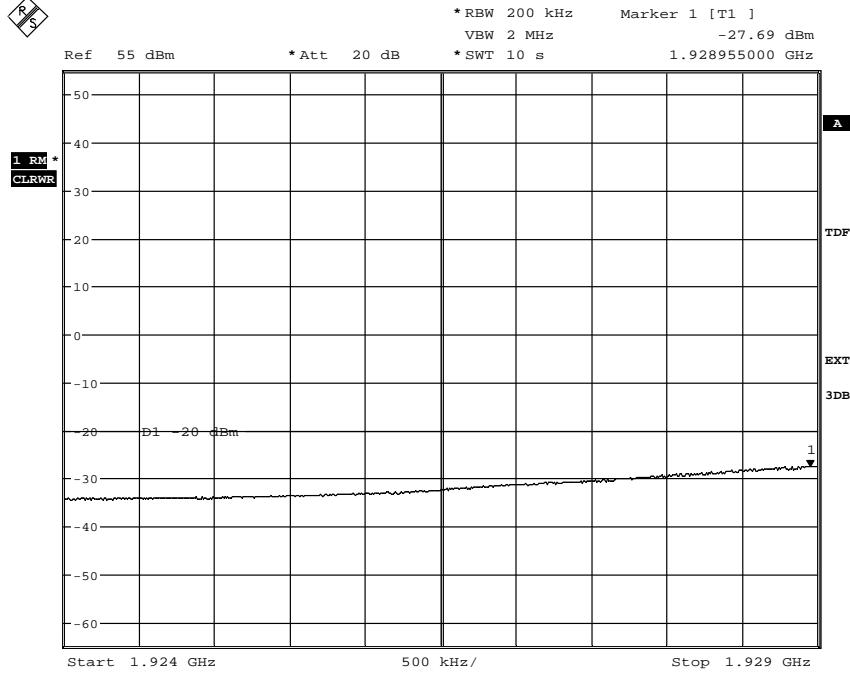

Date: 1.JUL.2011 11:36:04

Appendix 4

Diagram 1c

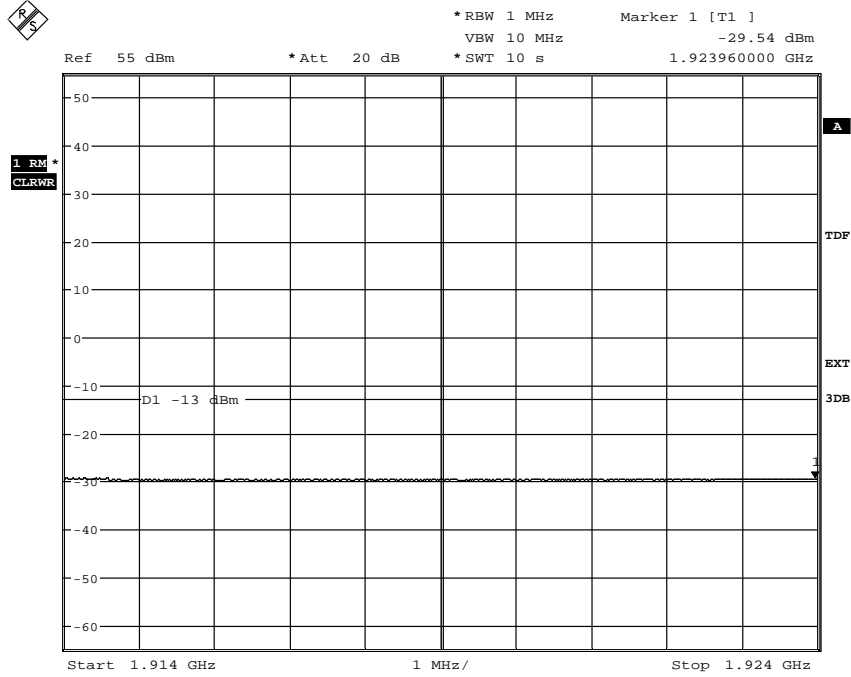

Date: 4.JUL.2011 14:08:22

Appendix 4

Diagram 2a:

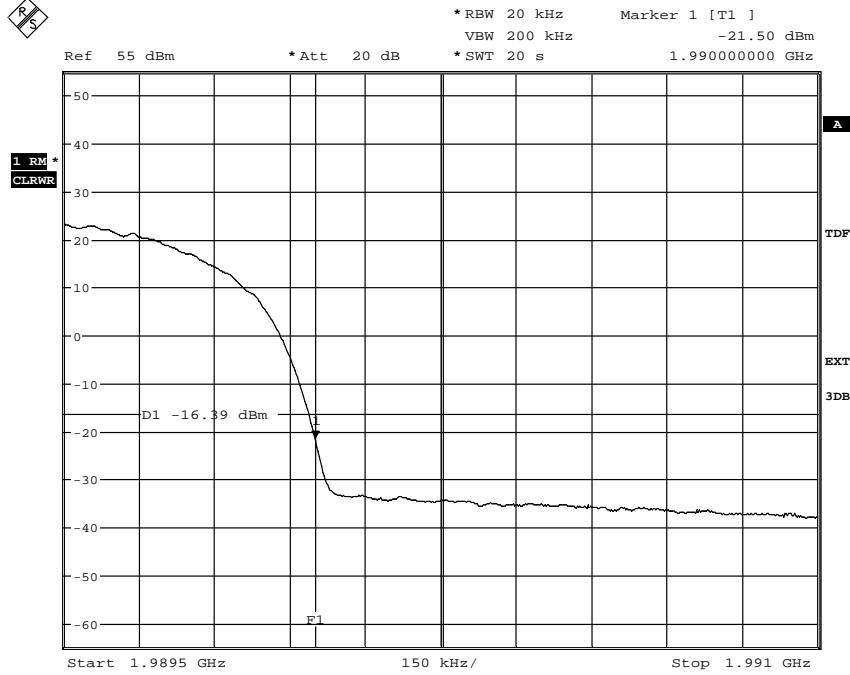

Date: 1.JUL.2011 10:57:16

Diagram 2b:

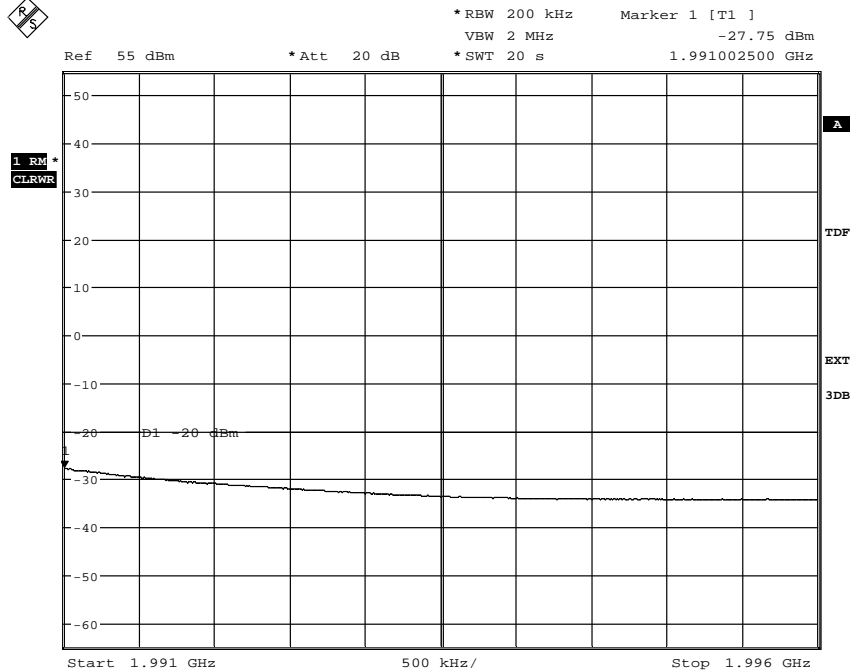

Date: 1.JUL.2011 10:59:50



Appendix 4

Diagram 2c:

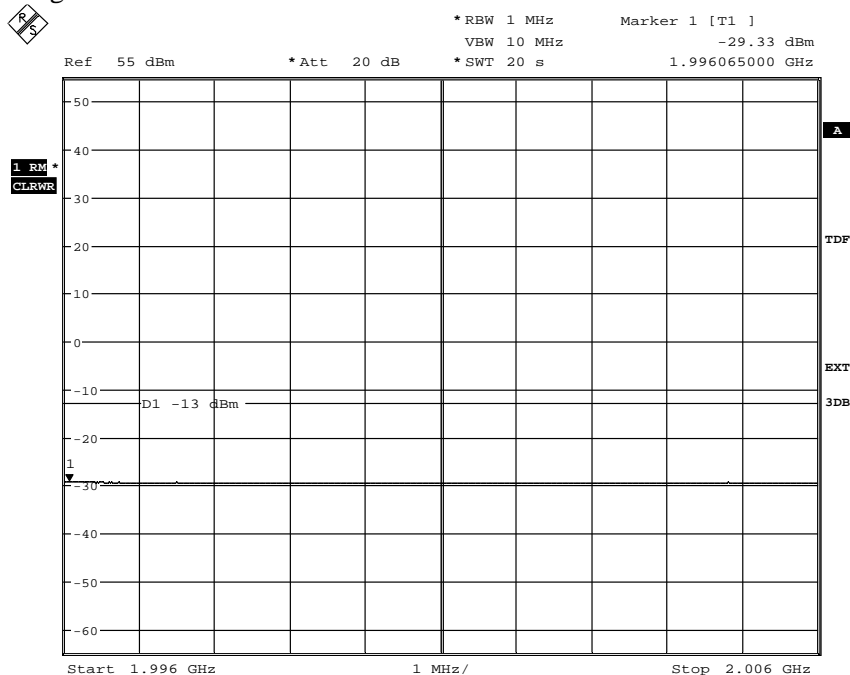

Date: 1.JUL.2011 11:09:36

Appendix 4

Diagram 3a:

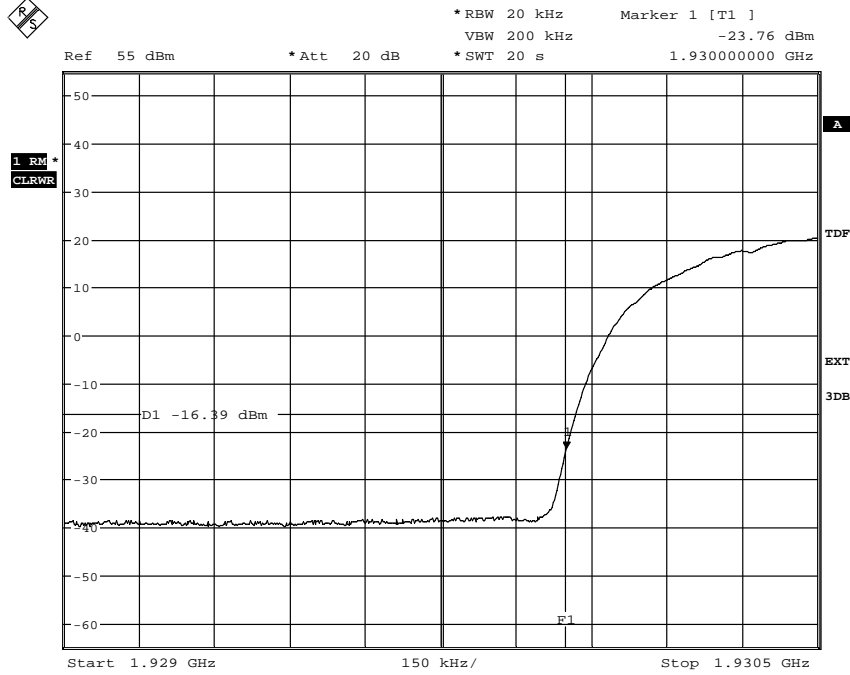

Date: 1.JUL.2011 14:59:49

Diagram 3b:

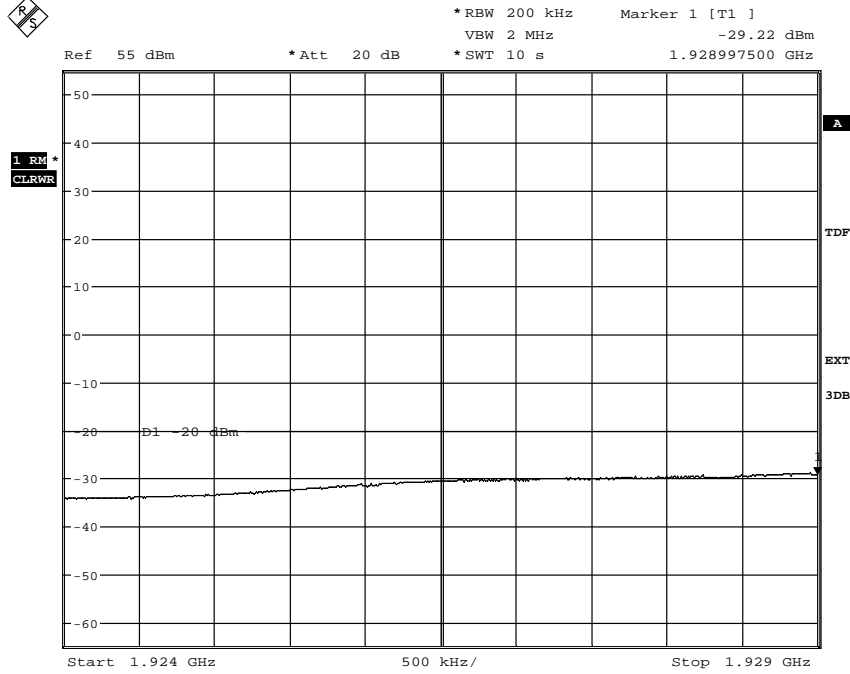

Date: 1.JUL.2011 15:03:27

Appendix 4

Diagram 3c:

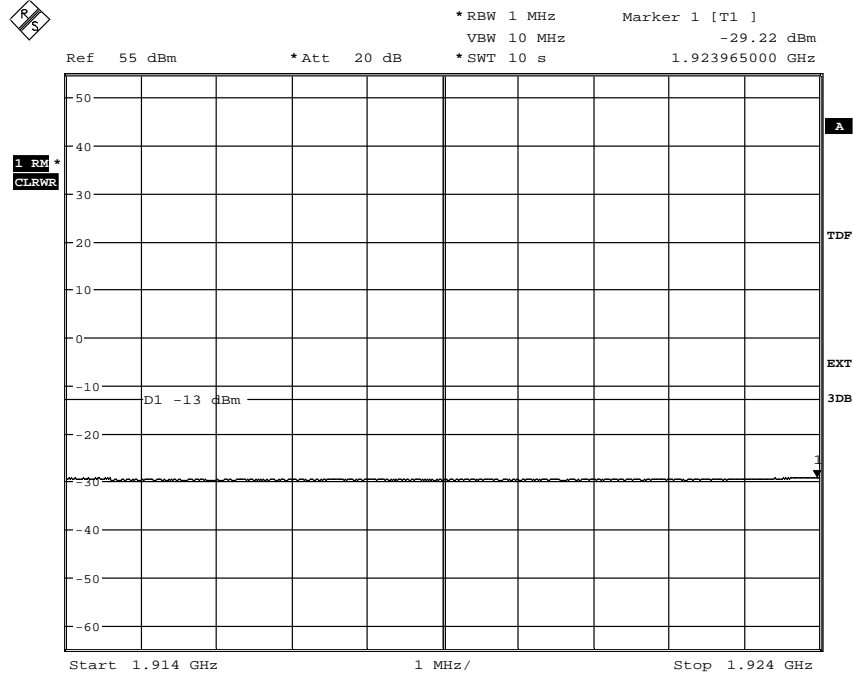

Date: 1.JUL.2011 15:06:21

Appendix 4

Diagram 4a:

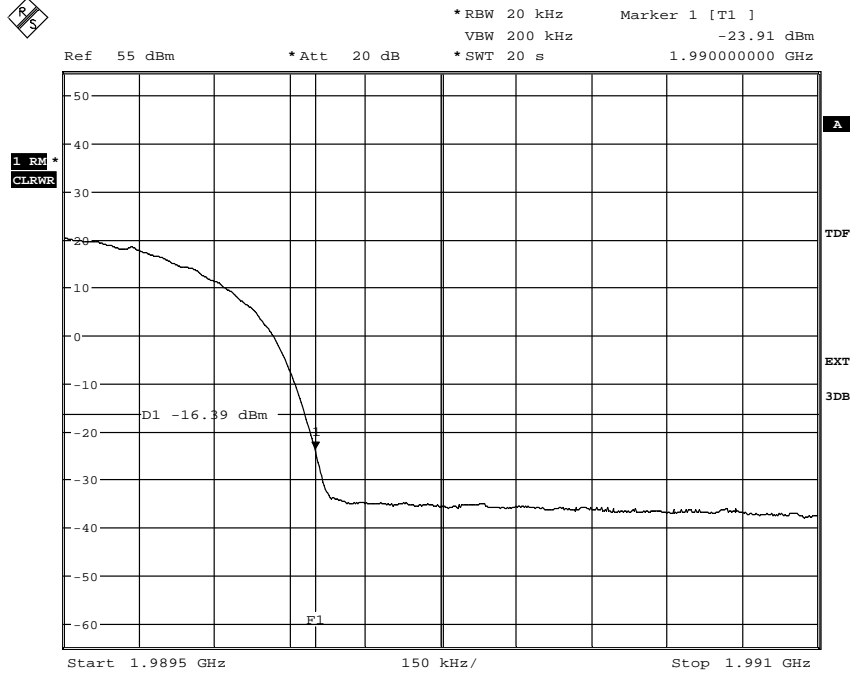

Date: 4.JUL.2011 07:42:16

Diagram 4b:

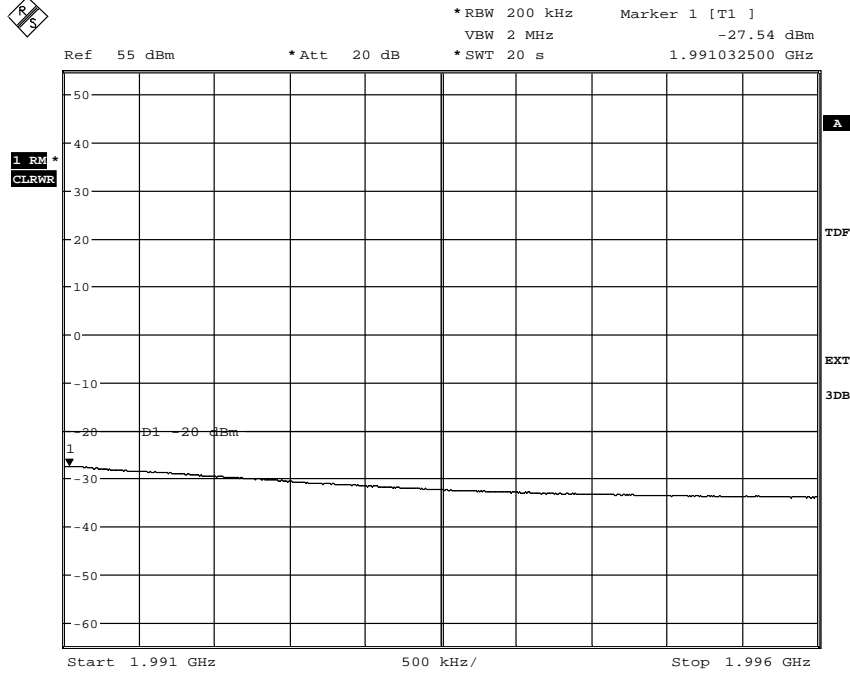

Date: 4.JUL.2011 07:47:19

Appendix 4

Diagram 4c:

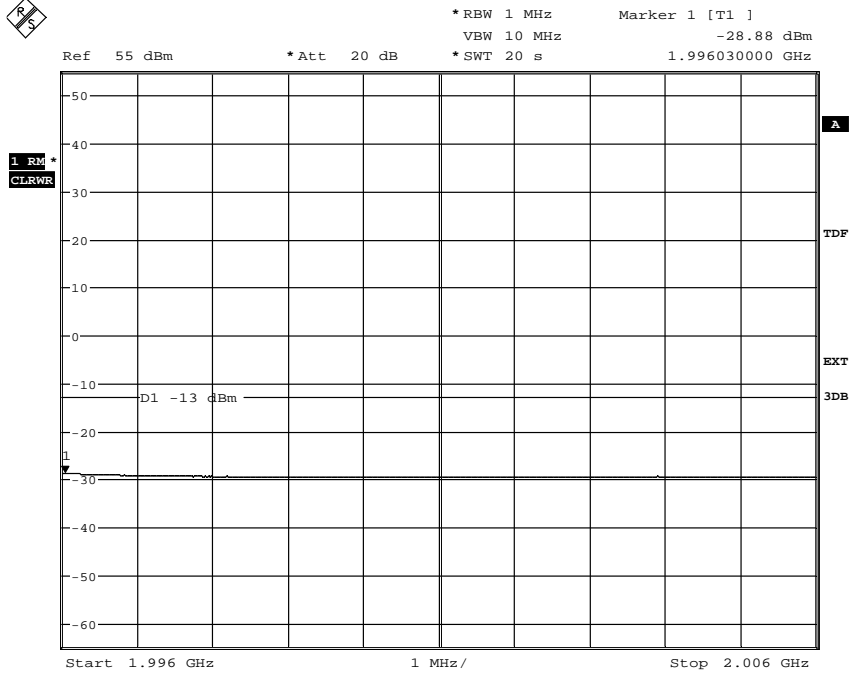

Date: 4.JUL.2011 07:51:10

Appendix 5

Conducted spurious emission measurements according to CFR 47 §24.238 / IC RSS-133 6.5

Date	Temperature	Humidity
2011-06-30	23 °C ± 3 °C	49 % ± 5 %
2011-07-01	24 °C ± 3 °C	52 % ± 5 %
2011-07-04	24 °C ± 3 °C	57 % ± 5 %

Test set-up and procedure

The measurements were made per definition in §24.238. The output was connected to a spectrum analyzer. The spectrum analyzer was connected to an external 10 MHz reference standard during the measurements. A pre-measurement was performed with the PEAK detector activated. Emission close to or above the limit with the PEAK detector is measured with the RMS detector activated and the level of the emission is determined with the substitution method.

Measurement equipment	SP number
R&S FSQ	504 143
RF attenuator	504 159
High pass filter	504 200
RF attenuator	900 229
High pass filter	503 740
Testo 635 temperature and humidity meter	504 203

Measurement uncertainty: 3.7 dB

Results

Single carrier:

Diagram 1: B

Diagram 2: M

Diagram 3: T

Multi carrier:

Diagram 4: B+(B+10)

Diagram 5: T+(T-10)

Remark

The emission at 9 kHz on the plots was not generated by the test object. A complementary measurement with a smaller RBW showed that it was related to the LO feed-through.

The highest internal frequency as declared by the client was 2.4576 GHz, thus the choice of the upper frequency boundary was set to $10 \times 2.5 \text{ GHz} = 25 \text{ GHz}$ for emission measurements.



Appendix 5

§24.238 and RSS-133 6.5

Outside a licensee's frequency band(s) of operation the power of any emission shall be attenuated below the transmitter power (P) by at least $43 + 10 \log (P)$ dB, resulting in a limit of -13 dBm per 1 MHz RBW.

Complies?	Yes
-----------	-----

Appendix 5

Diagram 1a

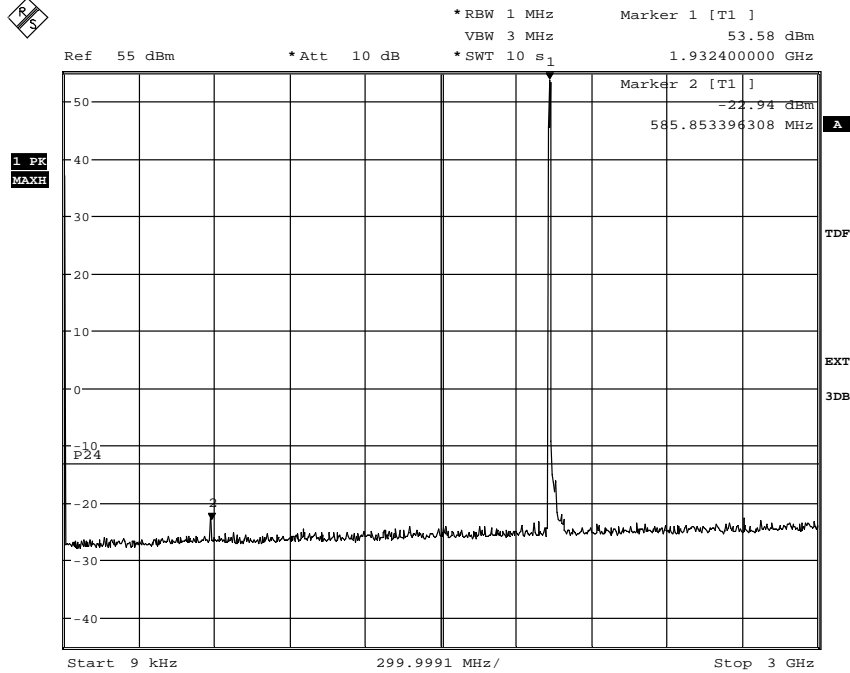

Date: 30.JUN.2011 14:17:50

The emissions around the carrier are within the operating frequency band

Diagram 1b

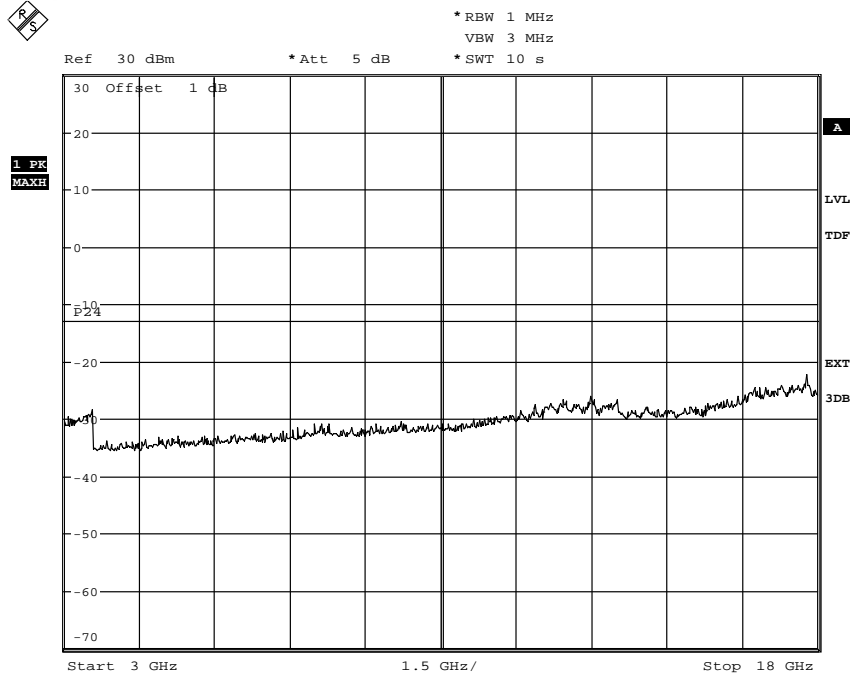

Date: 30.JUN.2011 14:08:05

Appendix 5

Diagram 1c

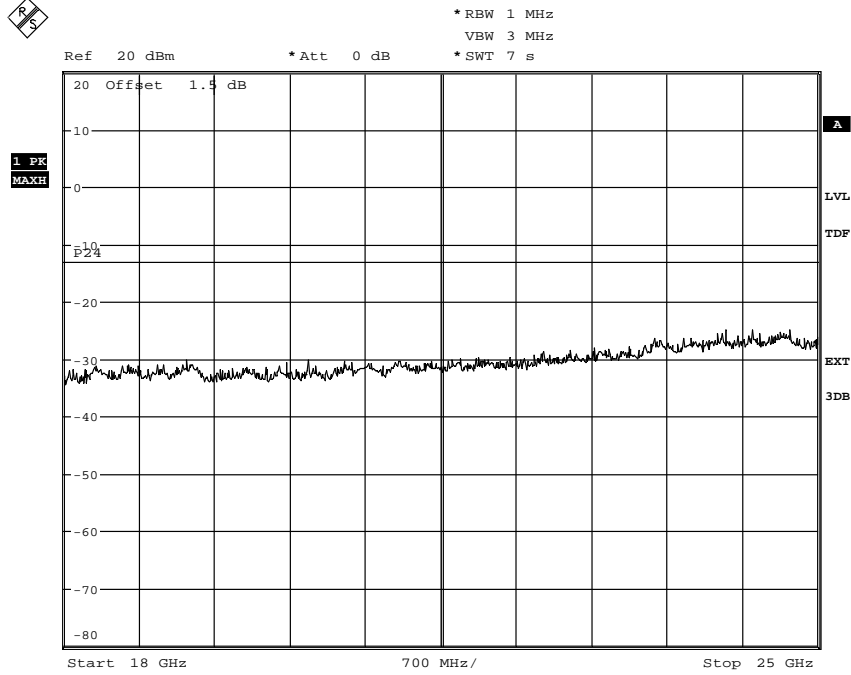

Date: 4.JUL.2011 13:04:37

Appendix 5

Diagram 2a

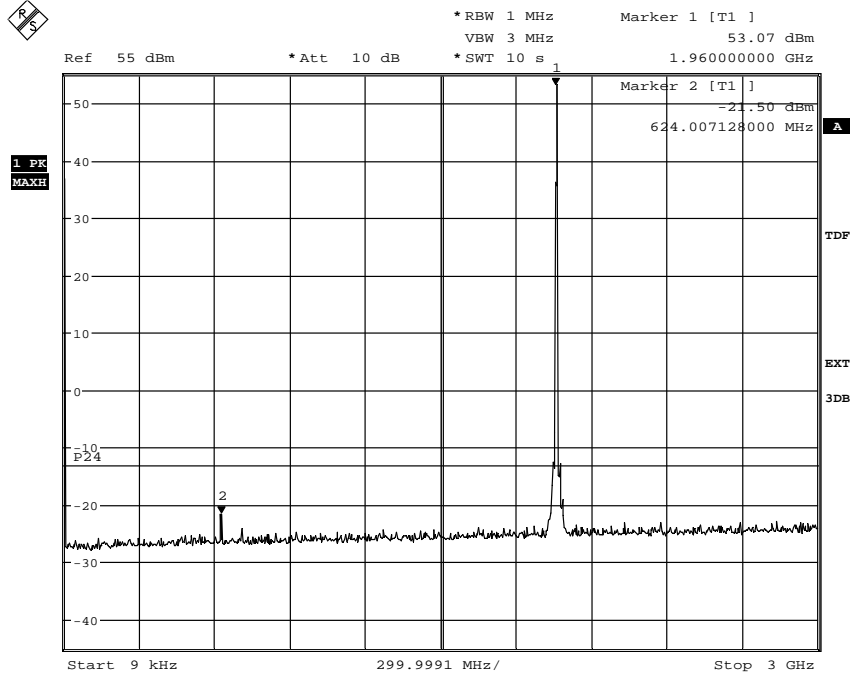

Date: 30.JUN.2011 13:41:58

Diagram 2b

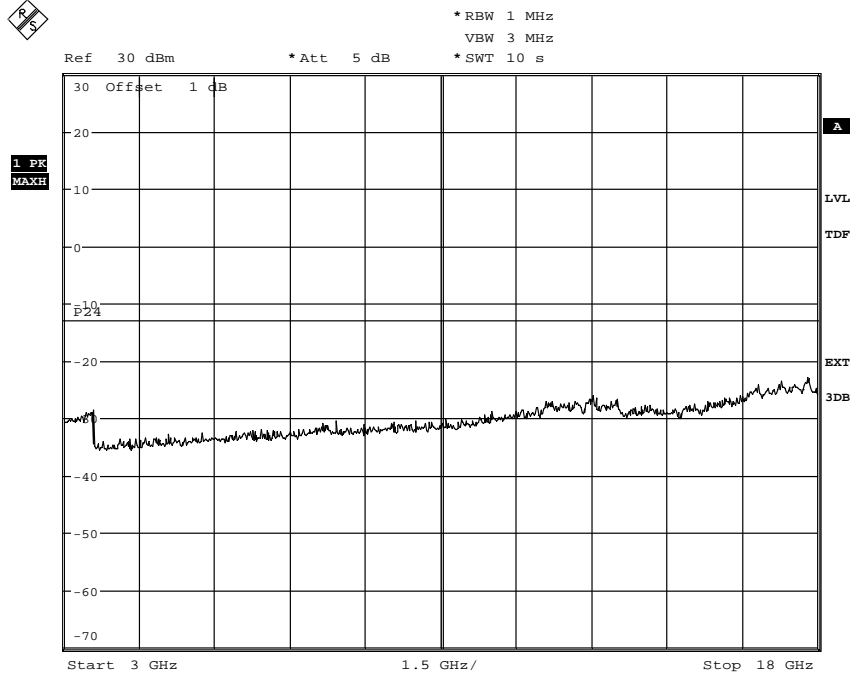

Date: 30.JUN.2011 13:46:58

Appendix 5

Diagram 2c

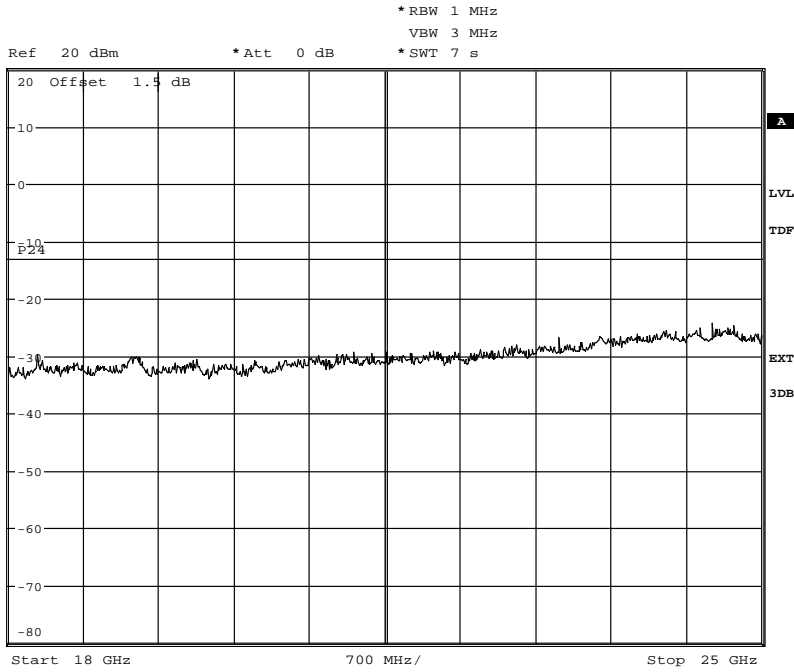

Date: 4.JUL.2011 13:26:46

Appendix 5

Diagram 3a

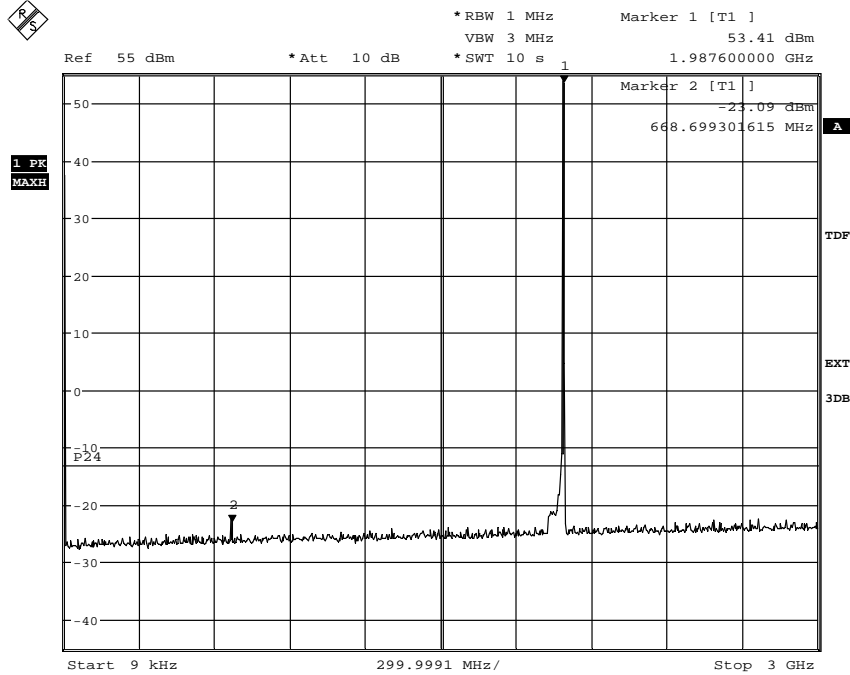

Date: 4.JUL.2011 13:49:37

The emissions around the carrier are within the operating frequency band

Diagram 3b

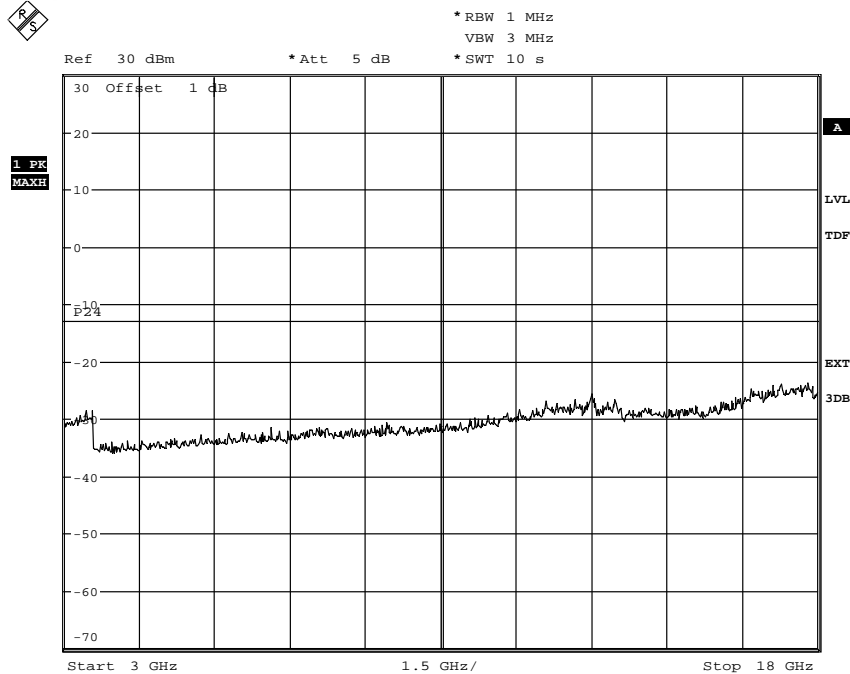

Date: 1.JUL.2011 10:16:18

Appendix 5

Diagram 3c

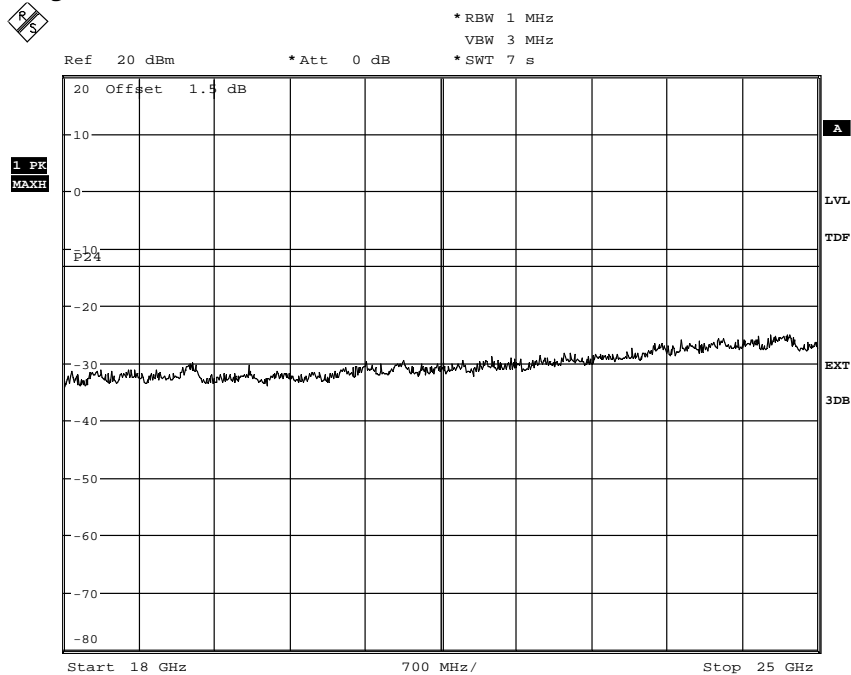

Date: 4.JUL.2011 13:35:18

Appendix 5

Diagram 4a

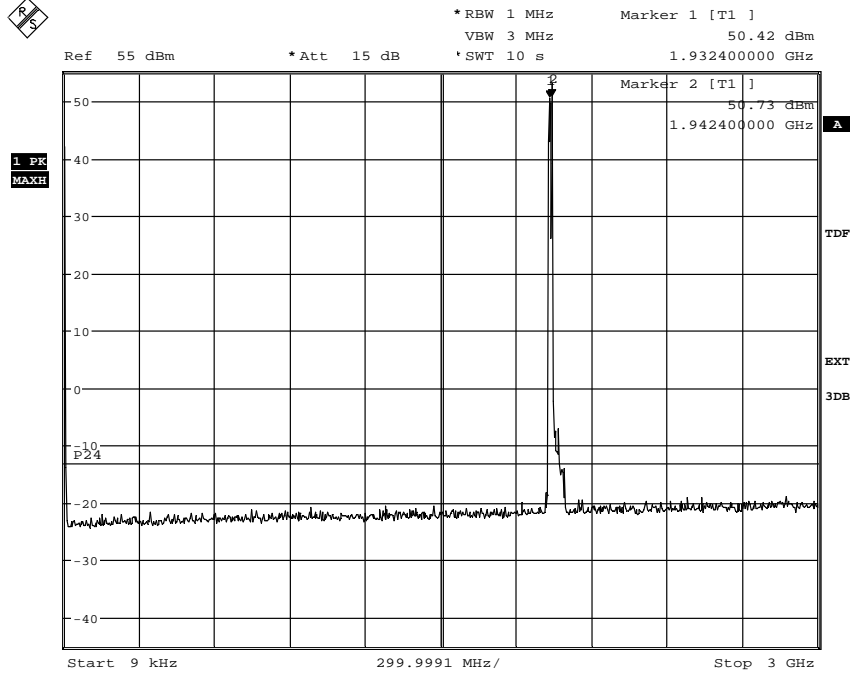

Date: 1.JUL.2011 14:34:46

The emissions around the carriers are within the operating frequency band

Diagram 4b

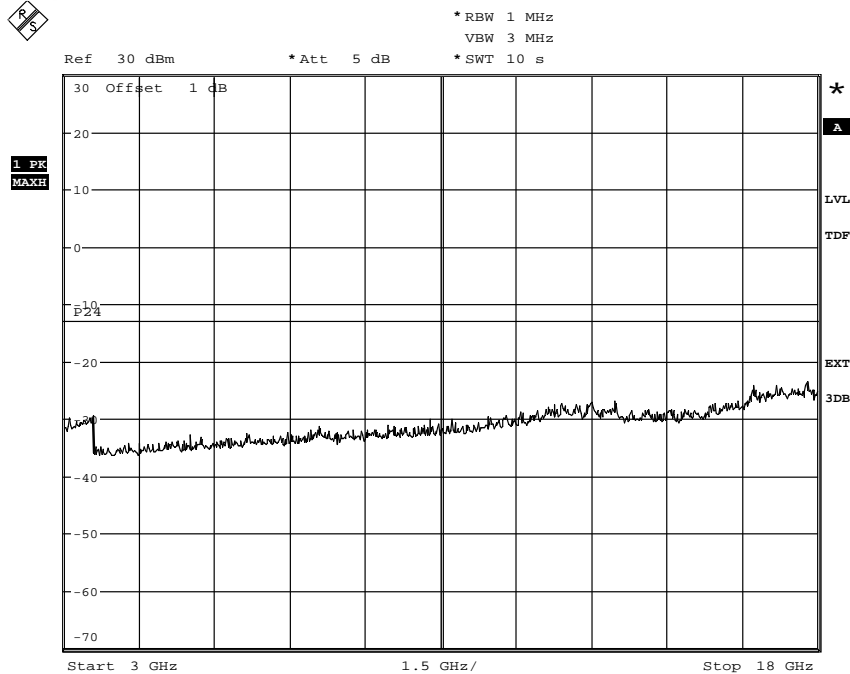

Date: 1.JUL.2011 13:51:32

Appendix 5

Diagram 4c

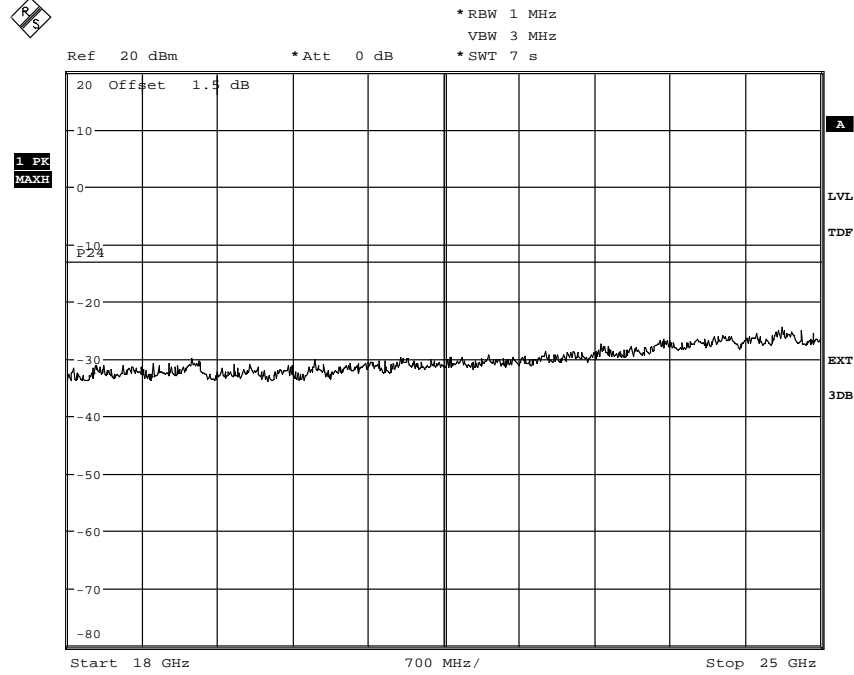

Date: 4.JUL.2011 12:22:57

Appendix 5

Diagram 5a

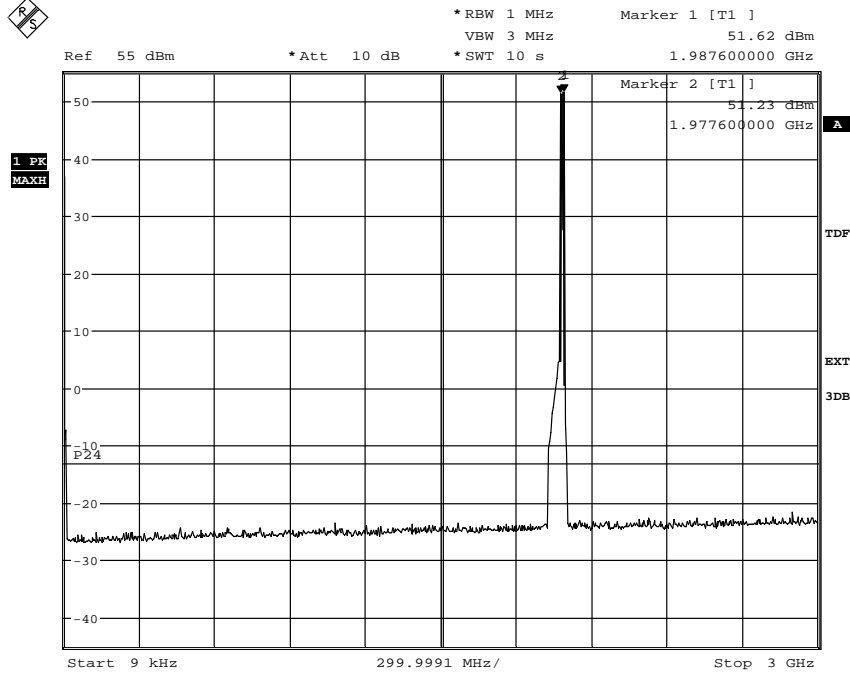

Date: 4.JUL.2011 08:11:28

The emissions around the carriers are within the operating frequency band

Diagram 5b

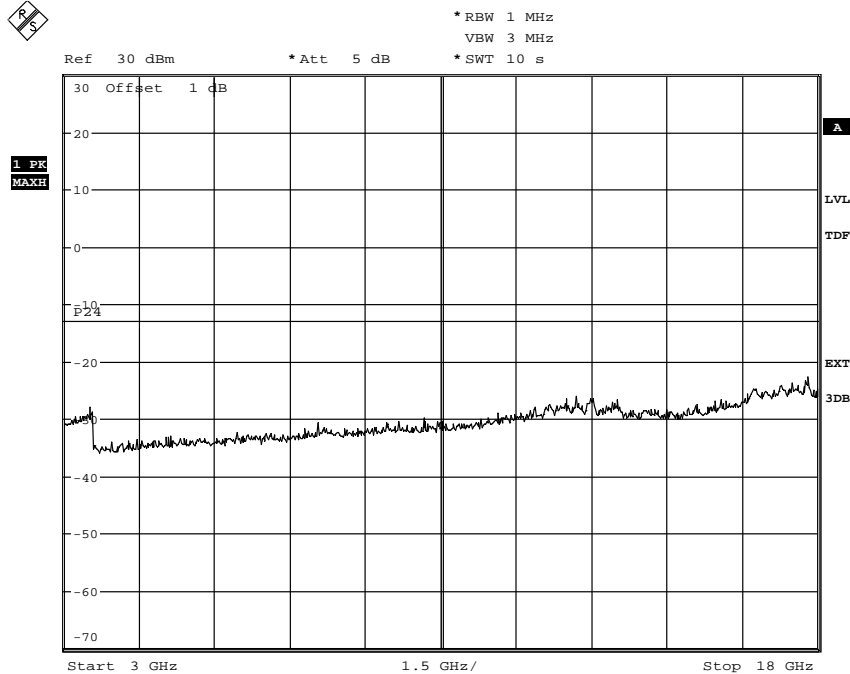

Date: 4.JUL.2011 08:20:28

Appendix 5

Diagram 5c

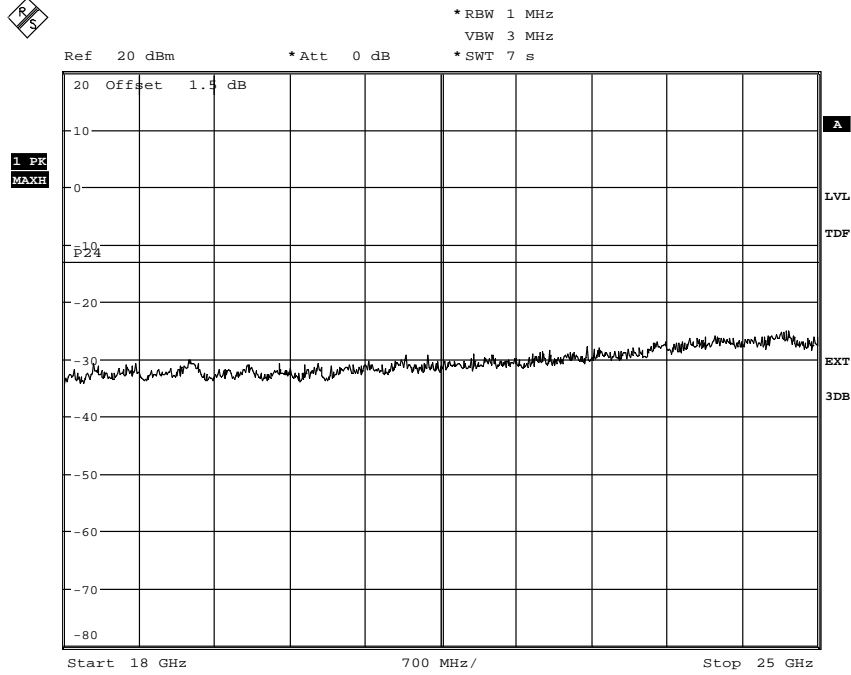

Date: 4.JUL.2011 12:38:31

Appendix 6

Field strength of spurious radiation measurements according to CFR 47 §24.238 / IC RSS-133 6.5

Date	Temperature	Humidity
2011-06-22 to 2011-06-30	23-24°C ± 3 °C	52-64 % ± 5 %

Test set-up and procedure

The test sites are listed at FCC, Columbia with registration number: 93866. The test site complies with RSS-Gen, Industry Canada file no. 3482A-1.

The measurements were performed with both horizontal and vertical polarization of the antenna. The antenna distance was 3 m in the frequency range 30 MHz – 18 GHz and 1m in the frequency range 18 - 25 GHz.

In the frequency range 30 MHz - 25 GHz the measurement was performed in power with a RBW of 1 MHz. A propagation loss in free space was calculated. The used formula was

$$\gamma = 20 \log \left(\frac{4\pi D}{\lambda} \right), \gamma \text{ is the propagation loss and } D \text{ is the antenna distance.}$$

The measurement procedure was as the following:

1. The pre-measurement was first performed with peak detector. The EUT was measured in eight directions and with the antenna at three heights, 1.0 m, 1.5 m and 2.0 m.
2. Spurious radiation on frequencies closer than 20 dB to the limit in the pre-measurement is scanned 0-360 degrees and the antenna is scanned 1- 4 m for maximum response. The emission is then measured with the RMS detector and the RMS value is reported. Frequencies closer than 10 dB to the limit when measured with the RMS detector were measured with the substitution method according to the standard.

The test set-up during the spurious radiation measurements is shown in the picture below:

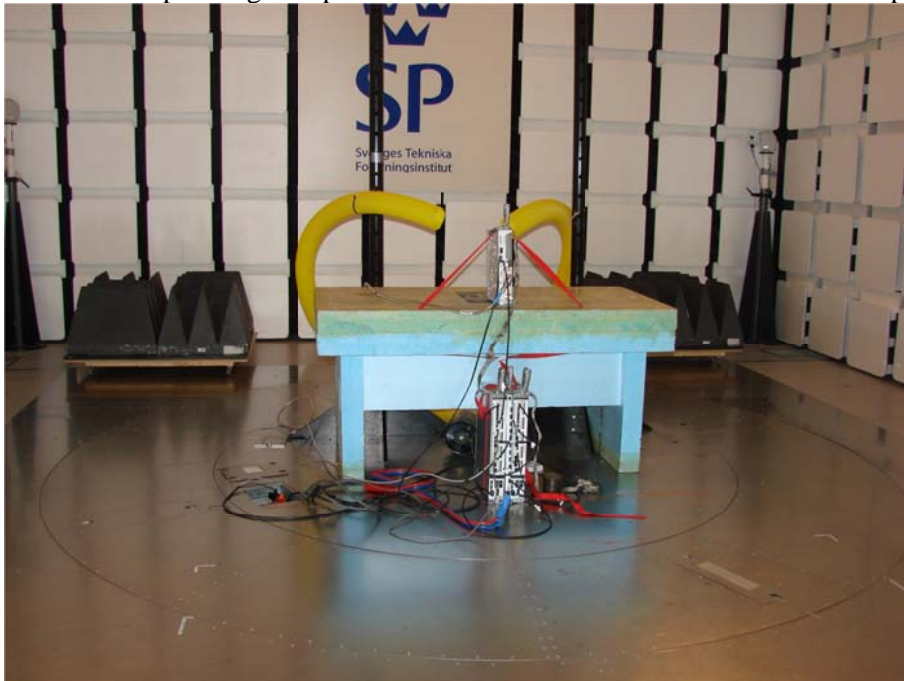

Appendix 6

Measurement equipment

Measurement equipment	SP number
Test site Tesla	503 881
R&S ESI 26	503 292
Control computer	-
R&S FSIQ 40	503 738
Software: R&S EMC32, ver. 8.20.1	503 745
Chase Bilog antenna CBL 6111A	503 182
µCorp Nordic, Low Noise Amplifier	504 160
Miteq, Low Noise Amplifier	503 285
EMCO Horn Antenna 3115	502 175
Standard gain antenna 20240-20	503 674
High pass filter, Wainright	504 200
High pass filter, RLC Electronics	503 739
Testo 625, temperature and humidity meter	504 188

Results

Frequency (MHz)	Spurious emission level (dBm)	
	Vertical	Horizontal
30-25 000	All emission > 20 dB below limit	All emission > 20 dB below limit

Measurement uncertainty:

3.2 dB up to 18 GHz, 3.6 dB above 18 GHz

Limits

§24.238 and RSS-133 6.5

Outside a licensee's frequency band(s) of operation the power of any emission shall be attenuated below the transmitter power (P) by at least $43 + 10 \log (P)$ dB, resulting in a limit of -13 dBm per 1 MHz RBW.

Complies?	Yes
-----------	-----

Appendix 7

Frequency stability measurements according to CFR 47 §24.235 / IC RSS 133 6.3

Date 2011-07-02 to 2011-07-03	Temperature (test equipment) 22-23 °C ± 3 °C	Humidity (test equipment) 48-55 % ± 5 %
----------------------------------	---	--

Test set-up and procedure

The measurement was made per 3GPP TS 25.141. The output was connected to a spectrum analyzer. The spectrum analyzer was connected to an external 10 MHz reference standard during the measurements.

Measurement equipment	SP number
Rohde & Schwarz signal analyzer FSQ40	504 143
RF attenuator	504 159
Testo 635, Temperature and humidity meter	504 203
Temperature cabinet	503 360
Multimeter Fluke 87	502 190

Results

Nominal Voltage -48 V DC

Maximum output power at mid channel (M)

Test conditions		Frequency error (Hz)
Supply voltage DC (V)	T (°C)	
-48.0	+20	+12
-55.2	+20	+8
-40.8	+20	+10
-48.0	+30	-10
-48.0	+40	+11
-48.0	+50	-8
-48.0	+10	-9
-48.0	0	-10
-48.0	-10	-10
-48.0	-20	-8
-48.0	-30	-10
Maximum freq. error (Hz)		11
Measurement uncertainty		$< \pm 1 \times 10^{-7}$

Limits (according to 3GPP TS 25.141)

The frequency error shall be within ± 0.05 PPM ± 12 Hz (109.9 Hz).

Complies?	Yes
-----------	-----

Appendix 8

Receiver spurious emissions measurements according to IC RSS-133 6.6

Date 2011-07-04	Temperature 24 °C ± 3 °C	Humidity 57 % ± 5 %
--------------------	-----------------------------	------------------------

Test set-up and procedure

The measurements were performed according to ANSI C63.4.

Measurements were performed on the receiver antenna terminal (RF B). The measurement is first performed with peak detector. Emission on frequencies close to or above the limit is re-measured with quasi-peak detector (average detector above 1000 MHz).

Measurement equipment	SP number
R&S FSQ40	504 143
RF attenuator (RF A)	900 229
Testo 635, Temperature and humidity meter	504 203

Result

	Channel
Diagram 1	M
Diagram 2	M

Note: During the measurement on the RX port RF B the combined TX/RX port RF A was terminated into 50 ohm, the TX was active in single carrier mode transmitting TM1.

Remark

The highest internal frequency as declared by the client was 2.4576 GHz, thus the choice of the upper frequency boundary was set to 5x2.5 GHz = 12.5 GHz for emission measurements.

Limit

RSS-Gen 6.2 Antenna Conducted limits

Receiver spurious emissions at any discrete frequency shall not exceed 2 nanowatts (-57 dBm) in the band 30-1000 MHz, and 5 nanowatts (-53 dBm) above 1000 MHz.

Emission below limit?	Yes
-----------------------	-----

Appendix 8

Diagram 1

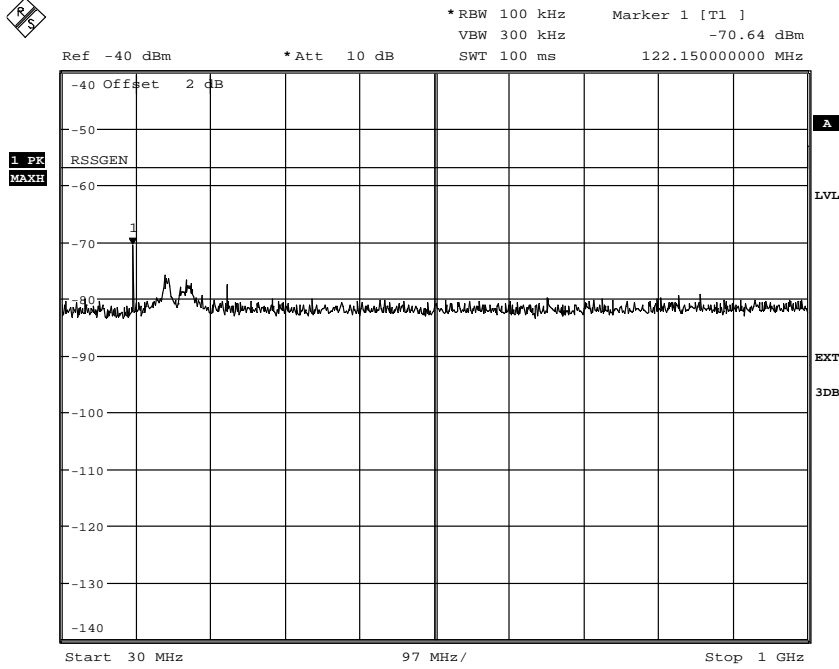

Date: 4.JUL.2011 14:32:55

Diagram 2

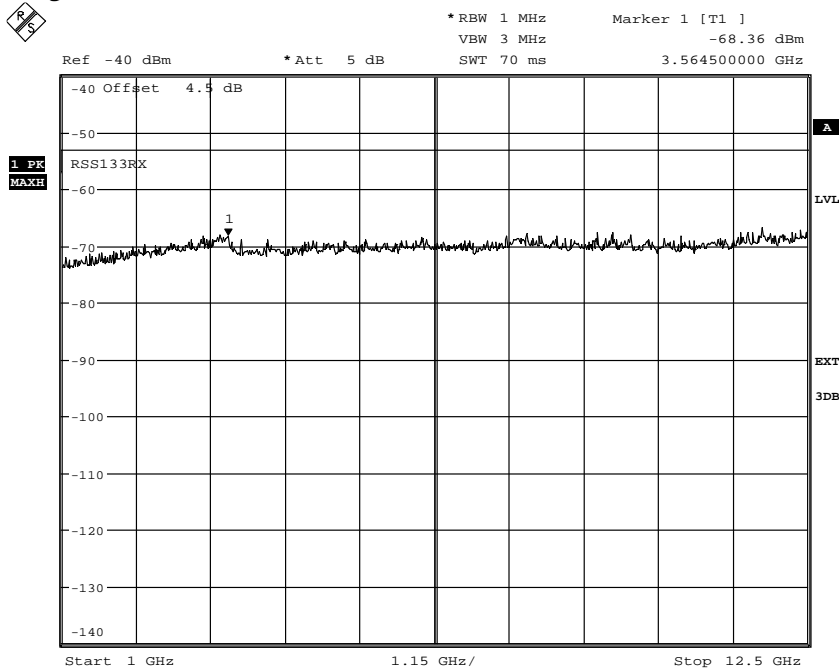

Date: 4.JUL.2011 14:35:20

Appendix 9

External photos

Front side



Rear side

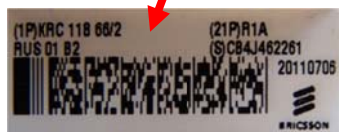

Appendix 9

Left side

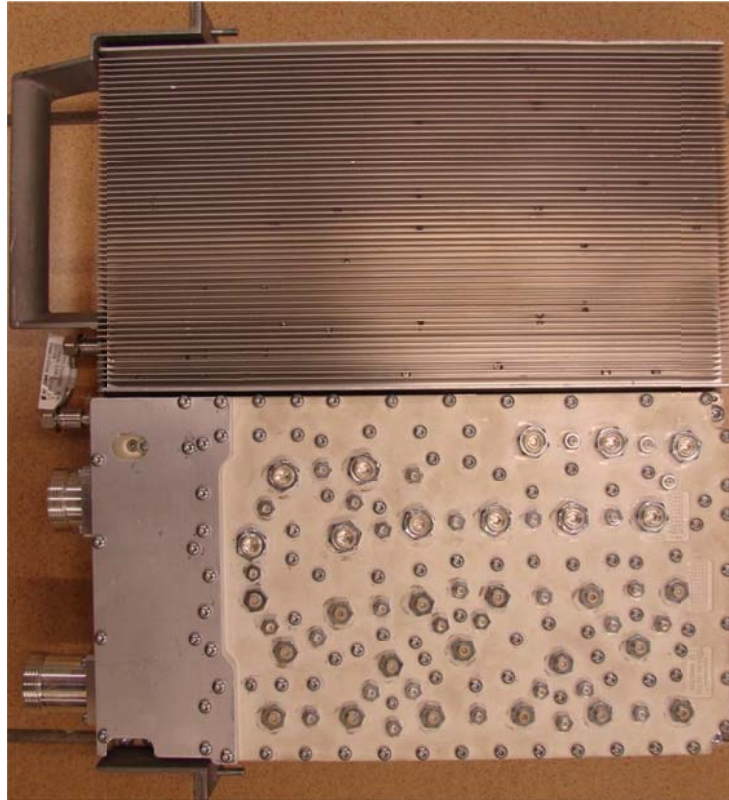

Right side

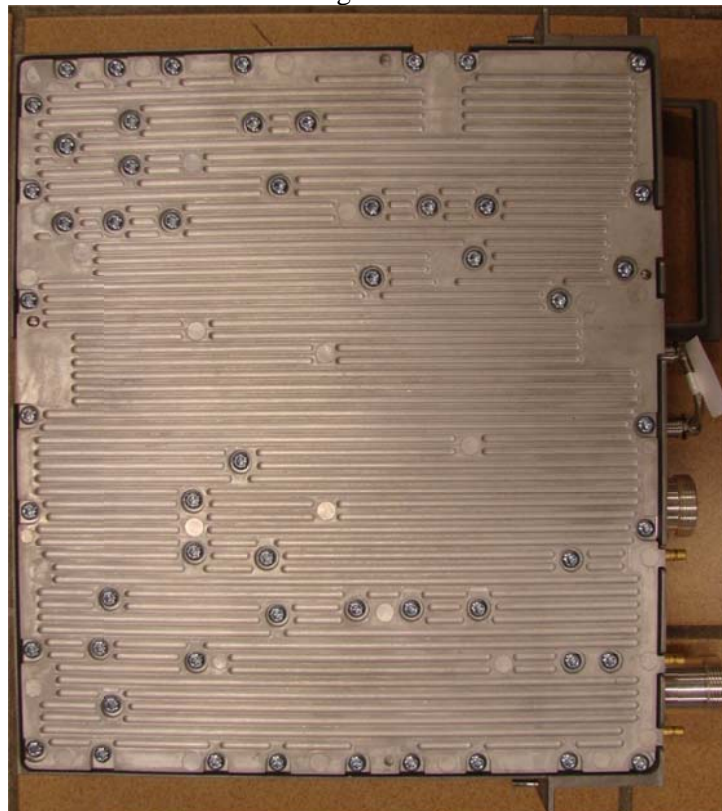

Appendix 9

Bottom side



Top side

