



# REPORT

issued by an FCC listed Laboratory Reg. no. 93866.  
The test site complies with RSS-Gen, IC file no: 3482A

Date  
2011-09-28

Reference  
FX112894-F22W

Page  
1 (2)



Contact person  
**Jonas Bremholt**  
Electronics  
+46 10 516 54 38  
jonas.bremholt@sp.se

Ericsson AB  
Anders Johansson  
PDU Radio Base Station  
164 80 Stockholm

## Radio measurements on RUS 01 B5 850 MHz radio equipment with FCC ID:TA8AKRC11864-3 and IC:287AB-AS118643 (9 appendices)

### Test object

RUS 01 B5, KRC 118 64/3, revision R1A, serial no: C824850036

### Summary

Standard	Compliant	Appendix
<b>FCC CFR 47 / IC RSS-132</b>		
2.1046 / RSS-132 4.4 RF power output	Yes	2
2.1049 / RSS-Gen 4.6.1 Occupied bandwidth	Yes	3
2.1051 / RSS-132 4.5 Band edge	Yes	4
2.1051 / RSS-132 4.5 Spurious emission at antenna terminals	Yes	5
2.1053 / RSS-132 4.5 Field strength of spurious radiation	Yes	6
2.1055 / RSS-132 4.3 Frequency stability	Yes	7
<b>FCC CFR 47/ Industry Canada RSS-132 Issue 2</b>		
RSS-132 4.6 Receiver spurious emissions	Yes	8

Note: Above RSS-132 items are given as cross-reference only. Measurements were performed according to ANSI procedures referenced by FCC and covered by SP's accreditation.

### SP Technical Research Institute of Sweden

#### Electronics - EMC

Performed by

Jonas Bremholt

Examined by

Christer Karlsson

### SP Technical Research Institute of Sweden

Postal address  
SP  
Box 857  
SE-501 15 Borås  
SWEDEN

Office location  
Västeråsen  
Brinellgatan 4  
SE-504 62 Borås  
SWEDEN

Phone / Fax / E-mail  
+46 10 516 50 00  
+46 33 13 55 02  
info@sp.se

Laboratories are accredited by the Swedish Board for Accreditation and Conformity Assessment (SWEDAC) under the terms of Swedish legislation. This report may not be reproduced other than in full, except with the prior written approval of the issuing laboratory.

**Table of contents**

Description of the test object	Appendix 1
Operation mode during measurements	Appendix 1
Test setups	Appendix 1
Purpose of test	Appendix 1
RF power output	Appendix 2
Occupied bandwidth	Appendix 3
Band edge	Appendix 4
Spurious emission at antenna terminals	Appendix 5
Field strength of spurious radiation	Appendix 6
Frequency stability	Appendix 7
Receiver spurious emissions	Appendix 8
External photos	Appendix 9

Appendix 1

**Description – Test object**

Equipment: Radio equipment RUS 01 B5 running in WCDMA mode supporting single and multi carrier.

Antenna ports: 1 TX/RX port and 1 RX port

Frequency bands: TX: 869 – 894 MHz  
RX: 824 – 849 MHz

Modulations: QPSK, 16QAM and 64QAM

Nominal output power: Single carrier: 1x 49.0 dBm (1x 80W)  
(Maximum) Multi carrier: 2x 46.0 dBm (2x 40W)  
4x 43.0 dBm (4x 20W)

Channel bandwidth: 4.2 to 5 MHz (configurable in steps of 100/200 kHz)

Channel spacing: 4.4 to 5 MHz (configurable in steps of 100/200 kHz)

Nominal power voltage: -48 VDC

**Tested channels**

Channel	Downlink		Uplink	
	Frequency*	UARFCN	Frequency*	UARFCN
B	871.4	4357	826.4	4132
B+5	876.4	4382	831.4	4157
B+10	881.4	4407	836.4	4182
B+15	886.4	4432	841.4	4207
M	881.6	4408	836.6	4183
T-15	876.6	4383	831.6	4158
T-10	881.6	4408	836.6	4183
T-5	886.6	4433	841.6	4208
T	891.6	4458	846.6	4233

\* Frequency in MHz

**Operation mode during measurements**

Measurements were performed with the test object transmitting the Test models which are defined in 3GPP TS 25.141. Test model 1 (TM1) uses the QPSK modulation only, Test model 5 (TM5) includes the 16QAM modulation and Test model 6 (TM6) includes the 64QAM modulation.

The settings below were found to be representative for all traffic scenarios when several settings with the different modulations, channel bandwidths and the number of carriers were tested to find the worst case setting. These settings were used for all measurements if not otherwise noted.

Single carrier

TM1: 64 DPCH:s at 30 ksps (SF=128)

Multi carrier

TM1: 32 DPCH:s at 30 ksps (SF=128) in each carrier (Two carriers activated)

Channel bandwidth 5 MHz

Appendix 1

**Conducted measurements**

The EUT was mounted into a RBS 6201 cabinet and supplied by the cabinet’s internal -48 V DC. All RF conducted measurements were performed with the test object configured for maximum transmit power. All TX measurements were done at the RF A connector and the RX measurements were done on the RF B connector.

**Radiated measurements**

The test object was powered with -48 VDC. All measurements were performed with the test object configured for maximum transmit power. The configuration represents worst case for radiated spurious emission measurements.

The RF output power port was via a RF attenuator connected to functional test equipment for supervision.

The RUS unit was allocated to the following UARFCN:

Single Carrier: (One carrier configuration)

Cell	1	1	1
Channel	B	M	T

Multi Carrier: (Two carrier configuration)

Cell	1	2
Channel	B	B+10
Channel	T-10	T

Multi Carrier: (Four carrier configuration)

Cell	1	2	3	4
Channel	B	B+5	B+10	B+15
Channel	T	T-5	T-10	T-15

**Purpose of test**

The purpose of the tests is to verify compliance to the performance characteristics specified in applicable parts of FCC CFR 47, Industry Canada RSS-132 and IC RSS-Gen.

**References**

Measurements were done according to relevant parts of the following standards:

- ANSI C63.4-2009
- ANSI/TIA/EIA-603-C-2004
- 3GPP TS 25.141, version 8.5.0
- CFR 47 part 2, October 1<sup>st</sup>, 2010
- CFR 47 part 22 Subpart H, October 1<sup>st</sup>, 2010
- RSS-132 Issue 2
- RSS-Gen Issue 3

Appendix 1

**Measurement equipment**

Measurement equipment	Calibration Due	SP number
Test site Tesla	2012-10	503 881
R&S FSIQ 40	2012-07	503 738
R&S FSQ 40	2012-07	504 143
R&S ESI 26	2012-07	503 292
Control computer with R&S software EMC32 version 8.20.1	-	503 479
High pass filter	2012-07	504 199
High pass filter	2012-07	504 200
High pass filter	2012-07	503 739
High pass filter	2012-07	503 740
RF attenuator	2012-07	504 159
RF attenuator	2012-07	900 233
Boonton RF Peak power meter/analyzer	2011-10	503 144
Boonton Power sensor 56518-S/4	2012-10	503 145
Chase Bilog Antenna CBL 6111A	2011-10	503 182
EMCO Horn Antenna 3115	2014-01	502 175
Std.gain horn FLANN model 20240-20	-	503 674
µComp Nordic, Low Noise Amplifier	2012-07	504 160
MITEQ Low Noise Amplifier	2012-07	503 285
Temperature cabinet	-	503 360
Multimeter Fluke 87	2012-05	502 190
Testo 625, Temperature and humidity meter	2012-06	504 188
Testo 635 Temperature and humidity meter	2012-05	504 203

**Uncertainties**

Measurement and test instrument uncertainties are described in the quality assurance documentation "SP-QD 10885". The measurement uncertainties can be found in the table below. The uncertainties are calculated with a coverage factor k=2 (95% level of confidence).

**Reservation**

The test results in this report apply only to the particular test object as declared in the report.

**Delivery of test object**

The test object was delivered 2011-08-10.

**Manufacturer's representative**

Christer Gustavsson, Ericsson AB

**Test engineers**

Jörgen Wassholm, and Jonas Bremholt

**Test participant(-s)**

Xiang Yue, Ericsson CBC (Partly present)

Appendix 1

Test set-up conducted measurements TX

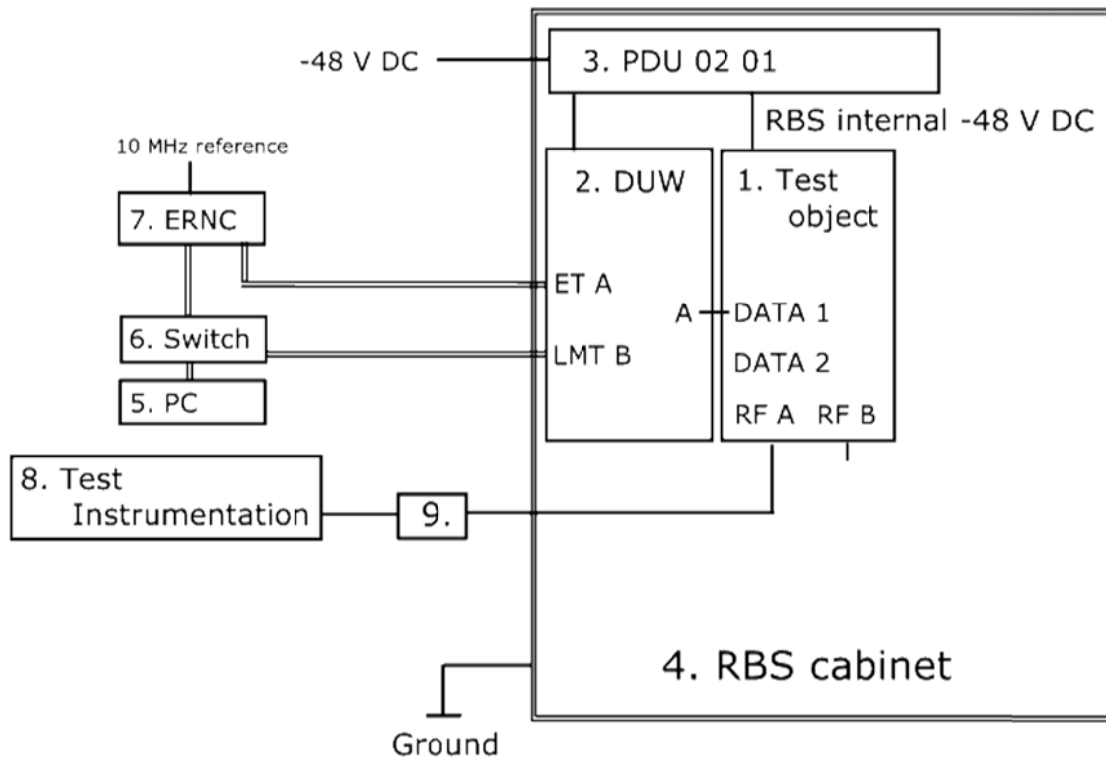

**Test object**

1. RUS 01 B5, KRC 118 64/3, revision R1A, S/N: C824850036 (FCC ID:TA8AKRC11864-3 / IC:287AB-AS118643)

**Functional test equipment**

2. PDU 02 01, BMG 980336/4, R2A, (S)BJ31528316
3. DU units:  
Configuration single carrier (1x1) and multi carrier (1x2)  
DU: DUW 30 01 KDU 127 161/3 Rev R4C, S/N: C824599840  
Configuration multi carrier (1x4)  
DU 1: DUW 30 01 KDU 127 161/3 Rev R4C, S/N: C824599840 and  
DU 2: DUW 30 01 KDU 127 161/3 Rev R3C, S/N: C824357268
4. RBS 6201 cabinet, BAMS 1000778792
5. Computer, Sunblade 1500
6. Ethernet switch, Mercury H108M
7. ERNC, BAMS – 1000759880
8. SP test instrument according measurement equipment list
9. RF attenuator

Appendix 1

**Test set-up conducted measurements RX**

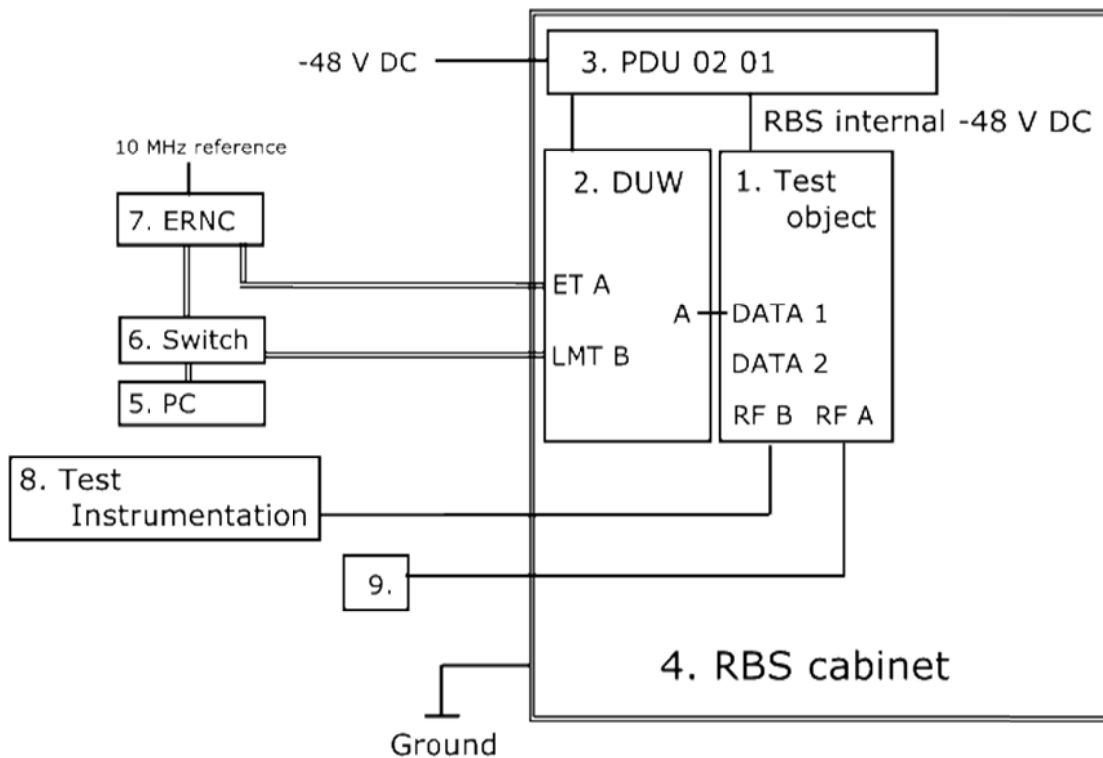

**Test object**

- 1 RUS 01 B5, KRC 118 64/3, revision R1A, S/N: C824850036  
(FCC ID:TA8AKRC11864-3 / IC:287AB-AS118643)

**Functional test equipment**

2. PDU 02 01, BMG 980336/4, R2A, (S)BJ31528316
3. DU units:  
Configuration single carrier (1x1) and multi carrier (1x2)  
DU: DUW 30 01 KDU 127 161/3 Rev R4C, S/N: C824599840  
Configuration multi carrier (1x4)  
DU 1: DUW 30 01 KDU 127 161/3 Rev R4C, S/N: C824599840 and  
DU 2: DUW 30 01 KDU 127 161/3 Rev R3C, S/N: C824357268
4. RBS 6201 cabinet, BAMS 1000778792
5. Computer, Sunblade 1500
6. Ethernet switch, Mercury H108M
7. ERNC, BAMS – 1000759880
8. SP test instrument according measurement equipment list
9. RF attenuator

Appendix 1

**Test set-up radiated measurements**

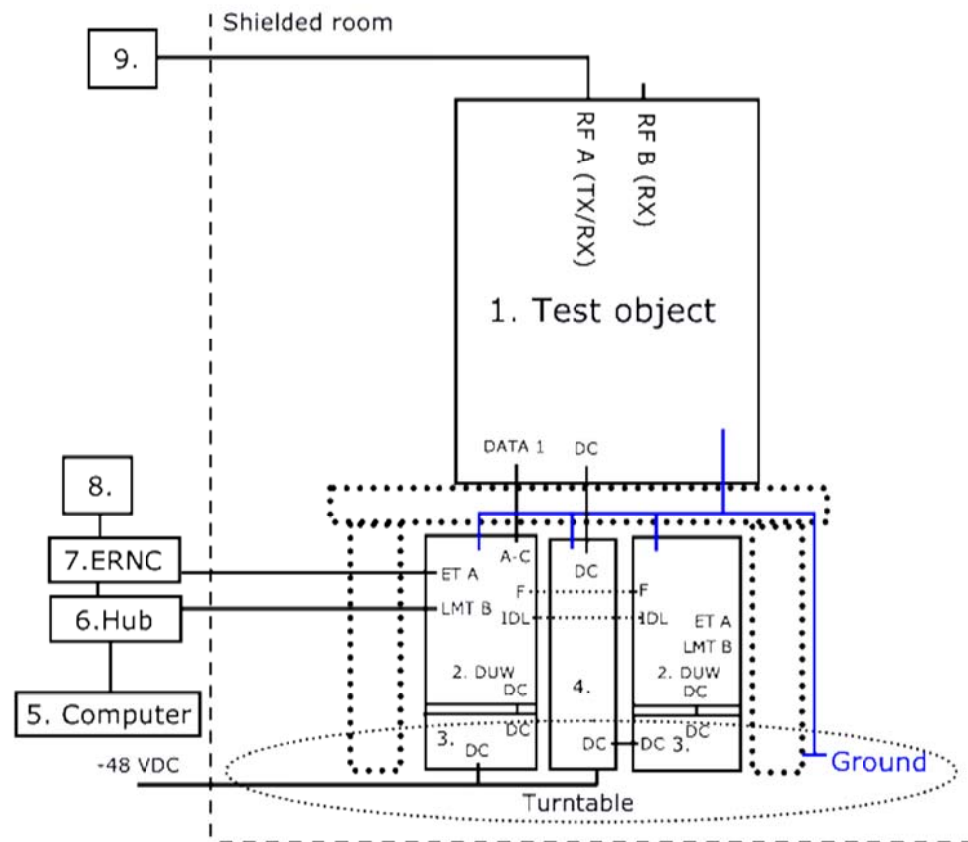

**Test object**

1. RUS 01 B5, KRC 118 64/3, revision R1A, S/N: C824850036 (FCC ID:TA8AKRC11864-3 / IC:287AB-AS118643)

**Functional test equipment**

2. DU units  
Configuration single carrier (1x1) and multi carrier (1x2)  
DU: DUW 30 01, KDU 127 161/3, Rev R4C, S/N: C824599840  
Configuration multi carrier (1x4)  
DU 1: DUW 30 01, KDU 127 161/3, Rev R4C, S/N: C824599840 and  
DU 2: DUW 30 01, KDU 127 161/3, Rev R3C, S/N: C824357268
3. SUP 1: SUP 6601, 1/BFL 901 009/1, Rev R3B, S/N: BR81262576  
SUP 2: SUP 6601, 1/BFL 901 009/1, Rev R3B, S/N: BR81262561
4. PDU 02 01, BMG 980 336/4, Rev R2A, S/N: BJ31534775
5. Computer Sunblade 1500
6. Mercury mini hub H108M
7. ERNC, BAMS – 1000759880
8. 10 MHz reference
9. Terminator



Appendix 1

**Test object interfaces**

**Type of port:**

Power configuration: -48 VDC	DC Power
Ground via RBS frame during conducted measurements, Ground via ground strap during radiated stand-alone measurements	Ground
Antenna port RF A, combined TX/RX, female 7/16 connector	Antenna
Antenna port RF B, RX only, female 7/16 connector	Antenna
Cross connect RX A, not supported, omitted in set-up drawings above	-
Cross connect RX B, not supported, omitted in set-up drawings above	-
RXA CO-site, not supported, omitted in set-up drawings above	-
Data 1, connected to DUW port RI A	Signal
Data 2, not supported	-

**RBS software**

Software	Revision
CXP 901 8436/1	R2AA02

Appendix 2

**RF power output measurements according to 47 CFR 2.1046, 22.913 / RSS-132 4.4**

Date 2011-08-29 to 2011-08-31	Temperature 22-23 °C ± 3 °C	Humidity 51-53 % ± 5 %
----------------------------------	--------------------------------	---------------------------

**Test set-up and procedure**

The test object was connected to a power analyzer measuring peak and RMS output power in CDF mode.

Measurement equipment	SP number
Boonton RF Peak power meter/analyzer	503 144
Boonton Power sensor 56518-S/4	503 146
RF attenuator	504 159
Testo 635, temperature and humidity meter	504 203

**Measurement uncertainty: 0.7 dB**

**Results**

Single carrier: Rated output power level at RF A connector (maximum): 1x 49 dBm

Transmitter power (dBm / dB) RMS / PAR		
B	M	T
48.7/ 6.9	48.5/ 6.8	48.6/ 6.9

Multi carrier: Rated output power level at RF A connector (maximum): 2x 46 dBm/ carrier

Transmitter power (dBm / dB) RMS / PAR		
B	M	T
45.8/ 9.4	45.8/ 9.3	45.7/ 9.5

Multi carrier: Rated output power level at RF A connector (maximum): 2x 46 dBm/ carrier

Combined Transmitter power (dBm / dB) RMS / PAR		
B+(B+5)	M+(M+5)	(T-5) +T
48.6/ 7.0	48.7/ 6.6	48.6/ 7.1

Appendix 2

Multi carrier: Rated output power level at RF A connector (maximum): 4x 43 dBm/ carrier

Transmitter power (dBm / dB) RMS / PAR		
B	M	T
42.7/ 10.5	42.8/ 10.4	42.8/ 10.6

Multi carrier: Rated output power level at RF A connector (maximum): 4x 43 dBm/ carrier

Combined Transmitter power (dBm / dB) RMS / PAR		
$B+(B+5)+(B+10)+\dots+(B+15)$	$(M-5) + M + (M+5) + (M+10) + \dots$	$(T-15) + (T-10) + \dots + (T-5) + T$
48.5/ 7.4	N/A	48.4/ 7.1

**Limits**

According to CFR 47/ RSS there are no conducted limits at the antenna connector.

CFR § 22.913/ SRSP-503 5.1: The effective radiated power (ERP) of base transmitters and cellular repeaters must not exceed 500 Watts (57 dBm).

RSS-132: The transmitter output power shall not exceed the limits given in SRSP-503

Complies?	Yes
-----------	-----

Appendix 3

**Occupied bandwidth measurements according to 47 CFR 2.1049 / RSS-Gen 4.6.1**

Date	Temperature	Humidity
2011-08-29	23 °C ± 3 °C	52 % ± 5 %
2011-08-30	22 °C ± 3 °C	51 % ± 5 %

**Test set-up and procedure**

The measurements were made per definition in §2.1049. The output was connected to a signal analyzer with the RMS detector activated. The signal analyzer was connected to an external 10 MHz reference standard during the measurements.

Measurement equipment	SP number
Rohde & Schwarz signal analyzer FSQ40	504 143
RF attenuator	504 159
Testo 615 temperature and humidity meter	503 498

Measurement uncertainty: 3.7 dB

**Results**

Diagram	BW configuration	Tested frequency	Occupied BW (99%) [MHz]	Emission BW (99.75%) [MHz]
1	5.0 MHz	B	4.18	4.37
2	5.0 MHz	M	4.18	4.38
3	5.0 MHz	T	4.17	4.37
4	4.2 MHz	B	3.85	3.95
5	4.2 MHz	M	3.85	3.95
6	4.2 MHz	T	3.85	3.95

Appendix 3

Diagram 1

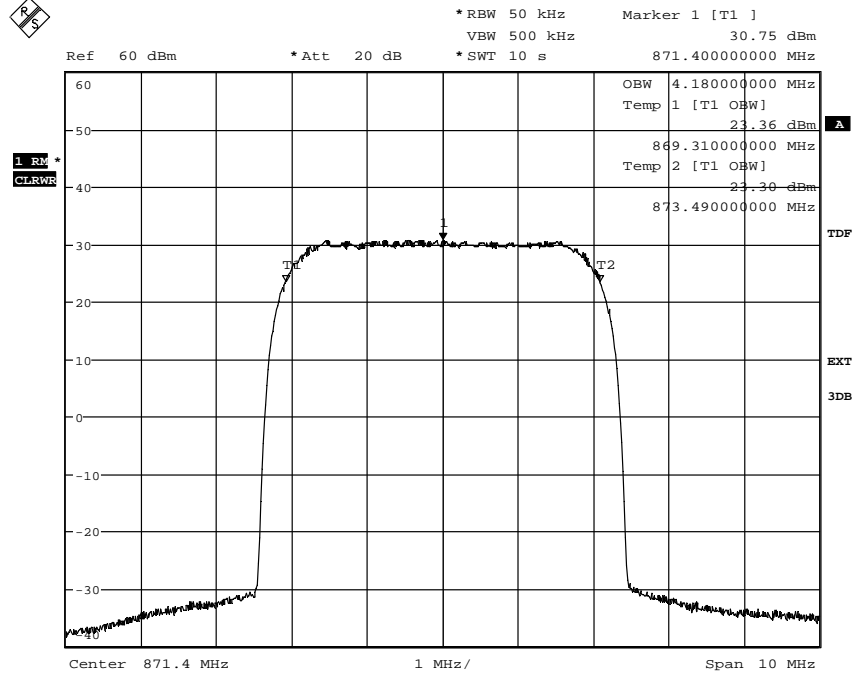

Date: 30.AUG.2011 11:20:12

Diagram 2

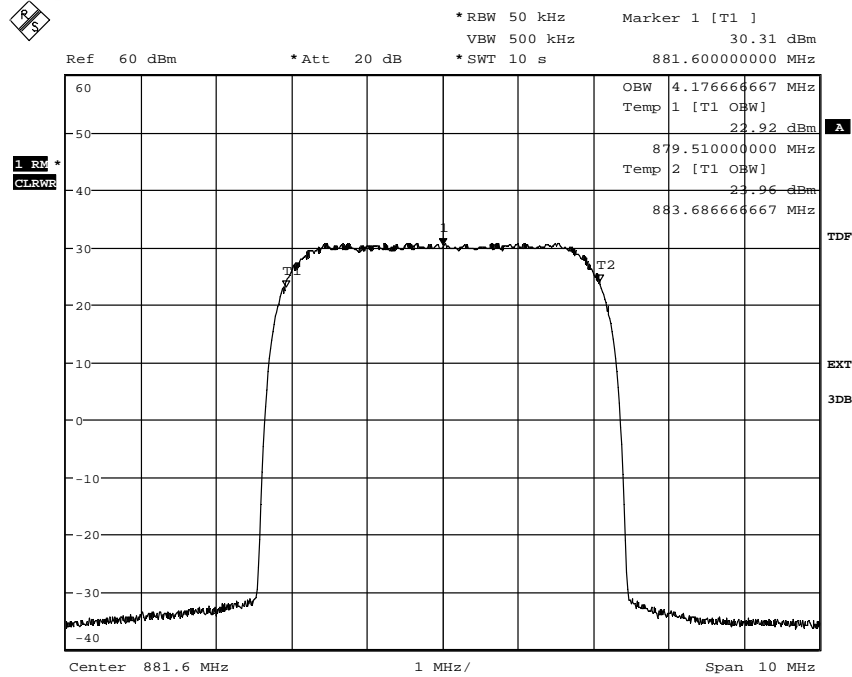

Date: 29.AUG.2011 10:53:22

Appendix 3

Diagram 3

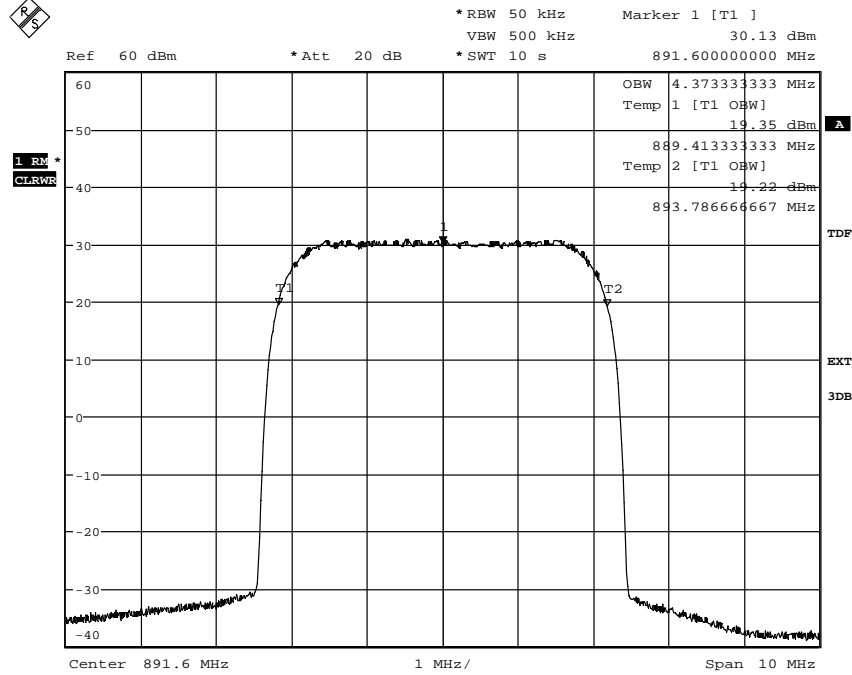

Date: 30.AUG.2011 09:57:57

Diagram 4

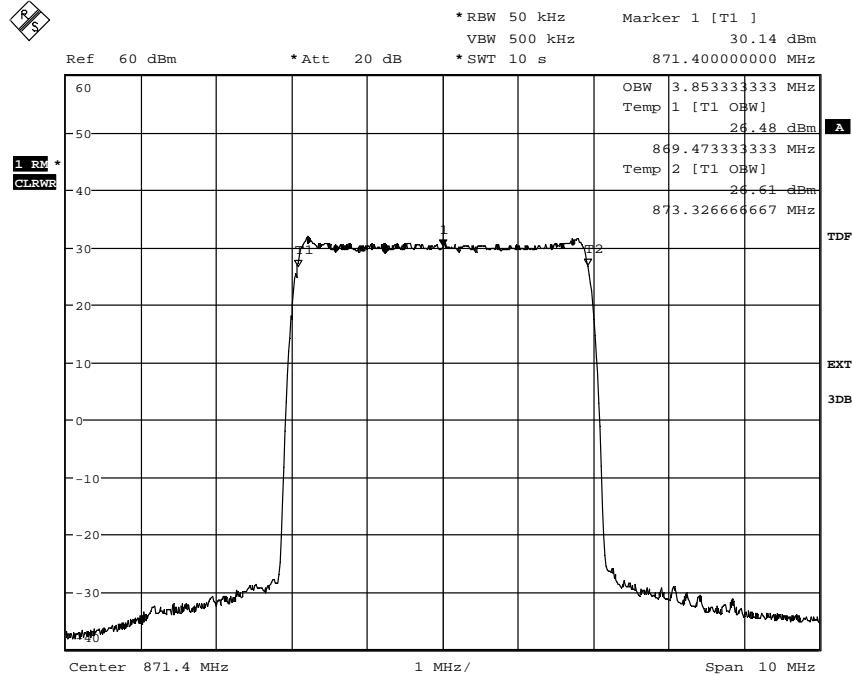

Date: 29.AUG.2011 15:11:51

Appendix 3

Diagram 5

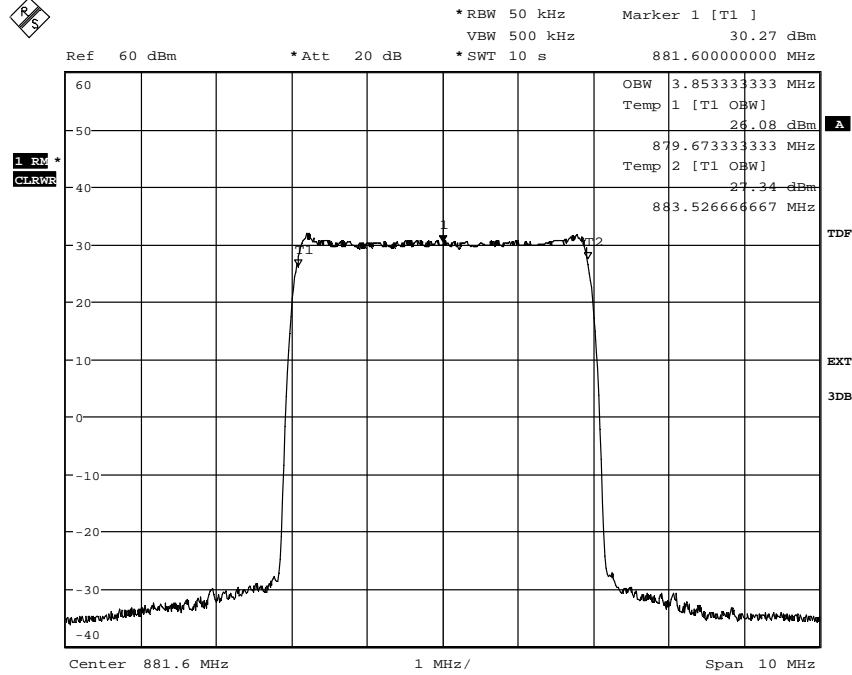

Date: 29.AUG.2011 14:18:13

Diagram 6

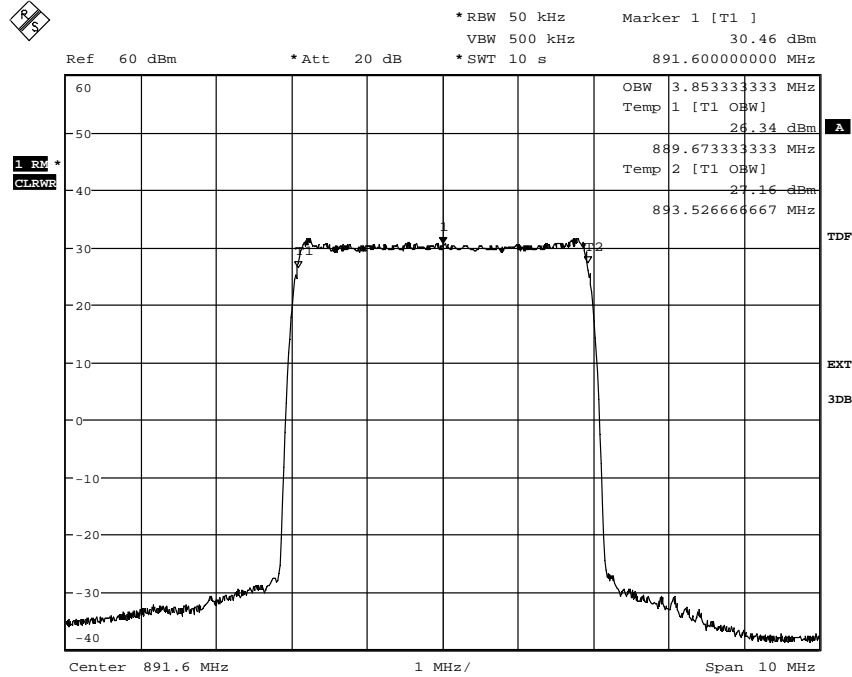

Date: 29.AUG.2011 14:58:18

Appendix 4

**Band edge measurements according to 47 CFR 2.1051, 22.917 / RSS-132 4.5**

Date 2011-08-29 to 2011-08-31	Temperature 22-23 °C ± 3 °C	Humidity 51-53 % ± 5 %
----------------------------------	--------------------------------	---------------------------

**Test set-up and procedure**

The output was connected to a spectrum analyzer with the RMS detector activated. The spectrum analyzer was connected to an external 10 MHz reference standard during the measurements. Both 22.917 and RSS-132 specifies a RBW of at least 1 % of the emission bandwidth up to 1 MHz away from the band edges. A resolution bandwidth of 20 kHz was used up to 1 MHz away from the band edges. 20 kHz is <1% of the Emission BW (4.37 MHz between the 26 dB points for 5 MHz nominal BW setting). To compensate for the reduced resolution bandwidth, the limit was adjusted with 3.39 dB to -16.39 dBm. 22.917 specifies a RBW of at least 100 kHz for measurements of emission >1 MHz away from the band edges and RSS-132 specifies a RBW of at least 1 MHz for measurements of emission >1MHz away from the band edges for equipment having an emission bandwidth of >4 MHz. A resolution bandwidth of 200 kHz was used 1 MHz to 6 MHz away from the band edges, to compensate for the reduced resolution bandwidth the limit was adjusted by 7 dB to -20 dBm.

Measurement equipment	SP number
R&S FSQ	504 143
RF attenuator	504 159
Testo 635, temperature and humidity meter	504 203

Measurement uncertainty: 3.7 dB

**Results**

Single carrier:

Diagram 1: B

Diagram 2: T

Multi carrier:

Diagram 3: B+(B+5)

Diagram 4: T+(T-5)

**Limits**

The power of any emission outside the frequency band shall be attenuated below the transmitter power (P) by at least  $43 + 10 \log P$  dB, resulting in a limit of -13 dBm.

Complies?	Yes
-----------	-----



Appendix 4

Diagram 1a:

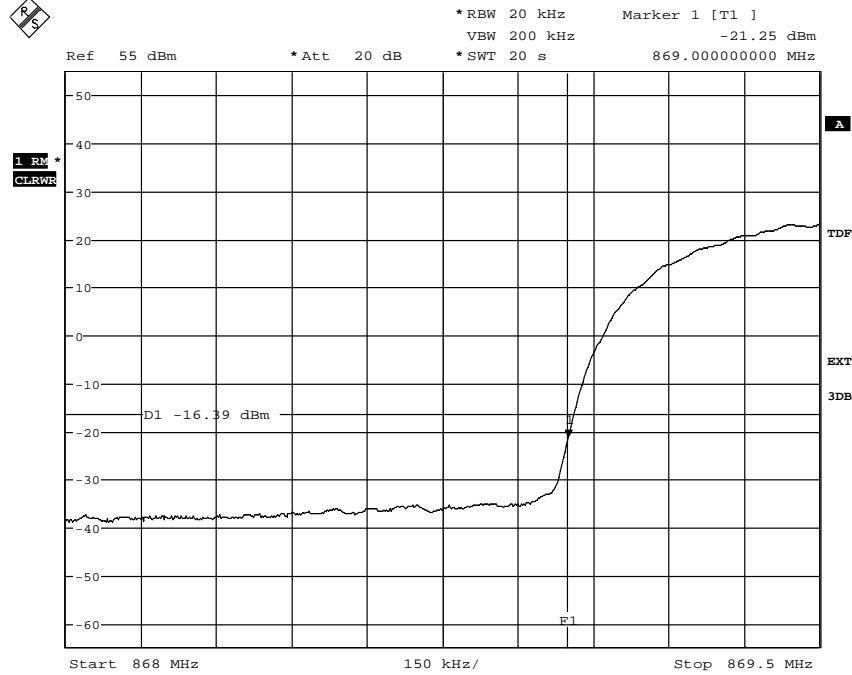

Date: 30.AUG.2011 12:16:56

Diagram 1b:

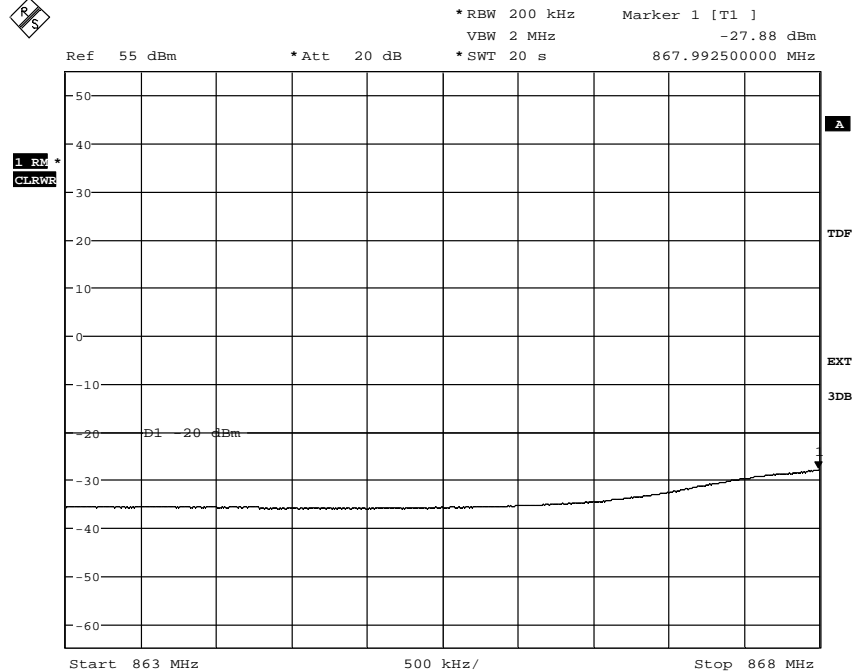

Date: 30.AUG.2011 12:19:13

Appendix 4

Diagram 1c

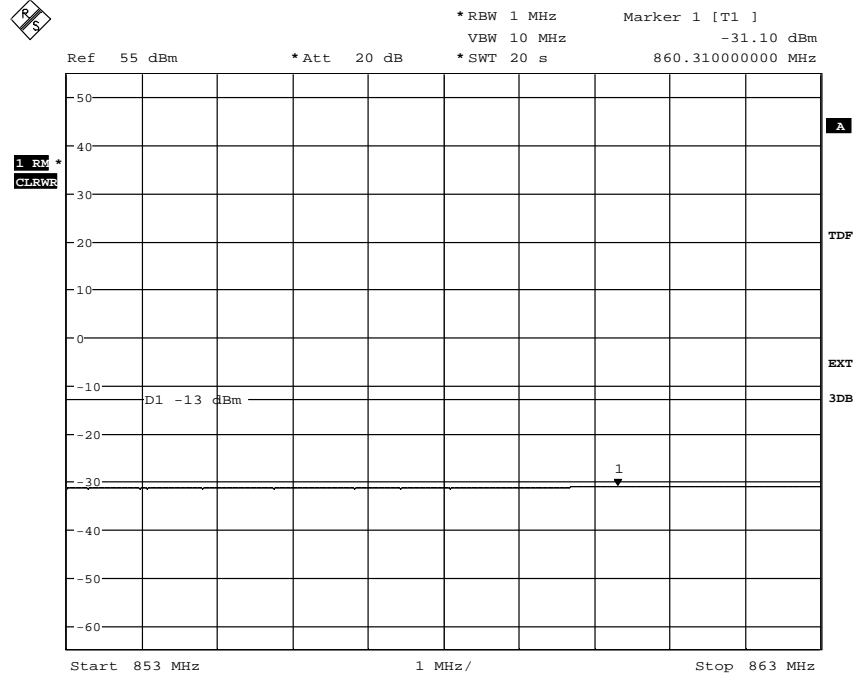

Date: 30.AUG.2011 12:20:22

Appendix 4

Diagram 2a:

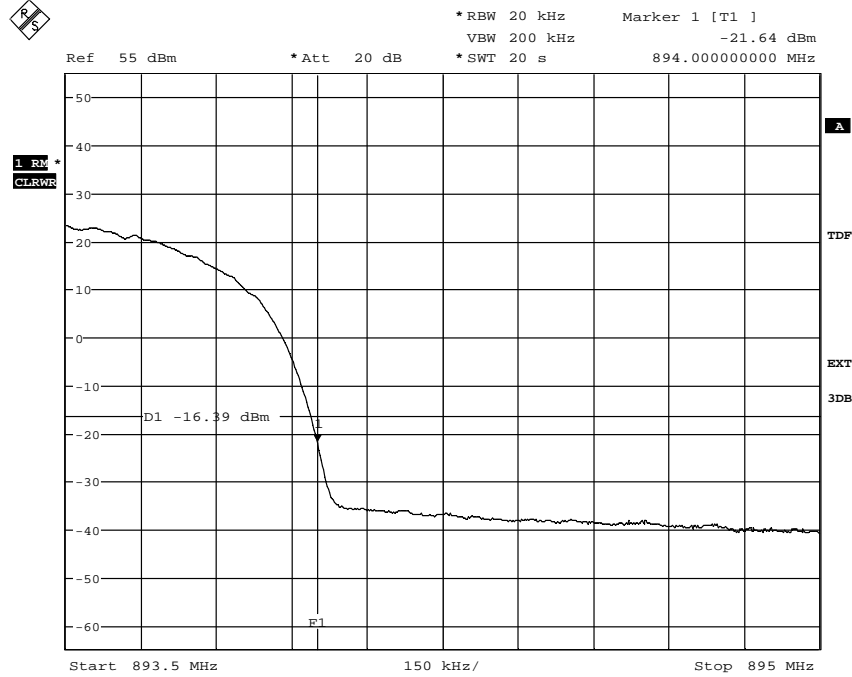

Date: 30.AUG.2011 10:10:06

Diagram 2b:

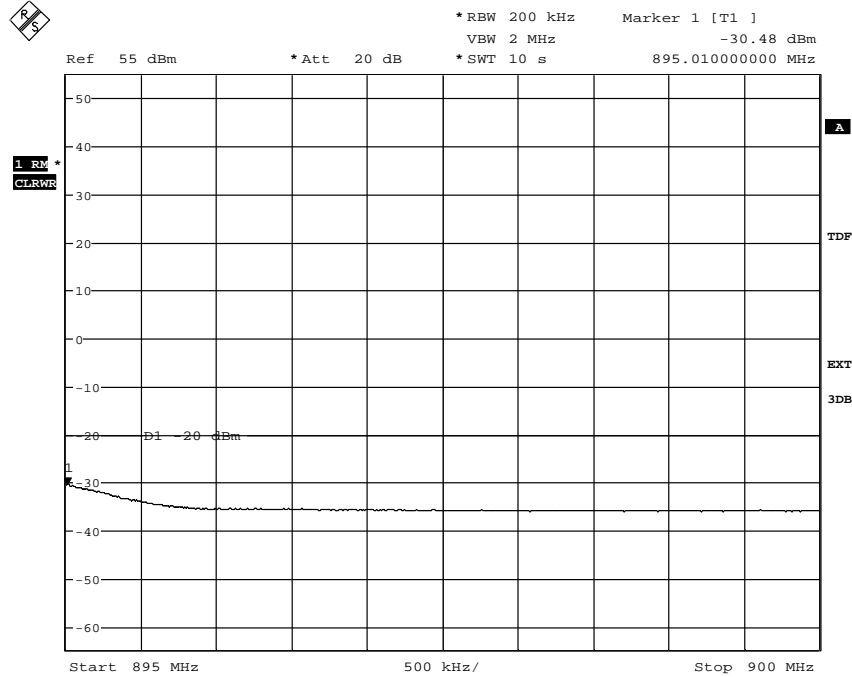

Date: 30.AUG.2011 10:12:18

Appendix 4

Diagram 2c:

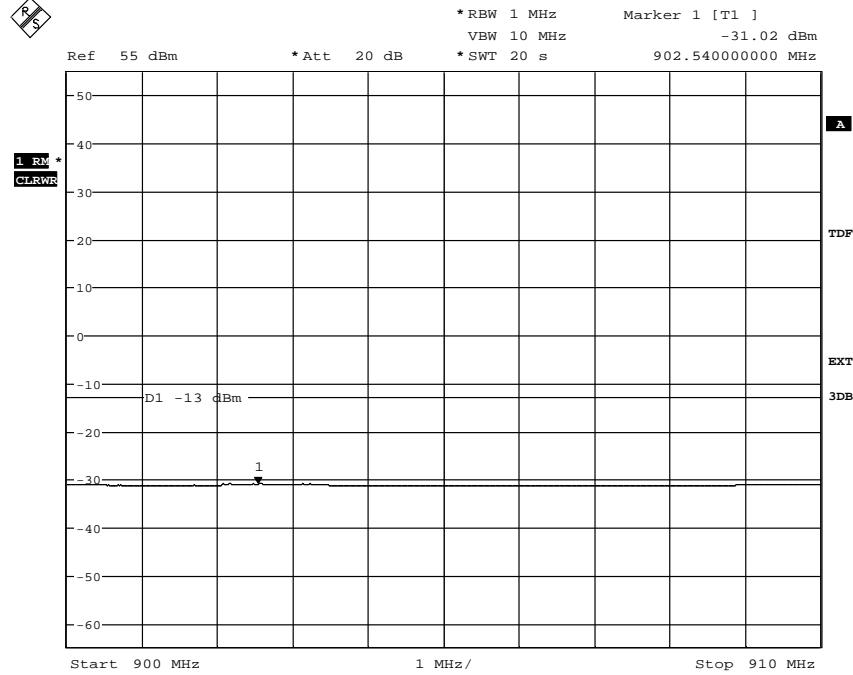

Date: 30.AUG.2011 10:13:55

Appendix 4

Diagram 3a:

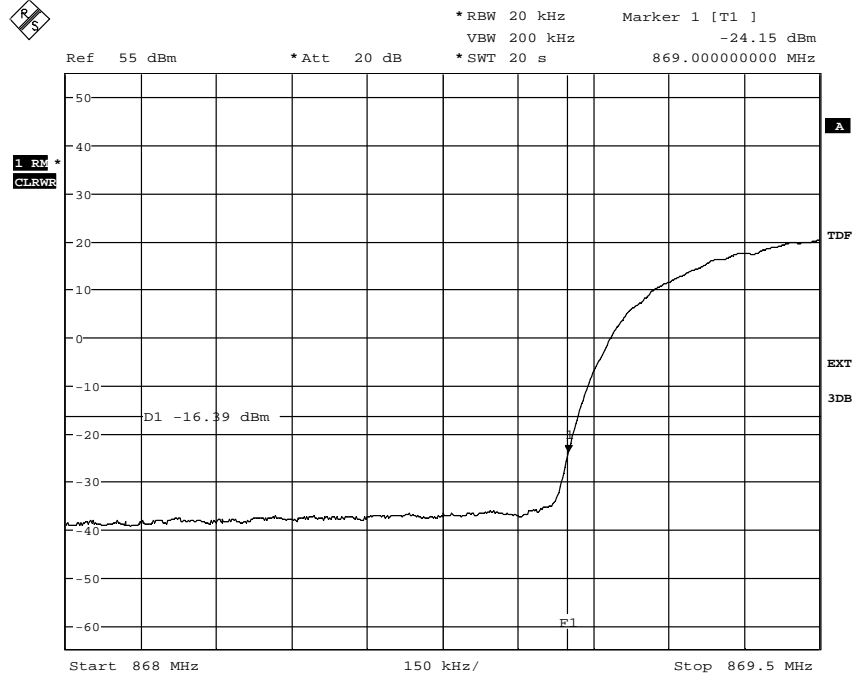

Date: 30.AUG.2011 14:43:08

Diagram 3b:

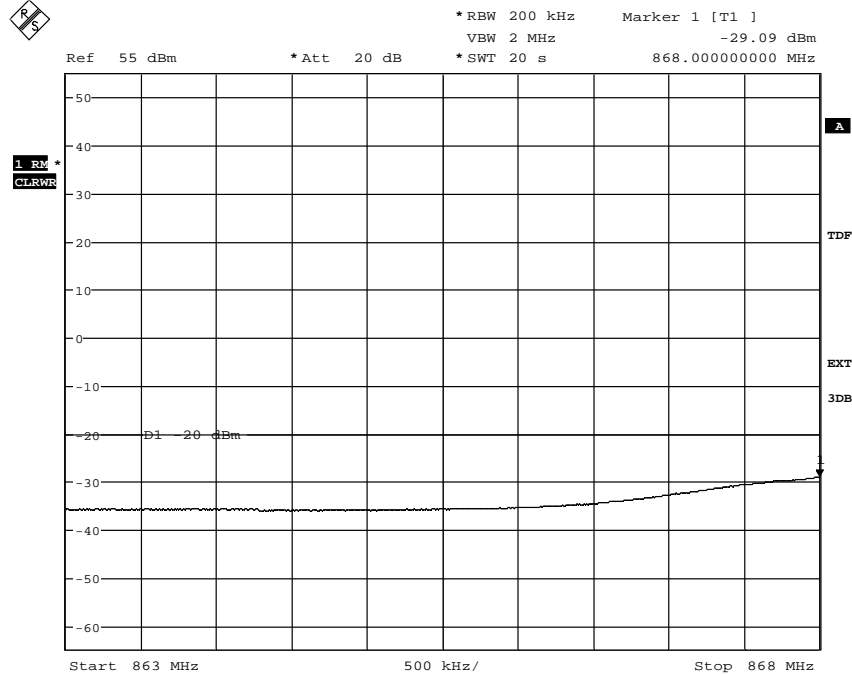

Date: 30.AUG.2011 14:48:38

Appendix 4

Diagram 3c:

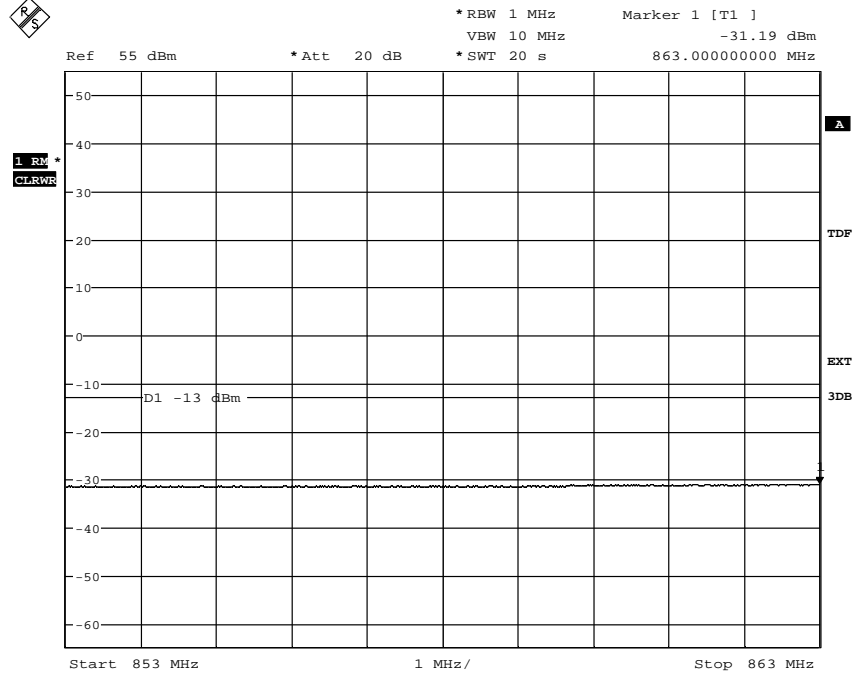

Date: 30.AUG.2011 14:46:51

Appendix 4

Diagram 4a:

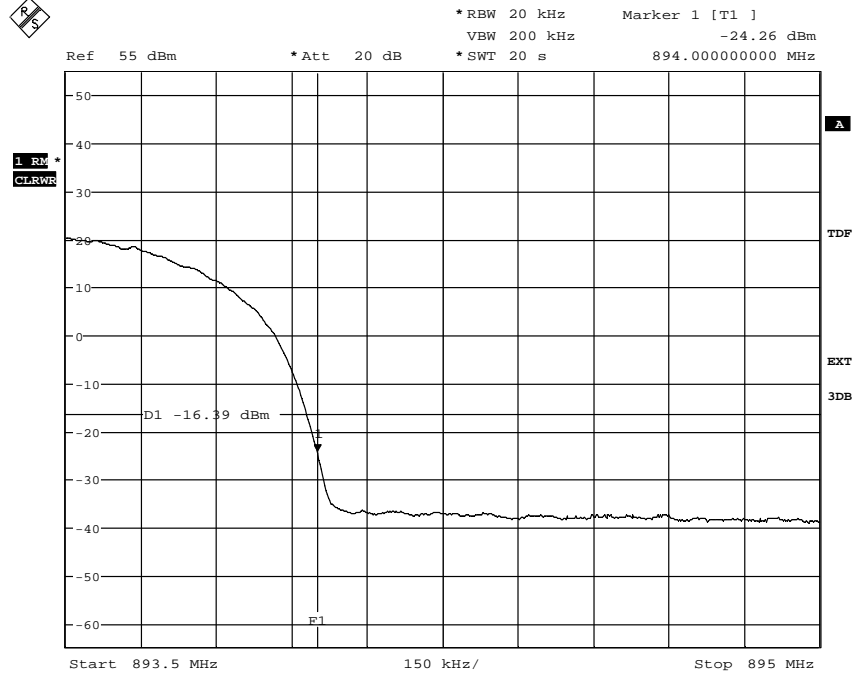

Date: 31.AUG.2011 09:01:49

Diagram 4b:

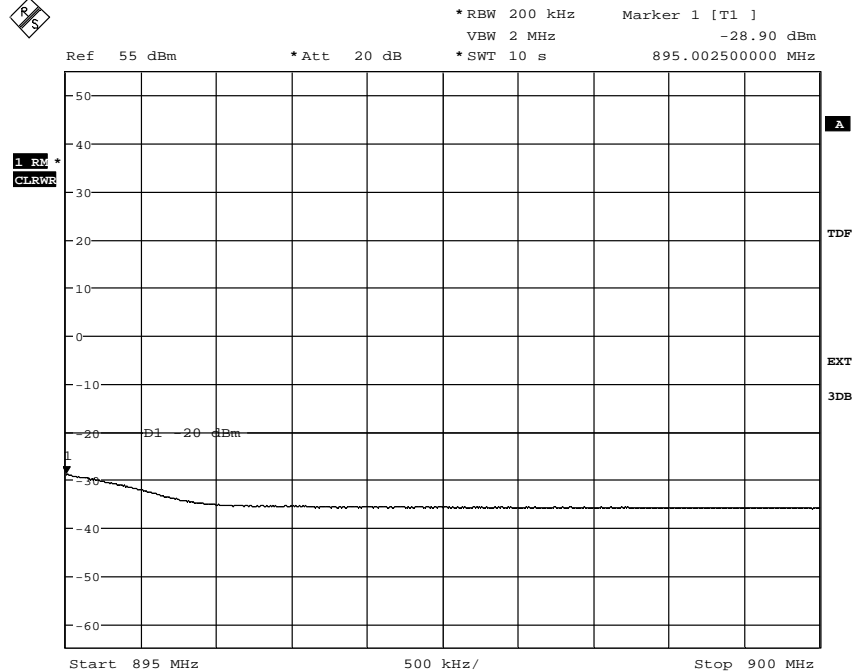

Date: 31.AUG.2011 09:05:06

Appendix 4

Diagram 4c:

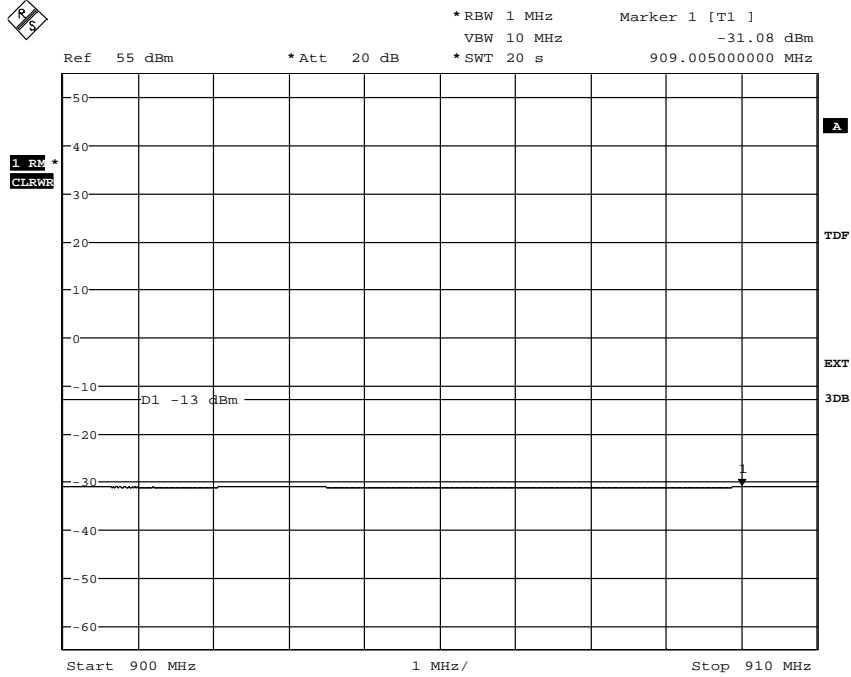

Date: 31.AUG.2011 09:06:52



Appendix 5

**Conducted spurious emission measurements according to 47 CFR 2.1051, 22.917 / RSS-132 4.5**

Date 2011-08-29 to 2011-08-31	Temperature 22-23 °C ± 3 °C	Humidity 51-53 % ± 5 %
----------------------------------	--------------------------------	---------------------------

**Test set-up and procedure**

The measurements were made with a resolution bandwidth of 1 MHz instead of 100 kHz as RSS-132 specifies a resolution bandwidth of 1 MHz for equipment with an emission bandwidth of  $\geq 4$  MHz. The output was connected to a spectrum analyzer with the RMS detector activated.

Measurement equipment	SP number
R&S FSQ	504 143
RF attenuator	504 159
High pass filter	504 199
High pass filter	503 739
RF attenuator	900 229
High pass filter	503 740
Testo 635 temperature and humidity meter	504 203

Measurement uncertainty: 3.7 dB

**Results**

Single carrier:

- Diagram 1 a-e: B
- Diagram 2 a-e: M
- Diagram 3 a-e: T

Multi carrier:

- Diagram 4 a-e: B+(B+10)
- Diagram 5 a-e: T+(T-10)

**Remark**

The emission at 9 kHz on the plots was not generated by the test object. A complementary measurement with a smaller RBW showed that it was related to the LO feed-through.

The highest internal frequency as declared by the client was 2.4576 GHz, thus the choice of the upper frequency boundary was set to  $10 \times 2.5 \text{ GHz} = 25 \text{ GHz}$  for emission measurements.

**Limits**

Outside a licensee's frequency band(s) of operation the power of any emission shall be attenuated below the transmitter power (P) by at least  $43 + 10 \log (P)$  dB, resulting in a limit of -13 dBm per 1 MHz RBW.

Complies?	Yes
-----------	-----

Appendix 5

Diagram 1a

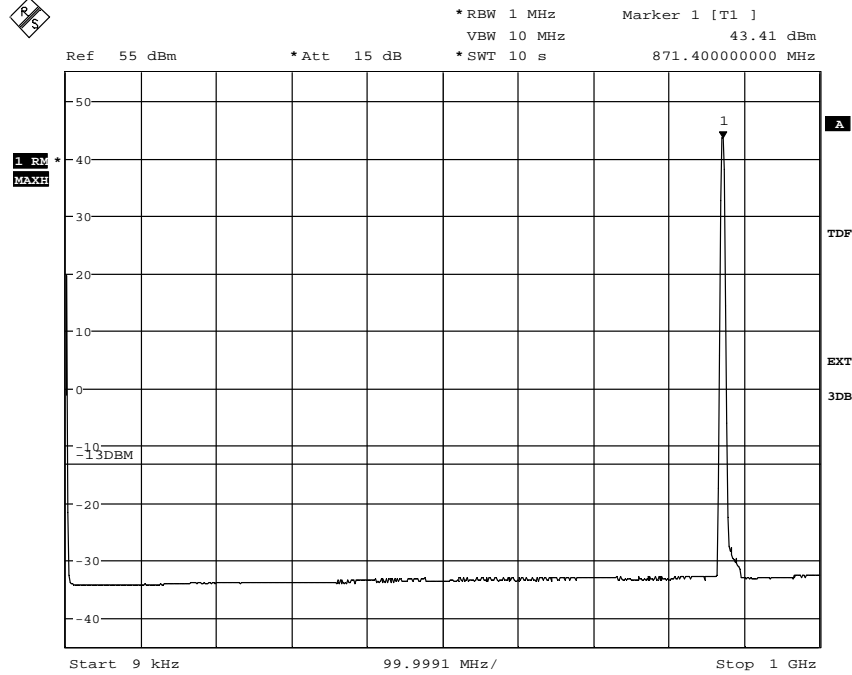

Date: 30.AUG.2011 11:01:14

The emissions around the carrier are within the operating frequency band

Diagram 1b

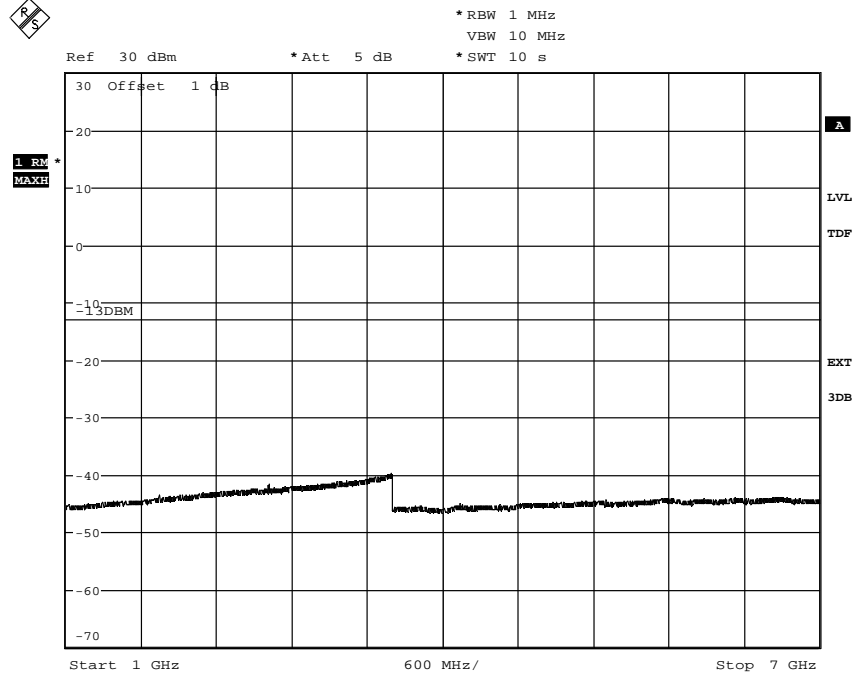

Date: 30.AUG.2011 12:28:04

Appendix 5

Diagram 1c

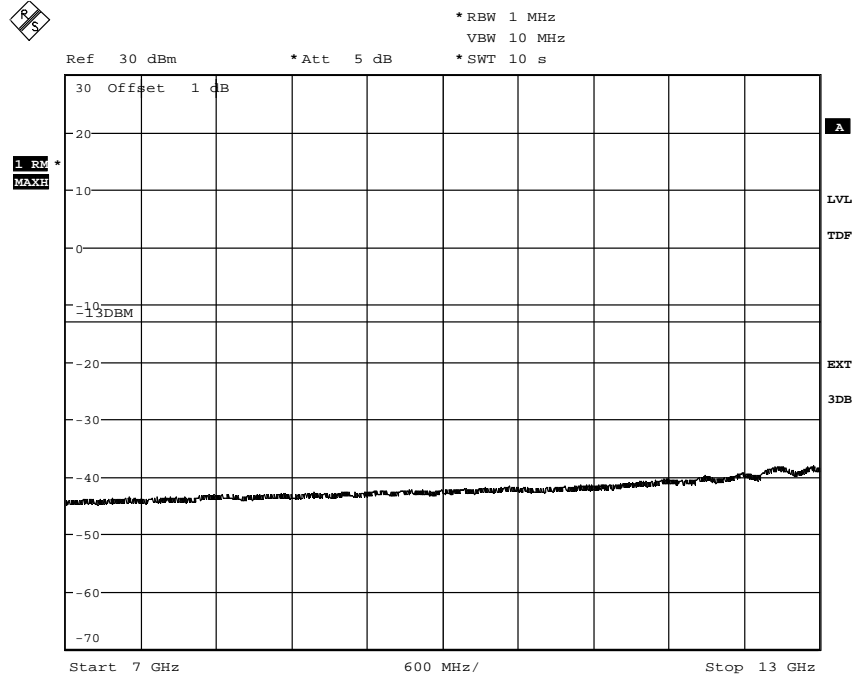

Date: 30.AUG.2011 12:23:01

Diagram 1d

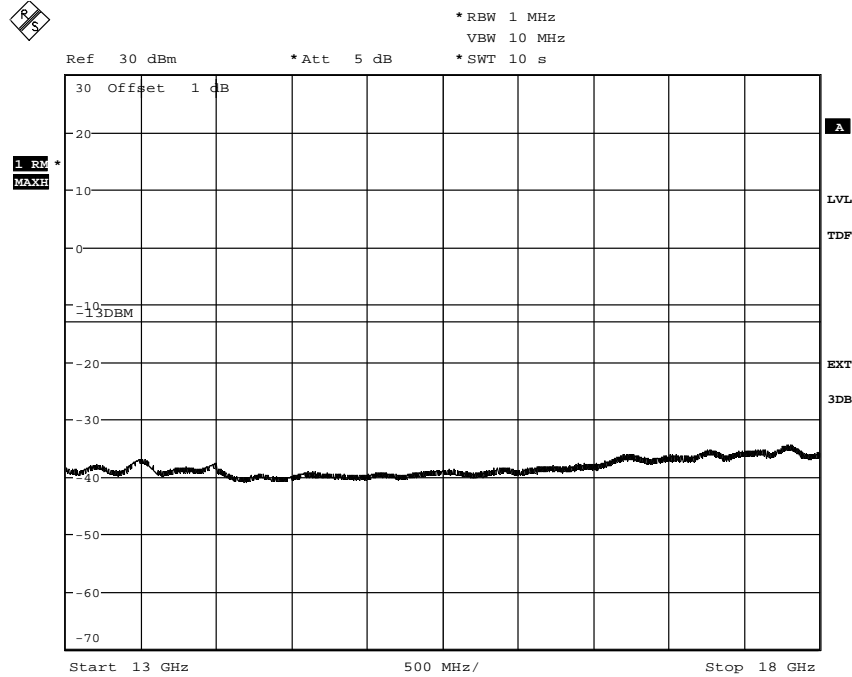

Date: 30.AUG.2011 12:24:11

Appendix 5

Diagram 1e

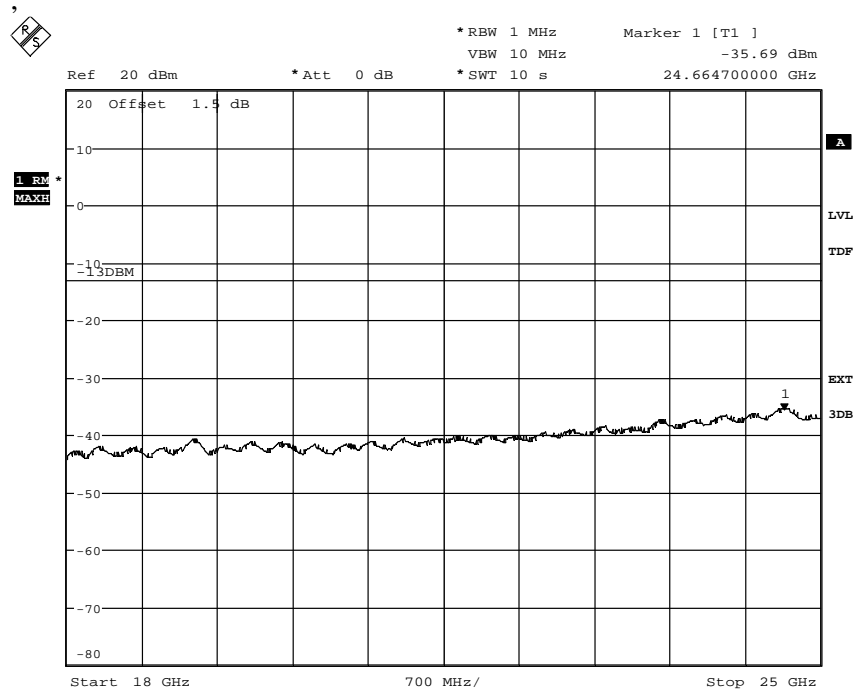

Date: 31.AUG.2011 14:06:20

Appendix 5

Diagram 2a

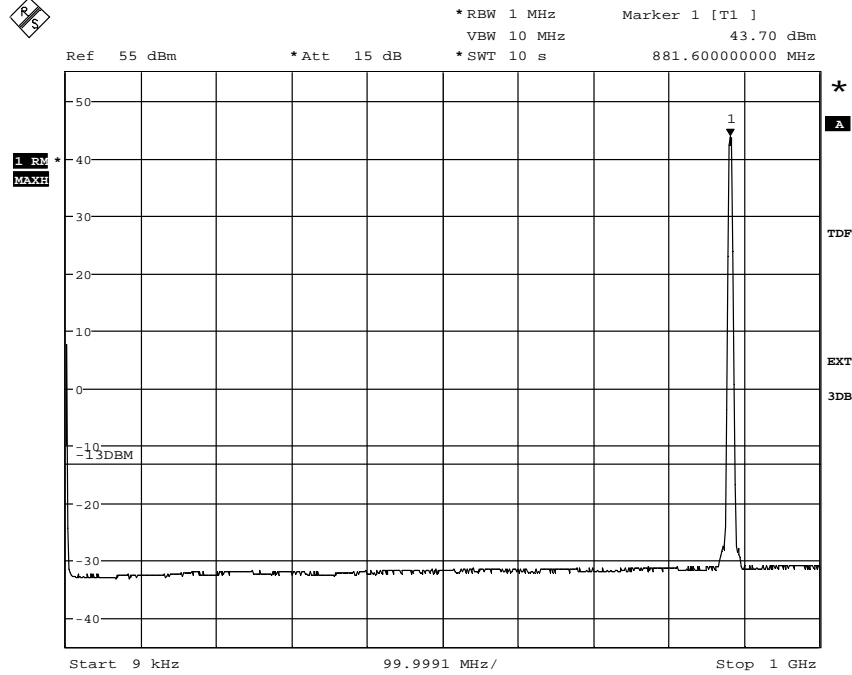

Date: 29.AUG.2011 11:02:48

Diagram 2b

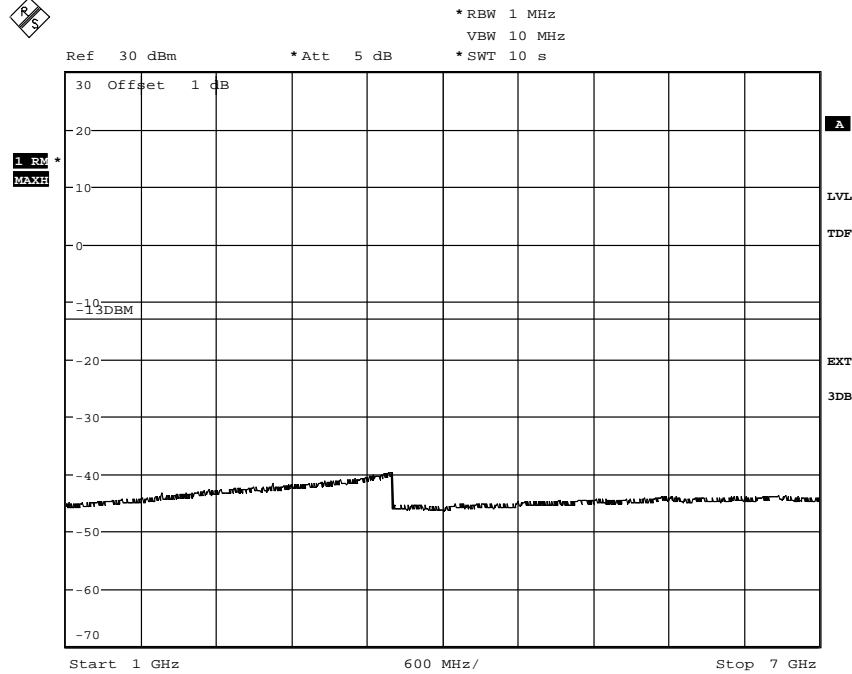

Date: 29.AUG.2011 11:12:36

Appendix 5

Diagram 2c

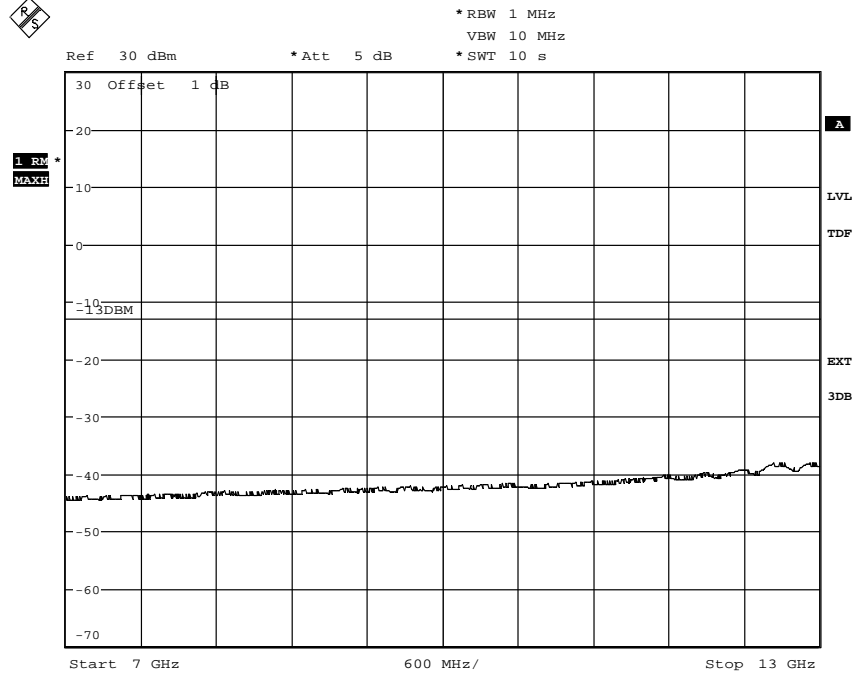

Date: 29.AUG.2011 11:18:11

Diagram 2d

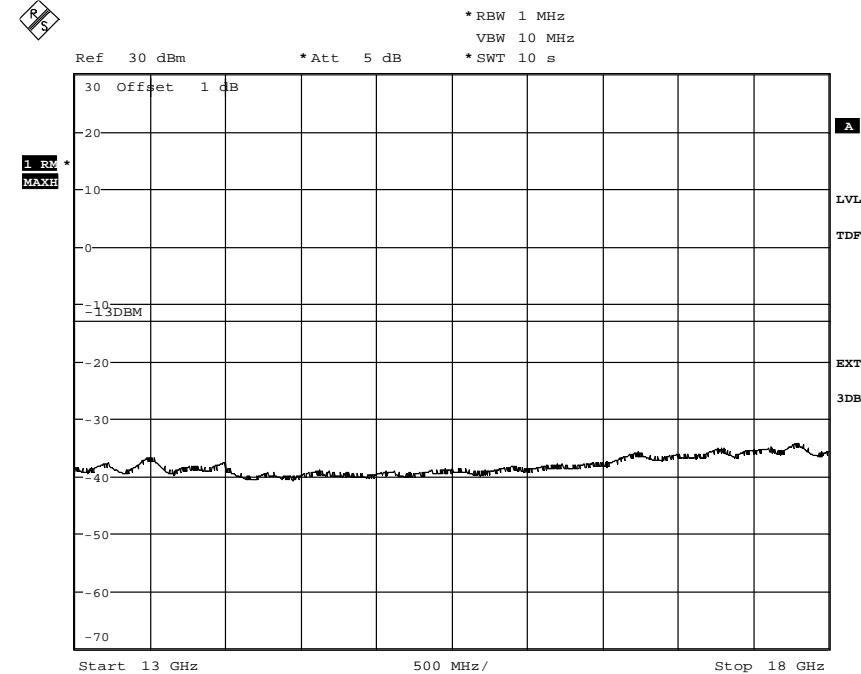

Date: 29.AUG.2011 11:21:08

Appendix 5

Diagram 2e

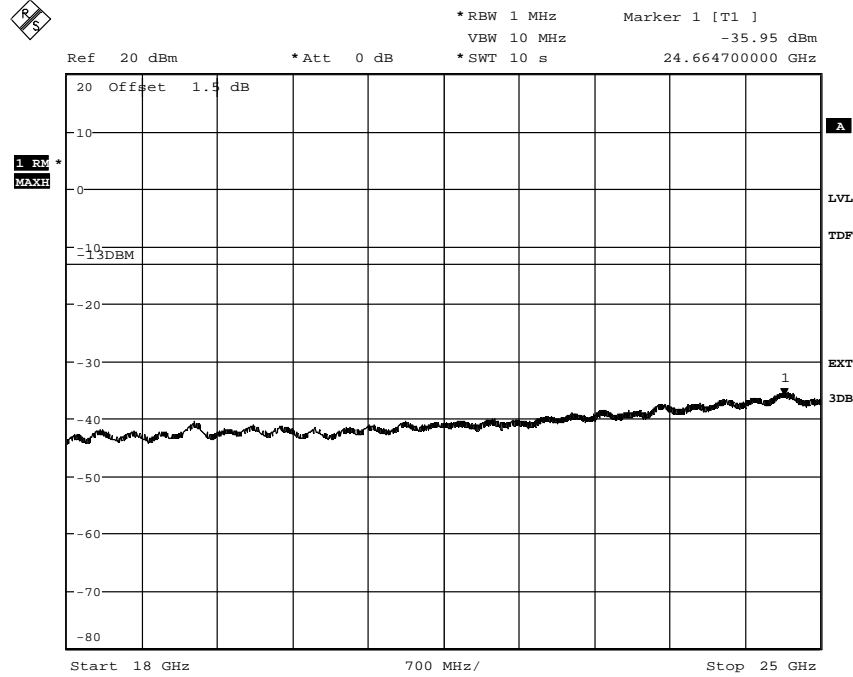

Date: 31.AUG.2011 14:19:31

Appendix 5

Diagram 3a

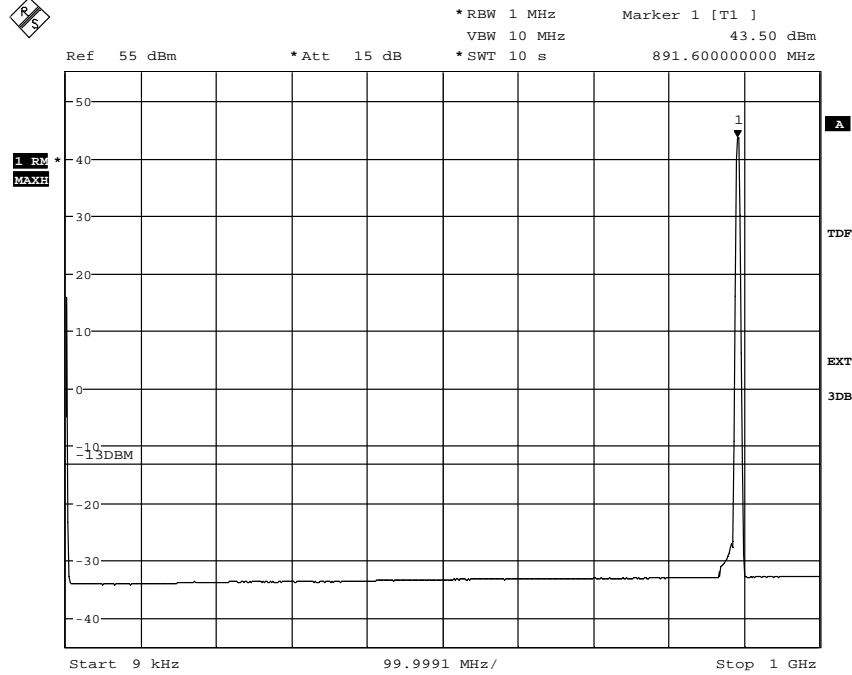

Date: 30.AUG.2011 10:17:26

The emissions around the carrier are within the operating frequency band

Diagram 3b

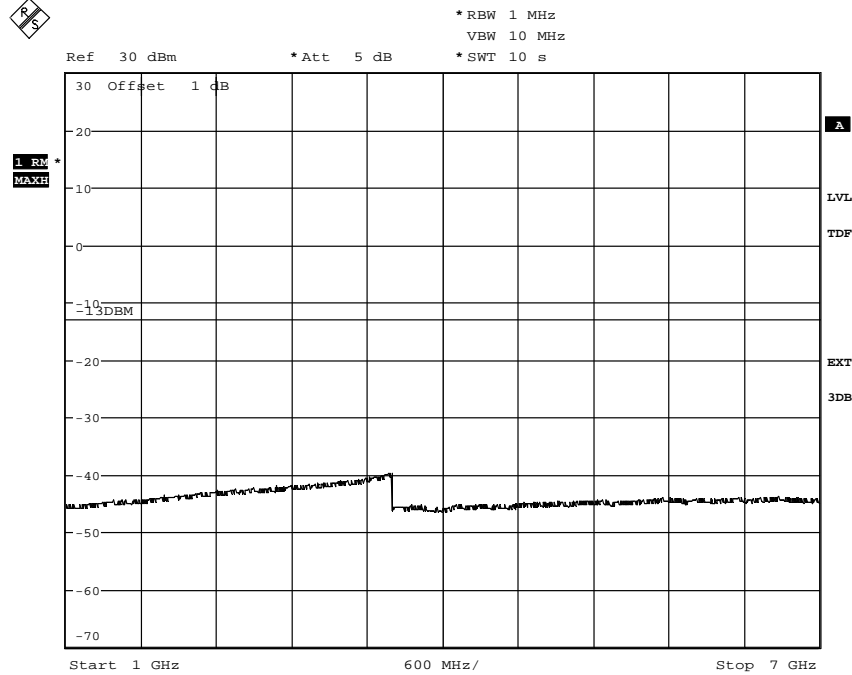

Date: 30.AUG.2011 10:39:59



Appendix 5

Diagram 3c

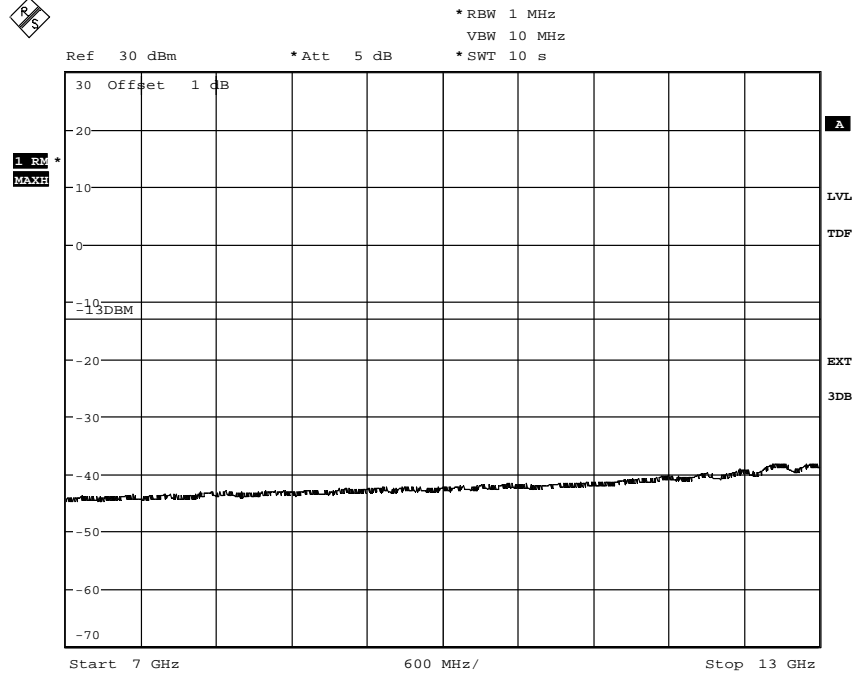

Date: 30.AUG.2011 10:44:53

Diagram 3d

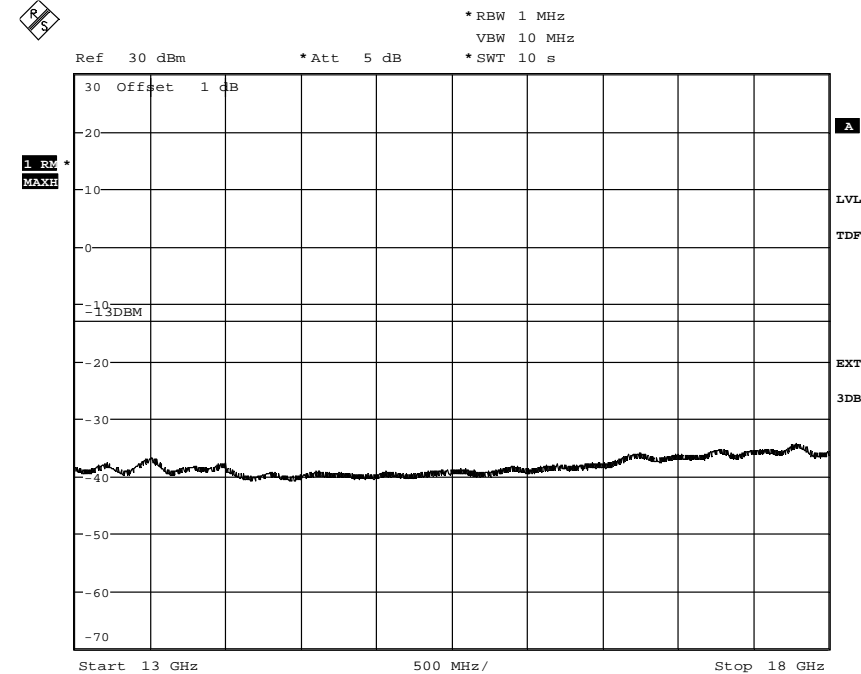

Date: 30.AUG.2011 10:42:14

Appendix 5

Diagram 3e

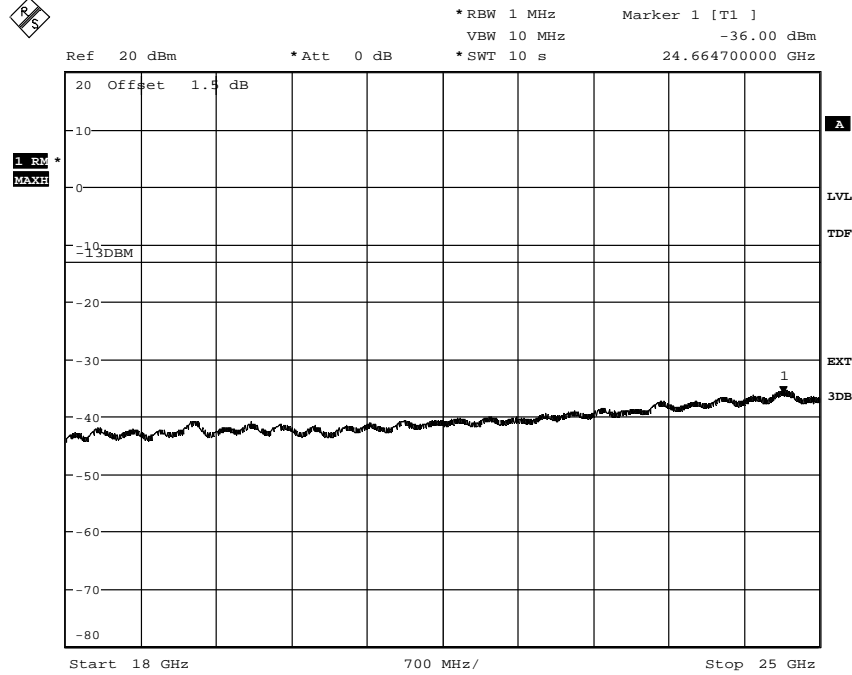

Date: 31.AUG.2011 13:56:17

Appendix 5

Diagram 4a

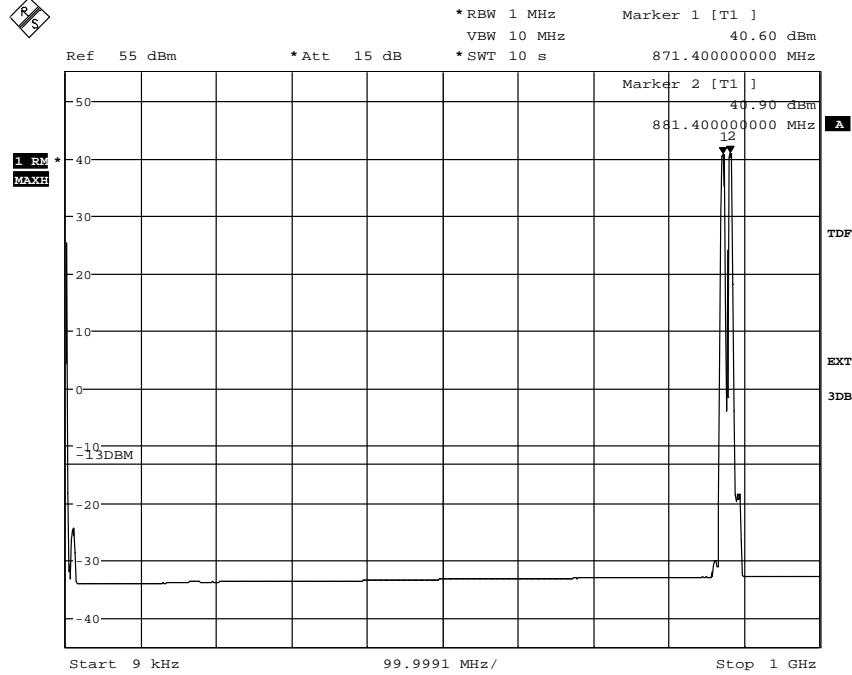

Date: 31.AUG.2011 08:35:19

The emissions around the carriers are within the operating frequency band

Diagram 4b

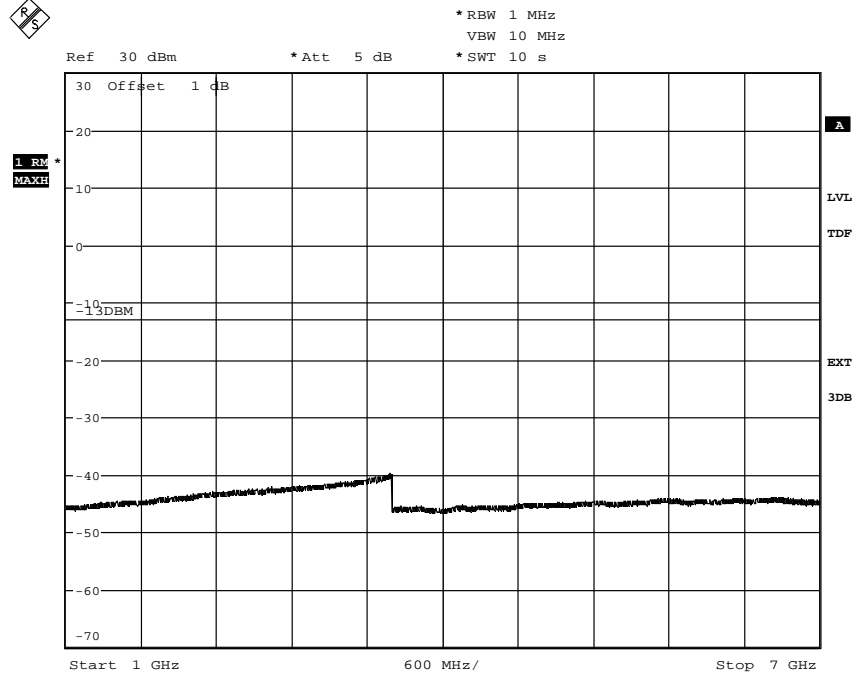

Date: 31.AUG.2011 08:48:21

Appendix 5

Diagram 4c

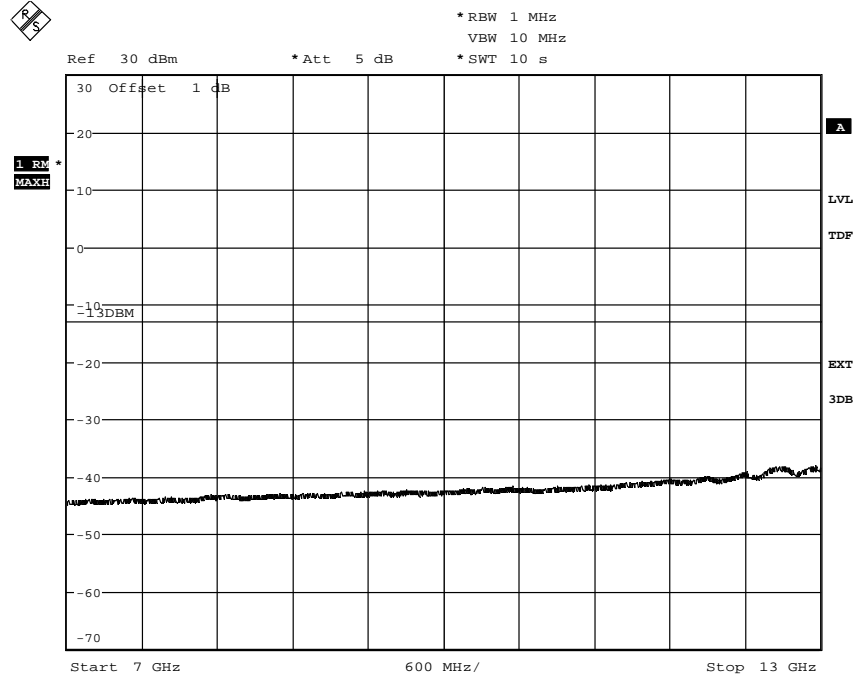

Date: 31.AUG.2011 08:40:46

Diagram 4d

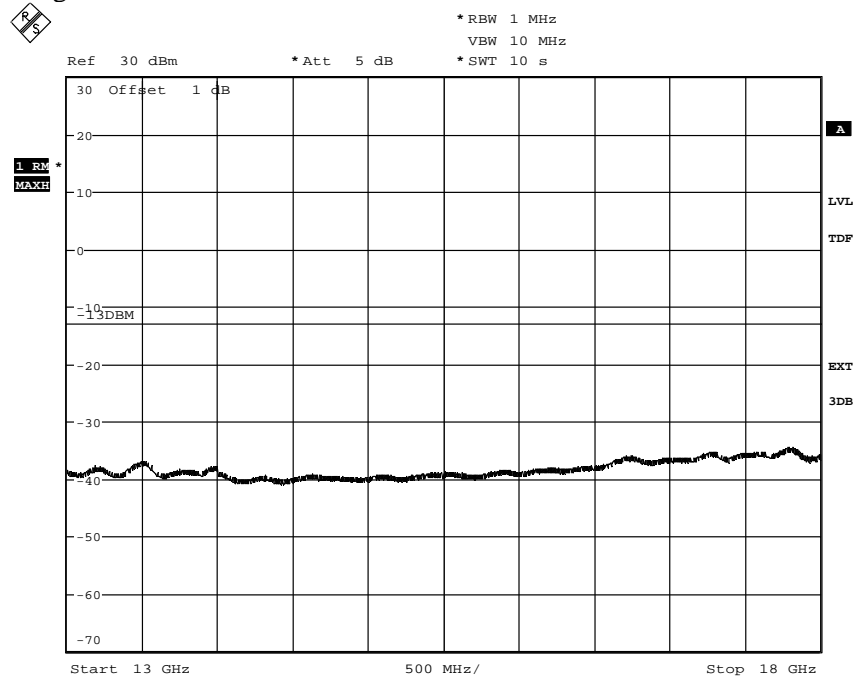

Date: 31.AUG.2011 08:42:03

Appendix 5

Diagram 4e

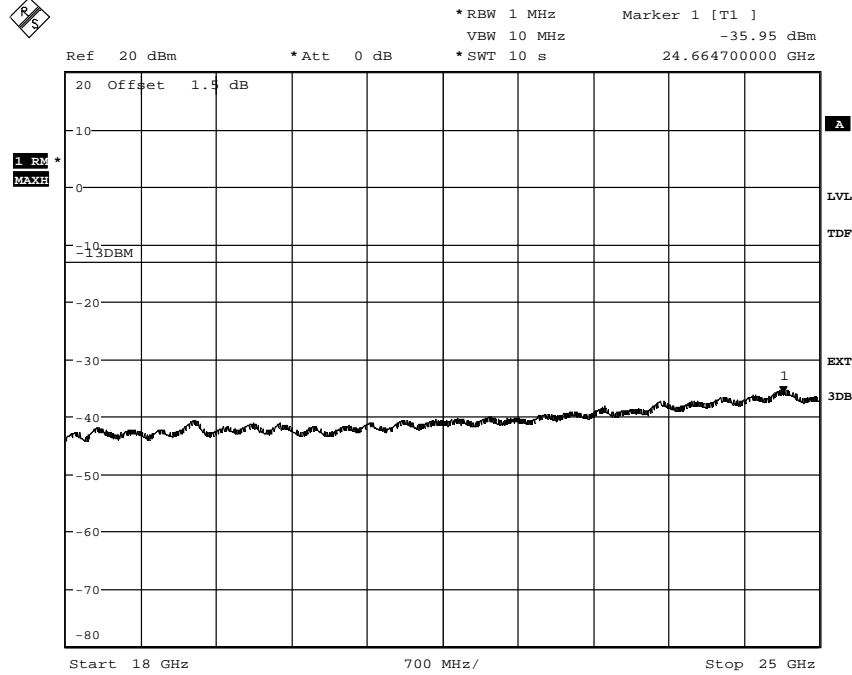

Date: 31.AUG.2011 13:36:49

Appendix 5

Diagram 5a

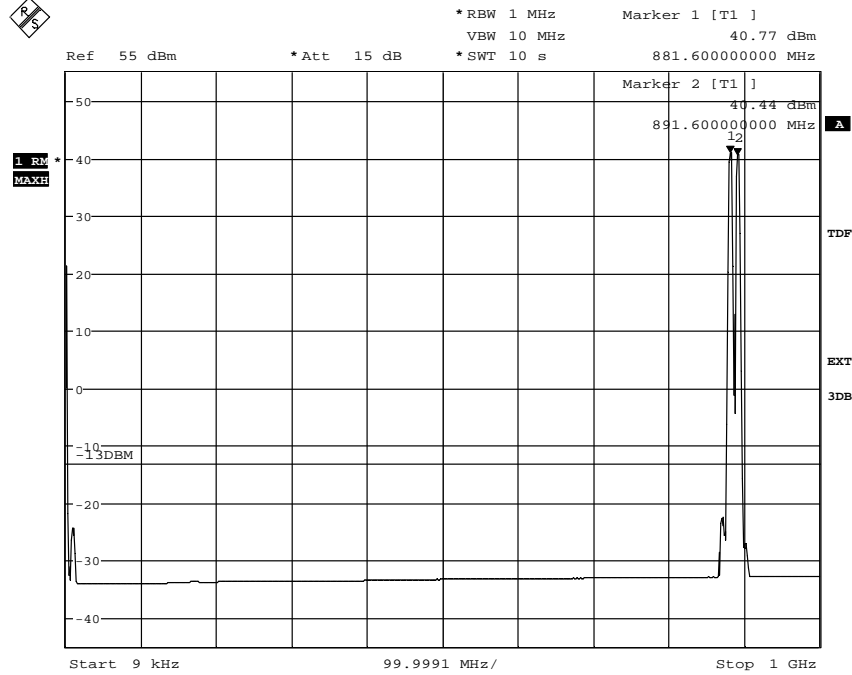

Date: 31.AUG.2011 09:16:19

The emissions around the carriers are within the operating frequency band

Diagram 5b

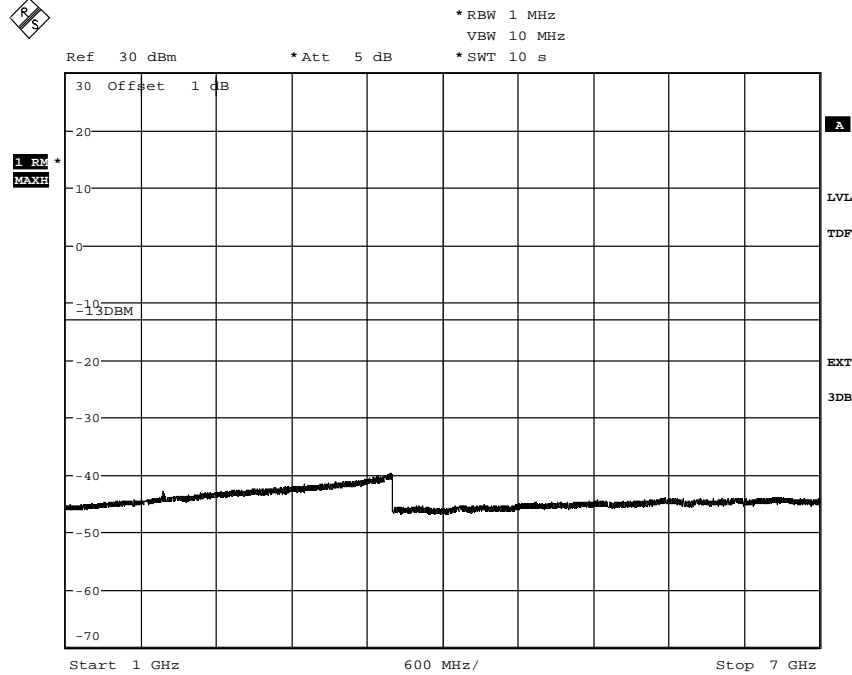

Date: 31.AUG.2011 09:25:40

Appendix 5

Diagram 5c

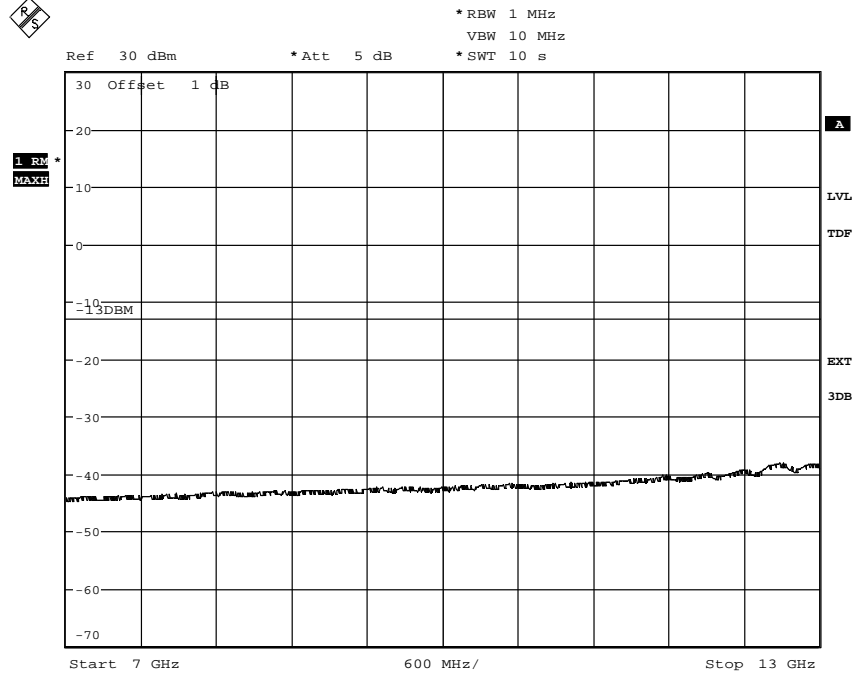

Date: 31.AUG.2011 09:20:36

Diagram 5d

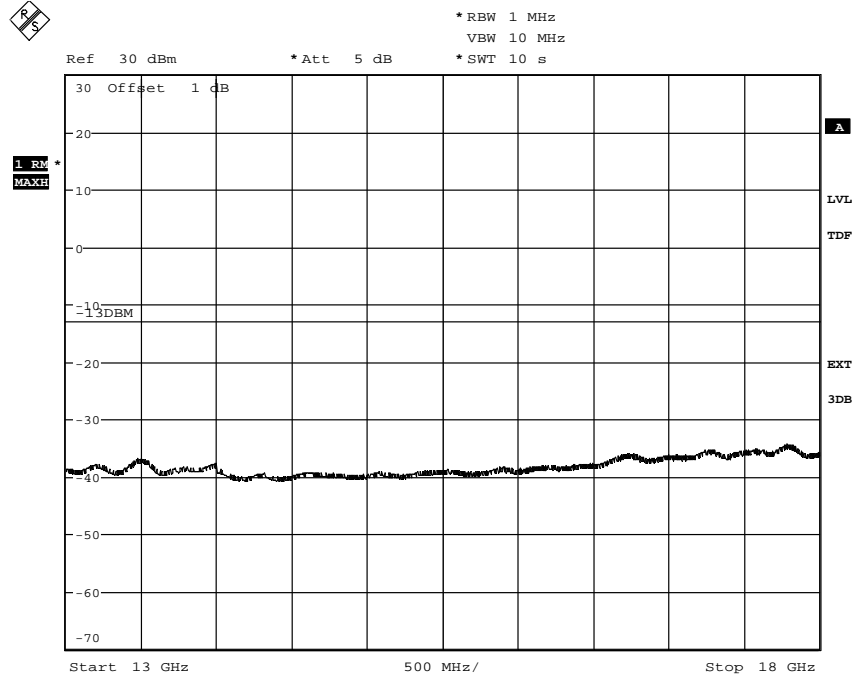

Date: 31.AUG.2011 09:22:38

Appendix 5

Diagram 5e

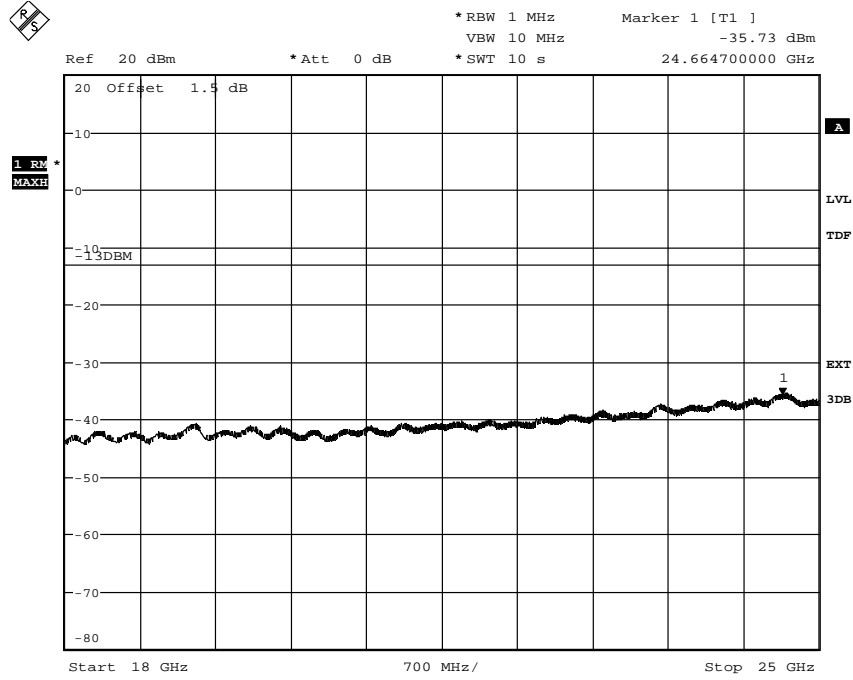

Date: 31.AUG.2011 13:45:41



Appendix 6

**Field strength of spurious radiation measurements according to CFR 47 §22.917 / IC RSS-132 4.5**

Date 2011-08-16 to 2011-08-20	Temperature 22-24 °C ± 3 °C	Humidity 47 % to 60 % ± 5 %
----------------------------------	--------------------------------	--------------------------------

**Test set-up and procedure**

The test sites are listed at FCC, Columbia with registration number: 93866. The test site complies with RSS-Gen, Industry Canada file no. 3482A-1.

The measurements were performed with both horizontal and vertical polarization of the antenna. The antenna distance was 3 m in the frequency range 30 MHz – 18 GHz and 1m in the frequency range 18 - 25 GHz.

In the frequency range 30 MHz - 25 GHz the measurement was performed in power with a RBW of 1 MHz. A propagation loss in free space was calculated. The used formula was

$$\gamma = 20 \log \left( \frac{4\pi D}{\lambda} \right), \gamma \text{ is the propagation loss and } D \text{ is the antenna distance.}$$

The measurement procedure was as the following:

1. The pre-measurement was first performed with peak detector. The EUT was measured in eight directions and with the antenna at three heights, 1.0 m, 1.5 m and 2.0 m.
2. Spurious radiation on frequencies closer than 20 dB to the limit in the pre-measurement is scanned 0-360 degrees and the antenna is scanned 1- 4 m for maximum response. The emission is then measured with the RMS detector and the RMS value is reported. Frequencies closer than 10 dB to the limit when measured with the RMS detector were measured with the substitution method according to the standard.

The test set-up during the spurious radiation measurements is shown in the picture below:

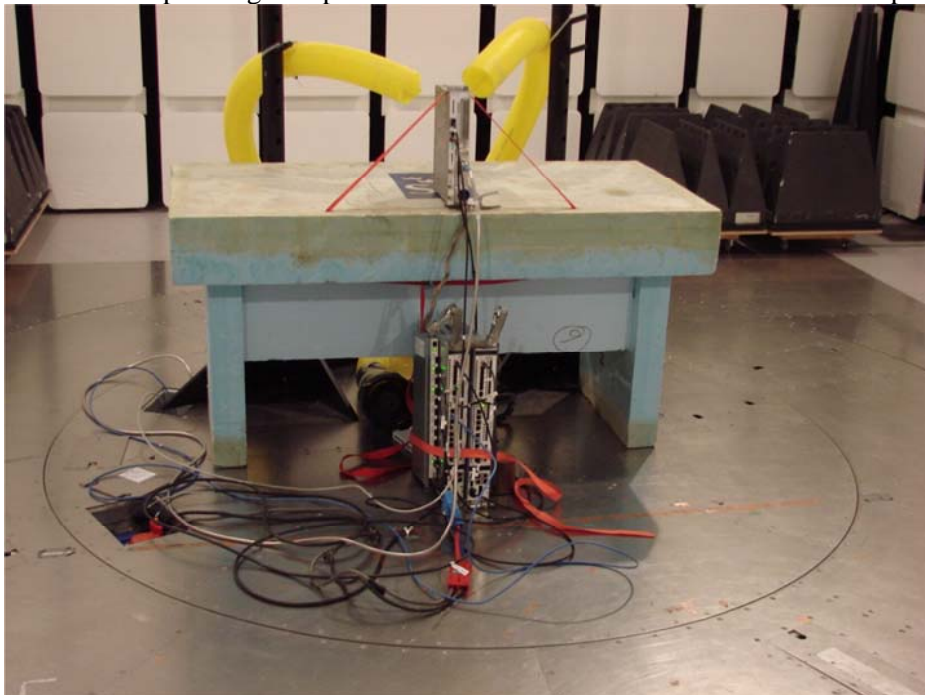

Appendix 6

**Measurement equipment**

Measurement equipment	SP number
Test site Tesla	503 881
R&S ESI 26	503 292
Control computer	503 479
Software: R&S EMC32, ver. 8.20.1	503 745
Chase Bilog antenna CBL 6111A	503 182
µCorp Nordic, Low Noise Amplifier	504 160
Miteq, Low Noise Amplifier	503 285
EMCO Horn Antenna 3115	502 175
Standard gain antenna 20240-20	503 674
High pass filter, Wainright	504 200
High pass filter, RLC Electronics	503 739
Testo 625 temperature and humidity meter	504 188

**Results**

Frequency (MHz)	Spurious emission level (dBm)	
	Vertical	Horizontal
30-25 000	All emission > 20 dB below limit	All emission > 20 dB below limit

**Measurement uncertainty:**

3.2 dB up to 18 GHz, 3.6 dB above 18 GHz

**Limits**

§22.917 and RSS-132 6.5

The power of any emission outside the frequency band shall be attenuated below the transmitter power (P) by at least  $43 + 10 \log P$  dB.

Complies?	Yes
-----------	-----

Appendix 7

**Frequency stability measurements according to CFR 47 §22.355 / IC RSS 132 4.5**

Date 2011-09-02 to 2011-09-04	Temperature (test equipment) 22-24°C ± 3 °C	Humidity (test equipment) 41-52% ± 5 %
----------------------------------	--	---

**Test set-up and procedure**

The measurement was made per 3GPP TS 25.141. The output was connected to a spectrum analyzer. The spectrum analyzer was connected to an external 10 MHz reference standard during the measurements.

Measurement equipment	SP number
Rohde & Schwarz signal analyzer FSQ40	504 143
RF attenuator	504 159
Testo 635, Temperature and humidity meter	504 203
Temperature cabinet	503 360
Multimeter Fluke 87	502 190

**Results**

Nominal Voltage -48 V DC

Maximum output power at mid channel (M)

Test conditions		Frequency error (Hz)
Supply voltage DC (V)	T (°C)	
-48.0	+20	-3
-55.2	+20	+4
-40.8	+20	+4
-48.0	+30	+5
-48.0	+40	-4
-48.0	+50	-5
-48.0	+10	+5
-48.0	0	-4
-48.0	-10	-7
-48.0	-20	-4
-48.0	-30	+3
Maximum freq. error (Hz)		7
Measurement uncertainty		< ± 1 x 10 <sup>-7</sup>

## Appendix 7

### Limits

#### § 22.355 Frequency tolerance

The carrier frequency of each transmitter in the Public Mobile Services must be maintained within the tolerances of  $\pm 1.5$  ppm for base stations.

#### RSS-132, 4.3 Frequency stability

The carrier frequency shall not depart from the reference frequency in excess of  $\pm 1.5$  ppm for base stations

Complies?	Yes
-----------	-----

Appendix 8

**Receiver spurious emissions measurements according to §15.111 / IC RSS-Gen 6.2**

Date 2011-09-16	Temperature 23 °C ± 3 °C	Humidity 45 % ± 5 %
--------------------	-----------------------------	------------------------

**Test set-up and procedure**

The measurements were performed according to ANSI C63.4.

Measurements were performed on the receiver antenna terminal (RF B). In the frequency range 9 kHz-1000 MHz the measurement is first performed with peak detector. Emission on frequencies close to or above the limit is re-measured with quasi-peak detector. The RMS detector was used in the frequency range 1-12.5 GHz.

Measurement equipment	SP number
R&S FSQ40	504 143
RF attenuator (RF A)	900 229
Testo 635, Temperature and humidity meter	504 203

**Result**

	Channel
Diagram 1a-c	B
Diagram 2a-c	M
Diagram 3a-c	T

A frequency component at 482.15 kHz was measured to -57.5 dBm with Quasi-peak detector activated.

Note: During the measurement on the RX port RF B the combined TX/RX port RF A was terminated into 50 ohm, the TX was active in single carrier mode transmitting TM1.

**Remark**

The highest internal frequency as declared by the client was 2.4576 GHz, thus the choice of the upper frequency boundary was set to 5x2.5 GHz = 12.5 GHz for emission measurements.

**Limit**

§15.111 Antenna power conduction limits for receivers

The power at the antenna terminal at any frequency within the range of measurements specified in §15.33 shall not exceed 2.0 nanowatts (-57 dBm).

RSS-Gen 6.2 Antenna Conducted limits

Receiver spurious emissions at any discrete frequency shall not exceed 2 nanowatts (-57 dBm) in the band 30-1000 MHz, and 5 nanowatts (-53 dBm) above 1000 MHz.

Emission below limit?	Yes
-----------------------	-----

Appendix 8

Diagram 1a

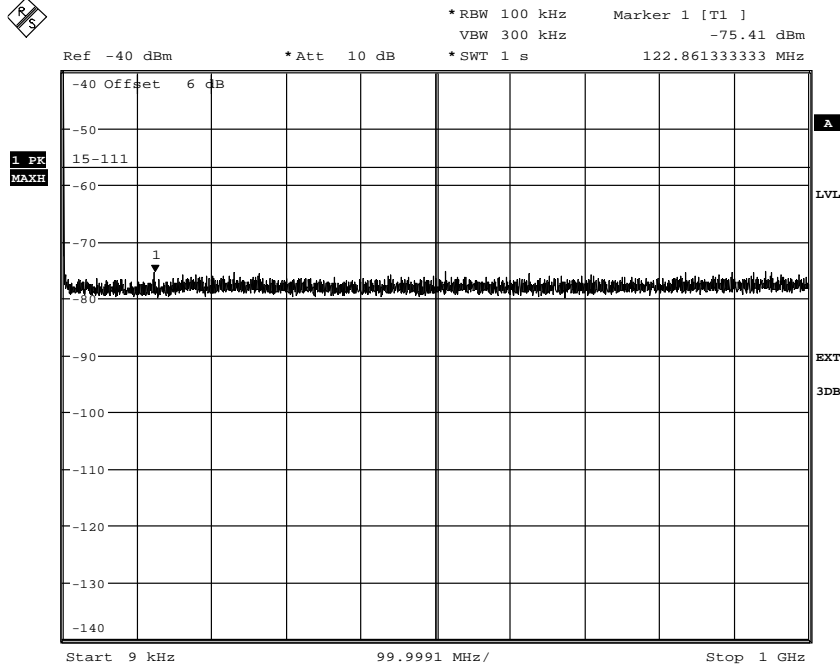

Date: 16.SEP.2011 10:26:17

Diagram 1b

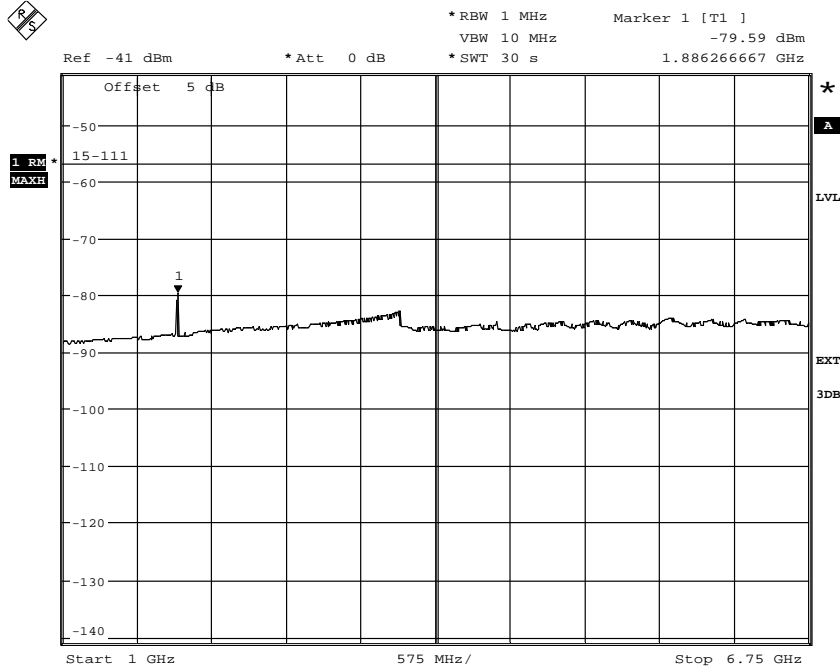

Date: 16.SEP.2011 11:08:42

Appendix 8

Diagram 1c

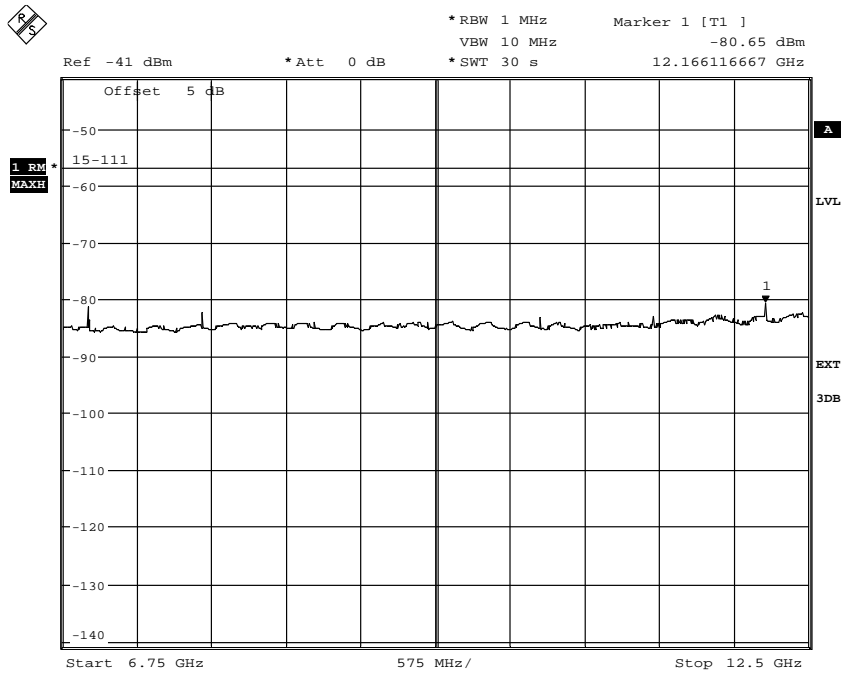

Date: 16.SEP.2011 11:10:38

Appendix 8

Diagram 2a

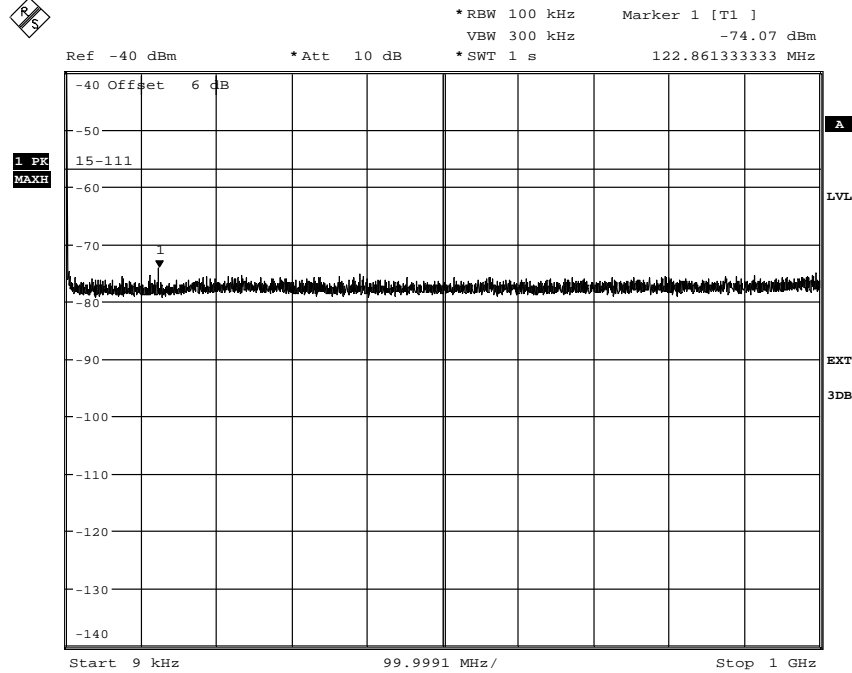

Date: 16.SEP.2011 10:16:24

Diagram 2b

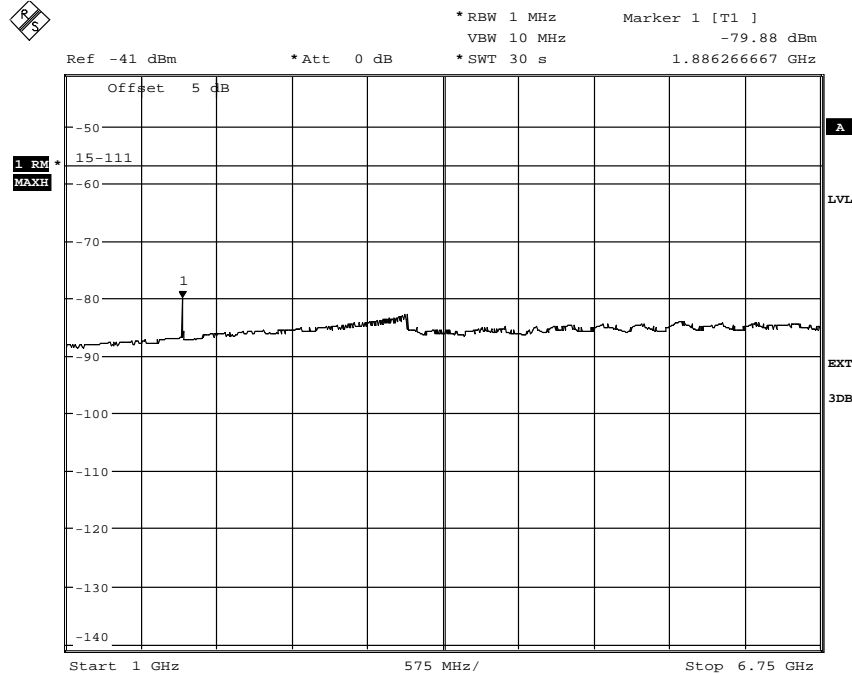

Date: 16.SEP.2011 10:54:53



Appendix 8

Diagram 2c

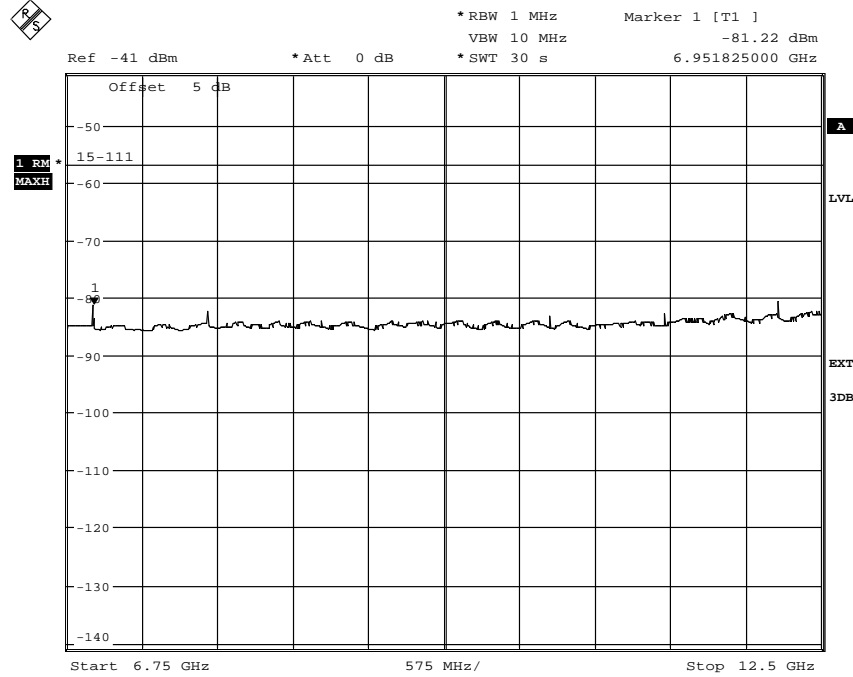

Date: 16.SEP.2011 10:53:40

Appendix 8

Diagram 3a

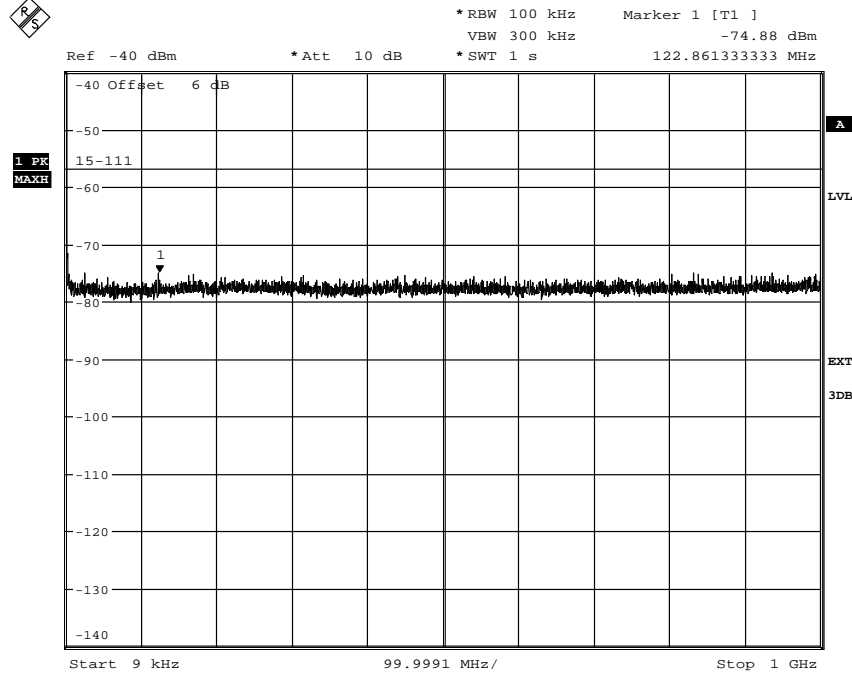

Date: 16.SEP.2011 10:35:32

Diagram 3b

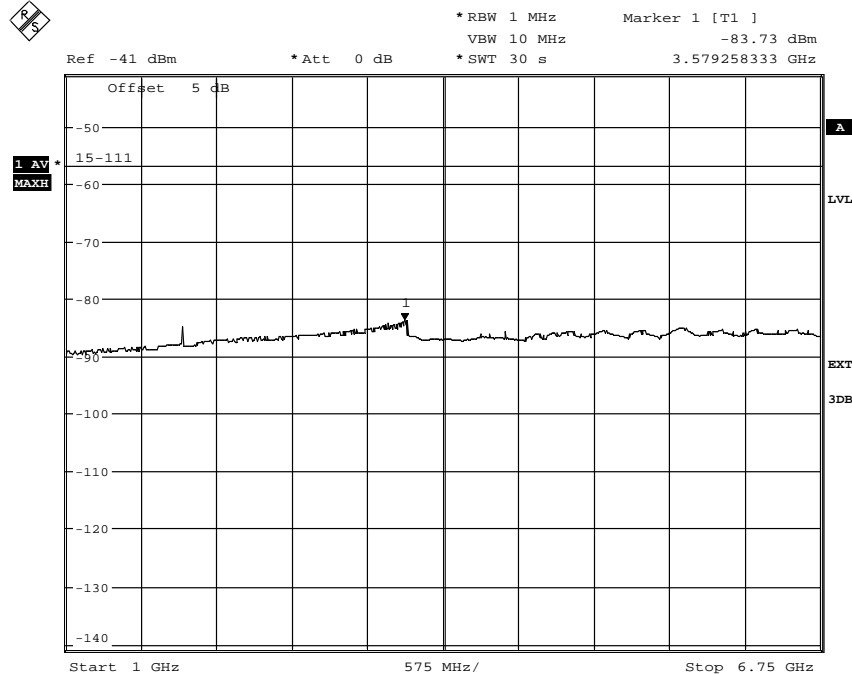

Date: 16.SEP.2011 10:43:01

Appendix 8

Diagram 3c

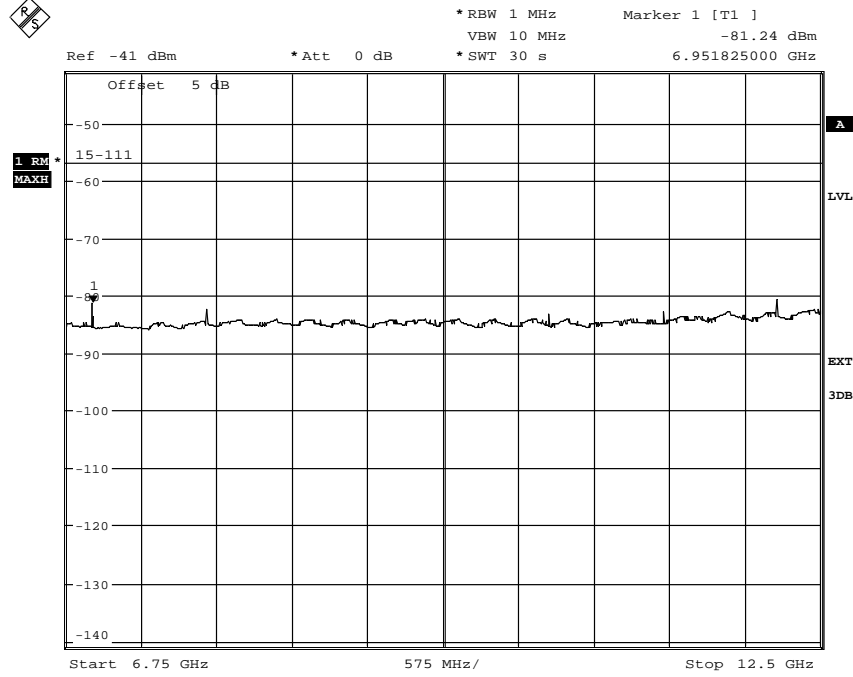

Date: 16.SEP.2011 10:44:39

Appendix 9

External photos

Photos show the sample used for conducted measurements

Front side



Rear side



Appendix 9

Left side

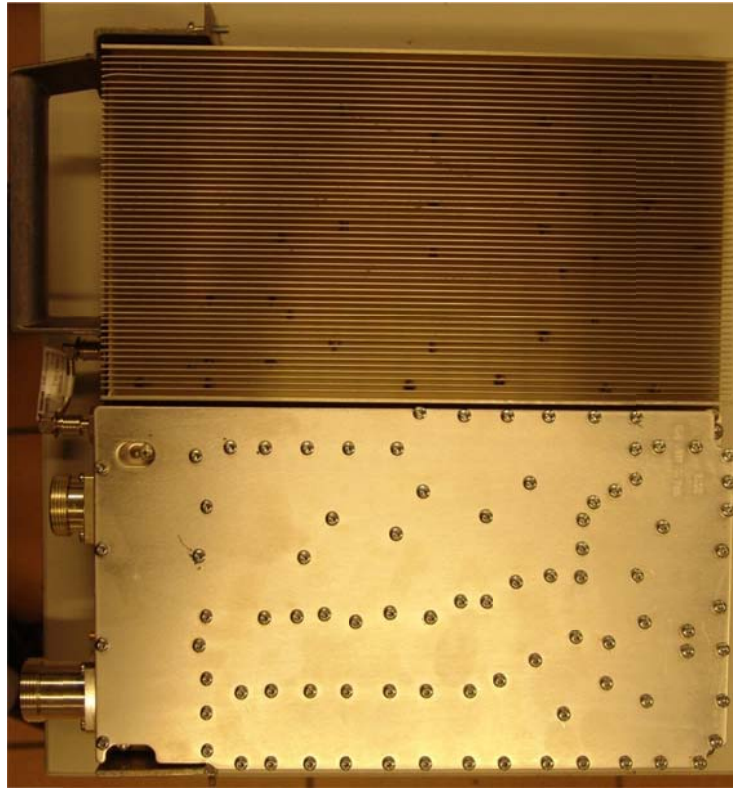

Right side

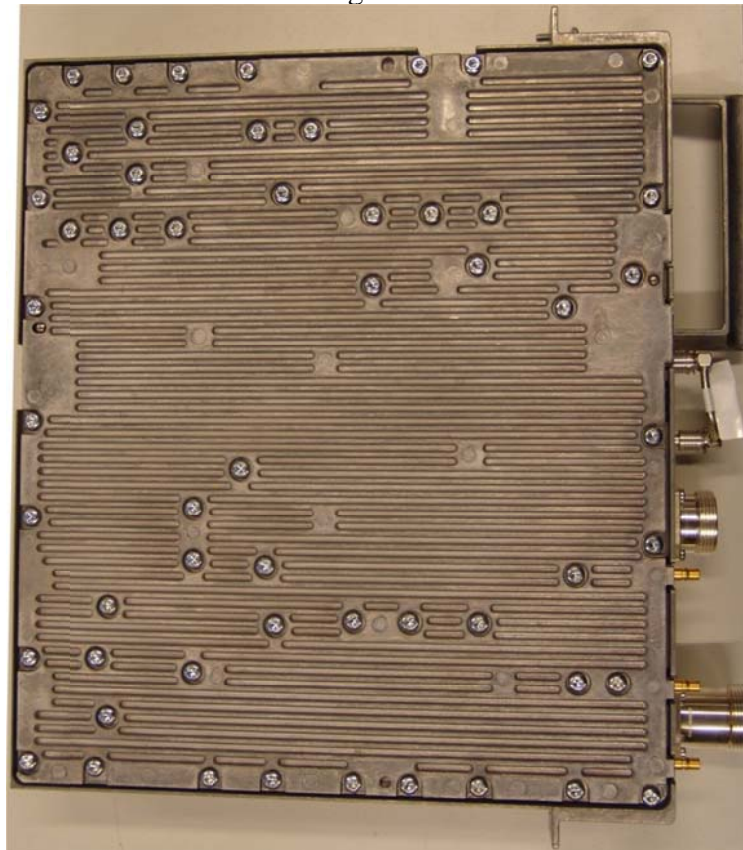

Appendix 9

Bottom side



Top side

