



# REPORT

issued by an FCC listed Laboratory Reg. no. 93866.  
The test sites comply with RSS-Gen, IC file no: 3482A

Date 2011-01-26 Reference FX022685-F22 Page 1 (2)



Handled by, department  
Reinhold Reul  
Electronics  
+46 10 516 55 84, reinhold.reul@sp.se

Ericsson AB  
Anders Johansson  
PDU Radio Base Stations  
164 80 Stockholm

## Class II permissive change measurements on RUS 01 B5 radio equipment with FCC ID: TA8AKRC11864-2 and IC: 287AB-AS118642

(9 appendices)

### Test object

RUS 01 B5, product KRC 118 64/2, revision R1C

### Summary

Appendix 1 describes the test object and set-ups during test.  
Appendix 9 presents photos of the test object.

Standard	Compliant	Appendix
<b>FCC CFR 47 / Industry Canada RSS-132</b>		
2.1046 / RSS-132 4.4 RF power output	Yes	2
2.1049 / RSS-Gen 4.6.1 Occupied bandwidth	Yes	3
2.1051 / RSS-132 4.5 Band edge	Yes	4
2.1051 / RSS-132 4.5 Spurious emission at antenna terminals	Yes	5
2.1053 / RSS-132 4.5 Field strength of spurious radiation	Yes	6
2.1055 / RSS-132 4.3 Frequency stability	Yes	7
<b>FCC CFR 47 / Industry Canada RSS-132</b>		
15.111 / RSS-132 4.6 Receiver spurious emissions	Yes	8

Note: Above RSS-132 items are given as cross-reference only. Measurements were performed according to ANSI procedures referenced by FCC and covered by SP's accreditation.

### SP Sveriges Tekniska Forskningsinstitut Electronics - EMC

Reinhold Reul  
Technical Officer

Jan Carlsson  
Deputy Technical Manager

### SP Technical Research Institute of Sweden

Postal address  
SP  
Box 857  
SE-501 15 Borås  
SWEDEN

Office location  
Västeråsen  
Brinellgatan 4  
SE-504 62 Borås  
SWEDEN

Phone / Fax / E-mail  
+46 10 516 50 00  
+46 33 13 55 02  
info@sp.se

Laboratories are accredited by the Swedish Board for Accreditation and Conformity Assessment (SWEDAC) under the terms of Swedish legislation. This report may not be reproduced other than in full, except with the prior written approval of the issuing laboratory.



FCC ID: TA8AKRC11864-2  
IC: 287AB-AS118642

**Table of contents**

Description of the test object	Appendix 1
Operation modes and test set-ups during measurements	Appendix 1
Purpose of test	Appendix 1
References	Appendix 1
Measurement equipment	Appendix 1
RF power output	Appendix 2
Occupied bandwidth	Appendix 3
Band edge	Appendix 4
Spurious emission at antenna terminals	Appendix 5
Field strength of spurious radiation	Appendix 6
Frequency stability	Appendix 7
Receiver spurious emissions	Appendix 8
External photos of the test object	Appendix 9

FCC ID: TA8AKRC11864-2  
IC: 287AB-AS118642

Appendix 1

**Description of the test object**

Equipment:	Radio equipment RUS 01 B5 running in LTE-mode (with comparative complementary tests in WCDMA and GSM mode as motivated in the test purpose section below )		
Frequency bands:	TX: 869 - 894 MHz RX: 824 – 849 MHz Highest and lowest EARFCN per supported channel BW configuration and corresponding frequencies are listed below.		
Supported channel bandwidth configurations	1.4 MHz, 3 MHz, 5 MHz, 10 MHz, 15 MHz and 20 MHz		
Modulation and access scheme	OFDMA in FDD		
OFDM subcarrier modulation	System information and pilots use BPSK and QPSK. For payload data QPSK, 16QAM and 64QAM can be used.		
Maximum rated output power:	Single carrier 1x 47.8 dBm (1x60 W)		
Number of antenna ports:	TX/RX: 1	RX only: 1	
Nominal supply voltage:	-48 VDC		

**Tested EARFCN settings and frequencies per LTE channel BW configuration**

EARFCN settings		Frequency [MHz]		BW configuration
DL	UL	DL	UL	
2407	20407	869.7	824.7	1.4 MHz, bottom (B) frequency
2415	20415	870.5	825.5	3 MHz, bottom (B) frequency
2425	20425	871.5	826.5	5 MHz, bottom (B) frequency
2450	20450	874.0	829.0	10 MHz, bottom (B) frequency
2475	20475	876.5	831.5	15 MHz, bottom (B) frequency
2500	20500	879.0	834.0	20 MHz, bottom (B) frequency
2525	20525	881.5	836.5	all BW, mid (M) frequency
2550	20550	884.0	839.0	20 MHz, top (T) frequency
2575	20575	886.5	841.5	15 MHz, top (T) frequency
2600	20600	889.0	844.0	10 MHz, top (T) frequency
2625	20625	891.5	846.5	5 MHz, top (T) frequency
2635	20635	892.5	847.5	3 MHz, top (T) frequency
2643	20643	893.3	848.3	1.4 MHz, top (T) frequency

Note: EARFCN are derived according 3GPP TS 36.141, table 5.7.3-1.

FCC ID: TA8AKRC11864-2  
IC: 287AB-AS118642

Appendix 1

**Operation modes and test set-ups during measurements**

Measurements were performed with the test object transmitting test models as defined in 3GPP TS 36.141. Test model E-TM1.1 was used to represent QPSK, test model E-TM3.2 to represent 16QAM and test model E-TM3.1 to represent 64QAM payload modulation.

The setting TX single carrier with test model E-TM1.1 in channel bandwidth configuration 1.4 MHz was found to be representative for all traffic scenarios when several settings with different modulations and channel bandwidth configurations were compared to find a worst case setting. This setting was used for all measurements unless noted otherwise.

The test object was powered with -48 VDC and measurements were performed with the test object configured for maximum transmit power, unless noted otherwise.

**Conducted measurements**

The EUT was mounted into a RBS 6201 cabinet and supplied by the cabinet's internal -48 V DC. TX parameters were measured at port RF A with port RF B unterminated. RX spurious emission conducted was measured at port RF B with port RF A activated at maximum nominal output power with E-TM1.1 in channel BW configuration 1.4 MHz and terminated via an RF attenuator into 50 ohm.

**Radiated measurements**

The test object was tested stand-alone and supplied with -48 VDC from functional test equipment. The active port RF A was terminated into 50 ohm outside the test chamber. Port RF B was unterminated.

**Purpose of test**

The purpose of the tests is a class II permissive change verification of maintained compliance to the performance characteristics specified in applicable parts of FCC CFR 47 and IC RSS-132. The changes comprise addition of a new RAT, LTE mode, and a product revision update to version R1C due to minor HW changes as described in the client documentation. The preceding hardware revision had been filed with RATs WCDMA and GSM earlier. Additional to the results presented in this report for LTE mode limited complementary verification measurements in GSM and WCDMA mode were performed and showed maintained compliance with hardware version R1C. Thus it was deemed sufficient to present only the results for the new LTE mode in this report.

**References**

Measurements were done according to relevant parts of the following standards:

ANSI C63.4-2003

ANSI/TIA/EIA-603-B-2002

3GPP TS 36.141, version 8.5.0

CFR 47 part 2, October 1<sup>st</sup>, 2010

CFR 47 part 24, October 1<sup>st</sup>, 2010

RSS-132 Issue 2

RSS-Gen Issue 3

FCC ID: TA8AKRC11864-2  
IC: 287AB-AS118642

Appendix 1

**Measurement equipment**

Measurement equipment	Calibration Due	SP number
Test site Tesla	2013-12	503 881
Rohde & Schwarz FSIQ 40	2011-07	503 738
Rohde & Schwarz FSQ 40	2011-07	504 143
Rohde & Schwarz ESI 26	2011-07	503 292
Control computer with Rohde & Schwarz software EMC32 version 8.20.1	-	503 479
High pass filter 3 GHz	2011-07	503 739
High pass filter 3 GHz	2011-03	504 200
RF attenuator 40 dB	2011-06	504 159
RF attenuator 30 dB	2011-08	900 233
Boonton RF Peak power meter/analyzer	2011-10	503 144
Boonton Power sensor 56518-S/4	2012-02	503 145
Chase Bilog antenna CBL 6111A	2011-10	503 182
EMCO Horn Antenna 3115	2014-01	502 175
Std.gain horn mod 20240-20	-	503 674
Std.gain horn	-	503 900
MITEQ Low Noise Amplifier	2011-06	503 285
µComp Nordic, Low Noise Amplifier	2011-07	504 160
High pass filter 1-15 GHz	2011-07	502 758
High pass filter 3-18 GHz	2011-07	504 200
High pass filter 18-27 GHz	2011-07	503 740
High pass filter 3-18 GHz	2011-07	503 739
Climate chamber 2	2013-11	501 031
Multimeter Fluke 87	2011-03	502 190
Testo 635 temperature and humidity meter	2011-03	504 203
Testo 625 temperature and humidity meter	2011-08	504 188
Testo 615 temperature and humidity meter	2012-04	503 498

**Uncertainties**

Measurement and test instrument uncertainties are described in the quality assurance documentation "SP-QD 10885". The uncertainties are calculated with a coverage factor k=2 (95% level of confidence).

**Reservation**

The test results in this report apply only to the particular test objects as declared in the report.

**Delivery of test object**

The test objects were delivered: 2011-01-10.

**Manufacturer's representative**

Anders Johansson, Ericsson AB

**Test engineers**

Jörgen Wassholm, Andreas Johnson, Tomas Lennhager, Jonas Bremholt and Reinhold Reul

FCC ID: TA8AKRC11864-2  
IC: 287AB-AS118642

Appendix 1

**Test set-up conducted TX measurements at port RF A**

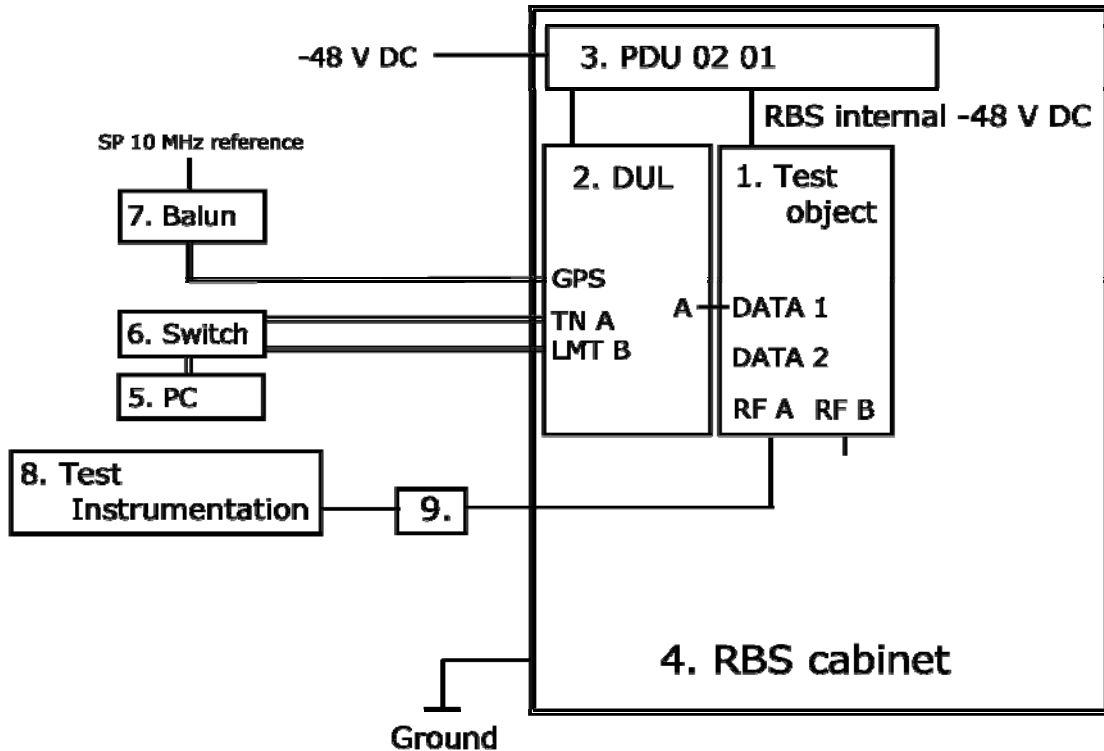

**Test object**

1. RUS 01 B5, product KRC 118 64/2, revision R1C, SN(S)C823990677  
FCC ID: TA8AKRC11864-2 and IC: 287AB-AS118642

**Functional test equipment**

2. DUL 20 01, product KDU 137 533/4, revision R1B, SN C823884475
3. PDU 02 01, product BMG 980 336/4, revision R2A, SN BJ31528316
4. RBS 6201 cabinet, BAMS 1000778792
5. Controlling laptop HP Elitebook 8730w, SN CNU 942532V, BAMS 1000757967  
running software MOSHELL V8.0k
6. Switch
7. Balun for 10 MHz reference, converting BNC to RJ-45 connector
8. SP test instrument according measurement equipment list
9. Attenuator and filter according measurement equipment list

FCC ID: TA8AKRC11864-2  
IC: 287AB-AS118642

Appendix 1

**Test set-up conducted RX measurements at port RF B**

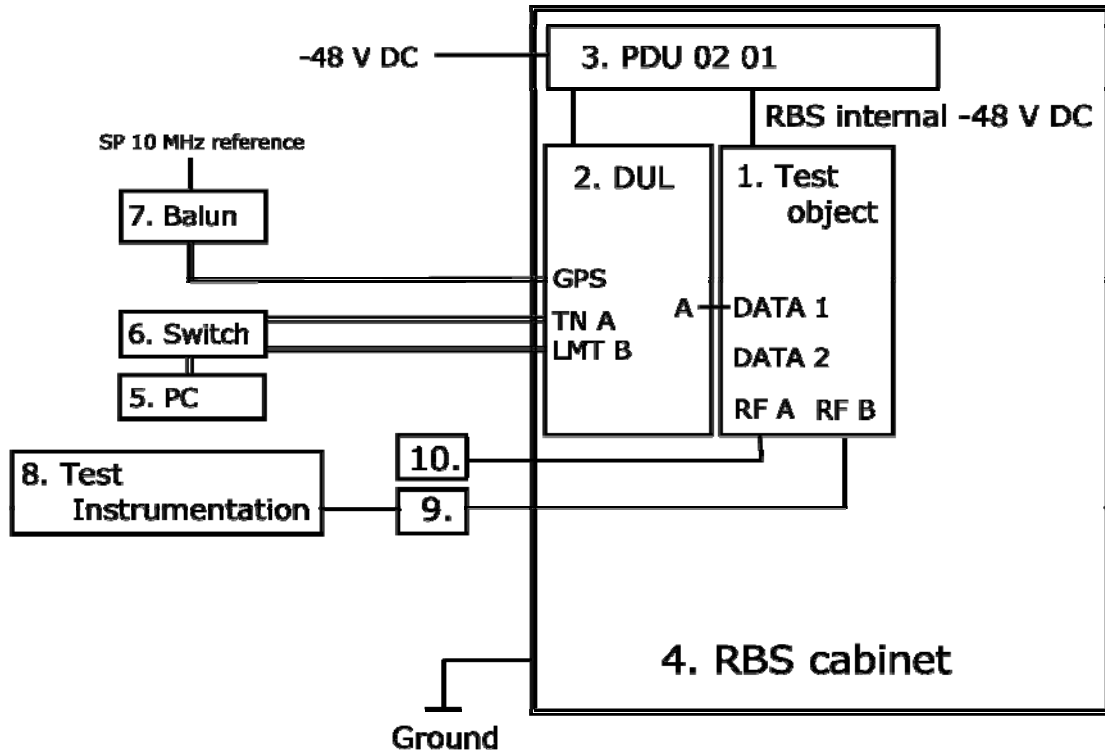

**Test object**

1. RUS 01 B5, product KRC 118 64/2, revision R1C, SN(S)C823990677  
FCC ID: TA8AKRC11864-2 and IC: 287AB-AS118642

**Functional test equipment**

2. DUL 20 01, product KDU 137 533/4, revision R1B, SN C823884475
3. PDU 02 01, product BMG 980 336/4, revision R2A, SN BJ31528316
4. RBS 6201 cabinet, BAMS 1000778792
5. Controlling laptop HP Elitebook 8730w, SN CNU 942532V, BAMS 1000757967  
running software MOSHELL V8.0k
6. Switch
7. Balun for 10 MHz reference, converting BNC to RJ-45 connector
8. SP test instrument according measurement equipment list
9. Attenuator and filter according measurement equipment list
10. Attenuator according measurement equipment list and 50 ohm termination

FCC ID: TA8AKRC11864-2  
IC: 287AB-AS118642

Appendix 1

**Test set-up, radiated measurements**

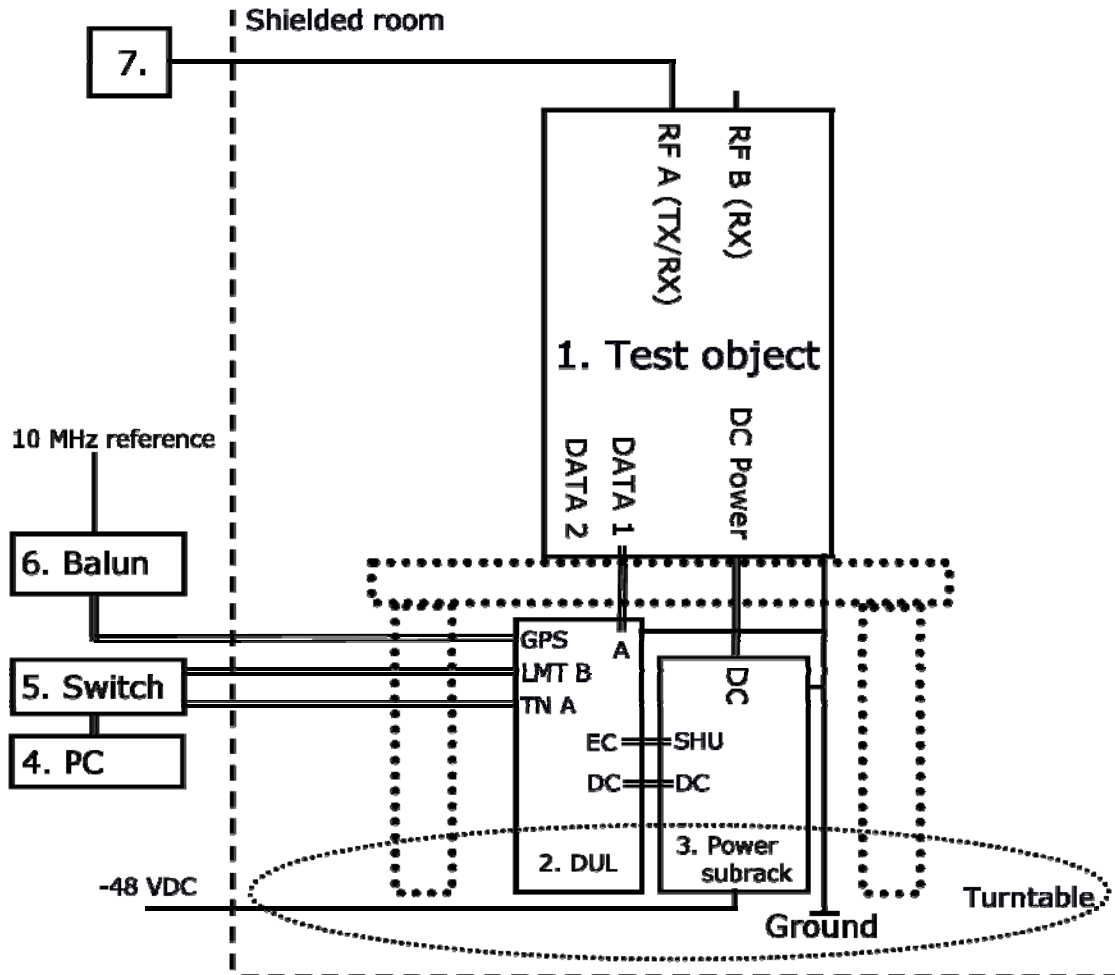

**Test object**

- 1 RUS 01 B5, product KRC 118 64/2, revision R1C, SN C823990659  
FCC ID: TA8AKRC11864-2 and IC: 287AB-AS118642

**Functional test equipment**

2. DUL 20 01, product KDU 137 533/4, revision R1B, SN C823884494
3. Power subrack, individual components are listed below
4. Laptop computer: Mobile Workstation, HP Elite book BAMS – 1000757968 with MOSHELL Ver. 8.0k
5. Fast Ethernet Switch: NETGEAR 10/100 Mbps model: FS108
6. Balun for 10 MHz reference, converting BNC to RJ-45 connector
7. Attenuator according measurement equipment list and 50 ohm termination



FCC ID: TA8AKRC11864-2  
IC: 287AB-AS118642

Appendix 1

**Test object ports**

<b>Interface:</b>	<b>Type of port:</b>
Ground connection during stand alone radiated emission test, in normal use grounded via cabinet	Ground
Supply power -48 VDC	DC Power
Antenna port 1 "RF A", 7/16 connector, female, combined TX/RX	Antenna
Antenna port 2 "RF B", 7/16 connector, female, RX only	Antenna
Data 1, connected to Port "A" at DUL	Signal
Data 2, unused	Signal
RXA I/O cross connector, unused	Signal
RXA OUT cross connector, unused	Signal
RXB I/O cross connector, unused	Signal

**Test object software**

<b>Software</b>	<b>Revision</b>
CXP 102 051/10	R9AJ

**Components of the power sub-rack used during radiated emission test**

<b>Position</b>	<b>Product name</b>	<b>Product number</b>	<b>R-state</b>	<b>Serial number</b>
1	PDU 01 01	BMG 980 336/2	R4F	BJ31532384
2	PDU 01 01	BMG 980 336/2	R4F	BJ31532382
3	SHU 01 01	BGK 901 18/1	R3C	BJ31446269
4	DUMMY	SXK 109 8257/1	R1F	-
5	DUMMY	SXK 109 8257/1	R1F	-
6	PFU 01 01	KFE 101 1162/1	R1B	BR80910495
7	DUMMY	SXK 109 8257/1	R1F	-
8	DUMMY	SXK 109 8257/1	R1F	-
9	PCF 02 01	KFE 101 1157/1	R1C	BW95301450

Note: The power subrack is functional test equipment in the context of this test report.



FCC ID: TA8AKRC11864-2  
IC: 287AB-AS118642

Appendix 2

**RF power output measurements according to 47 CFR 2.1046, 22.913 / IC RSS-132 4.4**

Date	Temperature	Humidity
2011-01-10	23 °C ± 3 °C	23 % ± 5 %
2011-01-11	22 °C ± 3 °C	18 % ± 5 %
2011-01-12	23 °C ± 3 °C	17 % ± 5 %
2011-01-13	23 °C ± 3 °C	14 % ± 5 %
2011-01-14	23 °C ± 3 °C	15 % ± 5 %

**Test set-up and procedure**

The test object was connected to a power analyzer measuring peak and RMS output power in CDF mode.

Measurement equipment	SP number
Boonton RF Peak power meter/analyzer	503 144
Boonton Power sensor 56518-S/4	503 145
RF attenuator	504 159
Testo 615 temperature and humidity meter	503 498

**Measurement uncertainty:** 0.7 dB

**Results**

Nominal maximum rated output power 47.8 dBm (60 W).

Measured output power at connector RF A:

Test conditions	Transmitter power RMS (dBm) / PAR (dB)		
	Frequency B	Frequency M	Frequency T
BW configuration 1.4 MHz	47.3 / 7.1	47.5 / 7.0	47.4 / 6.9
BW configuration 3 MHz	47.5 / 6.8	47.5 / 6.8	47.4 / 6.9
BW configuration 5 MHz	47.5 / 7.0	47.5 / 6.7	47.5 / 6.9
BW configuration 10 MHz	47.5 / 7.2	47.5 / 6.6	47.5 / 7.0
BW configuration 15 MHz	47.3 / 7.2	47.3 / 6.9	47.2 / 7.2
BW configuration 20 MHz	47.2 / 7.3	47.3 / 7.0	47.2 / 7.1

**Limits**

CFR 47, 22.913/ SRSP-503 5.1: The effective radiated power (ERP) of base transmitters and cellular repeaters must not exceed 500 Watts (57 dBm).

RSS-132: The transmitter output power shall not exceed the limits given in SRSP-503

Complies?	Yes
-----------	-----

FCC ID: TA8AKRC11864-2  
IC: 287AB-AS118642

Appendix 3

**Occupied bandwidth measurements according to 47 CFR 2.1049 /  
IC RSS-Gen 4.6.1**

Date	Temperature	Humidity
2011-01-11	22 °C ± 3 °C	18 % ± 5 %
2011-01-12	23 °C ± 3 °C	17 % ± 5 %
2011-01-13	23 °C ± 3 °C	14 % ± 5 %

**Test set-up and procedure**

The measurements were made per definition in §2.1049. The output was connected to a signal analyzer with the RMS detector activated. The signal analyzer was connected to an external 10 MHz reference standard during the measurements.

Measurement equipment	SP number
Rohde & Schwarz signal analyzer FSQ40	504 143
RF attenuator	504 159
Testo 615 temperature and humidity meter	503 498

Measurement uncertainty: 3.7 dB

**Results**

The results are shown in appendix 3.1

Diagram	BW configuration	Tested frequency	OBW / [MHz]
1	1.4 MHz	B	1.094
2	20 MHz	B	17.850
3	1.4 MHz	M	1.094
4	3 MHz	M	2.696
5	5 MHz	M	4.485
6	10 MHz	M	8.940
7	15 MHz	M	13.4250
8	20 MHz	M	17.850
9	1.4 MHz	T	1.094
10	20 MHz	T	17.850



FCC ID: TA8AKRC11864-2  
IC: 287AB-AS118642

Appendix 3.1

Diagram 1

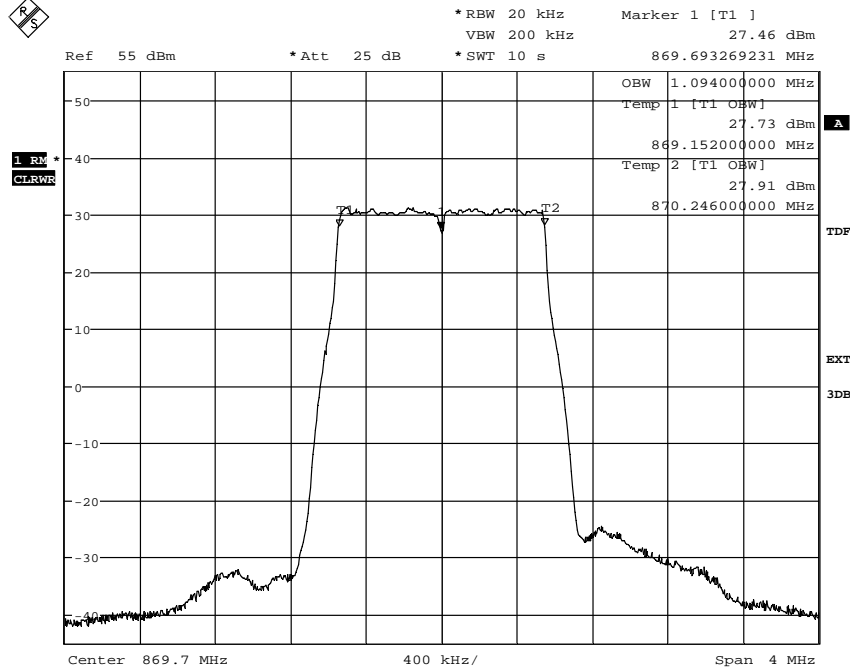

Date: 11.JAN.2011 13:09:40

Diagram 2

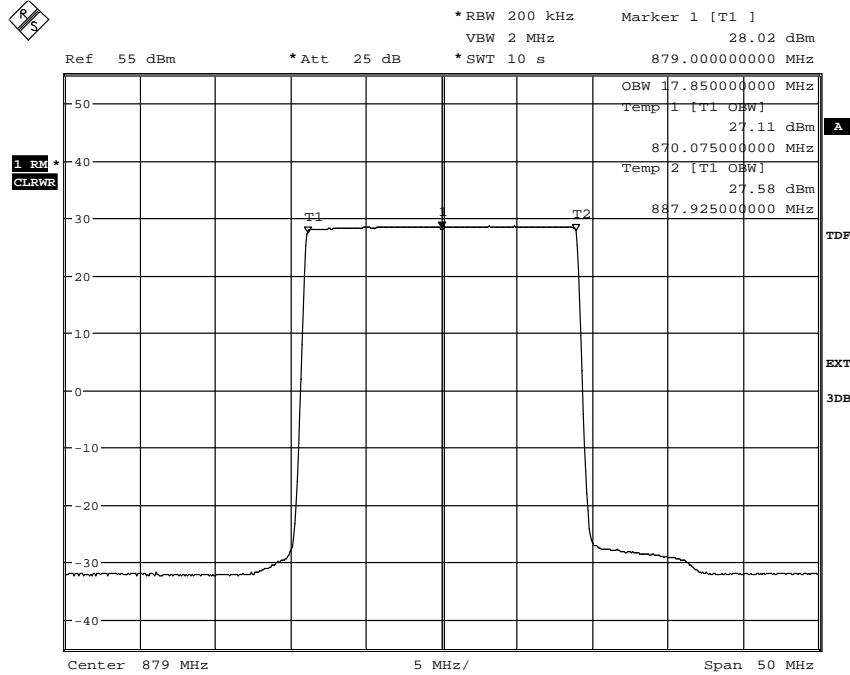

Date: 12.JAN.2011 15:14:37



FCC ID: TA8AKRC11864-2  
IC: 287AB-AS118642

Appendix 3.1

Diagram 3

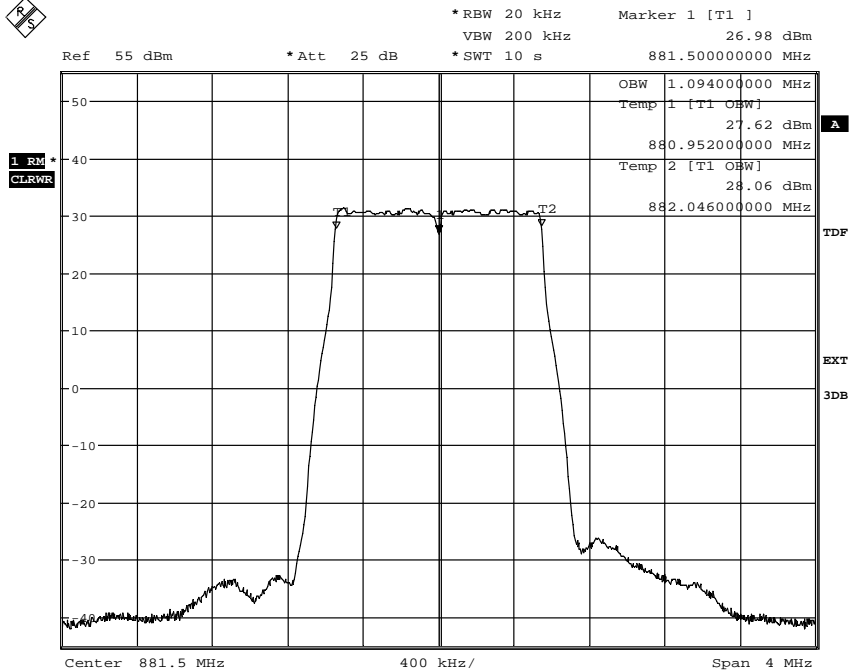

Date: 13.JAN.2011 09:04:07

Diagram 4

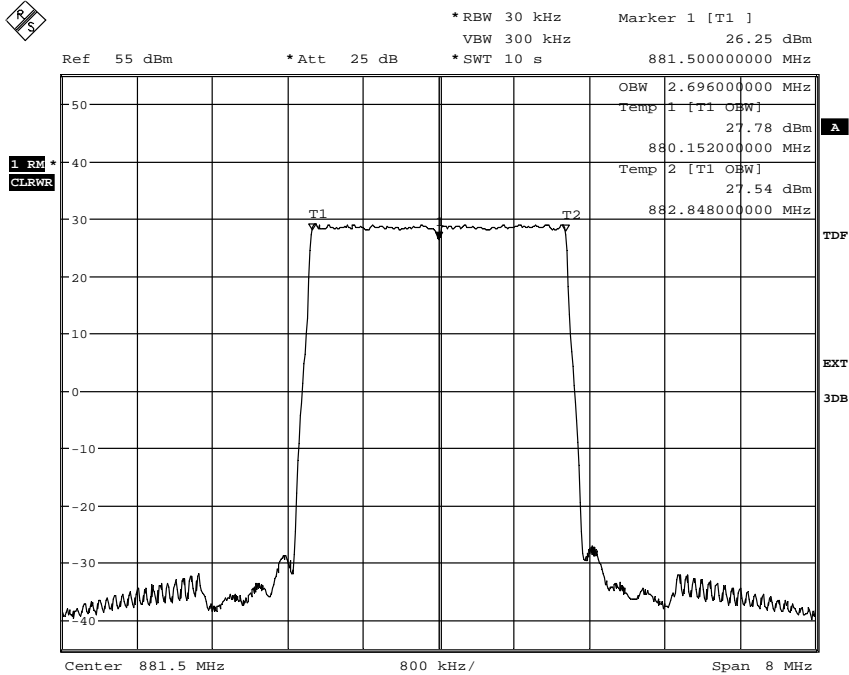

Date: 13.JAN.2011 09:16:44



FCC ID: TA8AKRC11864-2  
IC: 287AB-AS118642

Appendix 3.1

Diagram 5

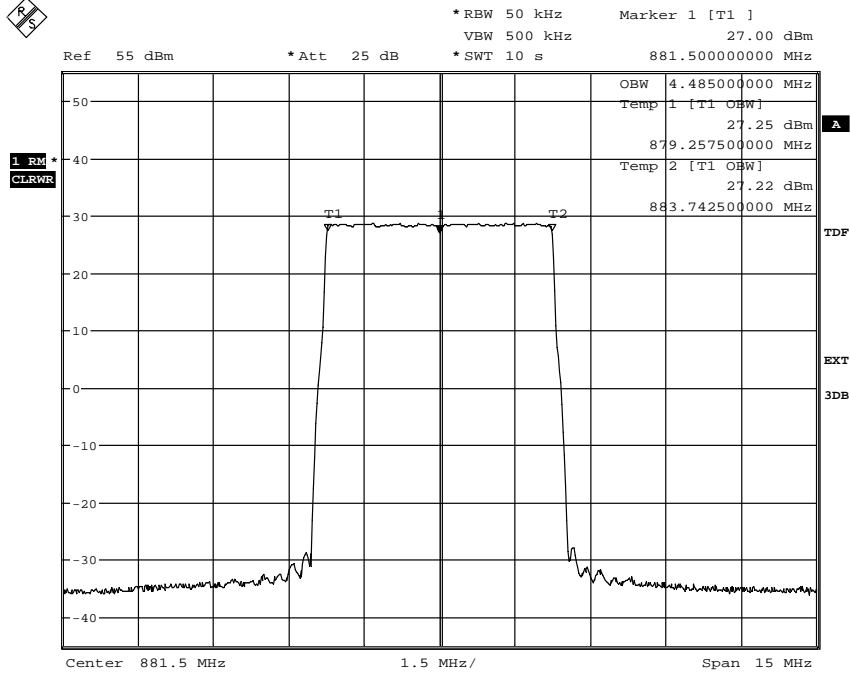

Date: 13.JAN.2011 10:18:17

Diagram 6

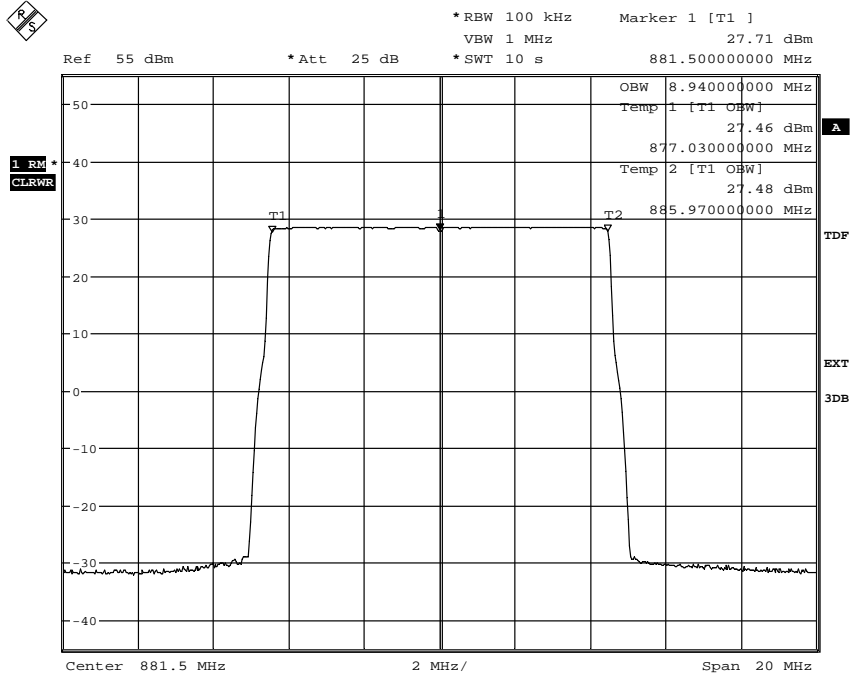

Date: 13.JAN.2011 10:53:35



FCC ID: TA8AKRC11864-2  
IC: 287AB-AS118642

Appendix 3.1

Diagram 7

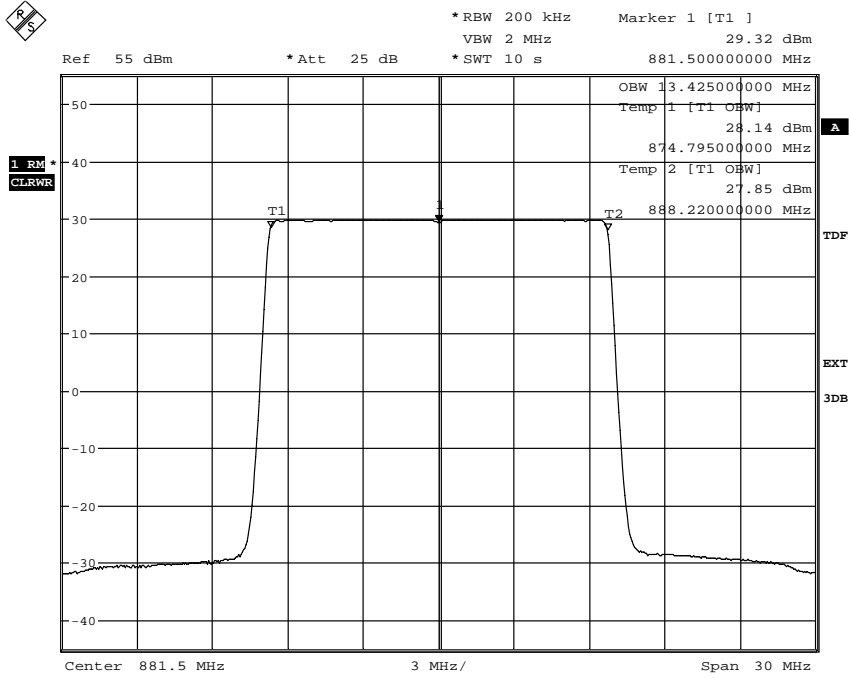

Date: 13.JAN.2011 12:50:37

Diagram 8

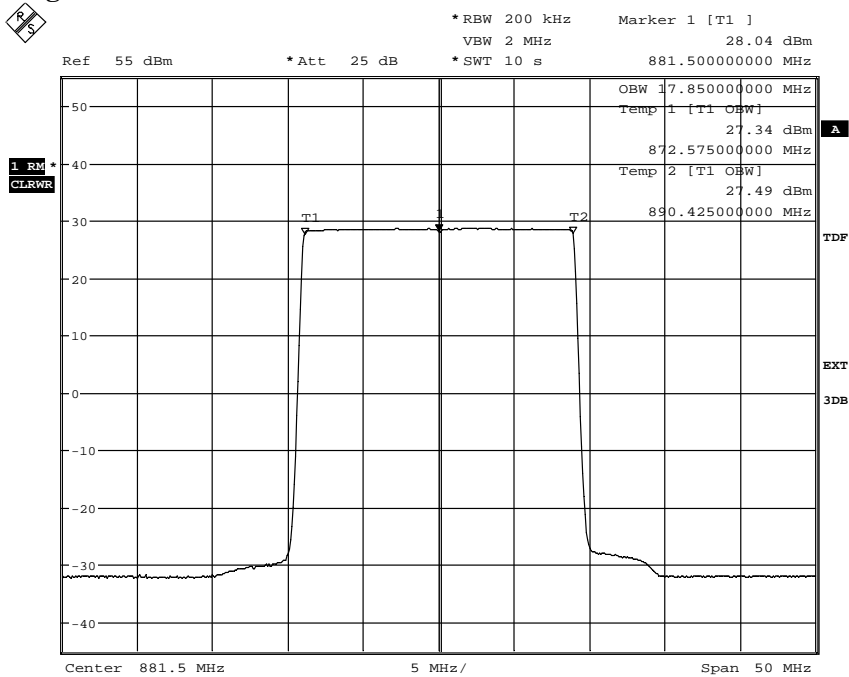

Date: 13.JAN.2011 14:06:04



FCC ID: TA8AKRC11864-2  
IC: 287AB-AS118642

Appendix 3.1

Diagram 9

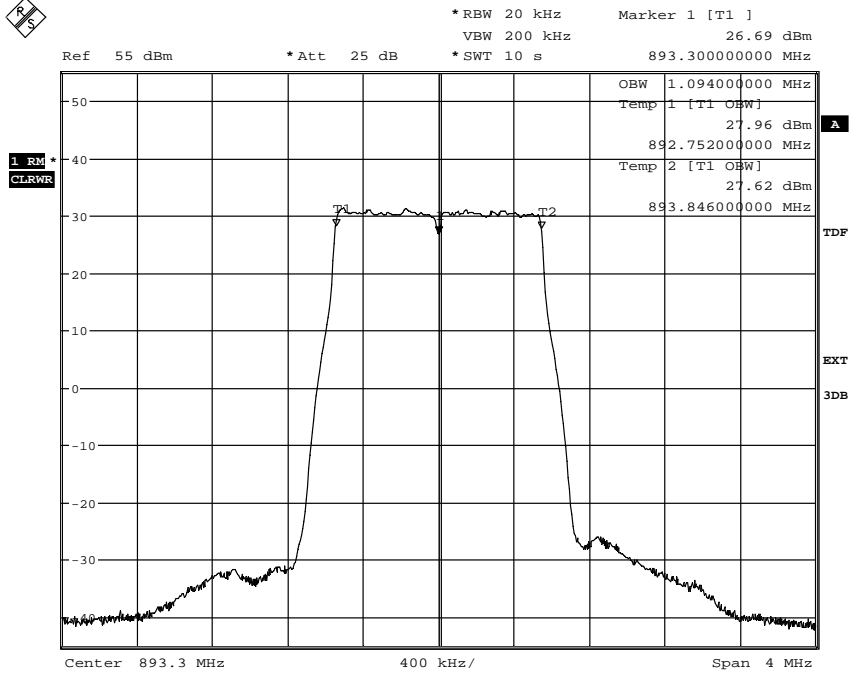

Date: 13.JAN.2011 15:39:26

Diagram 10

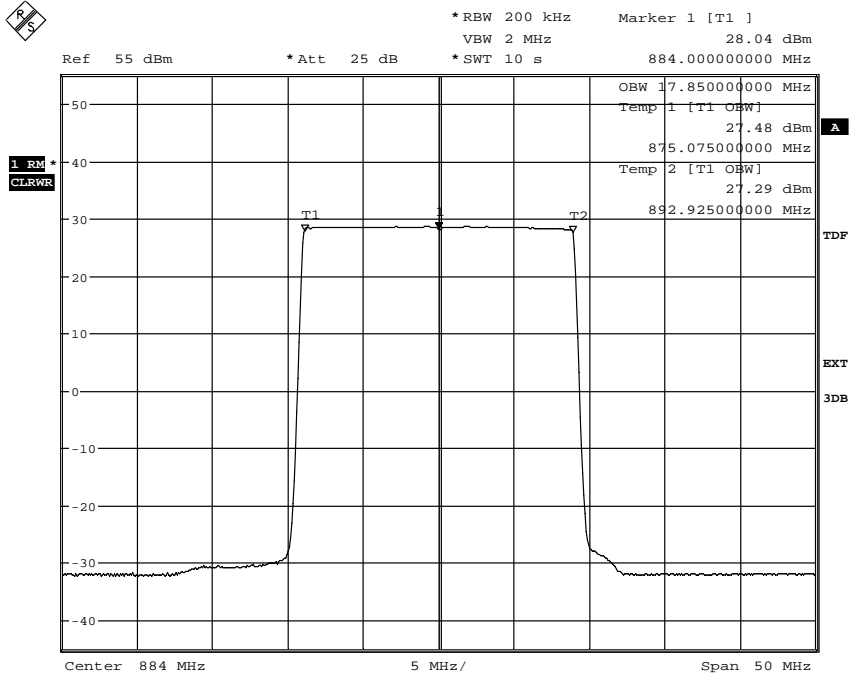

Date: 14.JAN.2011 09:40:41





FCC ID: TA8AKRC11864-2  
IC: 287AB-AS118642

Appendix 4

**Band edge measurements according to 47 CFR 2.1051, 22.917 / IC RSS-132 4.5**

Date	Temperature	Humidity
2011-01-11	22 °C ± 3 °C	18 % ± 5 %
2011-01-12	23 °C ± 3 °C	17 % ± 5 %
2011-01-13	23 °C ± 3 °C	14 % ± 5 %

**Test set-up and procedure**

The measurements were made per definition in §22.917. The test object was connected to a spectrum analyzer with the RMS detector activated. The spectrum analyzer was connected to an external 10 MHz reference standard during the measurements.

Beyond the 1<sup>st</sup> MHz off the band edges the limit was adjusted to compensate for reduced measurement bandwidths where applicable, pursuant to the FCC rules, specifying a RBW of at least 1% of the fundamental emission bandwidth up to 1 MHz away from the band edges and a RBW of at least 100 KHz for measurements of emissions more than 1 MHz away from the band edges. For used RBWs smaller than the reference measurement bandwidth required by the applicable standards the limit was determined according fomula [1],

Limit = -13 dBm + 10 log ( RBWused / Bandwidth required by the applicable standard) [1]

resulting in following limits for frequencies offset 1 MHz to 5 MHz from the band edges:

Channel BW configuration [MHz]	RBW used [kHz]	FCC limit [dBm]	IC limit [dBm]
1.4	20	-20.0	-20.0
3	30	-18.2	-18.2
5	30 (*)	-18.2	-28.2
10	100	-13.0	-23.0
15	200	-13.0	-20.0
20	200	-13.0	-20.0

(\*) The RBW 30 kHz is less than 1% of the measured emission bandwidth of 4.508 MHz for this BW configuration, thus the limit line in the plot was adapted by -1.8 dB (10 log[30/45]) to -14.8 dBm up to 1 MHz from the band edge.

Beyond 5 MHz off the band edges RBW 1 MHz was used to cover RSS-132 item 4.5.1.2, which requires 1 MHz RBW for signals exceeding 4 MHz emission bandwidth.

The limit lines shown in the plots represent the lower bound (most conservative requirement) of aggregated FCC and IC limits.

Measurement equipment	SP number
Rohde & Schwarz FSQ40	504 143
RF attenuator	504 159
Testo 615 temperature and humidity meter	503 498

**Measurement uncertainty: 3.7 dB**



FCC ID: TA8AKRC11864-2  
IC: 287AB-AS118642

Appendix 4

**Results**

The results are shown in appendix 4.1

Diagram	BW configuration	Tested frequency
1 a+b	1.4 MHz	B
2 a+b	3 MHz	B
3 a+b	5 MHz	B
4 a+b	10 MHz	B
5 a+b	15 MHz	B
6 a+b	20 MHz	B
7 a+b	1.4 MHz	T
8 a+b	3 MHz	T
9 a+b	5 MHz	T
10 a+b	10 MHz	T
11 a+b	15 MHz	T
12 a+b	20 MHz	T

**Limits**

CFR 47, 22.917 / RSS-132 4.5:

The power of any emission outside the frequency band shall be attenuated below the transmitter power (P) by at least  $43 + 10 \log P$  dB.

Complies?	Yes
-----------	-----



FCC ID: TA8AKRC11864-2  
IC: 287AB-AS118642

Appendix 4.1

Diagram 1 a

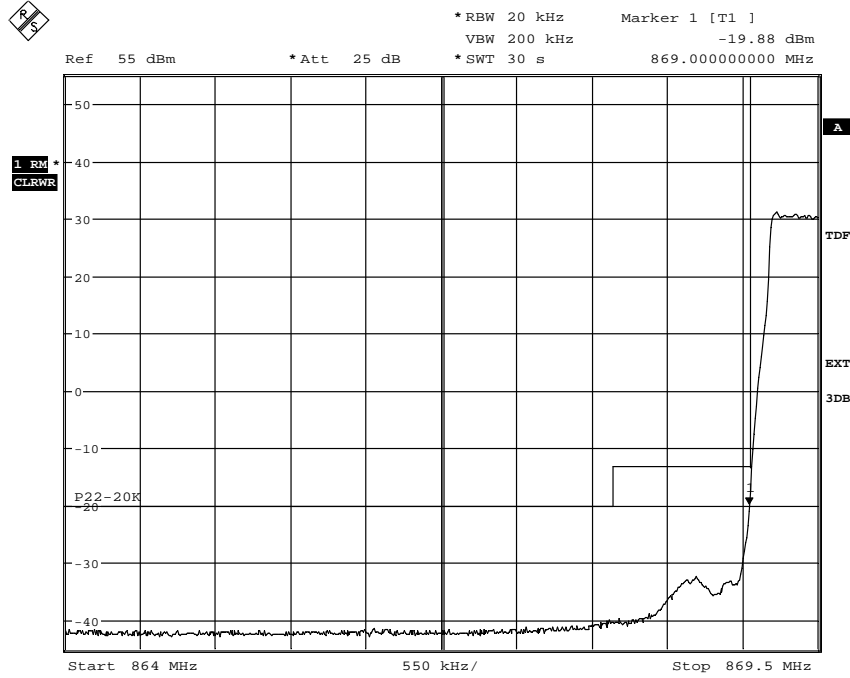

Date: 11.JAN.2011 11:43:55

Diagram 1 b

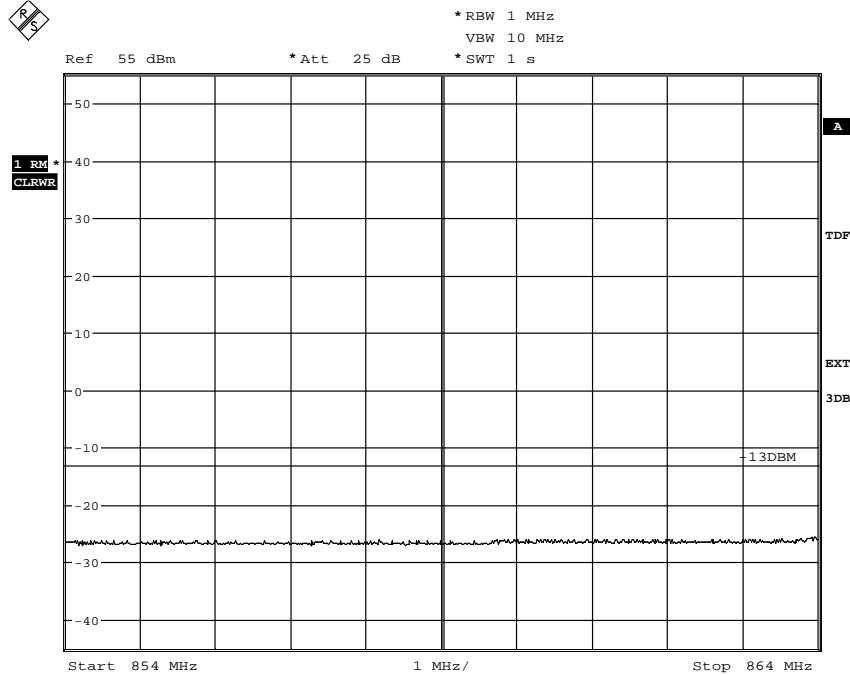

Date: 11.JAN.2011 11:49:29







FCC ID: TA8AKRC11864-2  
IC: 287AB-AS118642

Appendix 4.1

Diagram 4 a

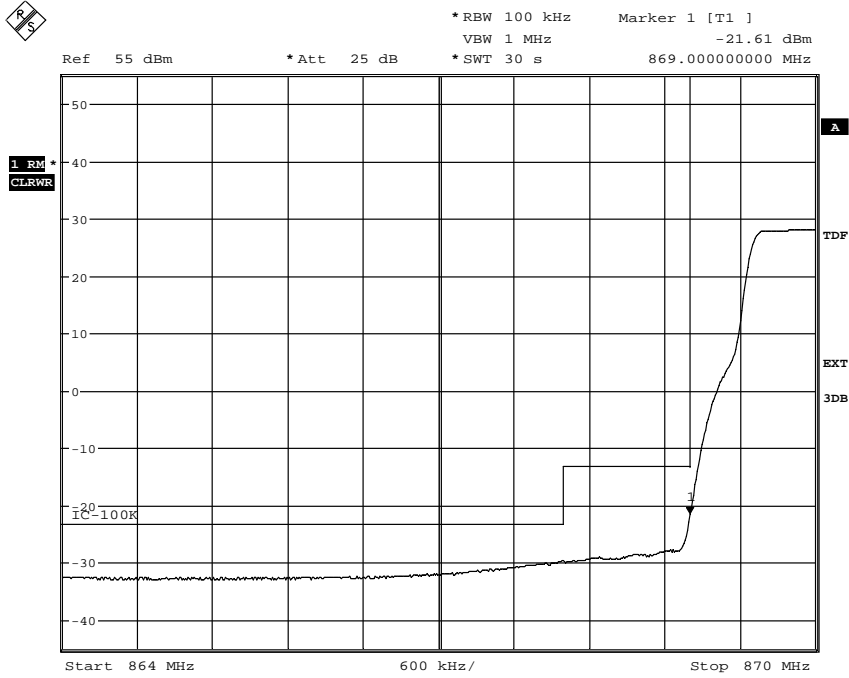

Date: 12.JAN.2011 10:24:42

Diagram 4 b

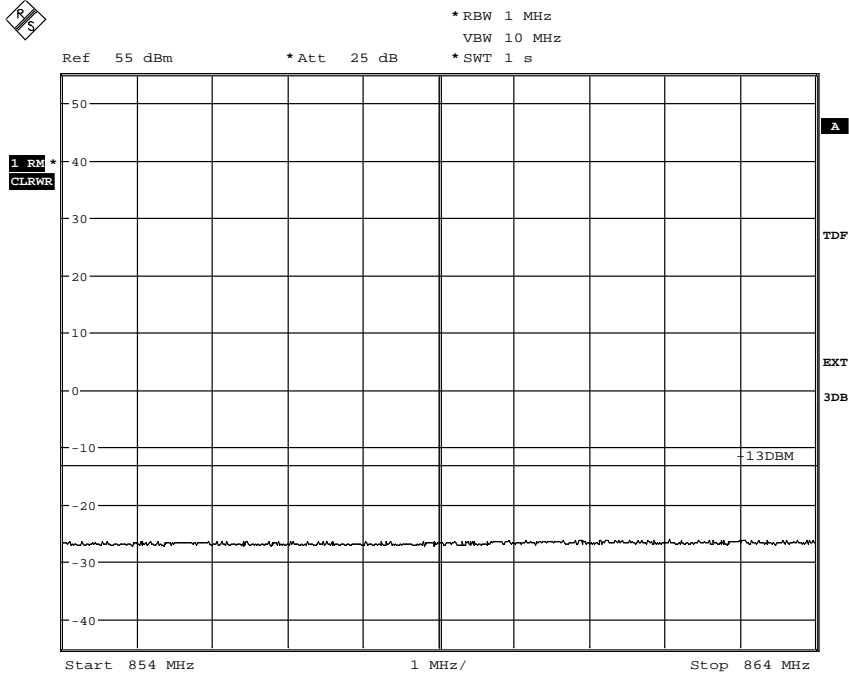

Date: 12.JAN.2011 10:26:53



FCC ID: TA8AKRC11864-2  
IC: 287AB-AS118642

Appendix 4.1

Diagram 5 a

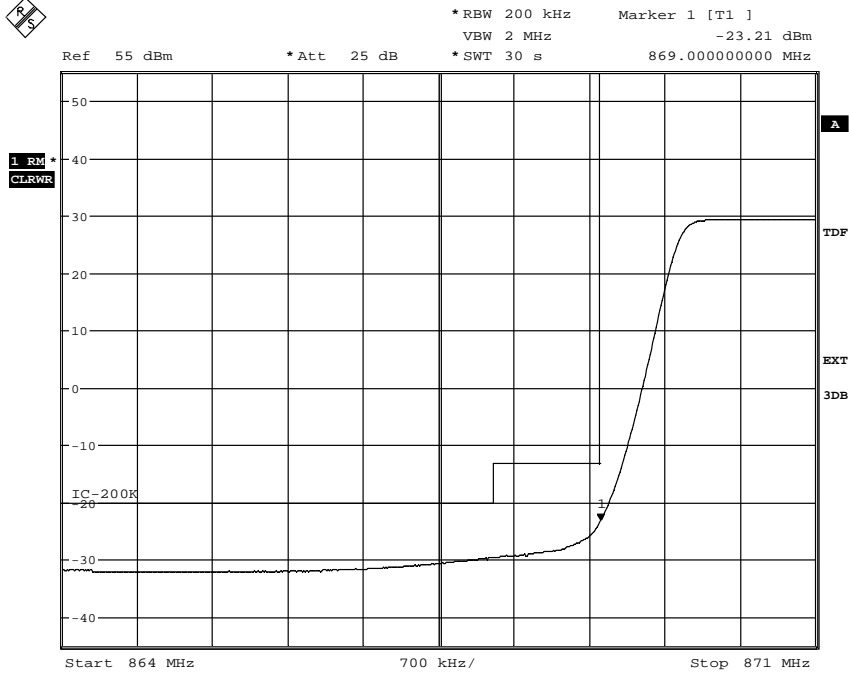

Date: 12.JAN.2011 11:13:00

Diagram 5 b

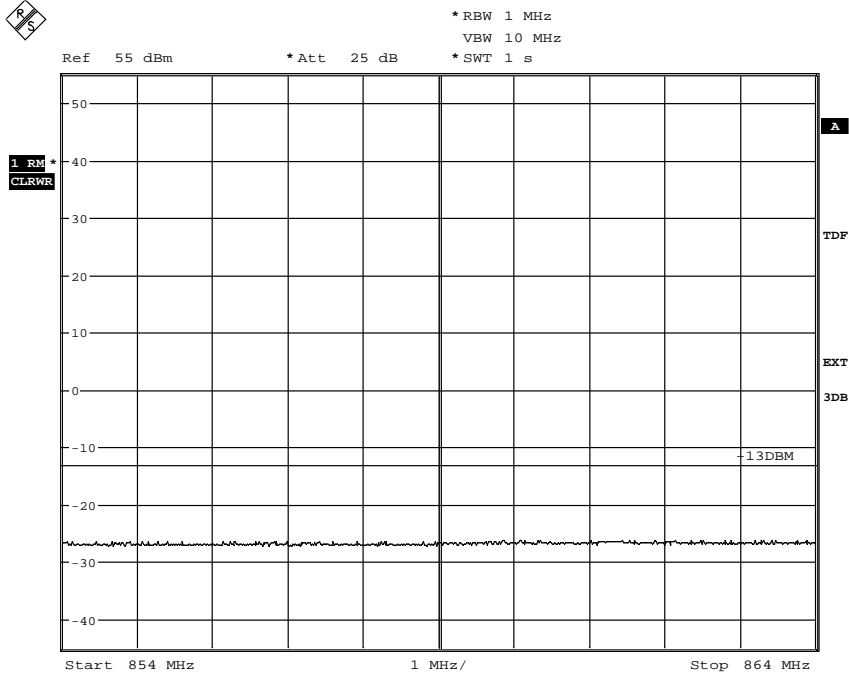

Date: 12.JAN.2011 11:14:14

FCC ID: TA8AKRC11864-2  
IC: 287AB-AS118642

Appendix 4.1

**Diagram 6 a**

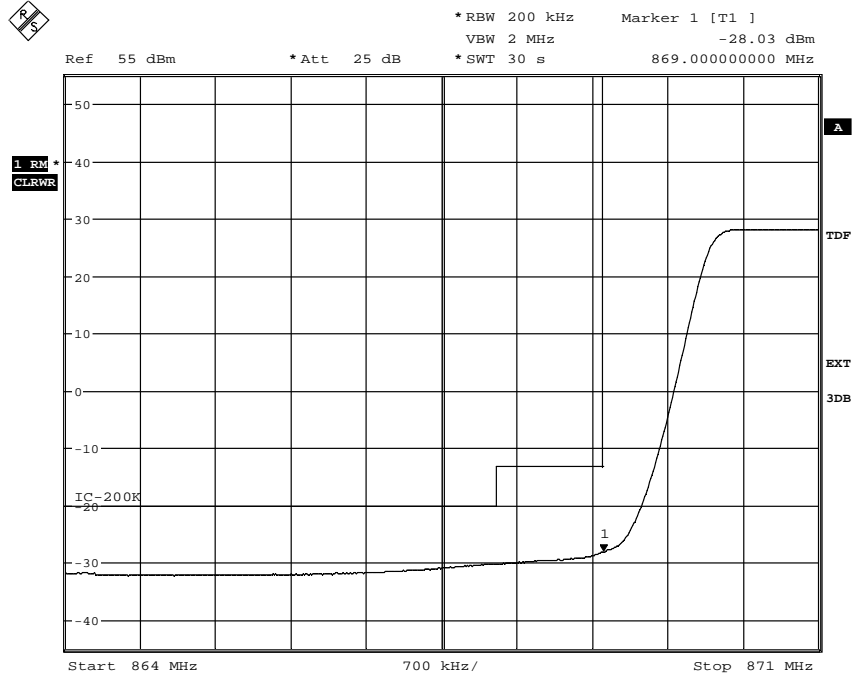

Date: 12.JAN.2011 14:58:22

**Diagram 6 b**

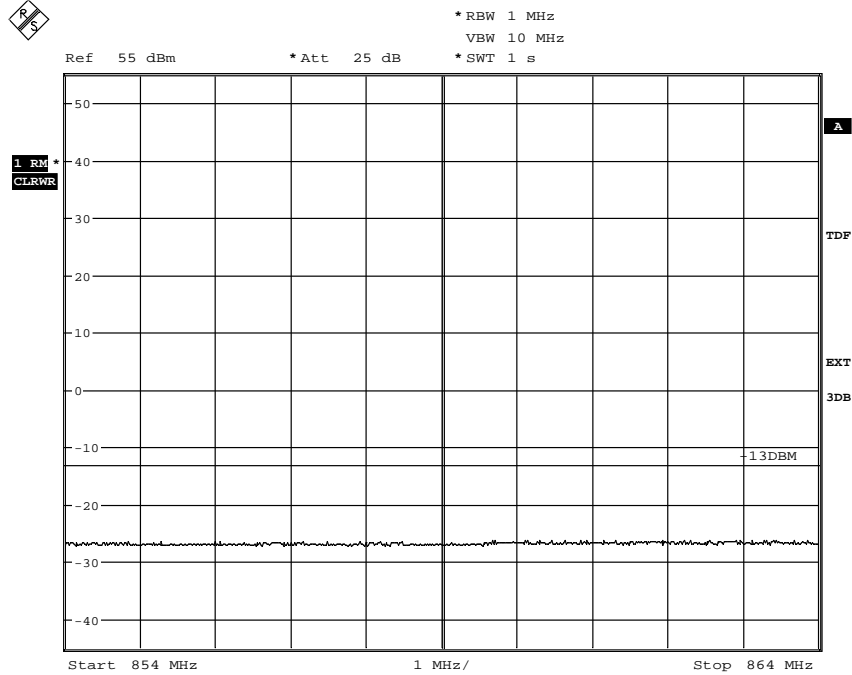

Date: 12.JAN.2011 14:59:27





FCC ID: TA8AKRC11864-2  
IC: 287AB-AS118642

Appendix 4.1

Diagram 7 a

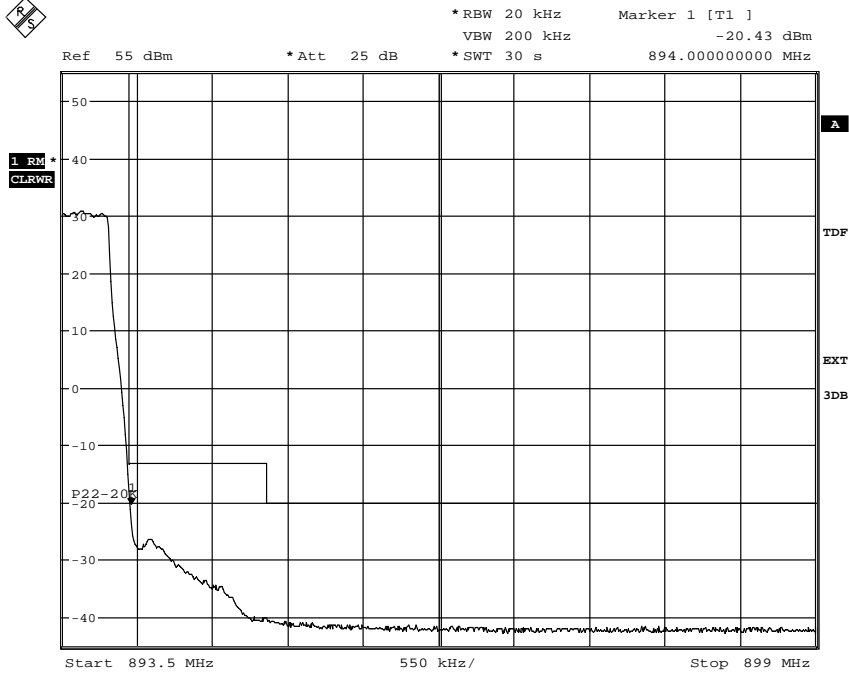

Date: 13.JAN.2011 15:45:01

Diagram 7 b

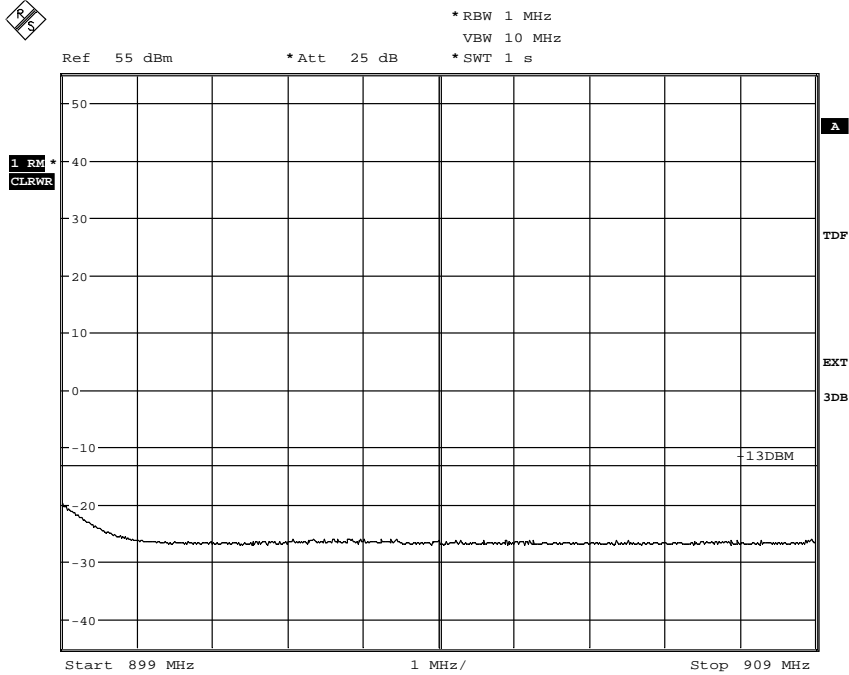

Date: 13.JAN.2011 15:49:32



FCC ID: TA8AKRC11864-2  
IC: 287AB-AS118642

Appendix 4.1

Diagram 8 a

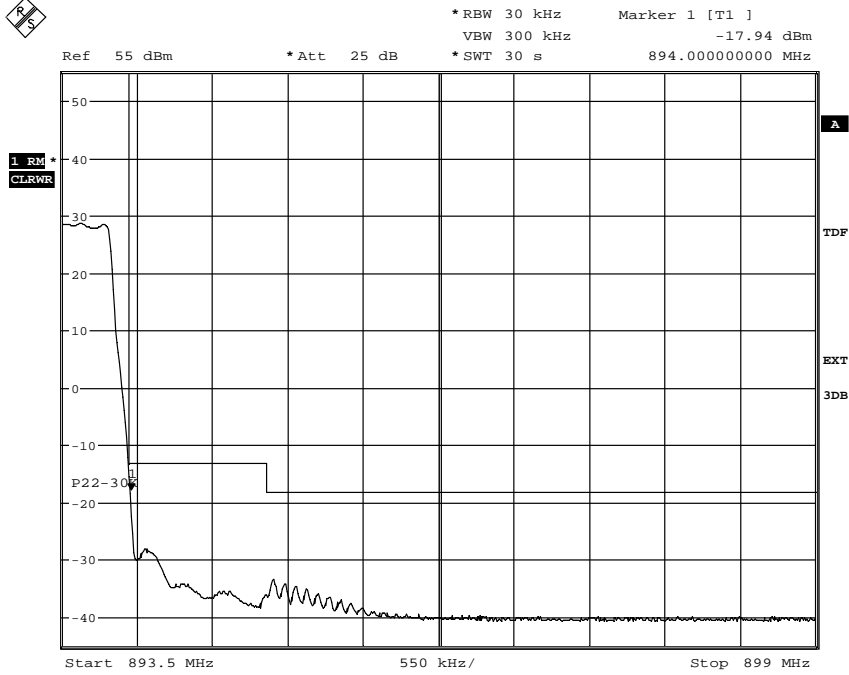

Date: 13.JAN.2011 16:13:13

Diagram 8 b

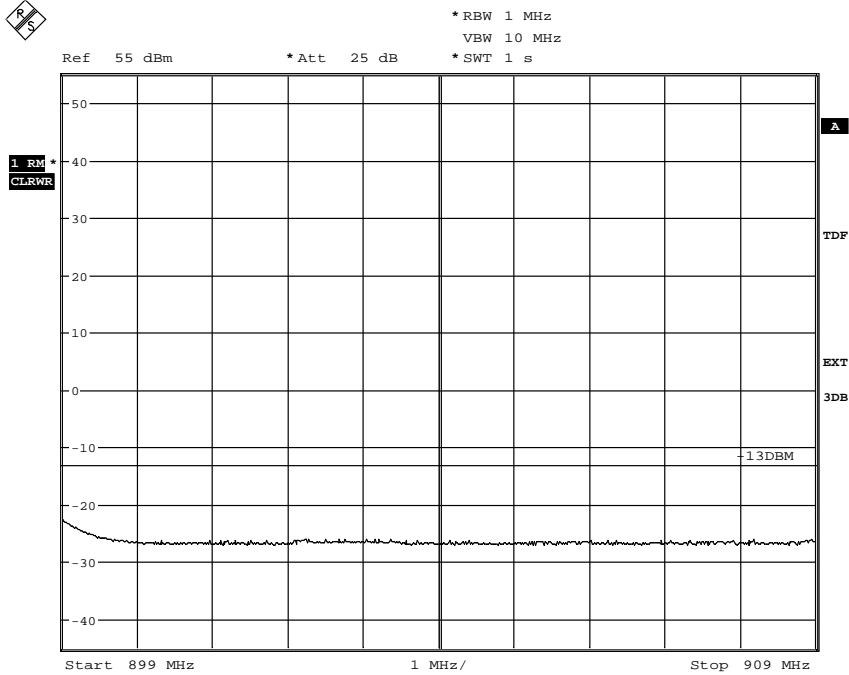

Date: 13.JAN.2011 16:14:52



FCC ID: TA8AKRC11864-2  
IC: 287AB-AS118642

Appendix 4.1

Diagram 9 a

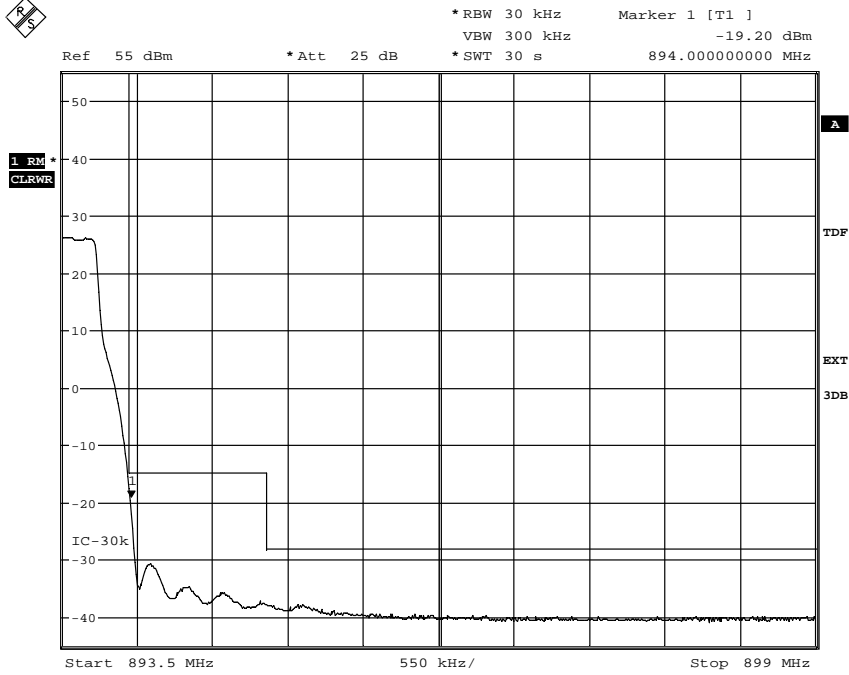

Date: 17.JAN.2011 16:34:42

Diagram 9 b

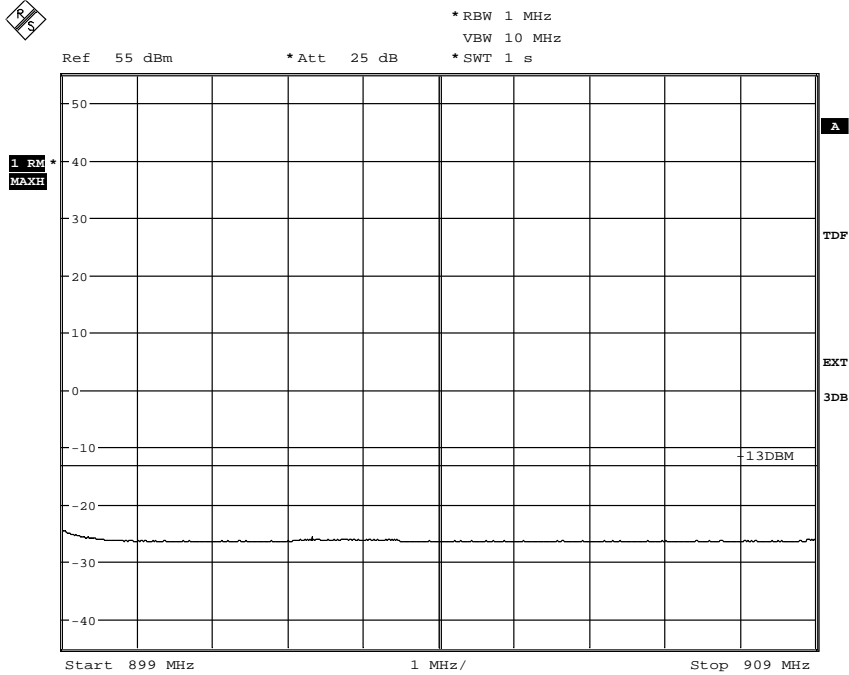

Date: 14.JAN.2011 07:27:50



FCC ID: TA8AKRC11864-2  
IC: 287AB-AS118642

Appendix 4.1

Diagram 10 a

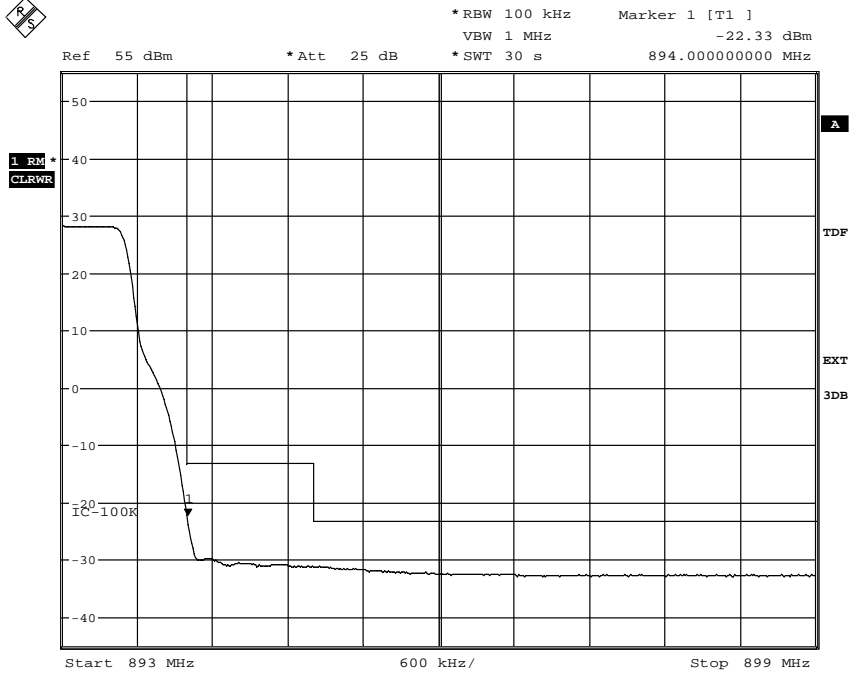

Date: 14.JAN.2011 08:33:19

Diagram 10 b

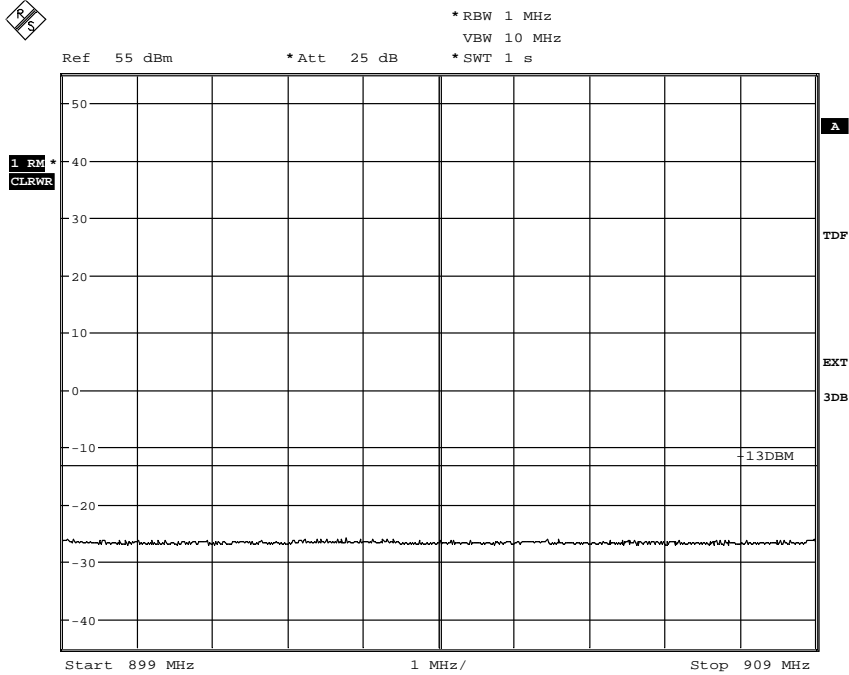

Date: 14.JAN.2011 08:40:03



FCC ID: TA8AKRC11864-2  
IC: 287AB-AS118642

Appendix 4.1

Diagram 11 a

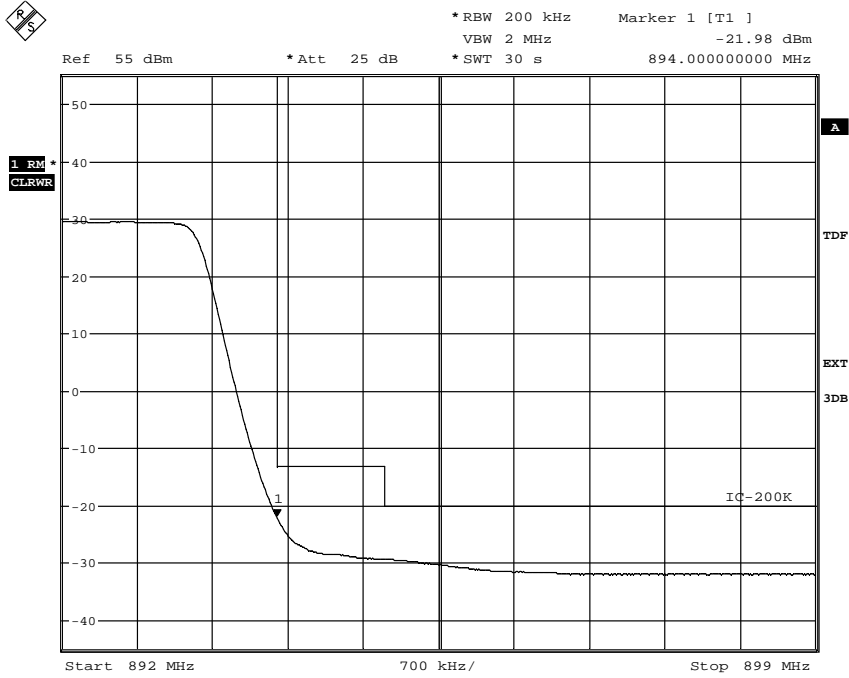

Date: 14.JAN.2011 09:05:15

Diagram 11 b

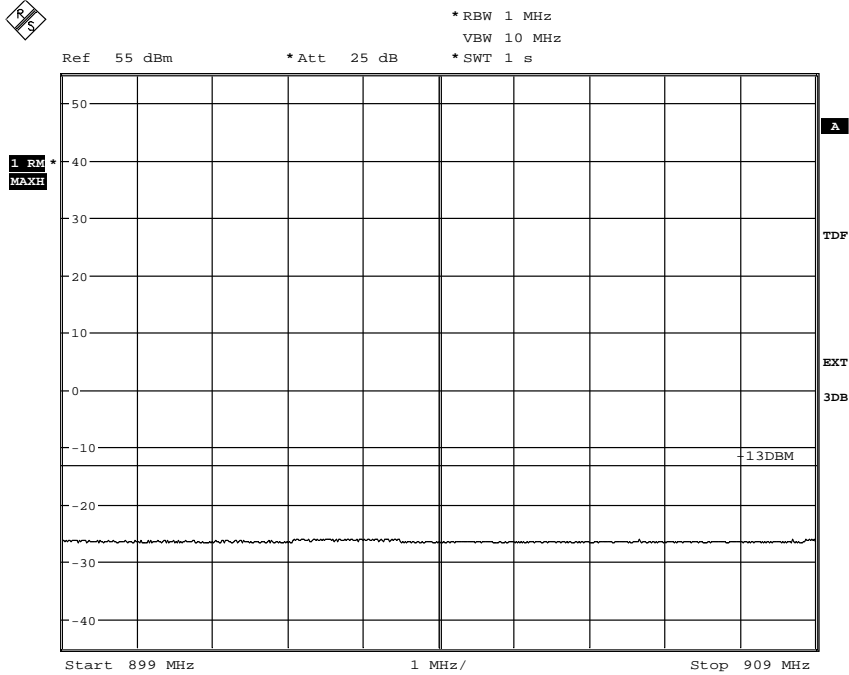

Date: 14.JAN.2011 09:01:42



FCC ID: TA8AKRC11864-2  
IC: 287AB-AS118642

Appendix 4.1

Diagram 12 a

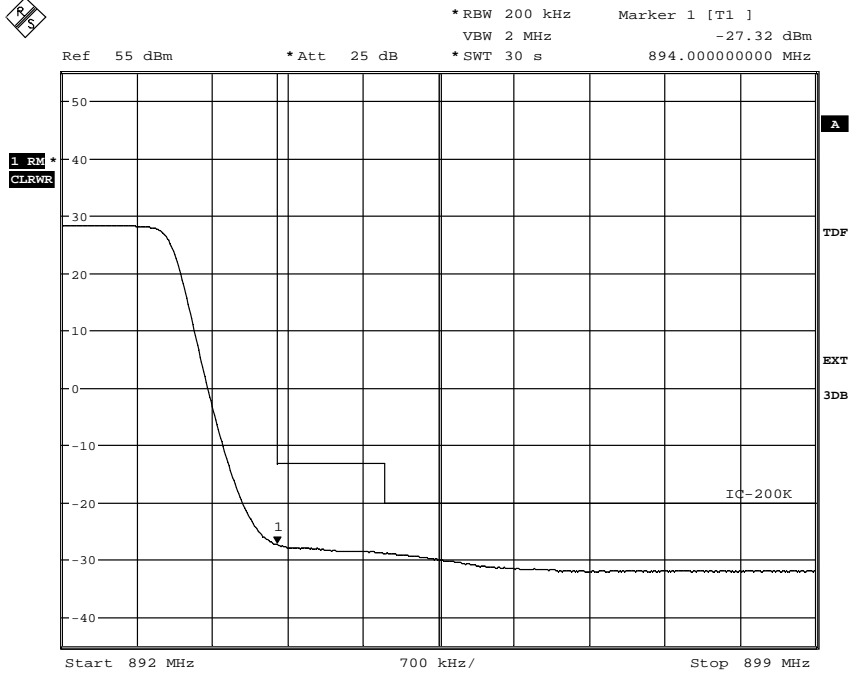

Date: 14.JAN.2011 09:27:39

Diagram 12 b

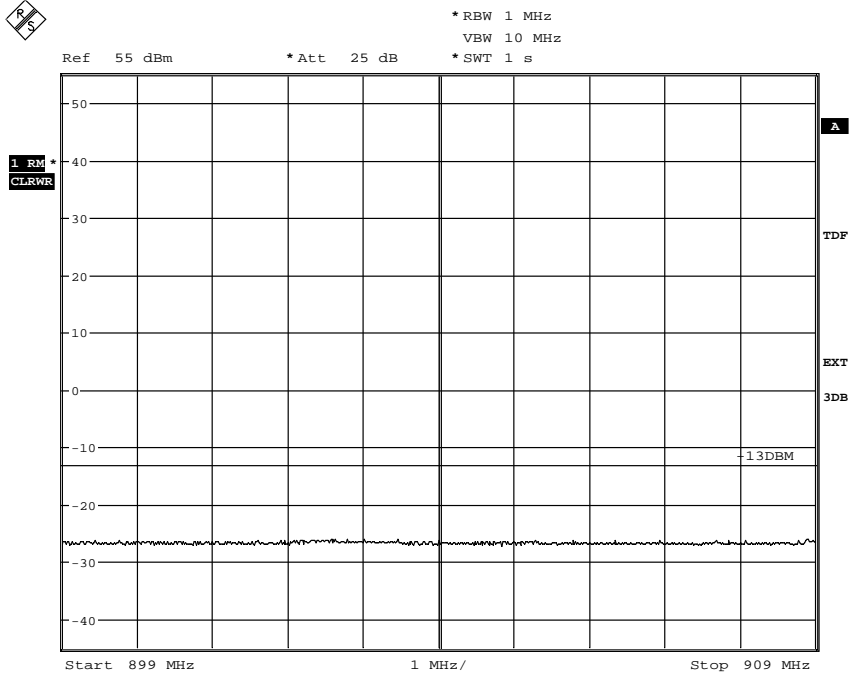

Date: 14.JAN.2011 09:30:12

FCC ID: TA8AKRC11864-2  
IC: 287AB-AS118642

Appendix 5

**Conducted spurious emission measurements according to 47 CFR 2.1051, 22.917 / IC RSS-132 4.5**

Date	Temperature	Humidity
2011-01-11	22 °C ± 3 °C	18 % ± 5 %
2011-01-12	23 °C ± 3 °C	17 % ± 5 %
2011-01-13	23 °C ± 3 °C	14 % ± 5 %
2011-01-14	23 °C ± 3 °C	14 % ± 5 %
2011-01-17	23 °C ± 3 °C	14 % ± 5 %
2011-01-24	23 °C ± 3 °C	17 % ± 5 %

**Test set-up and procedure**

The measurements were made with a RBW of 1 MHz instead of 100 kHz to cover RSS-132 section 4.5.1.2, requiring a RBW of 1 MHz for emission bandwidths exceeding 4 MHz, even though the worst case configuration was found to be BW configuration 1.4 MHz.

The test object output was connected to a spectrum analyzer. A pre-measurement wideband sweep was performed with the PEAK detector activated. Emission close to or above the limit with the PEAK detector was zoomed in and re-measured with the RMS detector activated using the substitution method, and the result was noted. The spectrum analyzer was connected to an external 10 MHz reference standard during the measurements.

According to the client, the 2.4576 GHz clock was not used in the RF chain and is not affected by the power setting of the carrier frequency. The transmitter was activated for 40 W output power during the measurements in the frequency range 18 to 25 GHz. In the frequency range 9 kHz to 18 GHz the transmitter was activated for maximum output power.

Measurement equipment	SP number
Rohde & Schwarz FSQ40	504 143
RF attenuator	504 159
RF attenuator	900 233
High pass filter used within 1-15 GHz	502 758
High pass filter used within 15-18 GHz	504 200
High pass filter used within 18-25 GHz	503 740
Testo 615 temperature and humidity meter	503 498

**Measurement uncertainty: 3.7 dB**



FCC ID: TA8AKRC11864-2  
IC: 287AB-AS118642

Appendix 5

**Results**

Diagram	BW configuration / [MHz]	Tested frequency
1	1.4	B
2	20	B
3	1.4	M
4	3	M
5	5	M
6	10	M
7	15	M
8	20	M
9	1.4	T
10	20	T

The diagrams are shown in appendix 5.1

**Remark**

The emission at 9 kHz on some plots was not generated by the test object. A complementary measurement with a smaller RBW showed that it was related to the LO feed-through.

**Limits**

CFR 47, 22.917 / RSS-132 4.5:

The power of any emission outside the frequency band shall be attenuated below the transmitter power (P) by at least  $43 + 10 \log P$  dB.

Complies?	Yes
-----------	-----





FCC ID: TA8AKRC11864-2  
IC: 287AB-AS118642

Appendix 5.1

Diagram 1:

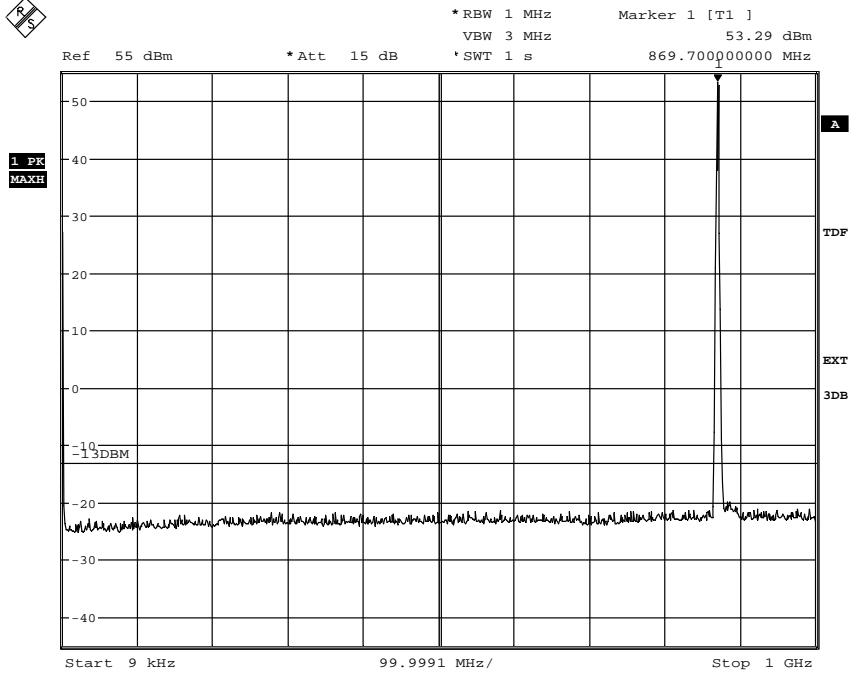

Date: 24.JAN.2011 15:54:03

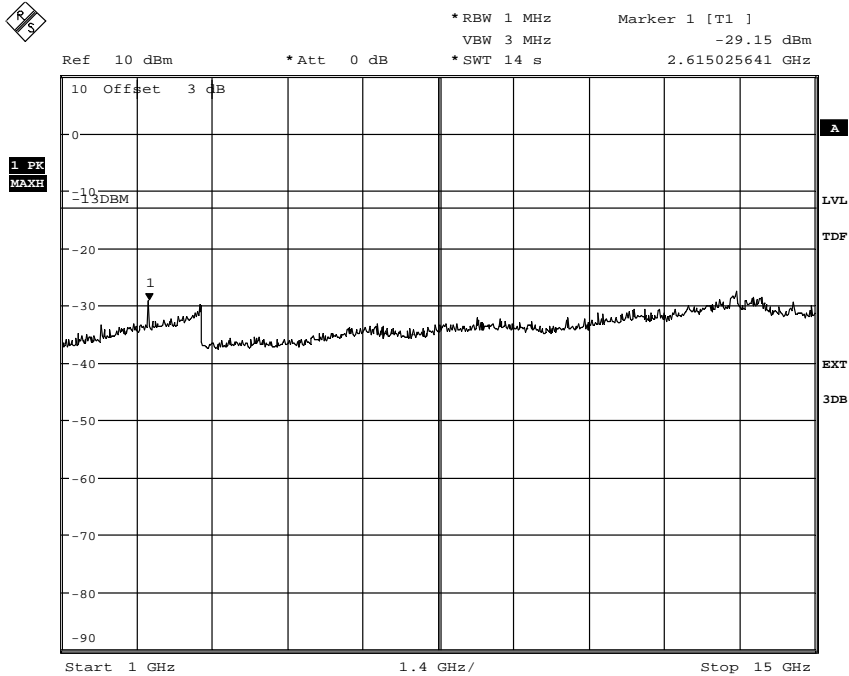

Date: 11.JAN.2011 13:50:31



# REPORT

Date  
2011-01-26

Reference  
FX022685-F22

Page  
2 (20)

FCC ID: TA8AKRC11864-2  
IC: 287AB-AS118642

## Appendix 5.1

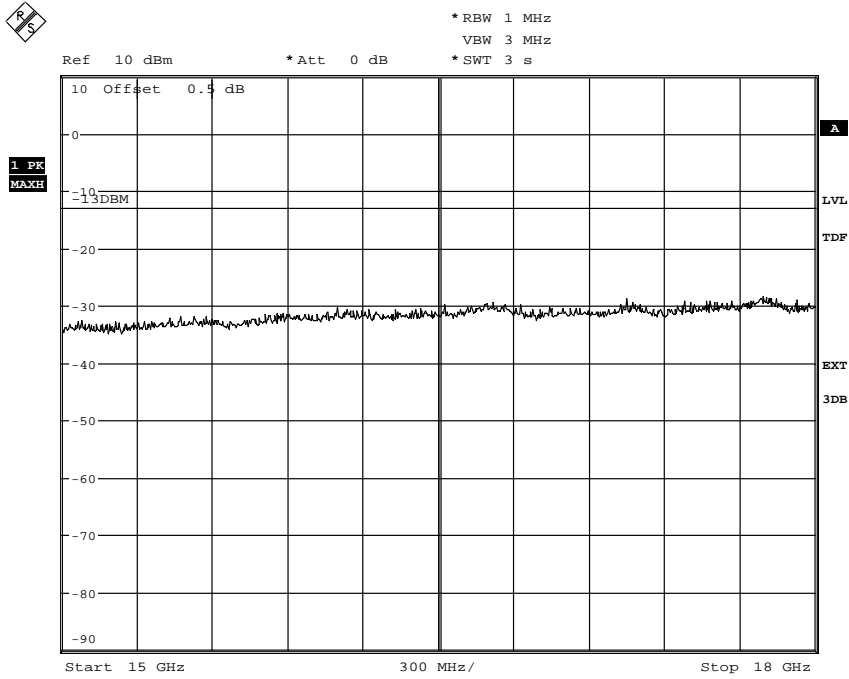

Date: 11.JAN.2011 13:58:24

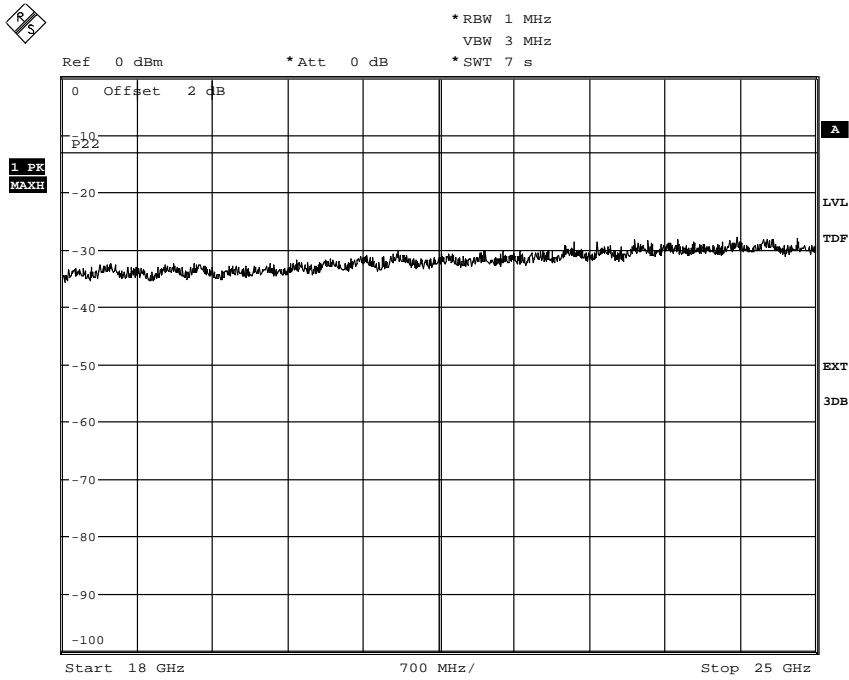

Date: 17.JAN.2011 12:16:13



FCC ID: TA8AKRC11864-2  
IC: 287AB-AS118642

Appendix 5.1

Diagram 2:

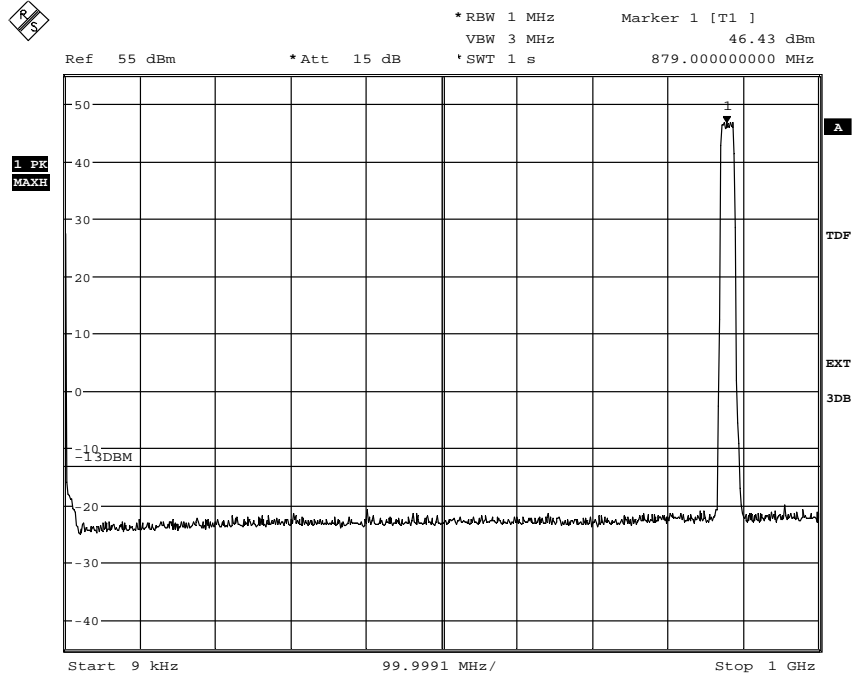

Date: 24.JAN.2011 16:12:34

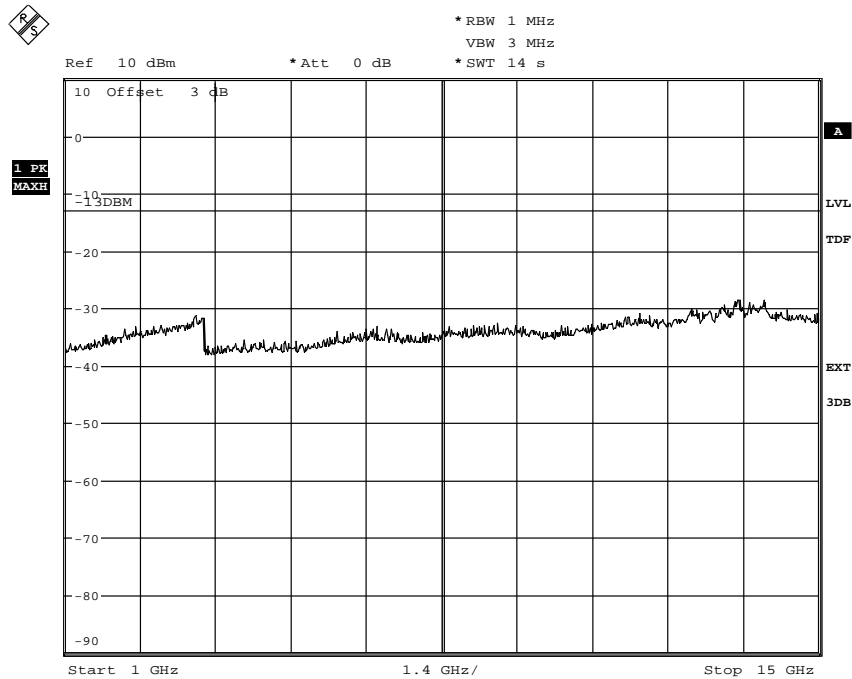

Date: 12.JAN.2011 14:23:08



FCC ID: TA8AKRC11864-2  
IC: 287AB-AS118642

Appendix 5.1

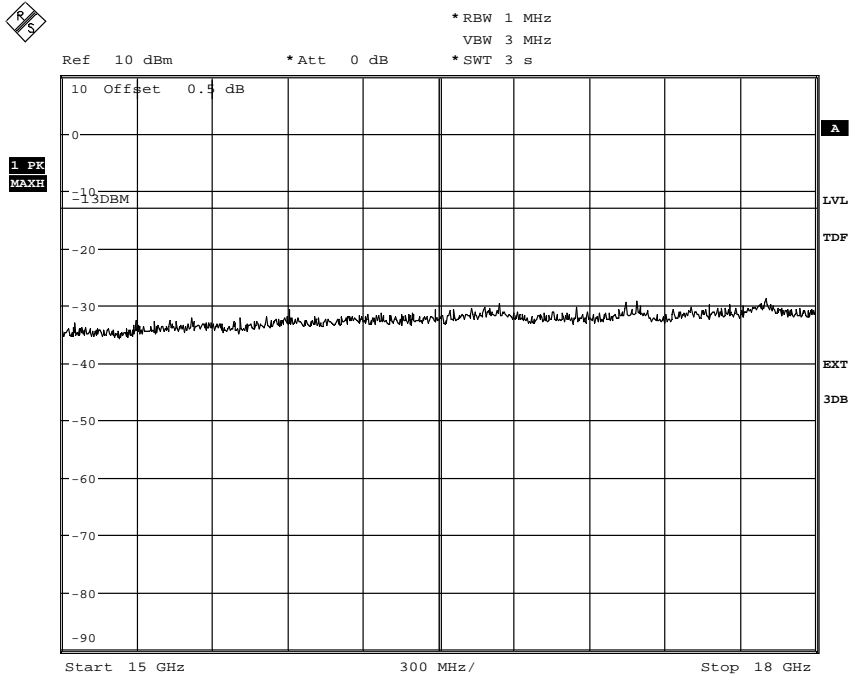

Date: 12.JAN.2011 14:20:31

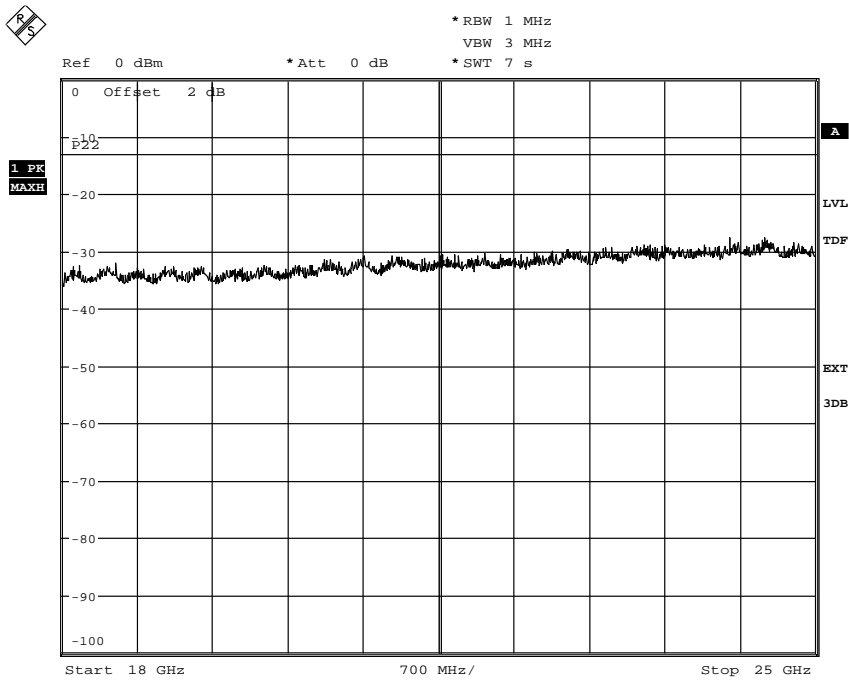

Date: 17.JAN.2011 12:43:54



FCC ID: TA8AKRC11864-2  
IC: 287AB-AS118642

Appendix 5.1

**Diagram 3:**

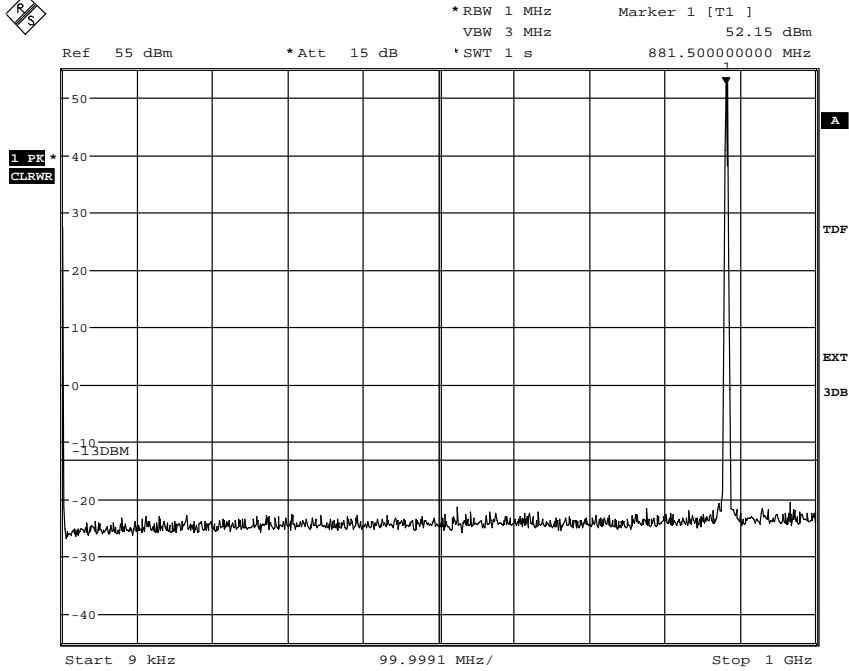

Date: 24.JAN.2011 15:23:53

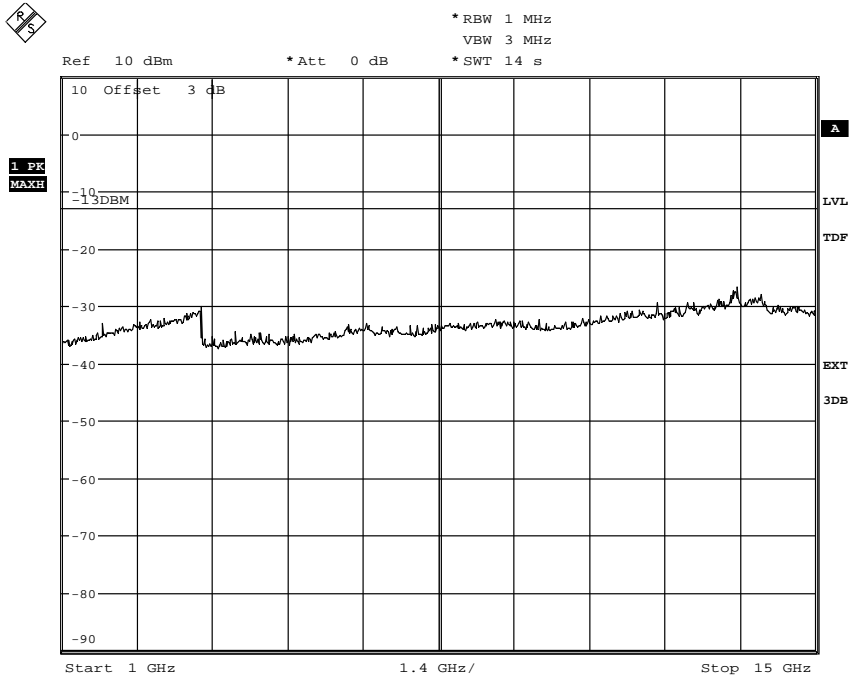

Date: 13.JAN.2011 08:55:56



FCC ID: TA8AKRC11864-2  
IC: 287AB-AS118642

Appendix 5.1

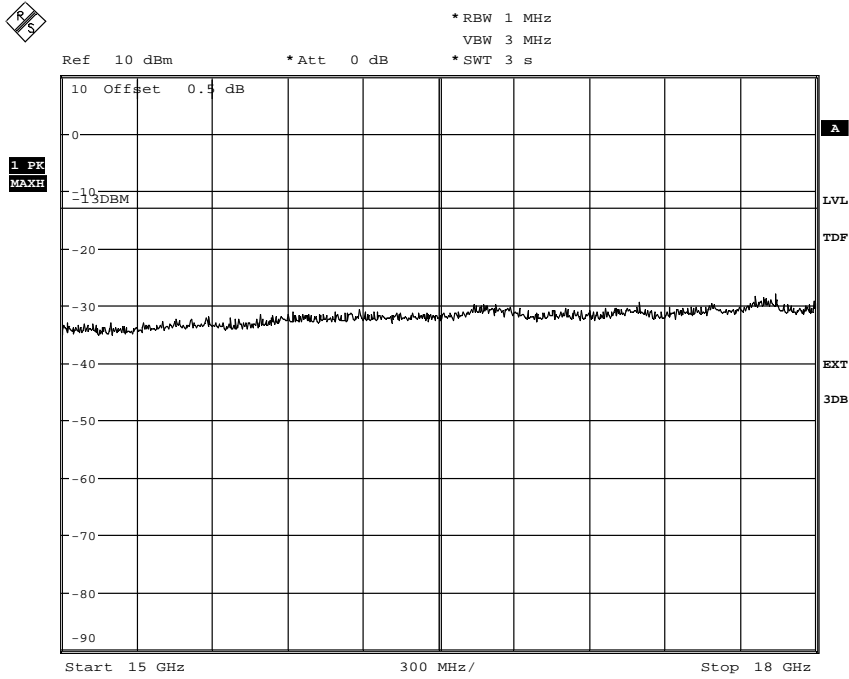

Date: 13.JAN.2011 08:59:13

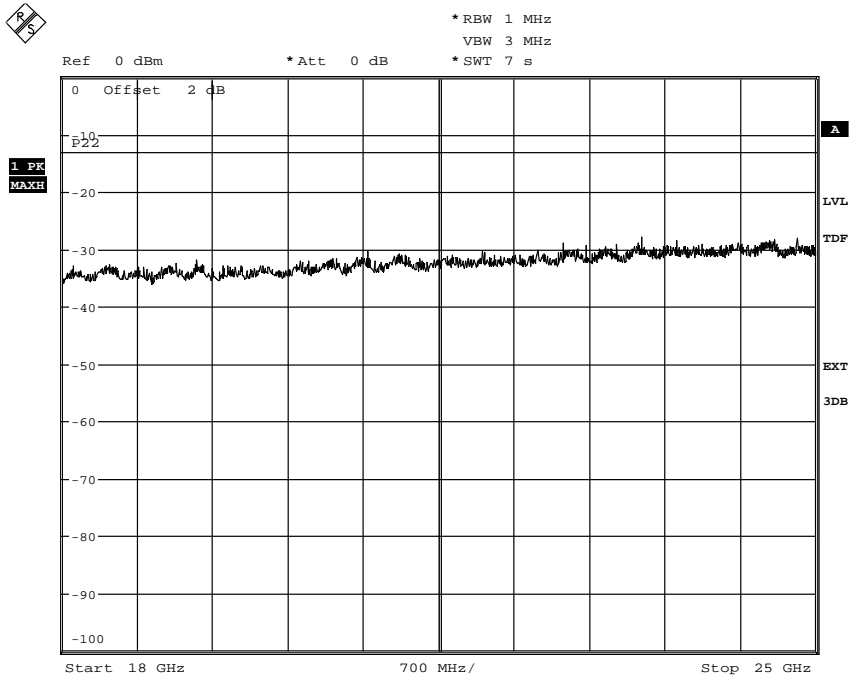

Date: 17.JAN.2011 10:00:42



FCC ID: TA8AKRC11864-2  
IC: 287AB-AS118642

Appendix 5.1

Diagram 4:

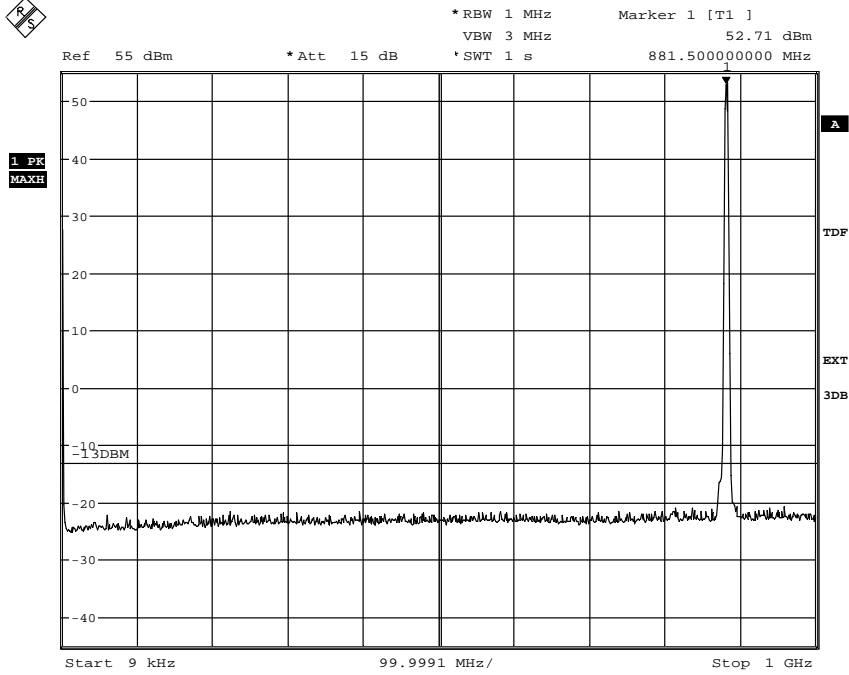

Date: 24.JAN.2011 15:05:44

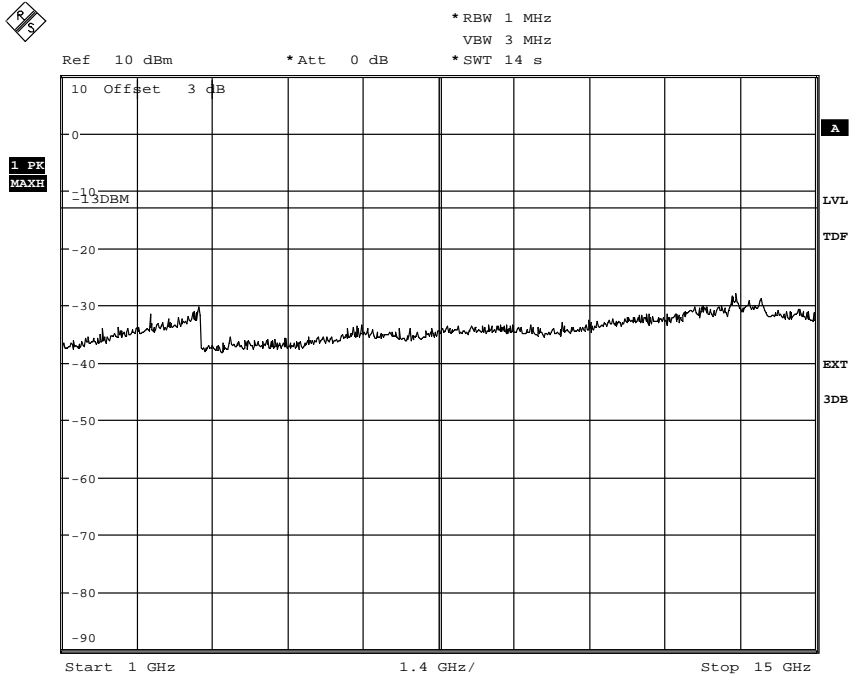

Date: 13.JAN.2011 13:45:37



FCC ID: TA8AKRC11864-2  
IC: 287AB-AS118642

Appendix 5.1

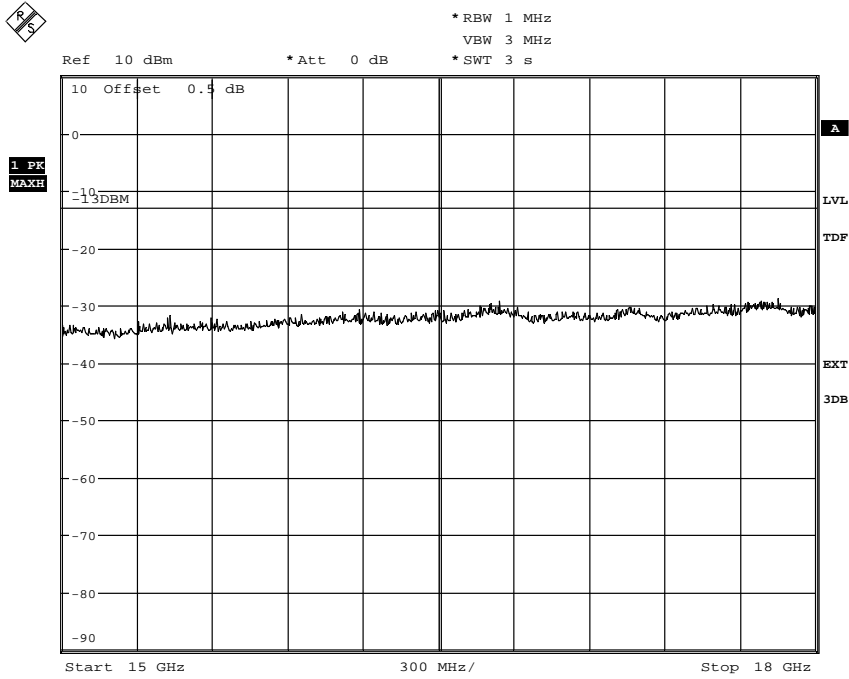

Date: 13.JAN.2011 09:30:10

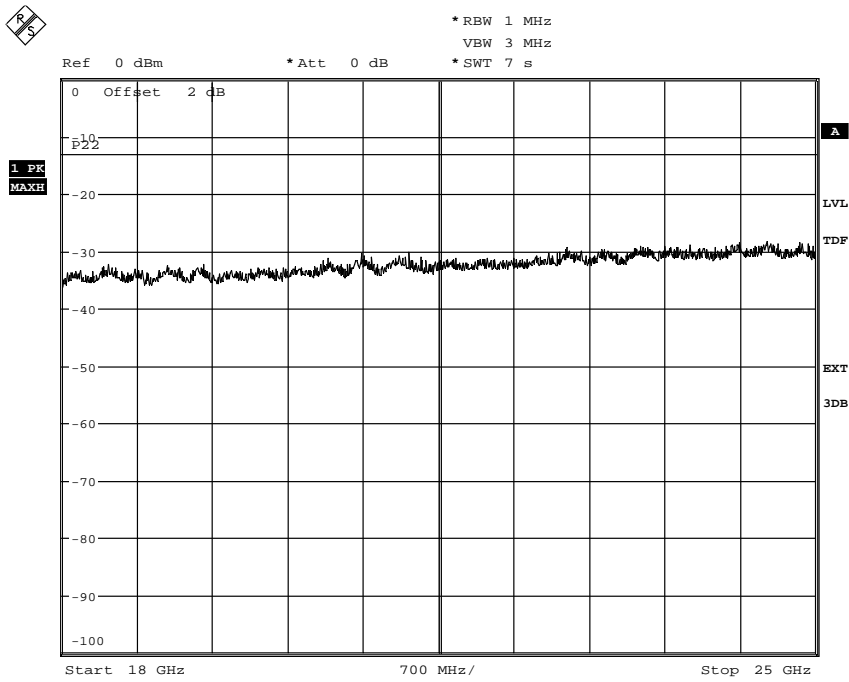

Date: 17.JAN.2011 10:17:04





FCC ID: TA8AKRC11864-2  
IC: 287AB-AS118642

Appendix 5.1

Diagram 5:

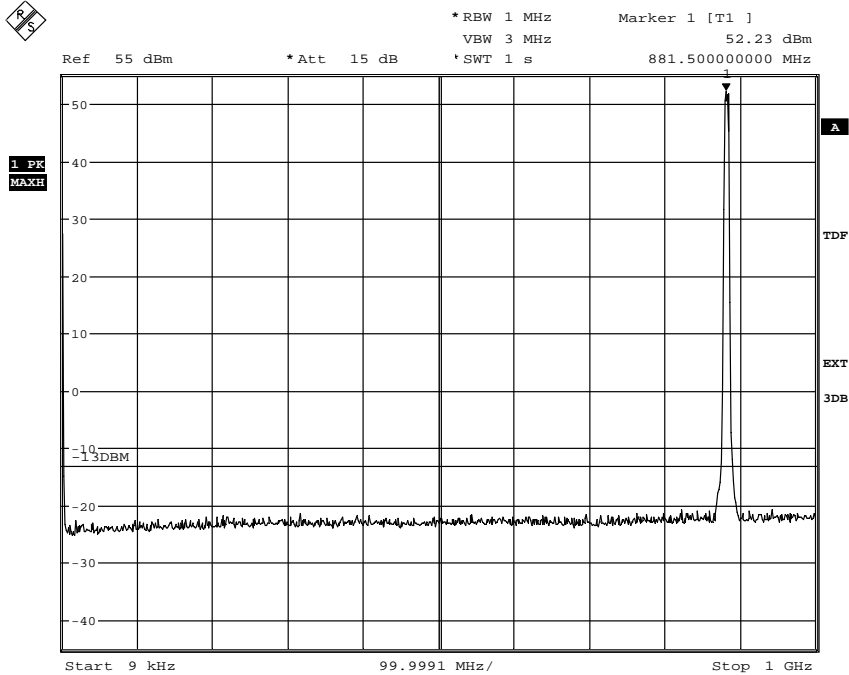

Date: 24.JAN.2011 14:50:42

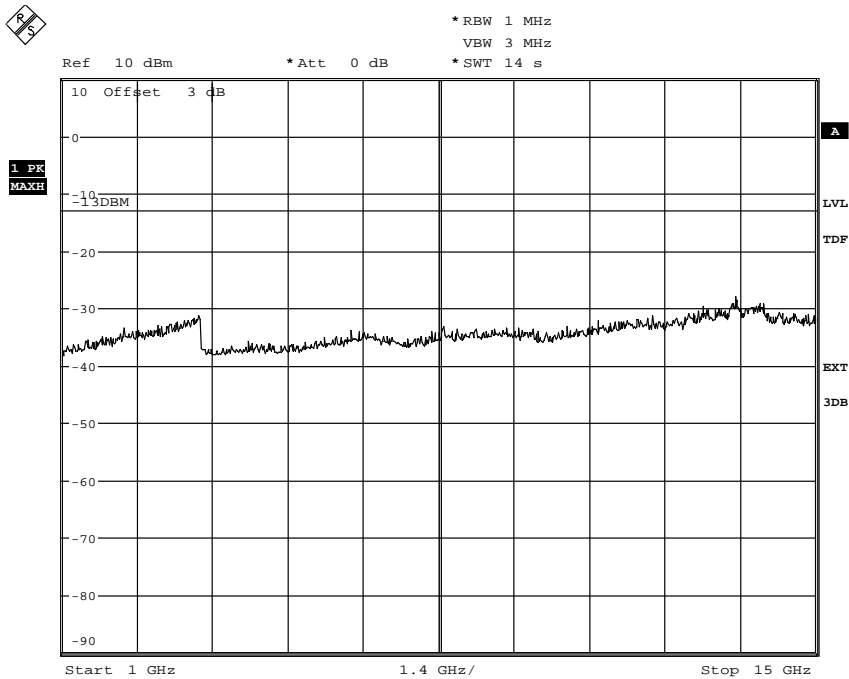

Date: 13.JAN.2011 10:24:09



FCC ID: TA8AKRC11864-2  
IC: 287AB-AS118642

Appendix 5.1

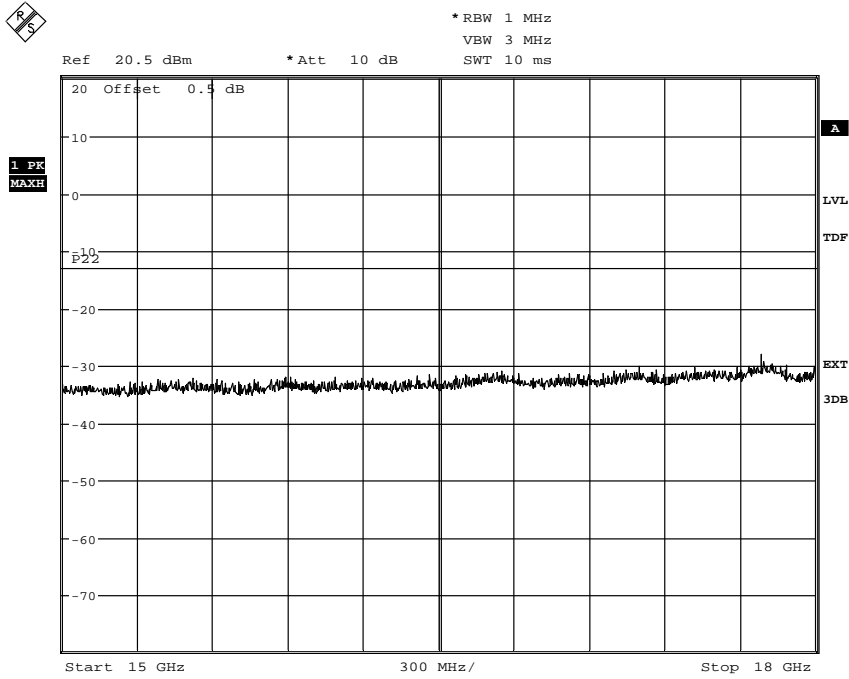

Date: 13.JAN.2011 10:29:21

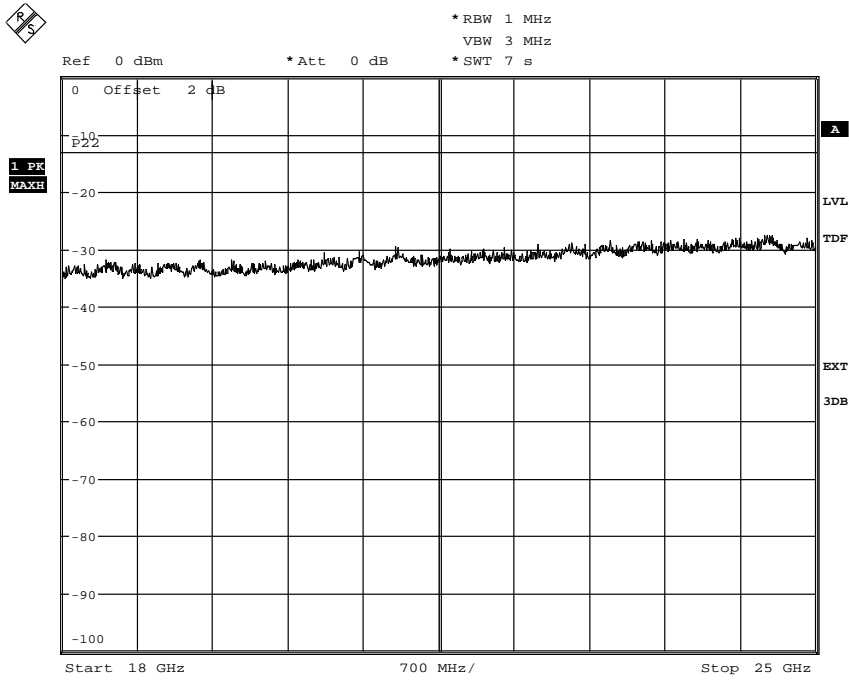

Date: 17.JAN.2011 10:26:44



FCC ID: TA8AKRC11864-2  
IC: 287AB-AS118642

Appendix 5.1

Diagram 6:

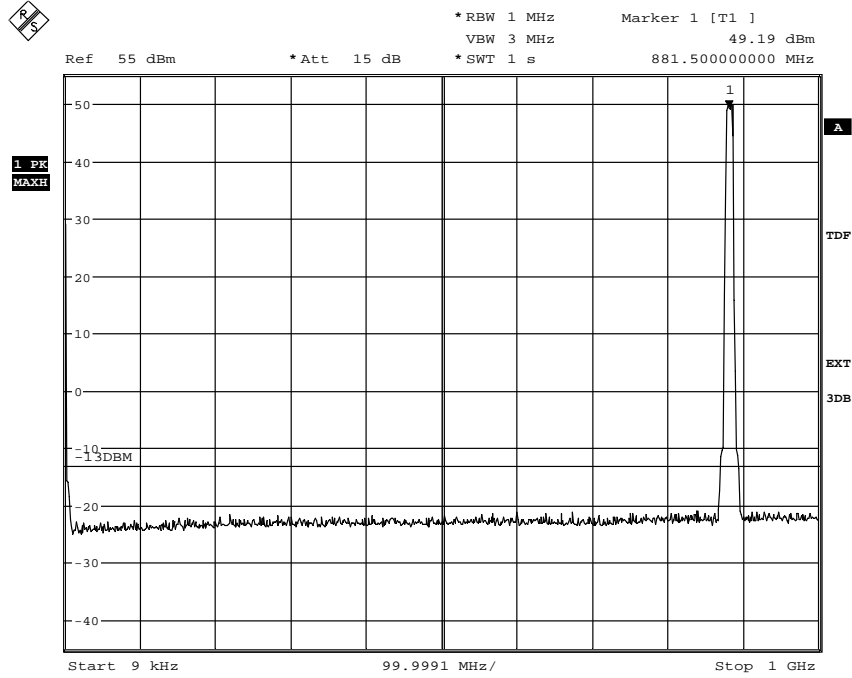

Date: 24.JAN.2011 13:17:10

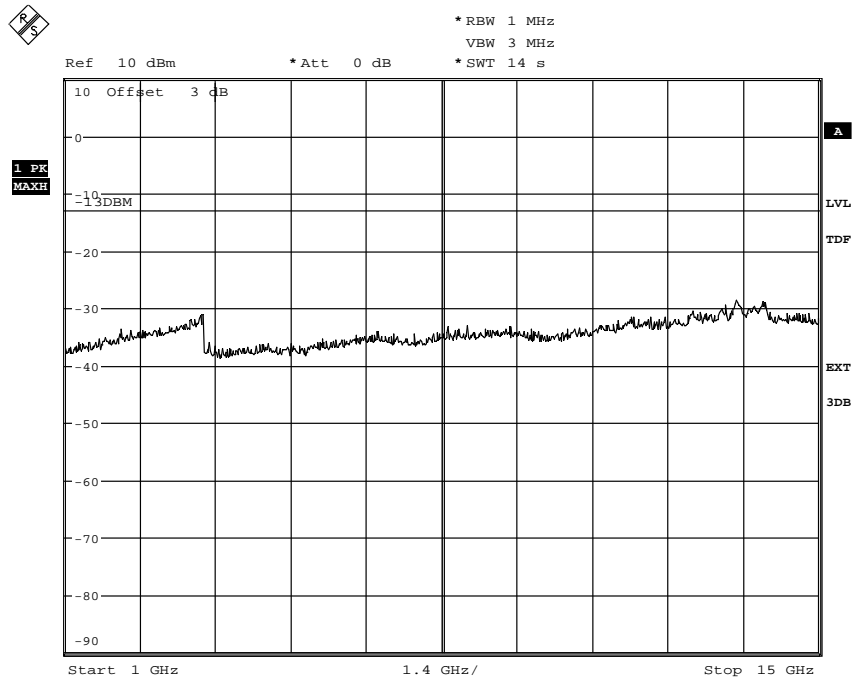

Date: 13.JAN.2011 10:47:43



FCC ID: TA8AKRC11864-2  
IC: 287AB-AS118642

Appendix 5.1

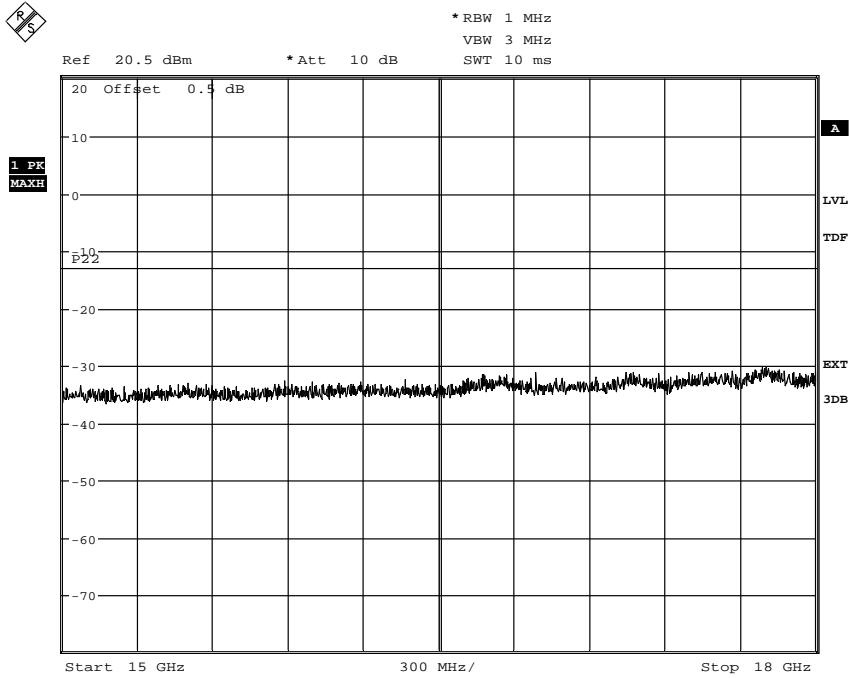

Date: 13.JAN.2011 10:44:04

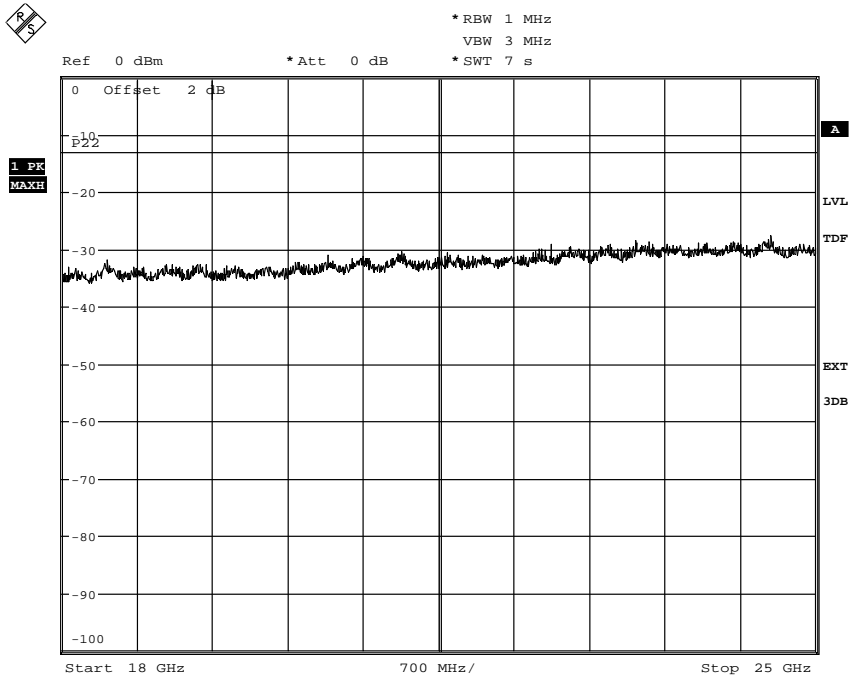

Date: 17.JAN.2011 10:43:03



FCC ID: TA8AKRC11864-2  
IC: 287AB-AS118642

Appendix 5.1

Diagram 7:

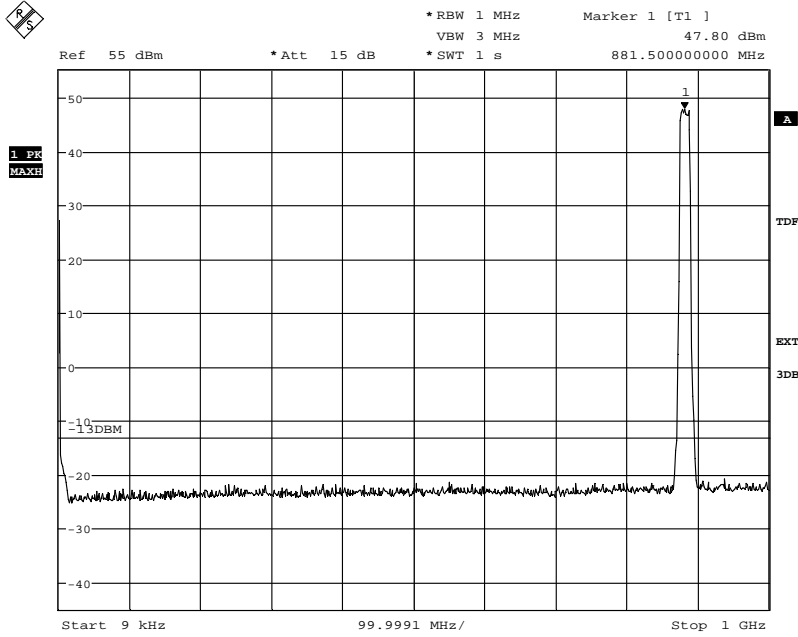

Date: 24.JAN.2011 13:04:18

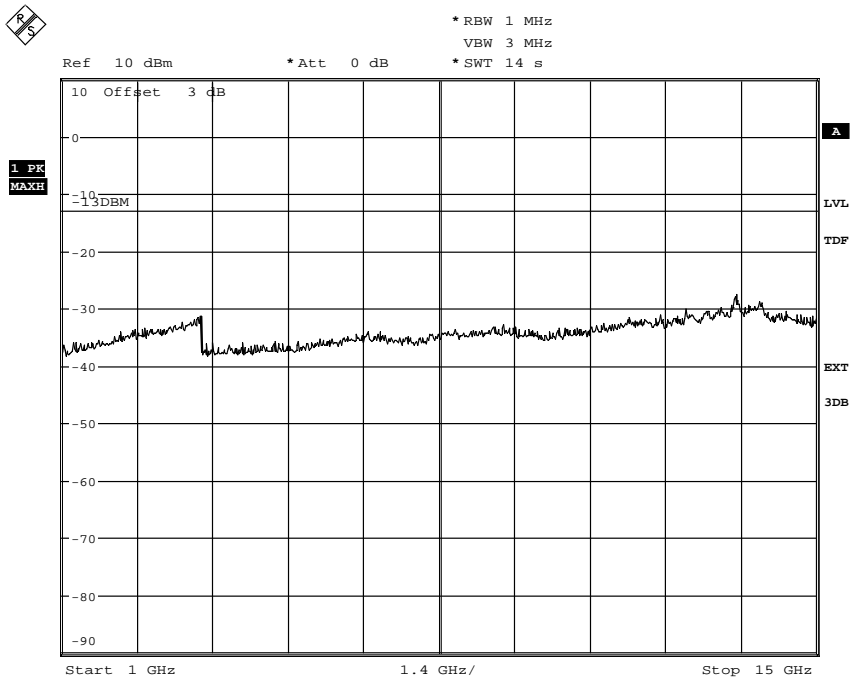

Date: 13.JAN.2011 12:56:10



FCC ID: TA8AKRC11864-2  
IC: 287AB-AS118642

Appendix 5.1

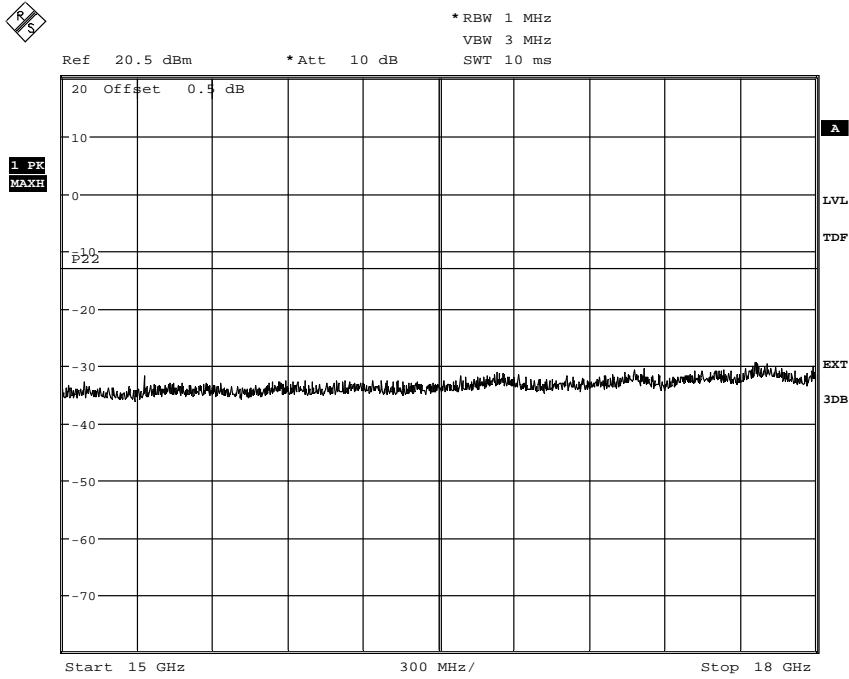

Date: 13.JAN.2011 12:59:51

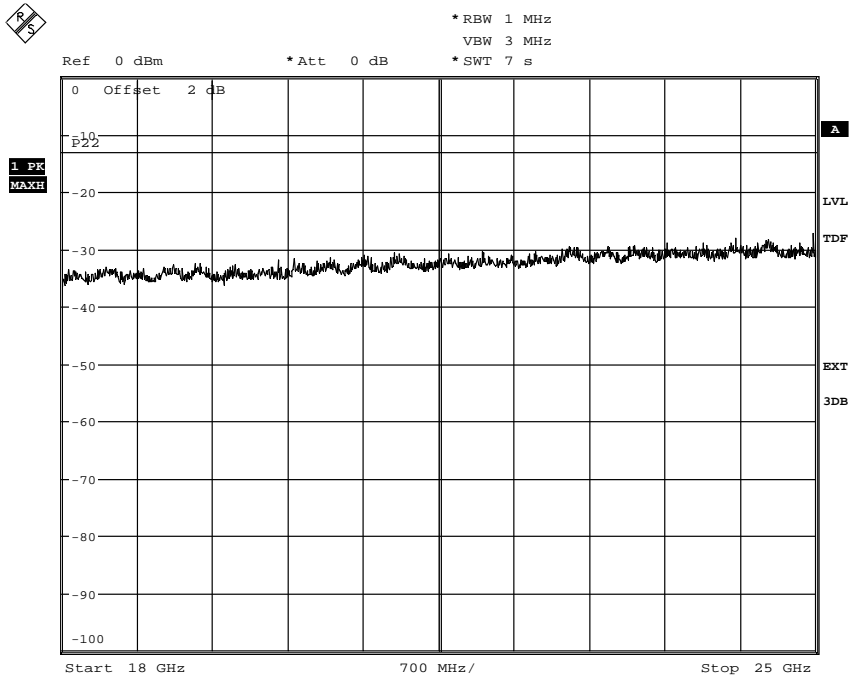

Date: 17.JAN.2011 11:23:22

FCC ID: TA8AKRC11864-2  
IC: 287AB-AS118642

Appendix 5.1

**Diagram 8:**

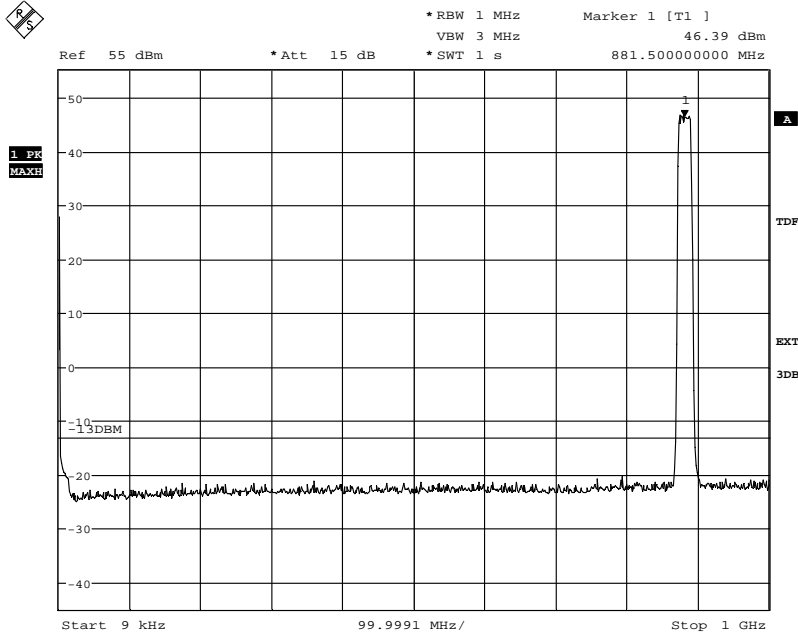

Date: 24.JAN.2011 12:50:45

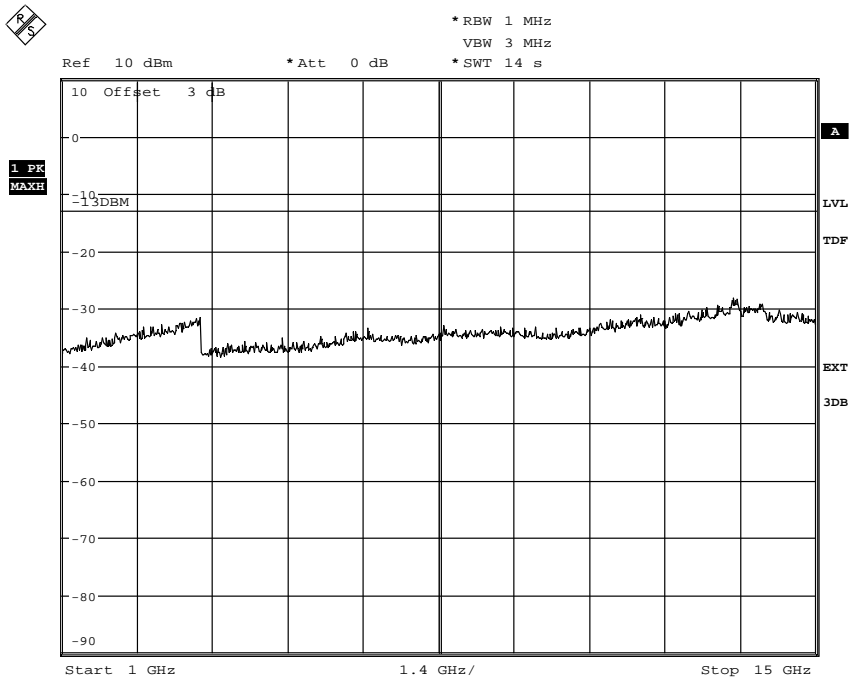

Date: 13.JAN.2011 14:12:15



FCC ID: TA8AKRC11864-2  
IC: 287AB-AS118642

Appendix 5.1

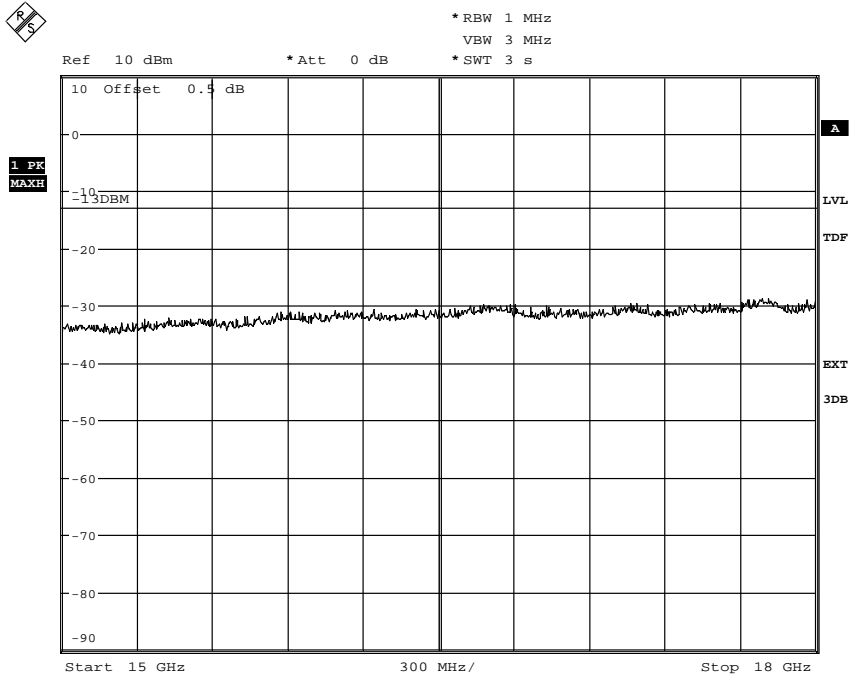

Date: 13.JAN.2011 14:15:32

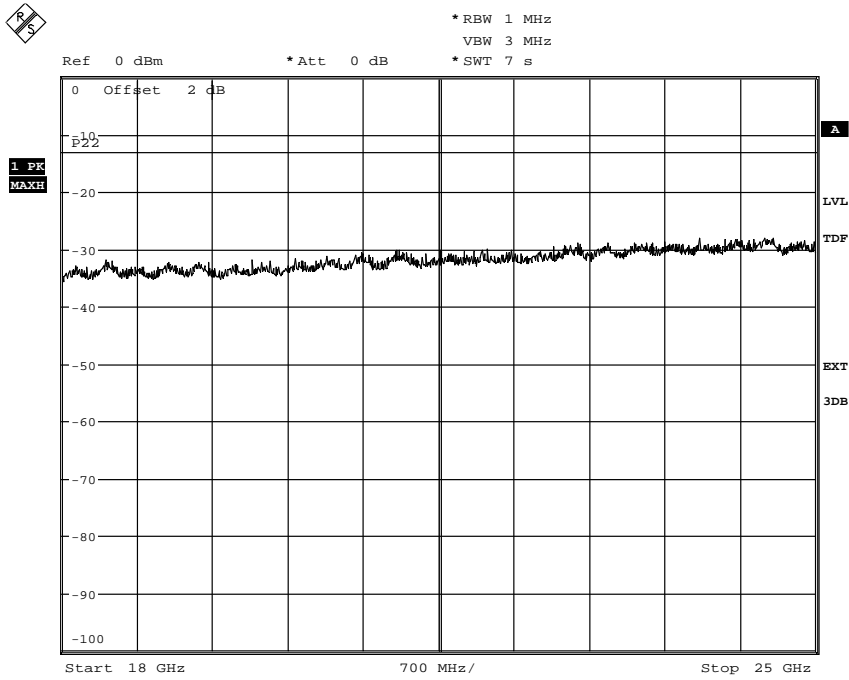

Date: 17.JAN.2011 11:15:31





FCC ID: TA8AKRC11864-2  
IC: 287AB-AS118642

Appendix 5.1

Diagram 9:

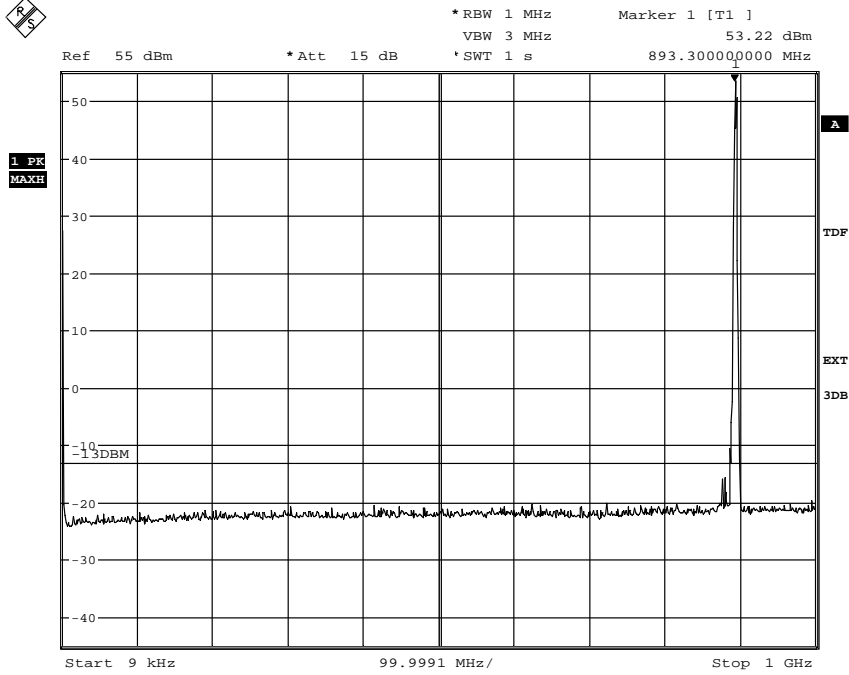

Date: 24.JAN.2011 16:04:05

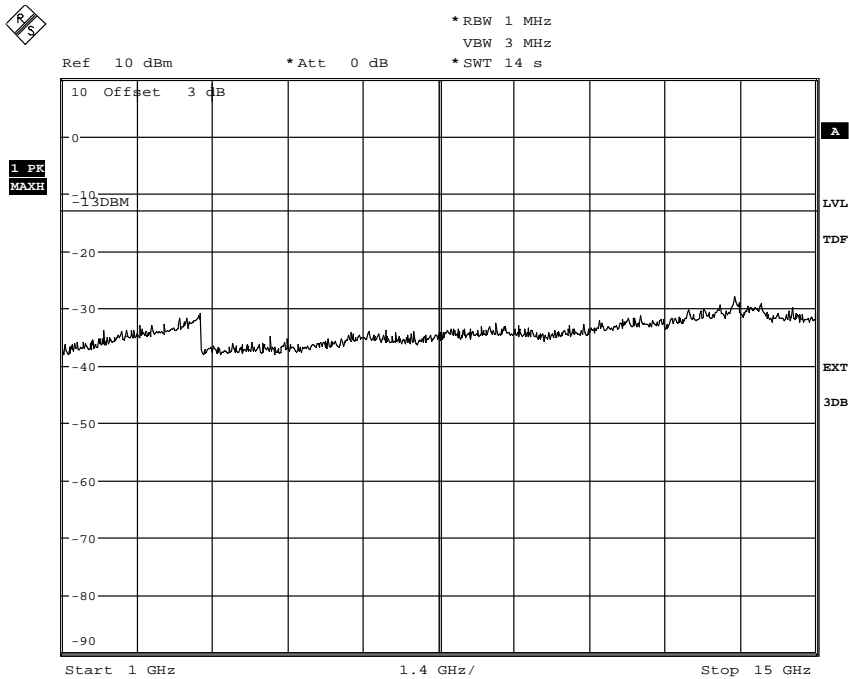

Date: 13.JAN.2011 15:54:10



FCC ID: TA8AKRC11864-2  
IC: 287AB-AS118642

Appendix 5.1

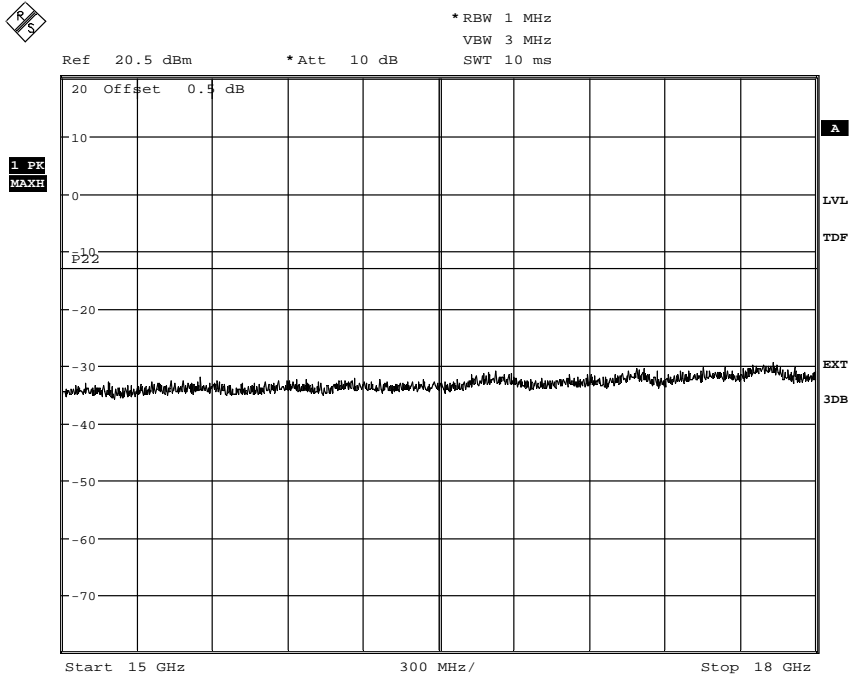

Date: 13.JAN.2011 15:57:51

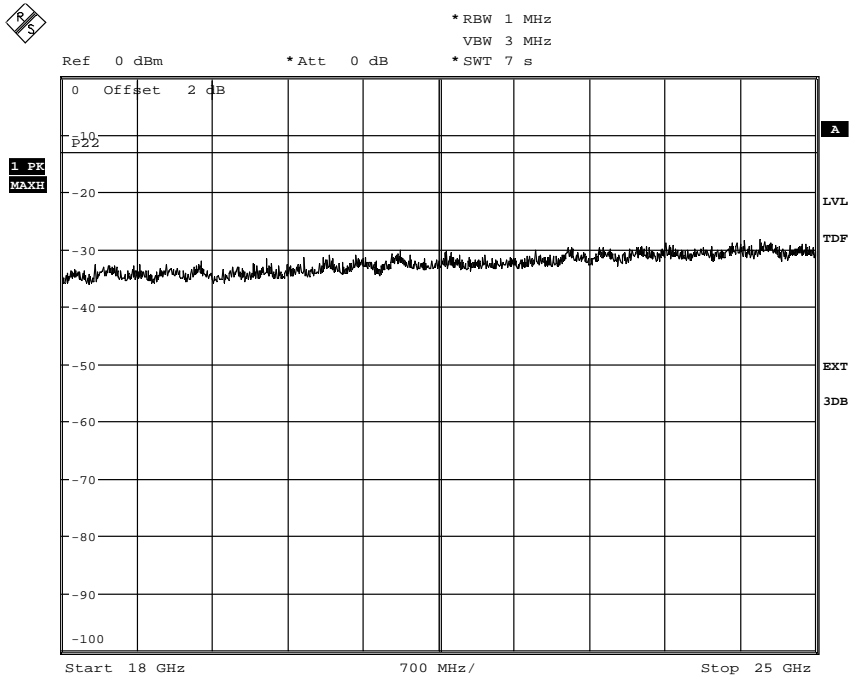

Date: 17.JAN.2011 12:32:44



FCC ID: TA8AKRC11864-2  
IC: 287AB-AS118642

Appendix 5.1

Diagram 10:

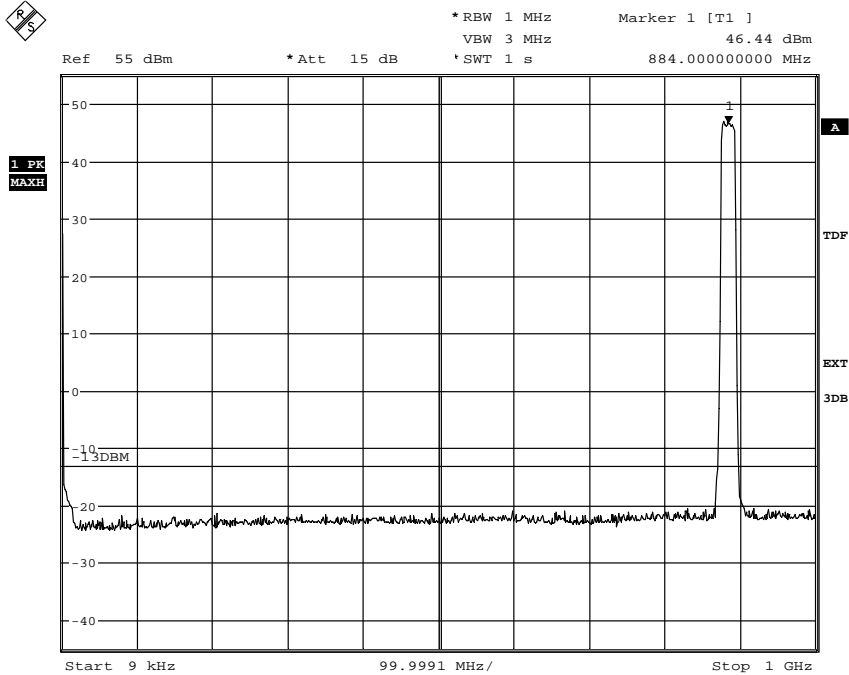

Date: 24.JAN.2011 16:23:09

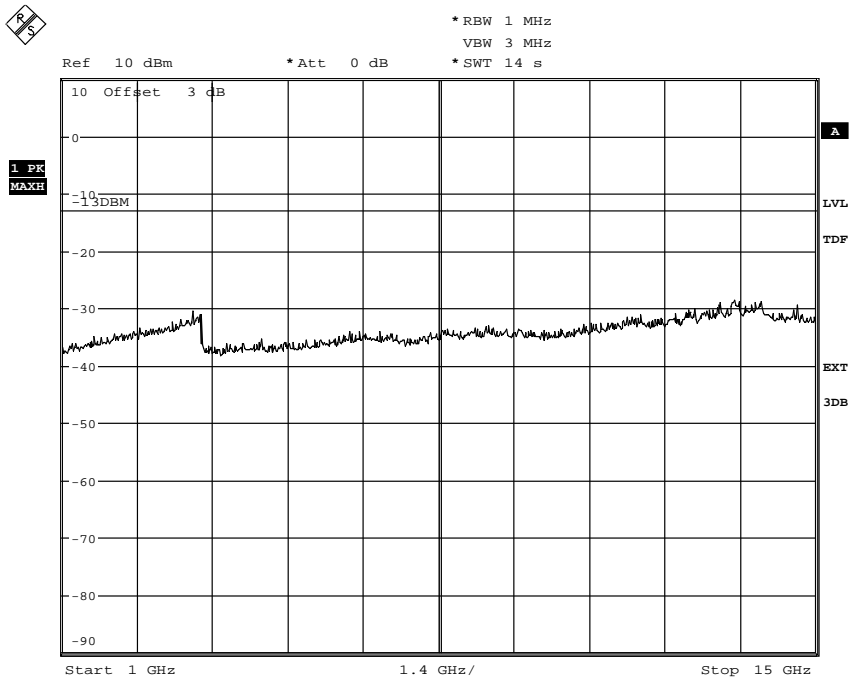

Date: 14.JAN.2011 09:48:46



FCC ID: TA8AKRC11864-2  
IC: 287AB-AS118642

Appendix 5.1

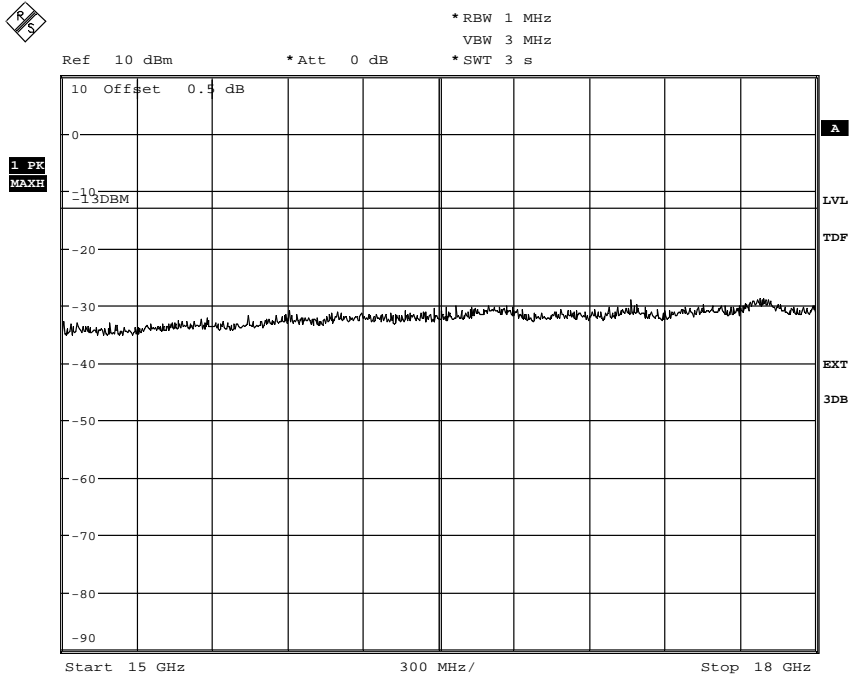

Date: 14.JAN.2011 09:51:55

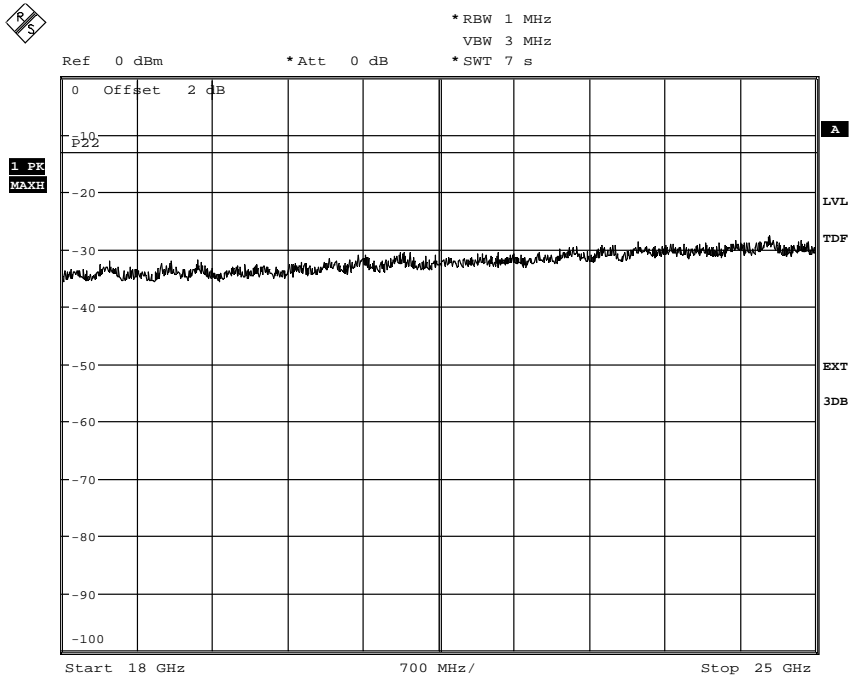

Date: 17.JAN.2011 12:54:55

FCC ID: TA8AKRC11864-2  
IC: 287AB-AS118642

Appendix 6

**Field strength of spurious radiation measurements according to 47 CFR 2.1053, 22.917 / IC RSS-132 4.5**

Date	Temperature	Humidity
2011-01-10	23 °C ± 3 °C	24 % ± 5 %
2011-01-11	23 °C ± 3 °C	21 % ± 5 %
2011-01-12	23 % ± 5 °C	21 % ± 5 %
2011-01-13	23 % ± 5 °C	17 % ± 5 %
2011-01-14	23 % ± 5 °C	19 % ± 5 %

**Test set-up and procedure**

The test sites are listed at FCC, Columbia with registration number: 93866. The test site complies with RSS-Gen, Industry Canada file no. 3482A-1.

The measurements were performed with both horizontal and vertical polarisation of the antenna. The antenna distance was 3 m in the frequency range 30 MHz – 15 GHz and 1m in the frequency range 15-25 GHz.

A pre-measurement was first performed:

In the frequency range 30 MHz-25 GHz the measurement was performed in power with a RBW of 1 MHz. A propagation loss in free space was calculated. The used formula was,

$$\gamma = 20 \log \left( \frac{4\pi D}{\lambda} \right), \gamma \text{ is the propagation loss and } D \text{ is the antenna distance.}$$

The measurement procedure was as the following:

1. The pre-measurement was first performed with peak detector. The EUT was measured in eight directions and with the antenna at three heights, 1.0 m, 1.5 m and 2.0 m.
2. Spurious radiation on frequencies closer than 20 dB to the limit is scanned 0-360 degrees and the antenna is scanned 1-4 m for maximum response. The emission is then measured with the average detector and the average value is reported, frequencies closer than 10 dB to the limit measured with the average detector was measured with the substitution method according to the standard.

Measurement equipment	SP number
Test site Tesla	503 881
R&S ESI 26	503 292
Control computer	503 479
Software: R&S EMC32, ver. 8.20.1	-
Chase Bilog antenna CBL 6111A	503 182
MITEQ Low Noise Amplifier	503 285
µComp Nordic Low Noise Amplifier	504 160
EMCO Horn Antenna 3115	502 175
Std.gain horn mod 20240-20	503 674
Std.gain horn	503 900
High pass filter 3-18 GHz	503 739
Testo 625 temperature and humidity meter	504 188

FCC ID: TA8AKRC11864-2  
IC: 287AB-AS118642

Appendix 6

The test set-up during the spurious radiation measurement is shown in the picture below:

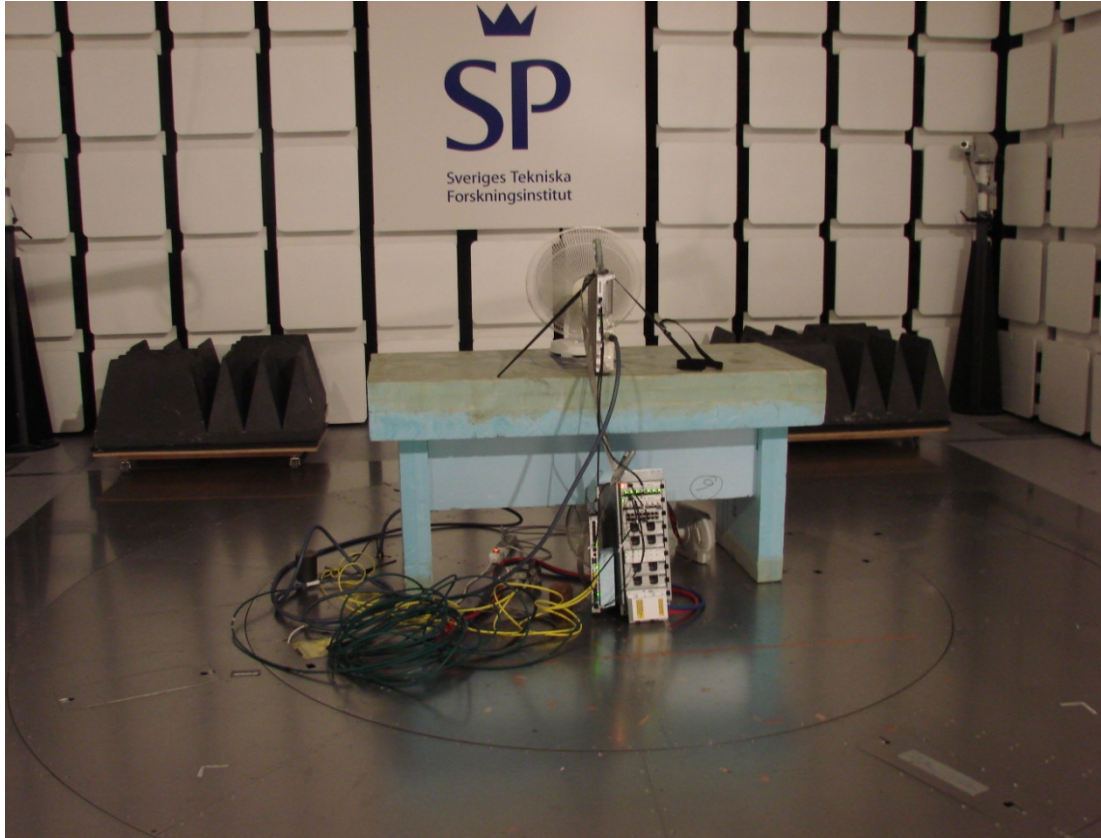

Note: The fans were required for thermal relief. The equipment lacks sufficient passive cooling capacity when tested stand-alone outside a RBS cabinet.

**Results**

Frequency (MHz)	Spurious emission level (dBm)	
	Vertical	Horizontal
30-25 000	All emission > 20 dB below limit	All emission > 20 dB below limit

**Measurement uncertainty:**

3.2 dB up to 18 GHz, 3.6 dB above 18 GHz

**Limits**

CFR 47, 22.917 / RSS-132 4.5:

The power of any emission outside the frequency band shall be attenuated below the transmitter power (P) by at least  $43 + 10 \log P$  dB.

Complies?	Yes
-----------	-----

FCC ID: TA8AKRC11864-2  
IC: 287AB-AS118642

Appendix 7

**Frequency stability measurements according to 47 CFR 2.1055, 22.355 /  
IC RSS-132 4.3**

Date	Temperature	Humidity
2011-01-19	23 °C ± 3 °C	26 % ± 5 %
2011-01-20	23 °C ± 3 °C	23 % ± 5 %
2011-01-21	23 °C ± 3 °C	28 % ± 5 %

**Test set-up and procedure**

The measurement was made per 3GPP TS 36.141. The output was connected to a spectrum analyzer. The spectrum analyzer was connected to an external 10 MHz reference standard during the measurements.

Measurement equipment	SP number
Climate chamber 2	501 031
Rohde & Schwarz signal analyzer FSQ40	504 143
RF attenuator	504 159
Testo 635 temperature and humidity meter	504 203
Testo 625 temperature and humidity meter	504 188
Rotronic temperature and humidity meter	502 946
Multimeter Fluke 87	502 190

FCC ID: TA8AKRC11864-2  
IC: 287AB-AS118642

Appendix 7

**Results**

Nominal transmitter frequency was 881.5 MHz in channel bandwidth configuration 1.4 MHz.  
Rated output power level at connector RF A (maximum): 47.8 dBm (60 W).

Test conditions		Frequency error (Hz)
Supply voltage DC (V)	T (°C)	Test model E-TM1.1
-48.0	+20	+2
-55.2	+20	+3
-40.8	+20	+3
-48.0	+30	-4
-48.0	+40	-2
-48.0	+50	-2
-48.0	+10	-2
-48.0	0	TX disabled (Note 1)
-48.0	-10	N.T.
-48.0	-20	N.T.
-48.0	-30	N.T.
Maximum freq. error (Hz)		-4
Measurement uncertainty		$< \pm 1 \times 10^{-7}$

Note 1: The test object firmware successfully disabled TX transmission outside the temperature range specified by the manufacturer.

**Remark**

It was deemed sufficient to test one combination of TX frequency, channel bandwidth configuration and test model (modulation), as all combinations share a common reference to derive the TX frequency from.

**Limits**

According to 3GPP TS 36.141, section 6.5.1.5:  
The frequency error shall be within  $\pm(0.05 \text{ PPM} + 12 \text{ Hz})$  ( $\pm 56.075 \text{ Hz}$ ).

CFR 47, 22.355 / RSS-132 4.3:  
The frequency error shall be within  $\pm(1.5 \text{ PPM} + 12 \text{ Hz})$  ( $\pm 1322.25 \text{ Hz}$ ).

Complies?	Yes
-----------	-----





FCC ID: TA8AKRC11864-2  
IC: 287AB-AS118642

Appendix 8

**Receiver spurious emissions measurements according 47 CFR 15.111 / RSS-132 4.6**

Date 2011-01-14	Temperature 22 °C ± 3 °C	Humidity 14 % ± 5 %
--------------------	-----------------------------	------------------------

**Test set-up and procedure**

The measurements were performed according to ANSI C63.4.

Measurements were performed on port “RF B” in the RX configuration corresponding to the worst case TX set-up (E-TM 1.1, BW 1.4 MHz). The measurement was first performed with a peak detector. Emission on frequencies close to or above the limit was re-measured with quasi-peak detector below 1 GHz and with average detector above 1GHz.

During the measurement at the receiver port “RF B” the combined TX/RX port “RF A” was active at maximum power at the TX band center frequency with test model E-TM1.1 in channel bandwidth configuration 1.4 MHz and the port was terminated into 50 ohm.

Measurement equipment	SP number
Rohde & Schwarz FSQ40	504 143
RF attenuator (RF A)	504 159
Testo 615 temperature and humidity meter	503 498

**Result**

The results are shown in appendix 8.1:

	Tested port, measurement range, RX frequency
Diagram 1	RX B, 30 MHz – 12.5 GHz, B
Diagram 2	RX B, 30 MHz – 12.5 GHz, M
Diagram 3	RX B, 30 MHz – 12.5 GHz, T

**Remark**

It was deemed sufficient to measure RX conducted emissions with only the worst case TX configuration.

The upper frequency bound 12.5 GHz was chosen to cover 5x 2.4576 GHz, the highest frequency used in the test object as declared by the client.

A sweep with PK detector and 1 MHz RBW for the complete range 30 MHz – 12.5 GHz showed compliance to the applicable limit, no further verification was deemed necessary.

Limit lines in plots show the most conservative aggregate limit.

**Limits**

CFR 47, 15.111:

The power of any spurious output signals appearing at the antenna terminals must not exceed -57 dBm (2 nanowatt).

RSS-132 4.6 refers to RSS-Gen:

The power of any spurious output signals appearing at the antenna terminals must not exceed -57 dBm (2 nanowatt) within 30 MHz to 1 GHz and -53 dBm above 1 GHz.

Emission below limit?	Yes
-----------------------	-----





FCC ID: TA8AKRC11864-2  
IC: 287AB-AS118642

Appendix 8.1

Diagram 3:

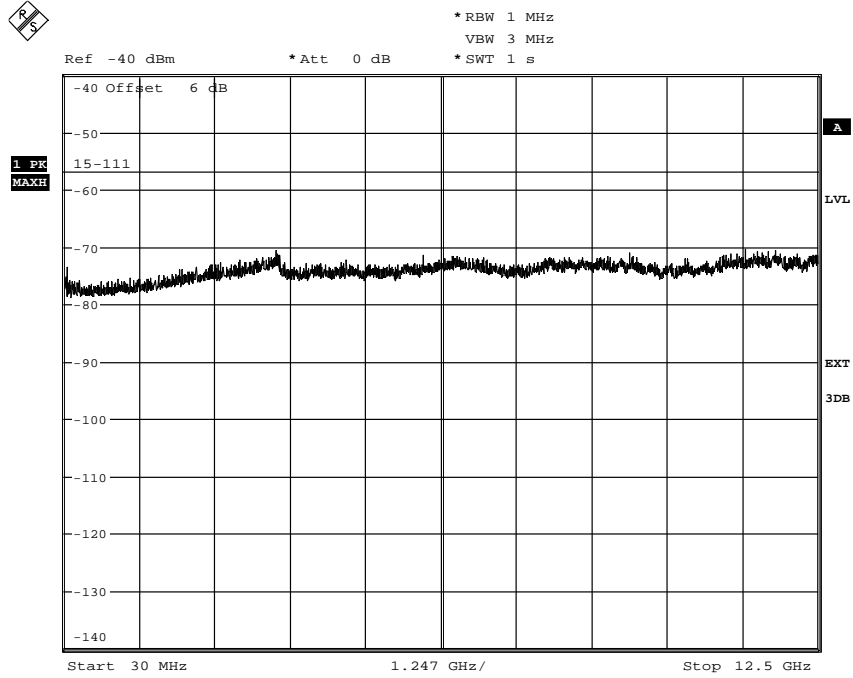

Date: 14.JAN.2011 12:26:01

FCC ID: TA8AKRC11864-2  
IC: 287AB-AS118642

Appendix 9

**External photos of the test object**

Note: The pictures show the sample used for radiated tests.

Front side



Rear side

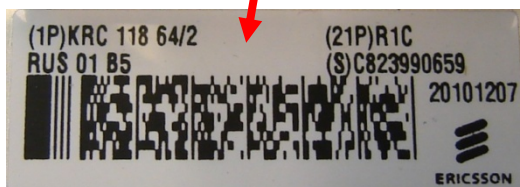
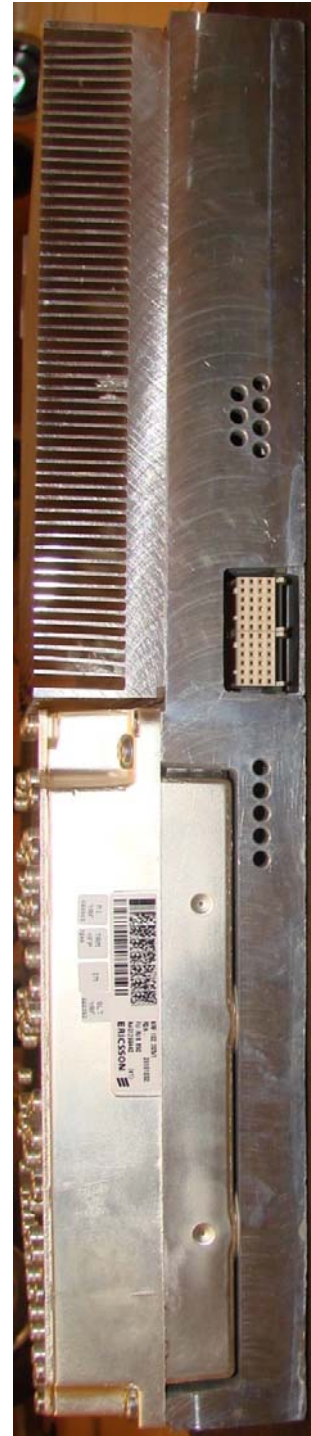

FCC ID: TA8AKRC11864-2  
IC: 287AB-AS118642

Appendix 9

Left side

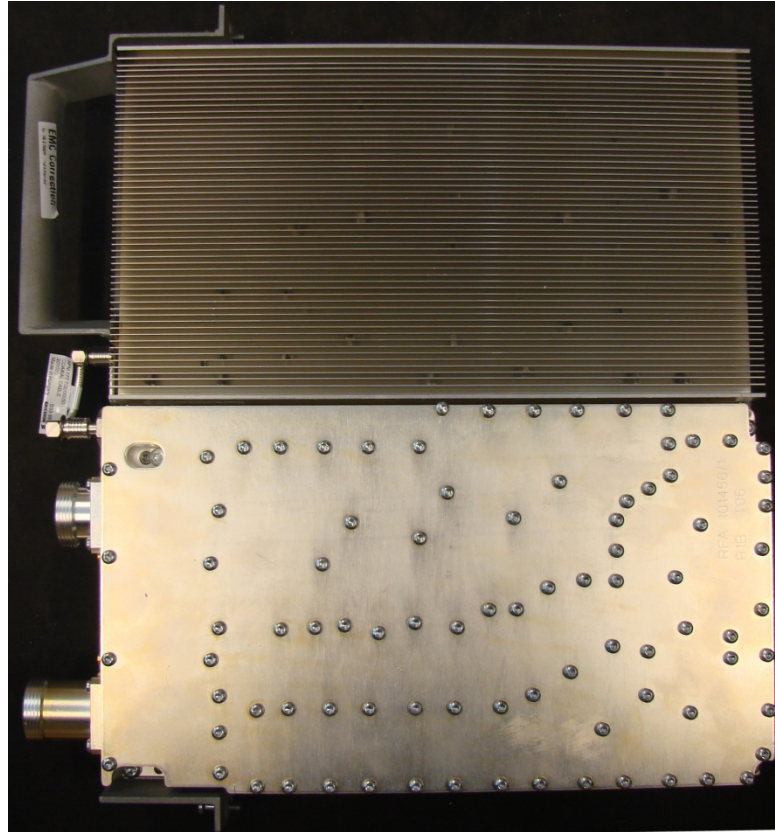

Right side

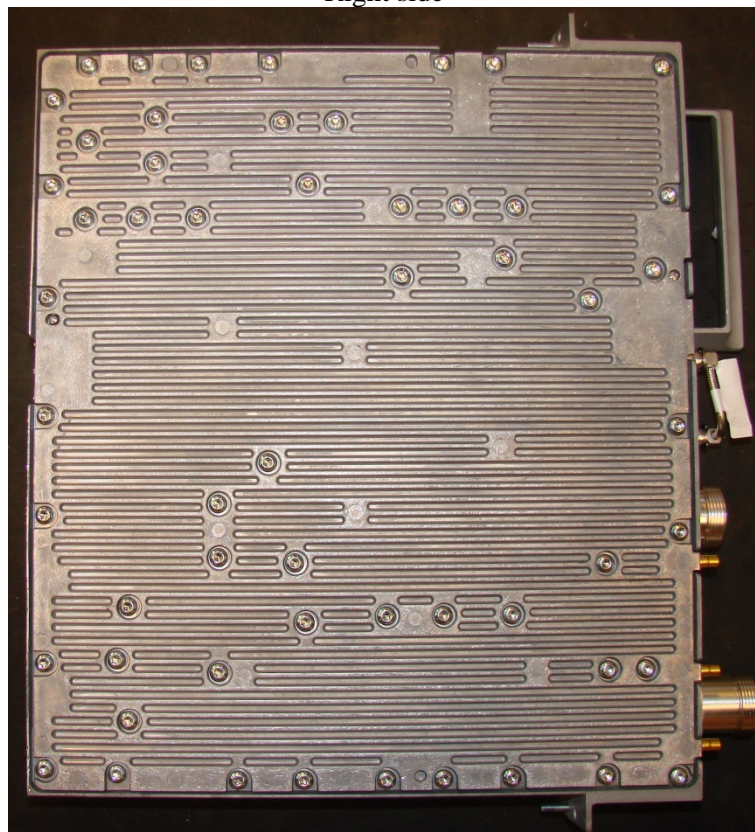

FCC ID: TA8AKRC11864-2  
IC: 287AB-AS118642

Appendix 9

Bottom side



Top side

