



REPORT

issued by an FCC listed Laboratory Reg. no. 93866.
The test site complies with RSS-Gen, file no: IC 3482A

Date
2010-10-15

Reference
FX015925-F22

Page
1 (2)



Handled by, department
Jonas Bremholt
Electronics
+46 (0)10 516 5438, jonas.bremholt@sp.se

Ericsson AB
Anders Johansson
PDU Radio Base Station
164 80 Stockholm

Radio measurements on RUS 01 B5 WCDMA 850 MHz radio equipment with FCC ID: TA8AKRC11864-1 and IC: 287AB-AS118641

(9 appendices)

Test object

RUS 01 B5, (1P)KRC 118 64/1, (21P)R1A

Summary

Standard	Compliant	Appendix
FCC CFR 47 / IC RSS-132 Issue 2		
2.1046 / RSS-132 4.4 RF power output	Yes	2
2.1049 / RSS-Gen 4.6.1 Occupied bandwidth	Yes	3
2.1051 / RSS-132 4.5 Band edge	Yes	4
2.1051 / RSS-132 4.5 Spurious emission at antenna terminals	Yes	5
2.1053 / RSS-132 4.5 Field strength of spurious radiation	Yes	6
2.1055 / RSS-132 4.3 Frequency stability	Yes	7
FCC CRF 47 / Industry Canada RSS-132 Issue 2		
15.111 / RSS-132 4.6 Receiver spurious emissions	Yes	8

Note: Above RSS-132 items are given as cross-reference only. Measurements were performed according to ANSI procedures referenced by FCC and covered by SP's accreditation.

SP Technical Research Institute of Sweden Electronics - EMC

Christer Karlsson
Technical Manager

Jonas Beremholt
Technical Officer

SP Technical Research Institute of Sweden

Postal address
SP
Box 857
SE-501 15 Borås
SWEDEN

Office location
Västeråsen
Brinellgatan 4
Borås

Phone / Fax / E-mail
+46 105 16 50 00
+46 33 13 55 02
info@sp.se

Laboratories are accredited by the Swedish Board for Accreditation and Conformity Assessment (SWEDAC) under the terms of Swedish legislation. This report may not be reproduced other than in full, except with the prior written approval of the issuing laboratory.



REPORT

FCC ID: TA8AKRC11864-1
IC: 287AB-AS118641

Table of contents

Description of the test object	Appendix 1
Operation mode during measurements	Appendix 1
Test setups	Appendix 1
Purpose of test	Appendix 1
RF power output	Appendix 2
Occupied bandwidth	Appendix 3
Band edge	Appendix 4
Spurious emission at antenna terminals	Appendix 5
Field strength of spurious radiation	Appendix 6
Frequency stability	Appendix 7
Receiver spurious emissions	Appendix 8
External photos	Appendix 9

FCC ID: TA8AKRC11864-1
IC: 287AB-AS118641

Appendix 1

Description – Test object

Equipment: WCDMA radio equipment (RUS) 850 MHz single and multi carrier.

Frequency range: TX: 871.4 – 891.6 MHz
RX: 826.4 – 846.6 MHz

Modulations: QPSK, 16QAM and 64QAM

Nominal output power: Single carrier: 1x 47.8 dBm (1x 60W)
(Maximum) Multi carrier: 2x 44.8 dBm (2x 30W)
4x 41.8 dBm (4x 15W)

Channel bandwidth: 4.2 to 5 MHz (configurable in steps of 100/200 kHz)

Channel spacing: 4.4 to 5 MHz (configurable in steps of 100/200 kHz)

Nominal power voltage: -48 VDC

Tested channels

Channel	Downlink		Uplink	
	Frequency*	UARFCN	Frequency*	UARFCN
B	871.4	4357	826.4	4132
B+5	876.4	4382	831.4	4157
B+10	881.4	4407	836.4	4182
B+15	886.4	4432	841.4	4207
M	881.6	4408	836.6	4183
T-15	876.6	4383	831.6	4158
T-10	881.6	4408	836.6	4183
T-5	886.6	4433	841.6	4208
T	891.6	4458	846.6	4233

* Frequency in MHz

Operation mode during measurements

Measurements were performed with the test object transmitting the Test models which are defined in 3GPP TS 25.141. Test model 1 (TM1) uses the QPSK modulation only, Test model 5 (TM5) includes the 16QAM modulation and Test model 6 (TM6) includes the 64QAM modulation.

The settings below were found to be representative for all traffic scenarios when several settings with the different modulations, channel bandwidths and the number of carriers were tested to find the worst case setting. These settings were used for all measurements if not otherwise noted.

Single carrier

TM1: 64 DPCH:s at 30 ksps (SF=128)

Multi carrier

TM1: 32 DPCH:s at 30 ksps (SF=128) in each carrier (Two carrier mode)

Channel bandwidth 5 MHz

Conducted measurements

The test object was powered with -48 VDC. All RF conducted measurements were performed with the test object configured for maximum transmit power. All TX measurements were done at the RF A connector and the RX measurements were done on the RF B connector.



FCC ID: TA8AKRC11864-1
IC: 287AB-AS118641

Appendix 1

Radiated measurements

The test object was powered with -48 VDC. All measurements were performed with the test object configured for maximum transmit power. The configuration represents worst case for radiated spurious emission measurements.

The RF output power port was via a RF attenuator connected to functional test equipment for supervision.

The RUS unit was allocated to the following UARFCN:

Single Carrier: (One carrier configuration)

Cell	1	1	1
Channel	B	M	T

Multi Carrier: (Two carrier configuration)

Cell	1	2	1	2
Channel	B	B+10	T-10	T

Multi Carrier: (Four carrier configuration)

Cell	1	2	3	4
Channel	B	B+5	B+10	B+15
Channel	T	T-5	T-10	T-15

Purpose of test

The purpose of the tests is to verify compliance to the performance characteristics specified in applicable items of FCC CFR 47 and Industry Canada RSS-132.

References

Measurements were done according to relevant parts of the following standards:

- ANSI 63.4-2003
- ANSI/TIA/EIA-603-B-2002
- CFR 47 part 2, October 1st, 2009
- CFR 47 part 22, October 1st, 2009
- 3GPP TS 25.141, version 8.9.0
- RSS-Gen Issue 2
- RSS-132 Issue 2

FCC ID: TA8AKRC11864-1
IC: 287AB-AS118641

Appendix 1

Measurement equipment

Measurement equipment	Calibration Due	SP number
Test site Tesla	2010-10	503 881
R&S FSIQ 40	2011-07	503 738
R&S FSQ 40	2011-07	504 143
R&S ESI 26	2011-07	503 292
High pass filter, 1-15 GHz	2011-07	504 199
RF attenuator 40 dB	2011-06	504 159
RF step attenuator	2012-07	503 096
Boonton RF Peak power meter/analyzer	2010-10	503 144
Boonton Power sensor 56518-S/4	2012-02	503 146
Chase Bilog antenna CBL 6111A	2011-10	502 181
EMCO Horn Antenna 3115	2011-01	502 175
µComp Nordic, Low Noise Amplifier	2011-07	504 160
Climate chamber 2	2010-11	501 031
Multimeter Fluke 87	2011-03	502 190
Testo 625, Temperature and humidity meter	2011-08	504 188
Testo 635 temperature and humidity meter	2011-03	504 203

Reservation

The test results in this report apply only to the particular test object as declared in the report.

Delivery of test object

The test object was delivered 2010-09-23

Test engineers

Tomas Lennhager, Jörgen Wassholm and Jonas Bremholt

Test participant

Samir Catic, Ericsson AB

FCC ID: TA8AKRC11864-1
IC: 287AB-AS118641

Appendix 1

Test set-up conducted measurements TX

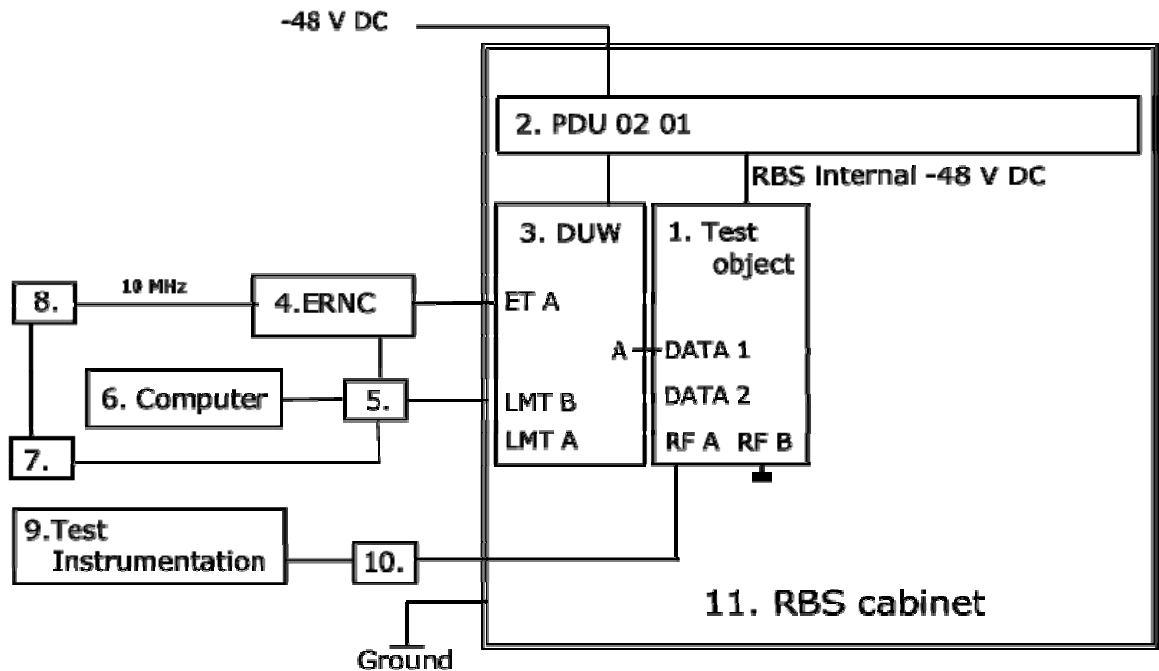

Test object

1. RUS 01 B5, (1P)KRC 118 64/1 Rev (21P)R1A, S/N (S)C823575825 with software CXP 901 6868/1 Rev R3N03 (FCC ID: TA8AKRC11864-1 / IC: 287AB-AS118641)

Functional test equipment

2. PDU 02 01, BMG 980336/4, R2A, (S)BJ31528316
3. DUW 30 01, KDU 127 161/3, Rev R2B, (S)C823486753
4. ERNC SIM 131, BAMS - 1000660992
5. Fast ethernet switch, Netgear
6. Computer Sunblade 2500 BAMS 0000015231
7. NTP-server, Symmetricom, BAMS 1000714182
8. Symmetricom model 8040 BAMS 1000714190
9. SP test instrument according measurement equipment list
10. Attenuator SP 504 159
11. RBS 6201, 1/BFM 901 290/2, BAMS-1000778792

Test set-up conducted measurements RX

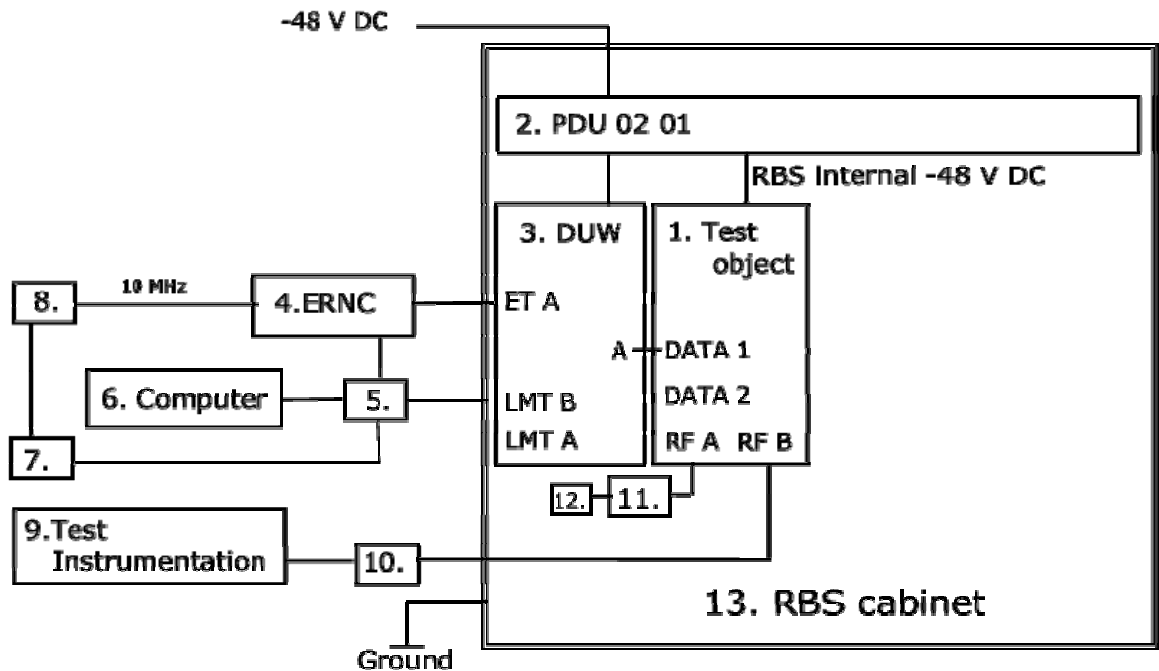

Test object

1. RUS 01 B5, (1P)KRC 118 64/1 Rev (21P)R1A, S/N (S)C823575825 with software CXP 901 6868/1 Rev R3N03 (FCC ID: TA8AKRC11864-1 / IC: 287AB-AS118641)

Functional test equipment

2. PDU 02 01, BMG 980336/4, R2A, (S)BJ31528316
3. DUW 30 01, KDU 127 161/3, Rev R2B, (S)C823486753
4. ERNC SIM 131, BAMS - 1000660992
5. Fast ethernet switch, Netgear
6. Computer Sunblade 2500 BAMS 0000015231
7. NTP-server, Symmetricom, BAMS 1000714182
8. Symmetricom model 8040 BAMS 1000714190
9. SP test instrument according measurement equipment list
10. Attenuator SP 504 159
11. Attenuator, Weinschel model 49-40-33
12. Terminator, Weinschel model 1453-4
13. RBS 6201, 1/BFM 901 290/2, BAMS-1000778792

Test set-up radiated measurements

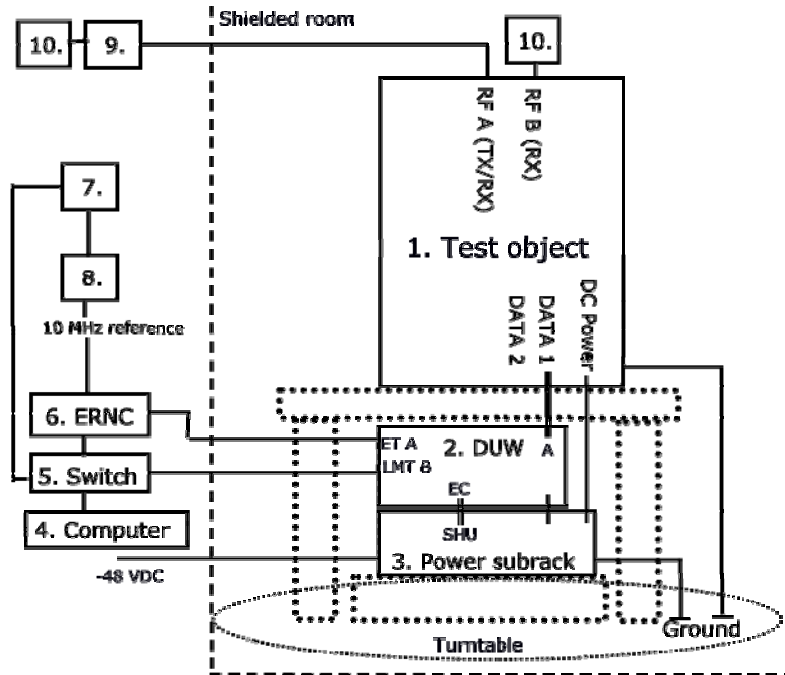

Test object

1. RUS 01 B5, (1P)KRC 118 64/1 Rev (21P)R1A, S/N (S)C823575825 with software CXP 901 6868/1 Rev R3N03 (FCC ID: TA8AKRC11864-1 / IC: 287AB-AS118641)

Functional test equipment

2. DUW 30 01, KDU 127 161/3, R2B, (S)C8234869753
3. Power subrack, for details see table below
4. Computer Sunblade Ultra 2500, BAMS – 0000015231
5. Fast ethernet switch, Netgear
6. ERNC SIM 131, BAMS - 1000660992
7. NTP-server, Symmetricom, BAMS 1000714182
8. Symmetricom model 8040 BAMS 1000714190
9. Attenuator, Weinschel model 49-40-33
10. Terminator, Weinschel model 1453-4

Components of the power sub-rack :

Position	Product name	Product number	R-state	Serial number
1	PDU 01 01	BMG 980 336/2	R4F	(S)BJ31532384
2	PDU 01 01	BMG 980 336/2	R4F	(S)BJ31532382
3	SHU 01 01	BGK 901 18/1	R3C	(S)BJ31446269
4	DUMMY	SXX 109 8257/1	R1F	-
5	DUMMY	SXX 109 8257/1	R1F	-
6	DUMMY	SXX 109 8257/1	R1F	-
7	DUMMY	SXX 109 8257/1	R1F	-
8	DUMMY	SXX 109 8257/1	R1F	-
9	PCF 02 01	KFE 101 1157/1	R1C	(S)BW95301450



FCC ID: TA8AKRC11864-1
IC: 287AB-AS118641

Appendix 2

RF power output measurements according to 47 CFR 2.1046/ RSS-132 4.4

Date	Temperature	Humidity
2010-10-04	24 °C ± 3 °C	34 % ± 5 %
2010-10-05	24 °C ± 3 °C	30 % ± 5 %
2010-10-06	24 °C ± 3 °C	31 % ± 5 %
2010-10-08	24 °C ± 3 °C	37 % ± 5 %

Test set-up and procedure

The output was connected to a peak power analyzer with the CDF mode activated.

Measurement equipment	SP number
Boonton RF Peak power meter/analyzer	503 144
Boonton Power sensor 56518-S/4	503 146
Multimeter Fluke 87	502 190
Testo 615, Temperature and humidity meter	503 505

Measurement uncertainty: 0.7 dB

Results

Single carrier: Rated output power level at RF A connector (maximum): 1x 47.8 dBm

Transmitter power (dBm / dB) RMS / PAR		
B	M	T
47.7/ 6.5	47.7/ 6.4	47.7/ 6.9

Multi carrier: Rated output power level at RF A connector (maximum): 2x 44.8 dBm

Transmitter combined power (dBm / dB) RMS / PAR	
B + (B+10)	T + (T-10)
47.6/ 6.8	47.5/ 7.0



REPORT

FCC ID: TA8AKRC11864-1
IC: 287AB-AS118641

Appendix 2

Limit

According to CFR 47/ RSS there are no conducted limits at the antenna connector.

CFR § 22.913/ SRSP-503 5.1: The effective radiated power (ERP) of base transmitters and cellular repeaters must not exceed 500 Watts (57 dBm).

RSS-132: The transmitter output power shall not exceed the limits given in SRSP-503

Complies?	Yes
-----------	-----



FCC ID: TA8AKRC11864-1
IC: 287AB-AS118641

Appendix 3

Occupied bandwidth measurements according to 47 CFR 2.1049/ RSS-Gen 4.6.1

Date	Temperature	Humidity
2010-10-04	24 °C ± 3 °C	34 % ± 5 %
2010-10-05	24 °C ± 3 °C	30 % ± 5 %
2010-10-06	24 °C ± 3 °C	31 % ± 5 %

Test set-up and procedure

The measurements were made as defined in §2.1049. The output was connected to a spectrum analyzer. The spectrum analyzer was connected to an external 10 MHz reference standard during the measurements.

Measurement equipment	SP number
R&S FSIQ	503 738
Testo 615, Temperature and humidity meter	503 505

Measurement uncertainty: 3.7 dB

Results

The results are shown in appendix 3.1

Channel Bandwidth 5.0 MHz

	Channel	OBW
Diagram 1	B	4.18 MHz
Diagram 2	M	4.18 MHz
Diagram 3	T	4.17 MHz

Channel Bandwidth 4.2 MHz

	Channel	OBW
Diagram 4	B	3.85 MHz
Diagram 5	M	3.85 MHz
Diagram 6	T	3.85 MHz



FCC ID: TA8AKRC11864-1
IC: 287AB-AS118641

Appendix 3.1

Diagram 1

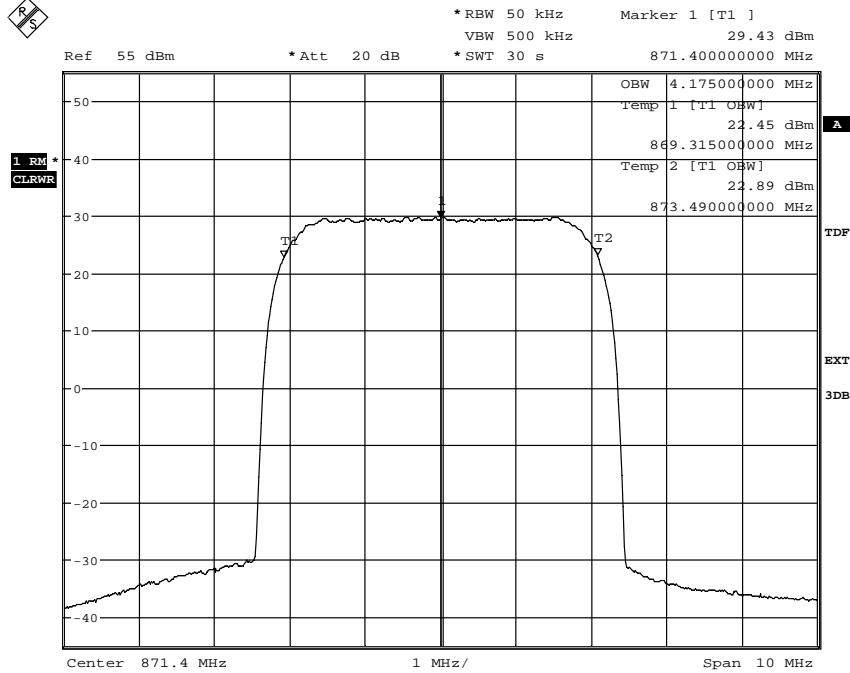

Date: 4.OCT.2010 16:03:33

Diagram 2

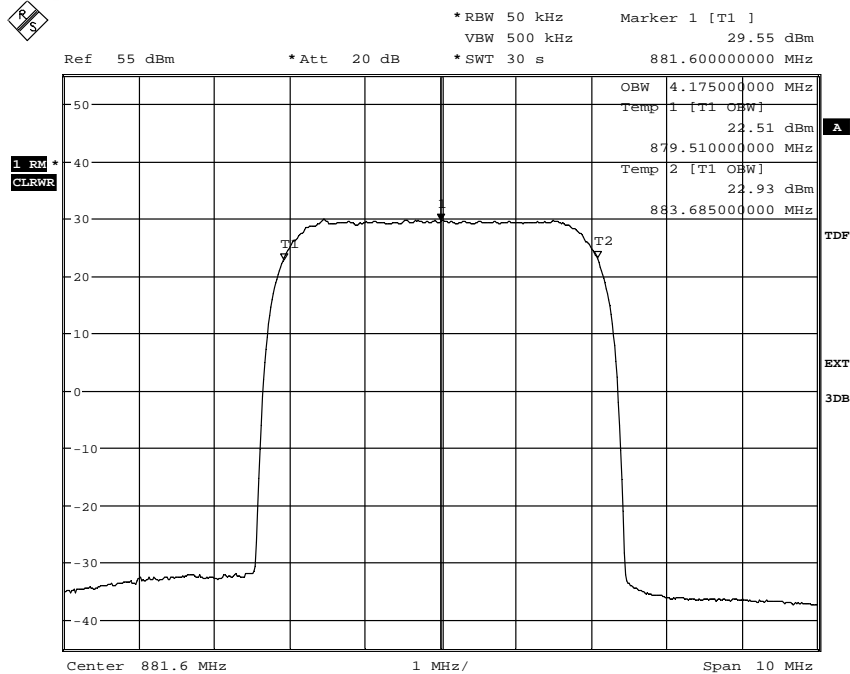

Date: 5.OCT.2010 08:01:52



FCC ID: TA8AKRC11864-1
IC: 287AB-AS118641

Appendix 3.1

Diagram 3

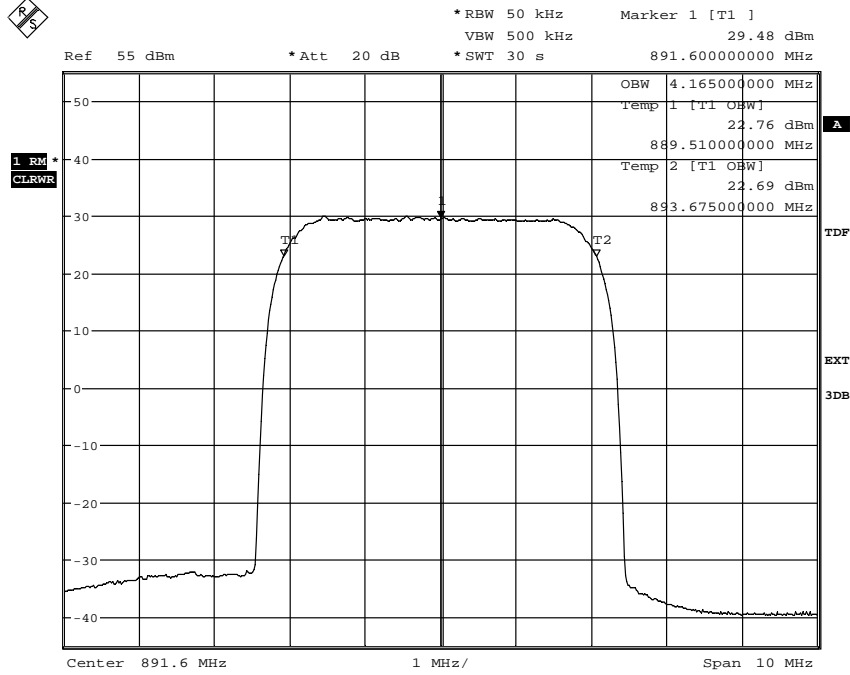

Date: 5.OCT.2010 09:10:01

Diagram 4

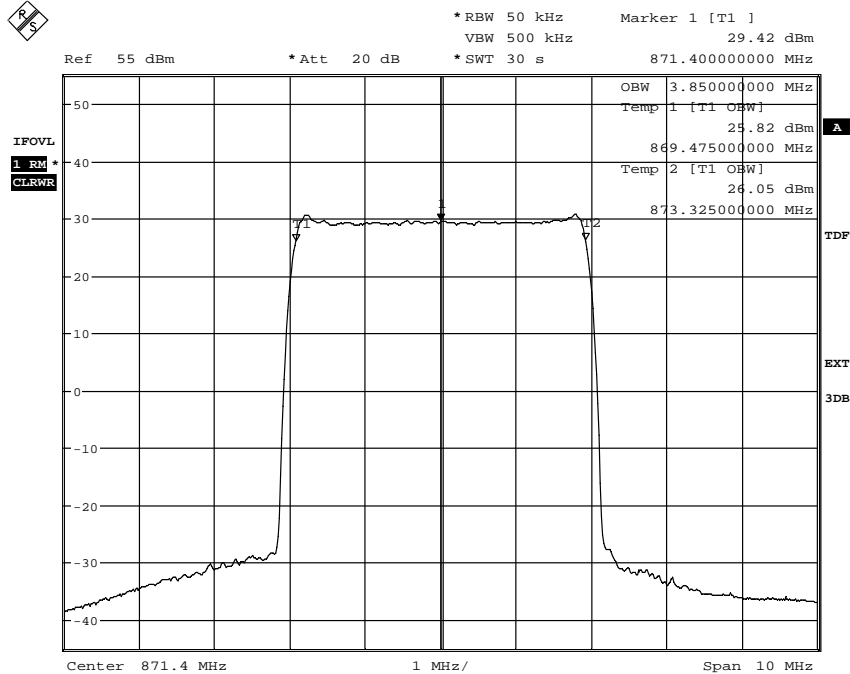

Date: 5.OCT.2010 10:02:38



FCC ID: TA8AKRC11864-1
IC: 287AB-AS118641

Appendix 3.1

Diagram 5

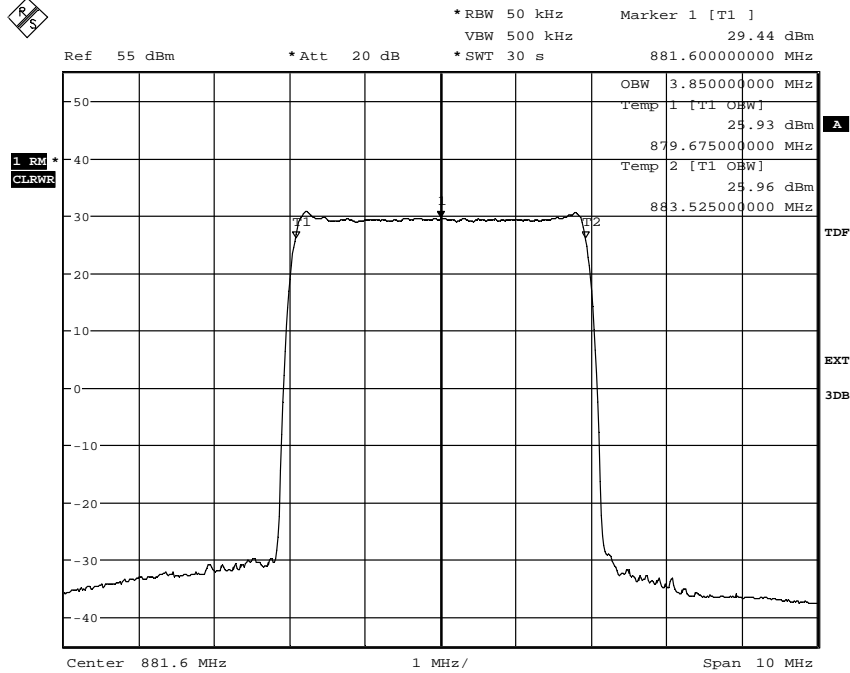

Date: 6.OCT.2010 10:41:31

Diagram 6

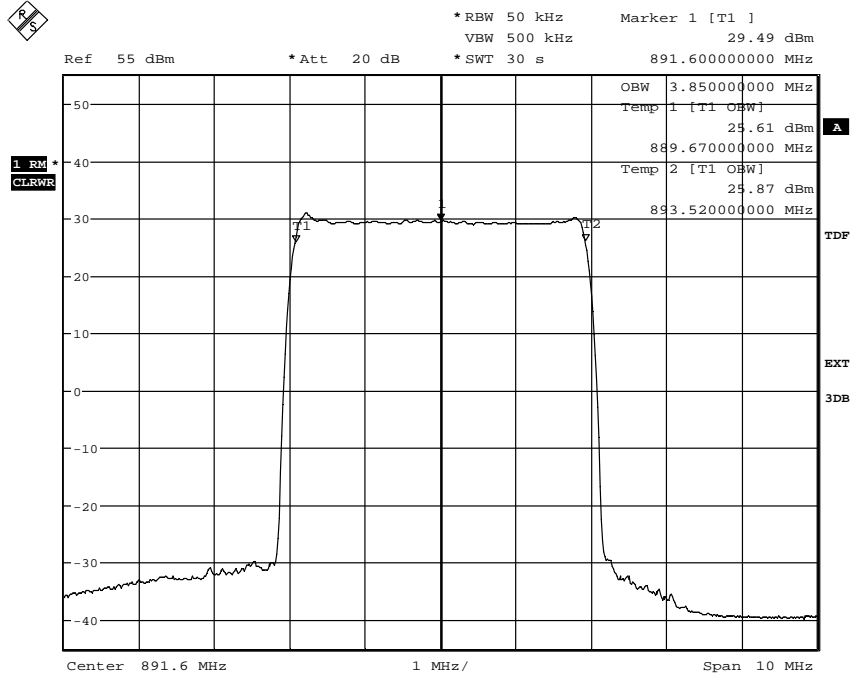

Date: 6.OCT.2010 10:57:15



FCC ID: TA8AKRC11864-1
IC: 287AB-AS118641

Appendix 4

Band edge measurements according to 47 CFR 2.1051/ RSS-132 4.5

Date	Temperature	Humidity
2010-10-04	24 °C ± 3 °C	34 % ± 5 %
2010-10-05	24 °C ± 3 °C	30 % ± 5 %
2010-10-06	24 °C ± 3 °C	31 % ± 5 %

Test set-up and procedure

The measurements were made as defined in §22.917. The output was connected to a spectrum analyzer with the RMS detector activated. The spectrum analyzer was connected to an external 10 MHz reference standard during the measurements. A resolution bandwidth of 30 kHz was used up to 3.25 MHz away from the band edges. 30 kHz is <1% of the Emission BW (4.25 MHz between the 26 dB points for 5 MHz nominal BW setting). To compensate for the reduced measurement bandwidth, the limit was adjusted with 1.5 dB to -14.5 dBm up to 1 MHz away from the band edges and with 15.2 dB to -28.2 dBm from 1 MHz to 5 MHz away from the band edges.

Measurement equipment	SP number
R&S FSIQ	503 738
Testo 615, Temperature and humidity meter	503 505

Measurement uncertainty: 3.7 dB

Results

The results are shown in appendix 4.1

Single carrier:

Diagram 1: B

Diagram 2: T

Multi carrier:

Diagram 3: B + (B+5)

Diagram 4: T+ (T-5)

Limits

The power of any emission outside the frequency band shall be attenuated below the transmitter power (P) by at least $43 + 10 \log P$ dB.

Complies?	Yes
-----------	-----



FCC ID: TA8AKRC11864-1
IC: 287AB-AS118641

Appendix 4.1

Diagram 1

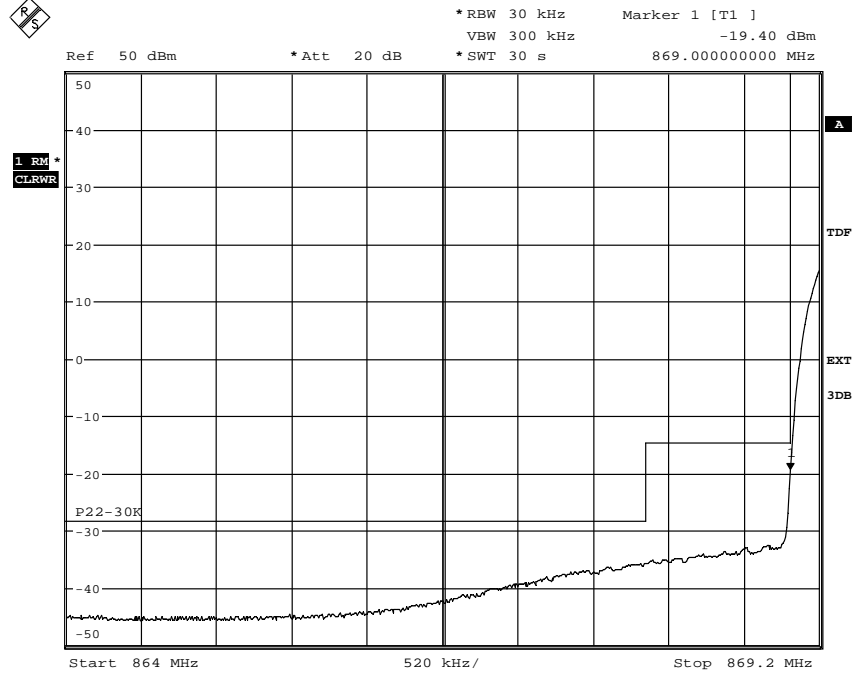

Date: 4.OCT.2010 16:13:05

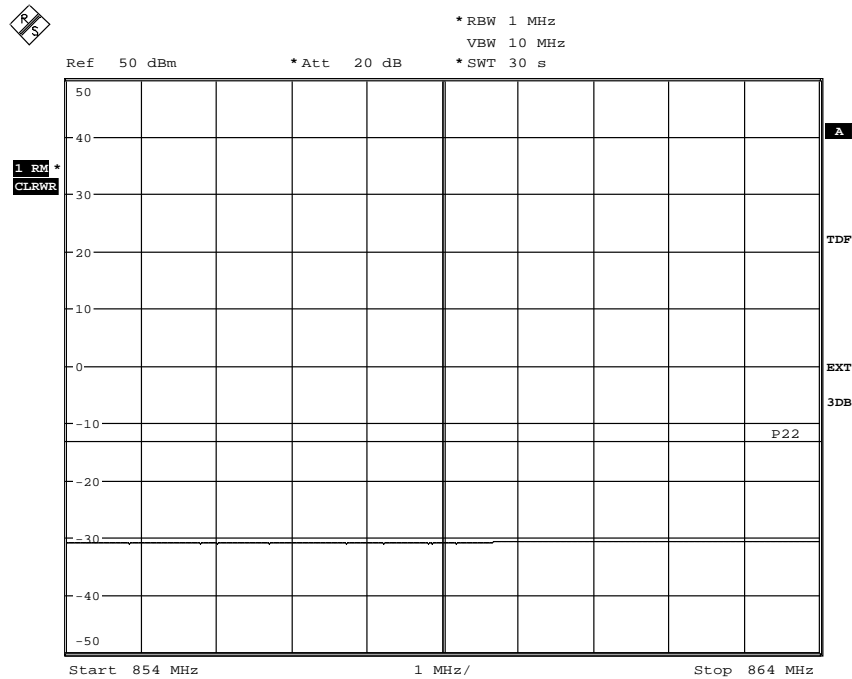

Date: 4.OCT.2010 16:20:13



REPORT

Date 2010-10-15 Reference FX015925-F22

Page 2 (4)

FCC ID: TA8AKRC11864-1
IC: 287AB-AS118641

Appendix 4.1

Diagram 2

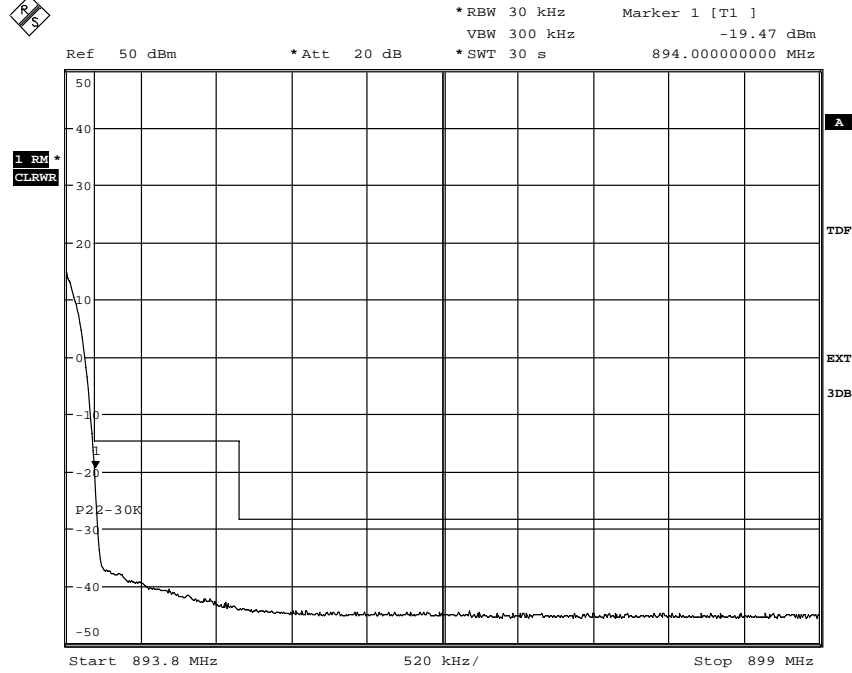

Date: 5.OCT.2010 09:24:16

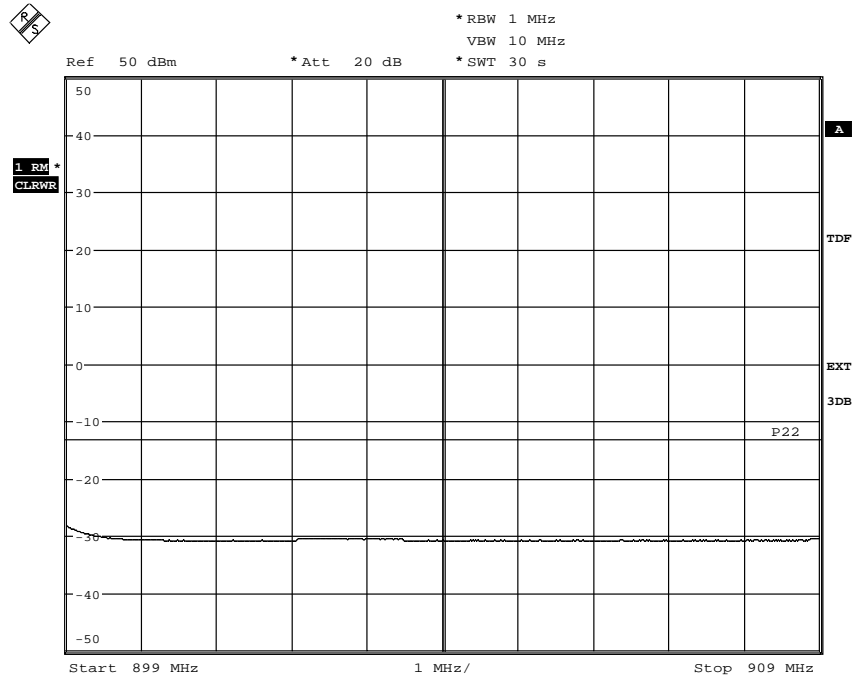

Date: 5.OCT.2010 09:27:35



FCC ID: TA8AKRC11864-1
IC: 287AB-AS118641

Appendix 4.1

Diagram 3

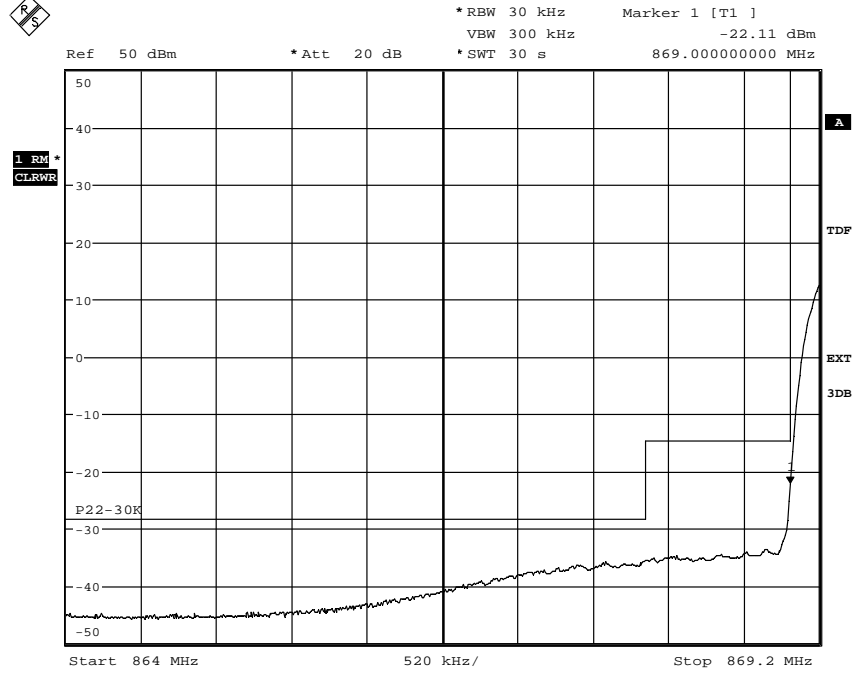

Date: 6.OCT.2010 08:28:06

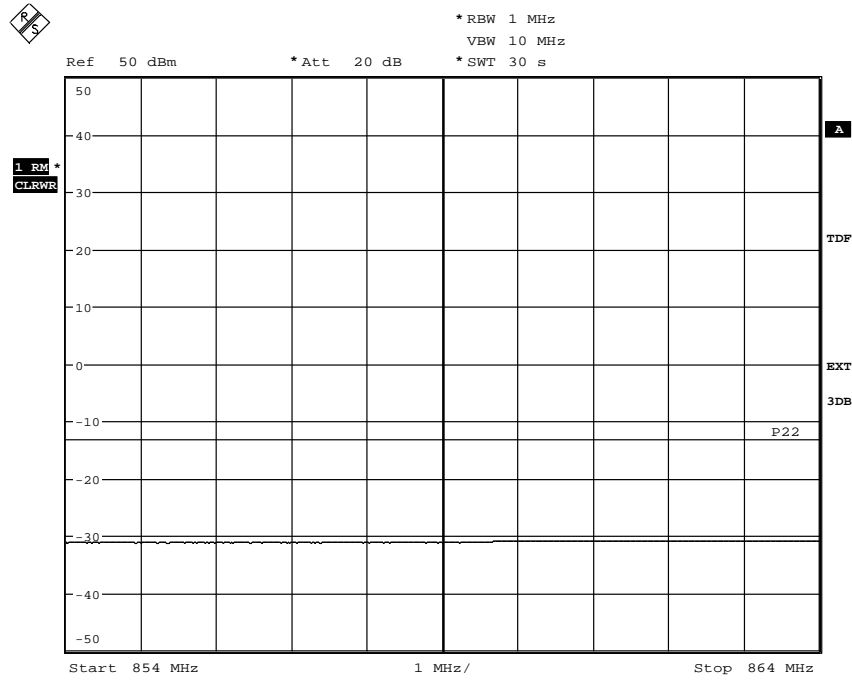

Date: 6.OCT.2010 08:30:28



FCC ID: TA8AKRC11864-1
IC: 287AB-AS118641

Appendix 4.1

Diagram 4

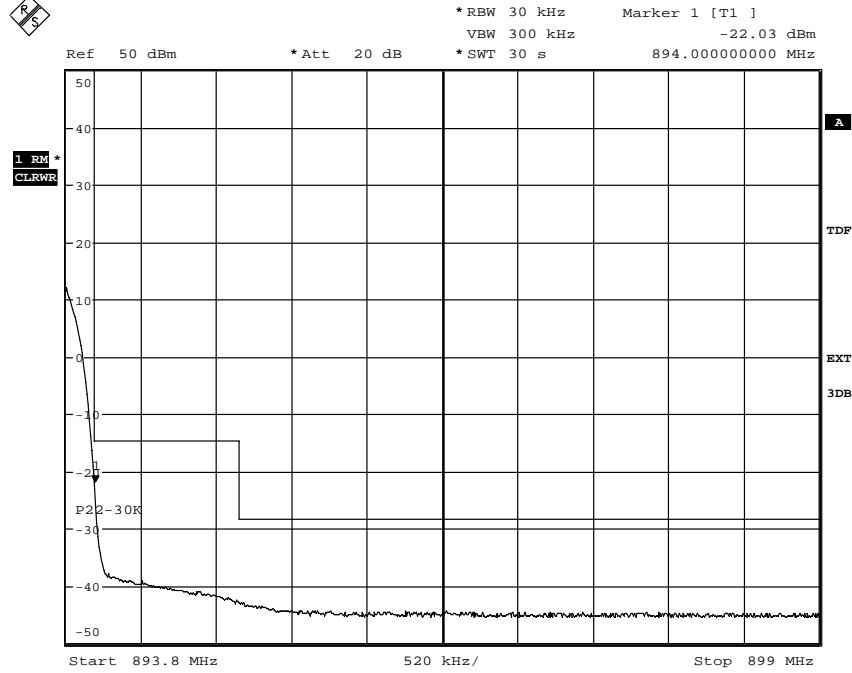

Date: 6.OCT.2010 09:53:36

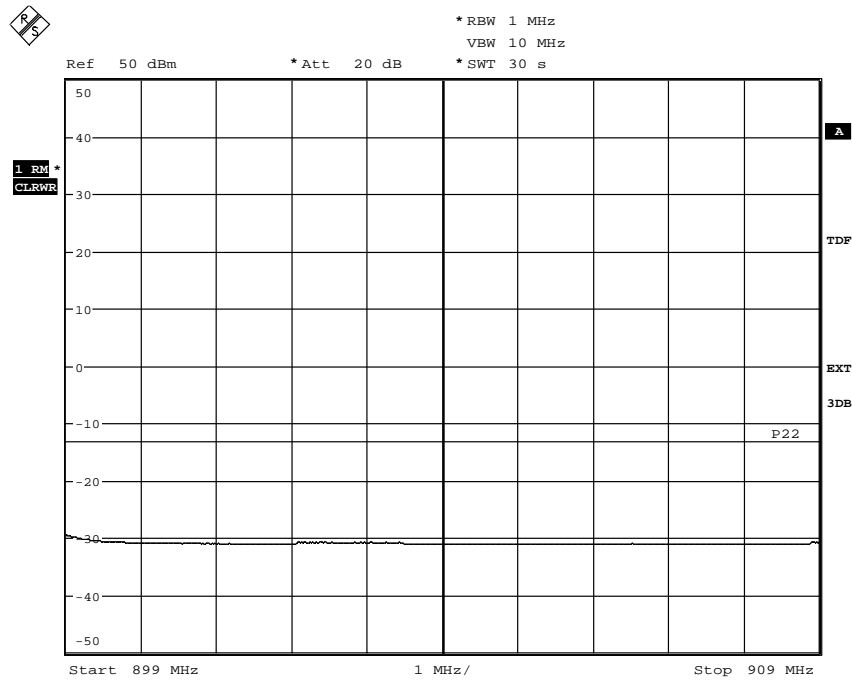

Date: 6.OCT.2010 09:56:15

FCC ID: TA8AKRC11864-1
IC: 287AB-AS118641

Appendix 5

**Conducted spurious emission measurements according to 47 CFR 2.1051/
RSS-132 4.5**

Date	Temperature	Humidity
2010-10-04	24 °C ± 3 °C	34 % ± 5 %
2010-10-05	24 °C ± 3 °C	30 % ± 5 %
2010-10-06	24 °C ± 3 °C	31 % ± 5 %

Test set-up and procedure

The measurements were made with a resolution bandwidth of 1 MHz instead of 100 kHz as RSS-132 specifies 1 MHz for equipment with an emission bandwidth of ≥ 4 MHz. The output was connected to a spectrum analyzer. First a pre-measurement with activated peak detector was performed. An emission close to or above the limit is measured with activated RMS detector and the RMS measurement result is noted. The spectrum analyzer was connected to an external 10 MHz reference standard during the measurements.

Measurement equipment	SP number
R&S FSIQ	503 738
High pass filter	503 739
Testo 615, Temperature and humidity meter	503 505

Measurement uncertainty: 3.7 dB

Results

The results are shown in appendix 5.1

Single carrier:

Diagram 1: B

Diagram 2: M

Diagram 3: T

Multi carrier:

Diagram 4: B+ (B+10)

Diagram 5: T+ (T-10)

Remark

The emission at 9 kHz on the plots was not generated by the test object. A complementary measurement with a smaller RBW showed that it was related to the LO feed-through.

Limits

The power of any emission outside the frequency band shall be attenuated below the transmitter power (P) by at least $43 + 10 \log P$ dB.

Complies?	Yes
-----------	-----



FCC ID: TA8AKRC11864-1
IC: 287AB-AS118641

Appendix 5.1

Diagram 1

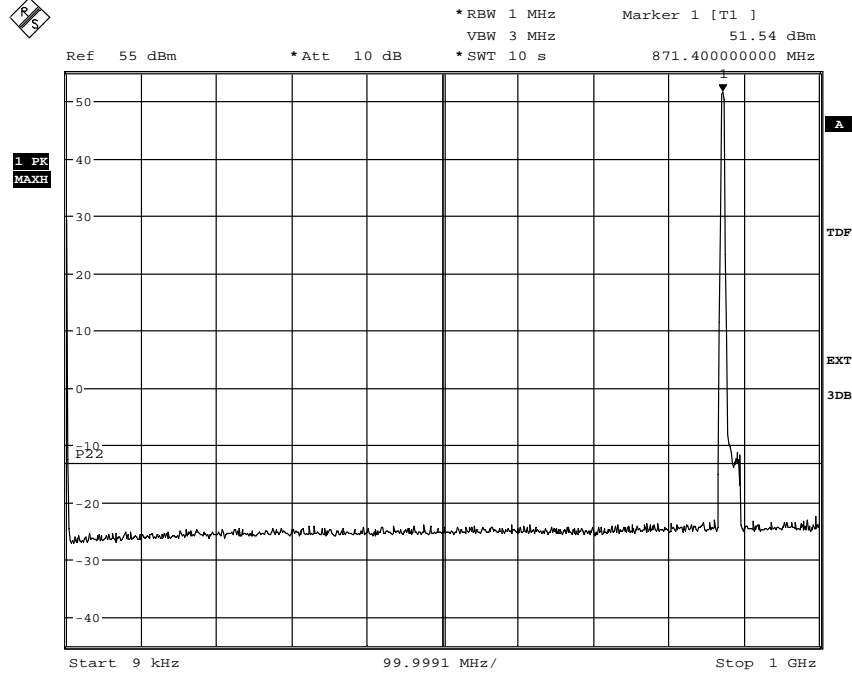

Date: 5.OCT.2010 07:19:15

The emissions around the carrier are within the operating frequency band

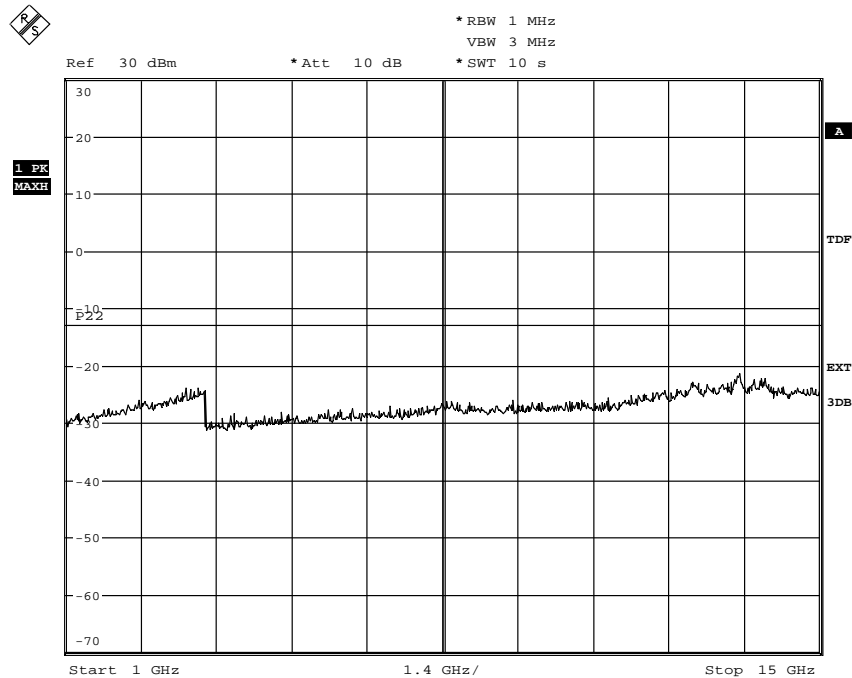

Date: 5.OCT.2010 07:21:43



FCC ID: TA8AKRC11864-1
IC: 287AB-AS118641

Appendix 5.1

Diagram 2

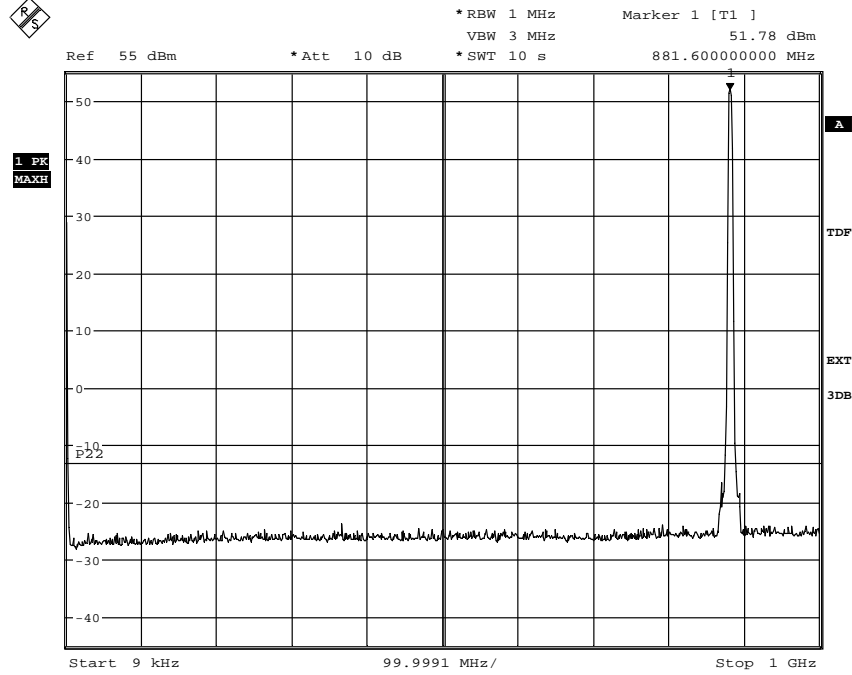

Date: 5.OCT.2010 07:50:54

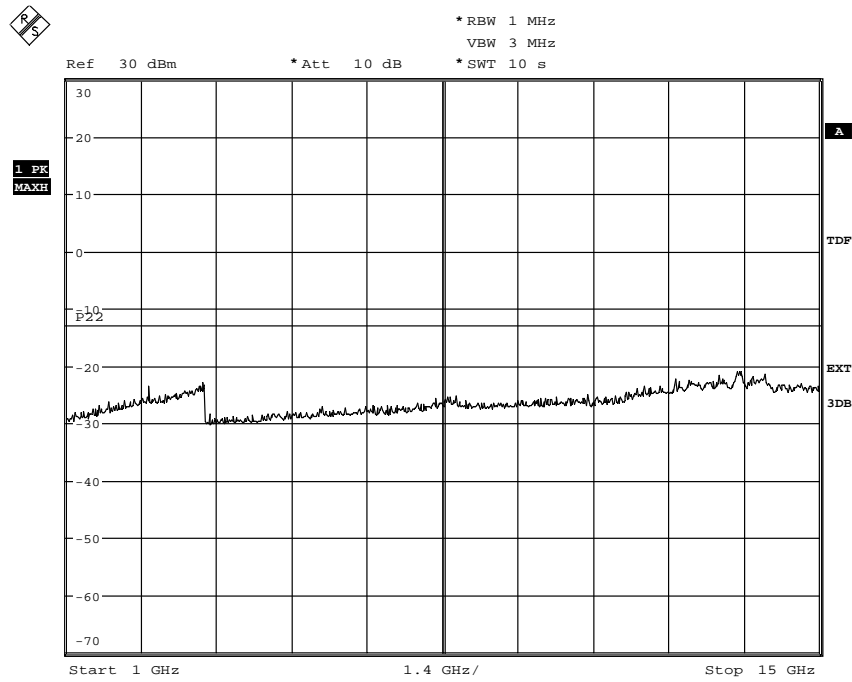

Date: 5.OCT.2010 07:45:21



FCC ID: TA8AKRC11864-1
IC: 287AB-AS118641

Appendix 5.1

Diagram 3

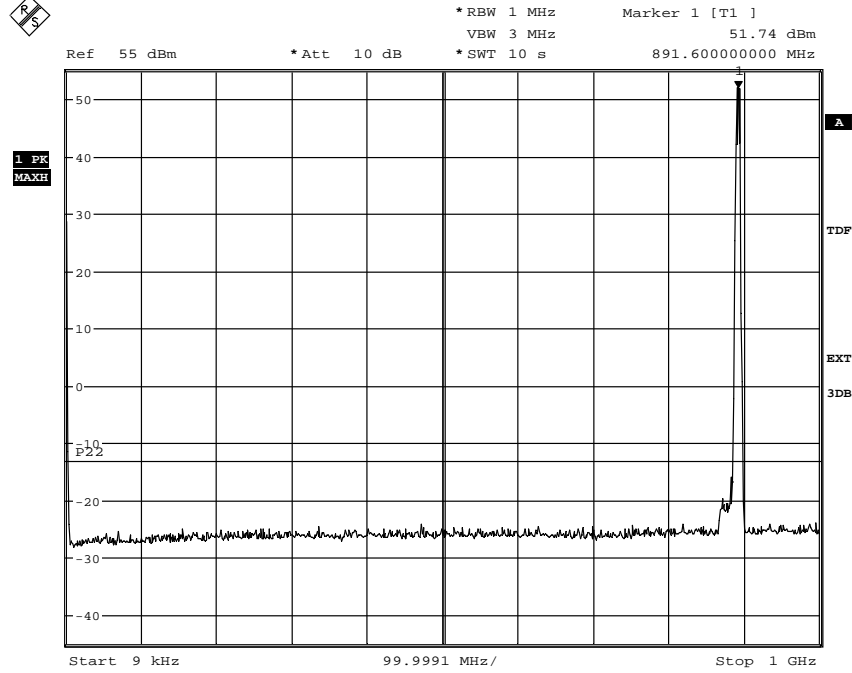

Date: 5.OCT.2010 09:05:05

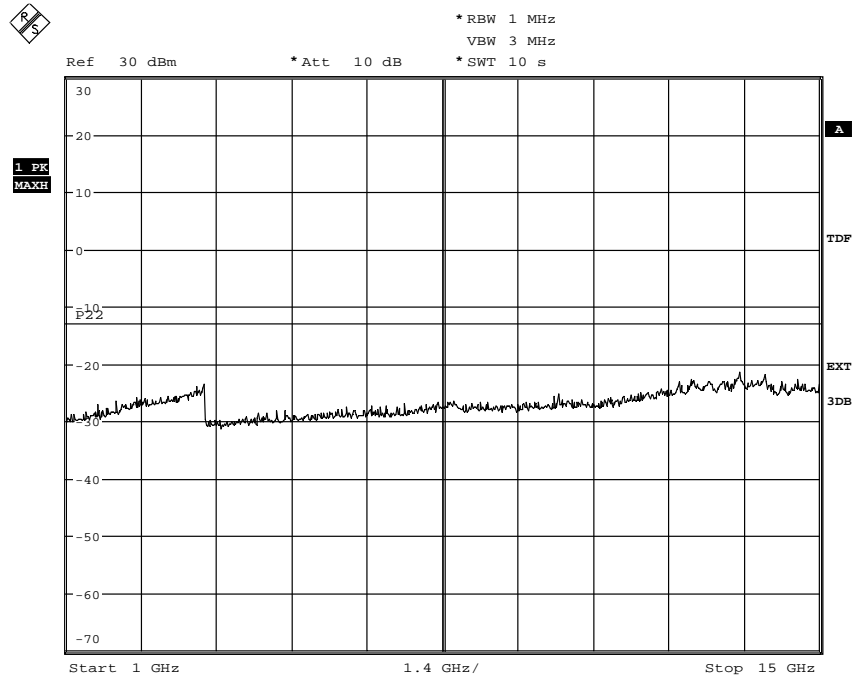

Date: 5.OCT.2010 09:03:14



FCC ID: TA8AKRC11864-1
IC: 287AB-AS118641

Appendix 5.1

Diagram 4

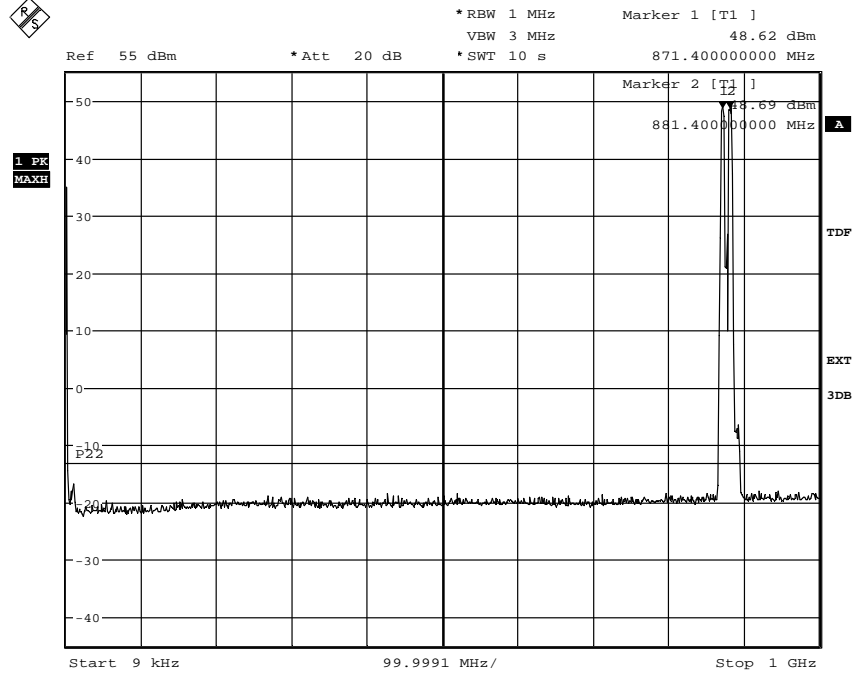

Date: 6.OCT.2010 08:50:56

The emissions around the carriers are within the operating frequency band

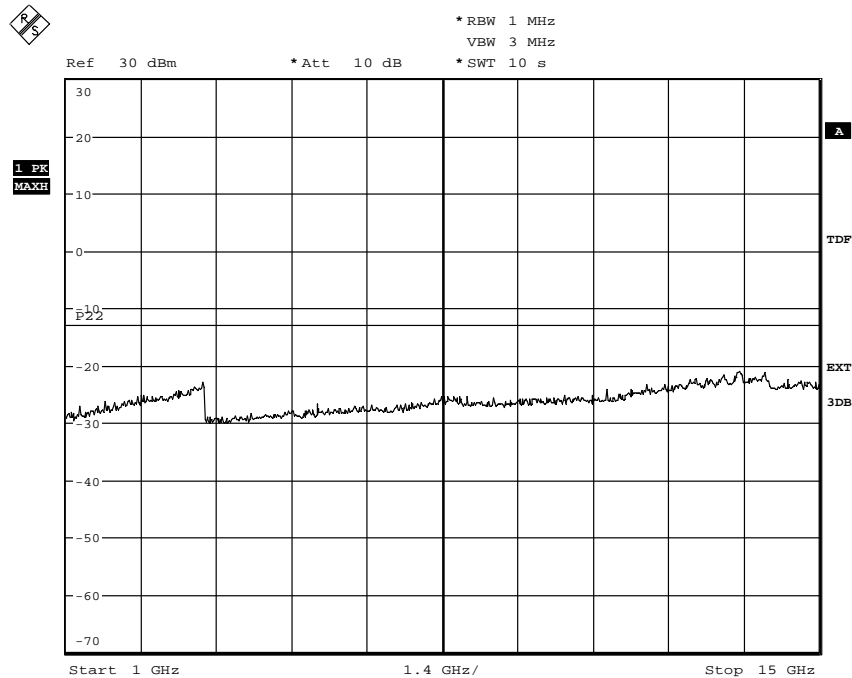

Date: 6.OCT.2010 07:54:37



FCC ID: TA8AKRC11864-1
IC: 287AB-AS118641

Appendix 5.1

Diagram 5

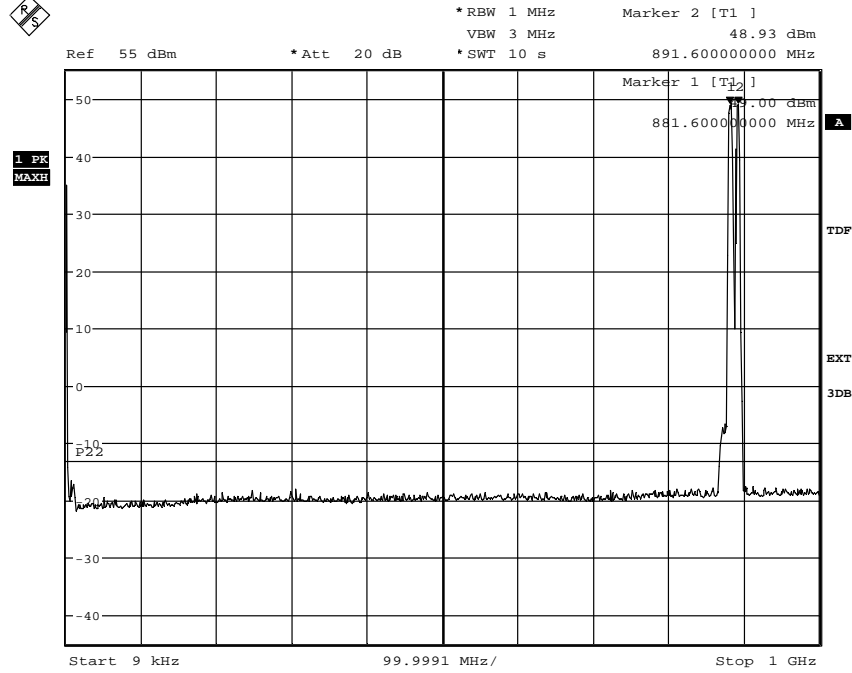

Date: 6.OCT.2010 09:20:39

The emissions around the carriers are within the operating frequency band

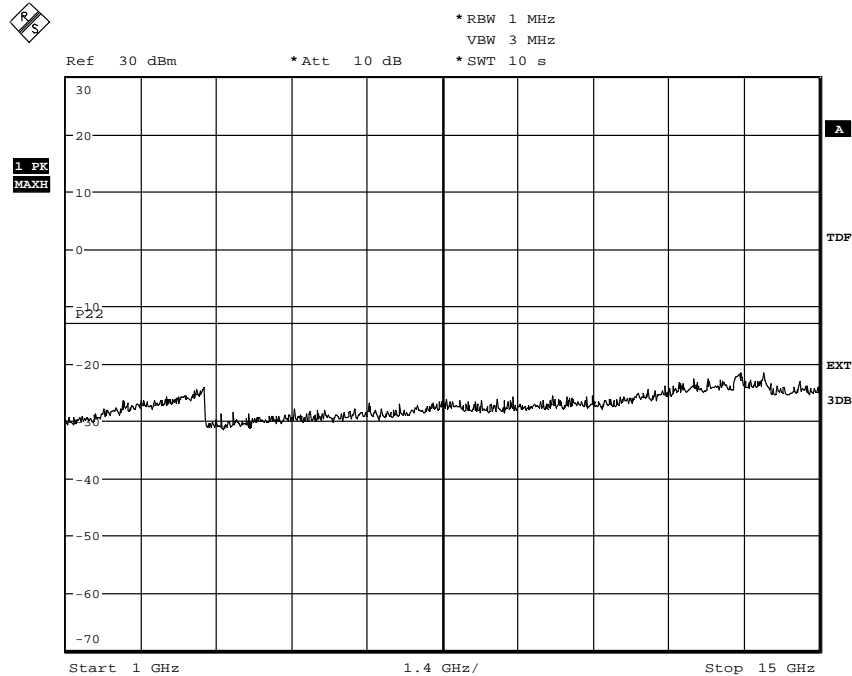

Date: 6.OCT.2010 09:33:25

FCC ID: TA8AKRC11864-1
 IC: 287AB-AS118641

Appendix 6

Field strength of spurious radiation measurements according to 47 CFR 2.1053/ RSS-132 4.5

Date	Temperature	Humidity
2010-09-23	23 °C ± 3 °C	42 % ± 5 %
2010-09-24	23 °C ± 3 °C	46 % ± 5 %
2010-09-27	22 °C ± 3 °C	40 % ± 5 %
2010-09-28	23 °C ± 3 °C	42 % ± 5 %
2010-10-04	23 °C ± 3 °C	39 % ± 5 %

Test set-up and procedure

The test site is listed at FCC, Columbia with registration number: 93866. The test site also complies with RSS-Gen, Industry Canada file no.:IC 3482A-1.

The transmitter was modulated with pseudorandom data during the measurements. Antenna port RF A was connected to functional test equipment outside the test chamber for signal monitoring. Antenna port RF B was terminated with a 50 ohm load.

The measurements were performed with both horizontal and vertical polarization of the antenna. The antenna distance was 3 m.

1. A pre-measurement was first performed:
2. In the frequency range 30 MHz-10 GHz the measurement was performed in power with a RBW of 1 MHz. A propagation loss in free space was calculated. The used formula was,

$$\gamma = 20 \log \left(\frac{4\pi D}{\lambda} \right), \gamma \text{ is the propagation loss and } D \text{ is the antenna distance.}$$

3. The measurement procedure was as the following:
4. The pre-measurement was first performed with peak detector. The EUT was measured in eight directions and with the antenna at three heights, 1.0 m, 1.5 m and 2.0 m.
5. Spurious radiation on frequencies closer than 20 dB to the limit is scanned 0-360 degrees and the antenna is scanned 1-4 m for maximum response. The emission is then measured with the RMS detector and the RMS value is reported, frequencies closer than 10 dB to the limit measured with the RMS detector were measured with the substitution method according to the standard.

Measurement equipment	SP number
Semi anechoic chamber	503 881
R&S ESI 26	503 292
Software: R&S EMC 32, ver.8.20.1	503 745
Chase Bilog antenna CBL 6111A	503 182
EMCO Horn Antenna 3115	502 175
MITEQ Low Noise Amplifier	504 160
HP 1-15 GHz	504 199
Temperature and humidity meter, Testo 625	504 188

FCC ID: TA8AKRC11864-1
 IC: 287AB-AS118641

Appendix 6

The test set-up during the spurious radiation measurements is shown in the picture below:

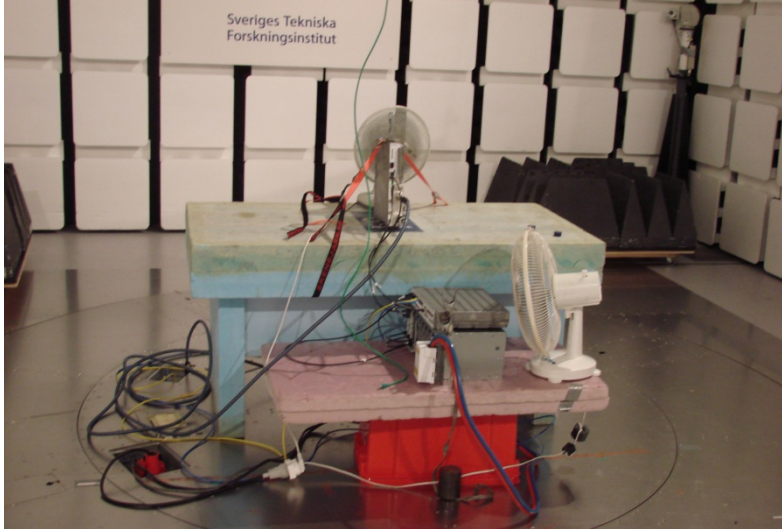

Results

Single carrier

Frequency (MHz)	Spurious emission level (dBm)	
	Vertical	Horizontal
30-15 000	All emission > 20 dB below limit	All emission > 20 dB below limit
Measurement uncertainty 4.7 dB		

Multi carrier

Frequency (MHz)	Spurious emission level (dBm)	
	Vertical	Horizontal
30-15 000	All emission > 20 dB below limit	All emission > 20 dB below limit
Measurement uncertainty 4.7 dB		

Measurement uncertainty:

3.2 dB up to 18 GHz

Limits

The power of any emission outside the frequency band shall be attenuated below the transmitter power (P) by at least $43 + 10 \log P$ dB.

Complies?	Yes
-----------	-----



FCC ID: TA8AKRC11864-1
IC: 287AB-AS118641

Appendix 7

Frequency stability according to 47 CFR 2.1055/ RSS-132 4.3

Date 2010-10-06 to 2010-10-08	Temperature (test equipment) 21-23°C ± 3 °C	Humidity (test equipment) 35-41 % ± 5 %
----------------------------------	--	--

Test set-up and procedure

The measurement was made per 3GPP TS 25.141. The output was connected to a spectrum analyzer. The spectrum analyzer was connected to an external 10 MHz reference standard during the measurements.

Measurement equipment	SP number
R&S FSQ 40	504 143
Testo 615, Temperature and humidity meter	503 505
Climate chamber 2	501 031

Results

Nominal Voltage -48 V DC
Maximum output power at mid channel (M)

Test conditions		Frequency error (Hz)
Supply voltage DC (V)	T (°C)	
-48.0	+20	-1
-55.2	+20	-3
-40.8	+20	-2
-48.0	+30	3
-48.0	+40	3
-48.0	+50	-4
-48.0	+10	2
-48.0	0	-2
-48.0	-10	TX disabled (Note 1)
-48.0	-20	N.T
-48.0	-30	N.T
Maximum freq. error (Hz)		4
Measurement uncertainty		< ± 1 x 10 ⁻⁷

Note 1: This temperature caused an unacceptable error “TemperatureExeptionallyLow” and it was not possible to enable the transmitter.

Limits (according to 3GPP TS 25.141)
The frequency error shall be within ± 0.05 PPM ± 12 Hz (56.1 Hz).

Complies?	Yes
-----------	-----



FCC ID: TA8AKRC11864-1
IC: 287AB-AS118641

Appendix 8

**Receiver spurious emissions measurements according to 47 CFR 15.111/
IC RSS-132, section 4.6.**

Date 2010-10-11	Temperature 23°C ± 3 °C	Humidity 42 % ± 5 %
--------------------	----------------------------	------------------------

Test set-up and procedure

The measurements were performed according to ANSI C63.4.

Measurements were performed on the receiver antenna terminal (RF B). The measurement is first performed with peak detector. Emission on frequencies close to or above the limit is re-measured with quasi-peak detector (average detector above 1000 MHz).

Measurement equipment	SP number
R&S FSQ 40	504 143
Testo 615, Temperature and humidity meter	503 505

Result

The results are shown in appendix 8.1:

Diagram 1 Channel B

Note: During the measurement on the RX port RF B the combined TX/RX port RF A was terminated into 50 ohm, the TX was active in single carrier mode transmitting TM1.

Limit

The power of any spurious output signals appearing at the antenna terminals must not exceed -57 dBm (2 nanowatt).

Emission below limit?	Yes
-----------------------	-----

FCC ID: TA8AKRC11864-1
IC: 287AB-AS118641

Appendix 9

External photos of EUT

Front side



Rear side

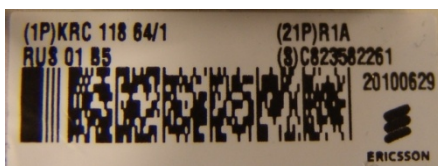
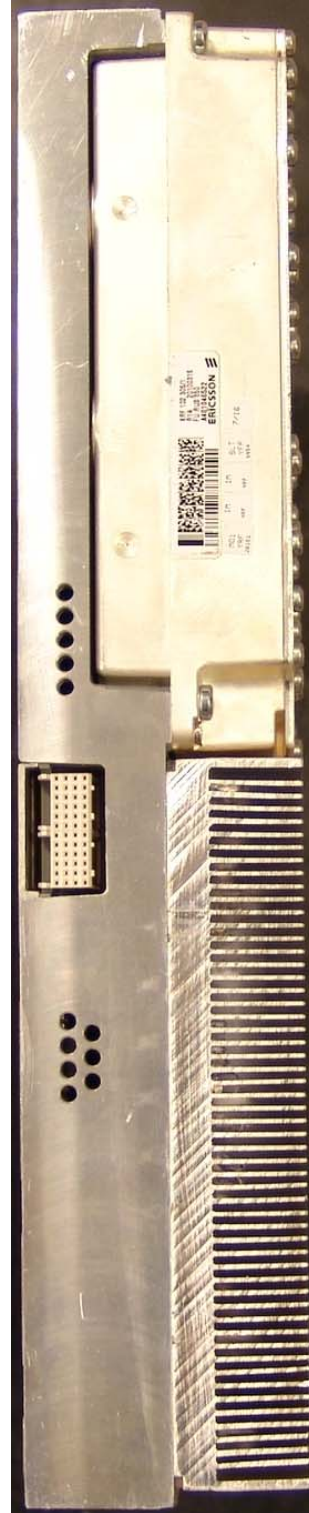

FCC ID: TA8AKRC11864-1
IC: 287AB-AS118641

Appendix 9

Right side

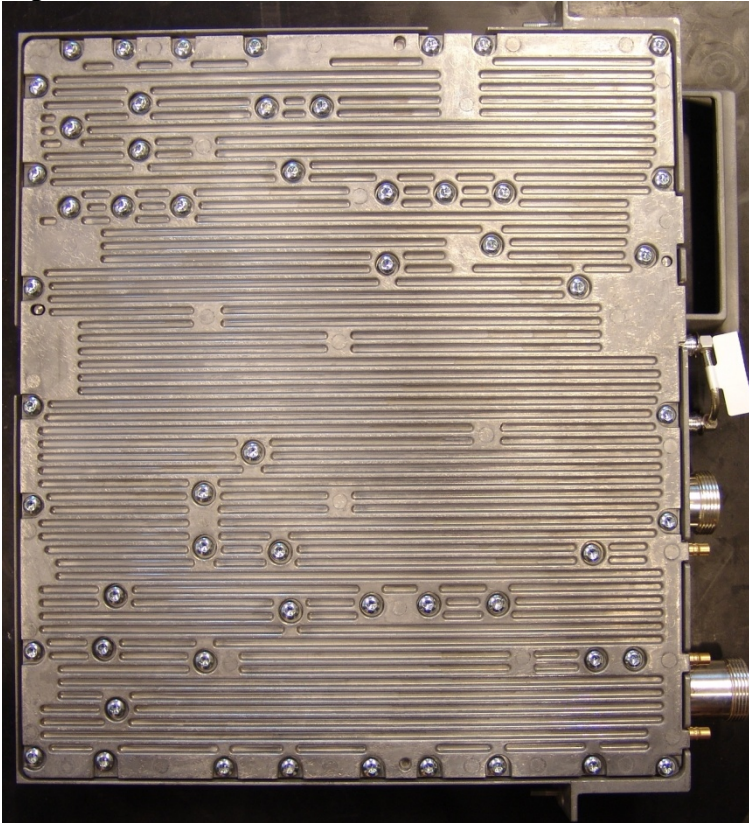

Left side

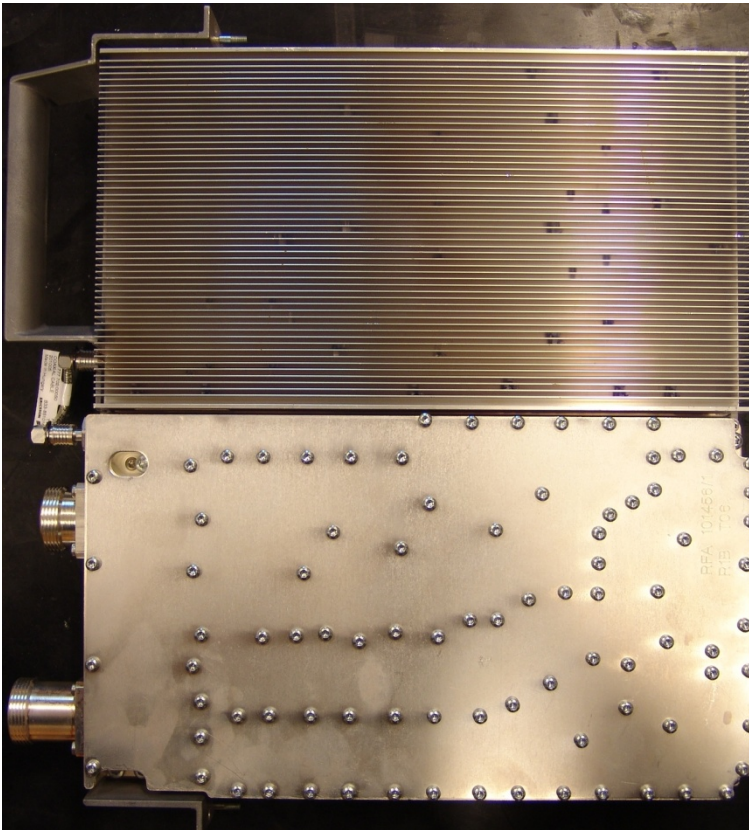

FCC ID: TA8AKRC11864-1
IC: 287AB-AS118641

Appendix 9

Bottom side



Top side

