



# REPORT

issued by an FCC listed Laboratory Reg. no. 93866.  
The test sites comply with RSS-Gen, IC file no: 3482A

Contact person  
Jörgen Wassholm  
Electronics  
+46 10 516 57 06  
jorgen.wassholm@sp.se

Date  
2012-12-07

Reference  
FX217498-F27

Page  
1 (2)

Ericsson AB  
Klaes Holm  
PDU HW  
164 80 Stockholm

## Class II permissive change on RUS 01 B4 1700/2100 MHz radio equipment with FCC ID: TA8AKRC11859-2 and IC: 287AB-AS118592 (7 appendices)

### Test object

RUS 01 B4, KRC 118 59/2, Rev R2B

### Summary

Standard	Compliant	Appendix
<b>FCC CFR 47 / IC RSS-139</b>		
2.1046 / RSS-139 6.4 RF power output	Yes	2
2.1049 / RSS-Gen 4.6.1 Occupied bandwidth	Yes	3
2.1051 / RSS-139 6.5 Band edge	Yes	4
2.1051 / RSS-139 6.5 Spurious emission at antenna terminals	Yes	5
2.1053 / RSS-139 6.5 Field strength of spurious radiation	Yes	6

Note: Above RSS-139 items are given as cross-reference only. Measurements were performed according to ANSI procedures referenced by FCC and covered by SP's accreditation.

### SP Technical Research Institute of Sweden Electronics - EMC

Performed by

Jörgen Wassholm

Examined by

Christer Karlsson

---

### SP Technical Research Institute of Sweden

Postal address  
SP  
Box 857  
SE-501 15 BORÅS  
Sweden

Office location  
Västeråsen  
Brinellgatan 4  
SE-504 62 BORÅS

Phone / Fax / E-mail  
+46 10 516 50 00  
+46 33 13 55 02  
info@sp.se

This document may not be reproduced other than in full, except with the prior written approval of SP.

## Table of contents

Description of the test object	Appendix 1
Operation mode during measurements	Appendix 1
Test setups	Appendix 1
Purpose of test	Appendix 1
RF power output	Appendix 2
Occupied bandwidth	Appendix 3
Band edge	Appendix 4
Spurious emission at antenna terminals	Appendix 5
Field strength of spurious radiation	Appendix 6
External photos	Appendix 7

## Appendix 1

### Description of the test object

Equipment:	Radio equipment RUS 01 B4 supporting 2x2 MIMO and mixed mode standard (MSR) LTE+WCDMA.
Antenna ports:	1 TX/RX and 1 RX port
Frequency bands:	TX: 2110 – 2155 MHz RX: 1710 – 1755 MHz
Nominal output power per antenna port:	Single carrier: 1 x 49.0 dBm (1 x 80.0W) Multi carrier: 2 x 46.0 dBm (2 x 40.0W) 3 x 44.2 dBm (3 x 26.6W) 4 x 43.0 dBm (4 x 20W) In WCDMA MIMO configuration nominal output power is limited to 1 x 47 dBm (1 x 50W)
LTE Modulations:	QPSK, 16QAM and 64QAM
Channel bandwidth:	1.4MHz, 3 MHz, 5 MHz, 10 MHz and 15 MHz, 20MHz
WCDMA Modulations:	QPSK, 16QAM and 64QAM
Channel bandwidth:	4.2 to 5 MHz (configurable in steps of 100/200 kHz)
Channel spacing:	4.4 to 5 MHz (configurable in steps of 100/200 kHz)
Nominal power voltage:	-48VDC

Appendix 1

**LTE, MIMO**

**Tested frequencies and EARFCNs for TX measurements**

EARFCN	Frequency [MHz]	Comment
Downlink		
1957	2110.7	TX Bottom (B) frequency in 1.4 MHz BW configuration
1965	2111.5	TX Bottom (B) frequency in 3 MHz BW configuration
1975	2112.5	TX Bottom (B) frequency in 5 MHz BW configuration
2000	2115.0	TX Bottom (B) frequency in 10 MHz BW configuration
2025	2117.5	TX Bottom (B) frequency in 15 MHz BW configuration
2050	2120.0	TX Bottom (B) frequency in 20 MHz BW configuration
2175	2132.5	TX Mid (M) frequency in all BW configurations
2393	2154.3	TX top (T) frequency in 1.4 MHz BW configuration
2385	2153.5	TX top (T) frequency in 3 MHz BW configuration
2375	2152.5	TX top (T) frequency in 5 MHz BW configuration
2350	2150.0	TX top (T) frequency in 10 MHz BW configuration
2325	2147.5	TX top (T) frequency in 15 MHz BW configuration
2300	2145.0	TX top (T) frequency in 20 MHz BW configuration

**WCDMA, MIMO**

**Tested frequencies and UARFCNs for TX measurements**

Channel	Downlink		Uplink	
	Frequency	UARFCN	Frequency	UARFCN
B	2112.4	1537	1712.4	1312
B+5	2117.4	1562	1717.4	1337
M	2132.6	1638	1732.6	1413
M+5	2137.6	1663	1737.6	1438
T-5	2147.6	1713	1747.6	1488
T	2152.6	1738	1752.6	1513

Appendix 1

**LTE+WCDMA**

**Tested configurations**

Configuration 1:

	<b>LTE</b>	<b>WCDMA</b>
	(40W)	(40 W)
Downlink	2125 (2127.5 MHz)	1538 (2112.6 MHz)
Uplink	20125 (1727.5 MHz)	1313 (1712.6 MHz)
Test model	E-TM1.1	TM1
Bandwidth	5 MHz	5 MHz

Configuration 2:

	<b>LTE</b>	<b>WCDMA</b>
	(40W)	(40 W)
Downlink	2136 (2128.6 MHz)	1538 (2112.6 MHz)
Uplink	20136 (1728.6 MHz)	1313 (1712.6 MHz)
Test model	E-TM1.1	TM1
Bandwidth	3 MHz	5 MHz

Appendix 1

Configuration 3:

	<b>LTE</b>	<b>WCDMA</b>
	(40W)	(40 W)
Downlink	2143 (2129.3 MHz)	1538 (2112.6 MHz)
Uplink	20143 (1729.3 MHz)	1313 (1712.6 MHz)
Test model	E-TM1.1	TM1
Bandwidth	1.4 MHz	5 MHz

Configuration 4:

	<b>LTE</b>	<b>WCDMA</b>
	(40W)	(40 W)
Downlink	2250 (2140 MHz)	1600 (2125 MHz)
Uplink	20250 (1740 MHz)	1375 (1725 MHz)
Test model	E-TM1.1	TM1
Bandwidth	5 MHz	5 MHz

Appendix 1

Configuration 5:

	<b>LTE</b>	<b>WCDMA</b>
	(40W)	(40 W)
Downlink	2260 (2141 MHz)	1600 (2125 MHz)
Uplink	20260 (1741 MHz)	1375 (1725 MHz)
Test model	E-TM1.1	TM1
Bandwidth	3 MHz	5 MHz

Configuration 6:

	<b>LTE</b>	<b>WCDMA</b>
	(40W)	(40 W)
Downlink	2270 (2142 MHz)	1600 (2125 MHz)
Uplink	20270 (1742 MHz)	1375 (1725 MHz)
Test model	E-TM1.1	TM1
Bandwidth	1.4 MHz	5 MHz

Appendix 1

Configuration 7:

	<b>LTE</b>	<b>WCDMA</b>
	(40W)	(40 W)
Downlink	2375 (2152.5 MHz)	1663 (2137.6 MHz)
Uplink	20375 (1752.5 MHz)	1438 (1737.6 MHz)
Test model	E-TM1.1	TM1
Bandwidth	5 MHz	5 MHz

Configuration 8:

	<b>LTE</b>	<b>WCDMA</b>
	(40W)	(40 W)
Downlink	2385 (2153.5 MHz)	1663 (2137.6 MHz)
Uplink	20385 (1753.5 MHz)	1438 (1737.6 MHz)
Test model	E-TM1.1	TM1
Bandwidth	3 MHz	5 MHz



Appendix 1

Configuration 9:

	<b>LTE</b>	<b>WCDMA</b>
	(40W)	(40 W)
Downlink	2393 (2154.3 MHz)	1663 (2137.6 MHz)
Uplink	20393 (1754.3 MHz)	1438 (1737.6 MHz)
Test model	E-TM1.1	TM1
Bandwidth	1.4 MHz	5 MHz

Configuration 10:

	<b>WCDMA</b>	<b>LTE</b>
	(40 W)	(40 W)
Downlink	1730 (2151.0 MHz)	2393 (2154.3 MHz)
Uplink	1505 (1751.0 MHz)	20393 (1754.3 MHz)
Test model	TM1	E-TM1.1
Bandwidth	5 MHz	1.4 MHz

## Appendix 1

**LTE Operation mode during measurements**

The measurements were performed with the test object transmitting test model E-TM1.1 defined in 3GPP TS 36.141 as representative for worst case setting. The test object was powered with -48 VDC. All measurements were performed with the test object configured for maximum transmit power.

**WCDMA Operation mode during measurements**

Measurements in MIMO configuration were performed with the test object transmitting the test model 5 as representative for worst case setting. Measurements in multi standard (MSR) configuration were performed with the test object transmitting the test model 1 as representative for worst case setting. The test models are defined in 3GPP TS 25.141. Test model 1 (TM1) uses the QPSK modulation only. Test model 5 (TM5) includes the 16QAM modulation.

The following detailed settings were used:

MIMO configuration:

Single carrier

TM5: 30 DPCH:s at 30 ksps and 8 HS-PDSCH (SF=128)

Multi carrier (Two carriers)

TM5: 30 DPCH:s at 30 ksps and 8 HS-PDSCH (SF=128)

MSR Configuration:

TM1: 16 DPCH:s at 30 ksps (SF=128)

Channel bandwidth 5 MHz

**Conducted measurements**

The EUT was mounted in a RBS 6201 cabinet and supplied by the cabinet's internal -48 V DC. All RF conducted measurements were performed with the test object configured for maximum transmit power. The measurements were made on RUS 1 in MIMO mode when the object was primary linked to the DU. Additional measurements on RUS 1, when linked in secondary mode relative to DU, were made in order to verify identical performance.

**Radiated measurements**

The test object was powered with -48 VDC. All measurements were performed with the test object configured for maximum transmit power

## Appendix 1

### **Purpose of test**

The purpose of this test is to justify a Class II Permissive Change of the test object to include the use of MIMO and MSR for LTE and WCDMA access technology.

The purpose of the tests is to verify compliance to the performance characteristics specified in applicable items of FCC CFR 47 and Industry Canada RSS-139 and RSS-Gen.

### **References**

Measurements were done according to relevant parts of the following standards:

ANSI 63.4-2009

ANSI/TIA/EIA-603-C-2004

CFR 47 part 2, October 1<sup>st</sup>, 2011

CFR 47 part 27, October 1<sup>st</sup>, 2011

3GPP TS 25.141, version 8.9.0

RSS-Gen Issue 3

RSS-139 Issue 2

## Appendix 1

**Measurement equipment**

	Calibration Due	SP number
Test site Tesla	2014-01	503 881
R&S FSIQ 40	2013-07	503 738
R&S FSQ 40	2013-05	504 143
R&S ESU 26	2013-09	901 553
Control computer with R&S software EMC32 version 8.52.0	-	503 479
High pass filter	2013-07	901 502
High pass filter	2013-07	504 199
High pass filter	2013-08	901 373
High pass filter	2014-08	503 739
High pass filter	2013-07	503 740
Directional coupler	2013-07	901 496
RF attenuator	2013-07	504 159
RF attenuator	2013-09	900 233
RF attenuator	2013-08	900 691
Chase Bilog Antenna CBL 6111A	2014-10	503 182
EMCO Horn Antenna 3115	2014-01	502 175
Std.gain horn FLANN model 20240-20	2014-03	503 674
µComp Nordic, Low Noise Amplifier	2013-03	901 545
MITEQ Low Noise Amplifier	2013-08	503 285
Testo 635 Temperature and humidity meter	2013-06	504 203
Temperature and humidity meter, Testo 625	2013-06	504 188

**Uncertainties**

Measurement and test instrument uncertainties are described in the quality assurance documentation "SP-QD 10885". The uncertainties are calculated with a coverage factor  $k=2$  (95% level of confidence).

Compliance evaluation is based on a shared risk principle with respect to the measurement uncertainty.

**Reservation**

The test results in this report apply only to the particular test object as declared in the report.

**Delivery of test object**

The test object was delivered 2012-10-25.

**Manufacturer's representative**

Christer Gustavsson, Ericsson AB.



## Appendix 1

### **Test engineers**

Andreas Johnson, Tomas Lennhager, Tomas Isbring, Hyder Khalaf, Kexin Chen, Jörgen Wassholm and Martin Theorin, SP

### **Test participant**

None

Appendix 1

**Test set-up conducted measurements TX, MIMO LTE**

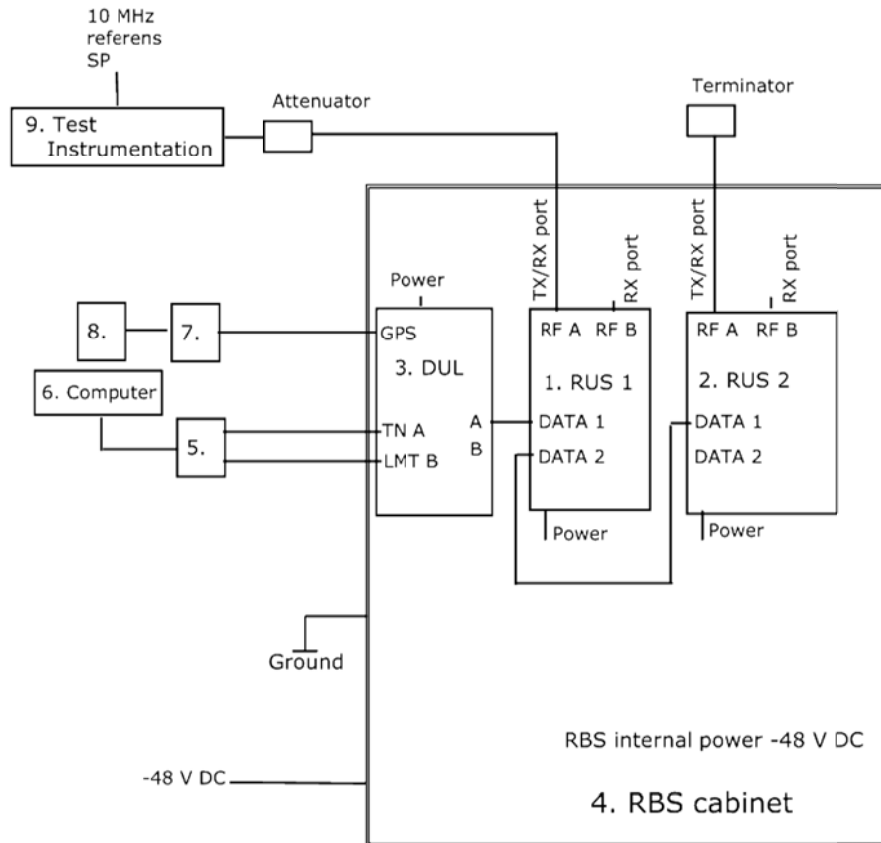

**Test object**

- 1-2. RUS 01 B4, KRC 118 59/2, revision R2B, S/N: C825565829 (RUS 1)  
RUS 01 B4, KRC 118 59/2, revision R2B, S/N: C825565888 (RUS 2)

(FCC ID: TA8AKRC11859-2 / IC: 287AB-AS118592)  
with software (PIS): CXP 901 7316/1 rev. R44FJ  
unlocked working software CXP 901 3268/6 R49AF

**Functional test equipment**

- 3. DUL 02 01, KDU 137 533/4, Rev R1D, S/N: C823997200
- 4. RBS 6201 cabinet, BAMS 1000778792  
PDU 02 01, BMG 980 336/4, revision R2A, S/N: BJ31528316
- 5. Fast Ethernet Switch: NETGEAR 10/100 Mbps model: FS108
- 6. Controlling laptop HP Elitebook 8540w, BAMS 1001053032  
running software MOSHELL V9.0c
- 7. GPS 02 01, NCD 901 41/1, rev. R1D, s/n: TU8K356490
- 8. GPS antenna
- 9. Signal Analyzer, R&S FSQ 40

Appendix 1

**Test set-up conducted measurements TX, MIMO WCDMA**

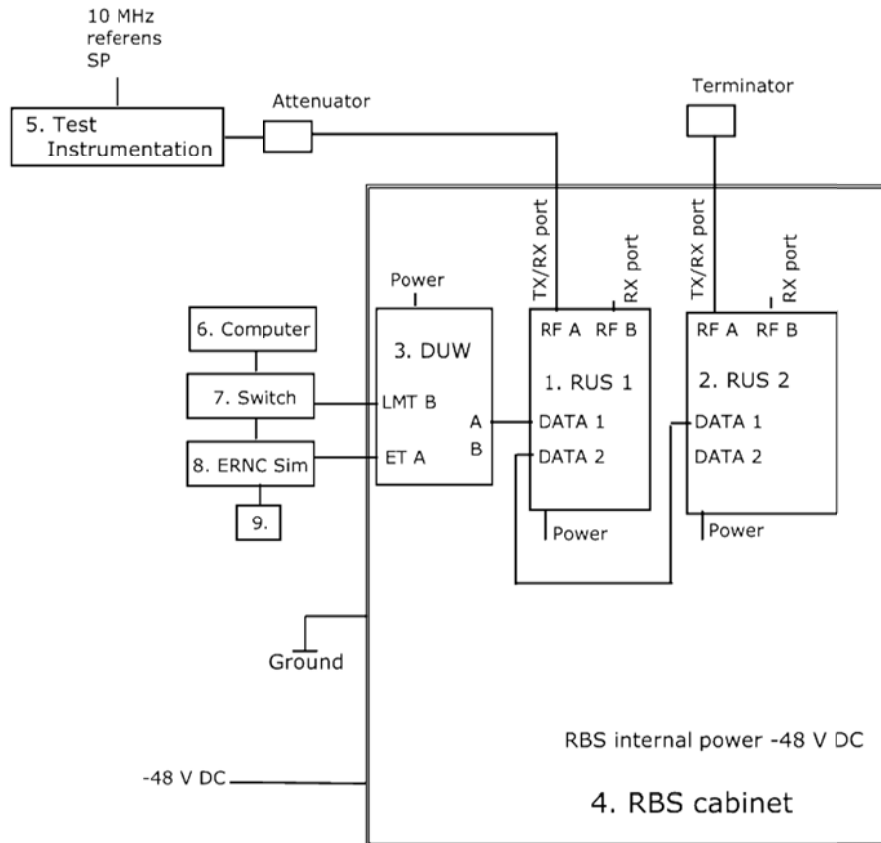

**Test object**

- 1-2. RUS 01 B4, KRC 118 59/2, revision R2B, S/N: C825565829 (RUS 1)  
RUS 01 B4, KRC 118 59/2, revision R2B, S/N: C825565888 (RUS 2)

(FCC ID: TA8AKRC11859-2 / IC: 287AB-AS118592)  
with software (PIS): CXP 901 7316/1 rev. R44FJ  
unlocked working software CXP 901 3268/6 R49AF

**Functional test equipment**

- 3. DUW 30 01, KDU 127 161/3, rev:R4E, s/n: C826303727
- 4. RBS 6201 cabinet, BAMS 1000778792  
PDU 02 01, BMG 980 336/4, revision R2A, S/N: BJ31528316
- 5. Signal Analyzer, R&S FSQ 40
- 6. Controlling laptop HP Elitebook 8540w, BAMS 1001053032  
running software MOSHELL V9.0c
- 7. Fast Ethernet switch, Netgear FS726G
- 8. ERNC Sim 127
- 9. Symmetricon 8040, BAMS 1000714186

Appendix 1

Test set-up conducted measurements TX, MSR

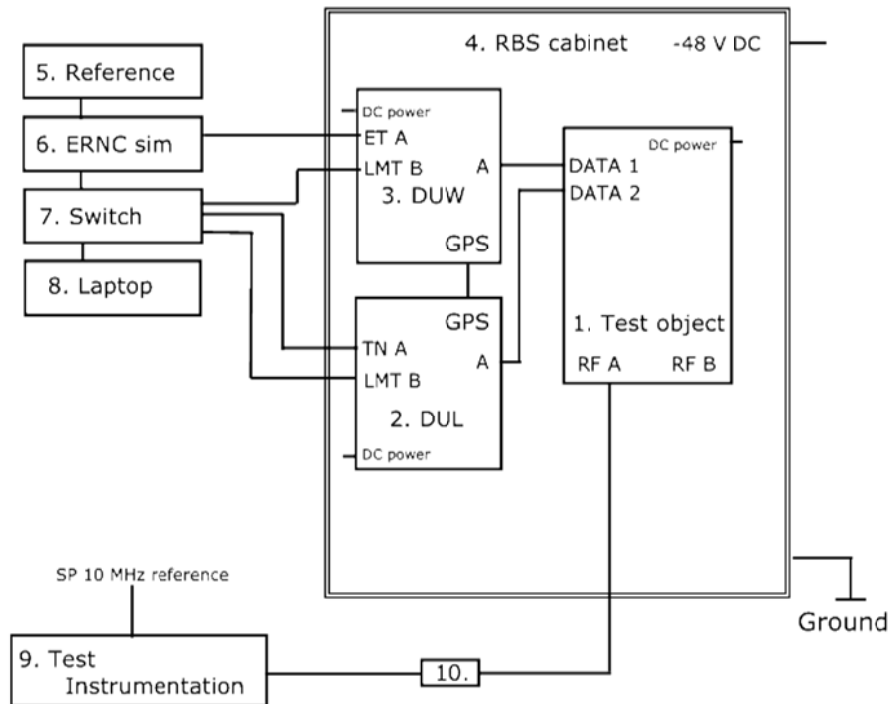

**Test object**

1. RUS 01 B4, KRC 118 59/2, revision R2B, S/N: C825565829 (RUS 1)  
 (FCC ID: TA8AKRC11859-2 / IC: 287AB-AS118592)  
 with software (PIS): CXP 901 7316/1 rev. R44FJ  
 unlocked working software CXP 901 3268/6 R49AF

**Functional test equipment**

2. DUL 02 01, KDU 137 533/4, Rev R1D, S/N: C823997200
3. DUW 30 01, KDU 127 161/3, rev:R4E, s/n: C826303727
4. RBS 6201 cabinet, BAMS 1000778792  
 PDU 02 01, BMG 980 336/4, revision R2A, S/N: BJ31528316
5. Symmetricon 8040, BAMS 1000714186
6. ERNC Sim 127
7. Fast Ethernet switch, Netgear FS726G
8. Controlling laptop HP Elitebook 8540w, BAMS 1001053032  
 running software MOSHELL V9.0c
9. Signal Analyzer, R&S FSQ 40



Appendix 1

Test set-up radiated measurements

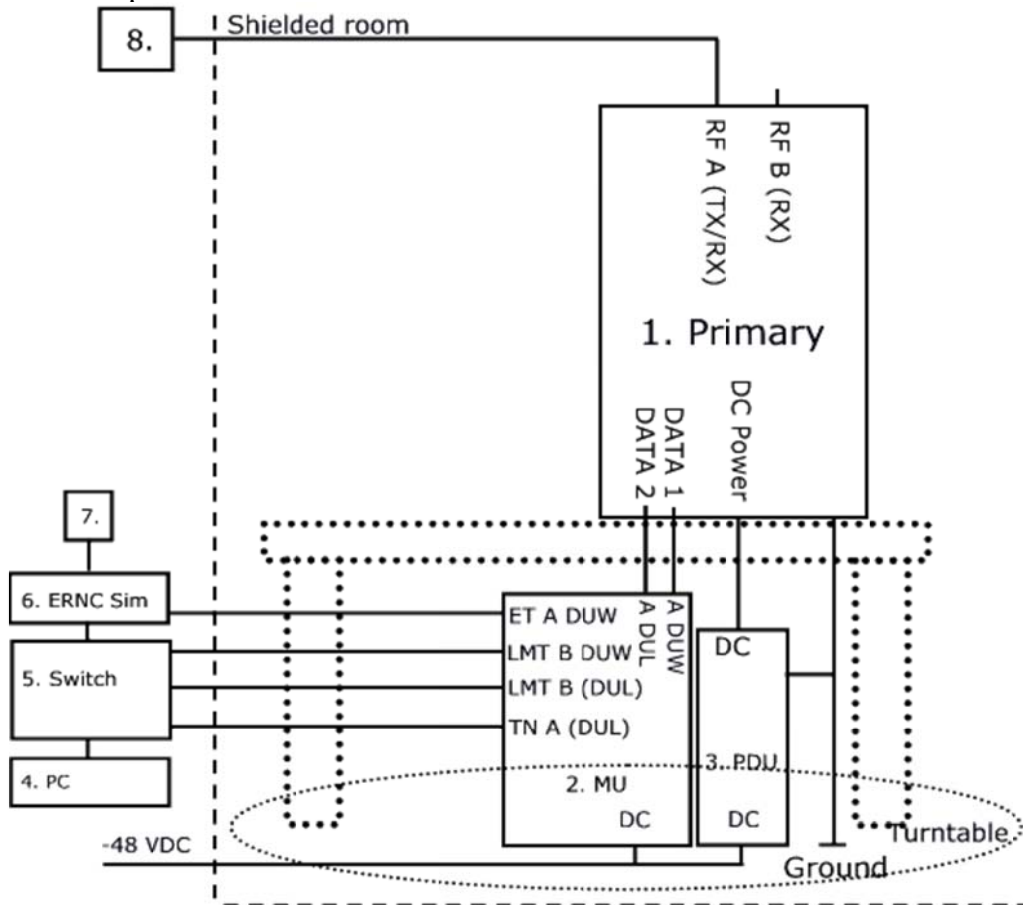

Test object:

1.	RUS 1: RUS 01 B4, KRC 118 59/2, rev. R2B, s/n: C825565829 with PIS software CXP 901 7316/1 rev. R44FJ, unlocked working software for LTE: CXP 901 3268/6 R49AF RUS 2: RUS 01 B4, KRC 118 59/2, rev. R2B, s/n: C825565888 with PIS software CXP 901 7316/1 rev. R44FJ, unlocked working software for LTE: CXP 901 3268/6 R49AF
----	--

Appendix 1

**Functional test equipment:**

2.	DUW 30 01, KDU 127 161/3, rev: R4E, s/n: C826303727 hosted in SUP 6601 1/BFL 901 009/1 rev: R2A, s/n. BR80879339 DUL 20 01 KDU 137 533/4 R1D C823997200, hosted in SUP 6601 1/BFL 901 009/1 Rev R3C, S/N. BR81734294
3.	Power Subrack: PDU 01 01, BMG 980 336/2, R4F, BJ31532384 PDU 01 01, BMG 980 336/2, R4F, BJ31532382 SHU 01 01, BGK 901 18/1, R3C, BJ31446269 PFU 01 01, KFE 101 1162/1, R1B, BR80910495 PCF 02 01, KFE 101 1157/1, R1C, BW95301450 DUMMY x3, SXX 109 8257/1, R1D DUMMY x1, SXX 109 8257/1, R1F
4.	Computer HP Elitebook 8540w, BAMS – 1001052043
5.	Fast Ethernet switch, Netgear FS726G
6.	ERNC Sim 127
7.	Symmetricon 8040, BAMS 1000714186
8.	Terminator

Interface:	Type of port:
Power: -48 VDC	DC Power
Antenna port (A), 7/16 connector, combined TX/RX	Antenna
Antenna port (B), 7/16 connector, only RX	Antenna
Data 1, electrical interface	Signal
Data 2, electrical interface, used for MSR	Signal
RXA I/O cross connector, used for MIMO	Signal
RXA OUT cross connector, unused	Signal
RXB I/O cross connector, used for MIMO	Signal
Ground wire	Ground

**RBS software**

	Software	Revision
DUL	CXP 102 051/16	R23BV
DUW	CXP 901 8350/1	R9V16

Appendix 2

**RF power output measurements according to CFR 47 §27.50 / IC RSS-139 6.4**

Date	Temperature	Humidity
2012-11-12	23 °C ± 3 °C	26 % ± 5 %
2012-11-13	23 °C ± 3 °C	23 % ± 5 %
2012-11-21	23 °C ± 3 °C	31 % ± 5 %
2012-11-22	23 °C ± 3 °C	28 % ± 5 %
2012-11-23	23 °C ± 3 °C	30 % ± 5 %
2012-11-30	23 °C ± 3 °C	16 % ± 5 %

**Test set-up and procedure**

The test object was connected to a signal analyzer measuring peak and RMS output power in CDF mode. A resolution bandwidth of 60 MHz was used.

Measurement equipment	SP number
R&S FSQ	504 143
RF attenuator	504 159
RF attenuator	901 384
RF attenuator	900 233
Directional coupler	901 496
Testo 635, temperature and humidity meter	504 203

**Measurement uncertainty: 1.1 dB**

Appendix 2

**Results**

**LTE:**

Single carrier: 1x LTE: Rated output power level at RF connector 1x 49 dBm

Test conditions Bandwidth/ Frequency	Transmitter power RMS (dBm)		
	RUS 1 Primary linked	RUS 1 Secondary linked	Primary+ Secondary <sup>1)</sup>
BW 1.4MHz, M	48.02	47.98	51.01
BW 3MHz, M	48.18	48.10	51.15
BW 5MHz, M	48.15	48.15	51.16
BW 10MHz, M	48.17	48.19	51.19
BW 15MHz, M	48.15	48.24	51.17
BW 20MHz ,M	48.25	48.18	51.23

Diagram	BW configuration	Tested frequency	Tested port
1	1.4 MHz	M	RUS 1, Primary linked
2	1.4 MHz	M	RUS 1, Secondary linked
3	3 MHz	M	RUS 1, Primary linked
4	3 MHz	M	RUS 1, Secondary linked
5	5 MHz	M	RUS 1, Primary linked
6	5 MHz	M	RUS 1, Secondary linked
7	10 MHz	M	RUS 1, Primary linked
8	10 MHz	M	RUS 1, Secondary linked
9	15 MHz	M	RUS 1, Primary linked
10	15 MHz	M	RUS 1, Secondary linked
11	20 MHz	M	RUS 1, Primary linked
12	20 MHz	M	RUS 1, Secondary linked

Appendix 2

WCDMA

Single carrier:1x WCDMA: Rated output power level at RF connector 1x 47 dBm/ RF port

Tested frequency	Transmitter power RMS (dBm)		
	RUS 1 Primary linked	RUS 1 Secondary linked	Primary+ Secondary <sup>1)</sup>
M	46.45	46.43	49.45

Multi carrier:2x WCDMA: Rated output power level at RF connector 2x 46 dBm/ RF port

Tested frequency	Transmitter power RMS (dBm)		
	RUS 1 Primary linked	RUS 1 Secondary linked	Primary+ Secondary <sup>1)</sup>
M+(M+5)	48.30	48.35	51.34

Diagram	Tested frequency	Tested port
13	M+(M+5)	RUS 1, primary linked
14	M+(M+5)	RUS 1, secondary linked
15	M	RUS 1, primary linked
16	M	RUS 1, secondary linked

Appendix 2

**MSR, LTE+WCDMA:**

LTE+ WCDMA. Rated output power level at RF connector 2x 46 dBm/ RF port

Test configurations	Transmitter power RMS (dBm)
	RFA
Configuration 1	48.24
Configuration 4	48.31
Configuration 5	48.04
Configuration 6	47.84
Configuration 7	48.24

Diagram	Tested configuration	Tested port
17	Configuration 1	RF A
18	Configuration 4	RF A
19	Configuration 5	RF A
20	Configuration 6	RF A
21	Configuration 7	RF A

<sup>1)</sup>: 2 outputs summed power according to FCC KDB662911 Multiple transmitter output v01r02



Appendix 2

**Limits**

§27.50: The maximum output power may not exceed 1640 W (EIRP)/ MHz.  
The Peak to Average Ratio (PAR) may not exceed 13 dB.

RSS-139 6.4: The average equivalent isotropically radiated power (e.i.r.p.) limits in SRSP-513 apply, resulting in a maximum EIRP of 1640 W/ MHz for the scope of this report. The peak-to-average ratio of the power shall not exceed 13 dB.

Complies?	Yes
-----------	-----

Appendix 2

Diagram 1:

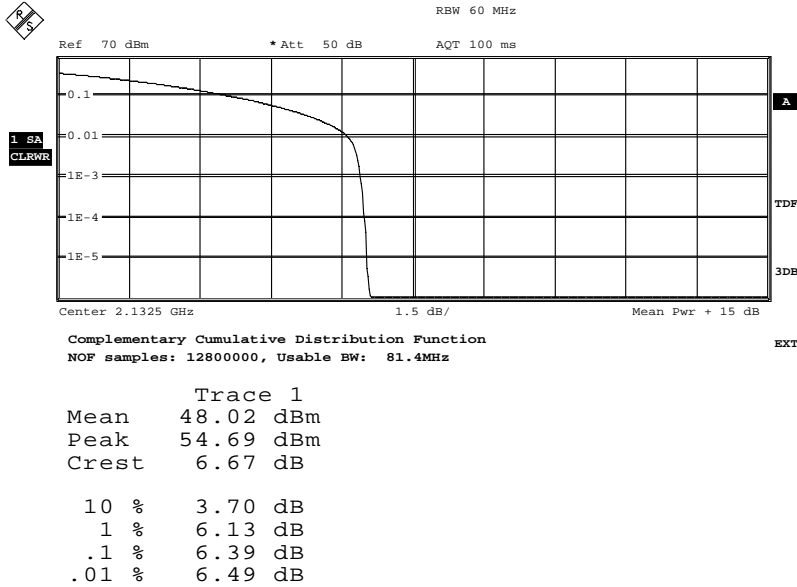

Date: 12.NOV.2012 12:51:55

Diagram 2:

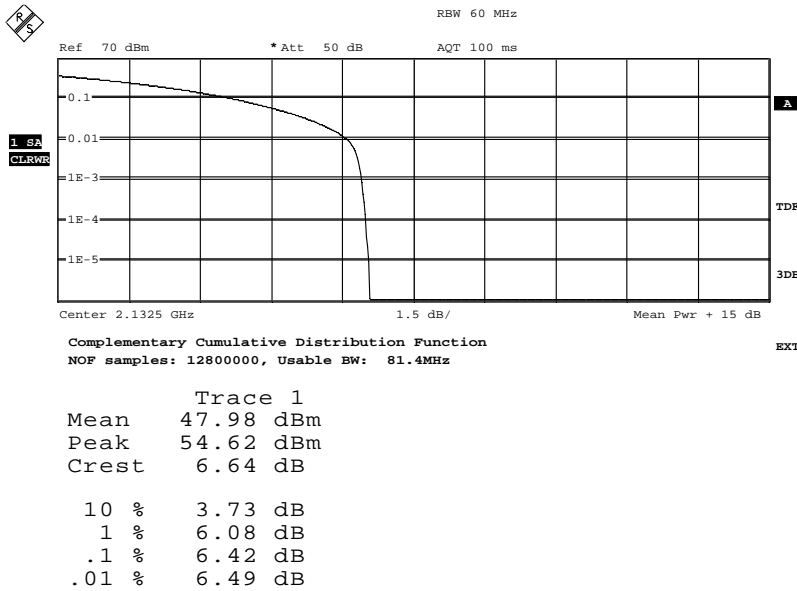

Date: 13.NOV.2012 07:54:44



Appendix 2

Diagram 3:

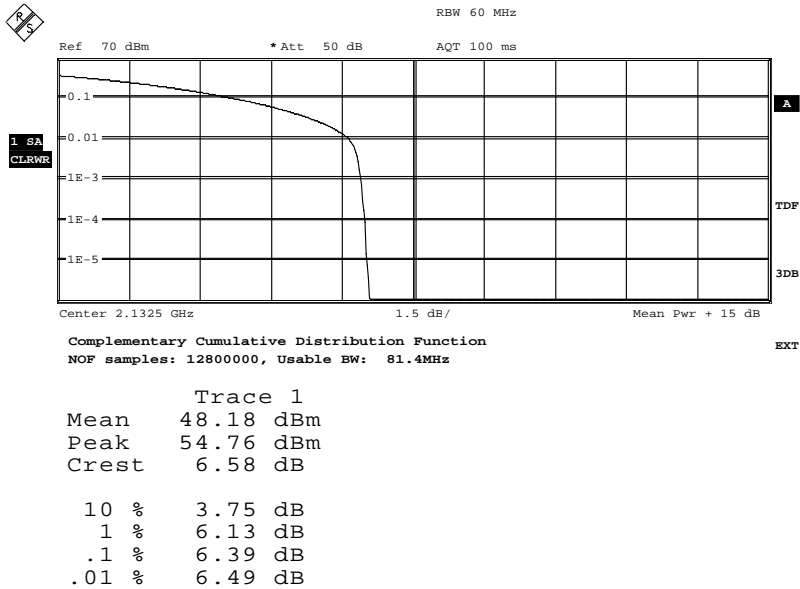

Date: 12.NOV.2012 13:12:30

Diagram 4:

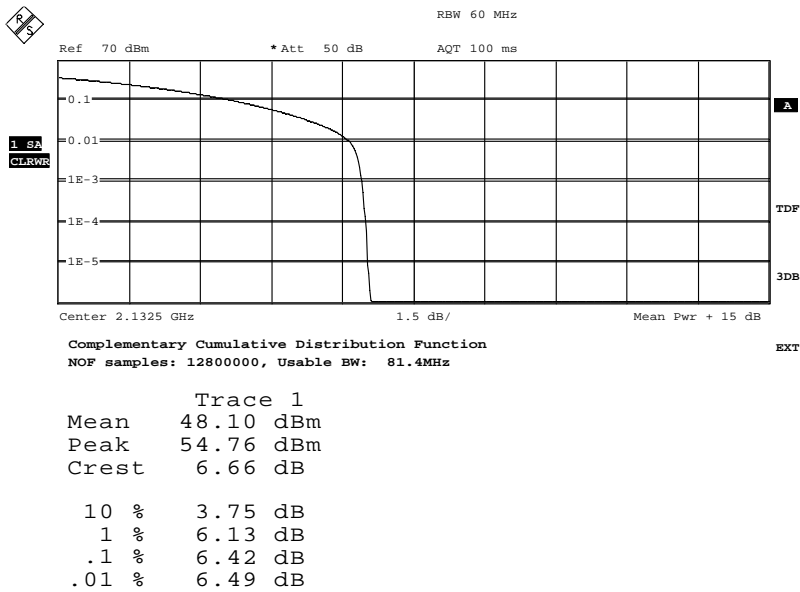

Date: 13.NOV.2012 07:56:27

Appendix 2

Diagram 5:

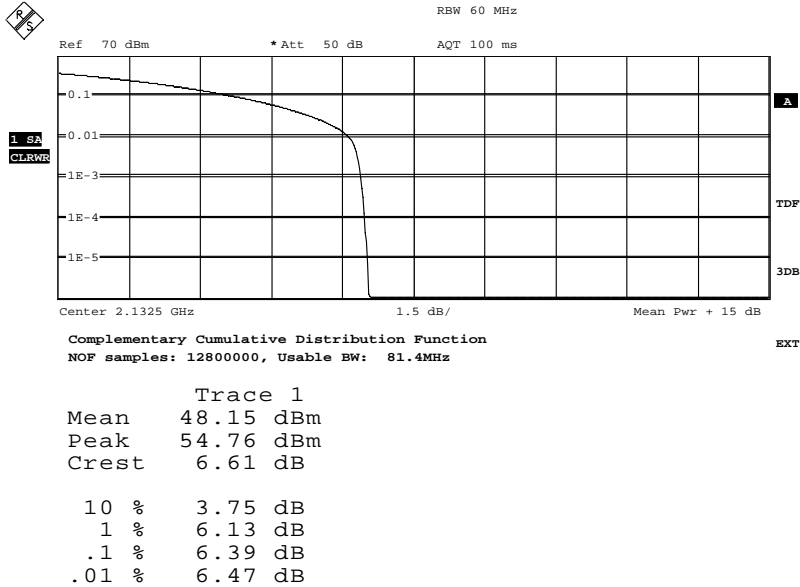

Date: 12.NOV.2012 13:21:45

Diagram 6:

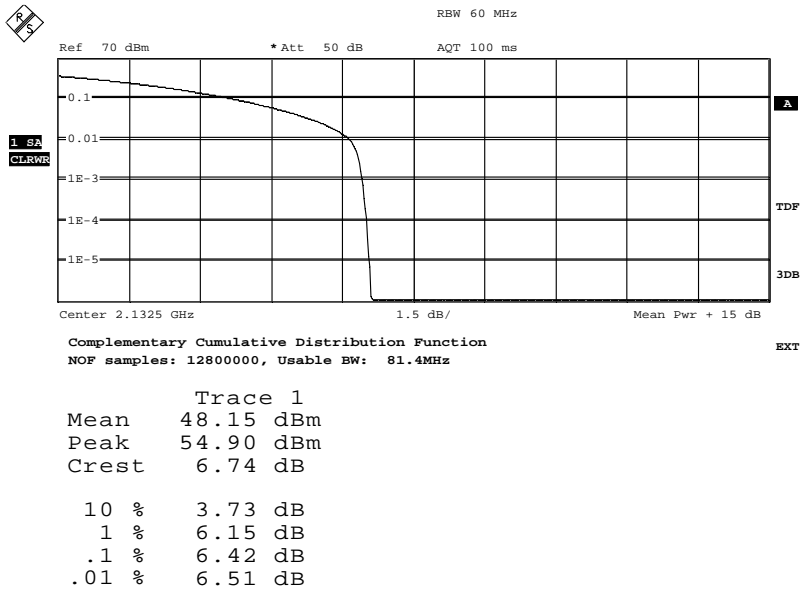

Date: 13.NOV.2012 07:57:44

Appendix 2

Diagram 7:

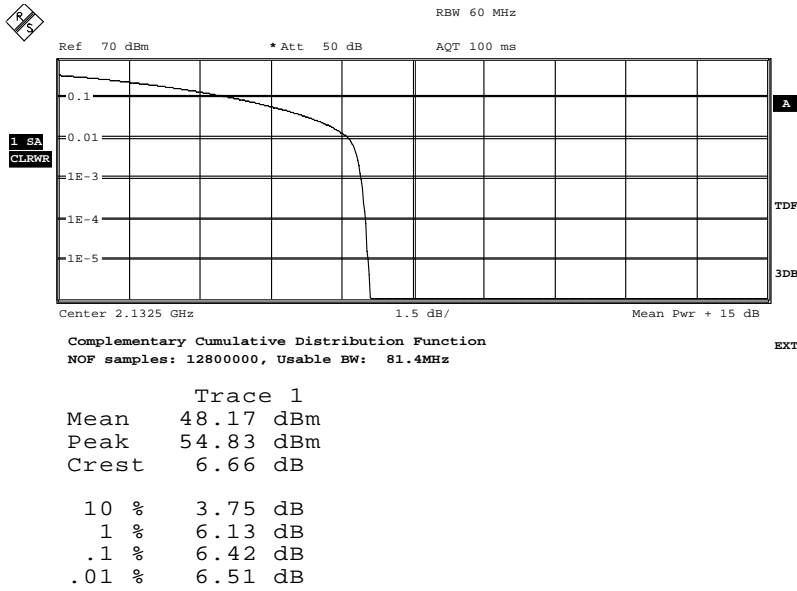

Date: 12.NOV.2012 13:24:39

Diagram 8:

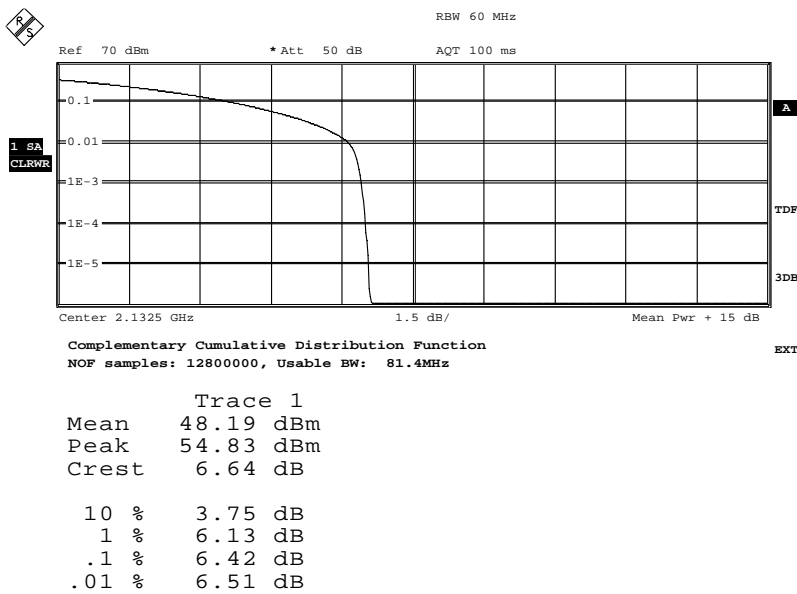

Date: 13.NOV.2012 07:59:04

Appendix 2

Diagram 9:

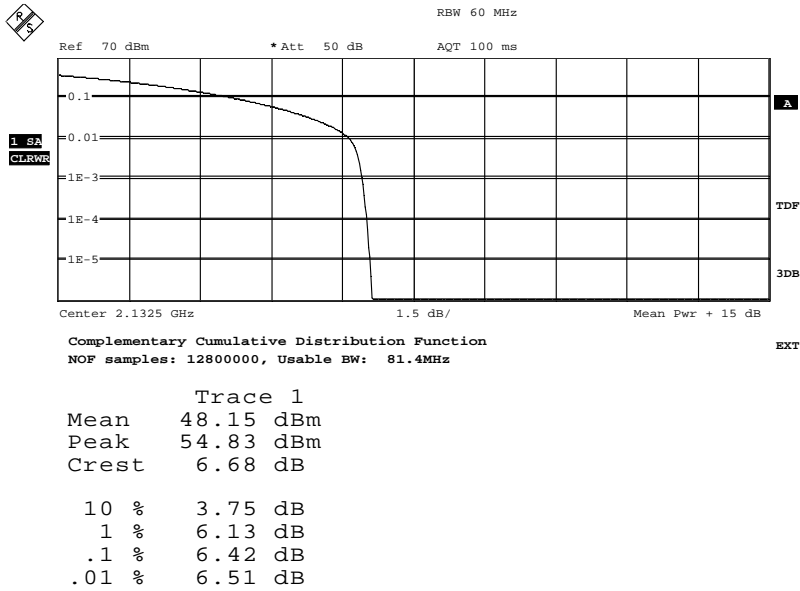

Date: 12.NOV.2012 13:36:10

Diagram 10:

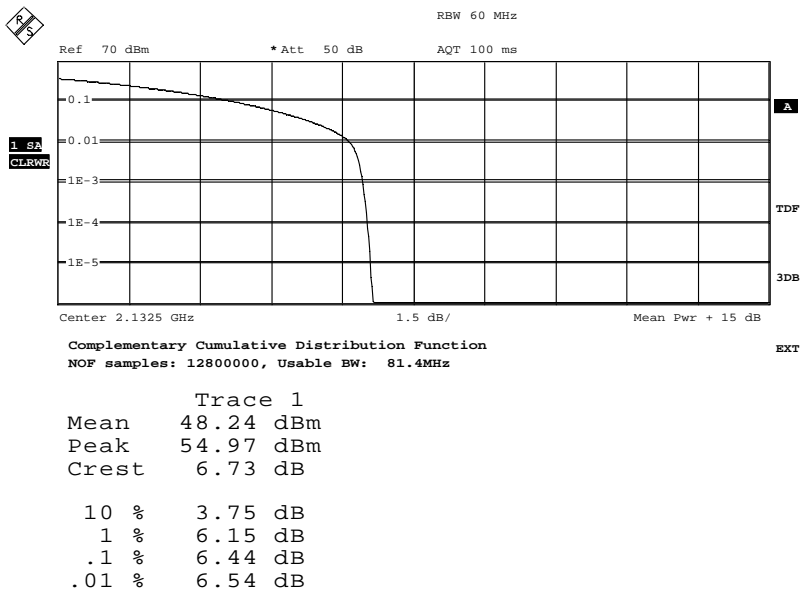

Date: 13.NOV.2012 08:00:43

Appendix 2

Diagram 11:

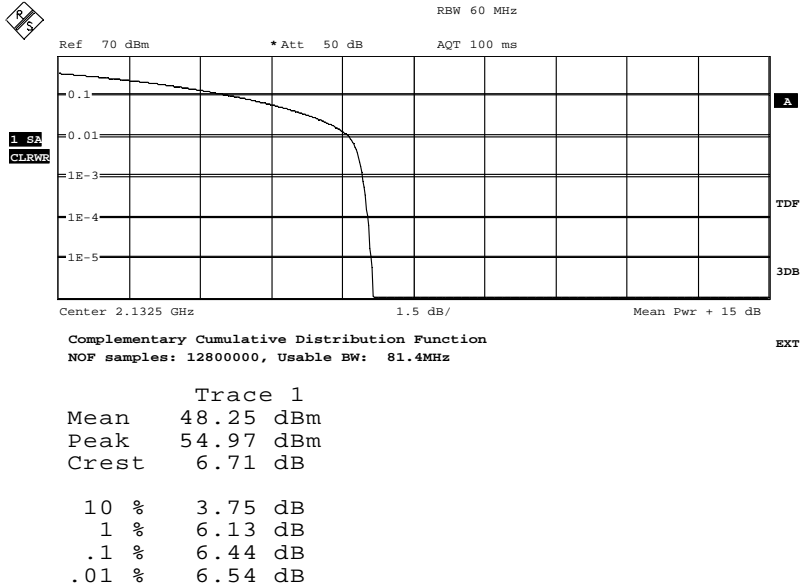

Date: 12.NOV.2012 13:37:32

Diagram 12:

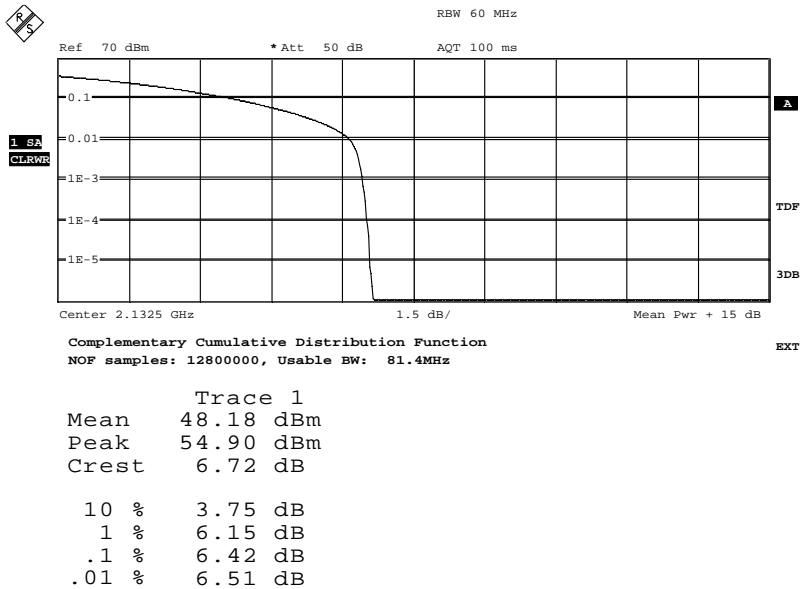

Date: 12.NOV.2012 15:40:41

Appendix 2

Diagram 13:

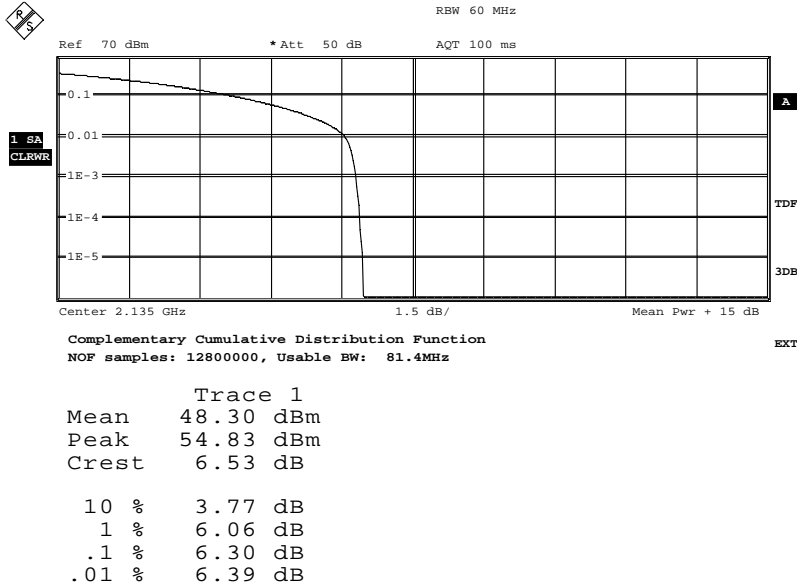

Date: 21.NOV.2012 08:57:12

Diagram 14:

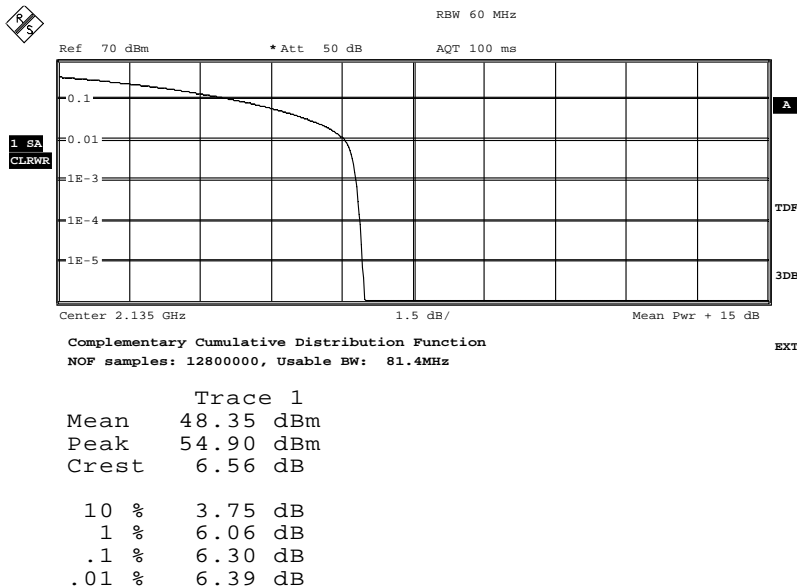

Date: 21.NOV.2012 09:33:20

Appendix 2

Diagram 15:

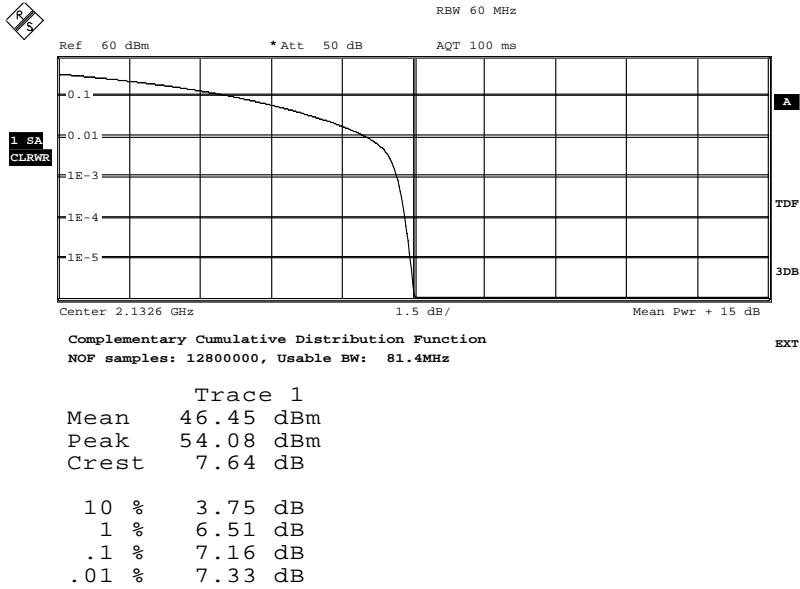

Date: 30.NOV.2012 12:02:34

Diagram 16:

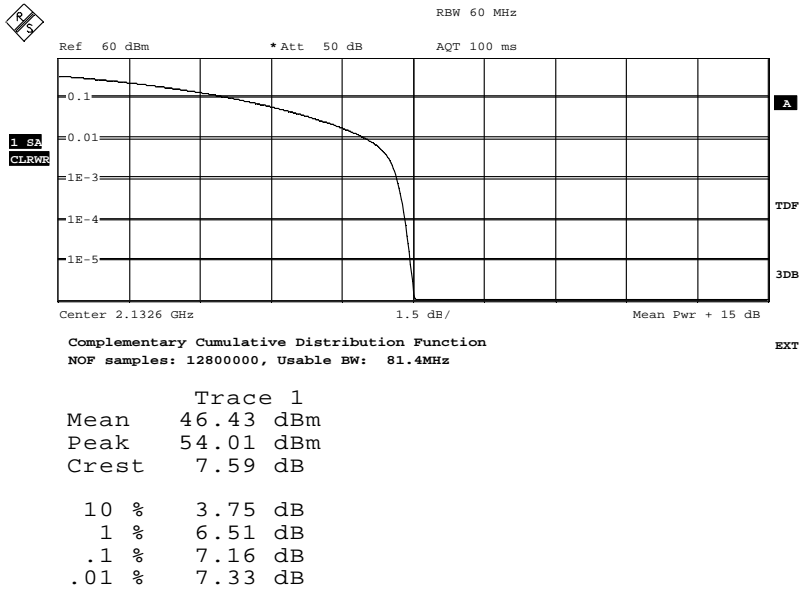

Date: 30.NOV.2012 12:32:00

Appendix 2

Diagram 17:

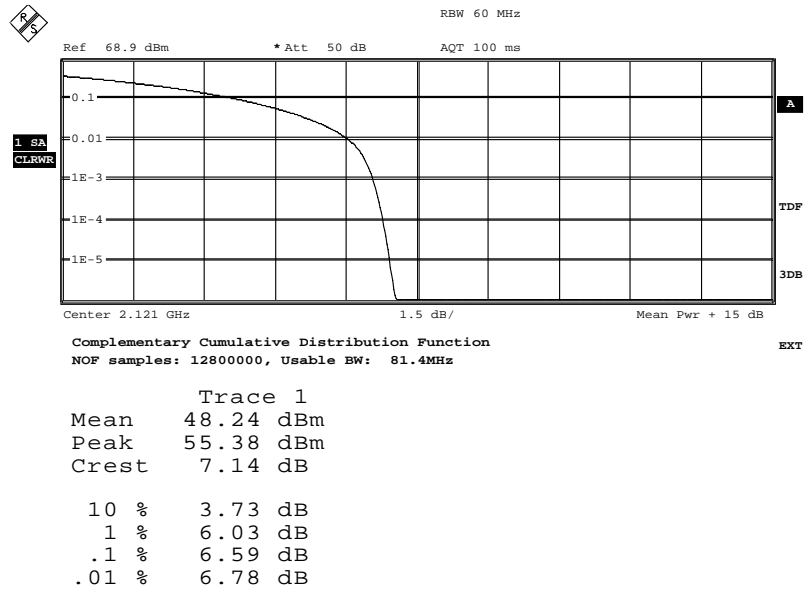

Date: 22.NOV.2012 08:33:20

Diagram 18:

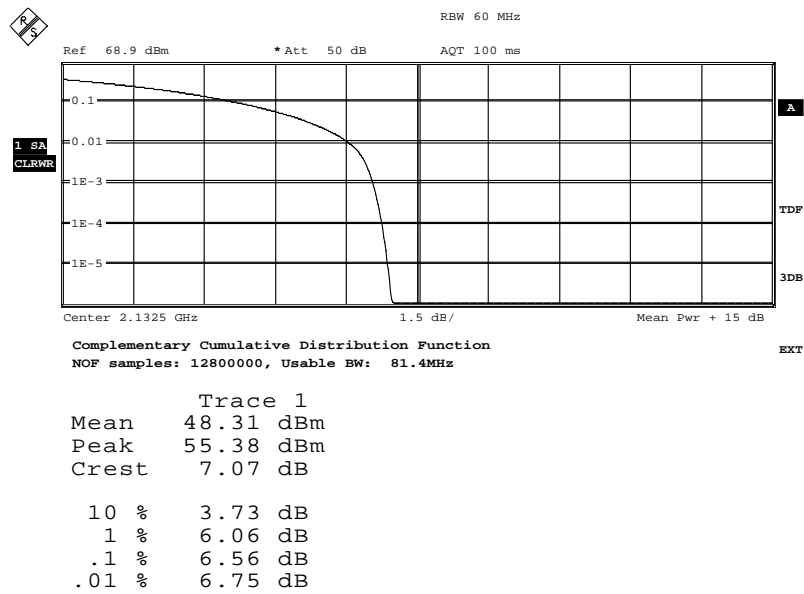

Date: 23.NOV.2012 08:05:28



Appendix 2

Diagram 19:

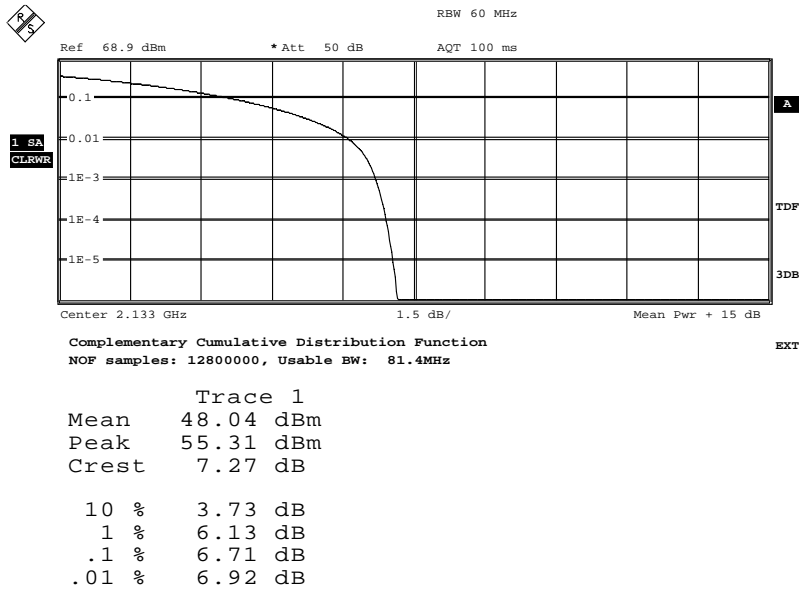

Date: 23.NOV.2012 07:37:51

Diagram 20:

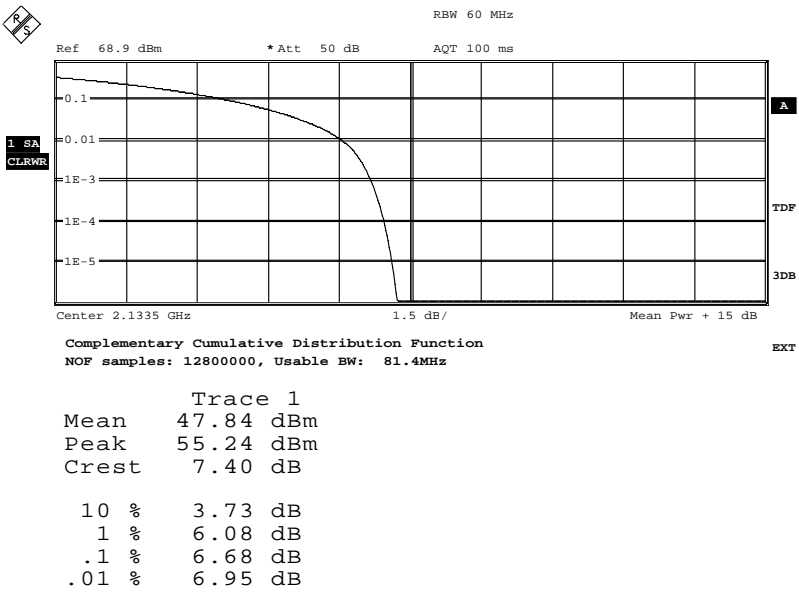

Date: 22.NOV.2012 12:10:53

Appendix 2

Diagram 21:

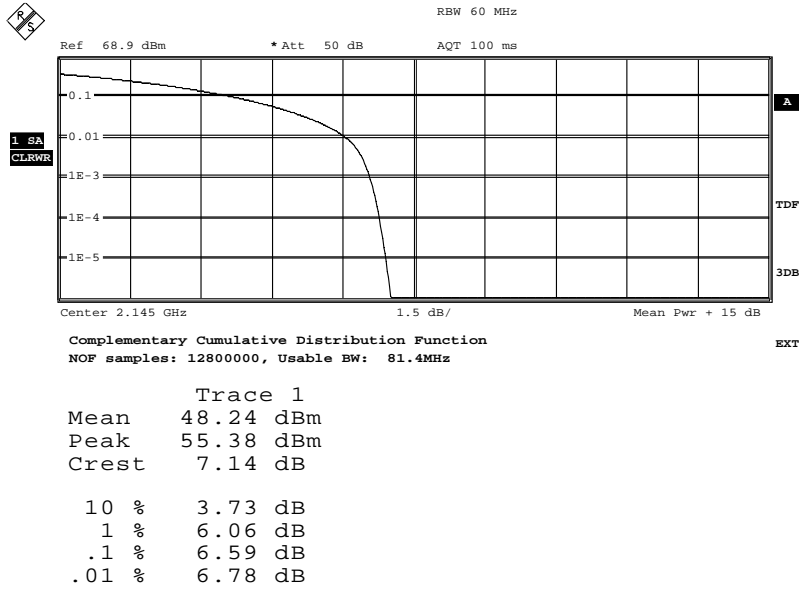

Date: 23.NOV.2012 09:13:14

Appendix 3

**Occupied bandwidth measurements according to 47 CFR 2.1049 / RSS-Gen 4.6.1**

Date	Temperature	Humidity
2012-11-12	23 °C ± 3 °C	26 % ± 5 %
2012-11-13	23 °C ± 3 °C	23 % ± 5 %
2012-11-30	23 °C ± 3 °C	16 % ± 5 %

**Test set-up and procedure**

The measurements were made per definition in §2.1049. The output was connected to a signal analyzer with the RMS detector activated. The signal analyzer was connected to an external 10 MHz reference standard during the measurements.

Measurement equipment	SP number
R&S FSQ	504 143
RF attenuator	504 159
RF attenuator	901 384
RF attenuator	900 233
Directional coupler	901 496
Testo 635, temperature and humidity meter	504 203

Measurement uncertainty: 3.7 dB

**Results**

**LTE:**

Diagram	BW Configuration [MHz]	Tested frequency	Tested Port	Occupied BW (99%) [MHz]
1	1.4 MHz	M	RUS 1, primary linked	1.09
2	1.4 MHz	M	RUS 1, secondary linked	1.09
3	3 MHz	M	RUS 1, primary linked	2.69
4	5 MHz	M	RUS 1, primary linked	4.48
5	10 MHz	M	RUS 1, primary linked	8.94
6	15 MHz	M	RUS 1, primary linked	13.44
7	20 MHz	M	RUS 1, primary linked	17.88
8	20 MHz	M	RUS 1, secondary linked	17.88

## Appendix 3

**WCDMA:**

Diagram	BW Configuration [MHz]	Tested frequency	Tested Port	Occupied BW (99%) [MHz]
9	5 MHz	M	RUS 1, primary linked	4.17
10	5 MHz	M	RUS 1, secondary linked	4.17

Appendix 3

Diagram 1:

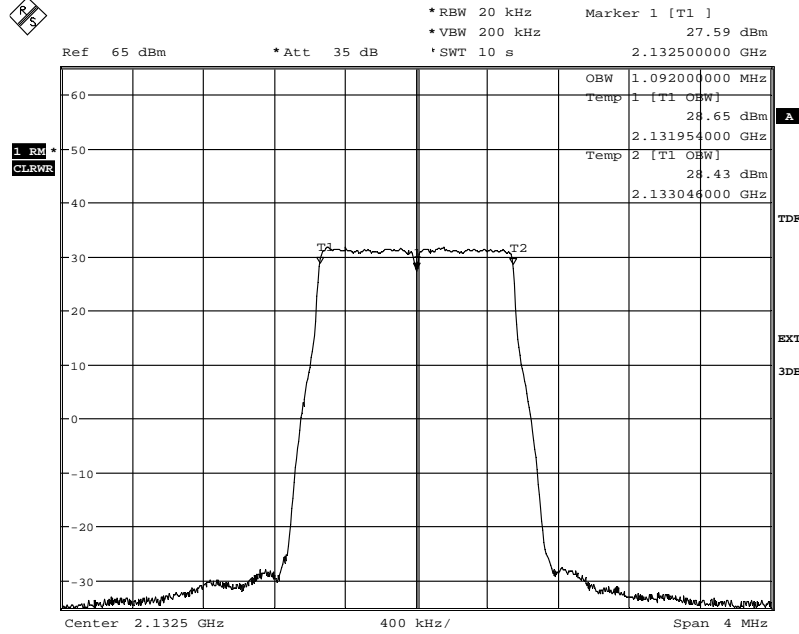

Date: 12.NOV.2012 12:56:44

Diagram 2:

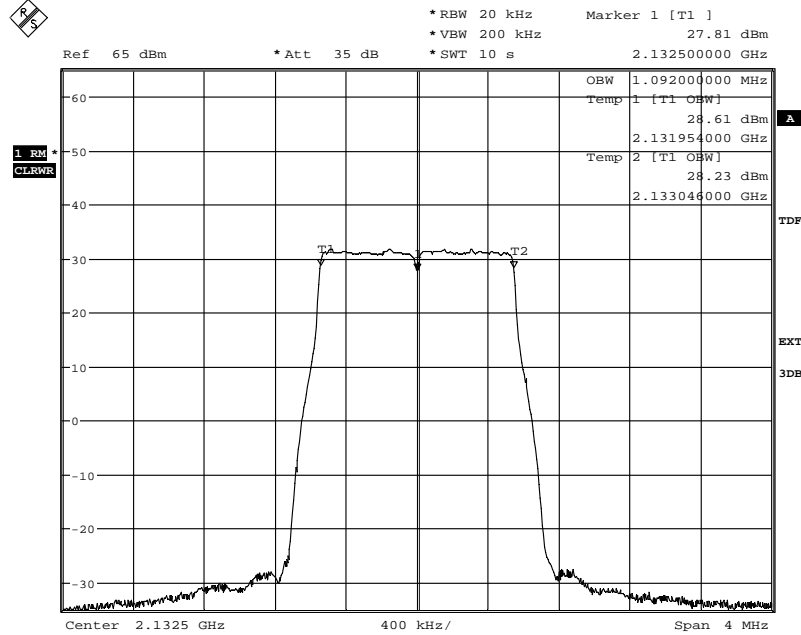

Date: 13.NOV.2012 07:52:50

Appendix 3

Diagram 3:

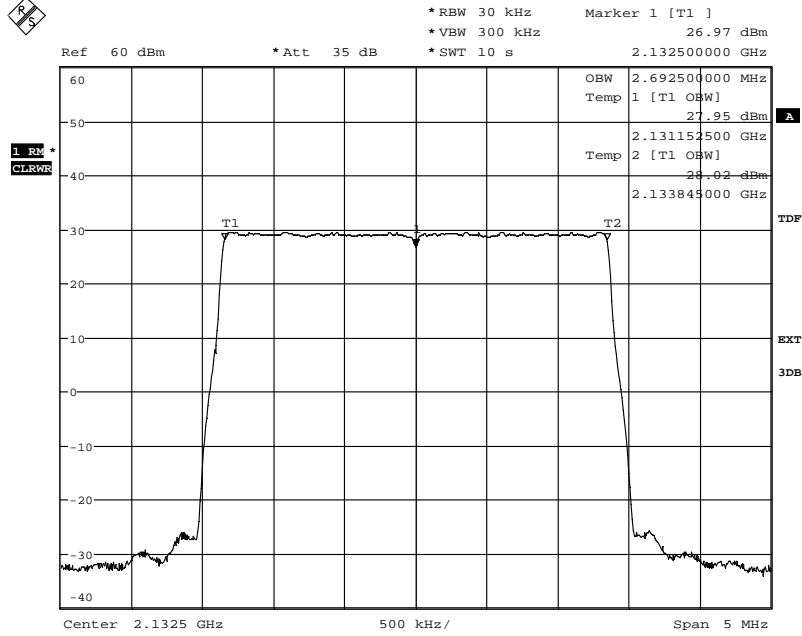

Date: 12.NOV.2012 13:15:10

Diagram 4:

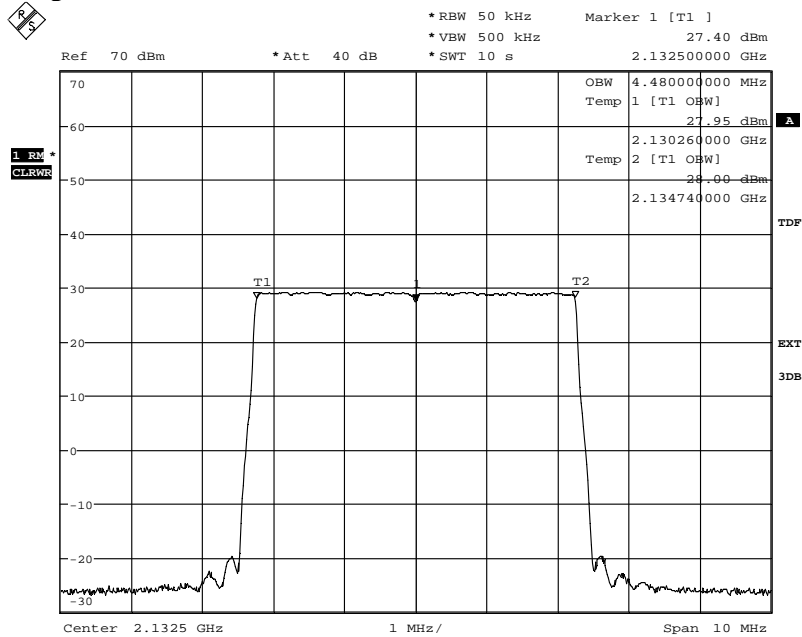

Date: 12.NOV.2012 13:31:46

Appendix 3

Diagram 5:

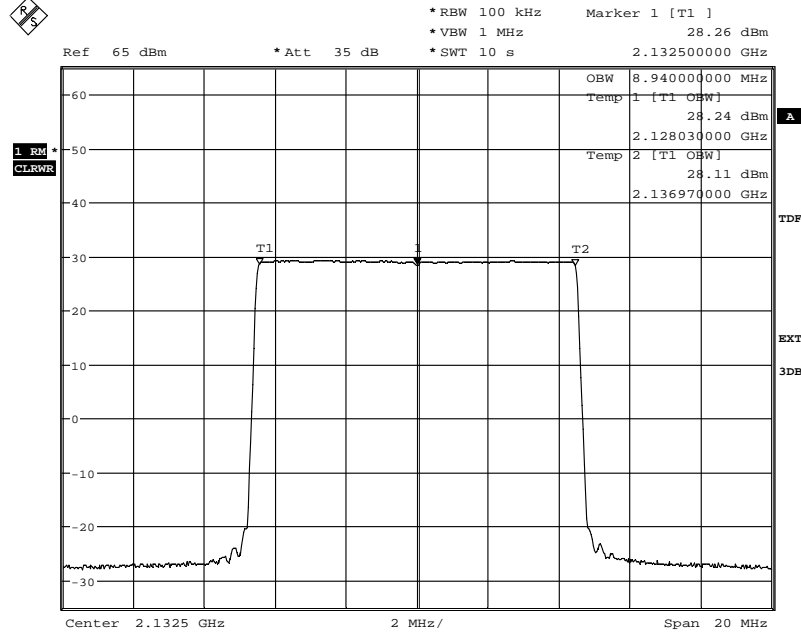

Date: 12.NOV.2012 13:26:09

Diagram 6:

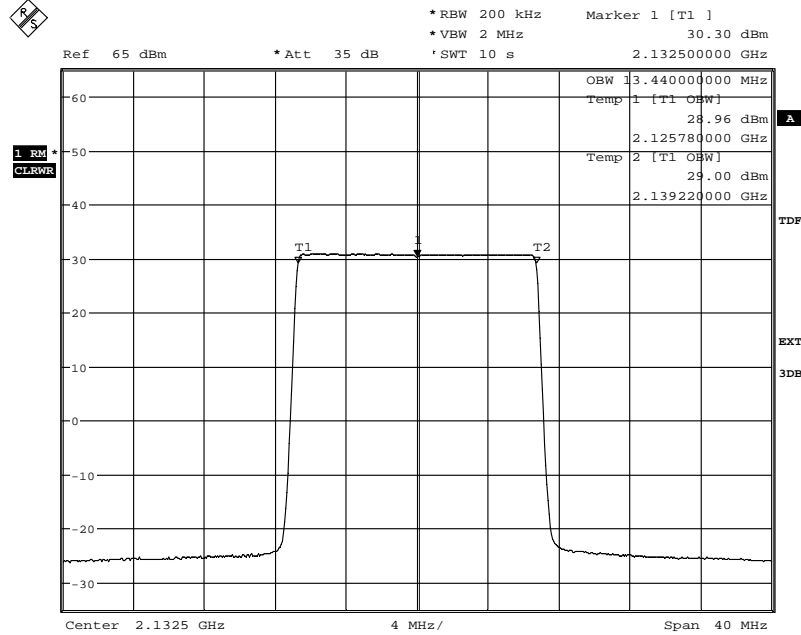

Date: 12.NOV.2012 13:35:05

Appendix 3

Diagram 7:

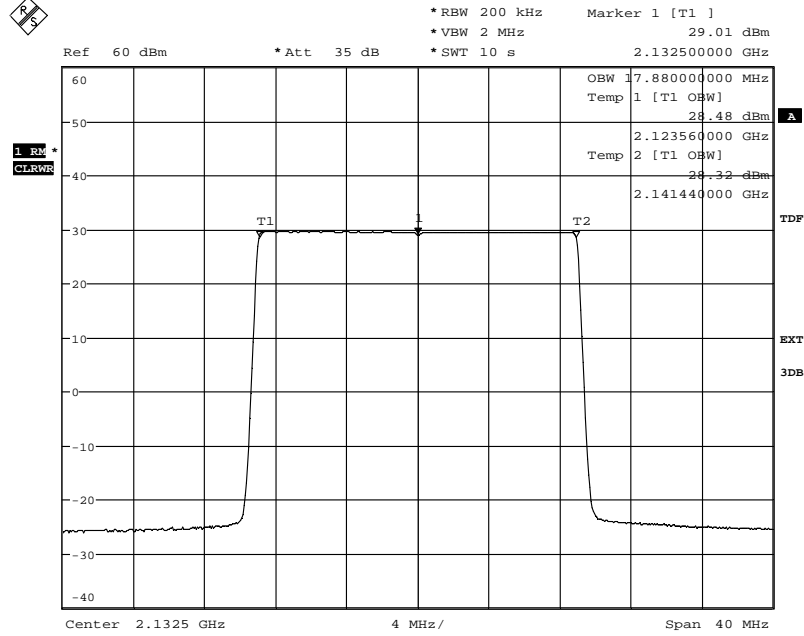

Date: 12.NOV.2012 13:38:15

Diagram 8:

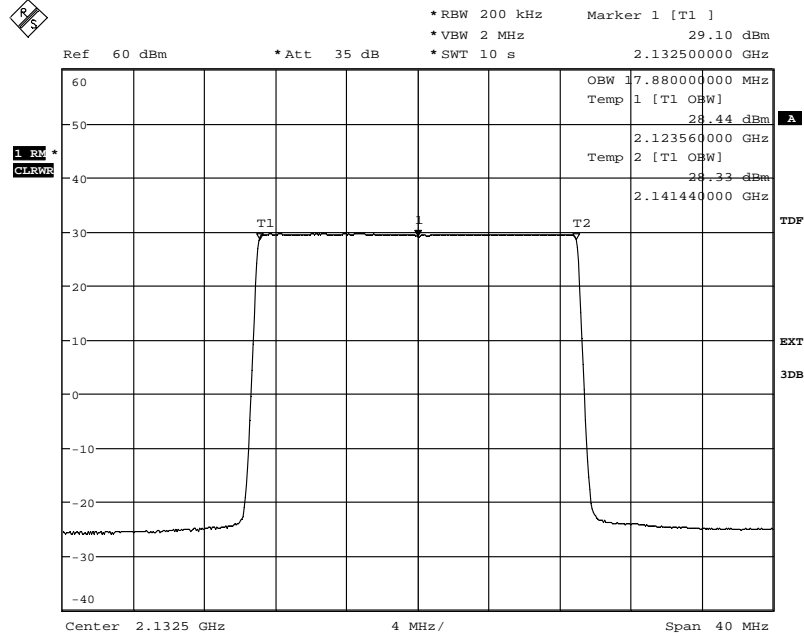

Date: 12.NOV.2012 15:41:34



Appendix 3

Diagram 9:

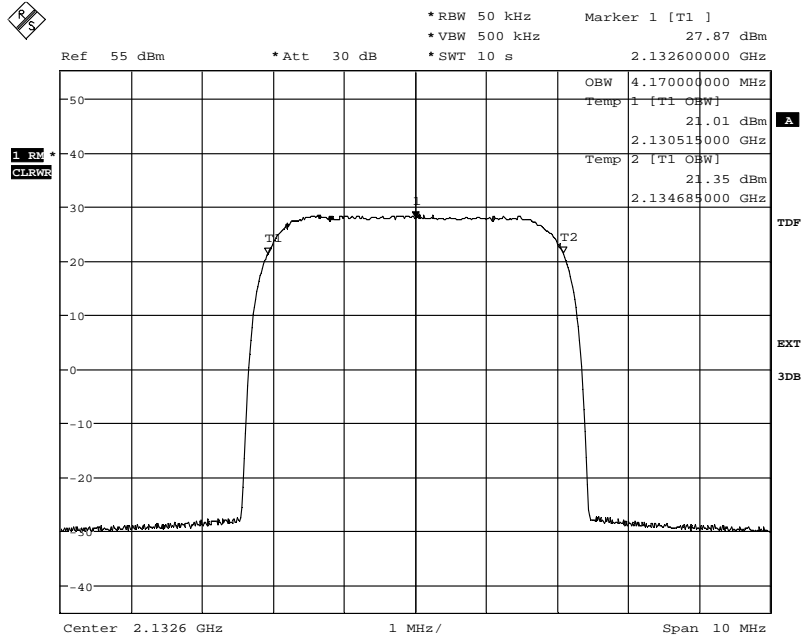

Date: 30.NOV.2012 12:05:53

Diagram 10:

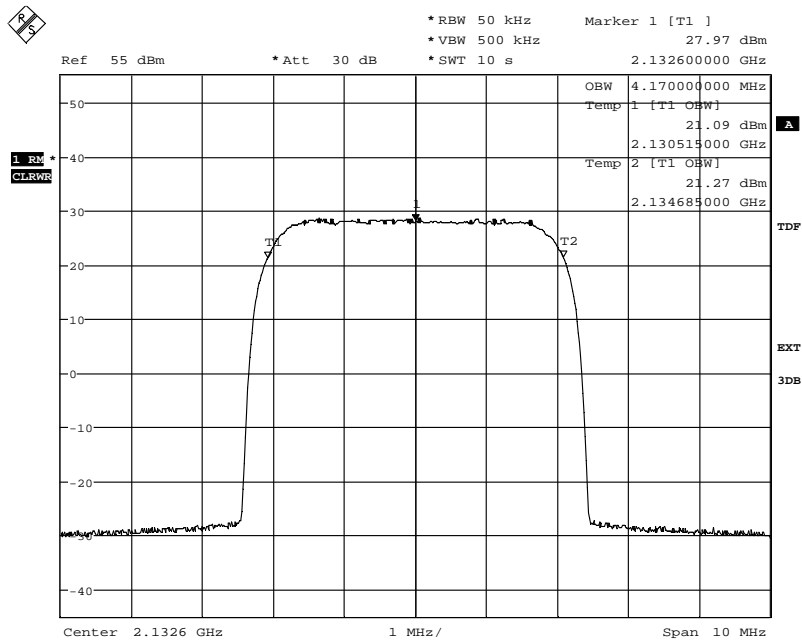

Date: 30.NOV.2012 12:30:36

Appendix 4

**Band edge measurements according to CFR 47 §27.53(h) / IC RSS-139 6.5**

Date	Temperature	Humidity
2012-11-12	23 °C ± 3 °C	26 % ± 5 %
2012-11-20	23 °C ± 3 °C	31 % ± 5 %
2012-11-21	23 °C ± 3 °C	31 % ± 5 %
2012-11-30	23 °C ± 3 °C	16 % ± 5 %

**Test set-up and procedure**

The measurements were made per definition in §27.53(h). The test object was connected to a spectrum analyzer with the RMS detector activated. The spectrum analyzer was connected to an external 10 MHz reference standard during the measurements. The FCC rules, specifying a RBW of at least 1% of the fundamental emission bandwidth up to 1 MHz away from the band edges and a RBW of 1 MHz for measurements of emissions more than 1 MHz away from the band edges. In cases where a smaller RBW was used than that specified by the rules, the limit was adjusted to compensate for the reduced RBW. In the frequency range up to 1 MHz away from the band edges the measured values of the emission bandwidth reported in tables below were used for the calculation of the limit.

Before comparing the results to the limit, 3 dB [10 log (2)] should be added according to method 2 “measure and add 10 log(N<sub>ANT</sub>)” of FCC KDB662911 D01 Multiple Transmitter Output v01r02

LTE:

BW configuration	Emission BW [MHz]	RBW used	Adjusted limit [dBm]
1.4 MHz	1.120	10 kHz	-13.49
3 MHz	2.733	10 kHz	-17.37
5 MHz	4.540	50 kHz	-
10 MHz	9.053	100 kHz	-
15 MHz	13.627	200 kHz	-
20 MHz	18.093	200 kHz	-

WCDMA:

BW configuration	Emission BW [MHz]	RBW used	Adjusted limit [dBm]
5 MHz	4.37	30 kHz	-14.60

In the frequency ranges 2104 to 2109 and 2156-2161 MHz a RBW of 100 kHz were used instead of 1 MHz, in this case the limit has been adjusted to -23 dBm

Measurement equipment	SP number
R&S FSQ	504 143
RF attenuator	504 159
RF attenuator	901 384
RF attenuator	900 233
Directional coupler	901 496
Testo 635, temperature and humidity meter	504 203

Measurement uncertainty: 3.7 dB

Appendix 4

**Results**

**LTE**

Diagram	BW configuration	Tested frequency	Tested Port
1 a+c	1.4 MHz	B	RUS 1, primary linked
2 a+c	1.4 MHz	B	RUS 1, secondary linked
3 a+c	3 MHz	B	RUS 1, primary linked
4 a+c	5 MHz	B	RUS 1, primary linked
5 a+c	10 MHz	B	RUS 1, primary linked
6 a+c	15 MHz	B	RUS 1, primary linked
7 a+c	20 MHz	B	RUS 1, primary linked
8 a+c	20 MHz	B	RUS 1, secondary linked
9 a+c	1.4 MHz	T	RUS 1, primary linked
10 a+c	1.4 MHz	T	RUS 1, secondary linked
11 a+c	3 MHz	T	RUS 1, primary linked
12 a+c	5 MHz	T	RUS 1, primary linked
13 a+c	10 MHz	T	RUS 1, primary linked
14 a+c	15 MHz	T	RUS 1, primary linked
15 a+c	20 MHz	T	RUS 1, primary linked
16 a+c	20 MHz	T	RUS 1, secondary linked

**WCDMA:**

Diagram	Tested frequency	Tested port
17 a-c	T+(T-5)	RUS 1, primary linked
18 a-c	T+(T-5)	RUS 1, secondary linked
19 a-c	B+(B+5)	RUS 1, primary linked
20 a-c	B+(B+5)	RUS 1, secondary linked
21 a-c	T	RUS 1, primary linked
22 a-c	T	RUS 1, secondary linked
23 a-c	B	RUS 1, primary linked
24 a-c	B	RUS 1, secondary linked

**Limits**

CFR 47 §27.53(h) and RSS-139 6.5

Outside a licensee's frequency band(s) of operation the power of any emission shall be attenuated below the transmitter power (P) by at least  $43 + 10 \log (P)$  dB, resulting in a limit of -13 dBm.

Complies?	Yes
-----------	-----

Appendix 4

Diagram 1a:

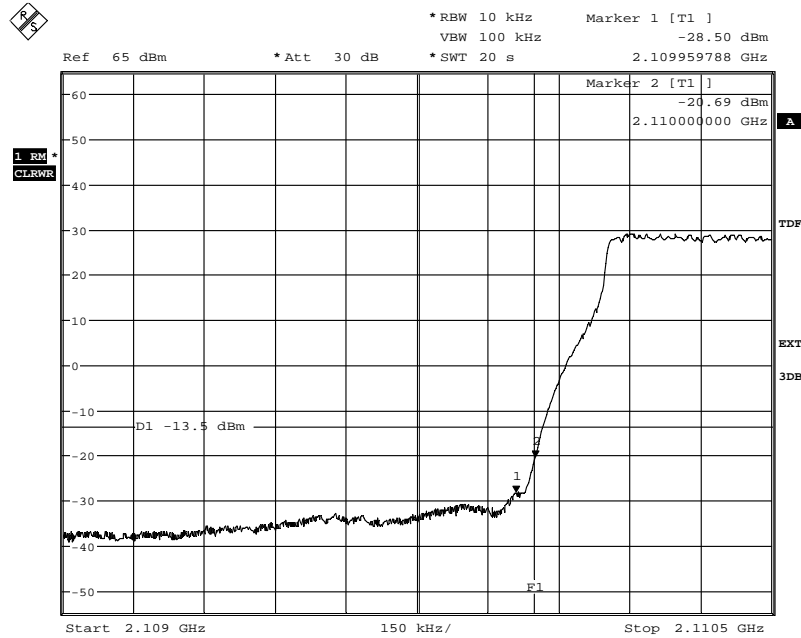

Date: 12.NOV.2012 14:02:36

Diagram 1b:

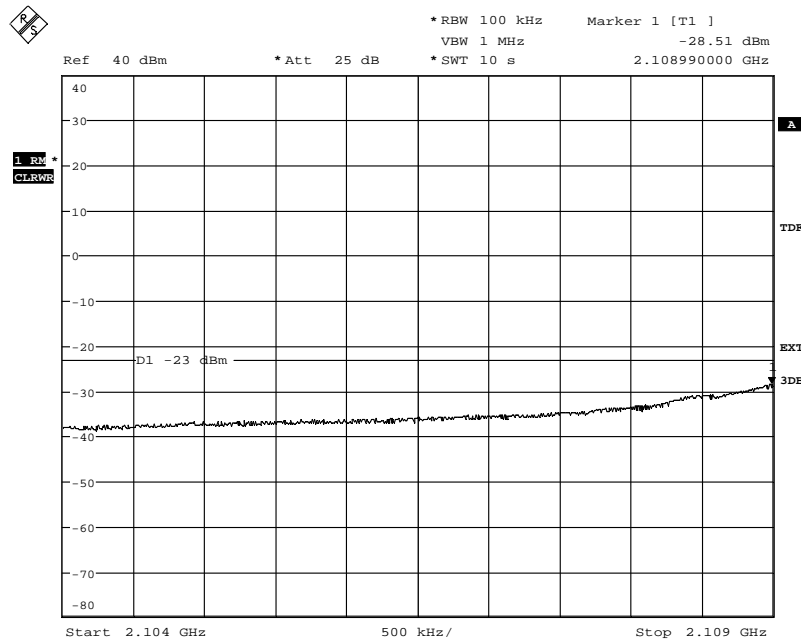

Date: 12.NOV.2012 14:05:05

Appendix 4

Diagram 1c

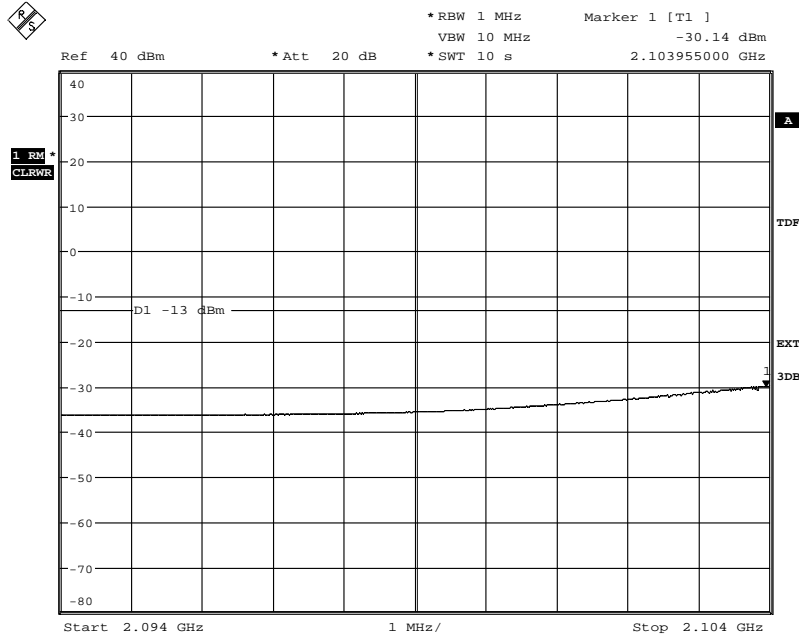

Date: 12.NOV.2012 14:06:04

Appendix 4

Diagram 2a:

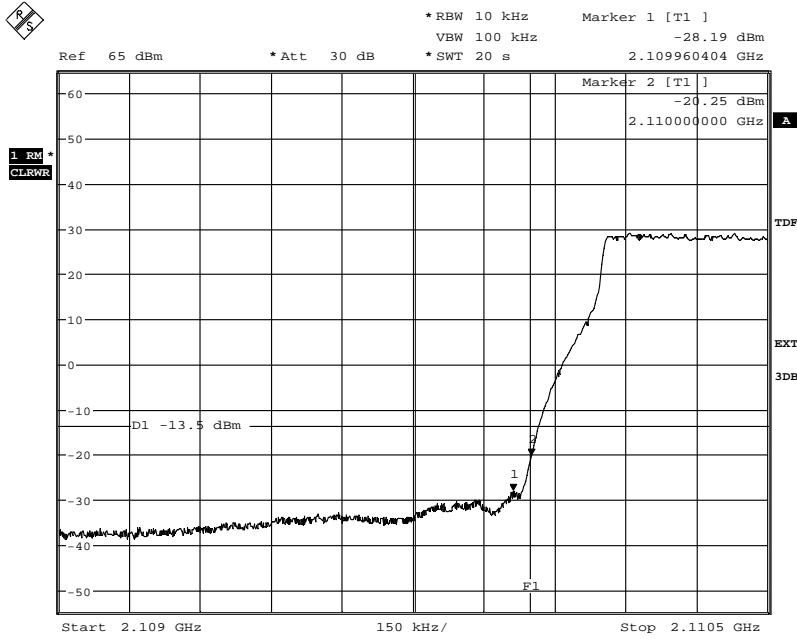

Date: 12.NOV.2012 15:31:52

Diagram 2b:

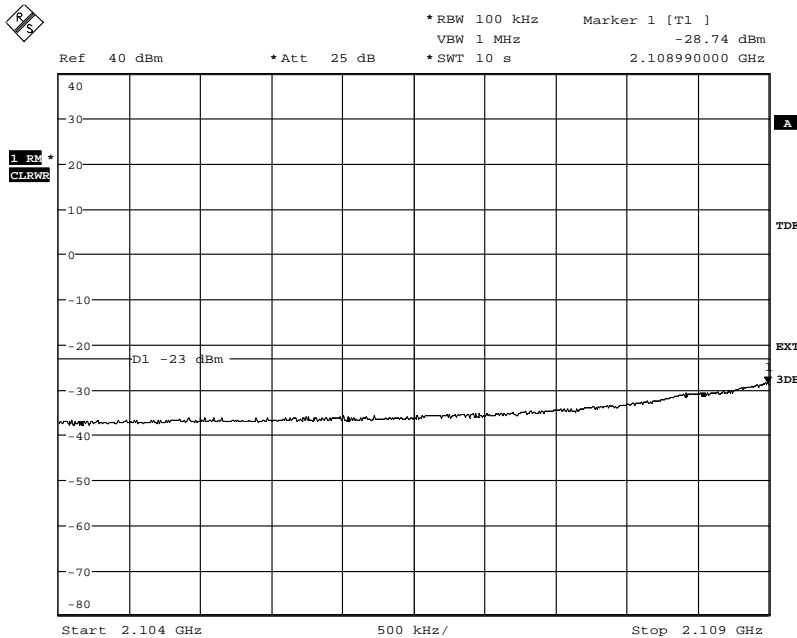

Date: 12.NOV.2012 15:32:35

Appendix 4

Diagram 2c:

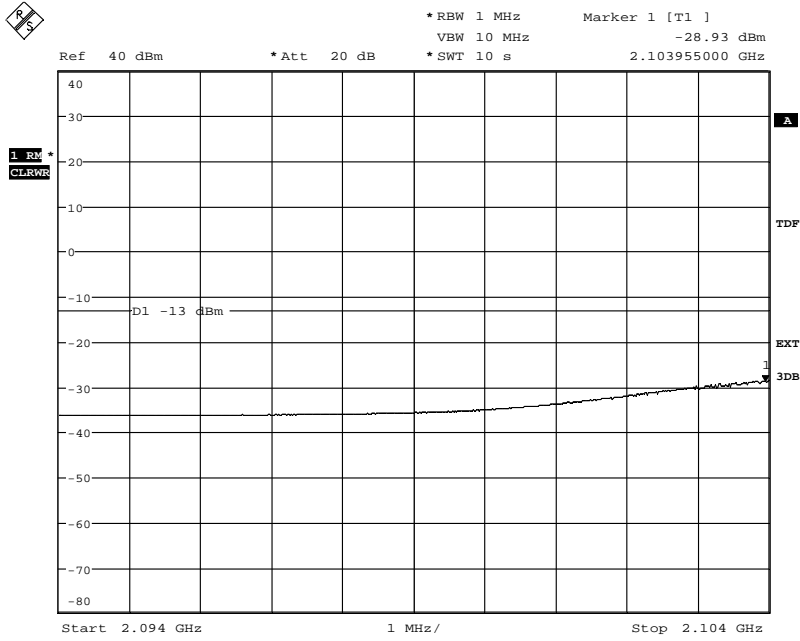

Date: 12.NOV.2012 15:33:38

Appendix 4

Diagram 3a:

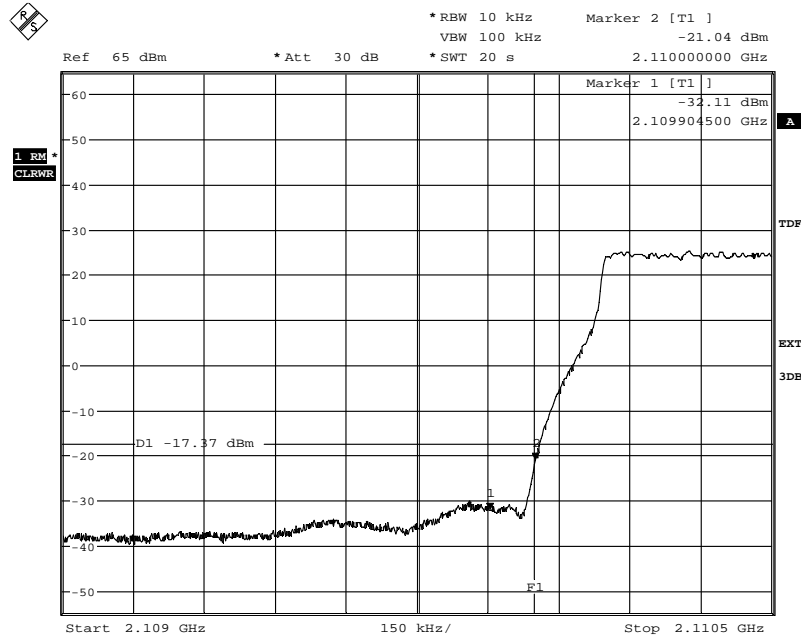

Date: 12.NOV.2012 14:12:50

Diagram 3b:

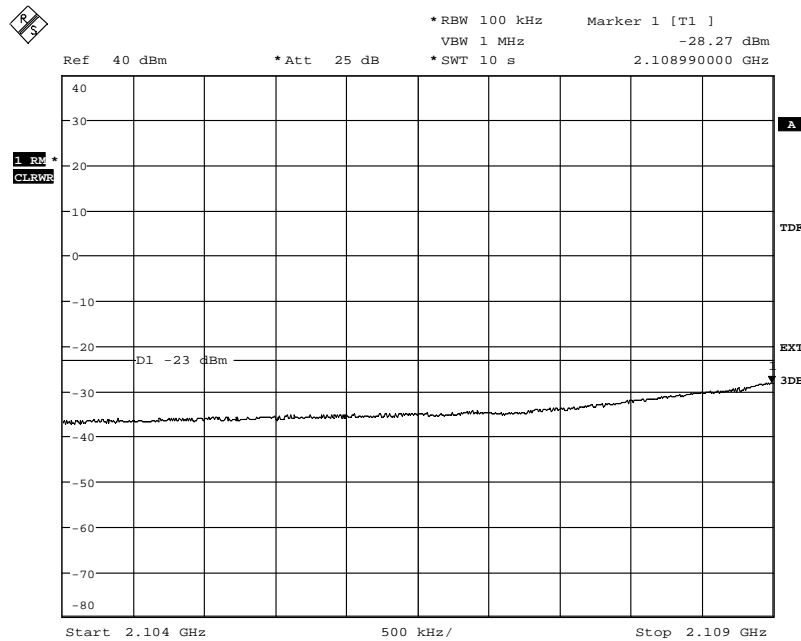

Date: 12.NOV.2012 14:16:07



Appendix 4

Diagram 3c:

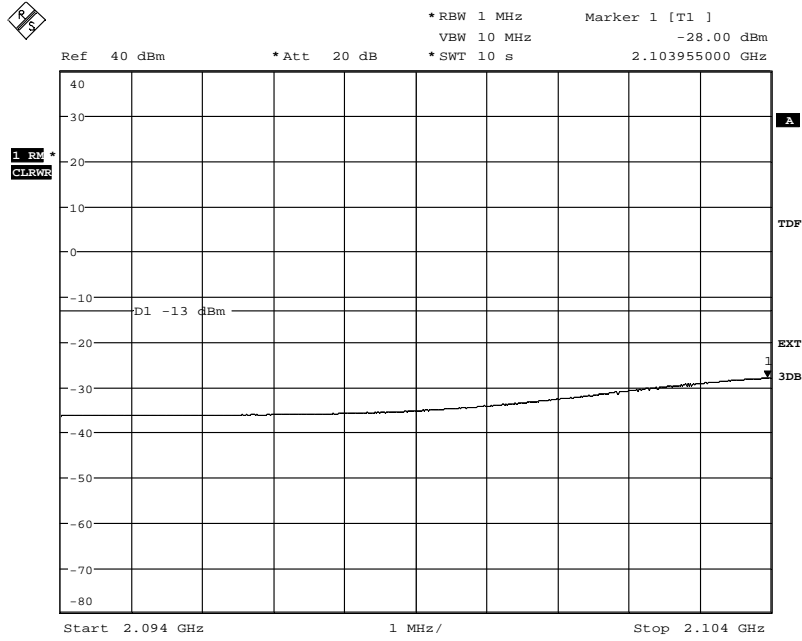

Date: 12.NOV.2012 14:17:04

Appendix 4

Diagram 4a:

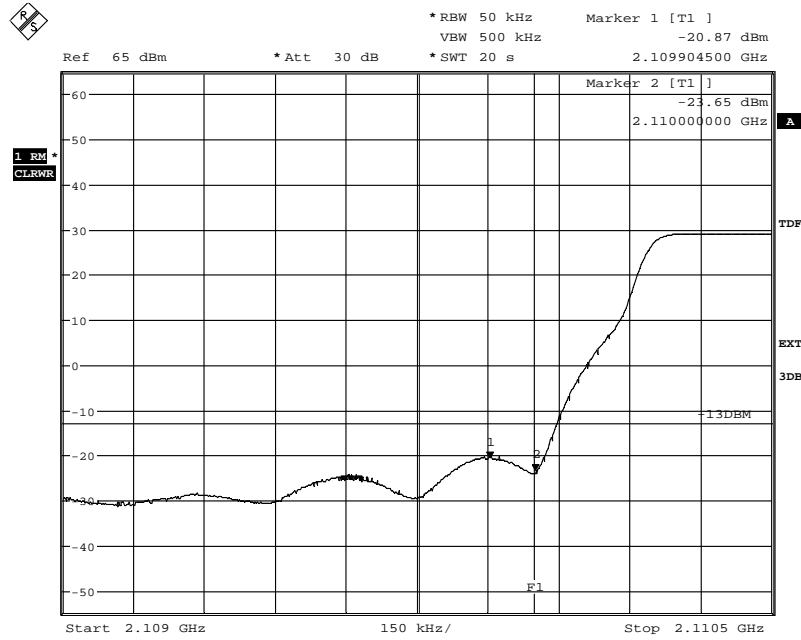

Date: 12.NOV.2012 14:19:35

Diagram 4b:

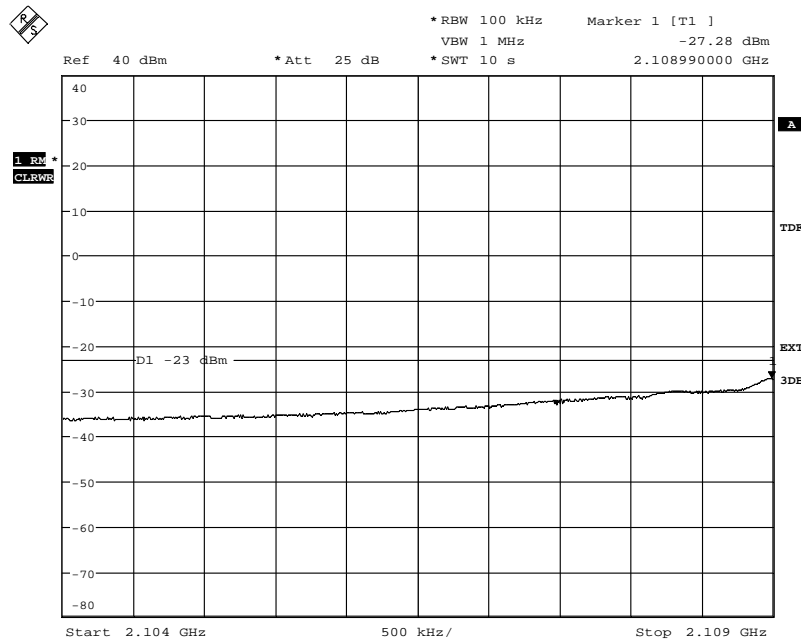

Date: 12.NOV.2012 14:20:38

Appendix 4

Diagram 4c:

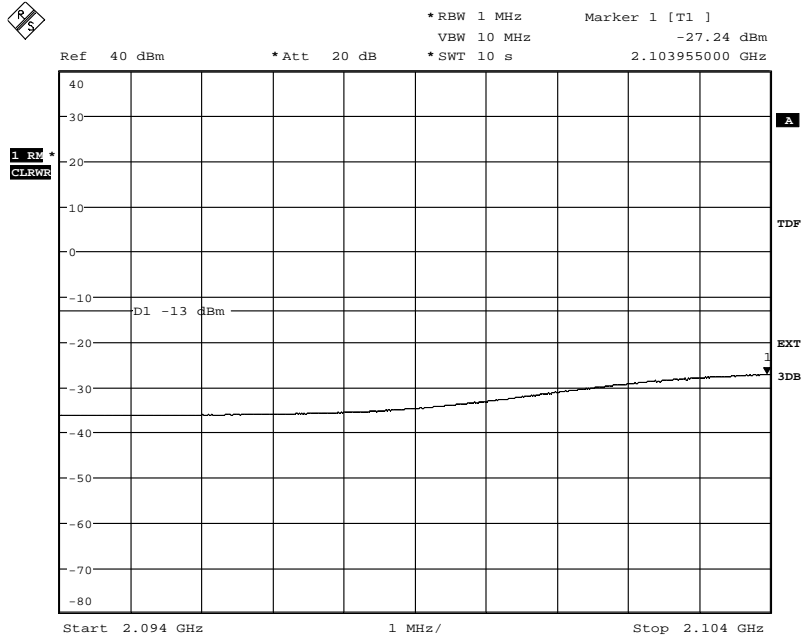

Date: 12.NOV.2012 14:18:37

Appendix 4

Diagram 5a:

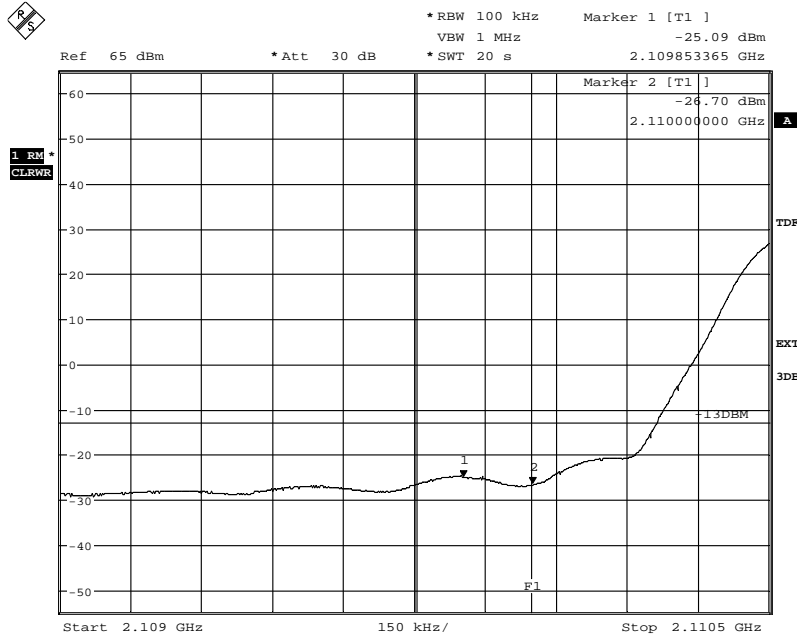

Date: 12.NOV.2012 14:25:17

Diagram 5b:

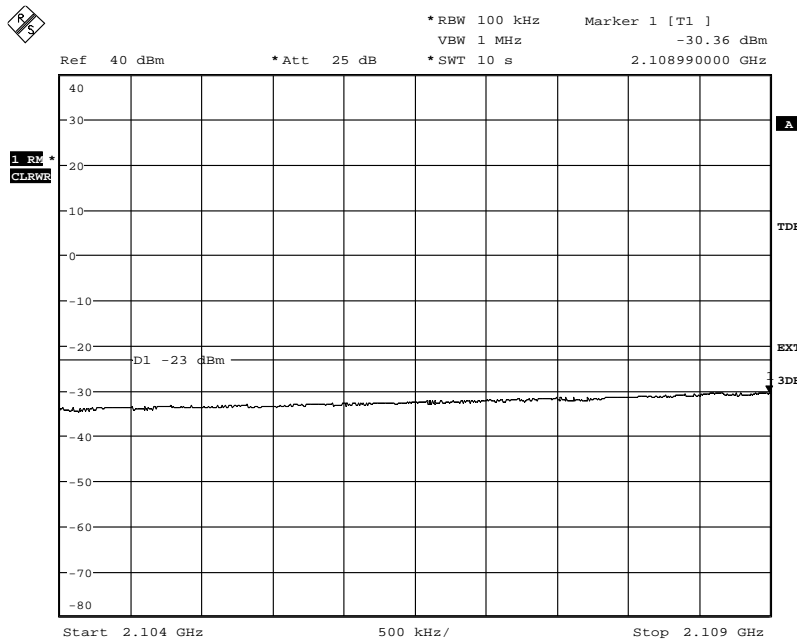

Date: 12.NOV.2012 14:22:33

Appendix 4

Diagram 5c:

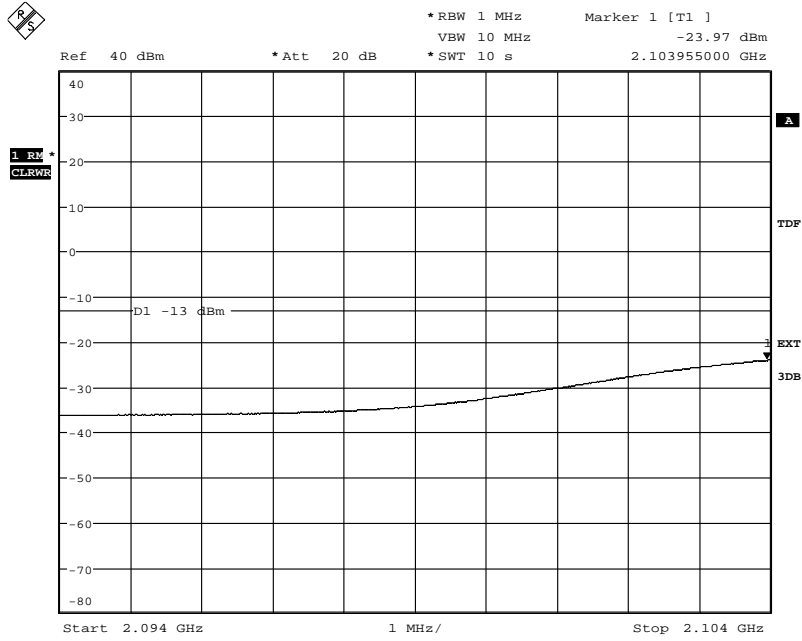

Date: 12.NOV.2012 14:26:08

Appendix 4

Diagram 6a:

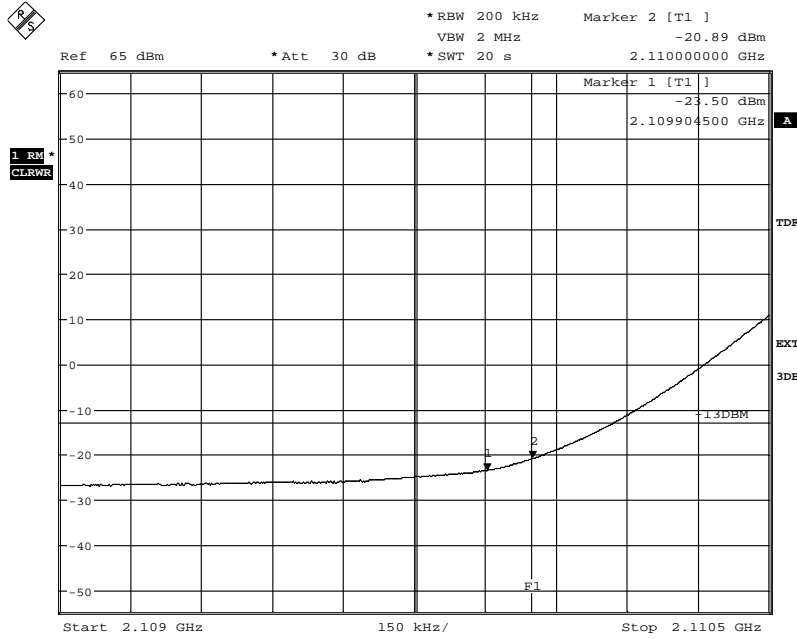

Date: 12.NOV.2012 14:31:47

Diagram 6b:

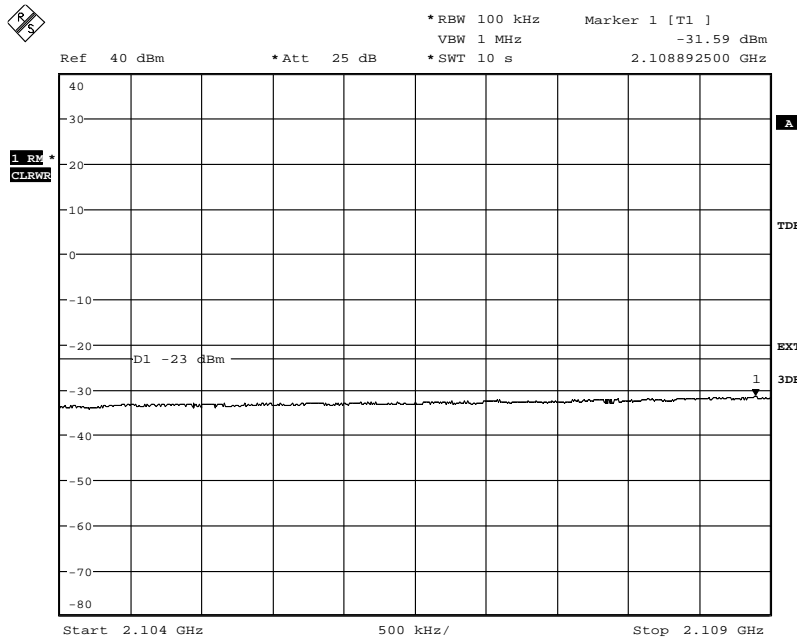

Date: 12.NOV.2012 14:30:22

Appendix 4

Diagram 6c:

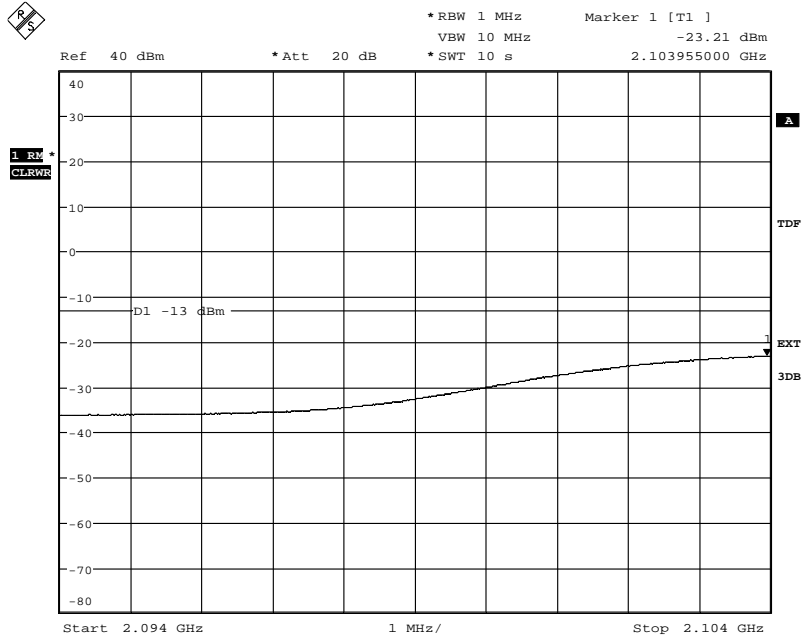

Date: 12.NOV.2012 14:27:59

Appendix 4

Diagram 7a:

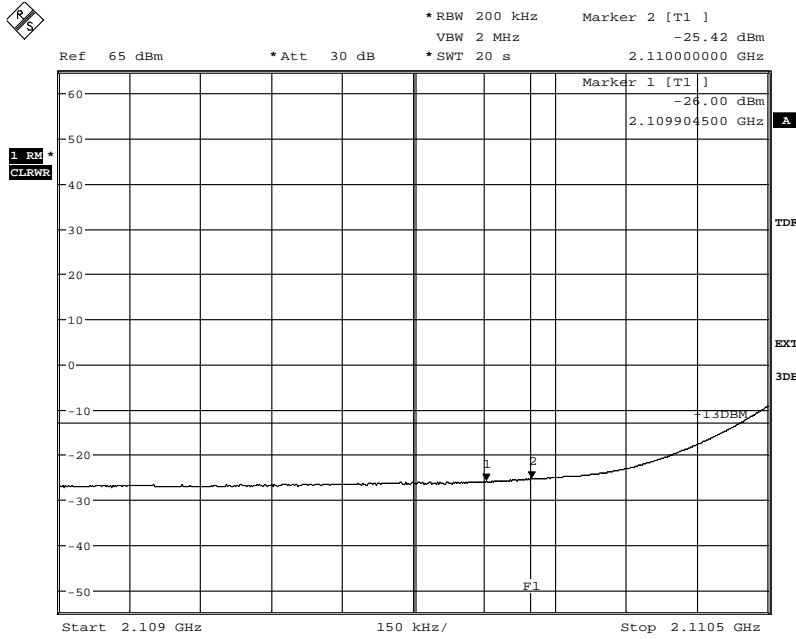

Date: 12.NOV.2012 14:44:32

Diagram 7b:

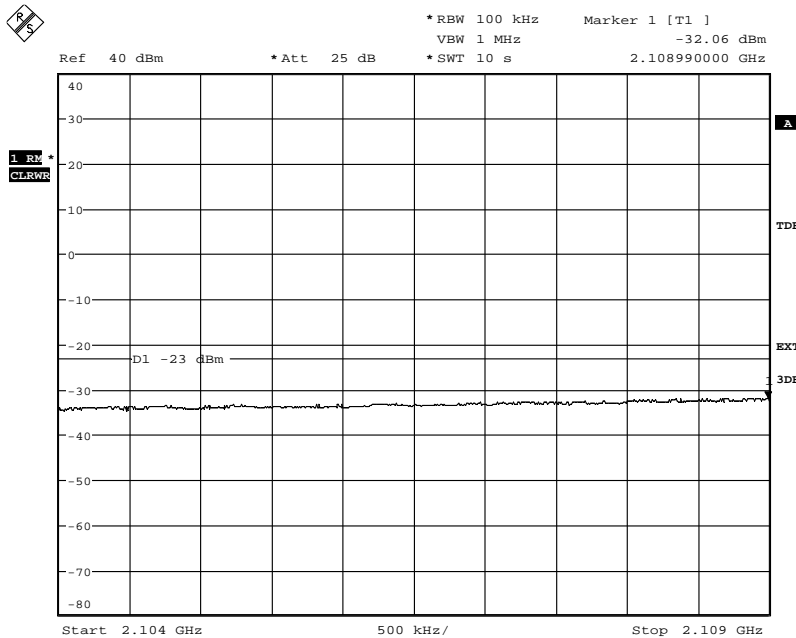

Date: 12.NOV.2012 14:45:50



Appendix 4

Diagram 7c:

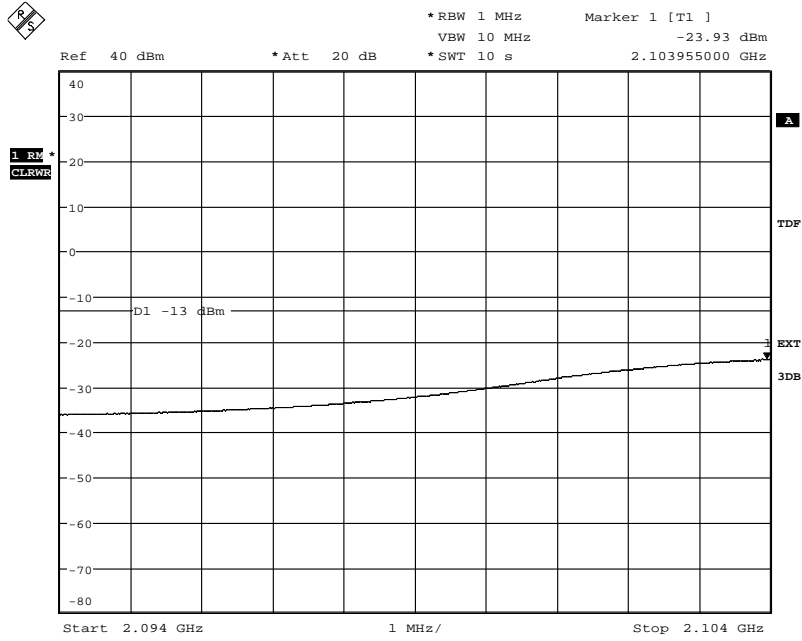

Date: 12.NOV.2012 14:46:37

Appendix 4

Diagram 8a:

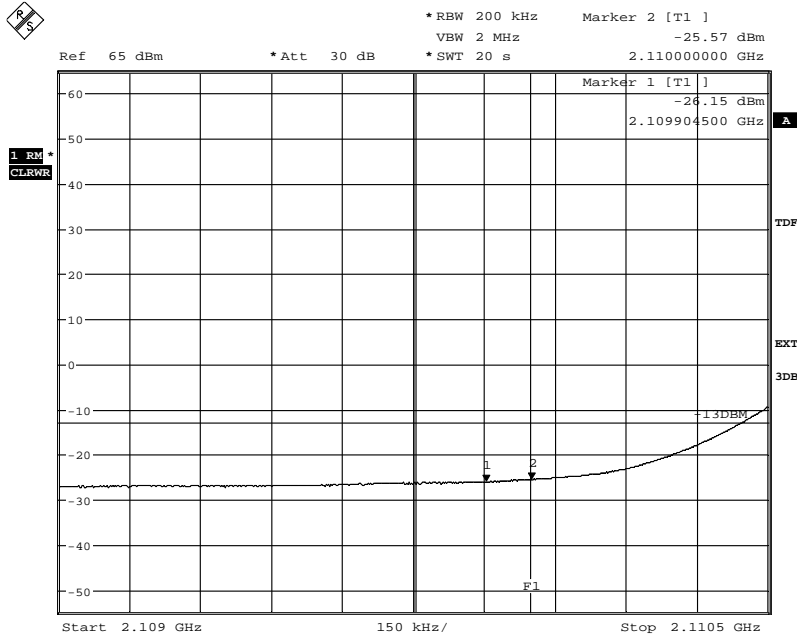

Date: 12.NOV.2012 15:37:00

Diagram 8b:

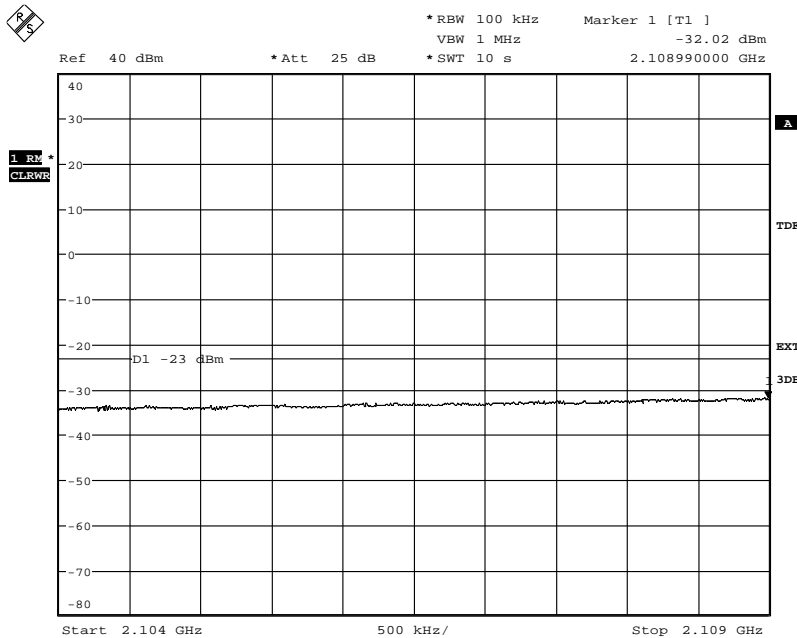

Date: 12.NOV.2012 15:35:38

Appendix 4

Diagram 8c:

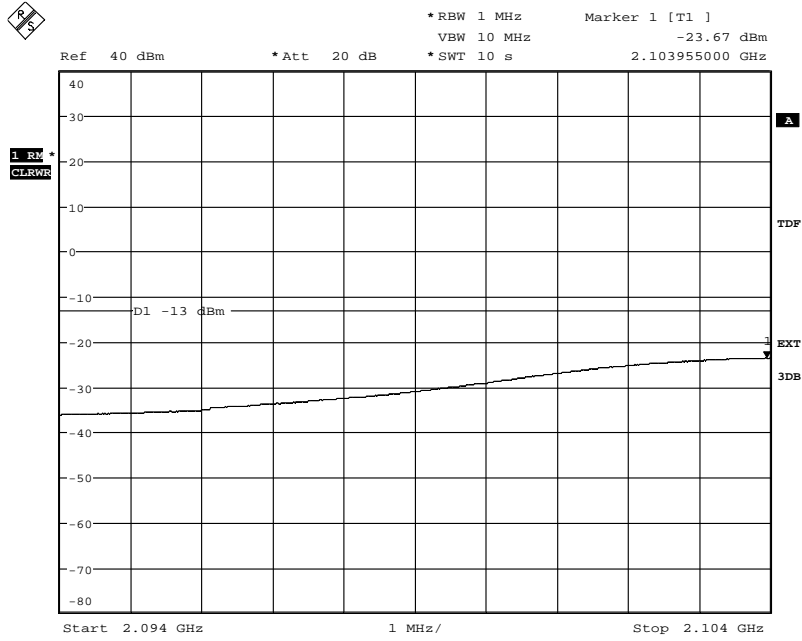

Date: 12.NOV.2012 15:34:49

Appendix 4

Diagram 9a:

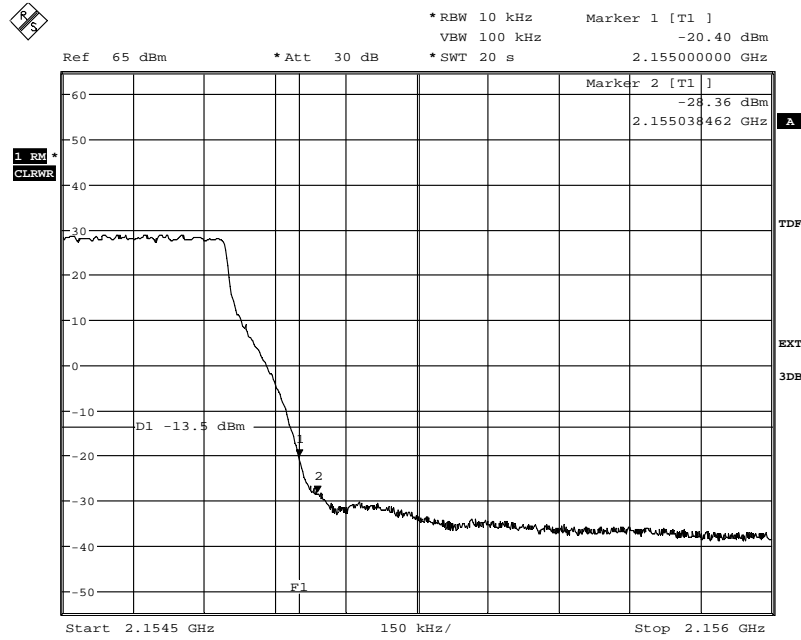

Date: 12.NOV.2012 14:49:55

Diagram 9b:

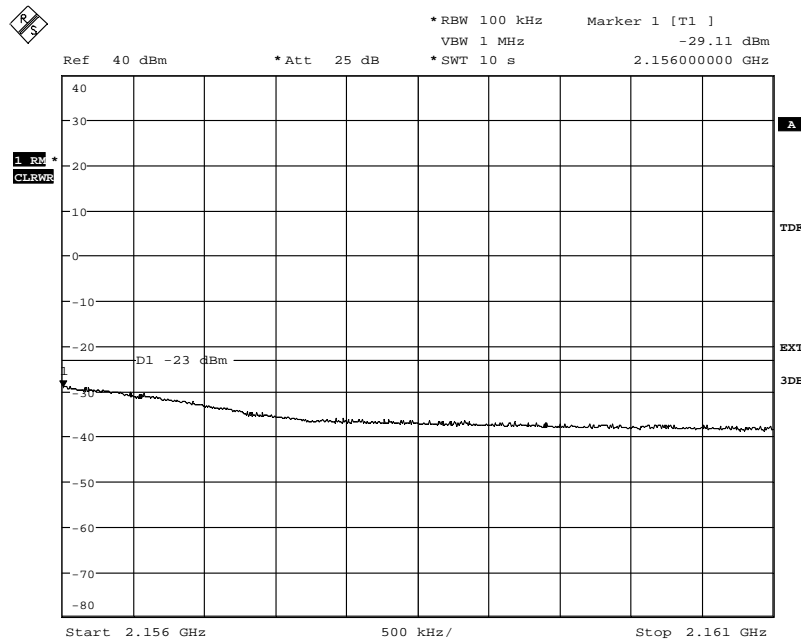

Date: 12.NOV.2012 14:50:51

Appendix 4

Diagram 9c

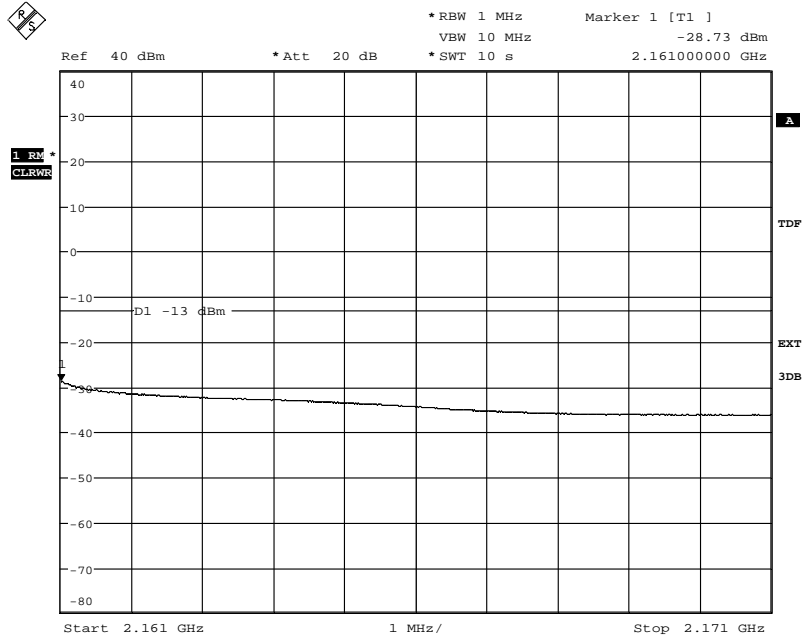

Date: 12.NOV.2012 14:53:16

Appendix 4

Diagram 10a:

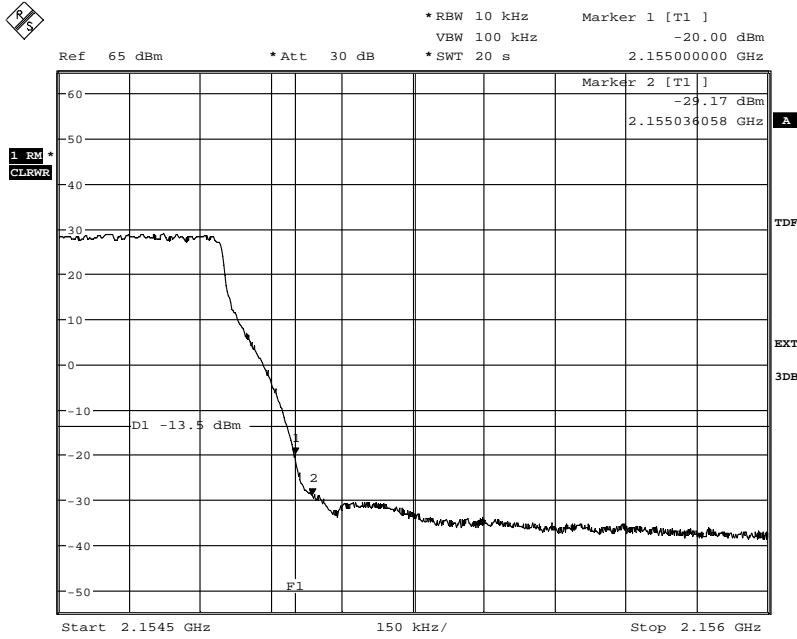

Date: 12.NOV.2012 15:27:38

Diagram 10b:

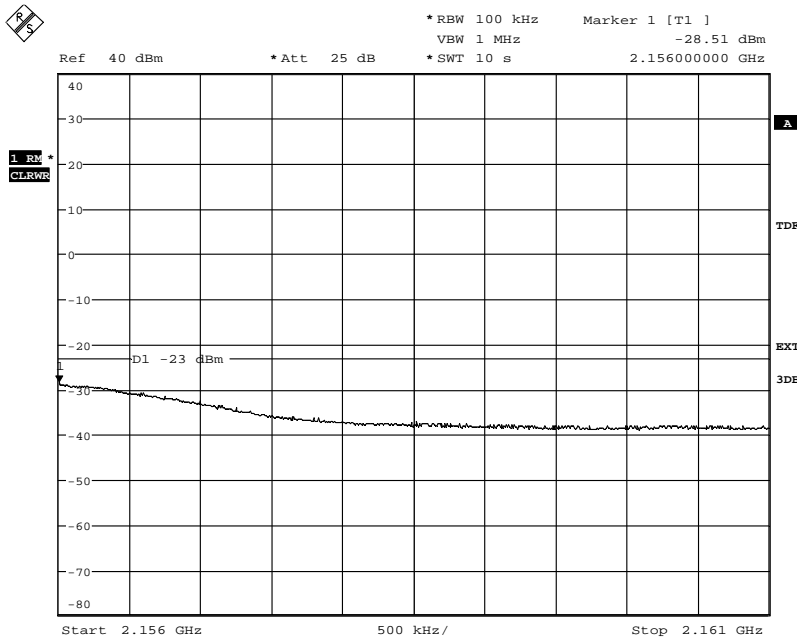

Date: 12.NOV.2012 15:28:18

Appendix 4

Diagram 10c:

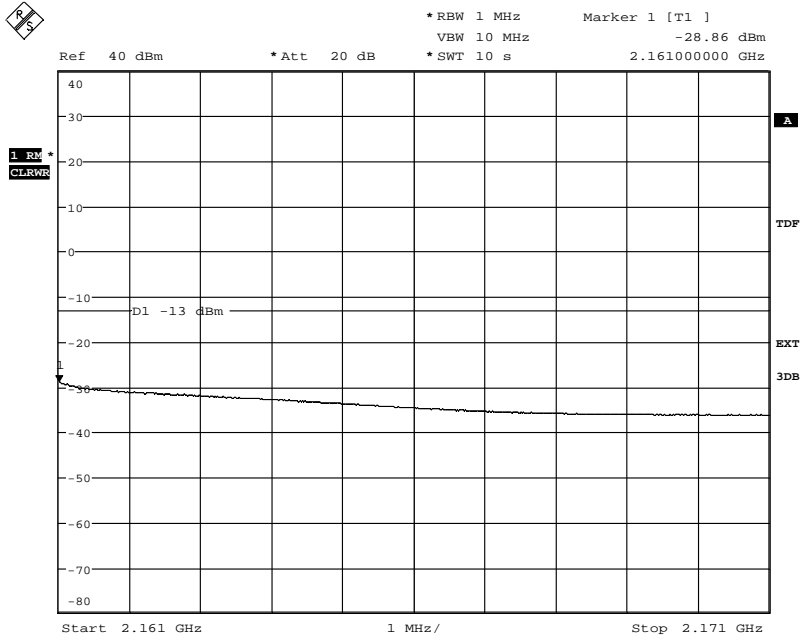

Date: 12.NOV.2012 15:28:53

Appendix 4

Diagram 11a:

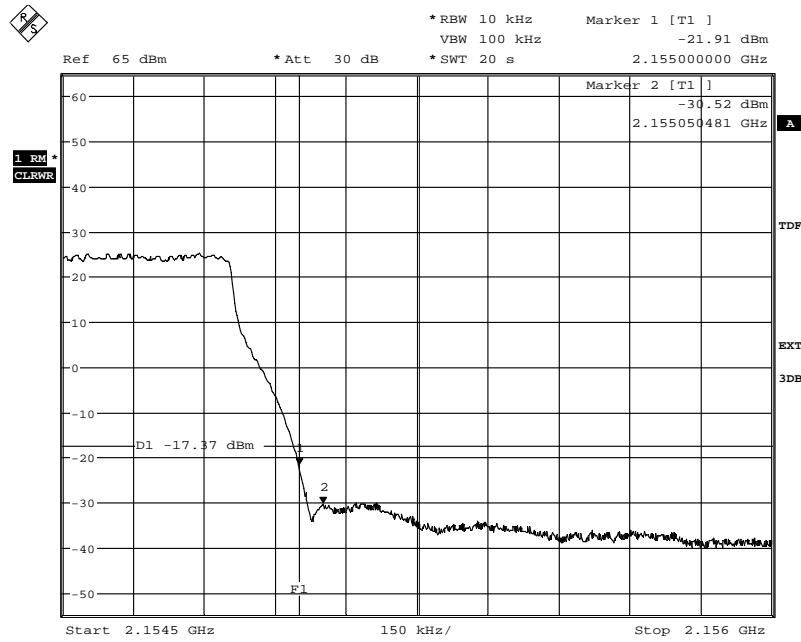

Date: 12.NOV.2012 14:56:34

Diagram 11b:

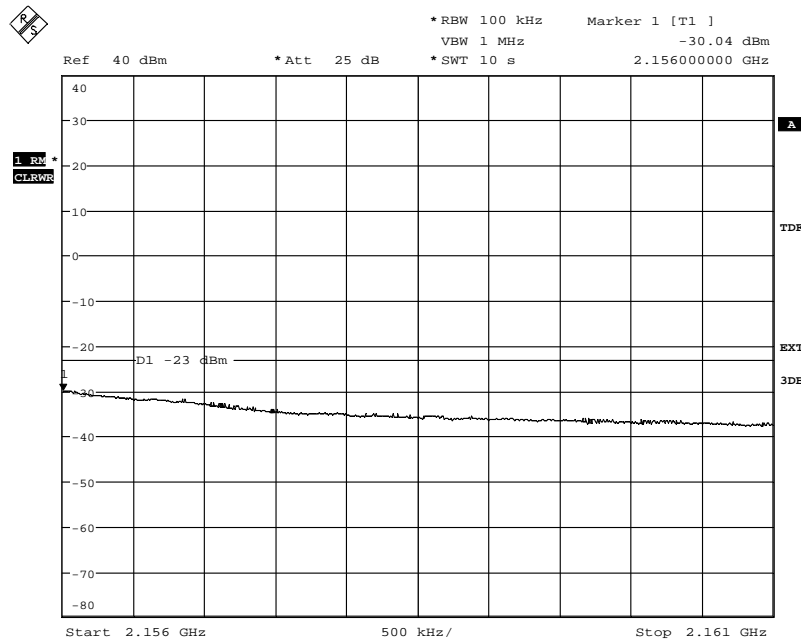

Date: 12.NOV.2012 14:57:23



Appendix 4

Diagram 11c:

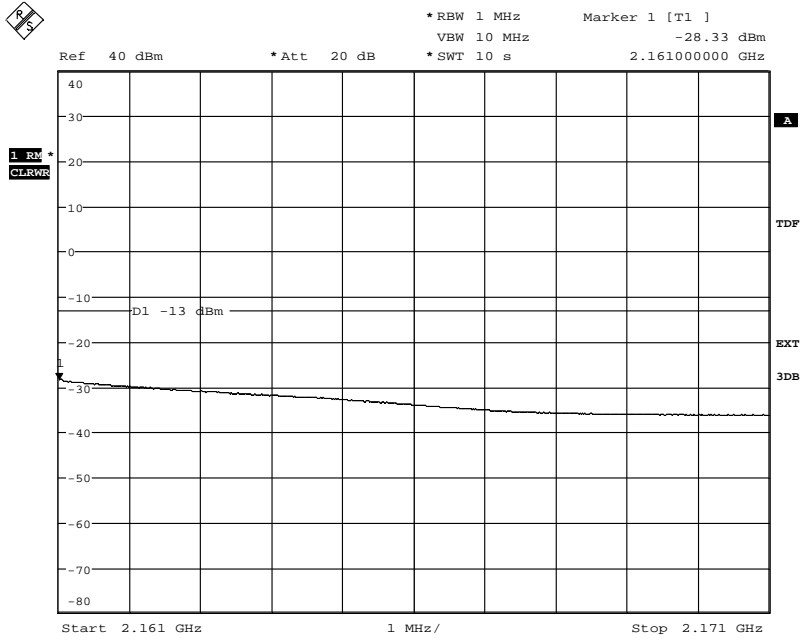

Date: 12.NOV.2012 14:58:13

Appendix 4

Diagram 12a:

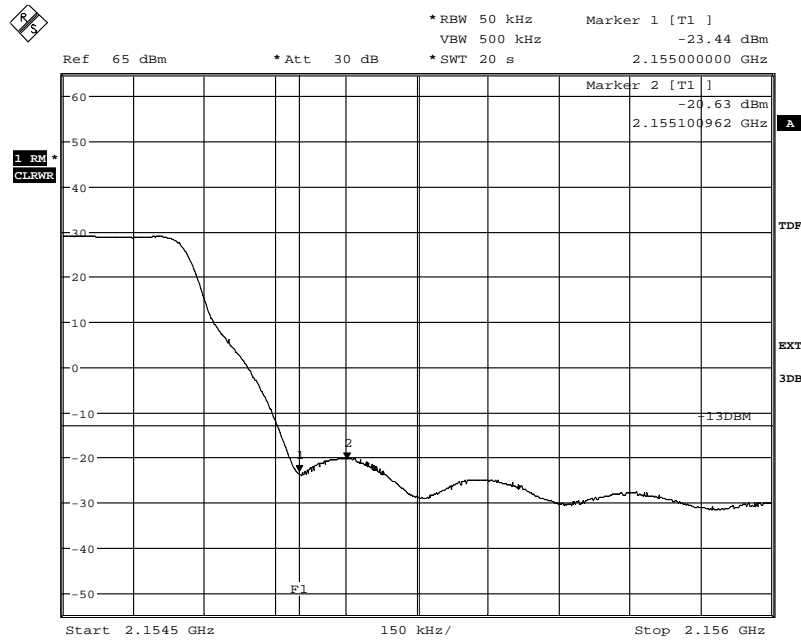

Date: 12.NOV.2012 15:02:46

Diagram 12b:

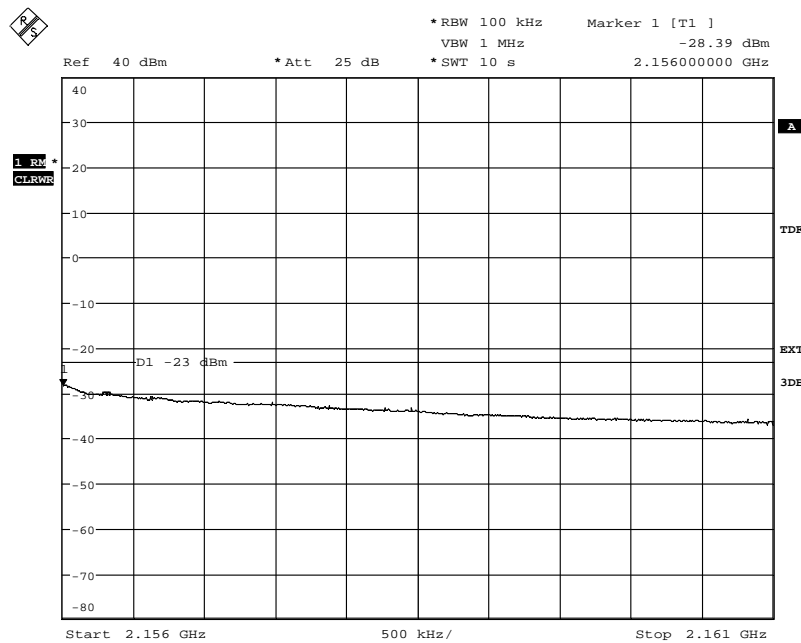

Date: 12.NOV.2012 15:04:22

Appendix 4

Diagram 12c:

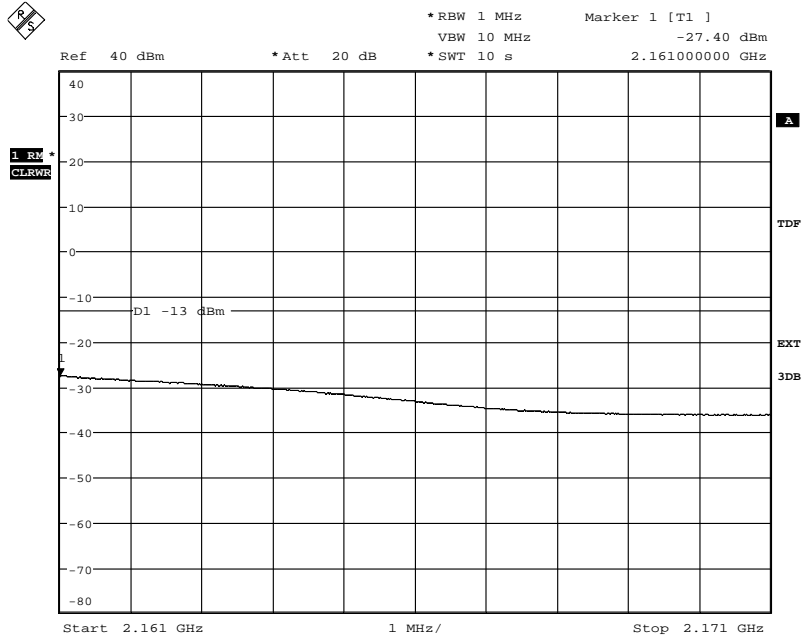

Date: 12.NOV.2012 15:05:36

Appendix 4

Diagram 13a:

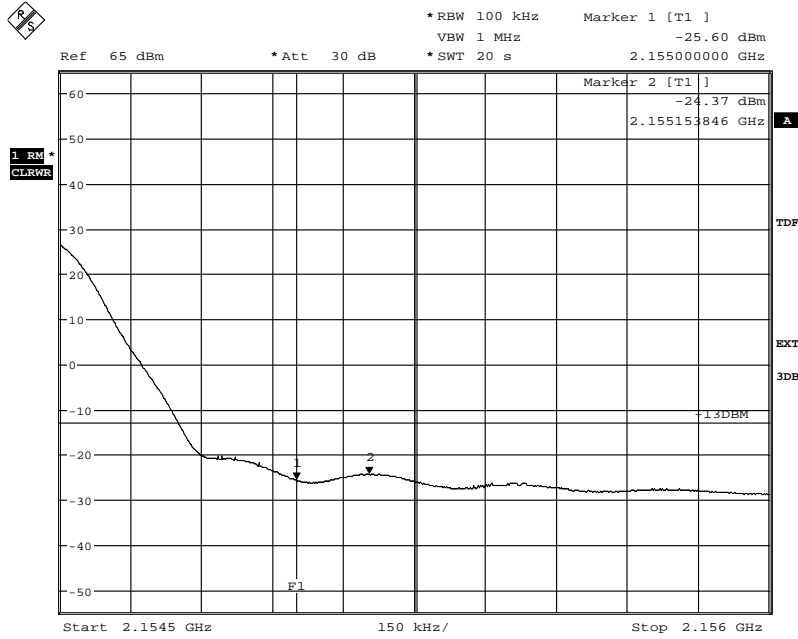

Date: 12.NOV.2012 15:09:19

Diagram 13b:

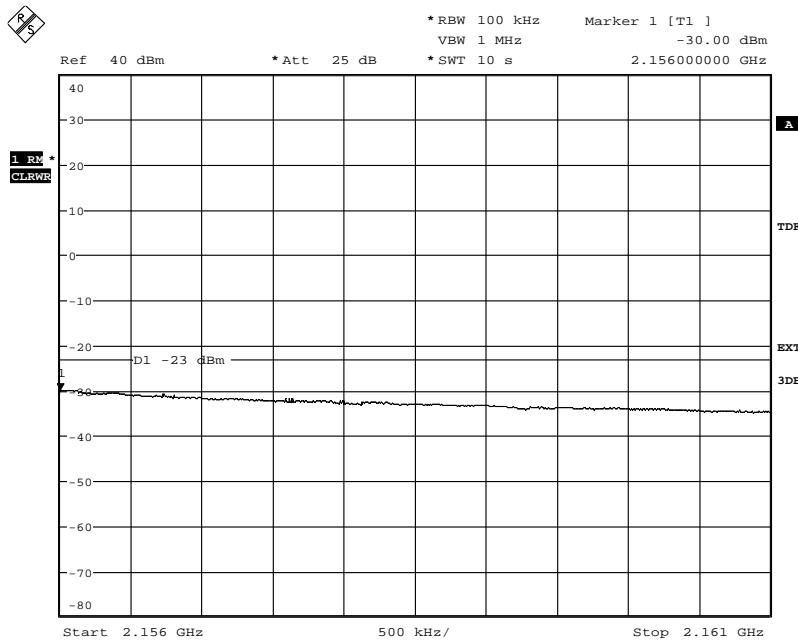

Date: 12.NOV.2012 15:10:29

Appendix 4

Diagram 13c:

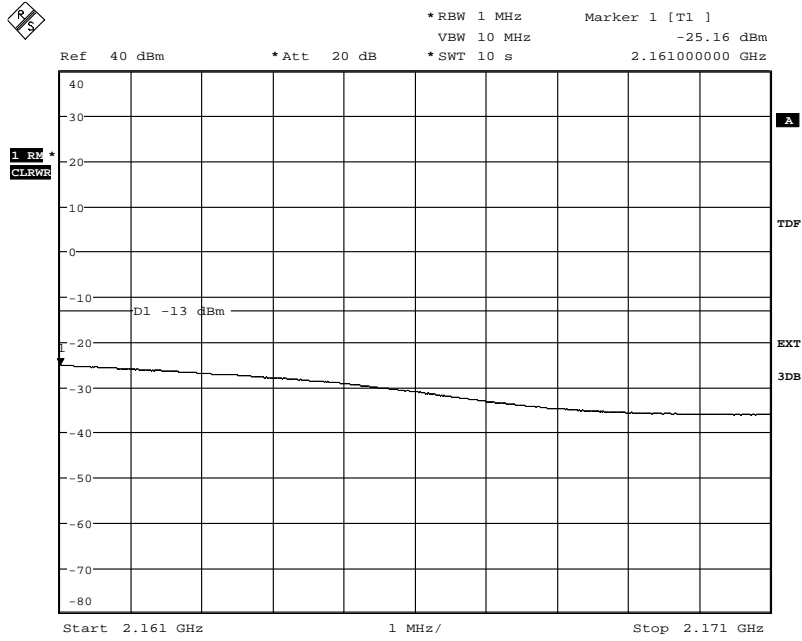

Date: 12.NOV.2012 15:11:19

Appendix 4

Diagram 14a:

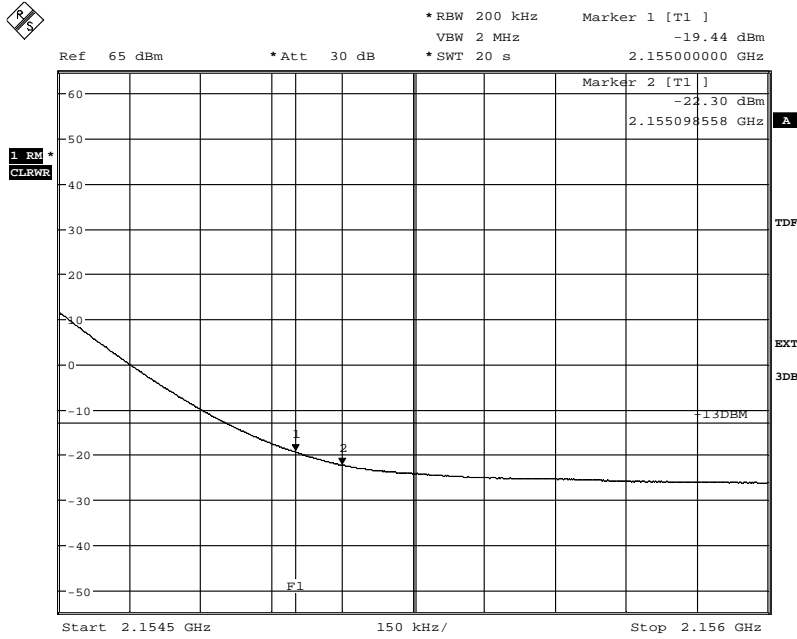

Date: 12.NOV.2012 15:16:15

Diagram 14b:

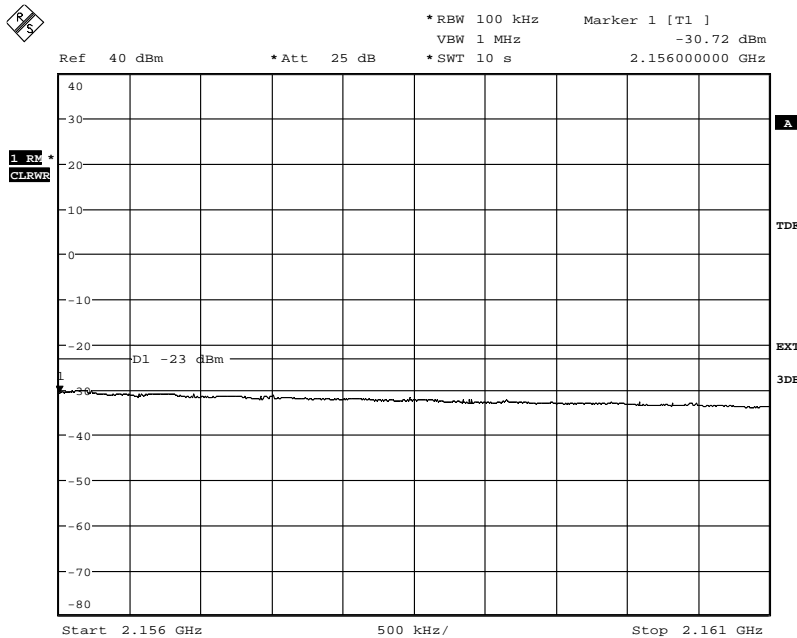

Date: 12.NOV.2012 15:13:54

Appendix 4

Diagram 14c:

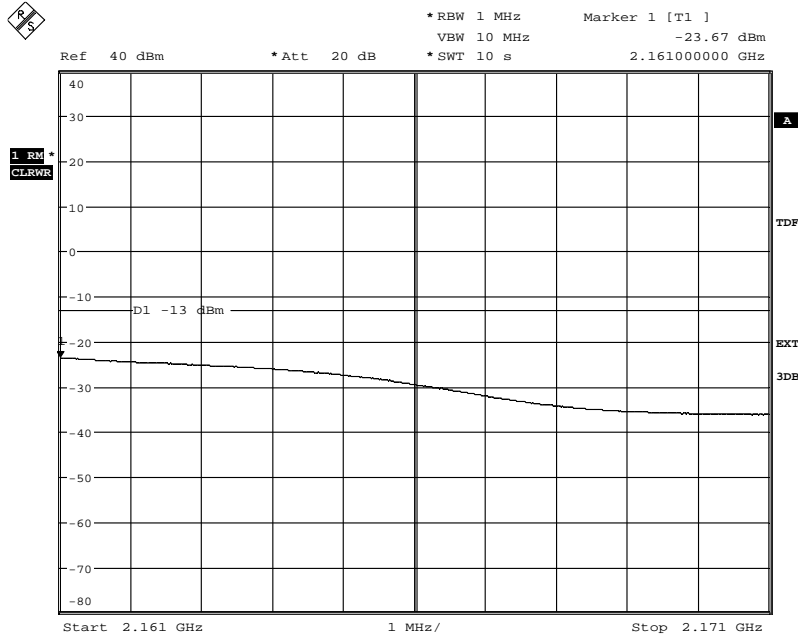

Date: 12.NOV.2012 15:12:43

Appendix 4

Diagram 15a:

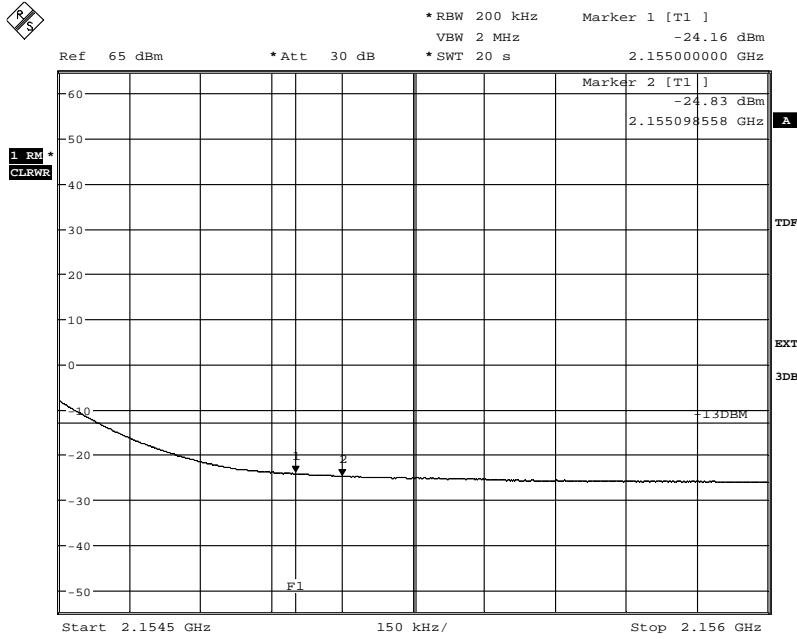

Date: 12.NOV.2012 15:17:42

Diagram 15b:

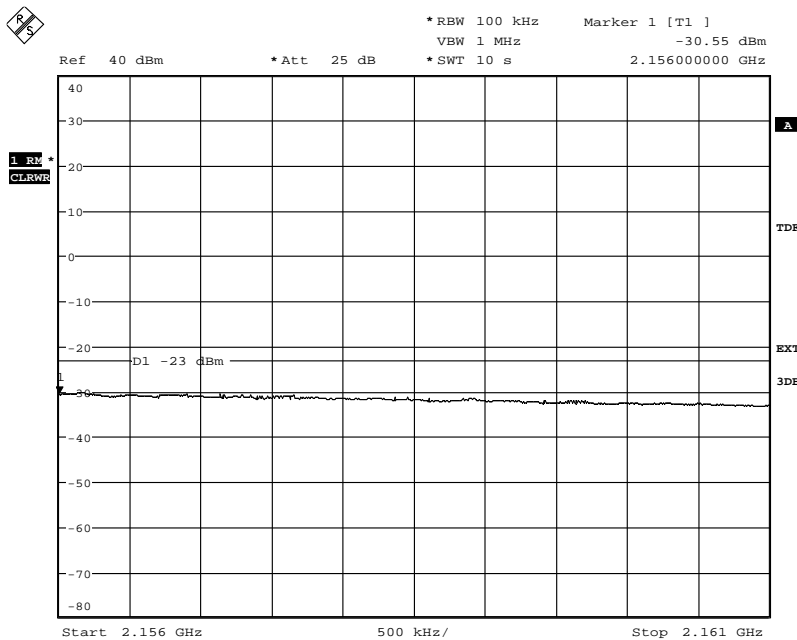

Date: 12.NOV.2012 15:18:30



Appendix 4

Diagram 15c:

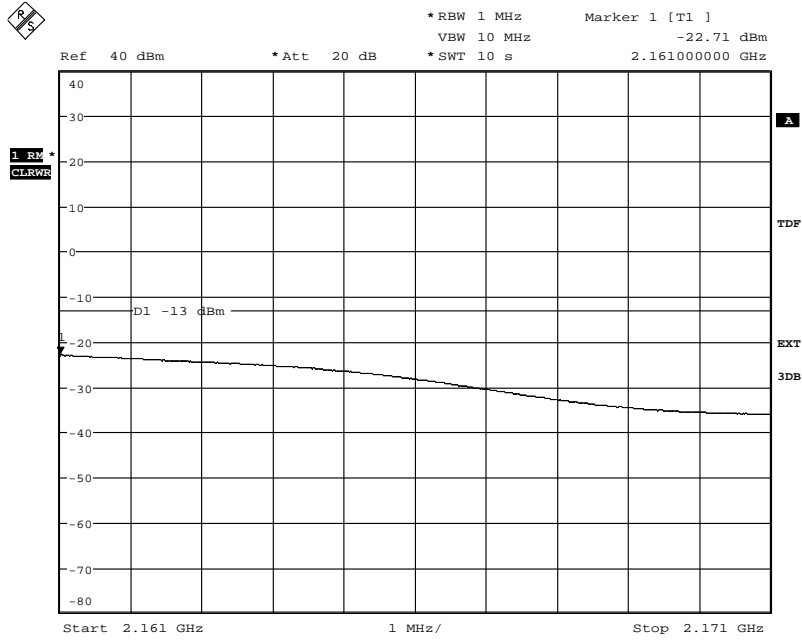

Date: 12.NOV.2012 15:19:11

Appendix 4

Diagram 16a:

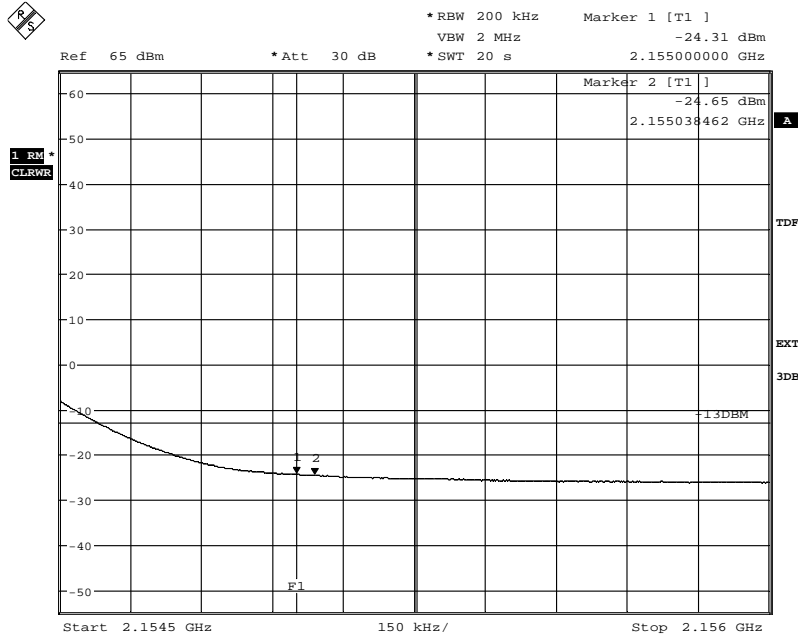

Date: 12.NOV.2012 15:25:37

Diagram 16b:

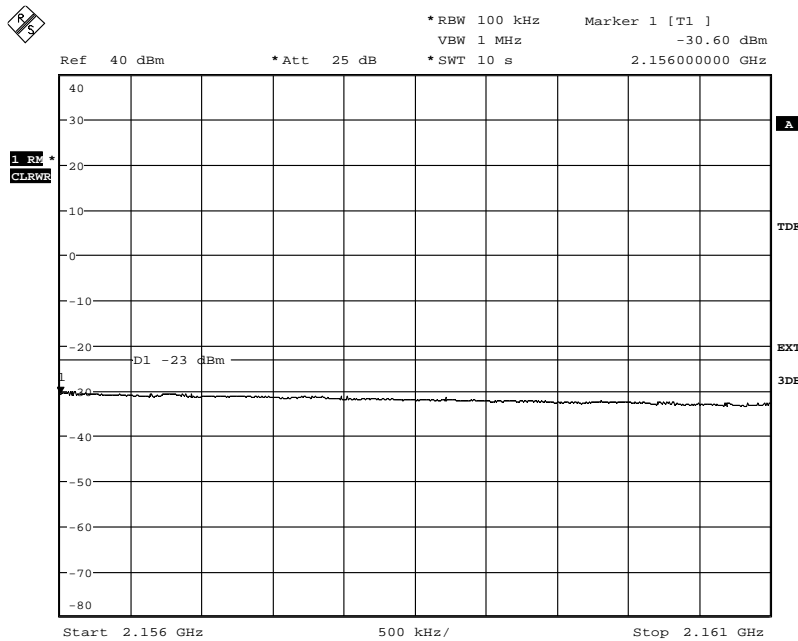

Date: 12.NOV.2012 15:24:00

Appendix 4

Diagram 16c:

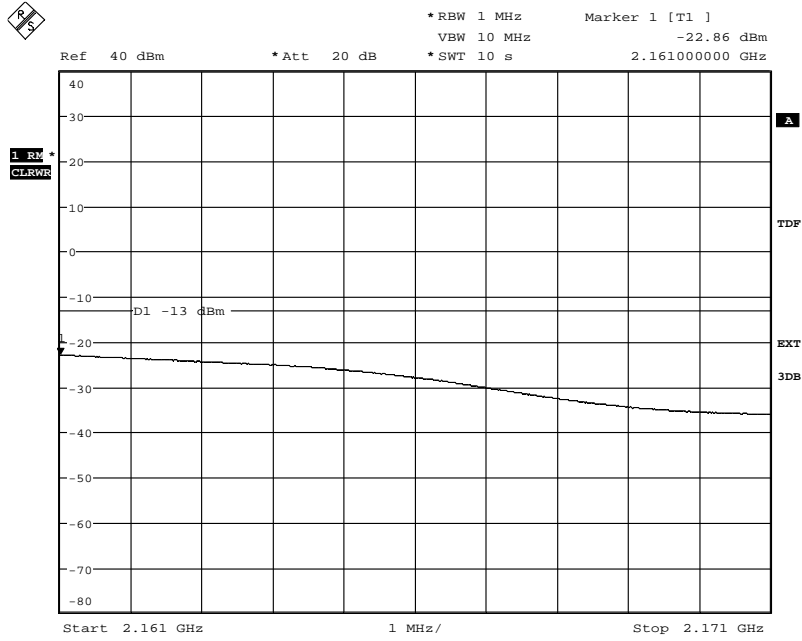

Date: 12.NOV.2012 15:23:06

Appendix 4

Diagram 17a:

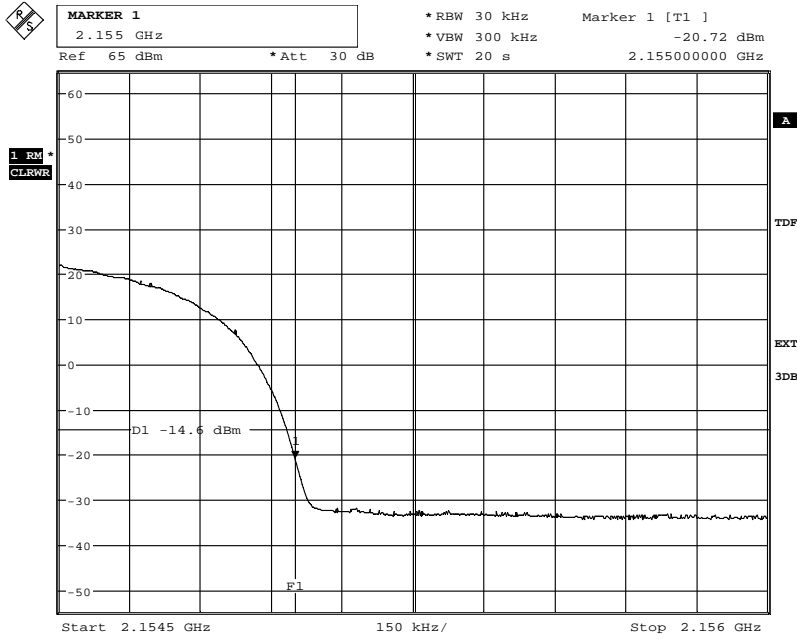

Date: 20.NOV.2012 15:24:27

Diagram 17b:

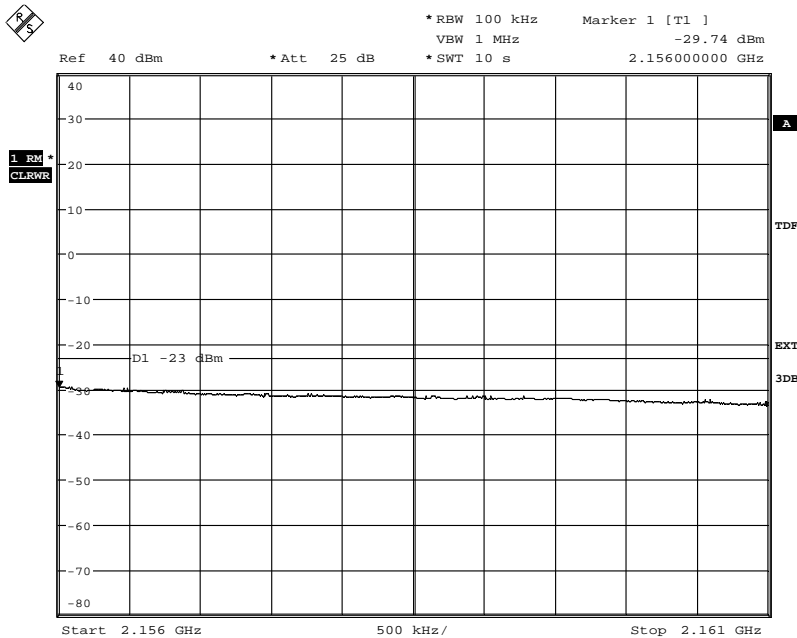

Date: 20.NOV.2012 15:28:25

Appendix 4

Diagram 17c:

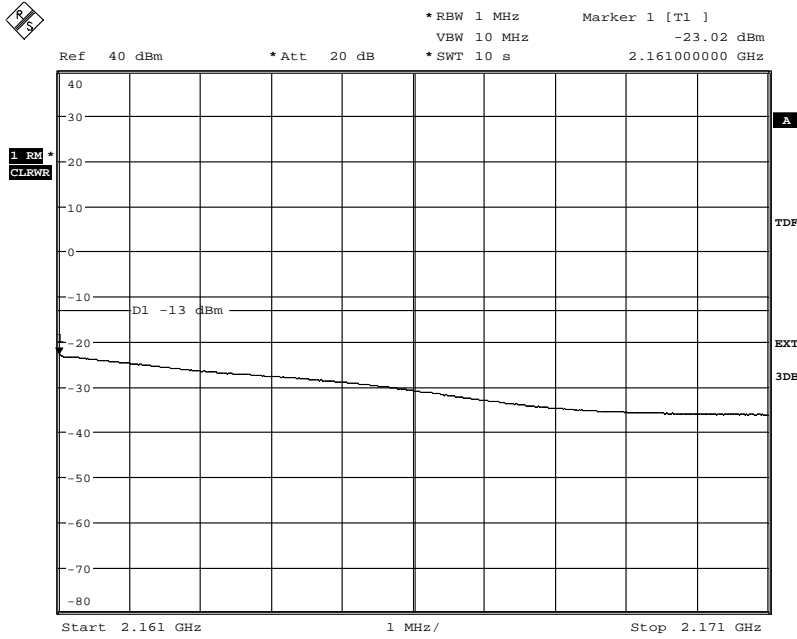

Date: 20.NOV.2012 15:29:06

Appendix 4

Diagram 18a:

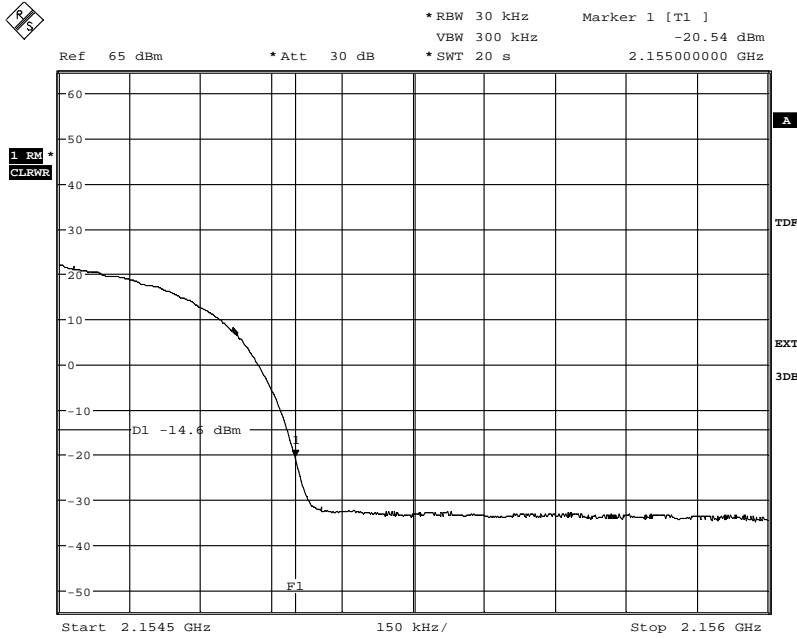

Date: 21.NOV.2012 07:25:26

Diagram 18b:

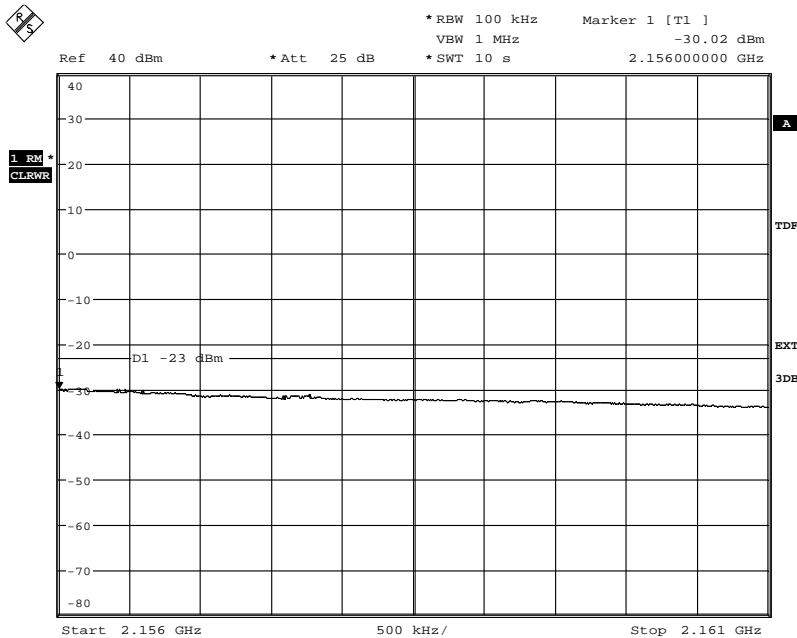

Date: 21.NOV.2012 07:26:30

Appendix 4

Diagram 18c:

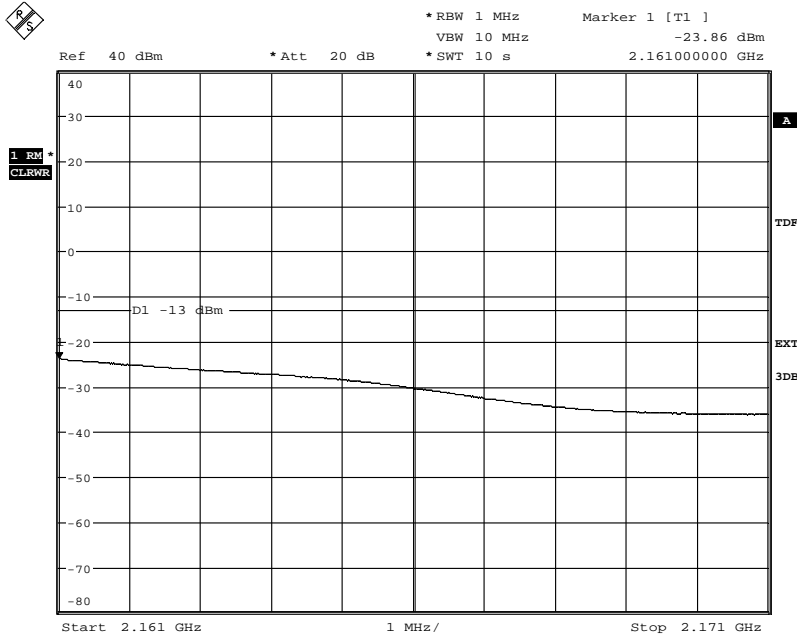

Date: 21.NOV.2012 07:27:24

Appendix 4

Diagram 19a:

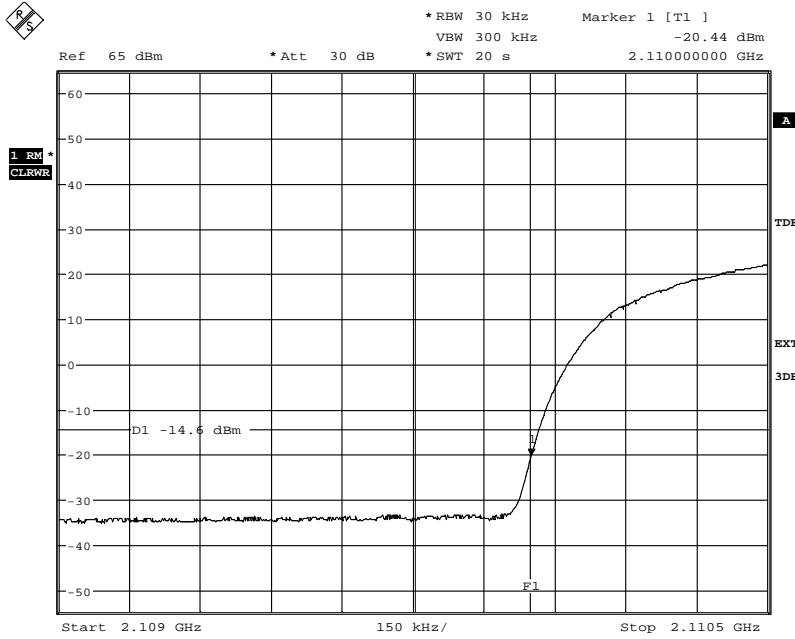

Date: 21.NOV.2012 08:34:06

Diagram 19b:

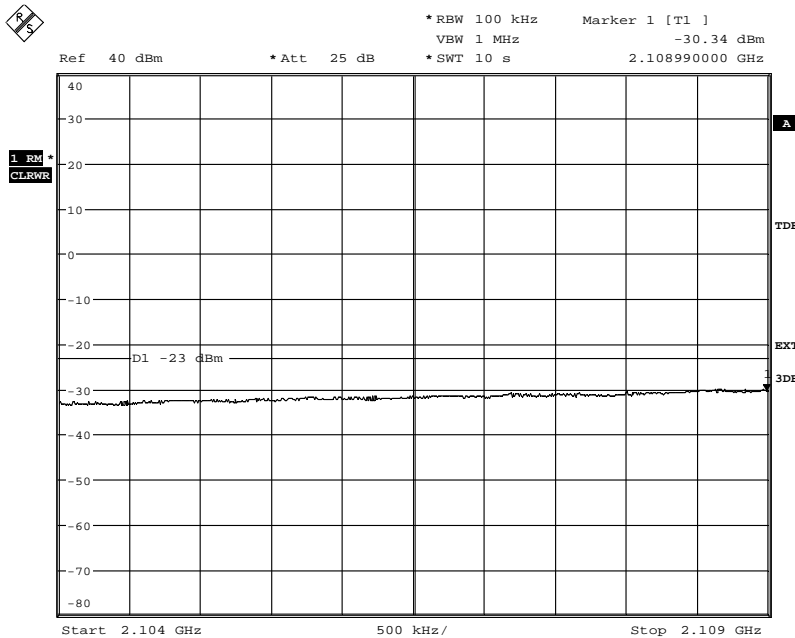

Date: 21.NOV.2012 08:32:34



Appendix 4

Diagram 19c:

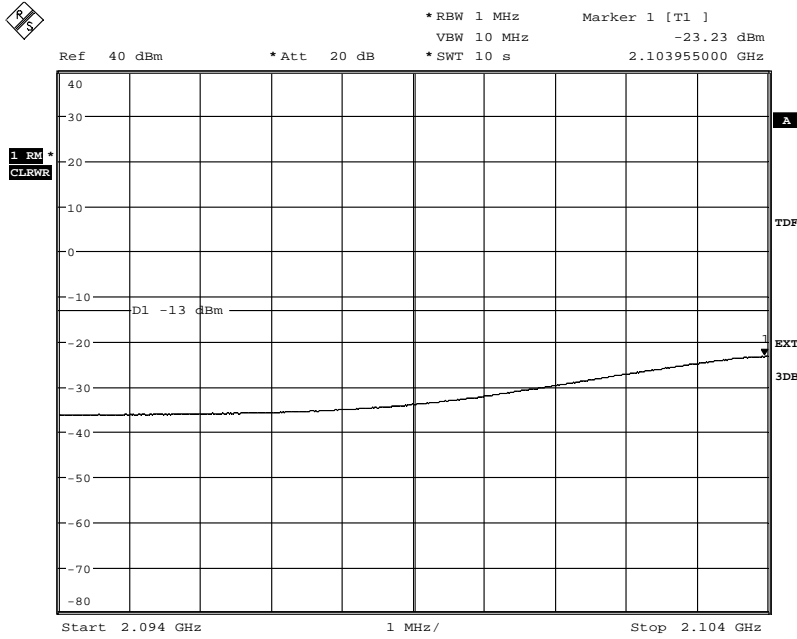

Date: 21.NOV.2012 08:31:30

Appendix 4

Diagram 20a:

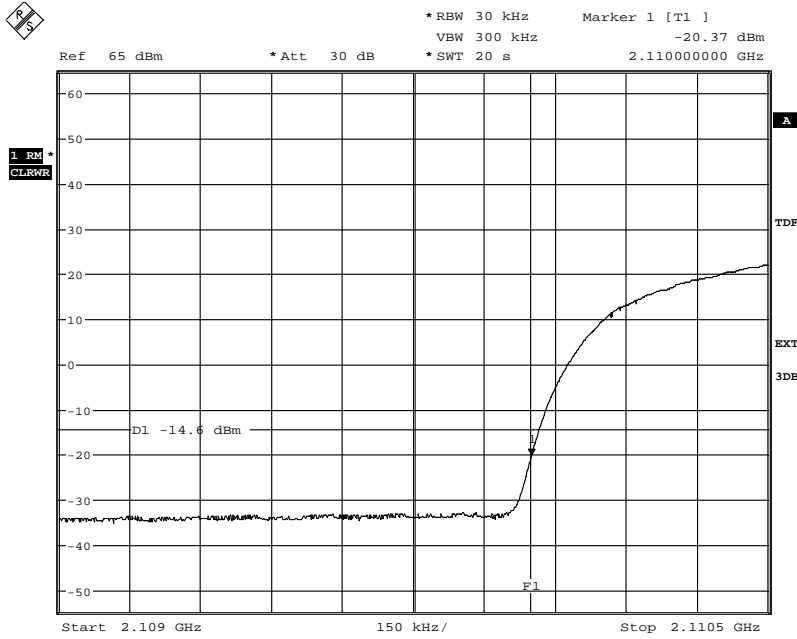

Date: 21.NOV.2012 07:54:55

Diagram 20b:

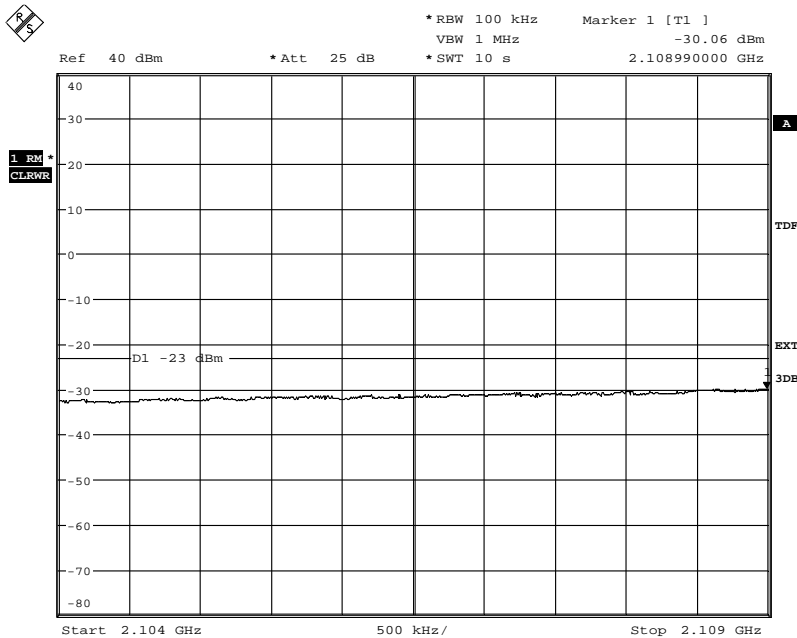

Date: 21.NOV.2012 08:02:40

Appendix 4

Diagram 20c:

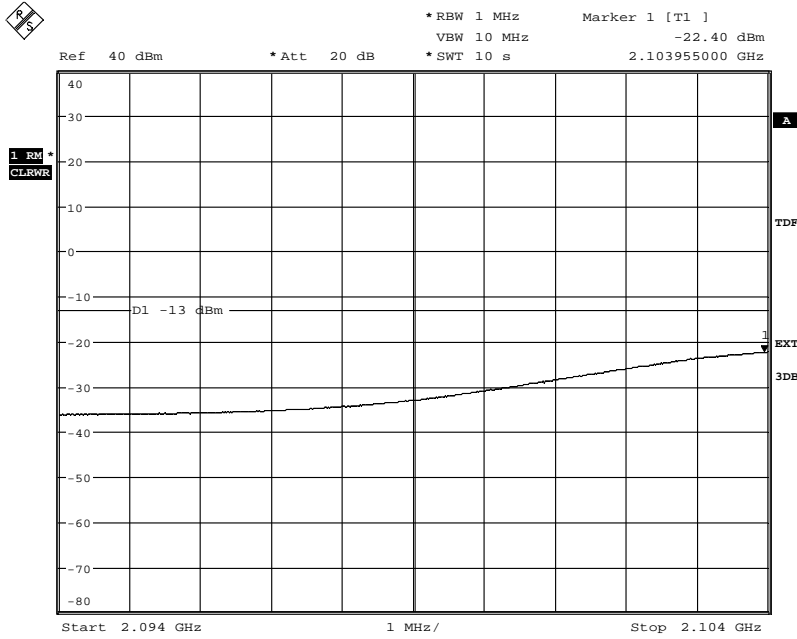

Date: 21.NOV.2012 08:03:41

Appendix 4

Diagram 21 a:

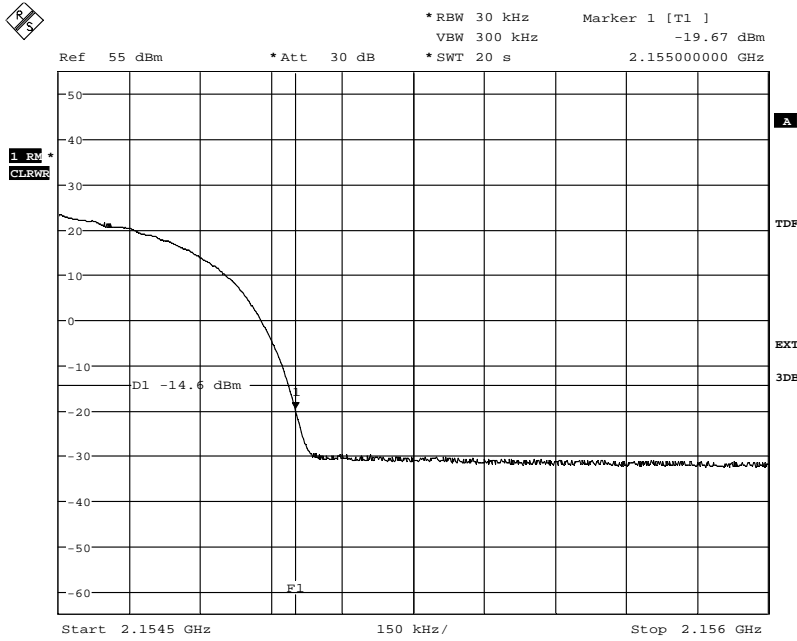

Date: 30.NOV.2012 10:58:33

Diagram 21 b:

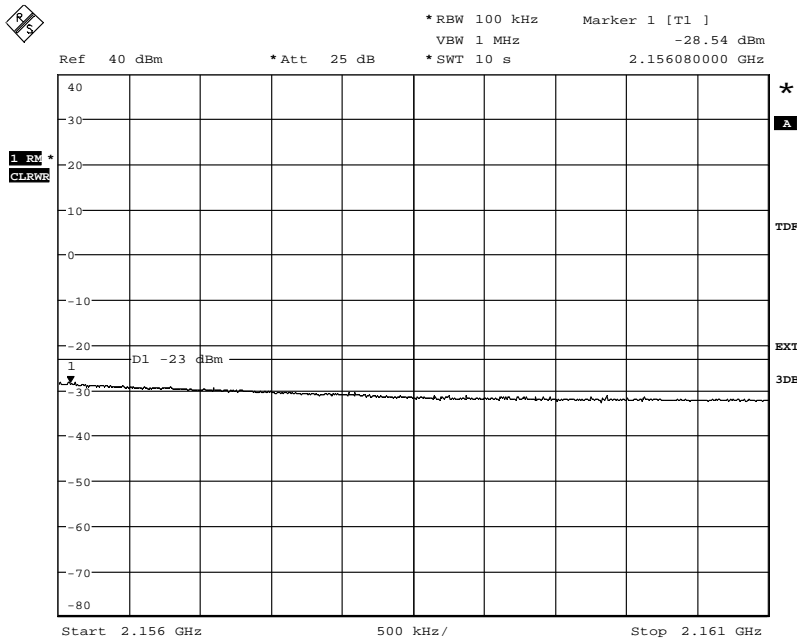

Date: 30.NOV.2012 11:41:45

Appendix 4

Diagram 21 c:

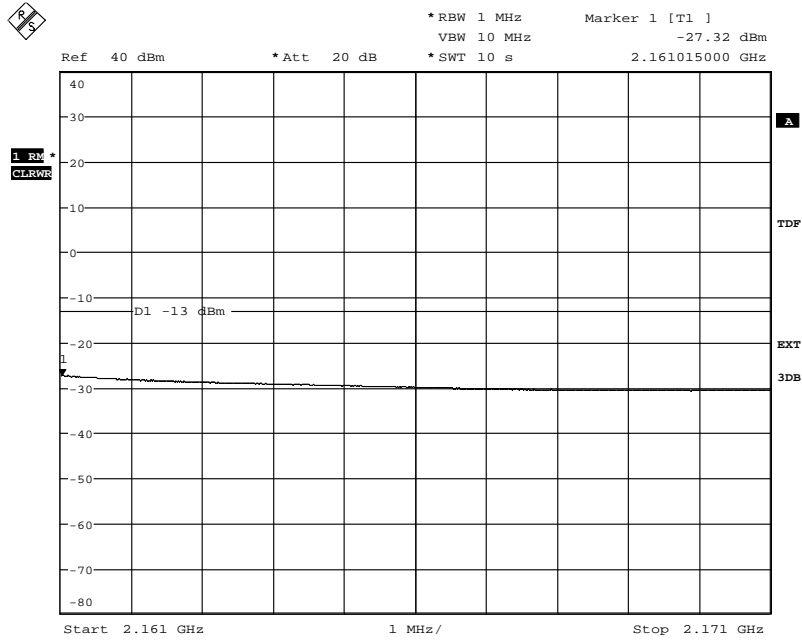

Date: 30.NOV.2012 11:43:47

Appendix 4

Diagram 22 a:

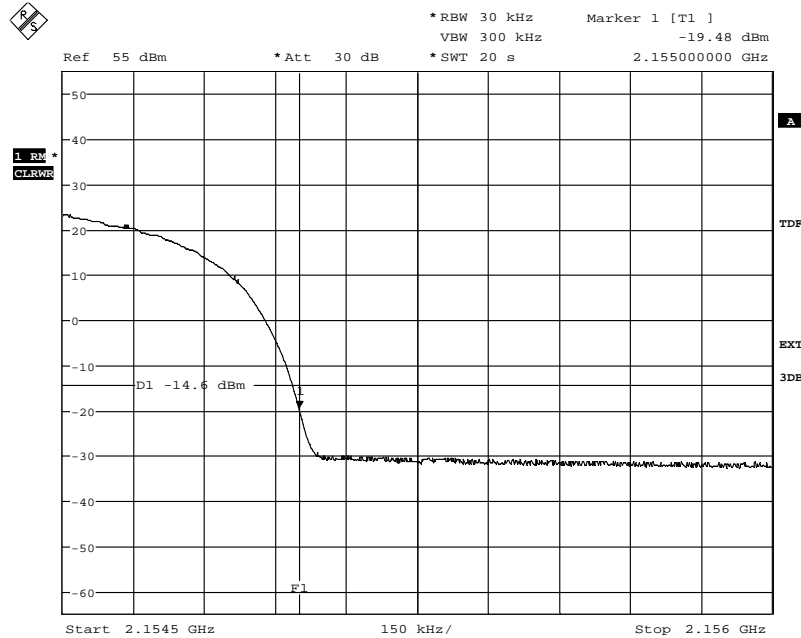

Date: 30.NOV.2012 12:55:27

Diagram 22 b:

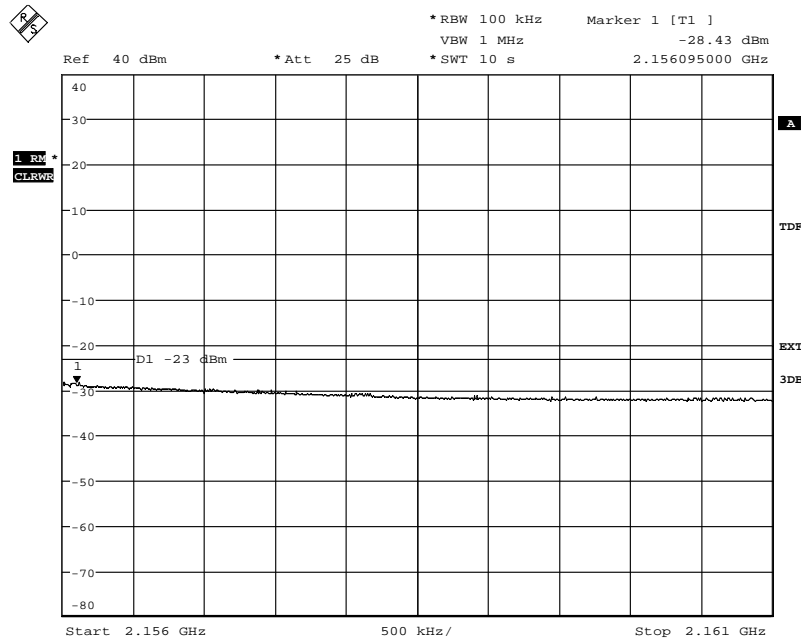

Date: 30.NOV.2012 12:56:39

Appendix 4

Diagram 22 c:

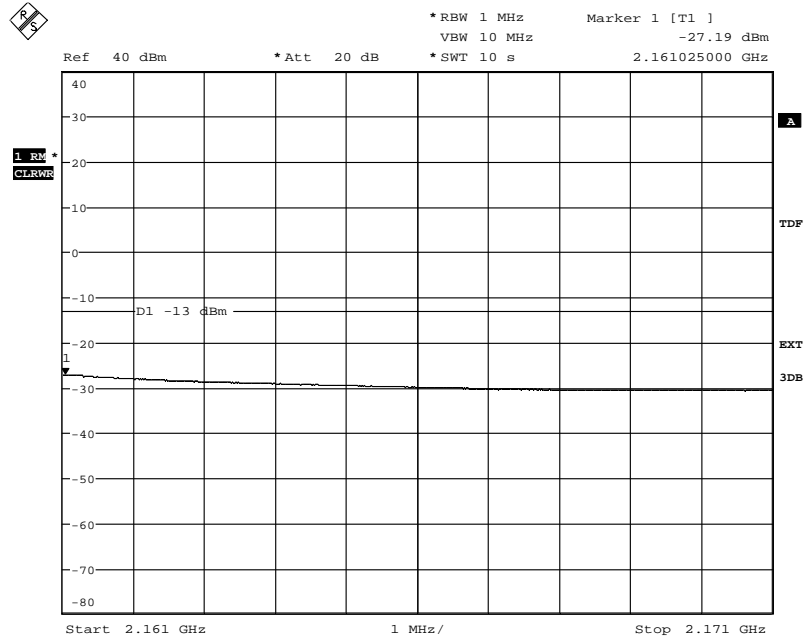

Date: 30.NOV.2012 12:57:39

Appendix 4

Diagram 23 a:

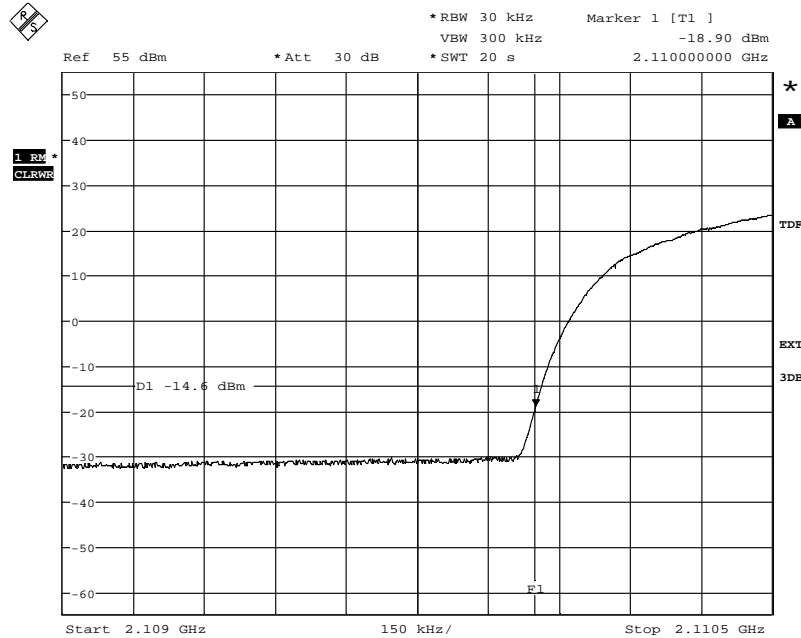

Date: 30.NOV.2012 11:55:06

Diagram 23 b:

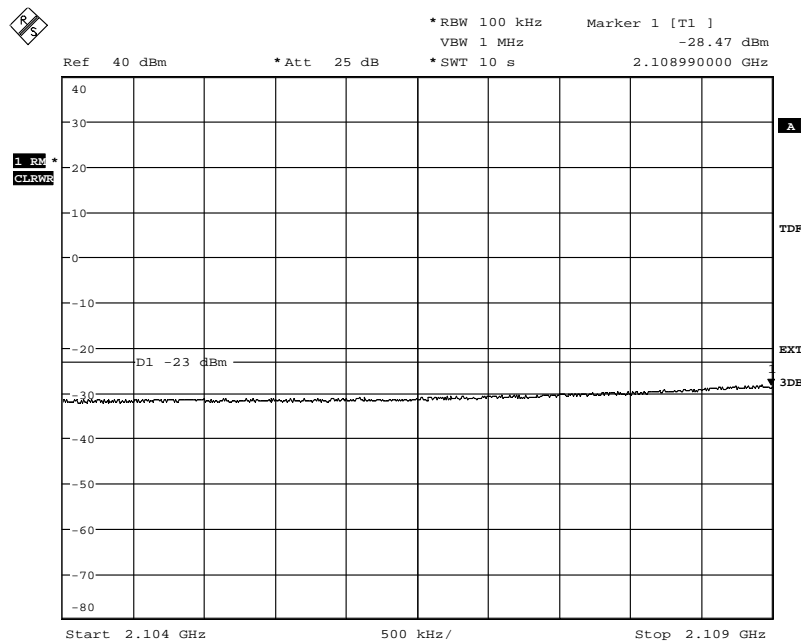

Date: 30.NOV.2012 11:52:33



Appendix 4

Diagram 23 c:

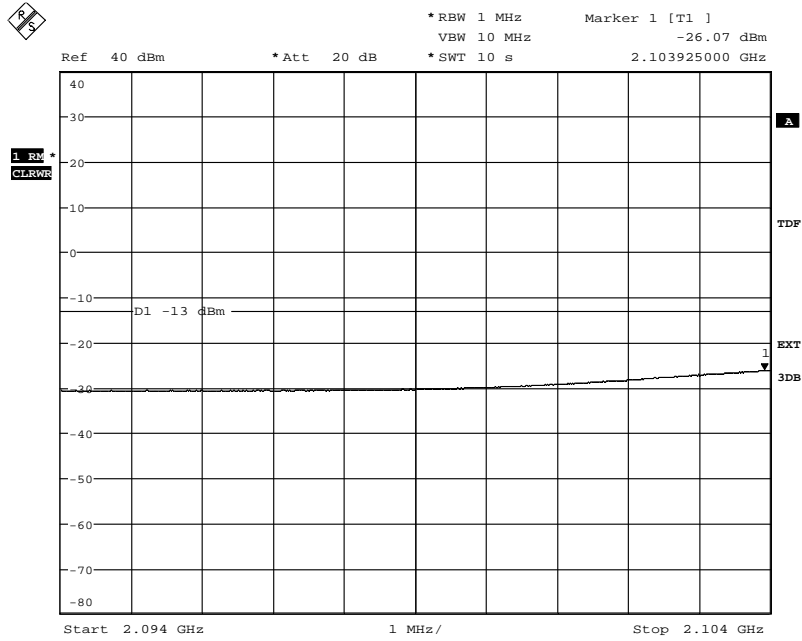

Date: 30.NOV.2012 11:51:04

Appendix 4

Diagram 24 a:

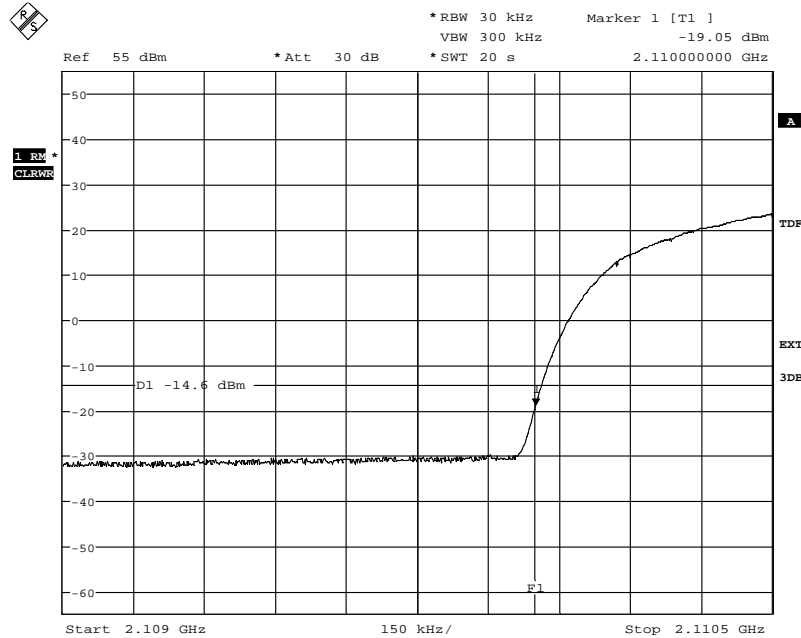

Date: 30.NOV.2012 12:40:58

Diagram 24 b:

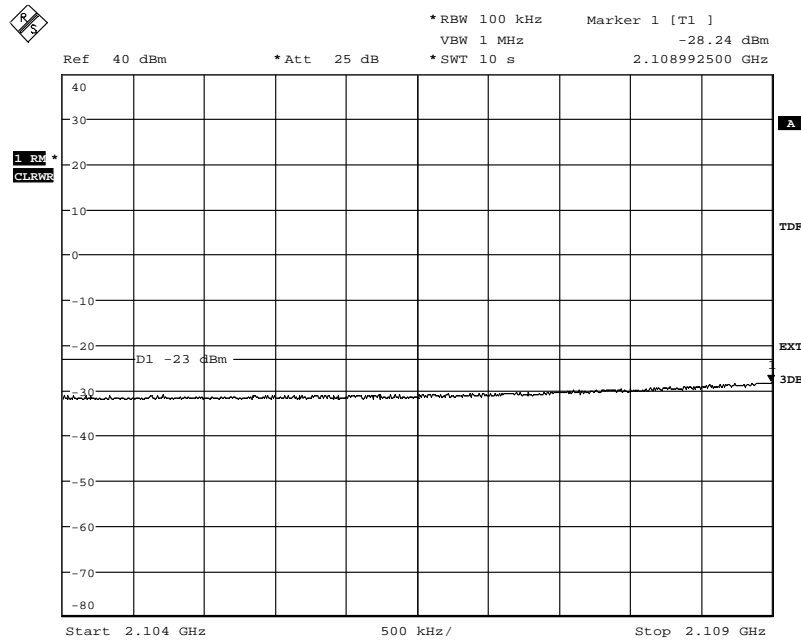

Date: 30.NOV.2012 12:42:42

Appendix 4

Diagram 24 c:

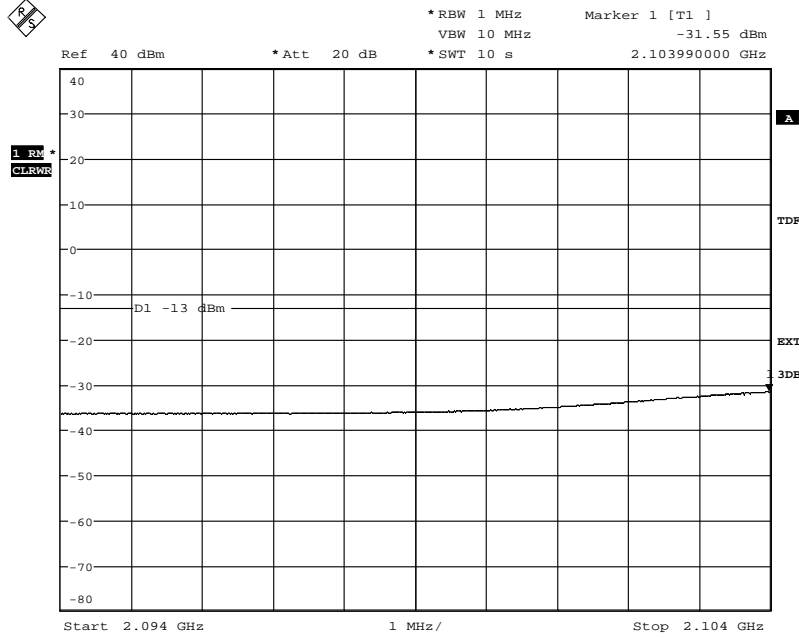

Date: 30.NOV.2012 12:44:00

Appendix 5

**Conducted spurious emission measurements according to CFR 47 §27.53(h)/  
IC RSS-139 6.5**

Date	Temperature	Humidity
2012-11-12	23 °C ± 3 °C	26 % ± 5 %
2012-11-13	23 °C ± 3 °C	23 % ± 5 %
2012-11-21	23 °C ± 3 °C	31 % ± 5 %
2012-11-22	23 °C ± 3 °C	28 % ± 5 %
2012-11-23	23 °C ± 3 °C	30 % ± 5 %
2012-11-30	23 °C ± 3 °C	16 % ± 5 %

**Test set-up and procedure**

The measurements were made per definition in §27.53(h). The output was connected to a spectrum analyzer with a RBW setting of 1 MHz and RMS detector activated. The spectrum analyzer was connected to an external 10 MHz reference standard during the measurements.

Before comparing the results to the limit, 3 dB [10 log (2)] should be added according to method 2 “measure and add 10 log(N<sub>ANT</sub>)” of FCC KDB662911 D01 Multiple Transmitter Output v01r02

Measurement equipment	SP number
R&S FSQ	504 143
RF attenuator	504 159
RF attenuator	901 384
RF attenuator	900 233
HP filter	901 502
Directional coupler	901 496
Testo 635, temperature and humidity meter	504 203

Measurement uncertainty: 3.7 dB

## Appendix 5

### Results

#### LTE:

Diagram	BW configuration / [MHz]	Tested frequency	Tested Port
1 a+b+c+d	1.4 MHz	M	RUS 1, primary linked
2 a+b+c+d	1.4 MHz	M	RUS 1, secondary linked
3 a+b+c+d	20 MHz	M	RUS 1, primary linked
4 a+b+c+d	20 MHz	M	RUS 1, secondary linked

#### WCDMA:

Diagram	BW configuration / [MHz]	Tested frequency	Tested Port
5 a+b+c+d	5 MHz	M+(M+5)	RUS 1, primary linked
6 a+b+c+d	5 MHz	M+(M+5)	RUS 1, secondary linked
7 a+b+c+d	5 MHz	M	RUS 1, primary linked
8 a+b+c+d	5 MHz	M	RUS 1, secondary linked

#### MSR, LTE +WCDMA:

Diagram	Tested configuration	Tested Port
9	1	RF A
10	2	RF A
11	3	RF A
12 a+b+c+d	4	RF A
13 a+b+c+d	5	RF A
14 a+b+c+d	6	RF A
15	7	RF A
16	8	RF A
17	9	RF A

Appendix 5

Diagram 1a:

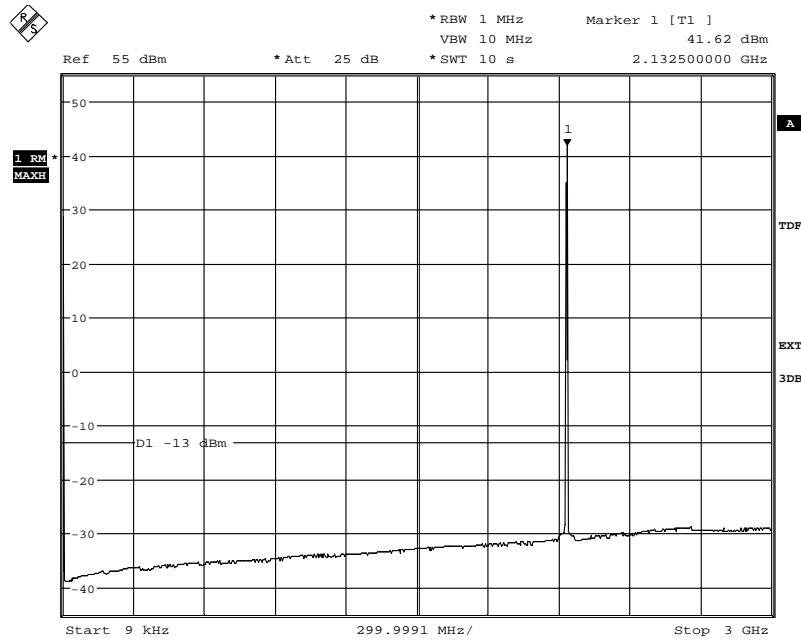

Date: 12.NOV.2012 12:58:55

Diagram 1b

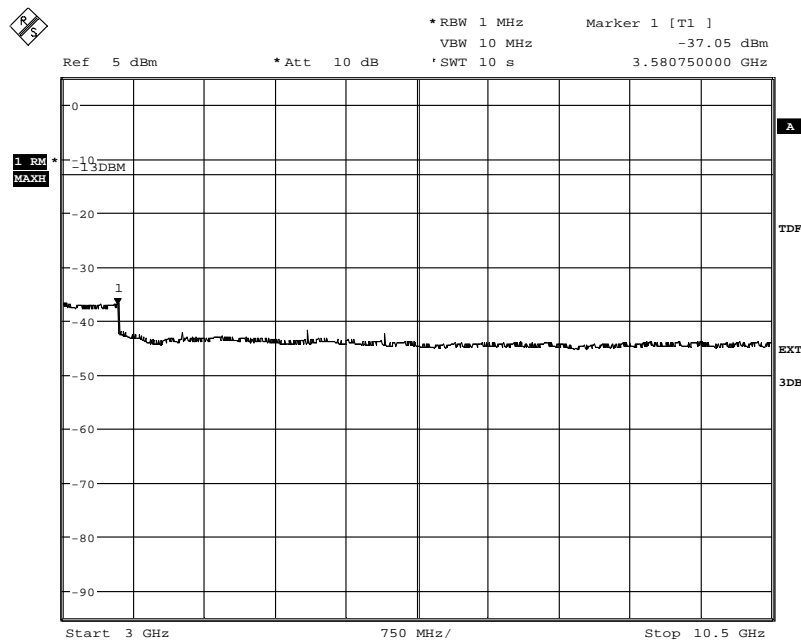

Date: 12.NOV.2012 13:06:06

Appendix 5

Diagram 1c:

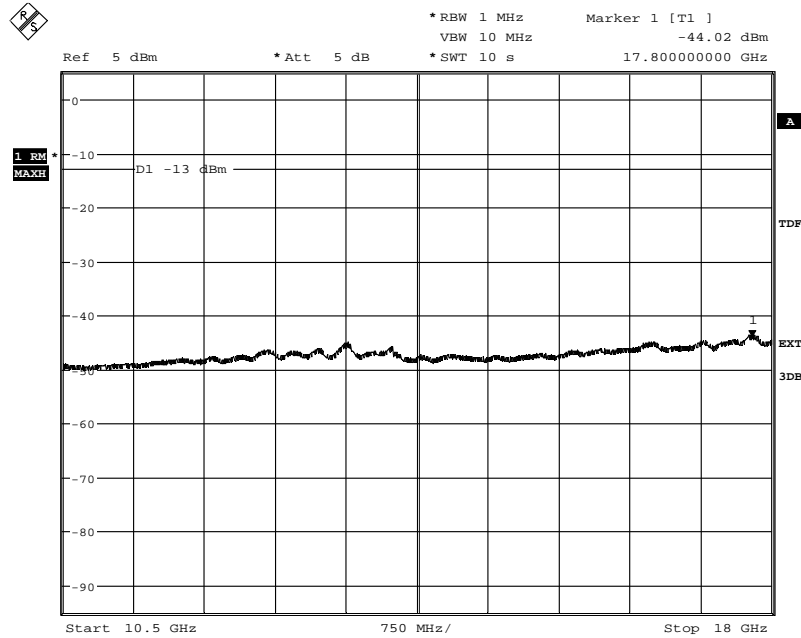

Date: 12.NOV.2012 13:06:51

Diagram 1d

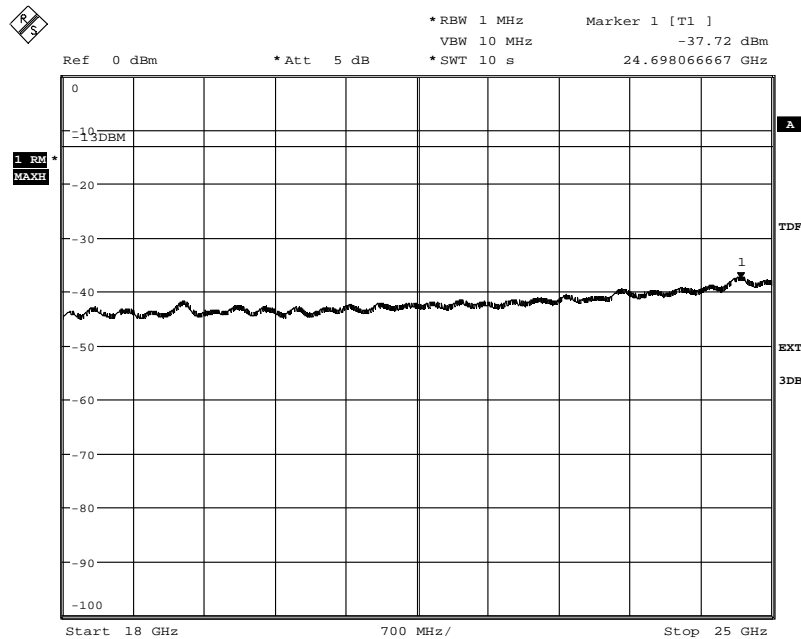

Date: 12.NOV.2012 13:07:33

Appendix 5

Diagram 2a:

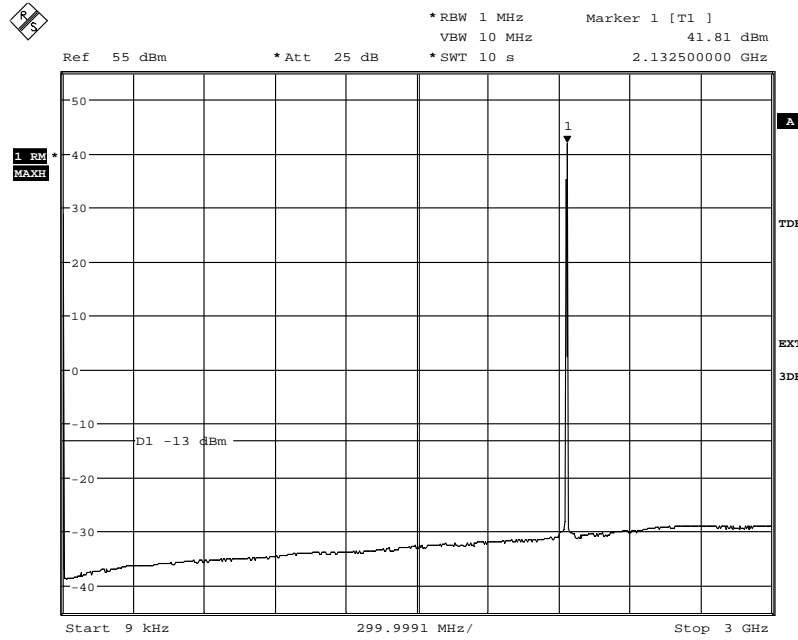

Date: 13.NOV.2012 07:51:22

Diagram 2b:

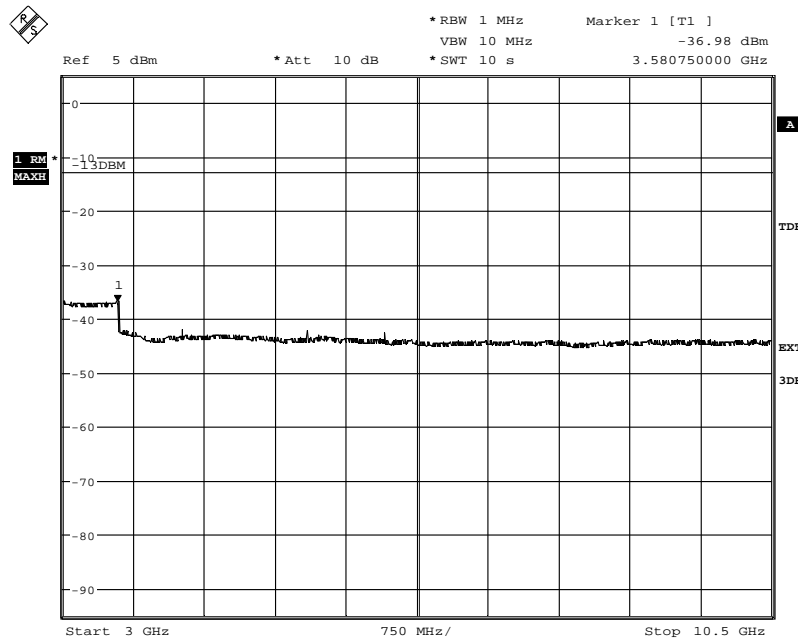

Date: 13.NOV.2012 07:49:10



Appendix 5

Diagram 2c:

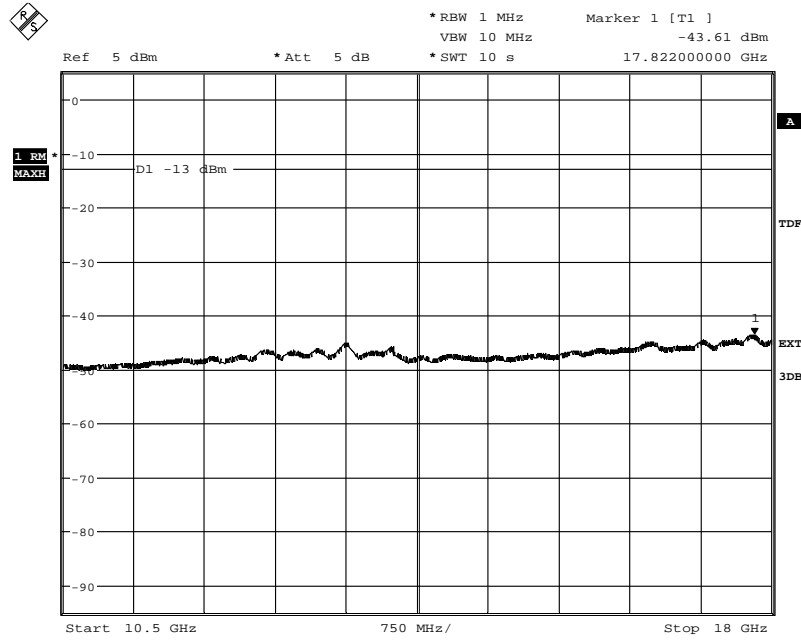

Date: 13.NOV.2012 07:47:02

Diagram 2d:

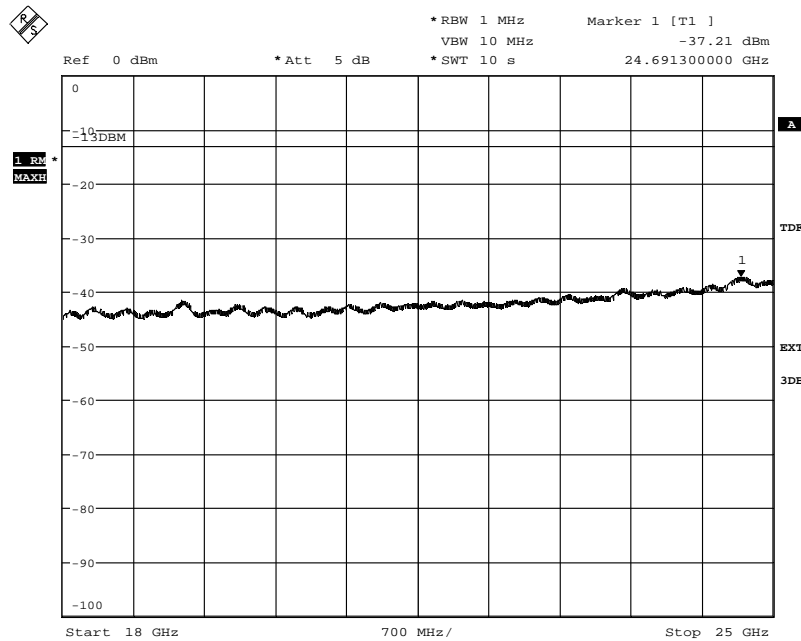

Date: 13.NOV.2012 07:45:29

Appendix 5

Diagram 3a:

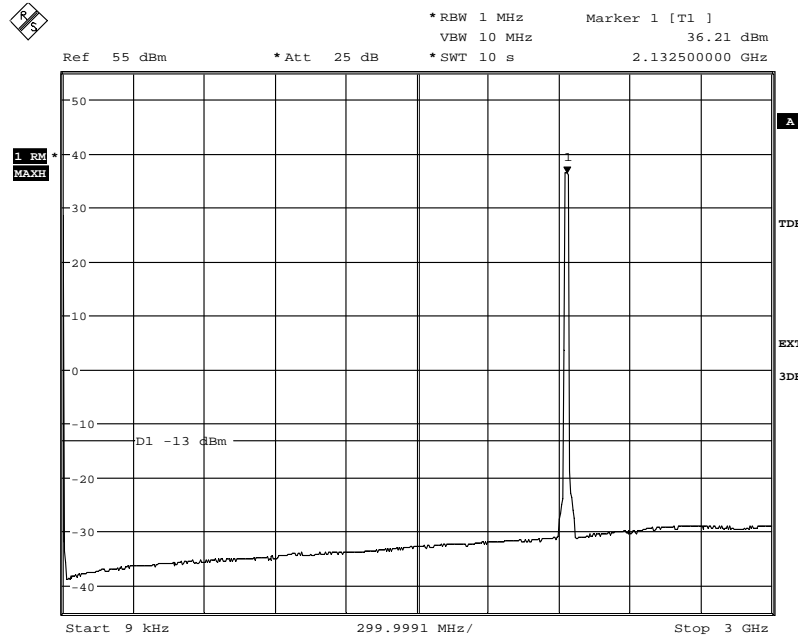

Date: 12.NOV.2012 13:39:30

Diagram 3b:

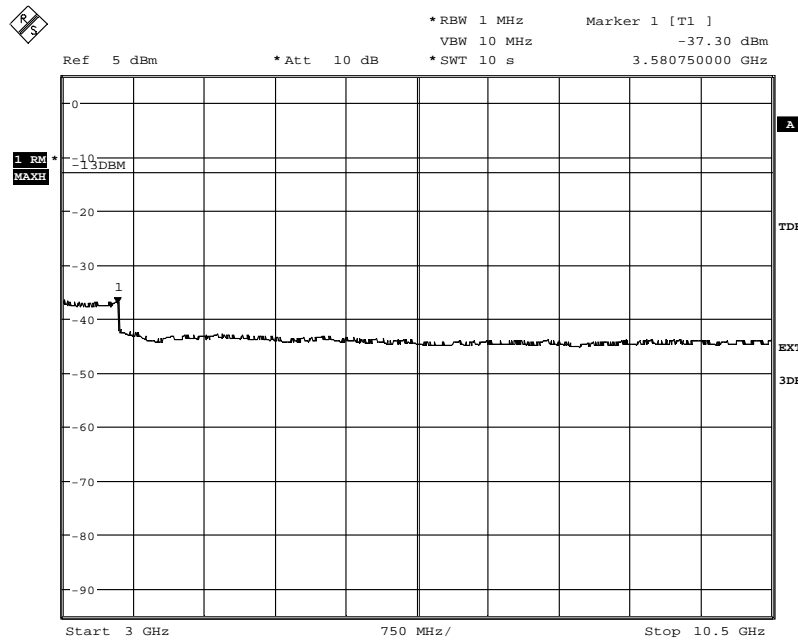

Date: 12.NOV.2012 13:44:05

Appendix 5

Diagram 3c:

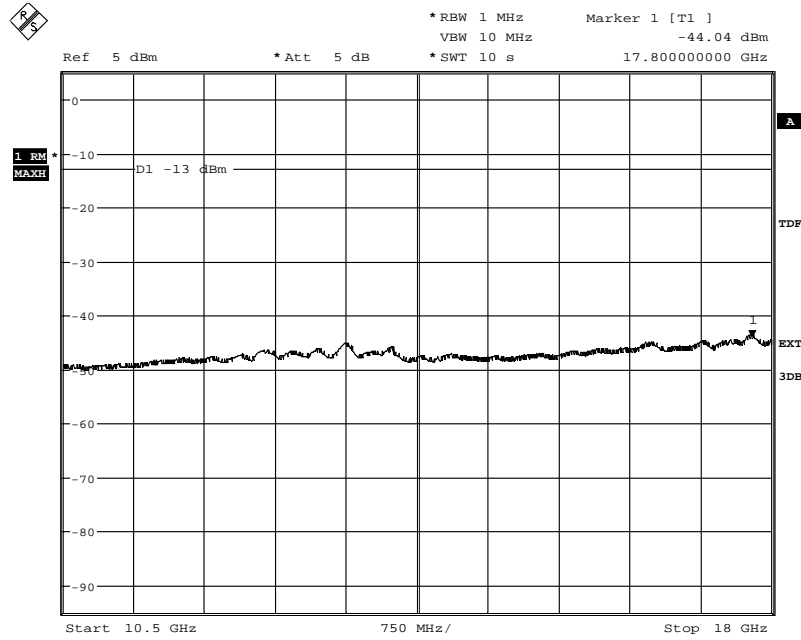

Date: 12.NOV.2012 13:45:02

Diagram 3d:

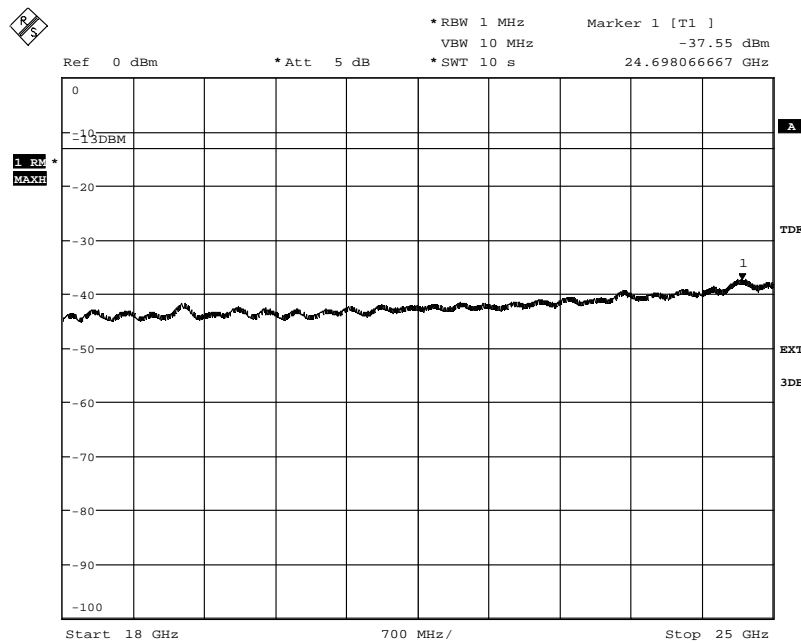

Date: 12.NOV.2012 13:45:44

Appendix 5

Diagram 4a:

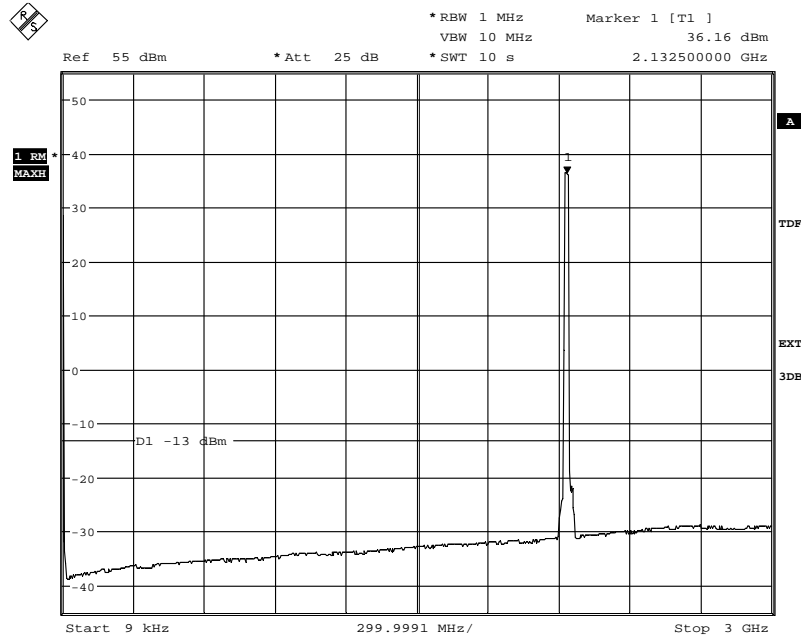

Date: 12.NOV.2012 15:42:51

Diagram 4b

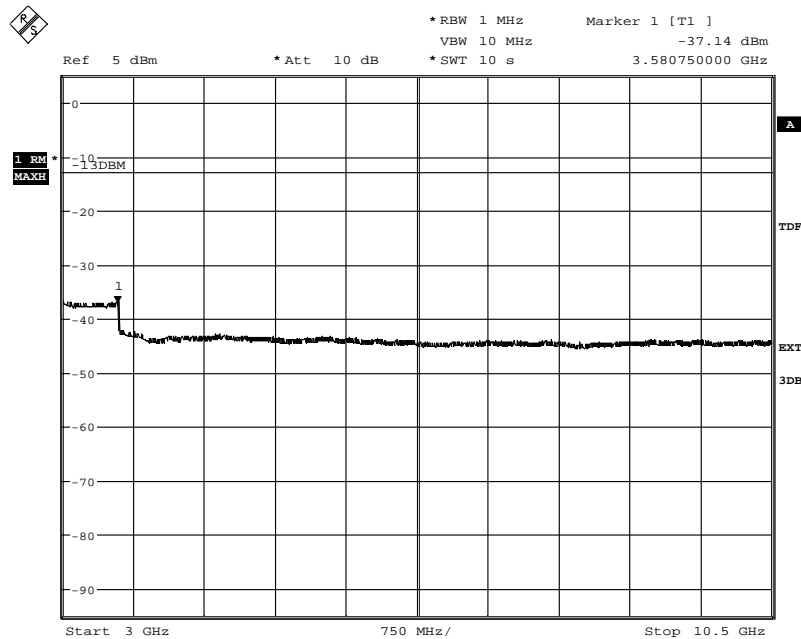

Date: 12.NOV.2012 15:43:53

Appendix 5

Diagram 4c:

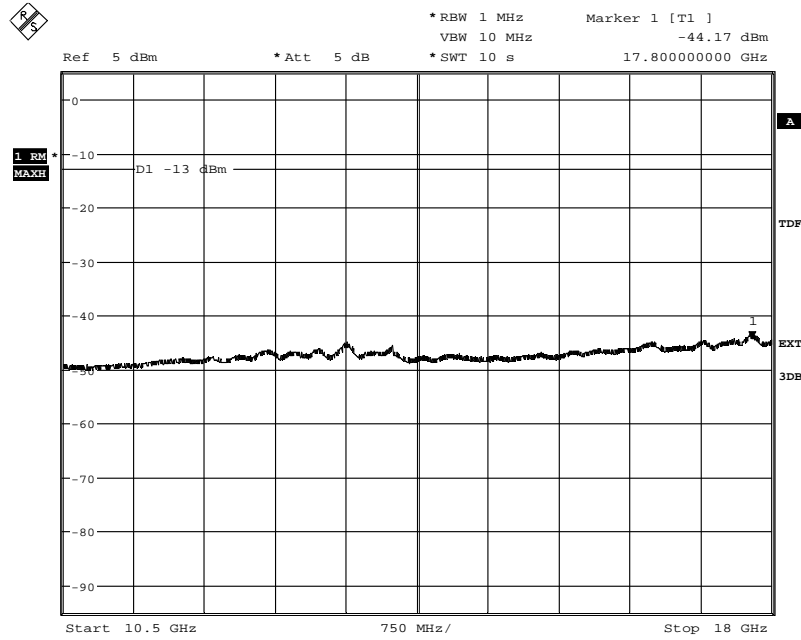

Date: 12.NOV.2012 15:44:39

Diagram 4d:

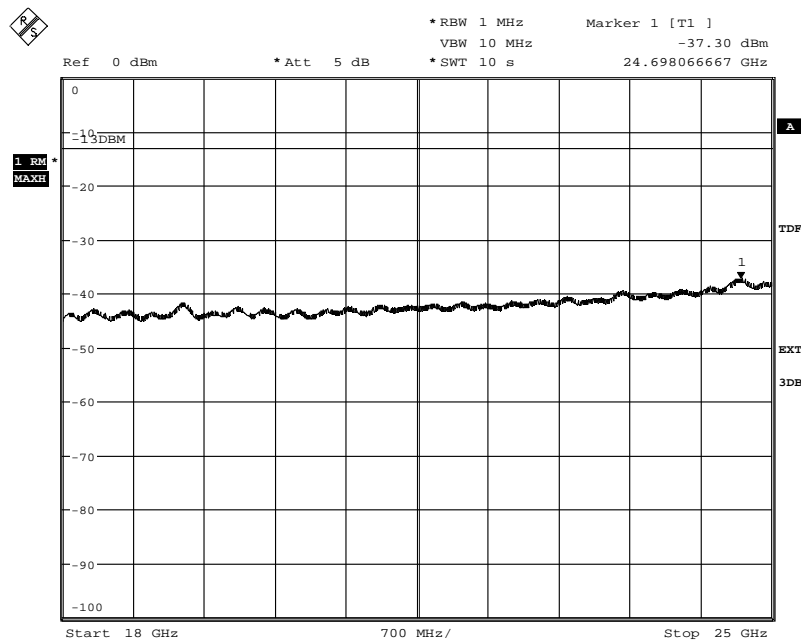

Date: 12.NOV.2012 15:45:20

Appendix 5

Diagram 5a:

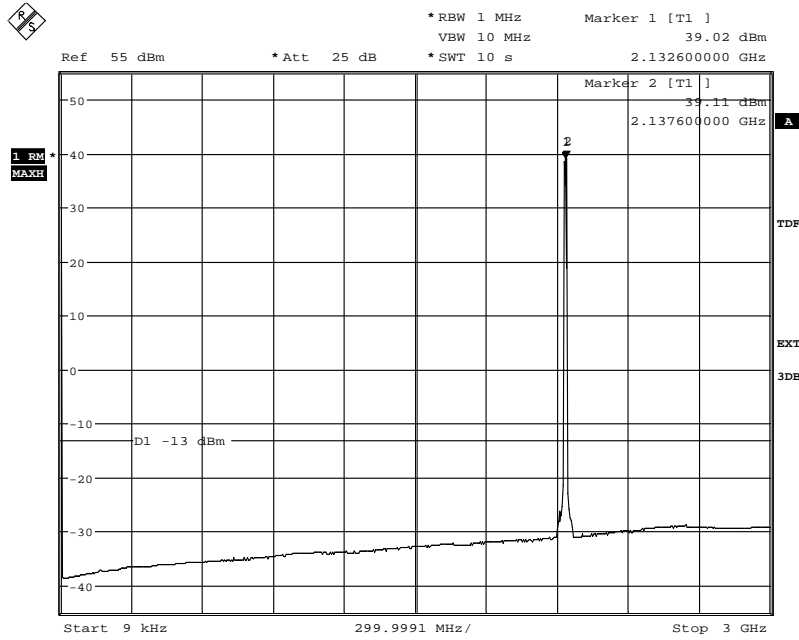

Date: 21.NOV.2012 09:02:47

Diagram 5b

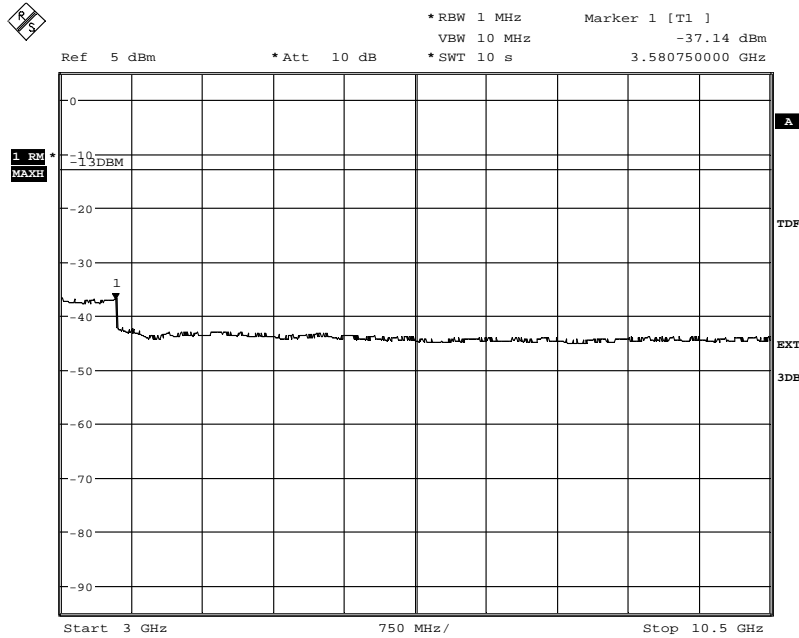

Date: 21.NOV.2012 09:10:46

Appendix 5

Diagram 5c:

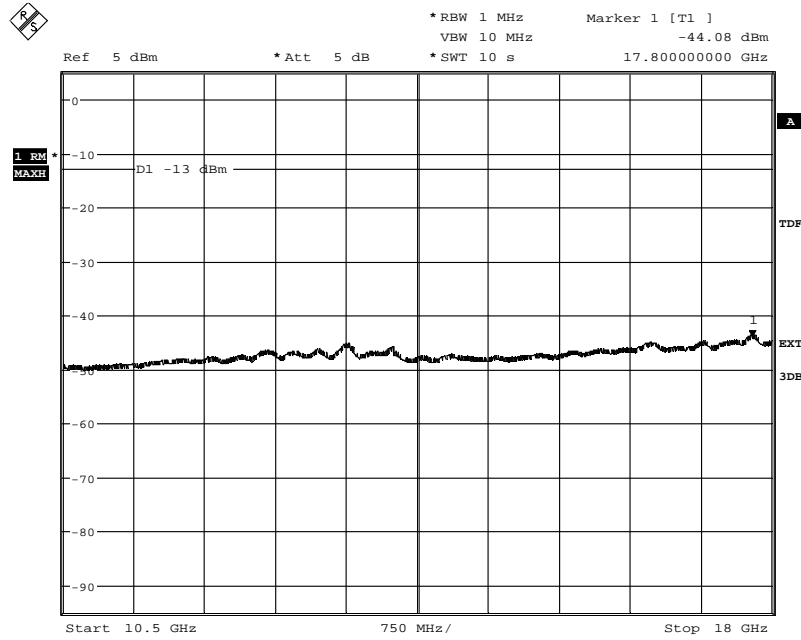

Date: 21.NOV.2012 09:11:34

Diagram 5d:

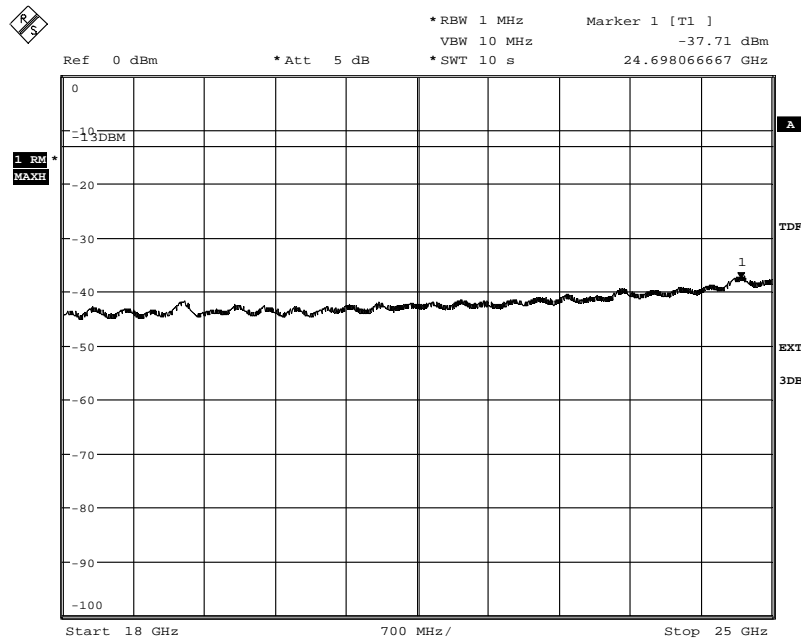

Date: 21.NOV.2012 09:12:21

Appendix 5

Diagram 6a:

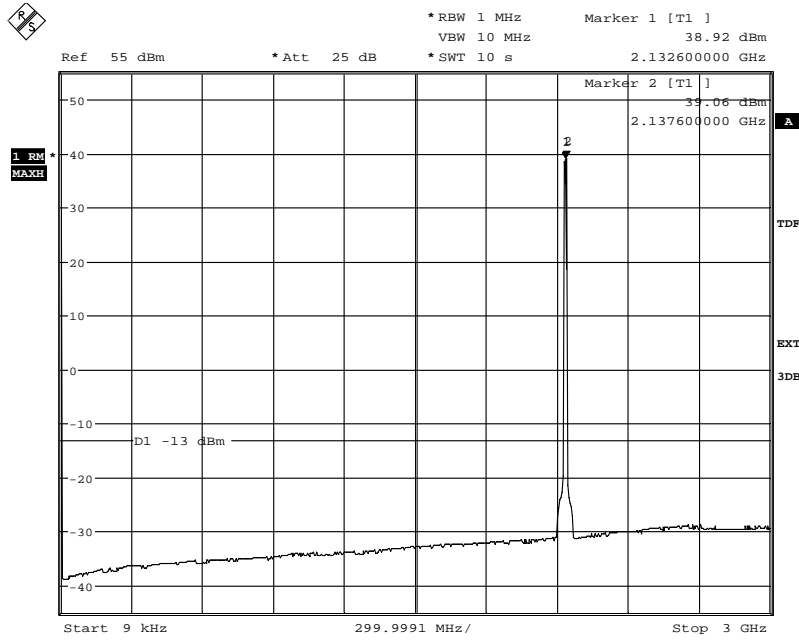

Date: 21.NOV.2012 09:34:22

Diagram 6b

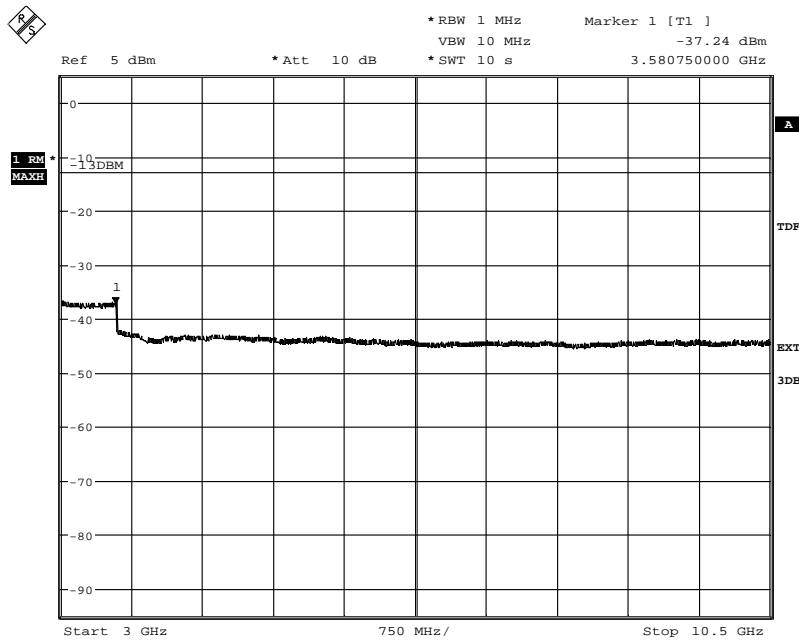

Date: 21.NOV.2012 09:36:21



Appendix 5

Diagram 6c:

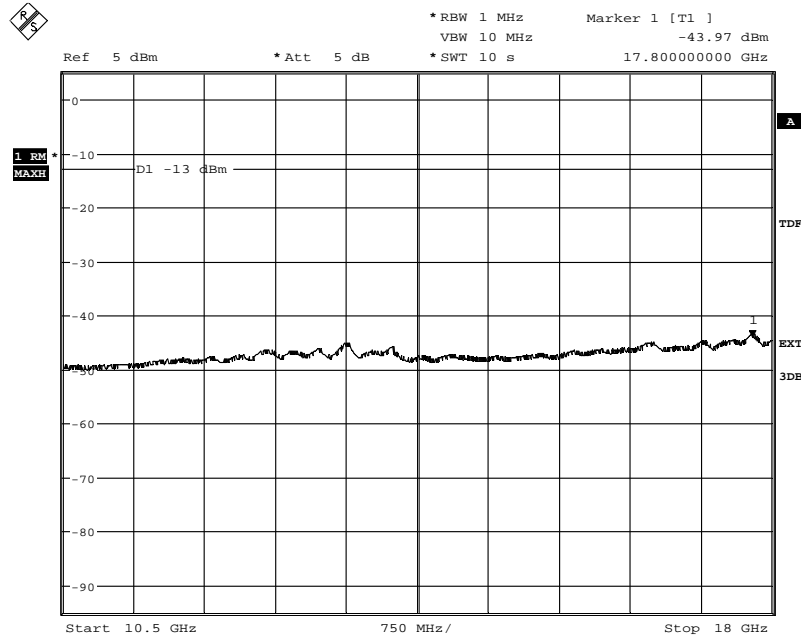

Date: 21.NOV.2012 09:37:35

Diagram 6d:

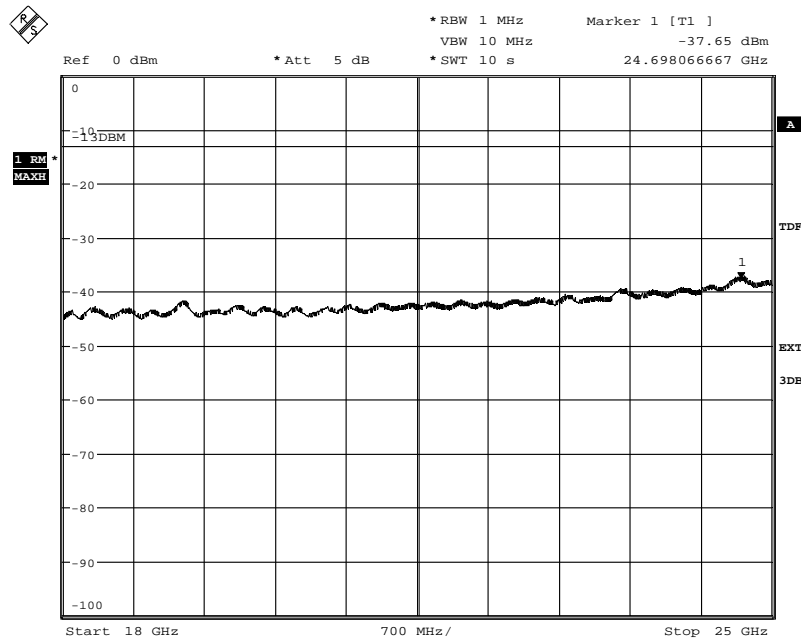

Date: 21.NOV.2012 09:38:22

Appendix 5

Diagram 7a:

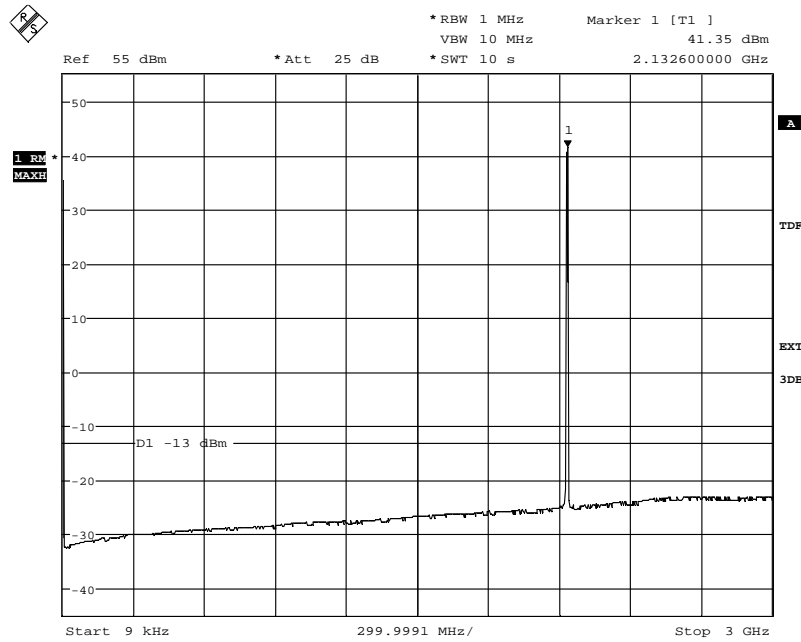

Date: 30.NOV.2012 12:11:28

Diagram 7b:

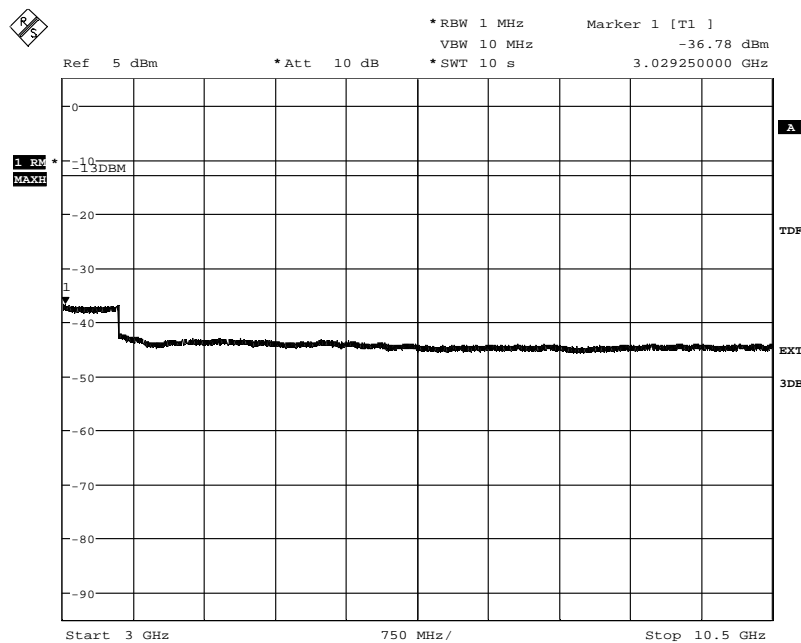

Date: 30.NOV.2012 12:13:24

Appendix 5

Diagram 7c:

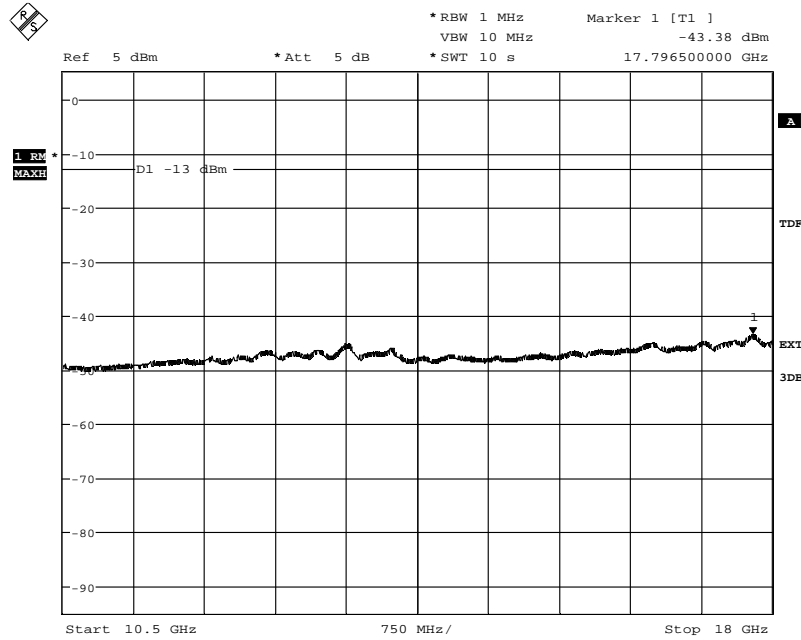

Date: 30.NOV.2012 12:14:33

Diagram 7d:

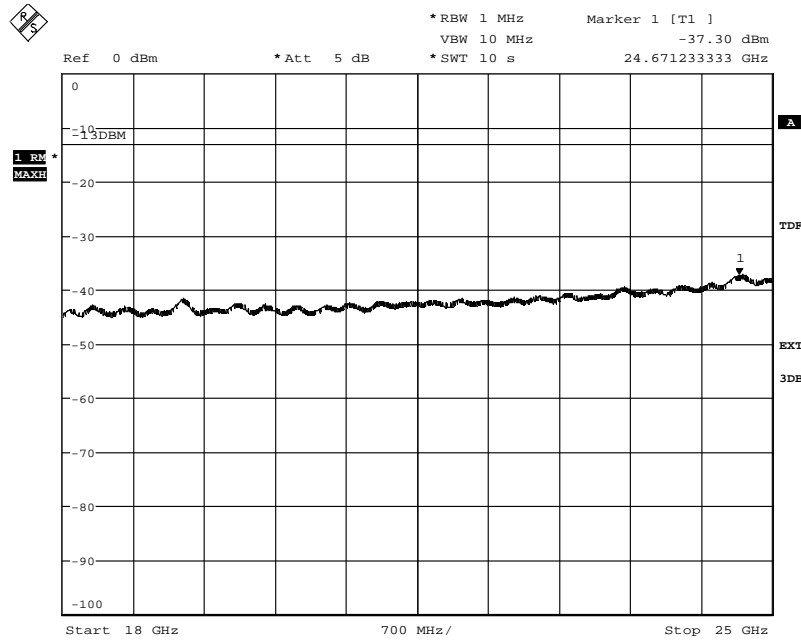

Date: 30.NOV.2012 12:15:31

Appendix 5

Diagram 8a:

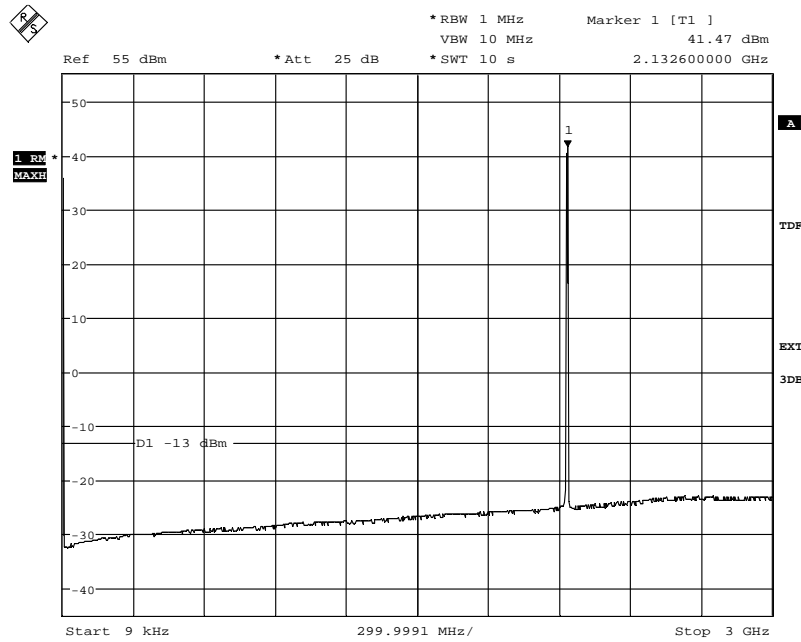

Date: 30.NOV.2012 12:26:41

Diagram 8b:

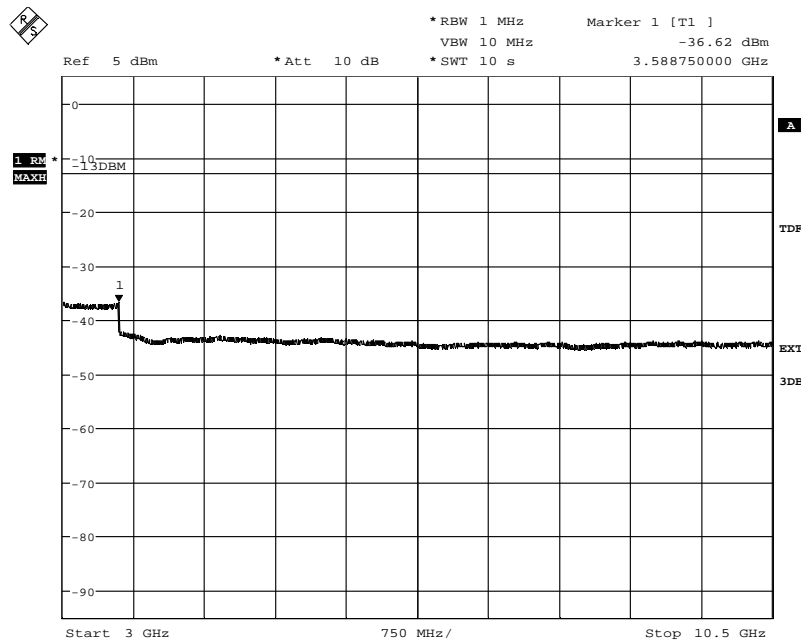

Date: 30.NOV.2012 12:25:21

Appendix 5

Diagram 8c:

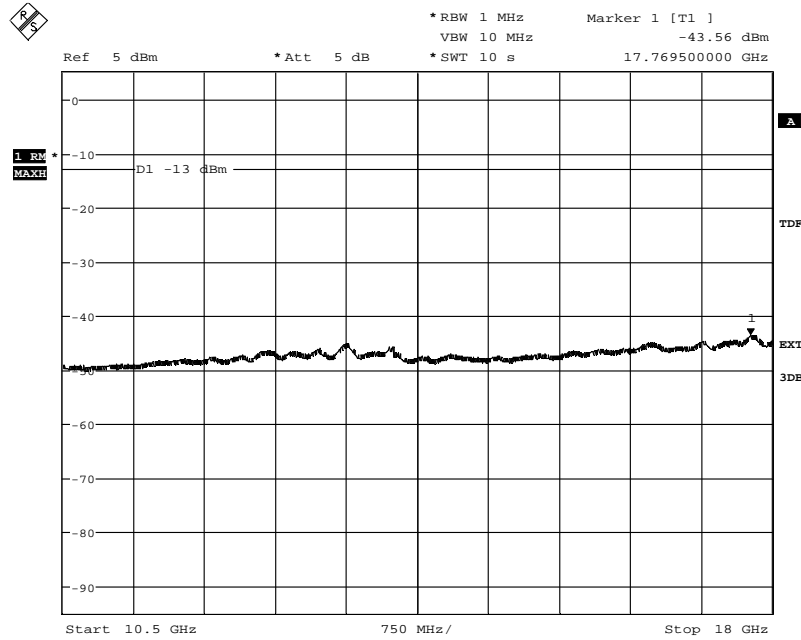

Date: 30.NOV.2012 12:24:21

Diagram 8d:

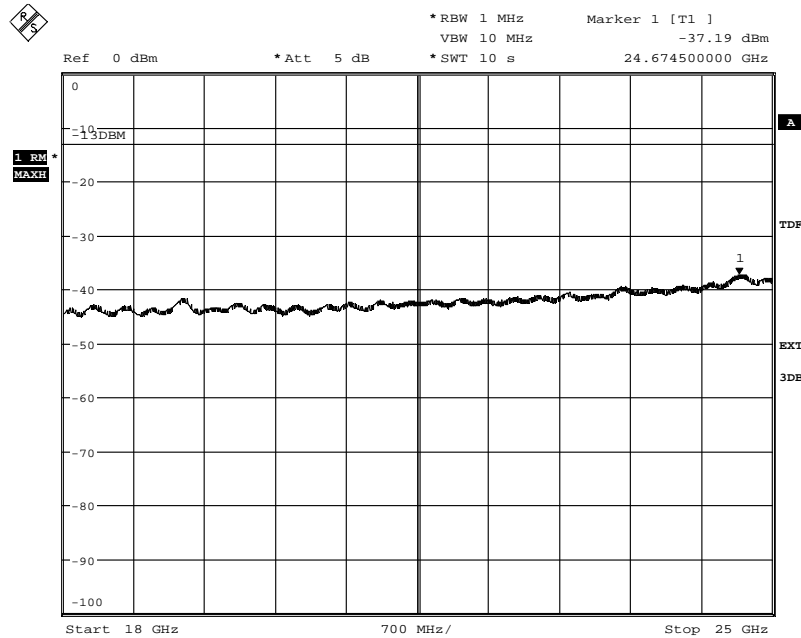

Date: 30.NOV.2012 12:22:17

Appendix 5

Diagram 9:

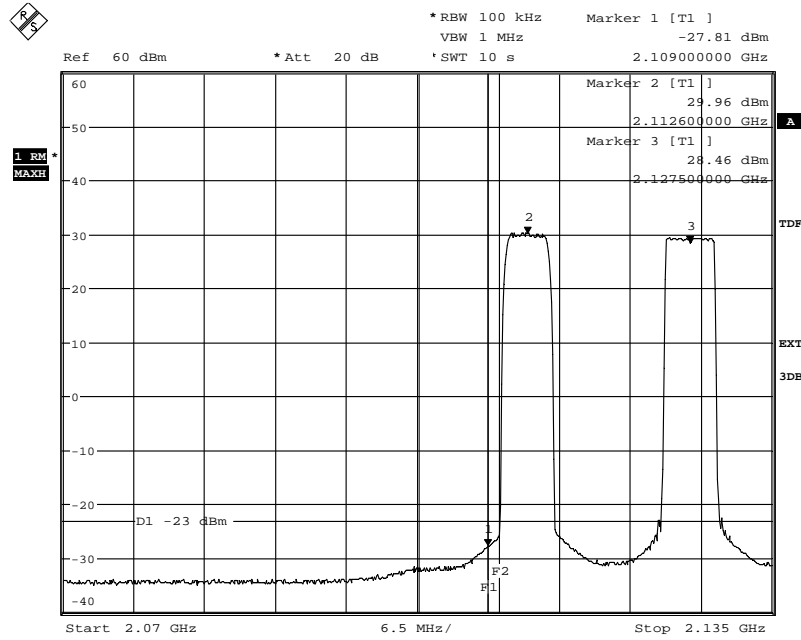

Date: 22.NOV.2012 08:26:50

Diagram 10:

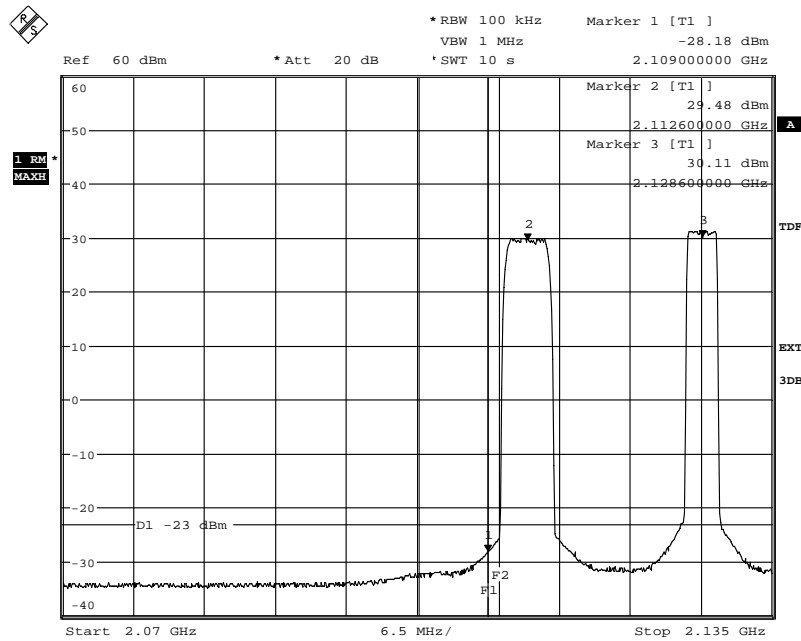

Date: 22.NOV.2012 08:24:28

Appendix 5

Diagram 11:

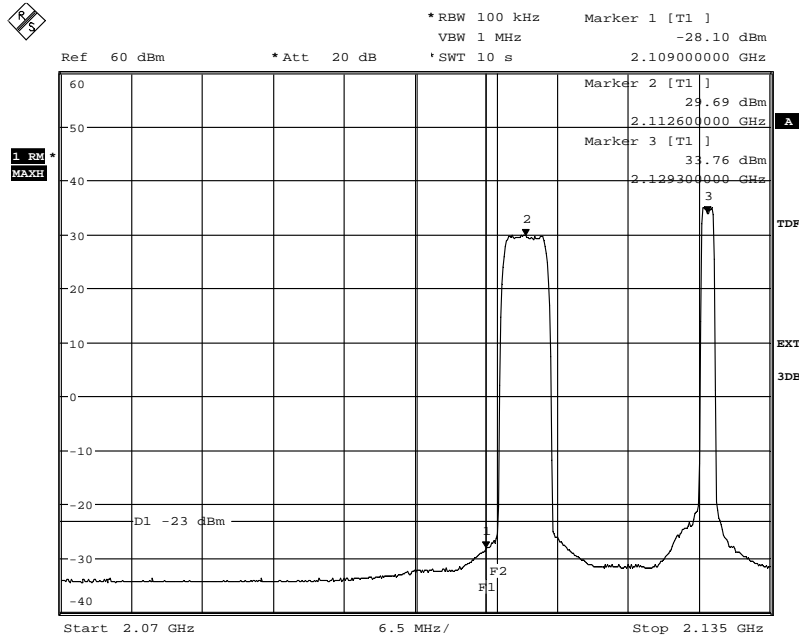

Date: 22.NOV.2012 08:13:21

Appendix 5

Diagram 12 a:

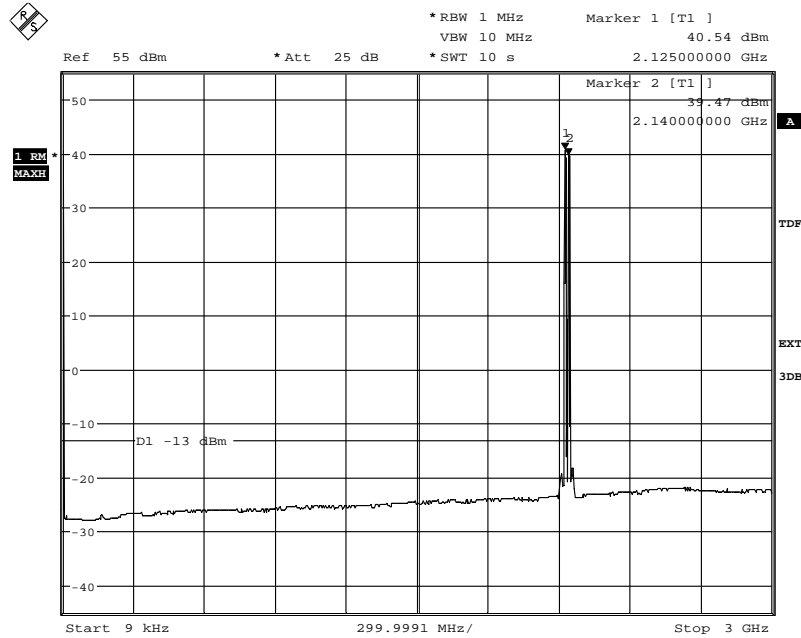

Date: 22.NOV.2012 12:42:04

Diagram 12 b:

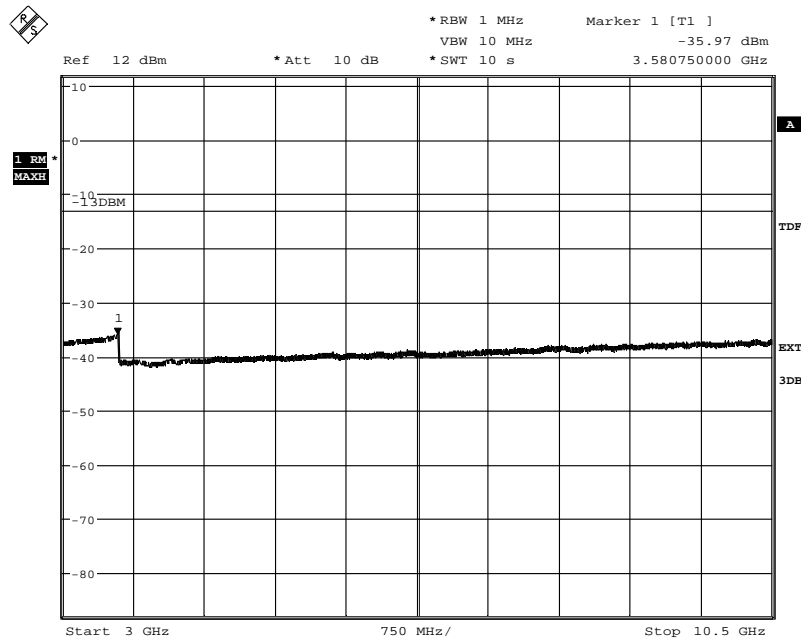

Date: 22.NOV.2012 12:44:15



Appendix 5

Diagram 12 c:

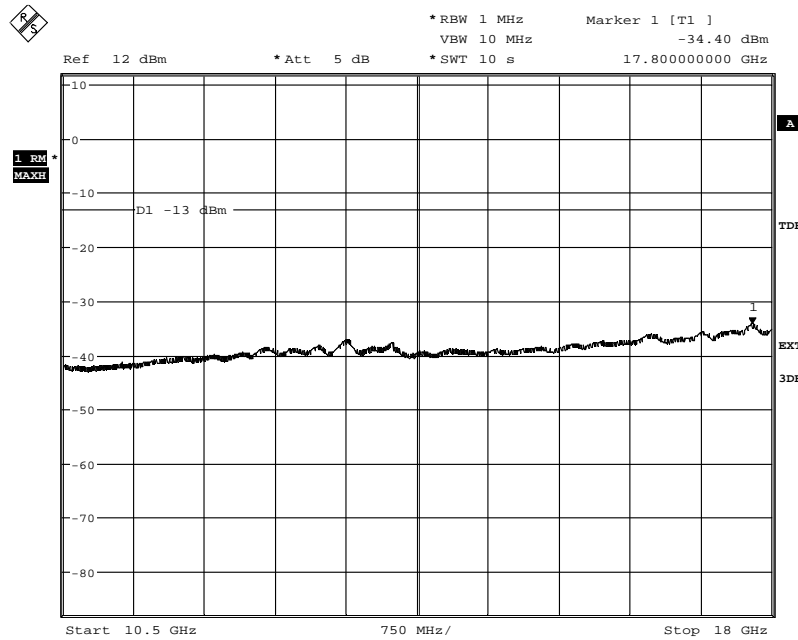

Date: 22.NOV.2012 12:45:37

Diagram 12 d:

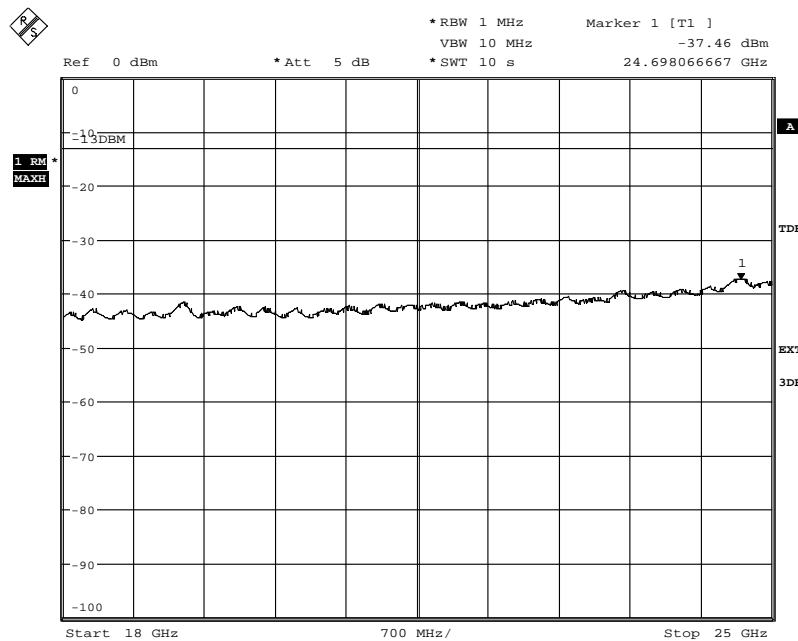

Date: 23.NOV.2012 08:11:57

Appendix 5

Diagram 13 a:

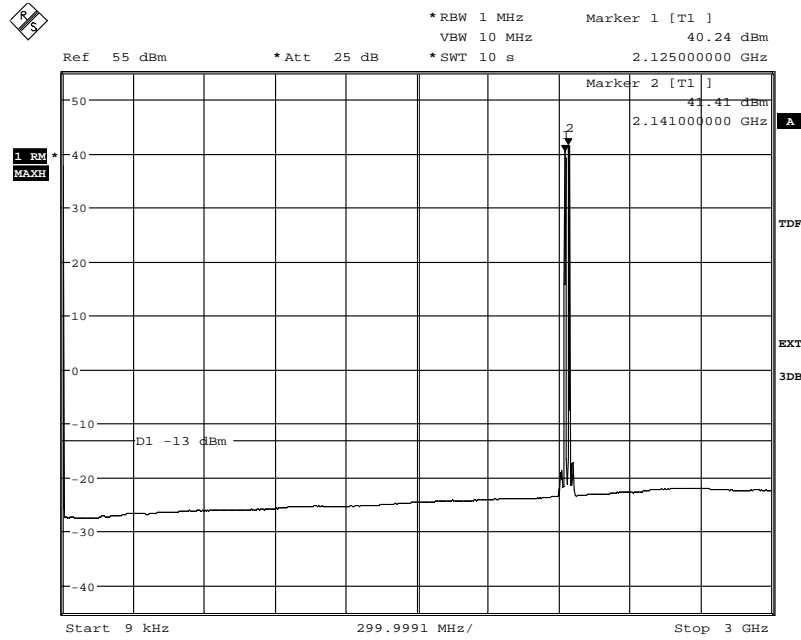

Date: 23.NOV.2012 07:50:48

Diagram 13 b:

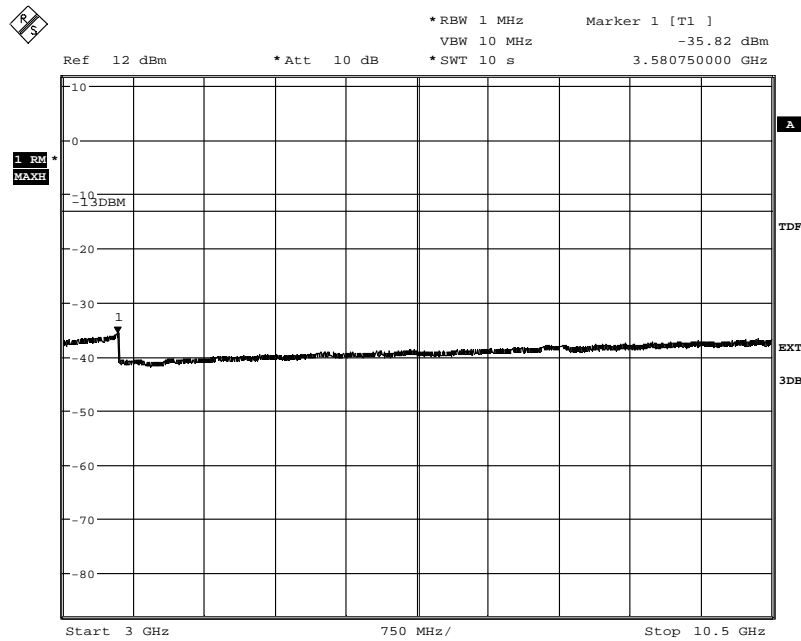

Date: 23.NOV.2012 07:59:14

Appendix 5

Diagram 13 c:

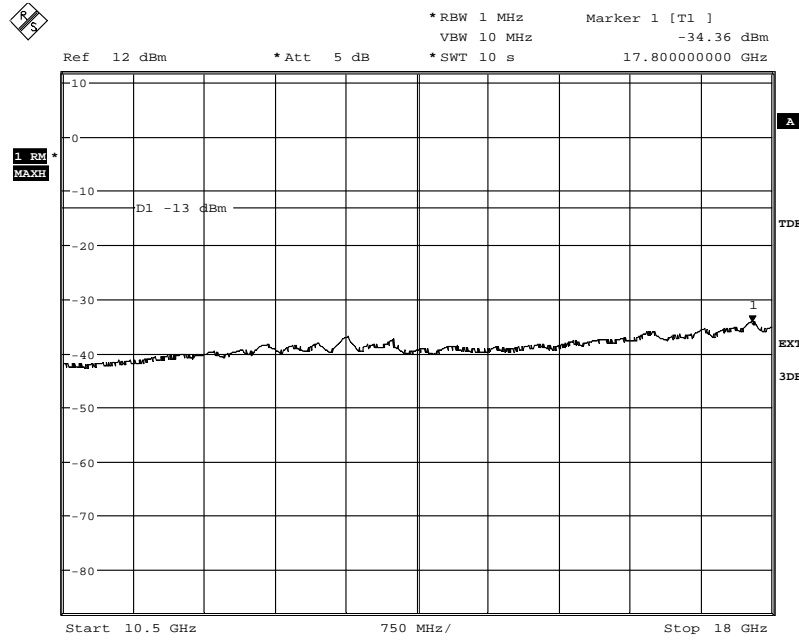

Date: 23.NOV.2012 08:01:41

Diagram 13 d:

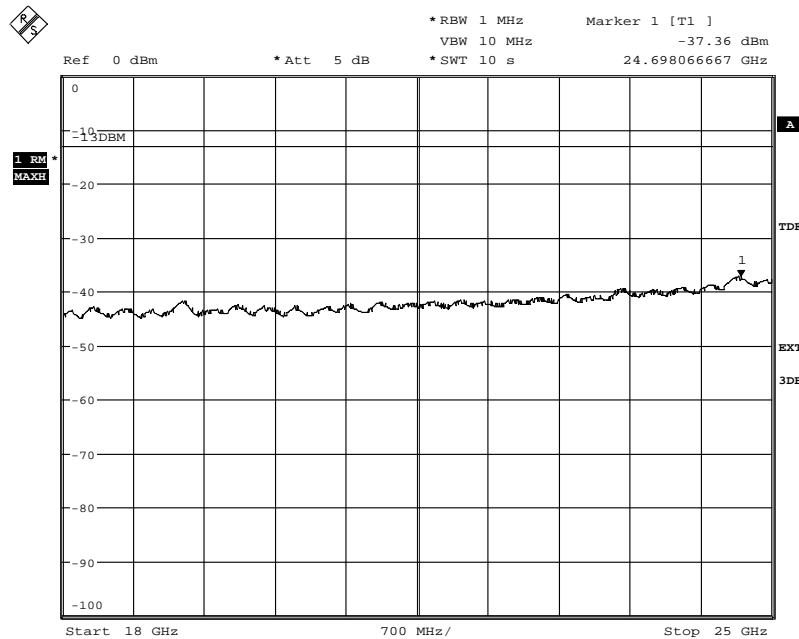

Date: 23.NOV.2012 08:18:07

Appendix 5

Diagram 14 a:

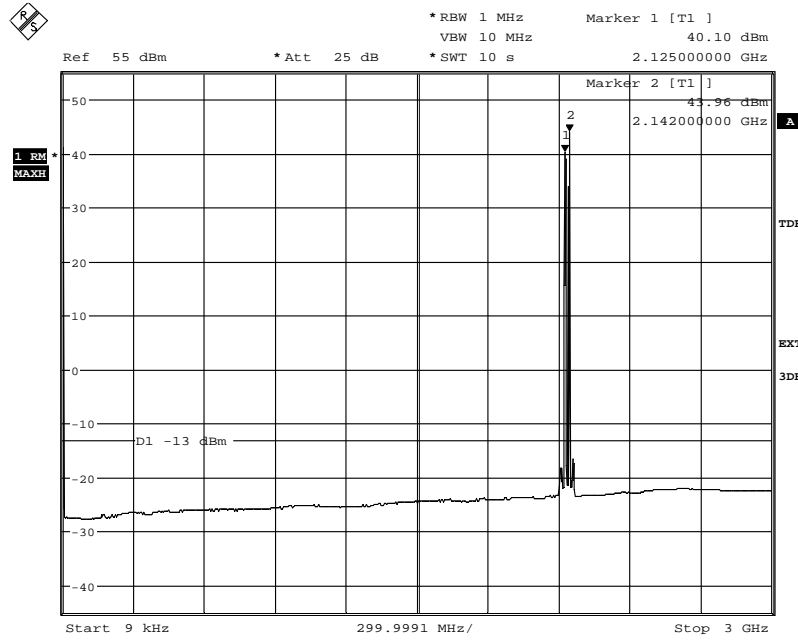

Date: 22.NOV.2012 12:16:45

Diagram 14 b:

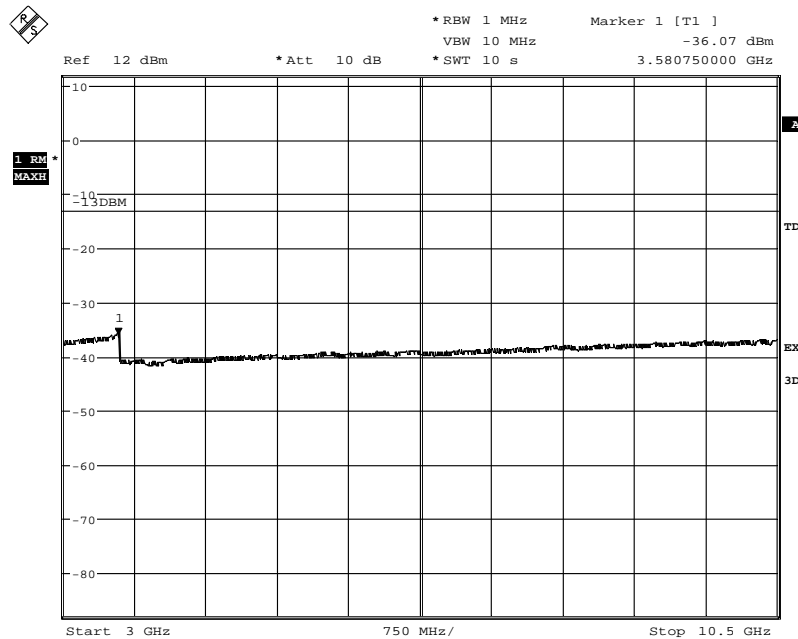

Date: 22.NOV.2012 12:20:34

Appendix 5

Diagram 14 c:

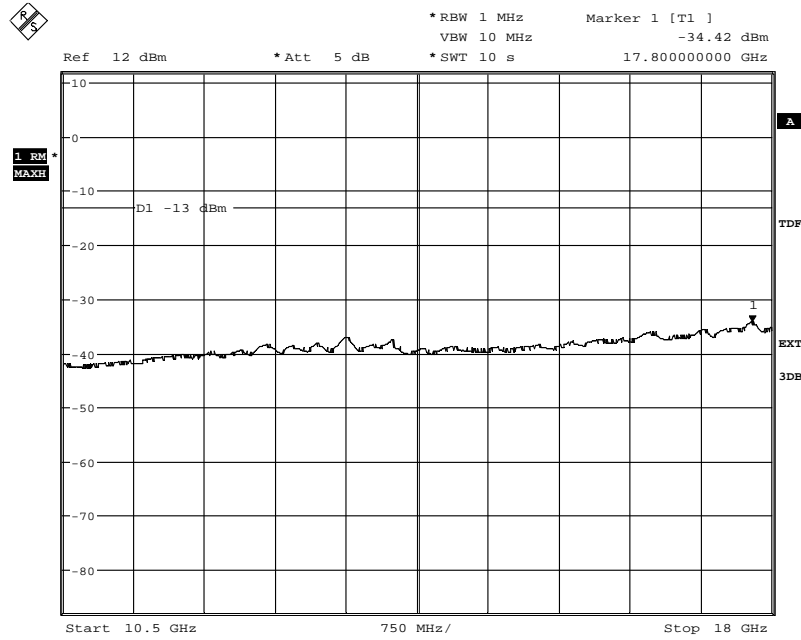

Date: 22.NOV.2012 12:24:11

Diagram 14 d:

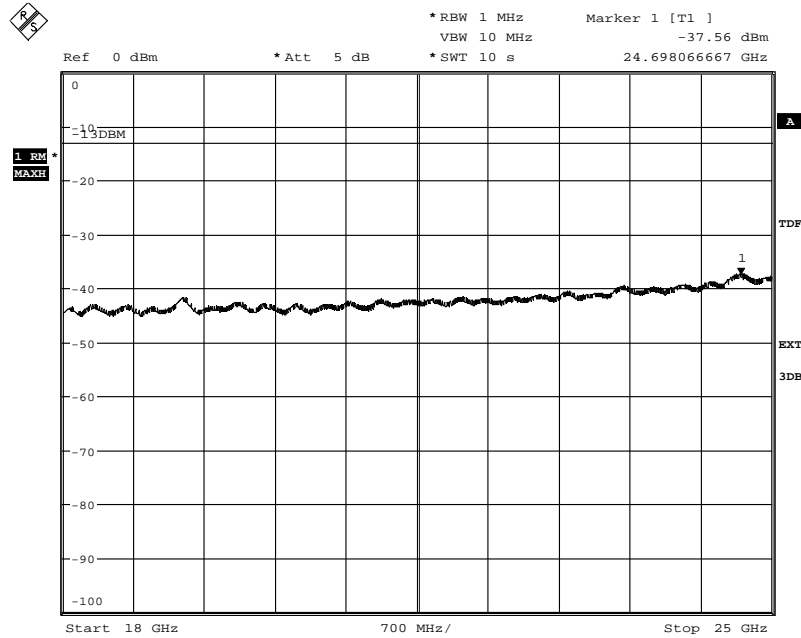

Date: 23.NOV.2012 08:20:18

Appendix 5

Diagram 15:

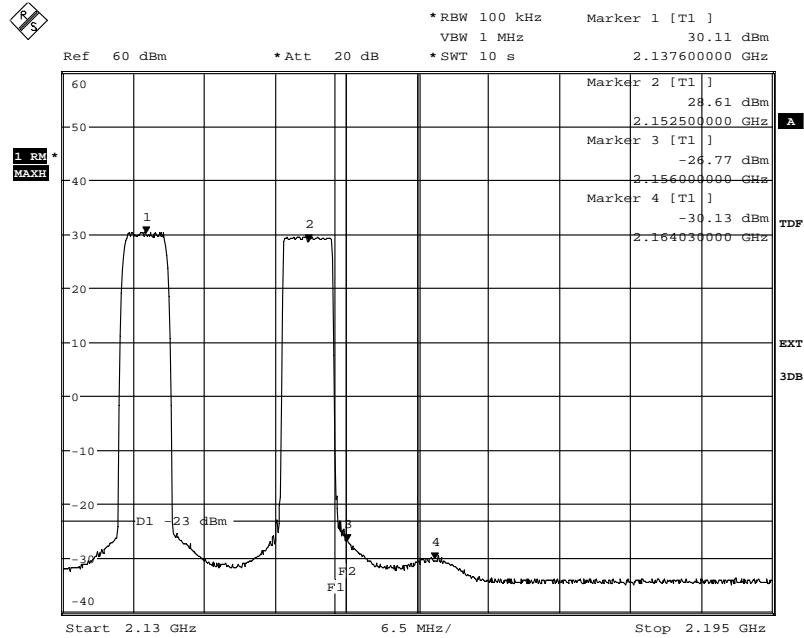

Date: 23.NOV.2012 09:10:16

Diagram 16:

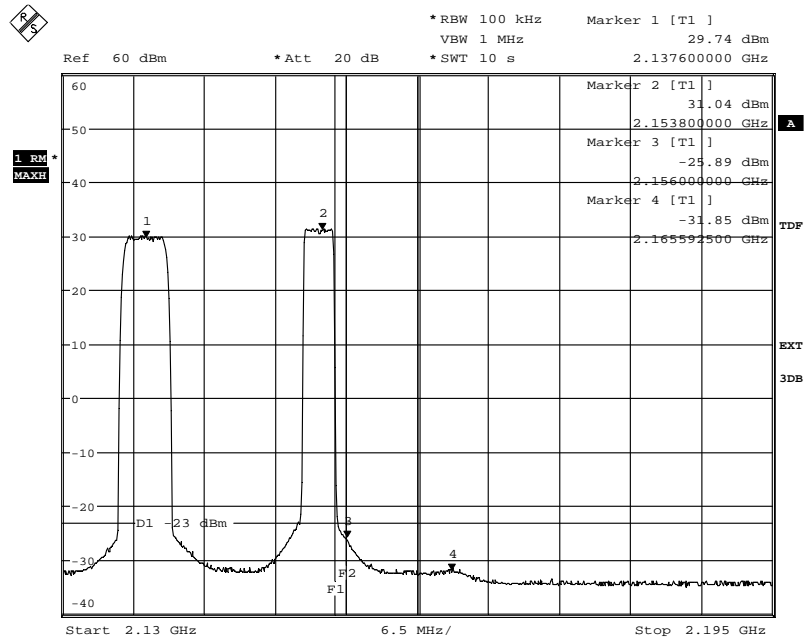

Date: 23.NOV.2012 09:08:11

Note: The center frequency of marker 2 should be corrected to 2153.5 MHz

Appendix 5

Diagram 17:

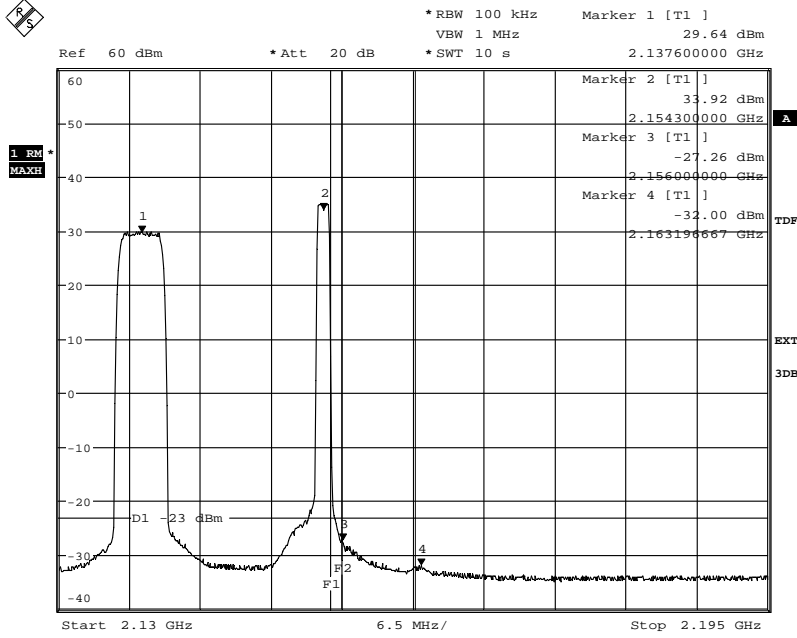

Date: 23.NOV.2012 09:05:25

## Appendix 5

### Remark

The emission at 9 kHz on the plots was not generated by the test object. A complementary measurement with a smaller RBW showed that it was related to the LO feed-through.

The highest internal frequency as declared by the client was 2.4576 GHz, thus the choice of the upper frequency boundary was set to  $10 \times 2.5 \text{ GHz} = 25 \text{ GHz}$  for emission measurements.

### Limits

§27.53(h) and RSS-139 6.5

Outside a licensee's frequency band(s) of operation the power of any emission shall be attenuated below the transmitter power (P) by at least  $43 + 10 \log (P)$  dB, resulting in a limit of -13 dBm per 1 MHz RBW.

Complies?	Yes
-----------	-----



## Appendix 6

### Field strength of spurious radiation measurements according to 47 CFR 27.53 (h) / IC RSS-139 6.5

Date	Temperature	Humidity
2012-10-26	22°C ± 3°C	31 % ± 5 %
2012-10-30	23°C ± 3°C	30 % ± 5 %
2012-11-09	23°C ± 3°C	29 % ± 5 %

#### Test set-up and procedure

The test sites are listed at FCC, Columbia with registration number: 93866. The test site complies with RSS-Gen, Industry Canada file no. 3482A-1.

The measurements were performed with both horizontal and vertical polarization of the antenna. The antenna distance was 3 m in the frequency range 30 MHz – 18 GHz and 1m in the frequency range 18 - 25 GHz.

In the frequency range 30 MHz - 25 GHz the measurement was performed in power with a RBW of 1 MHz. A propagation loss in free space was calculated. The used formula was

$$\gamma = 20 \log \left( \frac{4\pi D}{\lambda} \right), \gamma \text{ is the propagation loss and } D \text{ is the antenna distance.}$$

The measurement procedure was as the following:

1. The pre-measurement was first performed with peak detector. The EUT was measured in eight directions and with the antenna at three heights, 1.0 m, 1.5 m and 2.0 m.
2. Spurious radiation on frequencies closer than 20 dB to the limit in the pre-measurement is scanned 0-360 degrees and the antenna is scanned 1- 4 m for maximum response. The emission is then measured with the RMS detector and the RMS value is reported. Frequencies closer than 10 dB to the limit when measured with the RMS detector were measured with the substitution method according to the standard.

## Appendix 6

The test set-up during the spurious radiation measurements is shown in the pictures below:

MIMO:

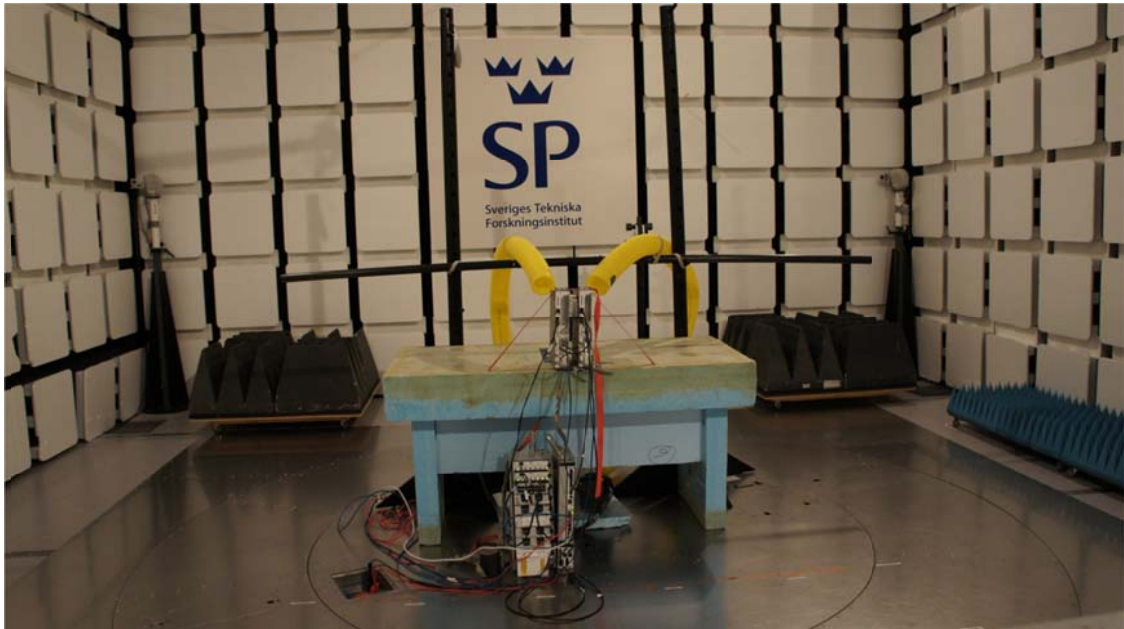

MSR:

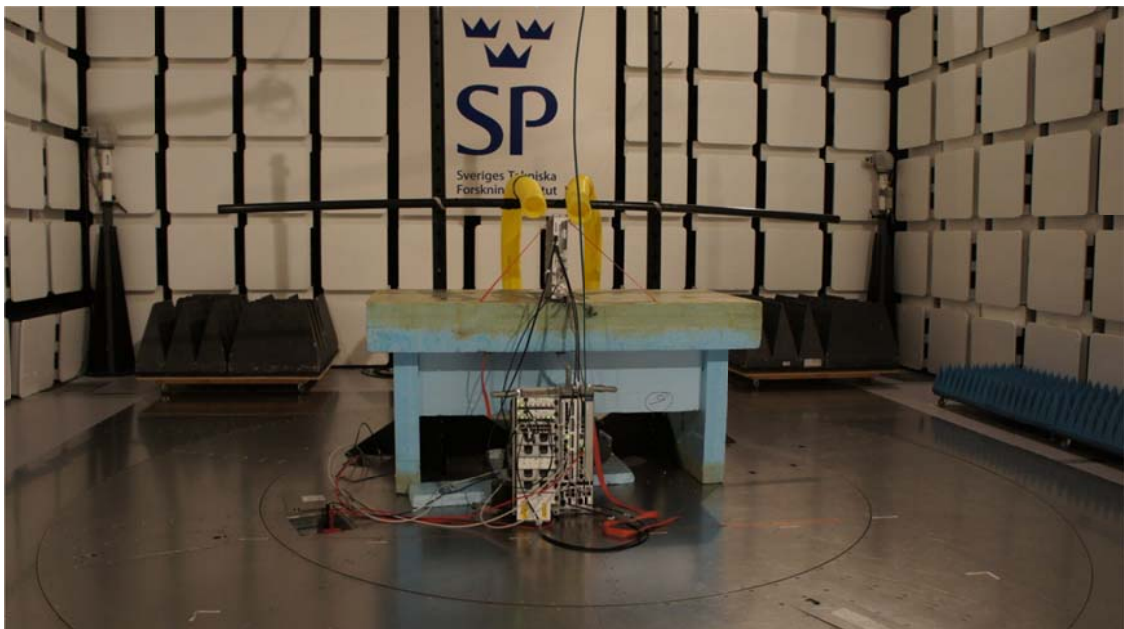

## Appendix 6

**Measurement equipment**

Measurement equipment	SP number
Semi anechoic chamber	503 881
R&S ESU 26	901 553
EMC 32 ver. 8.52.0	503 745
Chase Bilog Antenna CBL 6111A	502 181
EMCO Horn Antenna 3115	502 175
Flann STD Gain Horn Antenna 20240-20	503 674
High pass filter, RLC Electronics	503 739
Miteq, Low Noise Amplifier	503 285
µComp Nordic, Low Noise Amplifier	901 545
Temperature and humidity meter, Testo 625	504 188

**Tested configurations****LTE**

B, 1.4 MHz BW  
M, 1.4 MHz BW  
T, 1.4 MHz BW

**WCDMA**

T+(T-5)

**MSR, LTE+WCDMA**

Configuration 10

Appendix 6

**Results**, representing worst case

LTE, T, 1.4 MHz BW, Diagram 1: a-d

WCDMA, T+(T-5), Diagram 2: a-d

MSR Configuration 10, Diagram 3: a-d

Frequency (MHz)	Spurious emission level (dBm)	
	Vertical	Horizontal
30-25 000	All emission > 20 dB below limit	All emission > 20 dB below limit

**Measurement uncertainty:**

3.2 dB up to 18 GHz, 3.6 dB above 18 GHz

**Limits**

§27.53(h) and RSS-139 6.5

Outside a licensee's frequency band(s) of operation the power of any emission shall be attenuated below the transmitter power (P) by at least  $43 + 10 \log (P)$  dB, resulting in a limit of -13 dBm per 1 MHz RBW.

Complies?	Yes
-----------	-----

Appendix 6

Diagram 1a:

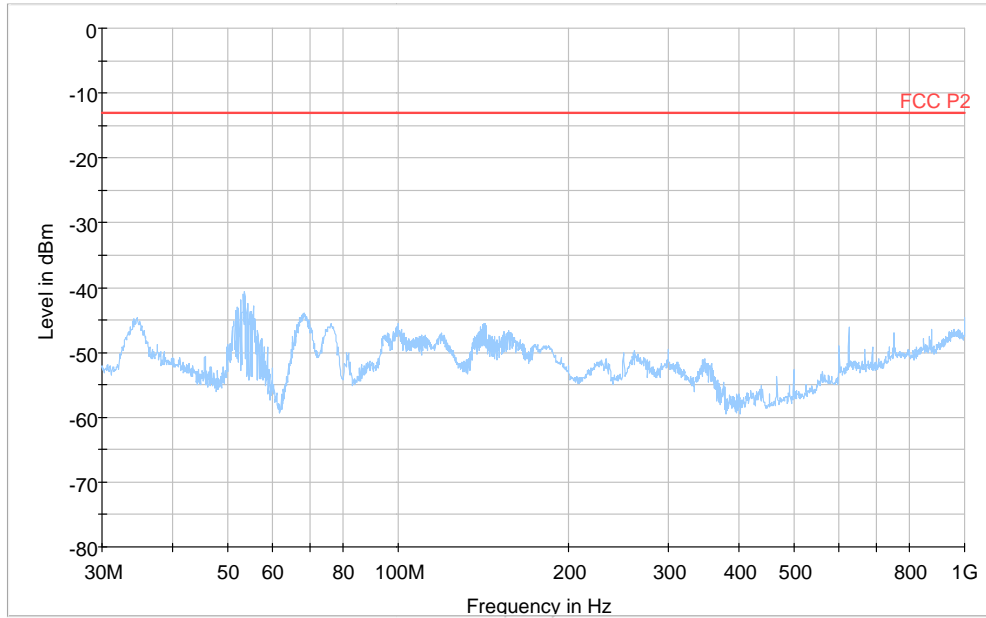
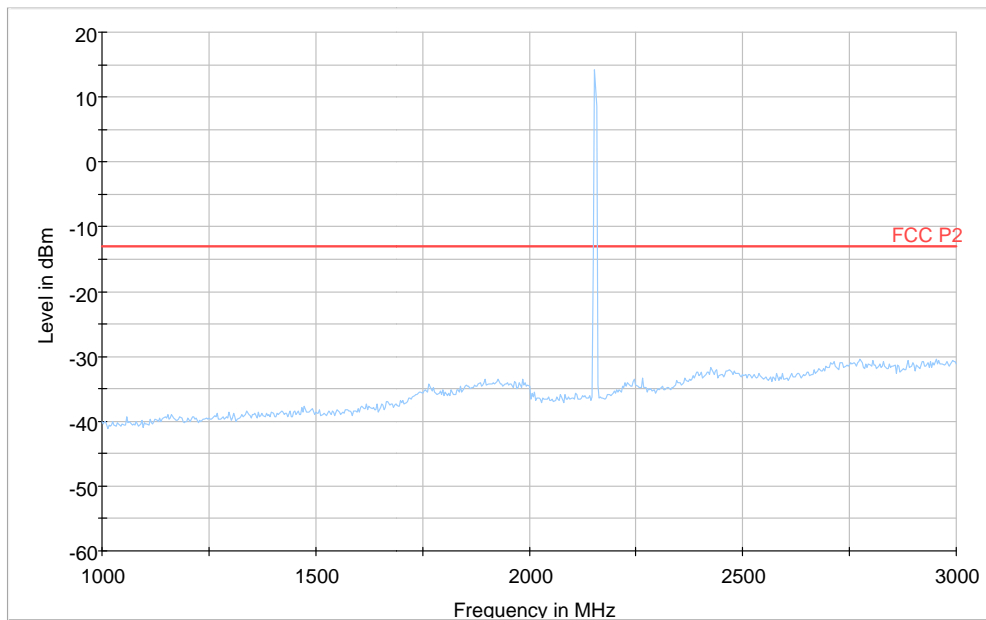

Diagram 1b:



Note: The emission at 2154.3 MHz is the carrier frequency and shall be ignored in the context.

Appendix 6

Diagram 1c:

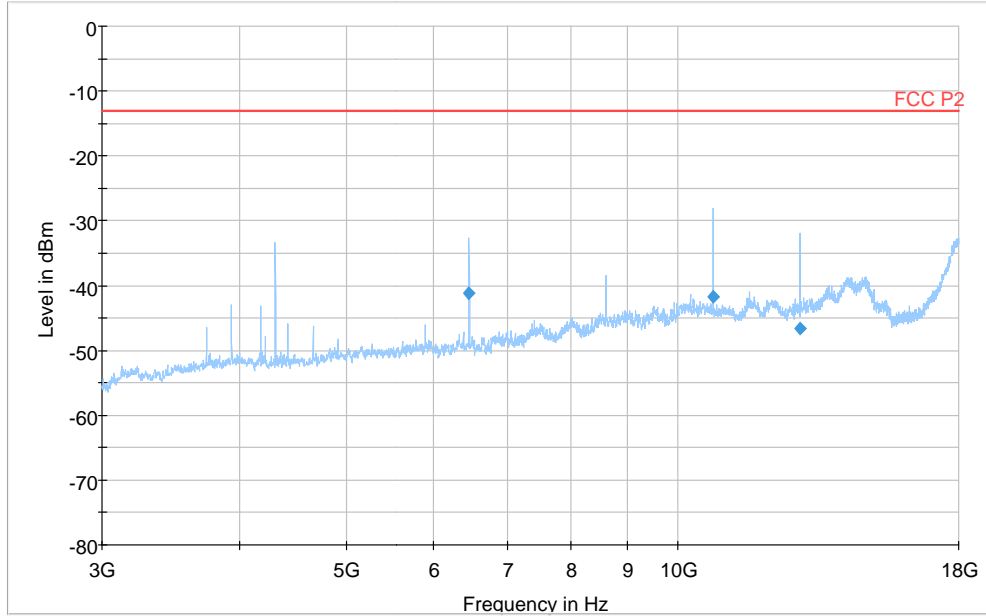
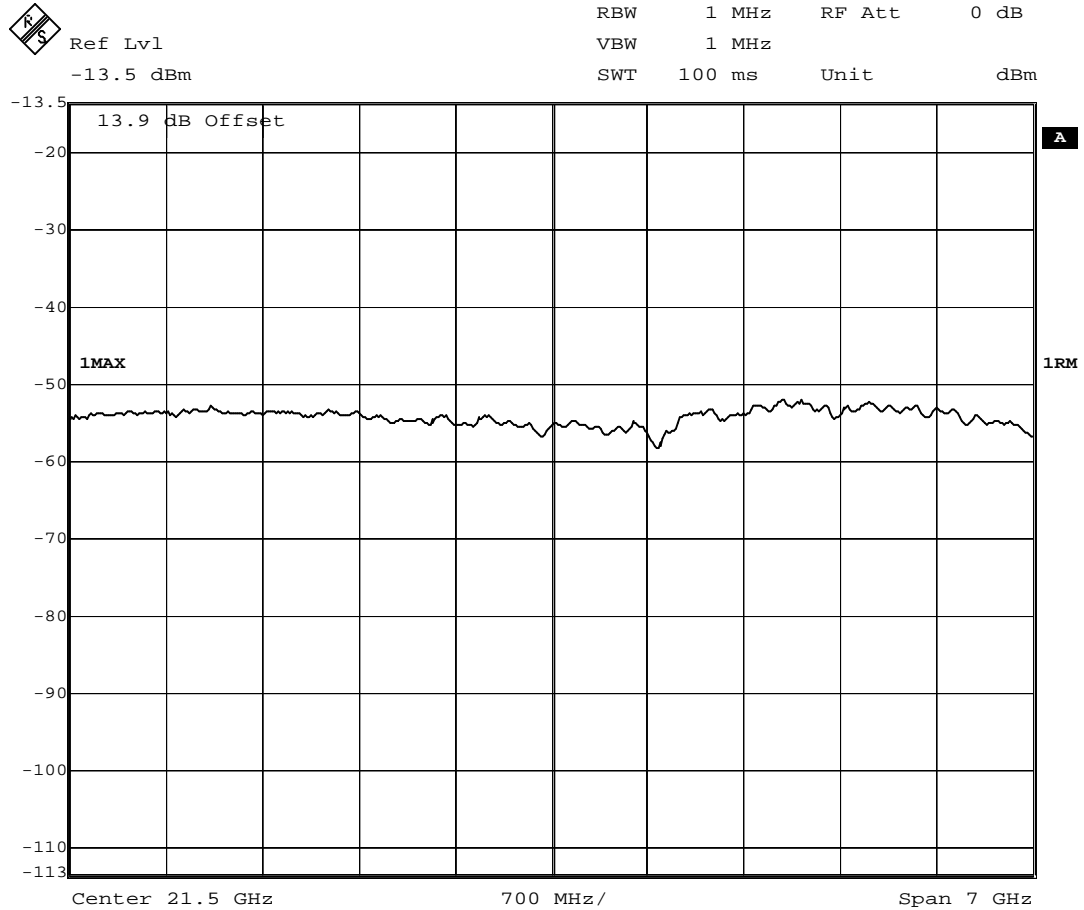

Diagram 1d:



Date: 25.OCT.2012 19:50:28

Appendix 6

Diagram 2a:

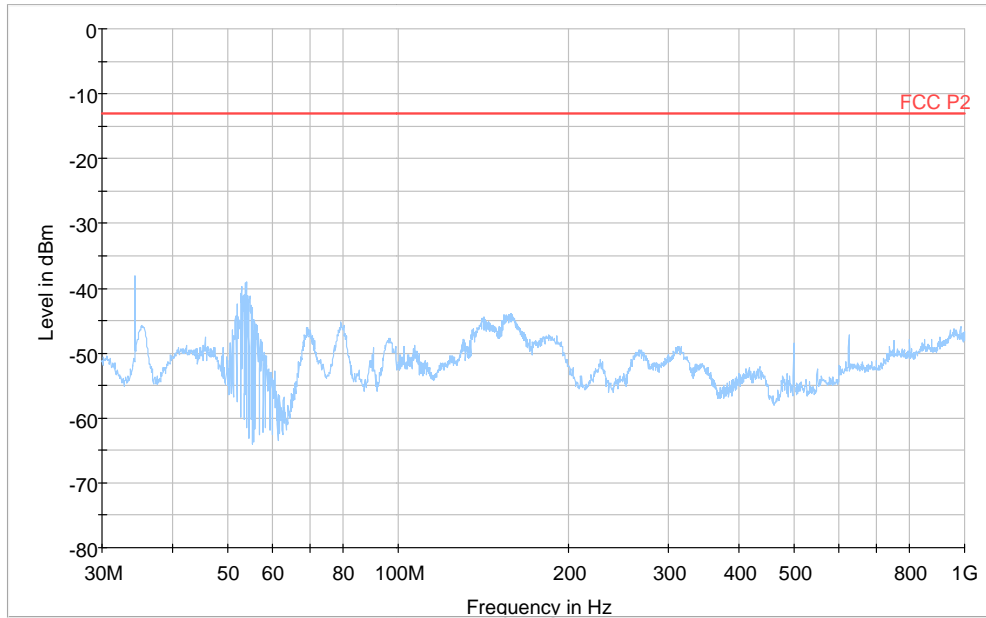
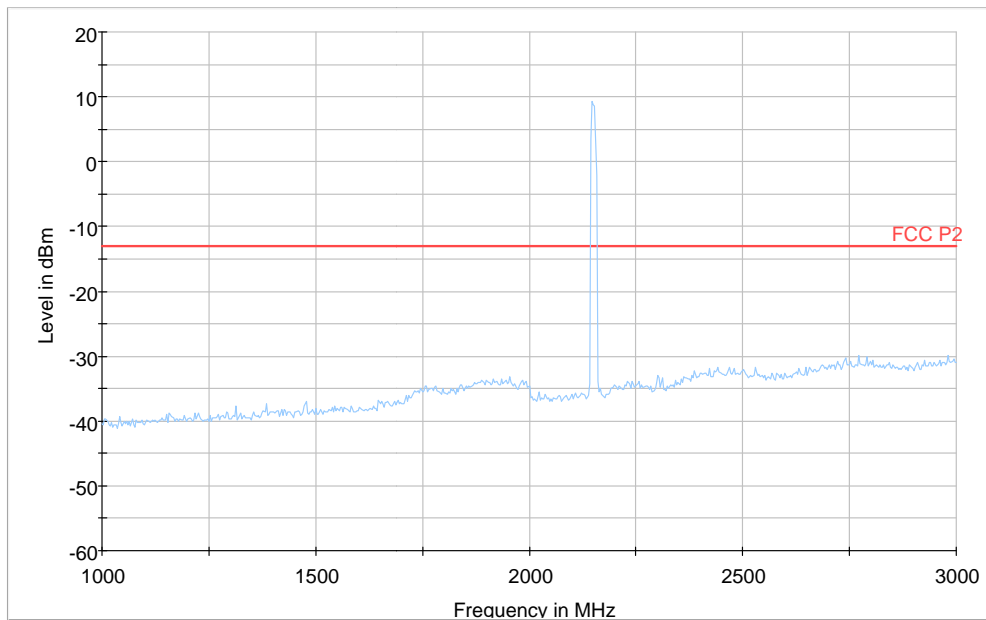

Diagram 2b:



Note: The emission at 2147.6 MHz and 2152.6 MHz are the carrier frequencies and shall be ignored in the context.

Appendix 6

Diagram 2c:

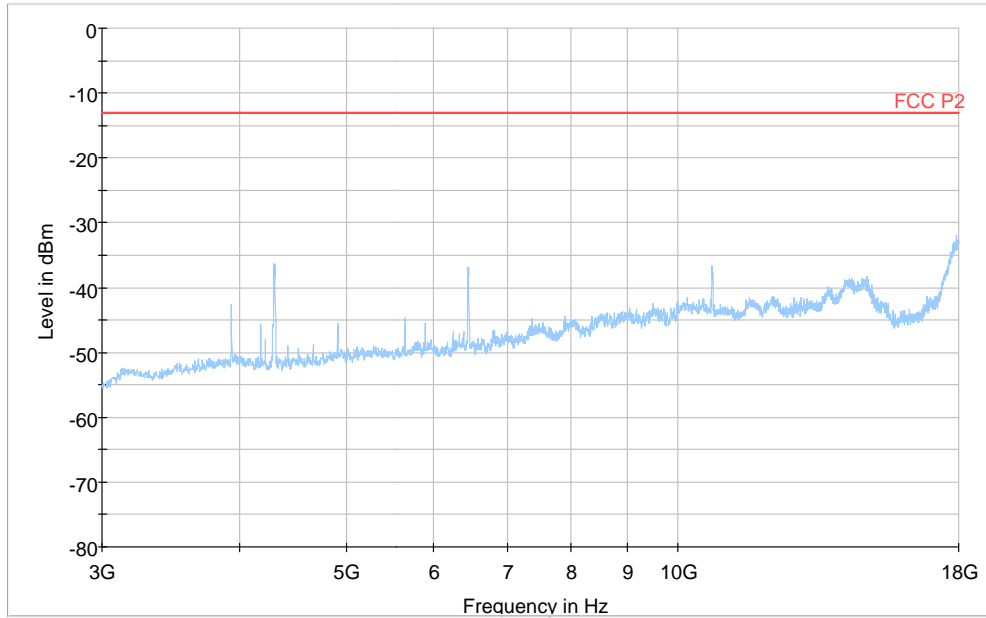
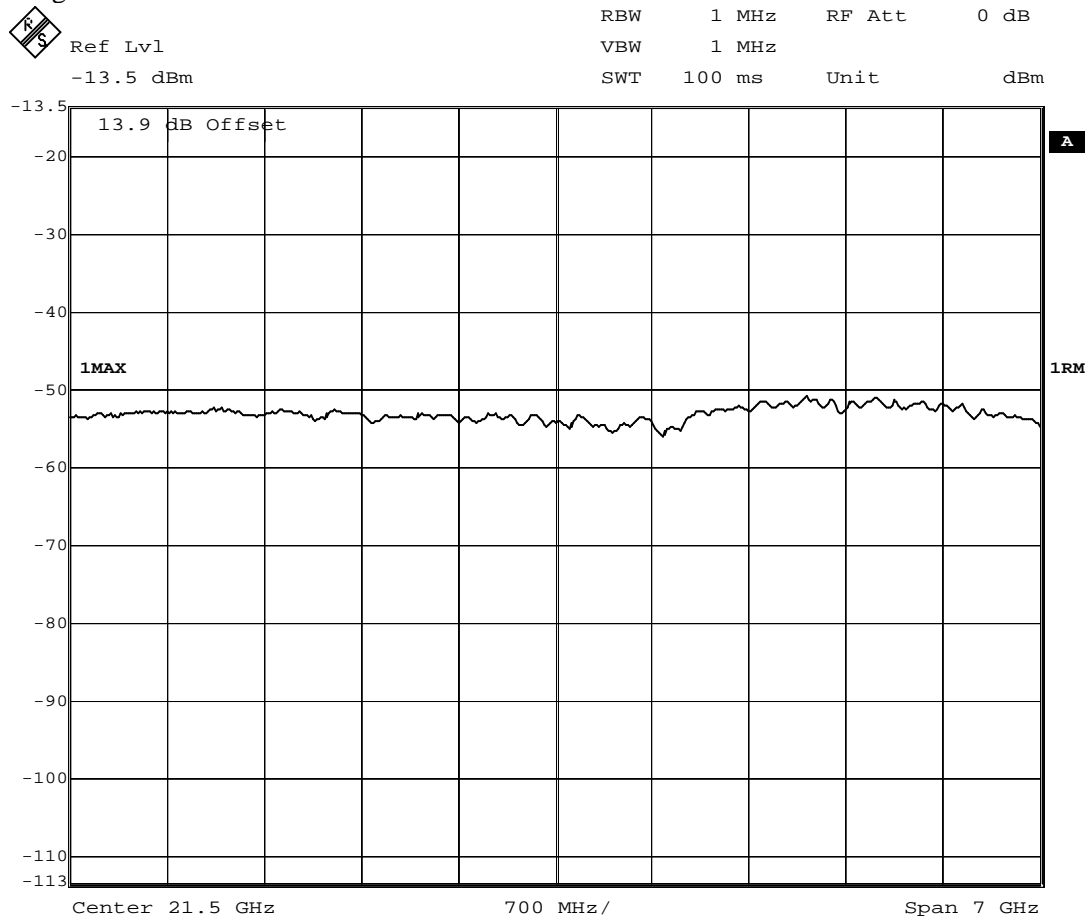

Diagram 2d:



Date: 30.OCT.2012 14:59:15



Appendix 6

Diagram 3a:

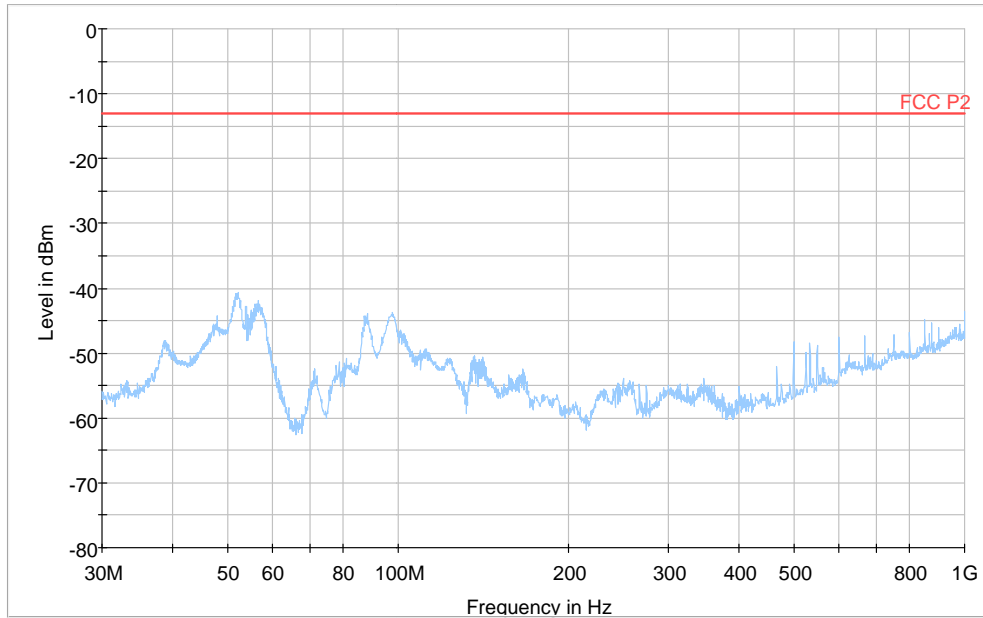
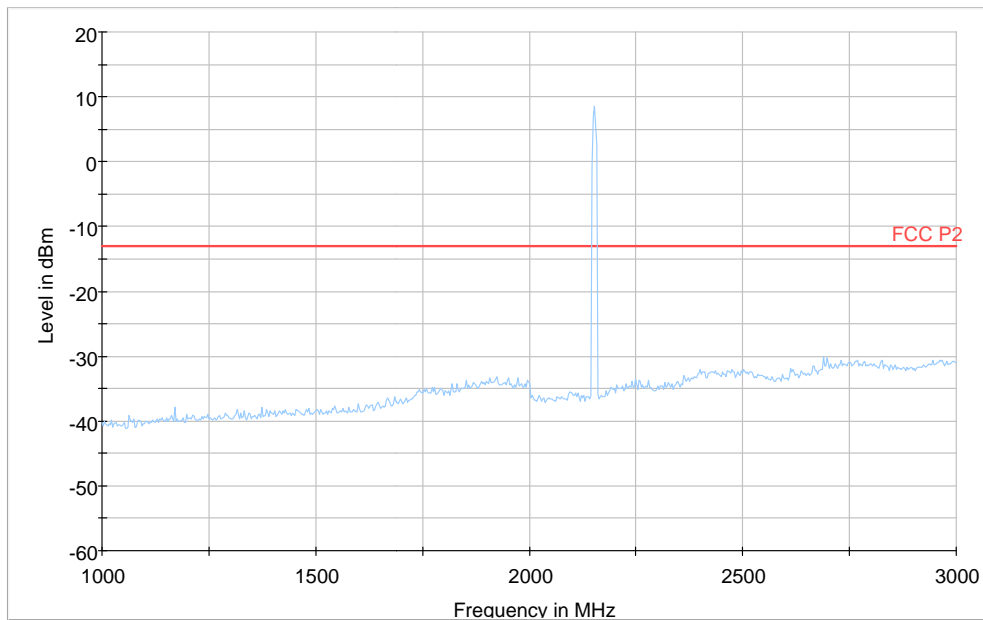

Diagram 3b:



Note: The emission between 2151 MHz and 2154.3 MHz are the carrier frequencies and shall be ignored in the context.

Appendix 6

Diagram 3c:

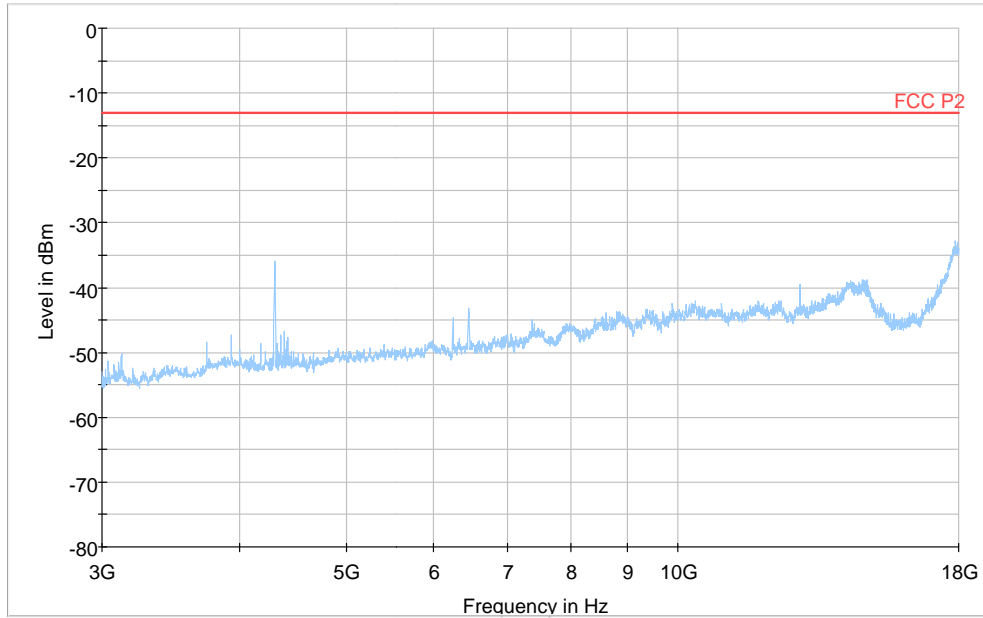
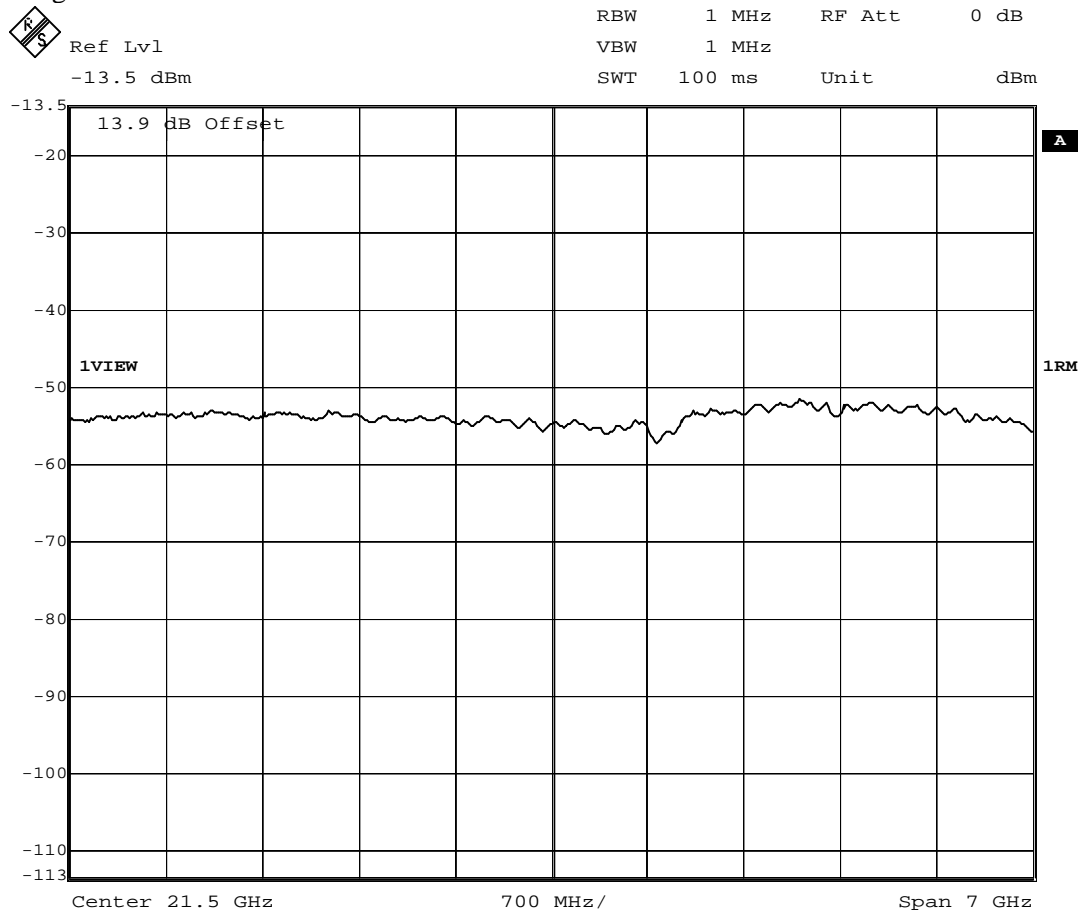

Diagram 3d:



Date: 8.NOV.2012 15:21:08

Appendix 7

External photos

Front side

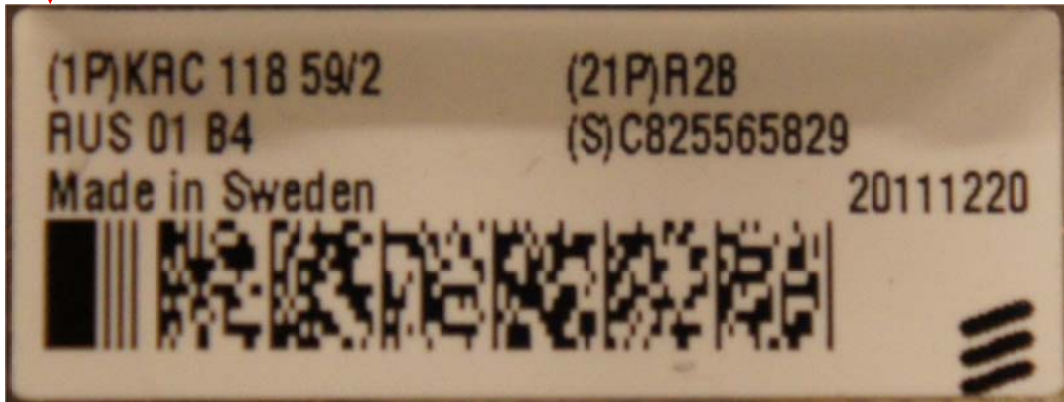

Appendix 7

Rear side

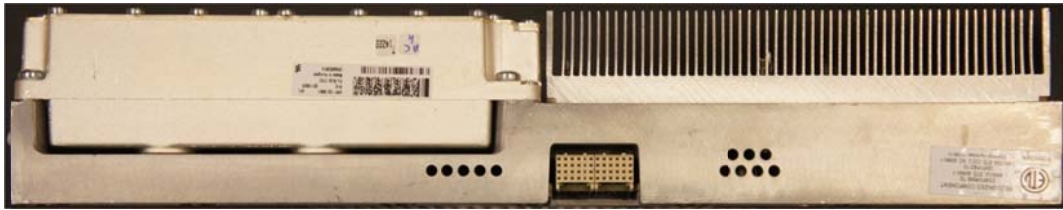

Left side

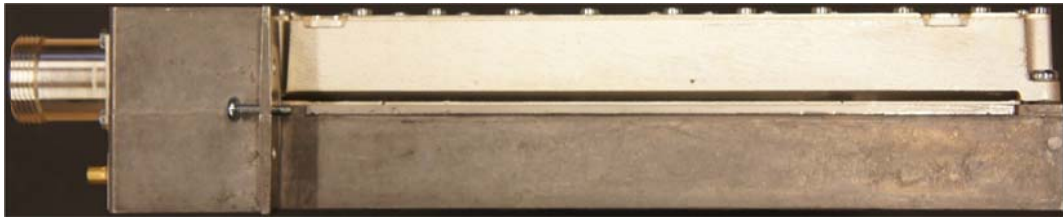

Right side



Appendix 7

Bottom side

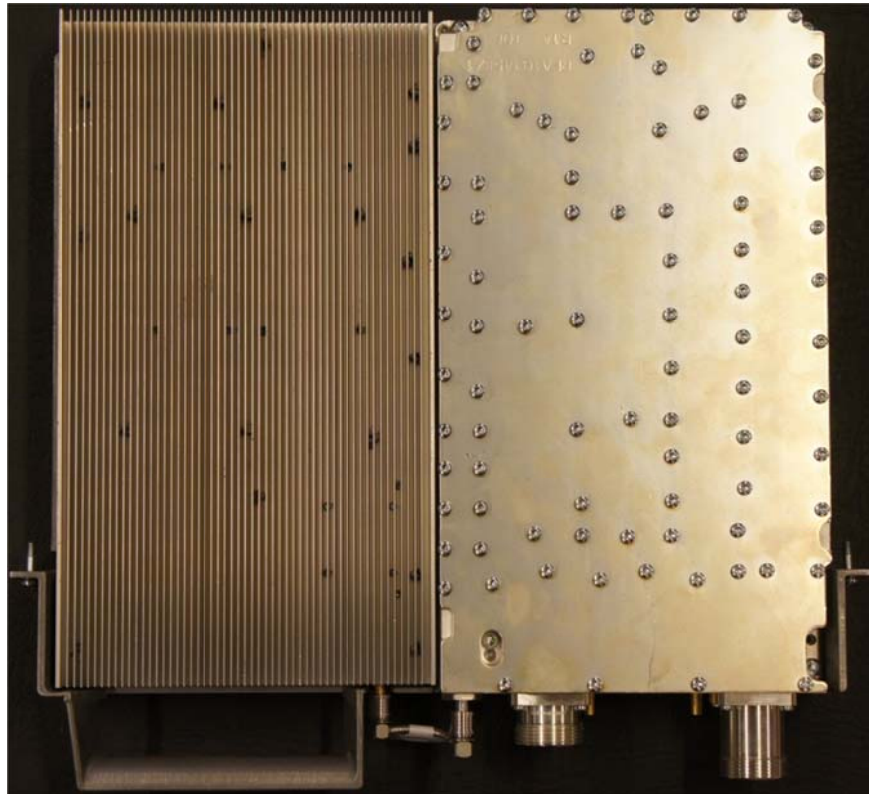

Top side

