

Prepared (also subject responsible if other) EWUTHFU		No. 3/0360-FCP 101 3765 Uen		
Approved EWU/PR/HD [Keith Goshia]	Checked	Date 2005-11-29	Rev B	Reference TA8AKRC11819-1

## FCC Part 24 Test Report - RU22 1900MHz

Prepared (also subject responsible if other) EWUTHFU		No. 3/0360-FCP 101 3765 Uen		
Approved EWU/PR/HD [Keith Goshia]	Checked	Date 2005-11-29	Rev B	Reference TA8AKRC11819-1

Sub-part 2.1033 (c):

**Equipment Identification**

FCC ID: TA8AKRC11819-1

**Date of Report**

**Tuesday, 11 October 2005**

Prepared (also subject responsible if other) EWUTHFU		No. 3/0360-FCP 101 3765 Uen		
Approved EWU/PR/HD [Keith Goshia]	Checked	Date 2005-11-29	Rev B	Reference TA8AKRC11819-1

The applicant has been cautioned as to the following:

#### 15.21 Information to User.

The user's manual or instruction manual for an intentional radiator shall caution the user that changes or modification not expressly approved by the party responsible for compliance could void the user's authority to operate the equipment.

#### 15.27 (a) Special Accessories.

Equipment marketed to a consumer must be capable of complying with the necessary regulations in the configuration in which the equipment is marketed. Where special accessories, such as shielded cables and/or special connectors are required to enable an unintentional or intentional radiator to comply with the emission limits in this part, the equipment must be marketed with, i.e. shipped and sold with, those special accessories. However, in lieu of shipping or packaging the special accessories with the unintentional or intentional radiator, the responsible party may employ other methods of ensuring that the special accessories are provided to the consumer, without additional charge.

Information detailing any alternative method used to supply the special accessories for a grant of equipment authorization or retained in the verification records, as appropriate. The party responsible for the equipment, as detailed in § 2.909 of this chapter, shall ensure that these special accessories are provided with the equipment. The instruction manual for such devices shall include appropriate instructions on the first page of text concerned with the installation of the device that these special accessories must be used with the device. It is the responsibility of the user to use the needed special accessories supplied with the equipment.

Prepared (also subject responsible if other) EWUTHFU		No. 3/0360-FCP 101 3765 Uen		
Approved EWU/PR/HD [Keith Goshia]	Checked	Date 2005-11-29	Rev B	Reference TA8AKRC11819-1

## Table of Contents

<u>Rule</u>	<u>Description</u>
2.1033	List of General Information Required
2.1046	RF Power Output
2.1049	Occupied Bandwidth
22.917	Emission Requirements
2.1051 22.917 (e)	Spurious Emissions at Antenna Terminals
2.1053	Field Strength of Spurious Radiation
2.1055	Frequency Stability - Temperature & Voltage Variation
2.202 (g)	Necessary Bandwidth and Emission Bandwidth
2.906	Testimonial & Statement of Certification
	Radio Frequency Radiation Exposure Limits
	Exhibits:
	Appendix:



Prepared (also subject responsible if other) EWUTHFU		No. 3/0360-FCP 101 3765 Uen		
Approved EWU/PR/HD [Keith Goshia]	Checked	Date 2005-11-29	Rev B	Reference TA8AKRC11819-1

2.1033(c)(8) Voltagages & Currents in all Elements in Final RF Stage,  
Including Final Transistor or Solid State Device:

Collector Current, ADC: 4X70A, 100A = per manual  
Collector Voltage, VDC: +24. -48 = per manual  
Supply Voltage, Vac 100-433 1Ø or 3Ø = per manual

**Open Exhibits**

- 2.1033 Cover Letter:  
Please see Attached Exhibit 1
- 2.1033 Cover Letter Confidentiality:  
Please see Attached Exhibit 2
- 2.1033 Cover Letter Temperature Range:  
Please see Attached Exhibit 3
- 2.1033 Cover Letter Filter Unit:  
Please see Attached Exhibit 4
- 2.1033 External Photo's:  
Please see Attached Exhibits 5
- 2.1033 Photo FCC ID:  
Please see Attached Exhibit 6
- 2.1033 Tune-Up Procedure:  
Please see Attached Exhibit 7
- ~~2.1033 FCC Form 731 Including Fee Processing Form:  
Please see Attached Exhibit 8~~
- 2.1033 Test Report:  
Please see Attached Exhibit 9

Prepared (also subject responsible if other) EWUTHFU		No. 3/0360-FCP 101 3765 Uen		
Approved EWU/PR/HD [Keith Goshia]	Checked	Date 2005-11-29	Rev B	Reference TA8AKRC11819-1

**Confidential Exhibits**

- 2.1033 Internal Photo's:  
Please see Attached Exhibit 10
- 2.1033 System Block Diagram:  
Please see Attached Exhibit 11
- 2.1033 Schematics:  
Please see Attached Exhibit 12
- 2.1033 Technical Description:  
Please see Attached Exhibit 13
- 2.1033 Installation Instruction:  
Please see Attached Exhibit 14
- 2.1033 Parts List:  
Please see Attached Exhibit 15
- 2.1033 Technical Circuit Description:  
Please see Attached Exhibit 16

Prepared (also subject responsible if other) EWUTHFU		No. 3/0360-FCP 101 3765 Uen		
Approved EWU/PR/HD [Keith Goshia]	Checked	Date 2005-11-29	Rev B	Reference TA8AKRC11819-1

2.1033(c)(14)      **Test Report:**

Test Report Follows



Prepared (also subject responsible if other) EWUTHFU		No. 3/0360-FCP 101 3765 Uen		
Approved EWU/PR/HD [Keith Goshia]	Checked	Date 2005-11-29	Rev B	Reference TA8AKRC11819-1

Sub-part  
2.1033 (c): Test and Measurement Data

All tests and measurement data shown were performed in accordance with FCC Rules and Regulations, Volume II; Part 2, Sub-part J, Sections 2.1046, 2.1049, 2.1051, 2.1053, 2.1055 and the following individual Parts:

<u>21</u>	Domestic Public Radio Services	—
<u>24</u>	Personal Communications Services	<u>X</u>
<u>22E</u>	Broadband PCS	—
22.901	Special Provisions for Alternative Cellular Technologies and Auxiliary Services	—
<u>23</u>	International Fixed Public Radio Communications Service	—
<u>74</u>	Experimental, Auxiliary & Special Broadcast and Other Program Distribution Services	—
<u>74H</u>	Low Power Auxiliary Stations	—
<u>80</u>	Stations in the Maritime Service	—
<u>80.209 (5)(l)</u>	Transmitter Frequency Tolerances, 156–162 MHz, Coast Stations	—
<u>80K</u>	Private Coast Stations & Marine Utility Stations	—
<u>80S</u>	Compulsory R/T Installations for Small Passenger Boats	—
<u>80T</u>	Radio Telegraph Installation Required for Vessels on the Great Lakes	—
<u>80U</u>	Radio Telegraph Installation Required by the Bridge-to-Bridge Act	—
<u>87</u>	Aviation Services	—
<u>90</u>	Private Land Mobile Radio Services	—
<u>94</u>	Private Operational–Fixed microwave Services	—

Prepared (also subject responsible if other) EWUTHFU		No. 3/0360-FCP 101 3765 Uen		
Approved EWU/PR/HD [Keith Goshia]	Checked	Date 2005-11-29	Rev B	Reference TA8AKRC11819-1

Prepared (also subject responsible if other) EWUTHFU		No. 3/0360-FCP 101 3765 Uen		
Approved EWU/PR/HD [Keith Goshia]	Checked	Date 2005-11-29	Rev B	Reference TA8AKRC11819-1

### General Information

1. Spurious radiation was measured at three (3) meters.
  
2. The normal modes of modulation are:
  - (a) Voice \_\_\_\_\_
  - (b) Wideband Data \_\_\_\_\_
  - (c) SAT \_\_\_\_\_
  - (d) ST \_\_\_\_\_
  - (e) SAT + Voice \_\_\_\_\_
  - (f) SAT + DTMF \_\_\_\_\_
  - (g) 16QAM or QPSK WCDMA  X
  - (h) Pi/4 DQPSK \_\_\_\_\_
  - (i) NAMPS Voice \_\_\_\_\_
  - (j) NAMPS DSAT \_\_\_\_\_
  - (k) NAMPS ST \_\_\_\_\_

Prepared (also subject responsible if other) EWUTHFU		No. 3/0360-FCP 101 3765 Uen		
Approved EWU/PR/HD [Keith Goshia]	Checked	Date 2005-11-29	Rev B	Reference TA8AKRC11819-1

**Standard Test Conditions  
and  
Engineering Practices**

Except as noted herein, the following conditions and procedures were observed during the testing:

Room Temperature	= 25 ± 5° C
Room Humidity	= 20–50%
Supply Voltage	+24, VDC - 48VDC, 110-433VAC

Prior to testing, the EUT was tuned up in accordance with the manufacturer's alignment procedures. All external gain controls were maintained at the position of maximum and/or optimum gain throughout the testing.

Measurement results, unless otherwise noted, are worst-case measurements.

Prepared (also subject responsible if other) EWUTHFU		No. 3/0360-FCP 101 3765 Uen		
Approved EWU/PR/HD [Keith Goshia]	Checked	Date 2005-11-29	Rev B	Reference TA8AKRC11819-1

Name of Test: RF Power Output & Occupied Bandwidth

Paragraph: 47 CFR 2.1046 & 2.1049

Guide: EIA Standard RS 152B, Paragraph 3.3

Test Condition: Standard Temperature & Humidity

Test Equipment: As per Attached Appendix J

Measurement Procedures

1. The EUT was connected to a directional coupler and a resistive coaxial attenuator of normal load impedance, and the modulated output power was measured by means of an RF power meter.
2. Measurement accuracy is  $\pm 3\%$ .

Measurement Results

Nominal, MHz	Channel	Band	RF Power Output, Watts	
			Low Power	High Power
1932.5	412		5.0	40.0
1987.5	687		5.0	40.0

Prepared (also subject responsible if other) <b>EWUTHFU</b>		No. 3/0360-FCP 101 3765 Uen		
Approved EWU/PR/HD [Keith Goshia]	Checked	Date 2005-11-29	Rev B	Reference TA8AKRC11819-1

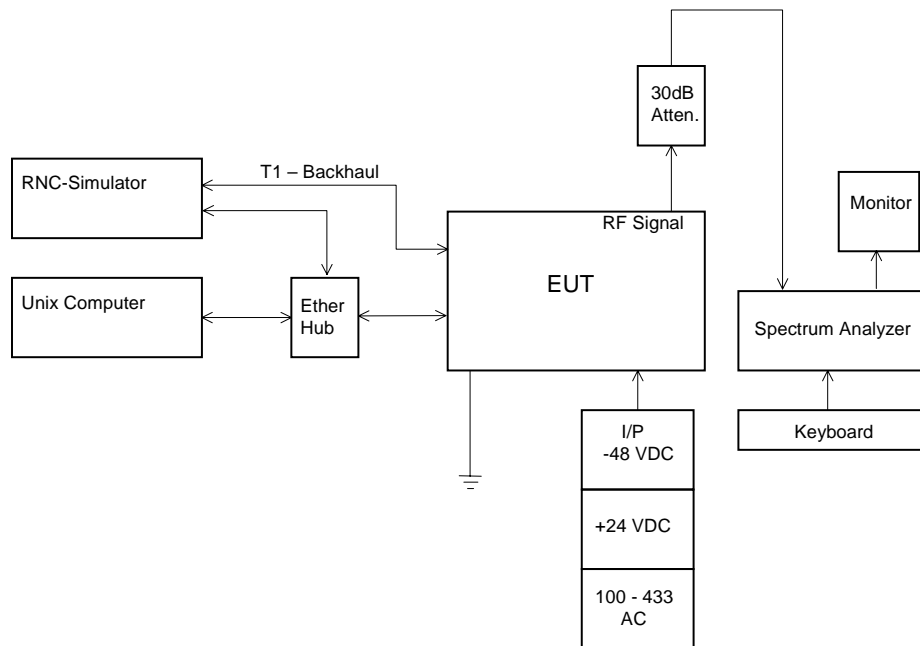

Prepared (also subject responsible if other) <b>EWUTHFU</b>		No. 3/0360-FCP 101 3765 Uen		
Approved EWU/PR/HD [Keith Goshia]	Checked	Date 2005-11-29	Rev B	Reference TA8AKRC11819-1

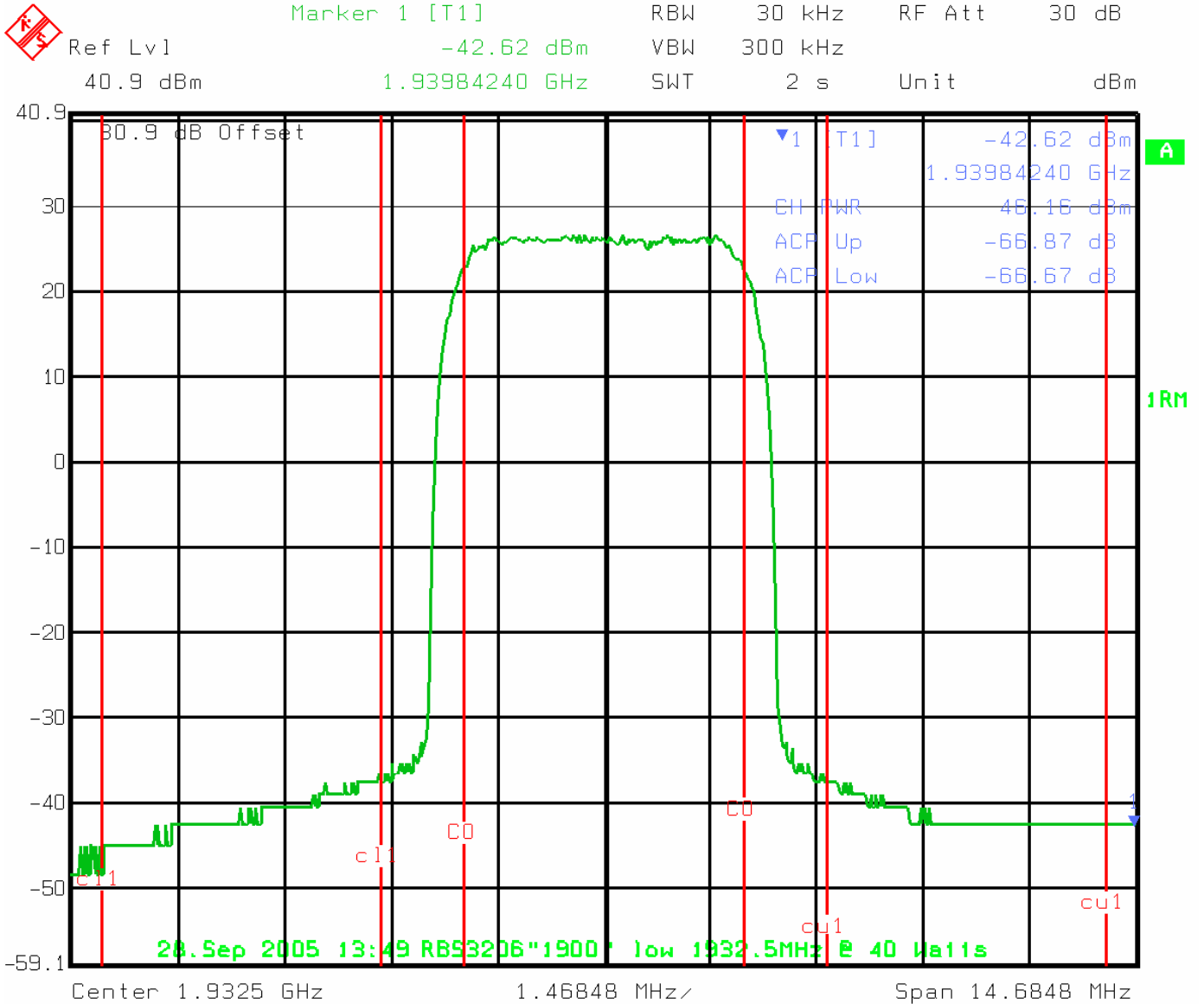

Date: 28.SEP.2005 13:49:17

Prepared (also subject responsible if other) <b>EWUTHFU</b>		No. 3/0360-FCP 101 3765 Uen		
Approved EWU/PR/HD [Keith Goshia]	Checked	Date 2005-11-29	Rev B	Reference TA8AKRC11819-1

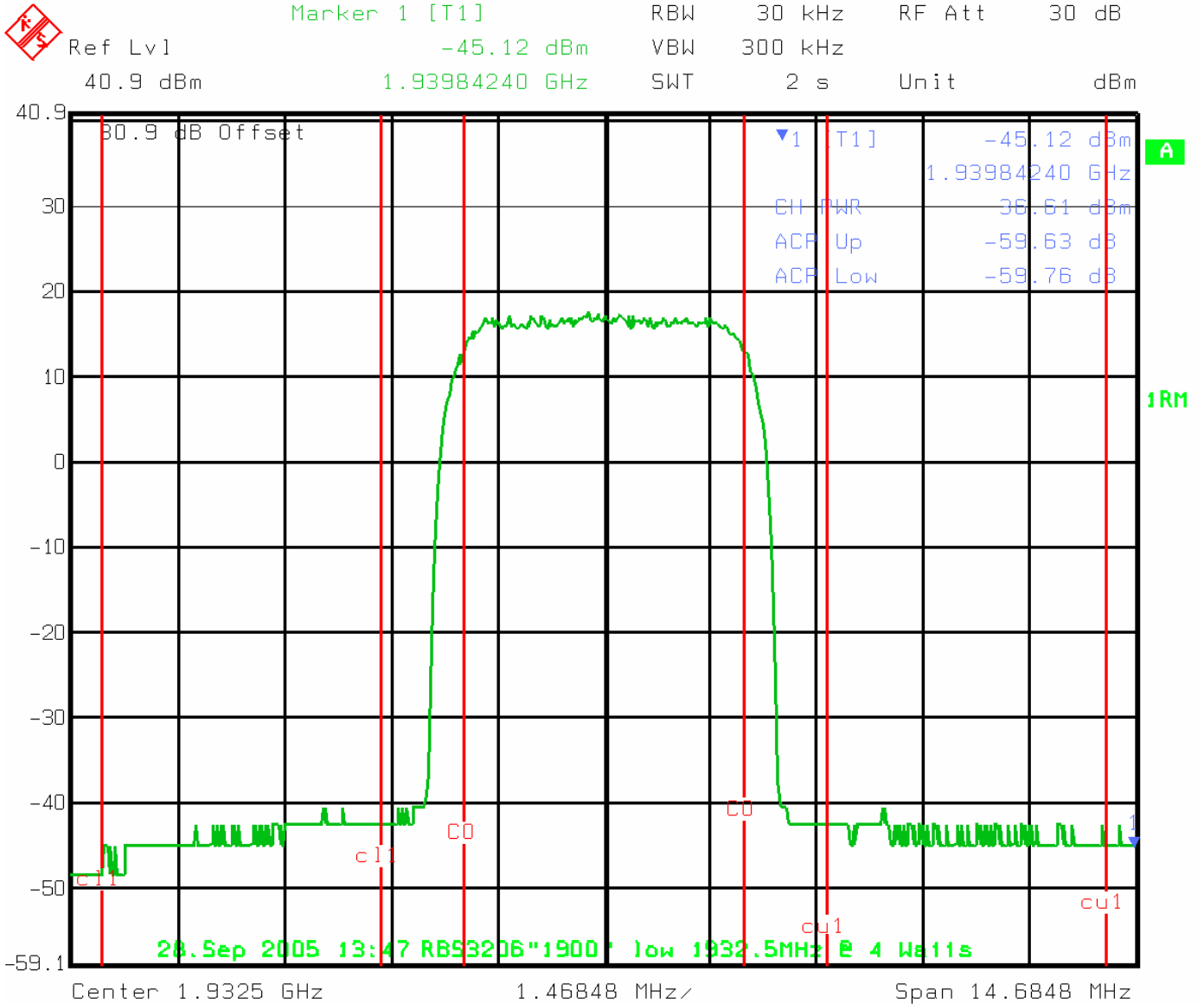

Date: 28.SEP.2005 13:47:33



Prepared (also subject responsible if other) EWUTHFU		No. 3/0360-FCP 101 3765 Uen		
Approved EWU/PR/HD [Keith Goshia]	Checked	Date 2005-11-29	Rev B	Reference TA8AKRC11819-1

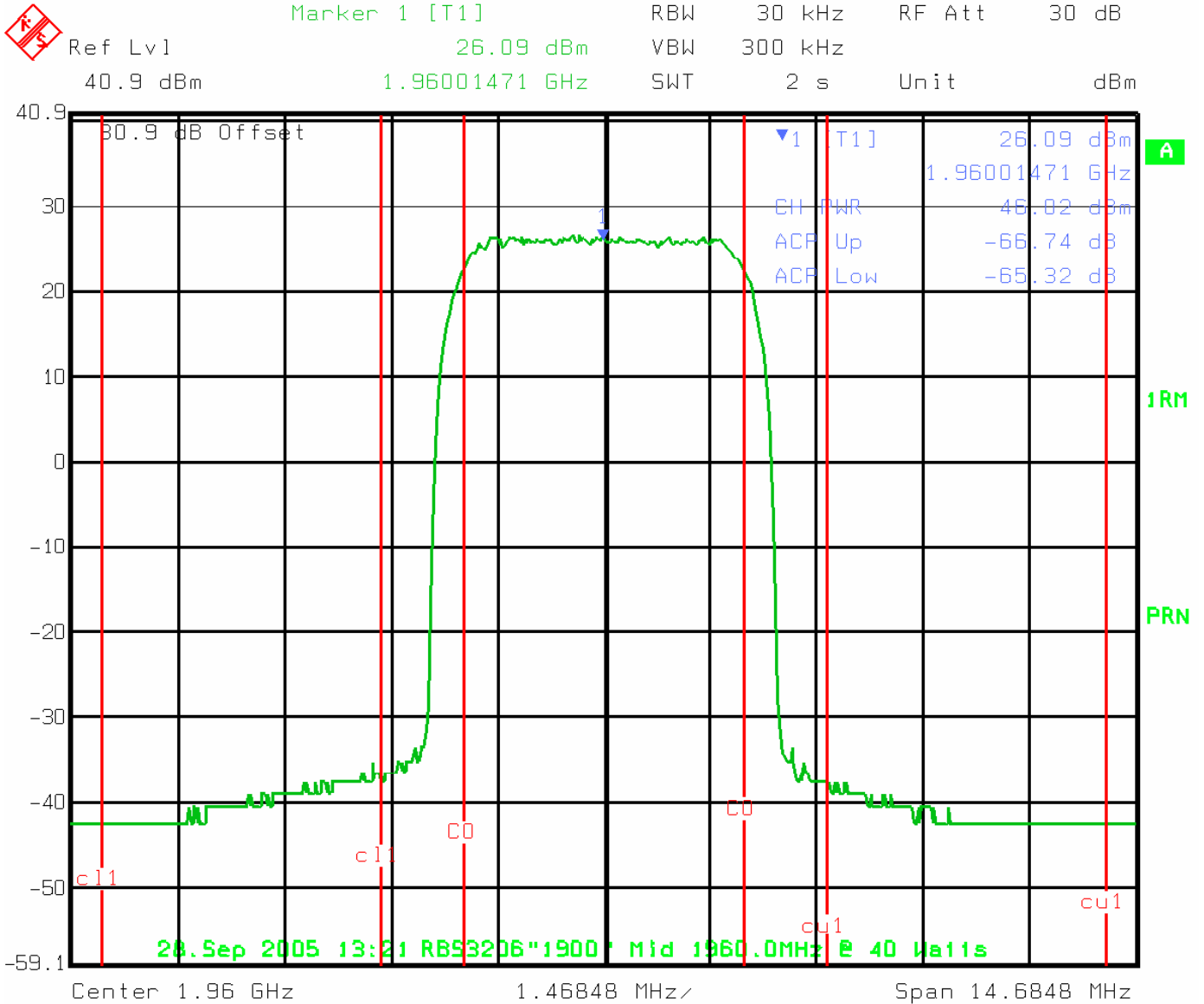

Date: 28.SEP.2005 13:21:40

Prepared (also subject responsible if other) EWUTHFU		No. 3/0360-FCP 101 3765 Uen		
Approved EWU/PR/HD [Keith Goshia]	Checked	Date 2005-11-29	Rev B	Reference TA8AKRC11819-1

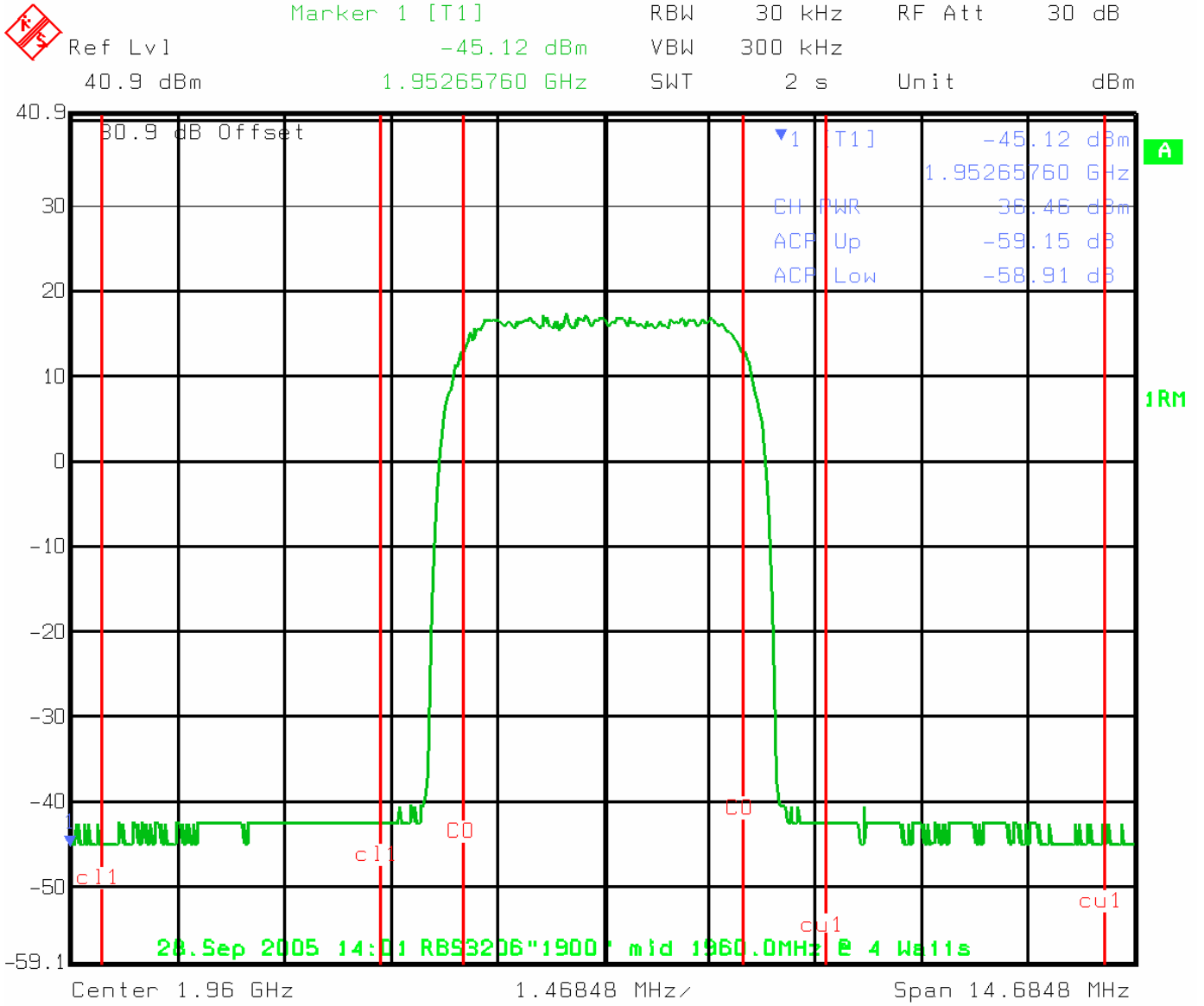

Date: 28.SEP.2005 14:02:03

Prepared (also subject responsible if other) EWUTHFU		No. 3/0360-FCP 101 3765 Uen		
Approved EWU/PR/HD [Keith Goshia]	Checked	Date 2005-11-29	Rev B	Reference TA8AKRC11819-1

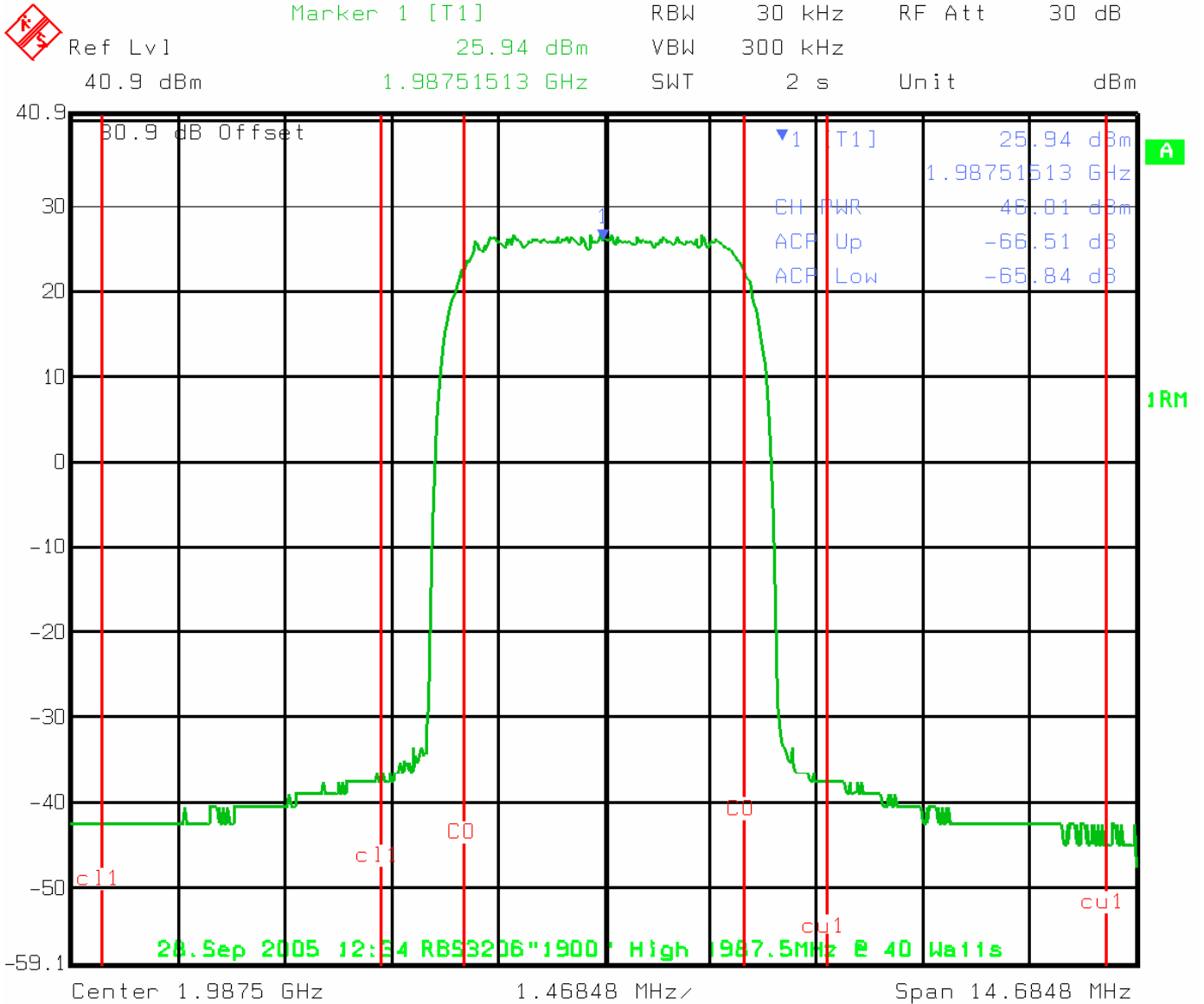

Date: 28.SEP.2005 12:34:13

Prepared (also subject responsible if other) EWUTHFU		No. 3/0360-FCP 101 3765 Uen		
Approved EWU/PR/HD [Keith Goshia]	Checked	Date 2005-11-29	Rev B	Reference TA8AKRC11819-1

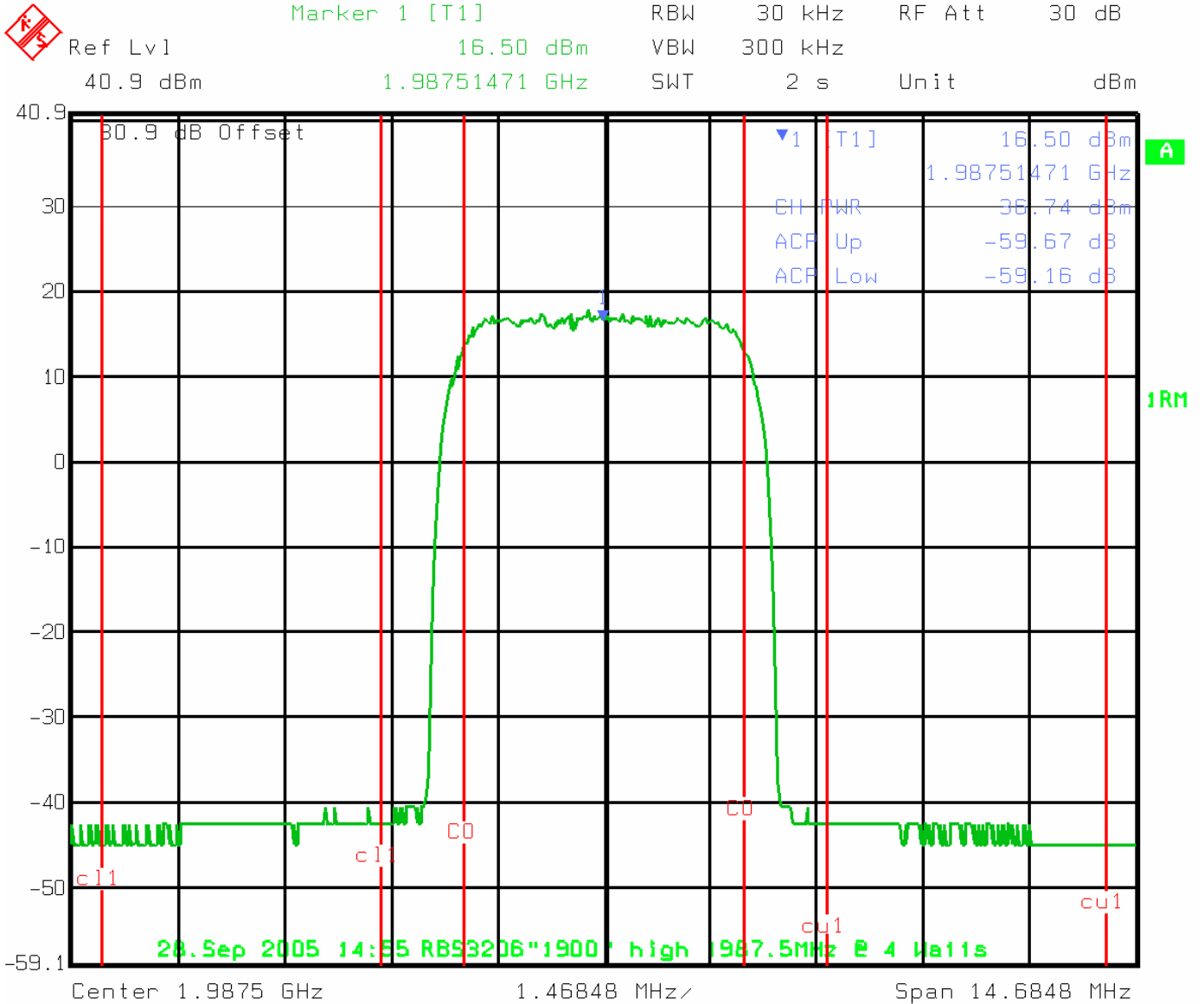

Date: 28.SEP.2005 14:55:46

Prepared (also subject responsible if other) EWUTHFU		No. 3/0360-FCP 101 3765 Uen		
Approved EWU/PR/HD [Keith Goshia]	Checked	Date 2005-11-29	Rev B	Reference TA8AKRC11819-1

Name of Test: Spurious Emissions at Antenna Terminals

Paragraph: 47 CFR 2.1051, 22.917(b)

Guide: EIA Standard RS 152B, Paragraph 17

Test Condition: Standard Temperature & Humidity

Test Equipment: As per Attached Appendix J

#### Measurement Procedures

1. The EUT was connected, through a directional coupler, a 30 dB coaxial attenuator then to a Rohde & Schwarz Spectrum Analyzer.
2. Measurements were made over the range from 1GHz to 20 GHz for the worst case modulation at the highest RF power settings.
3. All other emissions were 20 dB or more below the limit.
4. Spectrum analyzer bandwidth was set to section 22.917 (h)(1) & (2) as applicable.
5. Measurement Results: **All emissions are 30dB below and more.**

Prepared (also subject responsible if other) EWUTHFU		No. 3/0360-FCP 101 3765 Uen		
Approved EWU/PR/HD [Keith Goshia]	Checked	Date 2005-11-29	Rev B	Reference TA8AKRC11819-1

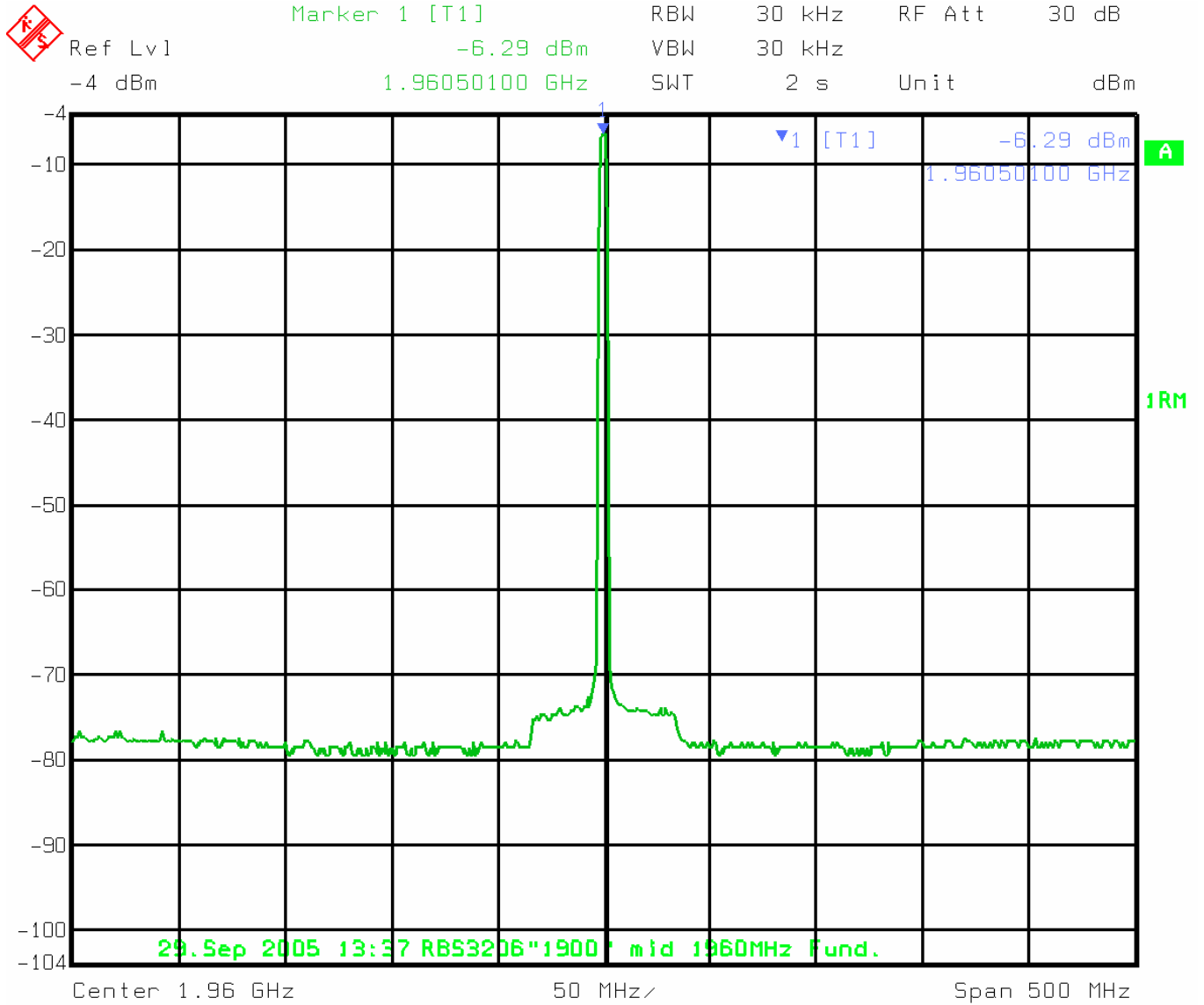

Date: 29.SEP.2005 13:37:23

Prepared (also subject responsible if other) EWUTHFU		No. 3/0360-FCP 101 3765 Uen		
Approved EWU/PR/HD [Keith Goshia]	Checked	Date 2005-11-29	Rev B	Reference TA8AKRC11819-1

Marker 1 [T1]
RBW 30 kHz RF Att 30 dB  
-76.64 dBm
VBW 30 kHz  
-4 dBm
3.92050100 GHz
SWT 2 s Unit dBm

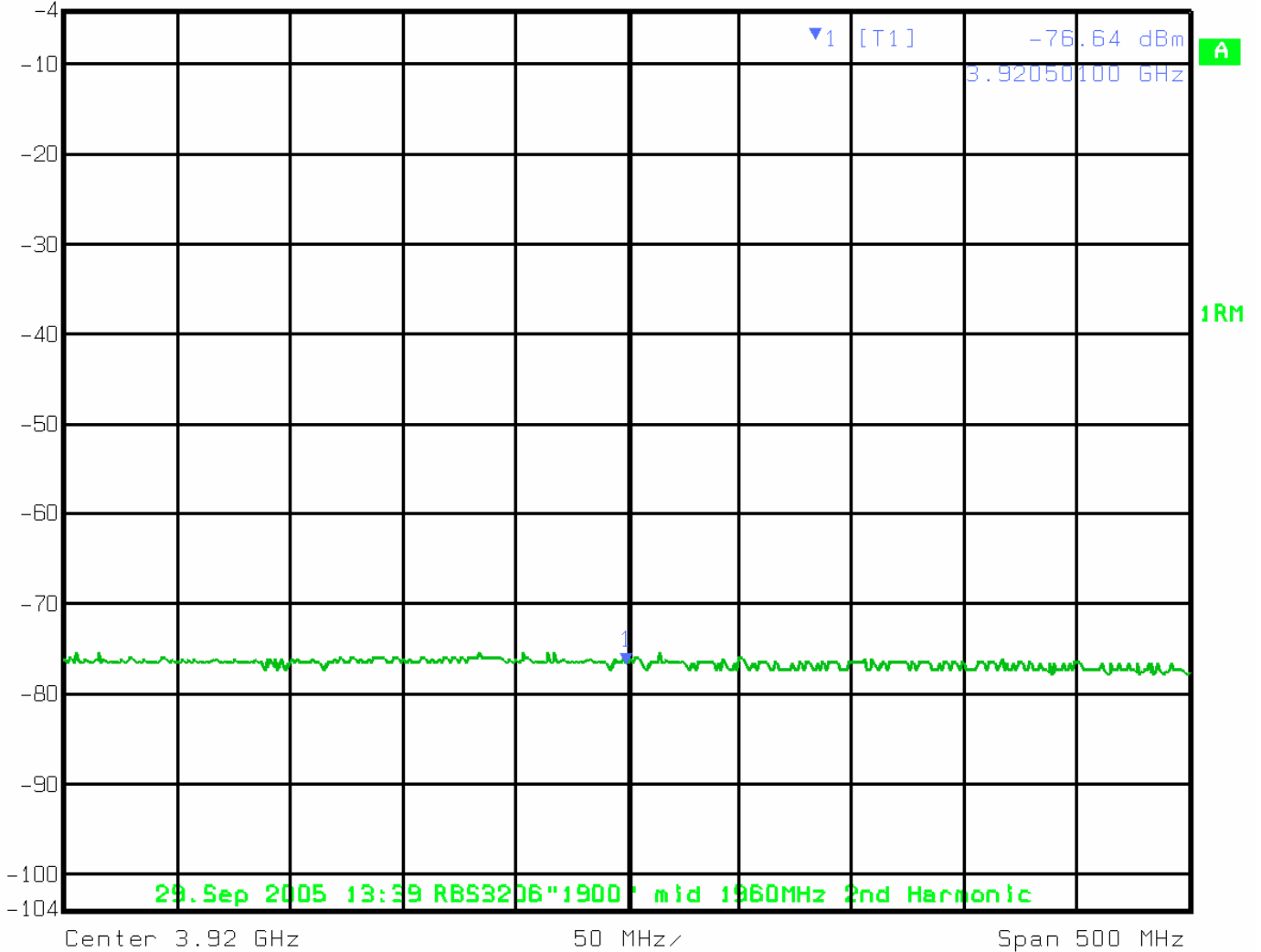

Date: 29.SEP.2005 13:39:18

Prepared (also subject responsible if other) EWUTHFU		No. 3/0360-FCP 101 3765 Uen		
Approved EWU/PR/HD [Keith Goshia]	Checked	Date 2005-11-29	Rev B	Reference TA8AKRC11819-1

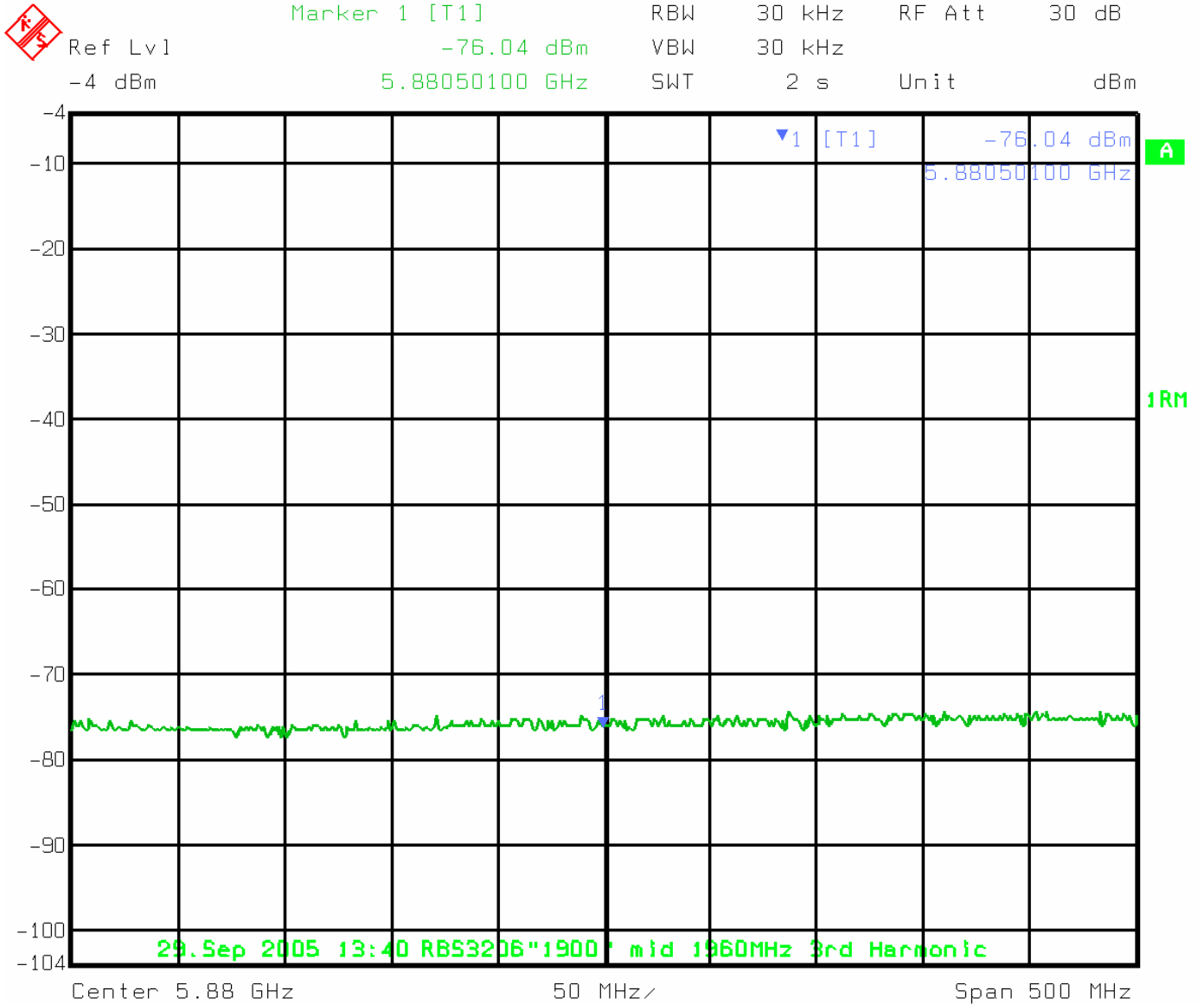

Date: 29.SEP.2005 13:40:46



Prepared (also subject responsible if other) EWUTHFU		No. 3/0360-FCP 101 3765 Uen		
Approved EWU/PR/HD [Keith Goshia]	Checked	Date 2005-11-29	Rev B	Reference TA8AKRC11819-1



Marker 1 [T1] RBW 30 kHz RF Att 30 dB  
 Ref Lvl -76.04 dBm VBW 30 kHz  
 -4 dBm 7.84050100 GHz SWT 2 s Unit dBm

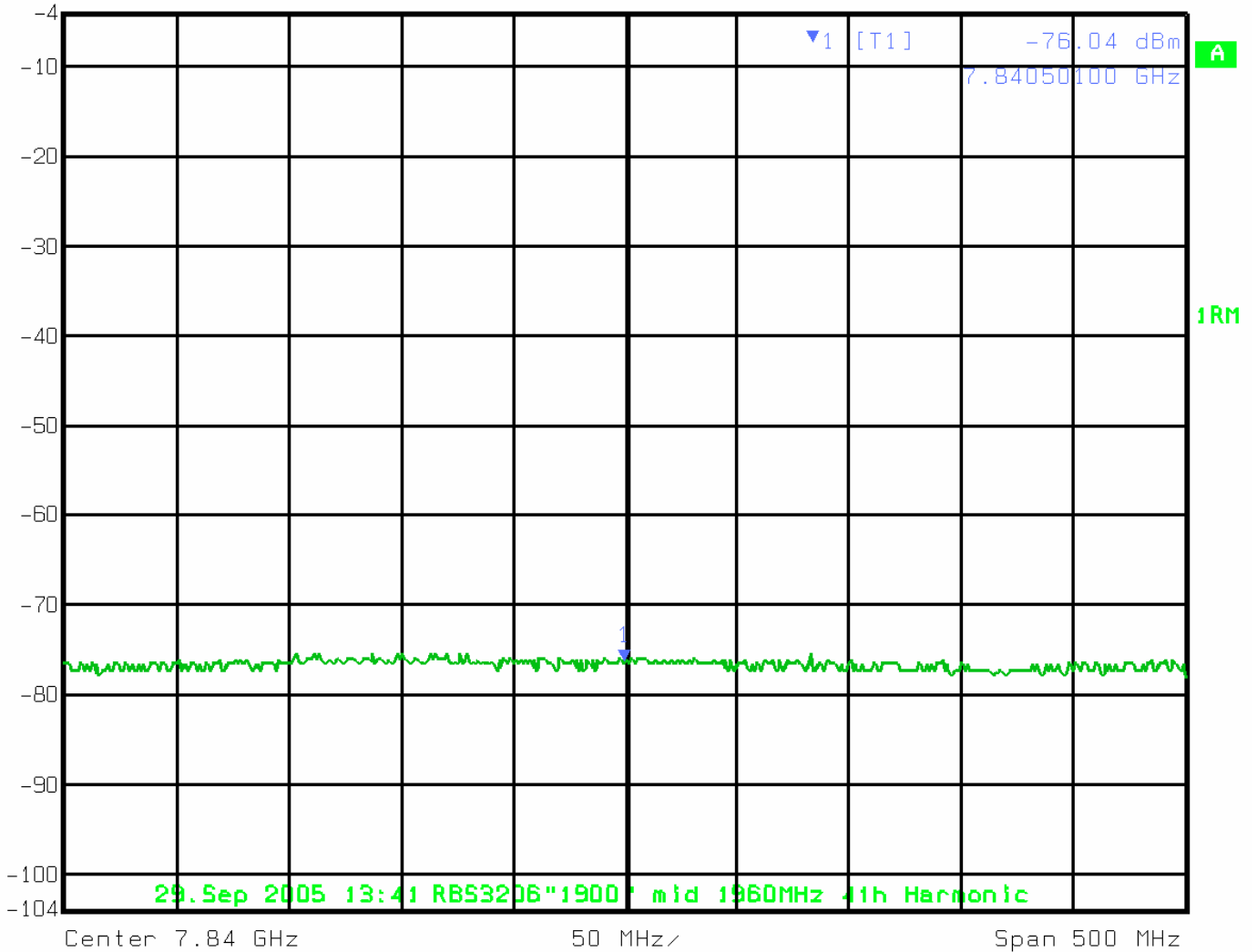

Date: 29.SEP.2005 13:42:00

Prepared (also subject responsible if other) EWUTHFU		No. 3/0360-FCP 101 3765 Uen		
Approved EWU/PR/HD [Keith Goshia]	Checked	Date 2005-11-29	Rev B	Reference TA8AKRC11819-1



Marker 1 [T1]      RBW 30 kHz      RF Att 30 dB  
 Ref Lvl -75.48 dBm      VBW 30 kHz  
 -4 dBm      9.80050100 GHz      SWT 2 s      Unit dBm

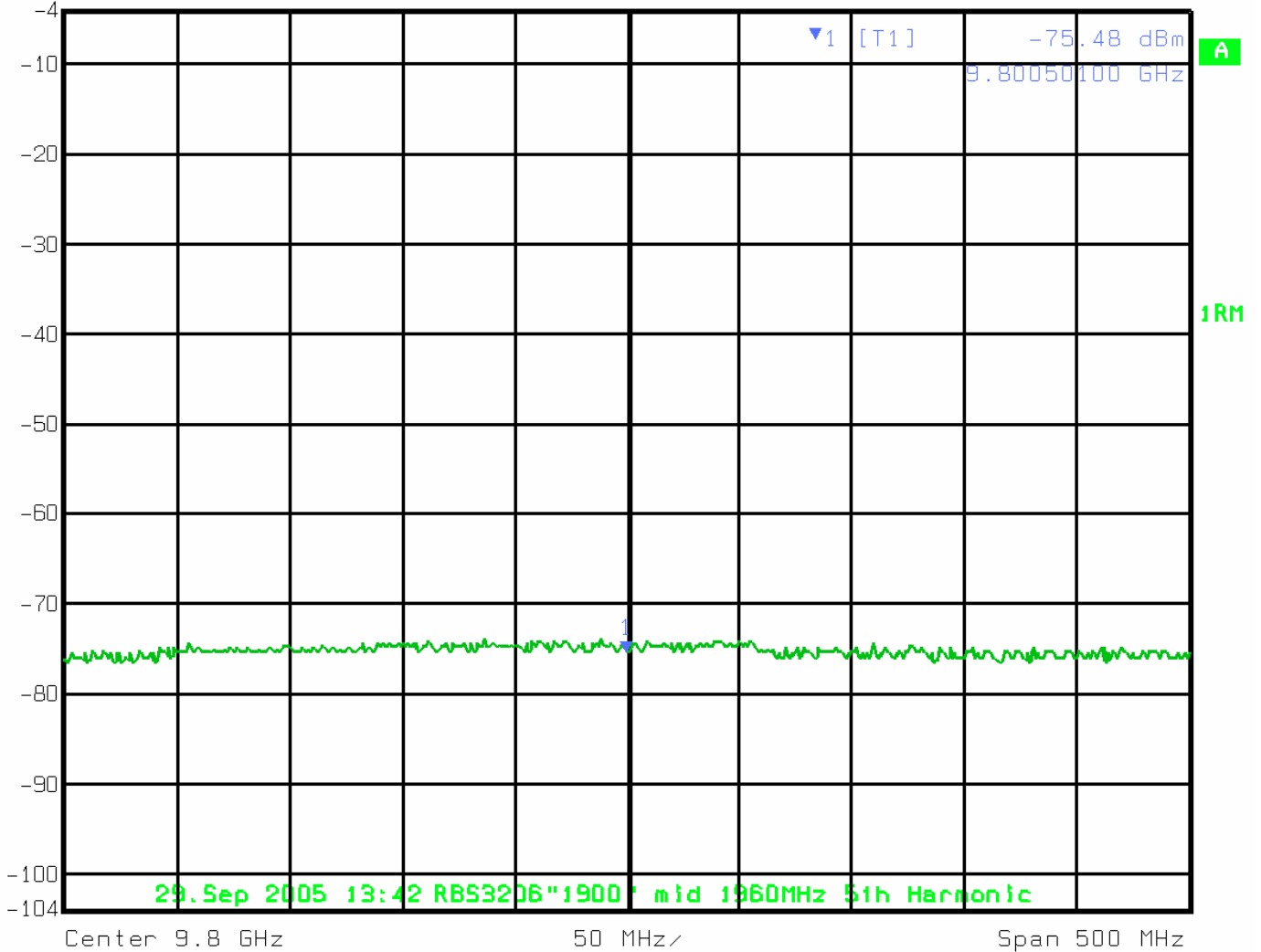

Date: 29.SEP.2005 13:43:05

Prepared (also subject responsible if other) EWUTHFU		No. 3/0360-FCP 101 3765 Uen		
Approved EWU/PR/HD [Keith Goshia]	Checked	Date 2005-11-29	Rev B	Reference TA8AKRC11819-1



Marker 1 [T1]      RBW    30 kHz    RF Att    30 dB  
 Ref Lvl                    -75.48 dBm    VBW    30 kHz  
 -4 dBm                    11.76050100 GHz    SWT    2 s    Unit            dBm

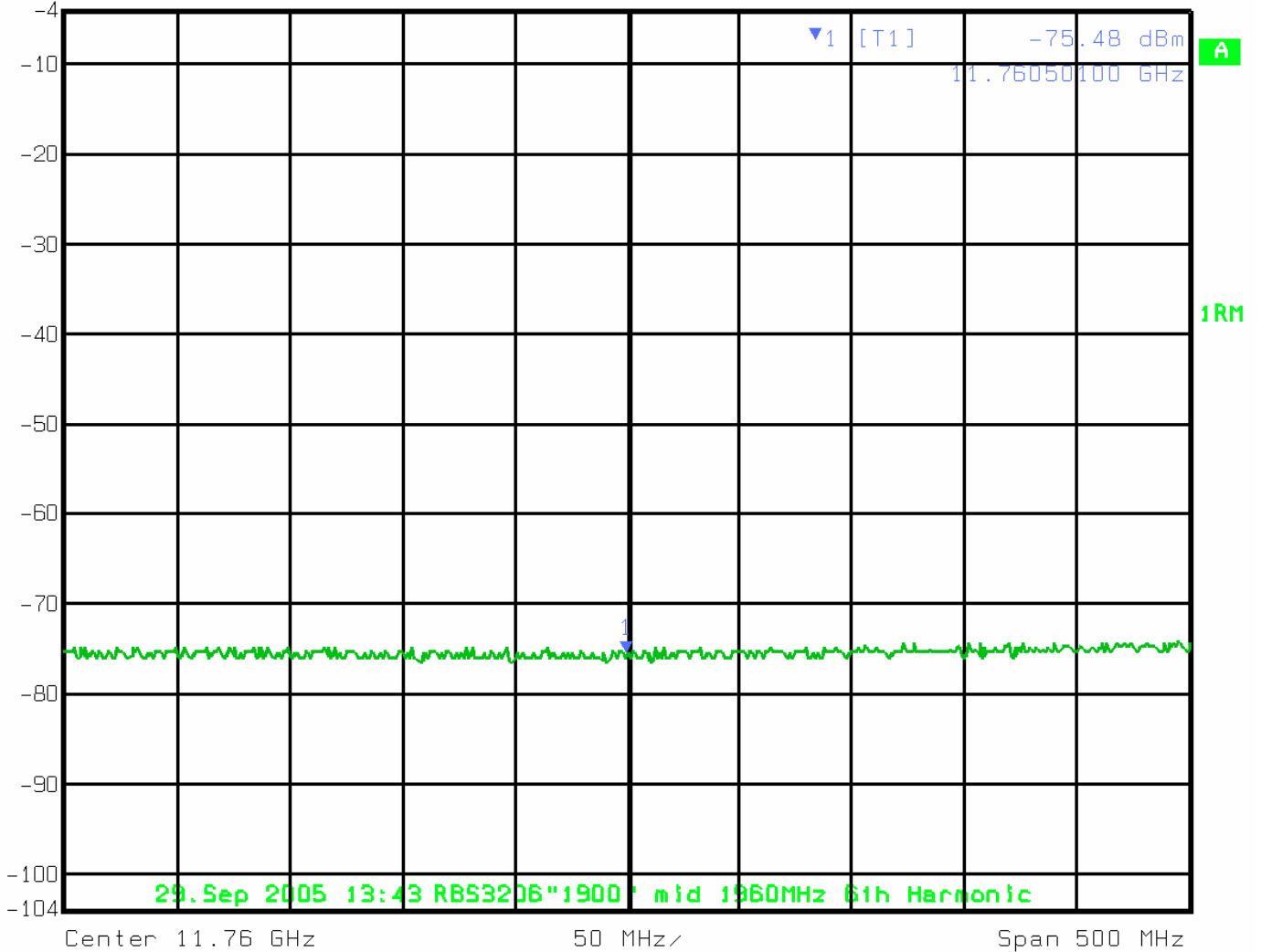

Date:      29.SEP.2005    13:44:04

Prepared (also subject responsible if other) EWUTHFU		No. 3/0360-FCP 101 3765 Uen		
Approved EWU/PR/HD [Keith Goshia]	Checked	Date 2005-11-29	Rev B	Reference TA8AKRC11819-1



Marker 1 [T1]      RBW 30 kHz      RF Att 30 dB  
 Ref Lvl -76.64 dBm      VBW 30 kHz  
 -4 dBm      13.72050100 GHz      SWT 2 s      Unit dBm

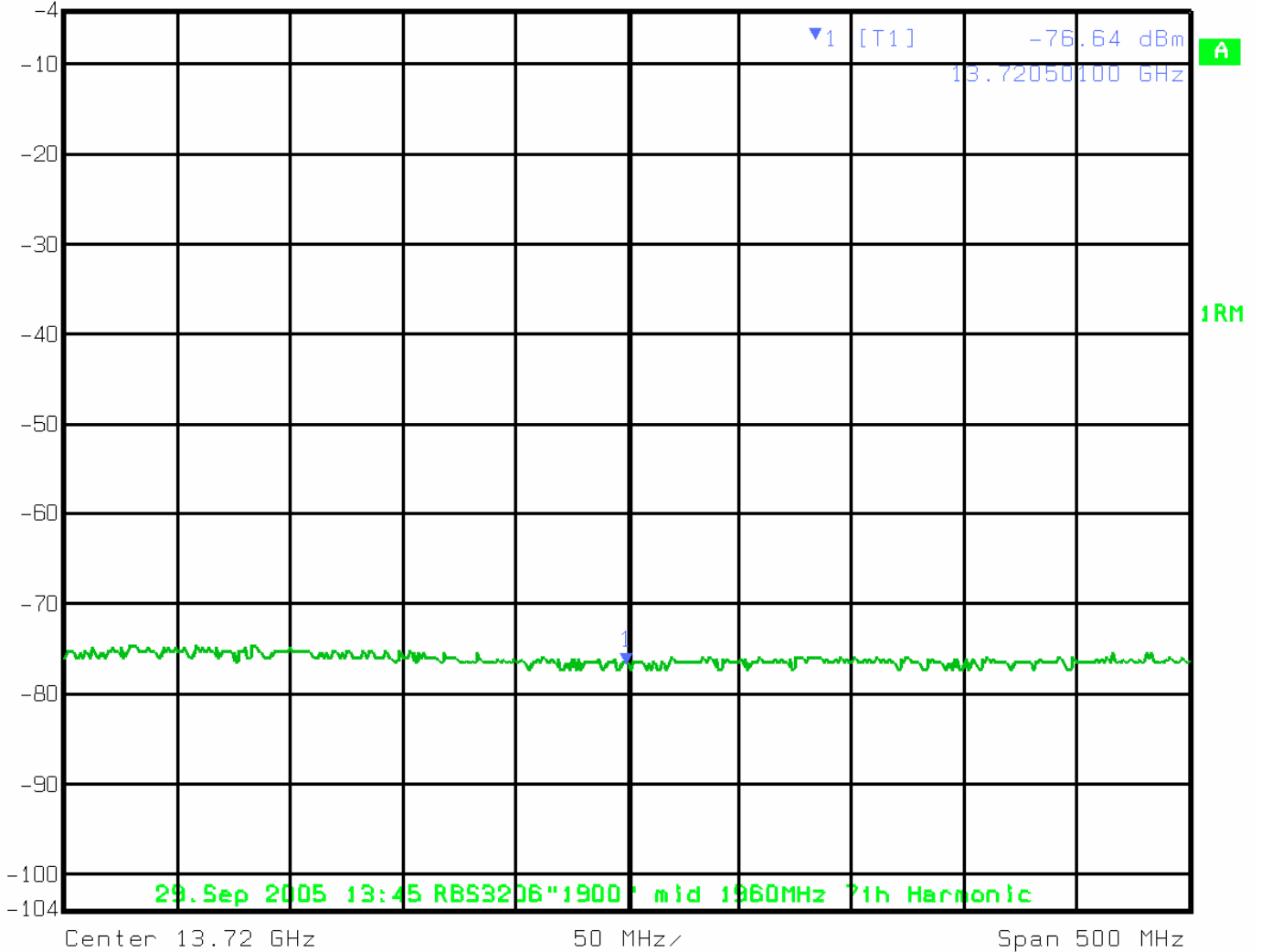

Date: 29.SEP.2005 13:45:09

Prepared (also subject responsible if other) EWUTHFU		No. 3/0360-FCP 101 3765 Uen		
Approved EWU/PR/HD [Keith Goshia]	Checked	Date 2005-11-29	Rev B	Reference TA8AKRC11819-1



Marker 1 [T1]      RBW 30 kHz      RF Att 30 dB  
 Ref Lvl -65.59 dBm      VBW 30 kHz  
 -4 dBm      15.67248497 GHz      SWT 2 s      Unit dBm

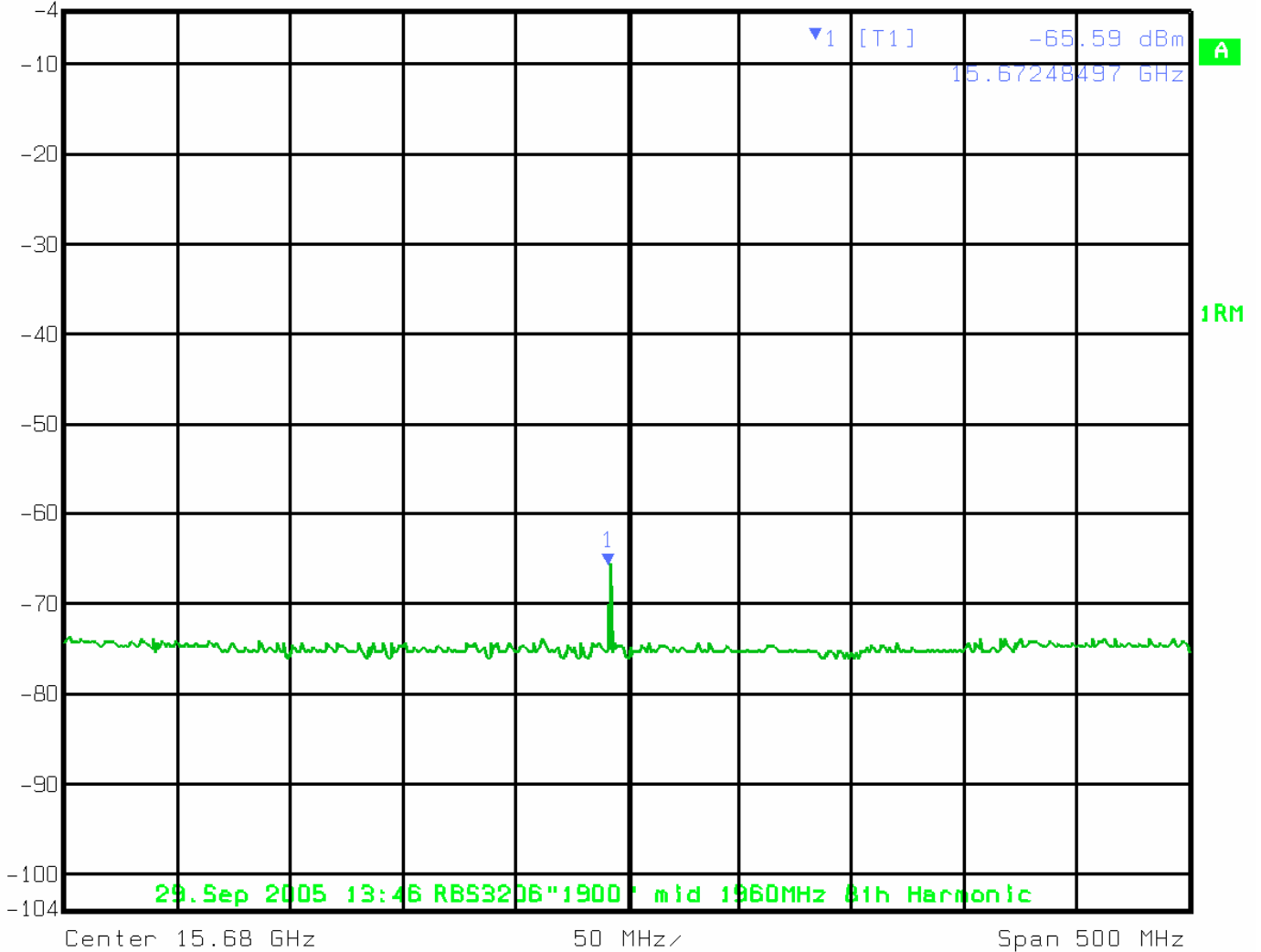

Date: 29.SEP.2005 13:46:38

Prepared (also subject responsible if other) EWUTHFU		No. 3/0360-FCP 101 3765 Uen		
Approved EWU/PR/HD [Keith Goshia]	Checked	Date 2005-11-29	Rev B	Reference TA8AKRC11819-1



Marker 1 [T1] RBW 30 kHz RF Att 30 dB  
 Ref Lvl -76.04 dBm VBW 30 kHz  
 -4 dBm 17.64050100 GHz SWT 2 s Unit dBm

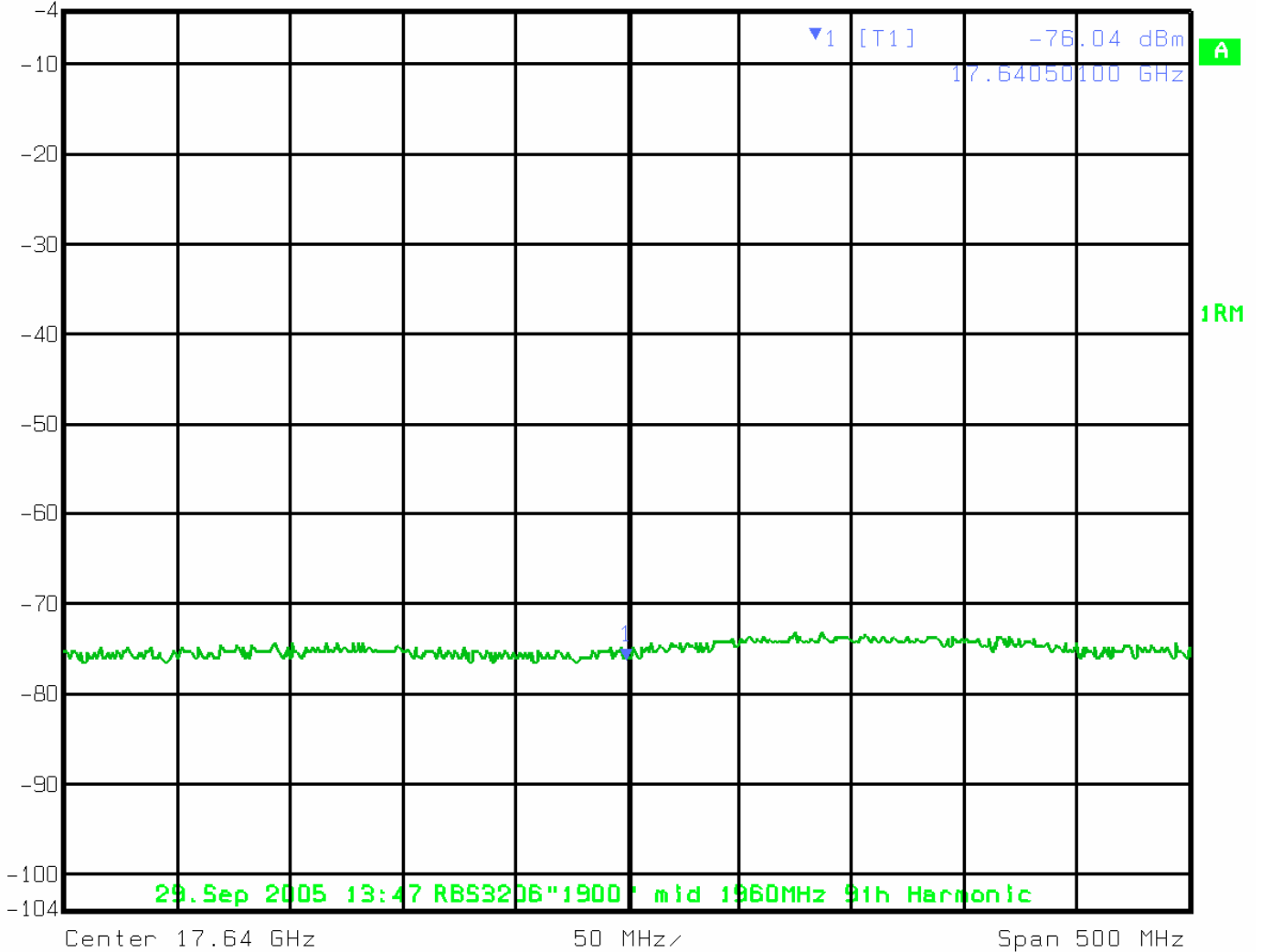

Date: 29.SEP.2005 13:47:42

Prepared (also subject responsible if other) EWUTHFU		No. 3/0360-FCP 101 3765 Uen		
Approved EWU/PR/HD [Keith Goshia]	Checked	Date 2005-11-29	Rev B	Reference TA8AKRC11819-1



Marker 1 [T1]      RBW 30 kHz      RF Att 30 dB  
 Ref Lvl -74.96 dBm      VBW 30 kHz  
 -4 dBm      19.60050100 GHz      SWT 2 s      Unit dBm

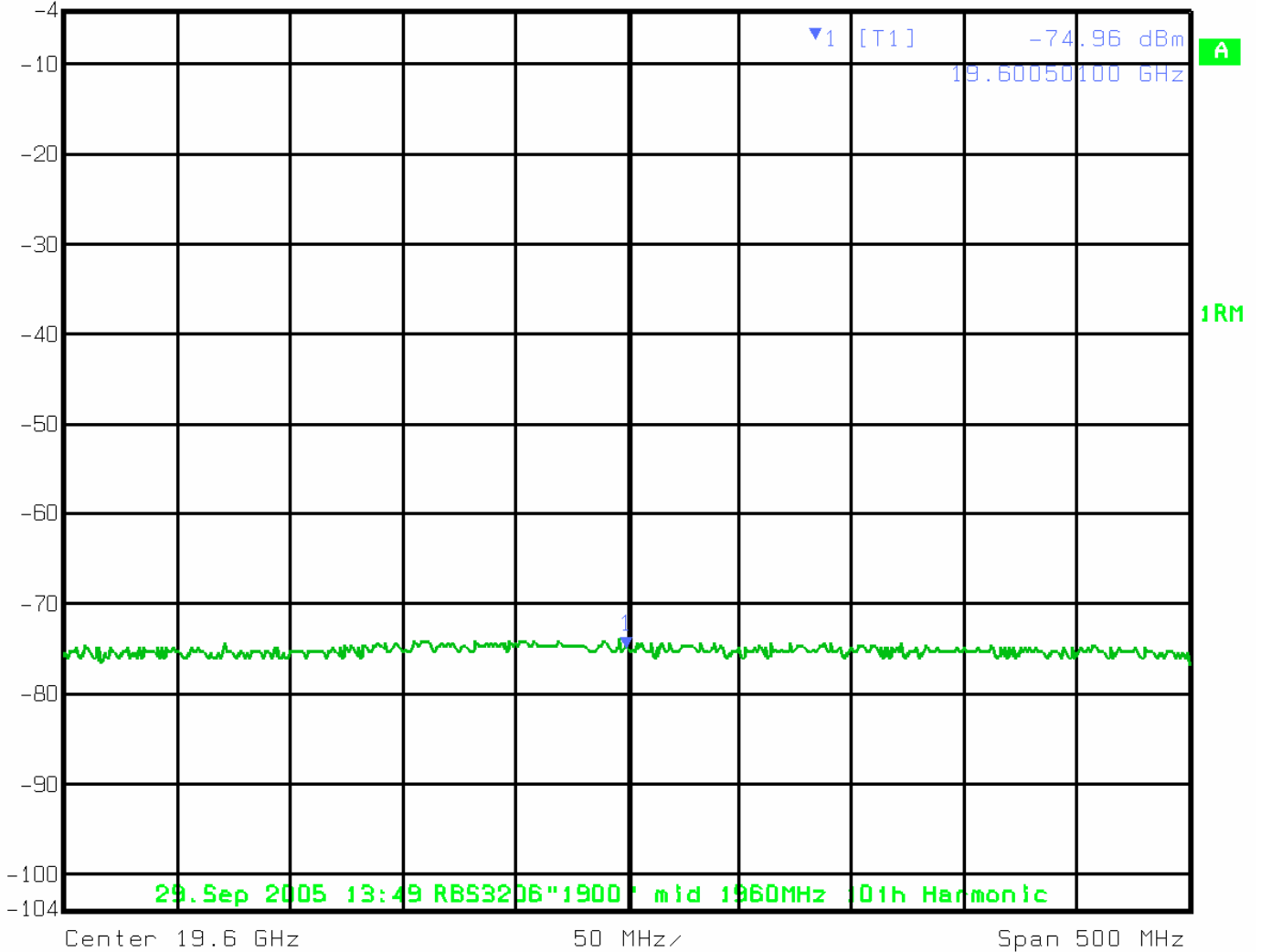

Date: 29.SEP.2005 13:49:06

Prepared (also subject responsible if other) EWUTHFU		No. 3/0360-FCP 101 3765 Uen		
Approved EWU/PR/HD [Keith Goshia]	Checked	Date 2005-11-29	Rev B	Reference TA8AKRC11819-1

### Spurious Emissions at Antenna Terminals

#### Test 1: Spurious Emissions at Antenna Terminals

---

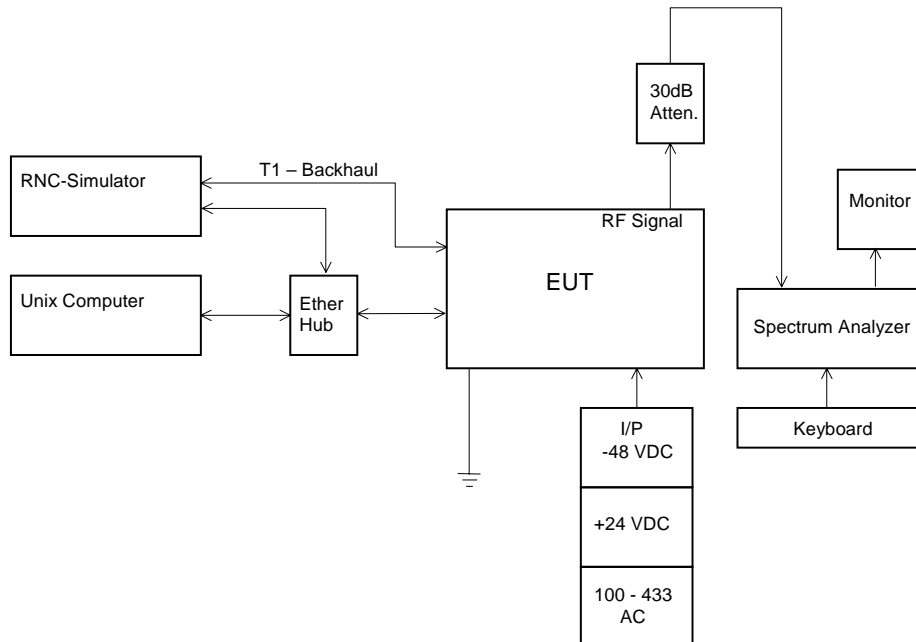



Prepared (also subject responsible if other) EWUTHFU		No. 3/0360-FCP 101 3765 Uen		
Approved EWU/PR/HD [Keith Goshia]	Checked	Date 2005-11-29	Rev B	Reference TA8AKRC11819-1

Name of Test: Field Strength of Spurious Radiation

Paragraph: 47 CFR 2.1053

Guide: See Measurement Procedure Below

Test Condition: Standard Temperature & Humidity

Test Equipment: As per Attached Appendix J

#### Measurement Procedures

1. A description of the measurement facilities was filed with the FCC and was found to be in compliance with the requirements of Section 15.38, by letter from the FCC. The test facility used was Criterion Technologies, Rollinsville Co.
2. In the field, the test sample was placed on a turntable at ten and three meters away from the search antenna. The test sample was connected to an RF wattmeter and a 50 ohm dummy load, and adjusted to its rated output.

In order to obtain the maximum response at each spurious frequency, the turntable was rotated. Also, the Search Antennas were raised and lowered vertically, and all cables were oriented. Excess power lead was coiled above the system.

#### 3. Measurement Results:

Spurious emission bandwidth settings per 22.907 (j)(1) & (2) as applicable.

Prepared (also subject responsible if other) EWUTHFU		No. 3/0360-FCP 101 3765 Uen		
Approved EWU/PR/HD [Keith Goshia]	Checked	Date 2005-11-29	Rev B	Reference TA8AKRC11819-1



NVLAP LAB CODE 100396-0

---

• P.O. Box 489 • 1350 Tolland Road • Rollinsville, CO 80474 • Phone: (303) 258-0100 • FAX: (303) 258-0775 •  
• [www.criteriontech.com](http://www.criteriontech.com) •

---

## EMC QUALIFICATION TEST REPORT

### ERICSSON RADIO BASE STATION, RBS 3206 -48VDC 1900MHZ 40WATT

TESTED TO CONFORM WITH:

 **Emissions Standards**

for

**INFORMATION TECHNOLOGY EQUIPMENT (ITE)**TEST REPORT NUMBER: 051003-964RDATE OF ISSUE: OCTOBER 20, 2005DATE OF TEST COMPLETION: OCTOBER 19, 2005MANUFACTURER'S ADDRESS: 6210 SPINE ROAD  
BOULDER, CO 80301PHONE: (303) 473-6839

Approved by:



Laboratory Director

Prepared (also subject responsible if other) EWUTHFU		No. 3/0360-FCP 101 3765 Uen		
Approved EWU/PR/HD [Keith Goshia]	Checked	Date 2005-11-29	Rev B	Reference TA8AKRC11819-1

Sheet 2 of 18

EMC QUALIFICATION TEST REPORT  
051003-964R FOR Ericsson

CRITERION TECHNOLOGY

**DISCLAIMERS**

This report is the confidential property of the client. For the protection of our clients and ourselves, extracts from this test report cannot be produced without prior written approval from Criterion Technology. Reproduction of the complete report can be performed at the client's discretion.

The client is aware that Criterion Technology has performed testing in accordance with the applicable standard(s). Test data is accurate within ANSI parameters for Emissions testing, unless a specific level of accuracy has been defined in writing prior to testing, by Criterion Technology and the client.

Criterion Technology reports apply only to the specific Equipment Under Test (EUT) sample(s) tested under the test conditions described in this report. If the manufacturer intends to use this report as a document demonstrating compliance of this model, additional models of this product must have electrical and mechanical characteristics identical to the device tested for this report. Criterion Technology shall have no liability for any deductions, inferences, or generalizations drawn by the client or others from Criterion Technology issued reports.

Total liability is limited to the amount invoiced for the testing of this EUT and the contents of this report are not warranted.

Compliance with the appropriate governmental standards is the responsibility of the manufacturer.

Any questions regarding this report should be directed to:

Laboratory Director  
Criterion Technology Corp.  
P.O. Box 488  
1350 Tolland Road  
Rollinsville, Colorado 80474  
Phone: (303) 258-0100  
Fax: (303) 258-0775  
mailto:laboratory\_director@critteriontech.com

**NVLAP Note:** Criterion Technology is accredited by the National Voluntary Laboratory Accreditation Program (NVLAP) for the specific scope of accreditation under Lab Code 100398-0. Test methods included in Lab Code 100398-0 are:

12/CIS22 - IEC/CISPR22 (1997) and En 55022 (1998)  
12/CIS22a - IEC/CISPR22 (1993), Amendment 1:1995 & Amendment 2: 1998  
12/CIS22b - CNS13438 (1997)  
12/EM02a - IEC 61000-3-2, Edition 2.1 (2001-10) and EN 61000-3-2 (2000)  
12/EM03 - EN 61000-3-3 (1995) and IEC 61000-3-3 (1995)  
12/F01 - ANSI C83.4 (2001) - cited in FCC Method - 47 CFR Part 15 - Digital Devices  
12/F01a - Conducted Emissions, Power Lines, 150 kHz to 30 MHz  
12/F01b - Radiated Emissions  
12/T61 - AS/NZS 3548  
12/I01 - IEC 61000-4-2 (1995) and Amendment 1 (1998)  
12/I02 - IEC 61000-4-3 (1995) and Amendment 1 (1998)  
12/I03 - IEC 61000-4-4 (1995)  
12/I04 - IEC 61000-4-5 (1995)  
12/I05 - IEC 61000-4-6 (1996)  
12/I06 - IEC 61000-4-8 (1993)  
12/I07 - IEC 61000-4-11 (1994)

The NVLAP Logo on the front cover of this report applies only to data taken for the above test methods.

This report may contain data which is not covered by the NVLAP accreditation.

This report must not be used by the client to claim product endorsement by NVLAP or any agency of the U.S. Government.

Criterion Technology has been accredited by the following groups: NVLAP, FCC, BSMI, VCCI, NMi (EU Competent Body Accreditation) and Industry Canada. The National Institute for Standards and Technology (NIST) has designated Criterion Technology a Conformity Assessment Body (CAB) for Taiwan (BSMI # SL2-IN-E-007R).

**ALL CRITERION TECHNOLOGY INSTRUMENTATION AND ACCESSORIES USED TO TEST PRODUCTS FOR COMPLIANCE TO THE INDICATED STANDARDS ARE CALIBRATED REGULARLY IN ACCORDANCE WITH ISO 9001, ISO GUIDE 25, ANSI/NCCL Z540-1-1994 AND ARE TRACEABLE TO NATIONAL STANDARDS.**

Prepared (also subject responsible if other) EWUTHFU		No. 3/0360-FCP 101 3765 Uen		
Approved EWU/PR/HD [Keith Goshia]	Checked	Date 2005-11-29	Rev B	Reference TA8AKRC11819-1

CRITERION TECHNOLOGY

EMC QUALIFICATION TEST REPORT  
051003-964R FOR Ericsson

Sheet 3 of 18

**TABLE OF CONTENTS**

**1.0 EXECUTIVE SUMMARY** ..... 4

    1.1 PURPOSE ..... 4

    1.2 CONFORMITY ..... 4

    1.3 EQUIPMENT UNDER TEST (EUT) ..... 4

**2.0 EMISSIONS TEST STANDARDS** ..... 5

    2.1 INTENTIONAL RADIATOR ..... 5

**3.0 APPENDIX A: EUT PHOTOGRAPHS** ..... 6

    3.1 INTENTIONAL RADIATOR ..... 6

**4.0 APPENDIX B: DATA SHEETS** ..... 7

    4.1 INTENTIONAL RADIATOR EMISSIONS PLOT – 1 GHZ TO 20 GHZ ..... 7

    4.2 INTENTIONAL RADIATOR EMISSIONS TABLE – 1 GHZ TO 20 GHZ ..... 8

    4.3 INTENTIONAL RADIATOR ..... 11

**5.0 APPENDIX C: PRODUCT INFORMATION FORM** ..... 12

**6.0 APPENDIX D: TEST EQUIPMENT AND CALIBRATION STATUS** ..... 15

**7.0 APPENDIX E: TEST DIRECTIVES, STANDARDS AND METHODS** ..... 16

Prepared (also subject responsible if other) EWUTHFU		No. 3/0360-FCP 101 3765 Uen		
Approved EWU/PR/HD [Keith Goshia]	Checked	Date 2005-11-29	Rev B	Reference TA8AKRC11819-1

Sheet 4 of 18

EMC QUALIFICATION TEST REPORT  
~~051003-964R~~ FOR Ericsson

CRITERION TECHNOLOGY

**EMC QUALIFICATION TEST REPORT  
RADIO BASE STATION, RBS 3206 -48VDC 1900MHZ 40WATT**

**1.0 EXECUTIVE SUMMARY**

**1.1 PURPOSE**

The purpose of this report is to present EMC test data and demonstrate conformity to the requirements of the prescribed standards for Emissions and/or Immunity.

**1.2 CONFORMITY**

The test article was tested to the standards listed in Table I with the indicated conformity status. All test methods were performed in accordance to with the standards listed.

TABLE I. EMISSIONS CONFORMITY SUMMARY

TEST TYPE	COMPLIANCE STANDARD	TESTING TECHNIQUE	TEST DESCRIPTION	PRODUCT CLASSIFICATION	CONFORMITY STATUS
EMISSIONS	<u>FCC Part 24</u>	<input checked="" type="checkbox"/> FCC TITLE 47 PART 24	Intentional Radiated Emissions	Class B	<b>PASSED</b>

**1.3 EQUIPMENT UNDER TEST (EUT)**

EUT NAME: RADIO BASE STATION  
 EUT MODEL/PART NUMBER(S): RBS 3206 -48VDC 1900MHZ 40WATT  
 EUT SERIAL NUMBER(S): A594670497

Prepared (also subject responsible if other) EWUTHFU		No. 3/0360-FCP 101 3765 Uen		
Approved EWU/PR/HD [Keith Goshia]	Checked	Date 2005-11-29	Rev B	Reference TA8AKRC11819-1

CRITERION TECHNOLOGY

EMC QUALIFICATION TEST REPORT  
051003-964R FOR Ericsson

Sheet 5 of 18

**2.0 EMISSIONS TEST STANDARDS**

FCC Part 24

Class B

**2.1  INTENTIONAL RADIATOR**

Measurements for *Intentional Radiated Emissions* were performed over the frequency range of 1GHz to 20 GHz the horizontal and vertical antenna polarities to the requirements of:

FCC Part 24

Class B

Testing Conditions

Date of Test: October 19, 2005  
 Temperature: 21°C  
 Relative Humidity: 38%  
 Test Voltage: -48VDC  
 Test Operator: lws

Test Location

Criterion Technology Open Area Test Site

Test Distance

Antenna Distance: 3 meter(s)      Final Measurement(s)

Test Equipment

- Hewlett-Packard Spectrum Analyzer, HP 8566B       Hewlett-Packard Quasi-Peak Adapter, HP 85650A
- Hewlett-Packard Tracking Generator, HP 85645A
- Rohde and Schwarz Receiver, ESHS-30       Rohde and Schwarz Receiver, ESVS-30
- Mini Circuits Pre-Amp #2       Veratech Pre-Amp #3
- Chase BiLog Antenna, Model 1121       Antenna Research, Horn Antenna, Model DRG118/A
- EMCO BiConical Antenna, Model 3108       EMCO Log Periodic Antenna, Model 3146
- EMCO Active Loop, 6502       EMCO Horn, 3180-08

Test Accessories: See Appendix C for support equipment list

Test Results of Radiated Emissions

Test Status: PASSED      Frequency Range: 1 GHz to 20 GHz

Minimum Margin to Limit: -6.27 dB at 3920 MHz

Remarks

See: **APPENDIX A** for EUT Photographs      **APPENDIX B** for Data Sheets  
**APPENDIX D** for Test Equipment Calibration Status

Prepared (also subject responsible if other) EWUTHFU		No. 3/0360-FCP 101 3765 Uen		
Approved EWU/PR/HD [Keith Goshia]	Checked	Date 2005-11-29	Rev B	Reference TA8AKRC11819-1

Sheet 6 of 18

EMC QUALIFICATION TEST REPORT  
051003-964 FOR Ericsson

CRITERION TECHNOLOGY

### 3.0 APPENDIX A: EUT PHOTOGRAPHS

#### 3.1 INTENTIONAL RADIATOR



Prepared (also subject responsible if other) EWUTHFU		No. 3/0360-FCP 101 3765 Uen		
Approved EWU/PR/HD [Keith Goshia]	Checked	Date 2005-11-29	Rev B	Reference TA8AKRC11819-1

CRITERION TECHNOLOGY

EMC QUALIFICATION TEST REPORT  
051003-964R FOR Ericsson

Sheet 7 of 18

**4.0 APPENDIX B: DATA SHEETS**

**4.1 INTENTIONAL RADIATOR EMISSIONS PLOT - 1 GHZ TO 20 GHZ**

Criterion Technology	Date: October 19, 2005
EUT: Radio Base Station, RBS 3206 -48VDC 1900MHz 40Watt	S/N: A594670497
Manufacturer: Ericsson	
Tester: lws	SpiD: 051003-964R
EUT Information: Channel Builder, RBS 3206 on center of turntable	
Test Information: 3 meters -48VDC antenna terminated into dummy load FCC Part 24	
Test Cond: Temp: 21°C	Humidity: 38%

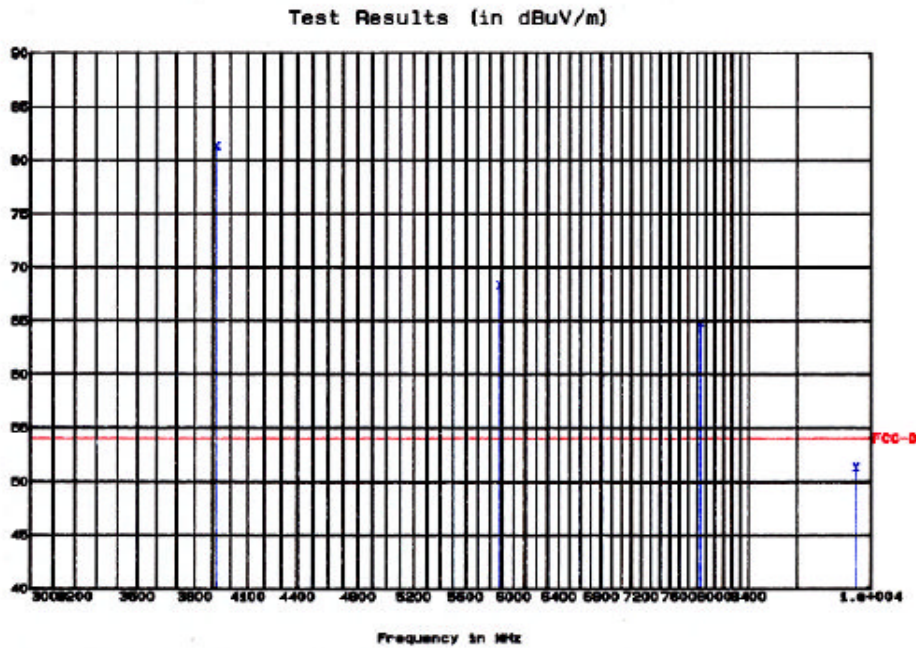



Prepared (also subject responsible if other) EWUTHFU		No. 3/0360-FCP 101 3765 Uen		
Approved EWU/PR/HD [Keith Goshia]	Checked	Date 2005-11-29	Rev B	Reference TA8AKRC11819-1

Sheet 8 of 18

EMC QUALIFICATION TEST REPORT  
051003-964R FOR Ericsson

CRITERION TECHNOLOGY

**4.2 INTENTIONAL RADIATOR EMISSIONS TABLE – 1 GHZ TO 20 GHZ**

**Notes:**

The third column below contains alpha characters which pertain to the type of measurements made. The following are the definitions for those characters: q = Quasi Peak, m = Maximized (cable, rotation and antenna height), s = scanned but no data taken, and a = average. For the first character in column four, a '\*' indicates that value is below the limit while an '\*\*' indicates that value is above the limit. If the list is sorted using "I-sort", then quasi-peak and average levels are weighted higher than peak levels and are moved to the front of the scan list.

The following keys help to better understand the data:

TT: Turntable position in degrees

Hght: Height of antenna in centimeters

Az: Azimuth, V = Vertical, H= Horizontal

Minimum Margin to Limit: -6.27 dB at 3920 MHz

Criterion Technology Wed Oct 19 14:32:37 2005

EUT: Radio Base Station, RBS 3206 –48VDC 1900MHz

Manufacturer: Ericsson

Tester: lws Special ID: 051003-964R

EUT Information: Channel builder, RBS 3206 on center of turntable

Test information: Channel builder, 3 meters, -48 VDC, antenna terminated into dummy load, FCC24

**Table 1: Scan List, sorted by margin to limit FCC-B, -30.0dB filter**

<u>Freq. MHz</u>	<u>Value</u>	<u>Sts</u>	<u>FCC-B</u>	<u>TT</u>	<u>Hght</u>	<u>Az</u>	<u>Comment</u>
3920.0000	81.28	m	27.30	354	130	V	ir harmonic
5880.0000	68.32	m	14.34	5	167	V	ir harmonic
7840.0000	64.72	m	10.74	359	109	V	ir harmonic
9800.0000	51.29	m	-2.69	328	136	V	noise floor

Prepared (also subject responsible if other) EWUTHFU		No. 3/0360-FCP 101 3765 Uen		
Approved EWU/PR/HD [Keith Goshia]	Checked	Date 2005-11-29	Rev B	Reference TA8AKRC11819-1

**Table 2: Scan List for FCC-B, sorted by Frequency, -30.0dB filter**

<u>Freq. MHz</u>	<u>Value</u>	<u>Sts</u>	<u>FCC-B</u>	<u>TT</u>	<u>Hght</u>	<u>Az</u>	<u>Comment</u>
3920.0000	81.28	m	27.30	354	130	V	ir harmonic
5880.0000	68.32	m	14.34	5	167	V	ir harmonic
7840.0000	64.72	m	10.74	359	109	V	ir harmonic
9800.0000	51.29	m	-2.69	328	136	V	noise floor

Prepared (also subject responsible if other) EWUTHFU		No. 3/0360-FCP 101 3765 Uen		
Approved EWU/PR/HD [Keith Goshia]	Checked	Date 2005-11-29	Rev B	Reference TA8AKRC11819-1

Sheet 10 of 18

EMC QUALIFICATION TEST REPORT  
051003-964R FOR Ericsson

CRITERION TECHNOLOGY

**Table 3: Complete Scan List Sorted by Frequency**

Freq. MHz	I-val	Final	Sts	TT	Hght	Az	Time	Comment
3920.0000	80.51	81.28	m	354	130	V	Wed Oct 19 12:50:45 2005	ir harmonic
5880.0000	57.05	68.32	m	5	167	V	Wed Oct 19 12:56:57 2005	ir harmonic
7840.0000	51.69	64.72	m	359	109	V	Wed Oct 19 13:02:14 2005	ir harmonic
9800.0000	35.06	51.29	m	328	136	V	Wed Oct 19 13:05:08 2005	noise floor

Prepared (also subject responsible if other) EWUTHFU		No. 3/0360-FCP 101 3765 Uen		
Approved EWU/PR/HD [Keith Goshia]	Checked	Date 2005-11-29	Rev B	Reference TA8AKRC11819-1

CRITERION TECHNOLOGY

EMC QUALIFICATION TEST REPORT  
051003-964R FOR Ericsson

Sheet 11 of 18

4.3 INTENTIONAL RADIATOR

Fundamental Freq (MHz)	Pwr Lvl to Ant using Sub method	Xmtr atten pads (db)	Pwr Out (dbm)	Pwr Out -Watts
------------------------	---------------------------------	----------------------	---------------	----------------

1960.	2.73	30.3 + 3.0 + 10.0	46.03	40.09
-------	------	-------------------	-------	-------

Harmonic #	Frequency	F val	FCC part 24 limit (dbuV/m)	Margin	Comments
2 Fo	3920.	***Note	94	-6.27	2 <sup>nd</sup> Harmonic
3 Fo	5880	68.32	94	-25.68	3 <sup>rd</sup> Harmonic
4 Fo	7840	64.72	94	-29.28	4th Harmonic
5 Fo	9800	51.29	94	-42.71	NOISE FLOOR
6 Fo	11760	53.85	94	-40.15	NOISE FLOOR
7 Fo	13720	23.83	94	-70.17	NOISE FLOOR
8 Fo	15680	24.75	94	-69.25	NOISE FLOOR
9 Fo	17640	38.54	94	-55.46	NOISE FLOOR
10 Fo	19600	46.85	94	-47.15	NOISE FLOOR

\*\*\*Note: Raw value for 2nd harmonic is 80.5 db on the spectrum analyzer. The EUT was replaced by an antenna driven by a signal generator at 3920 MHz, the signal generator level was increased until the 80.5 reference level was attained. When the HP XXXX power meter was used to measure the power into the antenna, the level was -21.15 dBm. The gain of the AH Systems Model SAS 519-4 Log Period at 3920 MHz is 4.18 DBi. Gain of a dipole is 2.3 dBi, so the log periodic has 1.88 db more gain than a dipole. The equivalent signal level into a dipole of the second harmonic is -21.15 dBm + 1.88 db = -19.27 dBm. Spec limit is -13 dBm, so the second harmonic has -6.27 dB margin to limit.

Prepared (also subject responsible if other) EWUTHFU		No. 3/0360-FCP 101 3765 Uen		
Approved EWU/PR/HD [Keith Goshia]	Checked	Date 2005-11-29	Rev B	Reference TA8AKRC11819-1

Sheet 12 of 18

EMC QUALIFICATION TEST REPORT  
051003-964R FOR Ericsson

CRITERION TECHNOLOGY

**5.0 APPENDIX C: PRODUCT INFORMATION FORM**

**CRITERION TECHNOLOGY PRODUCT INFORMATION FORM**

General Information

Date 9-27-2005

Company Name: Ericsson Wireless, Inc.  
Company Address: 6210 Spine Road  
Boulder, CO 80301

Contacts:  
Compliance Engineer: Keith Goshia Phone: 303-473-6956 Email: keith.goshia@ericsson.com

Test Description  
De-Bug          Formal (Initial)              Formal (Re-Verification)

Market Information (Check all that Apply)  
USA          Canada          Euro. Union          Taiwan          Japan          New Zealand  
Australia  
Other

Product Information  
Name Radio Base Station Model Number RBS 3206 -484VDC 1900MHz 40Watt Serial Number A594670497

Product Dimensions:                  Weight:  
Product Power Source:  
Battery  
Type                  Voltage -48 VDC  
AC Supply  
Input Voltage Range(s)  
Phases          Delta          Wye  
Current  
Frequency  
Manufacturer  
Model Number  
Topology  
Linear          Switching Mode          Switching Frequency

Support Equipment (if used):  
CPU:  
Manufacturer: Sun  
Model No.: Ultra 10  
Serial No.: TW00910322  
Monitor:  
Manufacturer: Sun  
Model No.: LSA800  
Serial No.: 0120409-0012ky0121  
Keyboard:  
Manufacturer: Sun  
Model No.: Type 6  
Serial No.: 0039147-9853001010  
Mouse:

Prepared (also subject responsible if other) EWUTHFU		No. 3/0360-FCP 101 3765 Uen		
Approved EWU/PR/HD [Keith Goshia]	Checked	Date 2005-11-29	Rev B	Reference TA8AKRC11819-1

CRITERION TECHNOLOGY

EMC QUALIFICATION TEST REPORT

Sheet 13 of 18

051003-964R FOR Ericsson

Manufacturer: Sun  
 Model No.: compac-1-1  
 Serial No.: LTC54507625

I/O Cables – Manufacturer, P/N, Length :

Serial Port: length as needed  
 Parallel Port: \_\_\_\_\_  
 SCSI Port: \_\_\_\_\_  
 Other: T1 length as needed

RNC:

Manufacturer: CES  
 Model No.: 4780 DA  
 Serial No.: 0204

Operation Software:

Name Channel builder Version Number N/A

Operating Modes: (Please Include Cycle Time)

RBS radiating at full power on 6 sectors Pseudo noise on all channels

Time necessary for EUT to be exercised and able to fully respond: ≤1 seconds.

Operation Pass/Fail Criteria:

\_\_\_\_\_  
 \_\_\_\_\_

Test Type – Emissions (Please check all that apply):

Information Technology Equipment

Class A\_

Class B X

Oscillator/Clock Frequencies (MHz) Frequency List Attachment

Industrial, Scientific, Medical Equipment

Class A\_

Class B\_

Oscillator/Clock Frequencies (MHz) \_\_\_\_\_

Unintentional Radiator

Class A\_

Class B\_

Oscillator/Clock Frequencies (MHz) \_\_\_\_\_

Receiver

Type (Regen., Superhet., Direct Conv., Homodyne) \_\_\_\_\_

Local Oscillator Frequencies \_\_\_\_\_

Frequency Range \_\_\_\_\_

Intentional Radiator

Fundamental Frequency Range 1960MHz

Local Oscillator Frequencies Frequency List Attachment

Power Output (to antenna) 40W

Integral Antenna (Yes/No) No

Modulation Type (AM, CM, Pulse, Spread Spectrum) WCDMA

Oscillator/Clock Frequencies (MHz) Frequency List Attachment



Prepared (also subject responsible if other) EWUTHFU		No. 3/0360-FCP 101 3765 Uen		
Approved EWU/PR/HD [Keith Goshia]	Checked	Date 2005-11-29	Rev B	Reference TA8AKRC11819-1

CRITERION TECHNOLOGY

 EMC QUALIFICATION TEST REPORT  
 051003-964R FOR Ericsson

Sheet 15 of 18

**6.0 APPENDIX D: TEST EQUIPMENT AND CALIBRATION STATUS**

Manufacturer	Name/Description	Model Number	Serial Number	Cal. Due Date
Haefely Trench	EFT Tester	PEFT Junior	583-333-51	10/12/2005
Hewlett Packard	Tracking Generator	HP85645A	3210A00124	11/9/2005
Heise	Barometer	710A	S7-15256	2/6/2006
Hewlett Packard	Pulse Generator	HP 8116A	2901G09493	2/13/2006
Amplifier Research	E-Field Probe	FP2000	19682	4/12/2006
Antenna Research	1-18 GHz Horn	DRG118/A	1057	4/13/2006
EMCO	Active Loop	6502	2626	4/14/2006
Amplifier Research	E-Field Probe	FP2080	20236	4/16/2006
Rohde/ Schwarz	VHF/UHF Receiver	ESVS-30	8634221014	4/19/2006
Hewlett Packard	Spectrum Analyzer Display	HP 85662A	2403A07322	5/12/2006
Hewlett Packard	Spectrum Analyzer	HP 8566B	2421A00527	5/12/2006
Veratech	Preamp (AMP2)		N/A	5/16/2006
Rohde/ Schwarz	HF Receiver	ESHS-30	826003/011	6/15/2006
Rohde/ Schwarz	LISN	ESH2-Z5	828739-001	6/15/2006
Chase	Bilog 30 - 1000 MHz	CB6111	1121	7/1/2006
FCC	CDN	FCC-801-M3-25	9714	8/2/2006
FCC	EM Clamp	F2031	309	8/3/2006
Amplifier Research	Power Amplifier	150A100A	20183	8/4/2006
Tegam	Current Probe	925236-1	12588	8/4/2006
Amplifier Research	Directional Coupler	DC2600	302981	8/4/2006
Hewlett Packard	Signal Generator	HP 8648D	3642000145	8/9/2006
Dickson	Temperature/ RH Recorder	THDX	5300245	8/11/2006
Amplifier Research	Power Amplifier	100W1000M1	20214	8/23/2006
Califorina Instruments	AC Power Source Pacs-1	5001iX-CTS-411	55637/ 72242	2/11/2007
EMCO	Horn	3160-08	1147	5/9/2007
Microwave Technologies	Standard Gain Horn	12A-18	19527	8/1/2007
Solar Electronics	LISN	8012-50-R-24-BNC	892310	8/9/2007



Prepared (also subject responsible if other) EWUTHFU		No. 3/0360-FCP 101 3765 Uen		
Approved EWU/PR/HD [Keith Goshia]	Checked	Date 2005-11-29	Rev B	Reference TA8AKRC11819-1

## 7.0 APPENDIX E: TEST DIRECTIVES, STANDARDS AND METHODS

### 7.1 EUROPEAN DIRECTIVES, STANDARDS AND METHODS

89/336/EEC: Council Directive of 03 May 1989 on the Approximation of the Laws of the Member States Relating to Electromagnetic Compatibility. OJEC No. L 139/19-26, Aug 1993.

EN 50081-1 (CENELEC): EMC - Generic Emission Standard, Part 1: Residential, Commercial and Light Industry, Revised 2001.

EN61000-6-4 (CENELEC): EMC - Generic Emission Standard, Part 6-4: Industrial Environment, 23 October 2001.

BS DD ENV 50204 (CENELEC): Testing and Measurement Techniques: Radiated Electromagnetic Field from Digital Radio Telephones - Immunity Test, 1996.

EN 55011 (CENELEC): ISM Radio-Frequency Equipment Radio Disturbance Characteristics - Limits and Methods of Measurement, with Amendments 1 & 2, 2003.

EN 55014-1 (CENELEC): Part 1. Electromagnetic Compatibility Requirements for Household Appliances, Electric Tools and Similar Apparatus - Part 1. Emission - Product Family Standard, 2001.

EN 55022 (CENELEC): ITE - Radio-Frequency Equipment Radio Disturbance Characteristics - Limits and Methods of Measurement, 2003.

EN 55024 (CENELEC): ITE - Immunity Characteristics - Limits and Methods of Measurement, 2003.

EN 60601-1-2 (CENELEC): Medical Electrical Equipment, Part 1. General Requirements for Safety - Section 1.2. Collateral Standard: Electromagnetic Compatibility - Requirements and Tests, 2002.

EN 61000-3-2 (CENELEC): EMC - Part 2. Limits for Harmonic Current Emissions (Equipment Input Current  $\leq 16$  A per phase), with Amendment 14, 2000.

EN 61000-3-3 (CENELEC): EMC - Part 3. Limitation of Voltage Fluctuation and Flicker in Low-Voltage Supply Systems for Equipment with Rated Current  $\leq 16$  A, 1998.

EN 61000-4-7 (CENELEC): EMC - Part 4-7 Testing and measurement techniques - General guide on harmonics and interharmonics measurements and instrumentation, for power supply systems and equipment connected thereto: 2002

EN 61000-4-2 (CENELEC): EMC - Part 4. Testing and Measurement Techniques: Section 2. Electrostatic Discharge Immunity Test, with Amendments 1 & 2, 2001.

EN 61000-4-3 (CENELEC): EMC - Part 4. Testing and Measurement Techniques: Section 3. Radiated, Radio-Frequency, Electromagnetic Field Immunity, with Amendments 1 & 2, 2005.

EN 61000-4-4 (CENELEC): EMC - Part 4. Testing and Measurement Techniques: Section 4. Electrical Fast Transient/Burst Immunity Test, 2005.

EN 61000-4-5 (CENELEC): EMC - Part 4. Testing and Measurement Techniques: Section 5. Surge Immunity Test, with Amendments 1 & 2, 2001.

EN 61000-4-6 (CENELEC): EMC - Part 4. Testing and Measurement Techniques: Section 6. Immunity to Conducted Disturbances, Induced by Radio-Frequency Fields, 2005.

EN 61000-4-8 (CENELEC): EMC - Part 4. Testing and Measurement Techniques: Section 8. Power Frequency Magnetic Field Immunity Test, 1994.

Prepared (also subject responsible if other) EWUTHFU		No. 3/0360-FCP 101 3765 Uen		
Approved EWU/PR/HD [Keith Goshia]	Checked	Date 2005-11-29	Rev B	Reference TA8AKRC11819-1

CRITERION TECHNOLOGY

EMC QUALIFICATION TEST REPORT  
051003-964R FOR Ericsson

Sheet 17 of 18

EN 61000-4-11 (CENELEC): EMC - Part 4. Testing and Measurement Techniques; Section 11. Voltage Dips, Short Interruptions and Voltage Variations Immunity Tests, 1999

IEC 61000-6-1: EMC – Part 6-1. Generic standards – Immunity for residential, commercial and light-industrial environments, 9 March 2005.

EN 61000-6-2: EMC- Part 6-2. Generic Standard-Immunity for Industrial Environments, October 2001

EN 61326 (CENELEC): Electrical Equipment for Measurement, Control and Laboratory Use - EMC Requirements, 1998.

7.2 47 CFR FCC PART 15 RADIO FREQUENCY DEVICES: OCT 2004

Subpart A General.

Subpart B Unintentional Radiators.

Subpart C Intentional Radiators.

Subpart D Unlicensed Personal Communications Service Devices.

7.3 47 CFR FCC PART 22 PUBLIC MOBILE SERVICES: OCT 2004

7.4 47 CFR FCC PART 24 PERSONAL COMMUNICATIONS SERVICES: OCT 2004

7.5 JAPAN

VCCI V-3

7.6 CANADA

ICES-001: Interference-Causing Equipment Standard - ISM RF Generators, 1998.

ICES-003: Interference-Causing Equipment Standard - Digital Apparatus, 2004.

7.7 AUSTRALIA/NEW ZEALAND

SAA AS/NZ 3548: Limits and Methods of Measurement of Radio Disturbance Characteristics of ITE, 1997.

AS/NZS CISPR22

7.8 CHINA

CNS13438, 1997.

Prepared (also subject responsible if other) EWUTHFU		No. 3/0360-FCP 101 3765 Uen		
Approved EWU/PR/HD [Keith Goshia]	Checked	Date 2005-11-29	Rev B	Reference TA8AKRC11819-1

**THIS PAGE INTENTIONALLY LEFT BLANK**

Prepared (also subject responsible if other) EWUTHFU		No. 3/0360-FCP 101 3765 Uen		
Approved EWU/PR/HD [Keith Goshia]	Checked	Date 2005-11-29	Rev B	Reference TA8AKRC11819-1

Name of Test: Frequency Stability – Temperature and Voltage Variation

Paragraph: 47 CFR 2.1055

Guide: EIA Standard RS 152B, Paragraph 10

Test Condition: Standard

1. Measurement Results: No data was captured due to the fact that this is a permissive change submittal and the actual Frequency Stability – Temperature and Voltage Variation data is contained inside the original submittal. Additionally, the WCDMA Radio Base Station operates using a frequency reference from the backhaul or a GPS receiver. If the frequency reference is lost the RBS signal will wilt. With this architecture, the RF portion of the system operates within 50 ppb of absolute in compliance with the 3GPP TS 25.141 technical standard for frequency accuracy.

Prepared (also subject responsible if other) EWUTHFU		No. 3/0360-FCP 101 3765 Uen		
Approved EWU/PR/HD [Keith Goshia]	Checked	Date 2005-11-29	Rev B	Reference TA8AKRC11819-1

Name of Test: Necessary Bandwidth and Emission Bandwidth

Paragraph: 47 CFR 2.202 (g)

Modulation = WCDMA (F9W)

$$\begin{aligned} &\text{Emission Bandwidth Calculation:} \\ &\text{Necessary Bandwidth, kHz} = 4,170.00 \end{aligned}$$

Justification for WCDMA bandwidth of 4.17 MHz.

Reference: 3GPP TS 25.141.

Chip rate is 3.840MHz per the 3GPP standard. At the 3dB down point, the bandwidth is 4.2MHz. Channel spacing is normally set to 5.0MHz from center frequency to center frequency.

Prepared (also subject responsible if other) EWUTHFU		No. 3/0360-FCP 101 3765 Uen		
Approved EWU/PR/HD [Keith Goshia]	Checked	Date 2005-11-29	Rev B	Reference TA8AKRC11819-1

Testimonial and Statement of Certification
--

This is to certify:

1. That the application was prepared either by, or under the direct supervision of, the undersigned.
2. That the technical data supplies with the application were taken under my direction and supervision.
3. That the data was obtained on representative units, randomly selected.
4. That, to the best of my knowledge and belief, the facts set forth in the application and accompanying technical data is true and correct.

Certifying Engineer:

Prepared (also subject responsible if other) EWUTHFU		No. 3/0360-FCP 101 3765 Uen		
Approved EWU/PR/HD [Keith Goshia]	Checked	Date 2005-11-29	Rev B	Reference TA8AKRC11819-1

### Radio Frequency Radiation Exposure Limits

The device is installed in a permanent location. It is not operator accessible, and is contained in a secured environment that is accessible by field service engineers or installation engineers only. The ERP of the device is less than 1000 Watts. The Antenna's used on this device are a typical 18dB gain antenna, with this configuration and the maximum RF output of the device set to 40 Watts the exposure limit is less than 1000 Watts.