



# REPORT

Issued by a FCC listed Laboratory Reg. no 93866  
 The test site complies with RSS-Gen, IC file no. 3482A-1  
 Contact person  
**Jörgen Wassholm**  
 Electronics  
 +46 10 516 57 06  
 Jorgen.Wassholm@sp.se

Date 2013-12-03 Reference 3P06431-03-F24 Page 1 (2)



Ericsson AB  
 Klaes Holm  
 PDU HW  
 164 80 Stockholm

## Radio measurements on AIR B2A B12P B8P 1900 MHz radio equipment with FCC ID: TA8AKRC118055-1 and IC: 287AB-AS1180551

(8 appendices)

### Test object

Product name: AIR 21 B2A B12P B8P  
 Product number: KRC 118 055/1, R1A

### Summary

See appendix 1 for general information and appendix 8 for external photos.

Standard	Compliant	Appendix
<b>FCC CFR 47 / IC RSS-133 Issue 6</b>		
2.1046 / RSS-133 6.4 RF power output	Yes	2
2.1049 / RSS-Gen 4.6.1 Occupied bandwidth	Yes	3
2.1051 / RSS-133 6.5 Band edge	Yes	4
2.1051 / RSS-133 6.5 Spurious emission at antenna terminals	Yes	5
2.1053 / RSS-133 6.5 Field strength of spurious radiation	Yes	6
2.1055 / RSS-133 6.3 Frequency stability	Yes	7

Note: Above RSS-133 items are given as cross-reference only. Measurements were performed according to ANSI procedures referenced by FCC and covered by SP's accreditation.

### SP Technical Research Institute of Sweden

#### Electronics – EMC

Performed by

Jörgen Wassholm

Examined by

Anders Nordlöf

### SP Technical Research Institute of Sweden

Postal address SP  
 Box 857  
 SE-501 15 BORÅS  
 Sweden

Office location Västeråsen  
 Brinellgatan 4  
 SE-504 62 BORÅS

Phone / Fax / E-mail  
 +46 10 516 50 00  
 +46 33 13 55 02  
 info@sp.se

Laboratories are accredited by the Swedish Board for Accreditation and Conformity Assessment (SWEDAC) under the terms of Swedish legislation. This report may not be reproduced other than in full, except with the prior written approval of the issuing laboratory.

## Table of contents

Description of the test object	Appendix 1
Operation modes during measurements	Appendix 1
Test frequencies and setups	Appendix 1
Purpose of test	Appendix 1
RF power output	Appendix 2
Occupied bandwidth	Appendix 3
Band edge	Appendix 4
Spurious emission at antenna terminals	Appendix 5
Field strength of spurious radiation	Appendix 6
Frequency stability	Appendix 7
External photos	Appendix 8

## Appendix 1

**Description of the test object**

Equipment:	Product name: AIR 21 B2A B12P B8P Product number KRC 118 055/1 FCC ID: TA8AKRC118055-1 IC: 287AB-AS1180551 IC MODEL NO: AS1180551
Tested configuration:	GSM single RAT
Frequency range:	TX: 1930 – 1990 MHz RX: 1850 – 1910 MHz
Antenna ports:	2 TX/RX ports, (internally connected to integrated Cross-Polarized antenna elements).
RF configuration:	Single and multi carrier
Nominal RF output power per antenna port:	Single carrier: 1x 44.8 dBm (1x 30W) Multi carrier: 2x 41.8 dBm (2x 15W) 4x 38.8 dBm (4x 7.5W)
Antenna type:	Cross- polarized antenna
Antenna gain:	18 dBi
Modulations:	GMSK, 8-PSK, 16QAM, 32QAM and AQPSK.
Nominal supply voltage:	-48 VDC

## Appendix 1

### Operation mode during measurements

Measurements were performed with the test object transmitting following modulations: GMSK, AQPSK, 8-PSK, 16QAM and 32QAM.

Unless otherwise stated, all measurements were performed with the test object transmitting pseudorandom data in all timeslots and settings for maximum transmitter output power applicable for each configuration. For AQPSK modulation the SCPIR is 0 dB.

The settings below were deemed representative for all traffic scenarios when settings with different modulations, channel bandwidths, number of carriers and RF configurations has been tested to find the worst case setting. The settings below were used for all measurements if not otherwise noted.

Single carrier, GMSK modulation.  
Multi carrier, GMSK modulation.

### Conducted measurements

The test object was pole mounted and powered with -48 VDC by an external power supply, unless noted otherwise. All TX parameters were measured at port RF A with port RF B terminated into 50 ohm. Complete measurements were made on RF A with additional measurements on RF B to verify that the ports are identical.

### Radiated measurements

The test object was pole mounted and powered with -48 VDC by an external power supply. Both RF ports were terminated into 50 ohm.

### Purpose of test

The purpose of the tests is to verify compliance to the performance characteristics specified in applicable parts of FCC CFR 47, IC RSS-133 and IC RSS-Gen.

### References

Measurements were done according to relevant parts of the following standards:

ANSI C63.4-2009

ANSI/TIA/EIA-603-C-2004

3GPP TS 36.141, version 11.4.0

CFR 47 part 2, October 1<sup>st</sup>, 2012

CFR 47 part 24 Subpart E, October 1<sup>st</sup>, 2012

RSS-Gen Issue 3

RSS-133 Issue 6

## Appendix 1

### **Uncertainties**

Measurement and test instrument uncertainties are described in the quality assurance documentation "SP-QD 10885". The uncertainties are calculated with a coverage factor  $k=2$  (95% level of confidence).

Compliance evaluation is based on a shared risk principle with respect to the measurement uncertainty.

### **Reservation**

The test results in this report apply only to the particular test object as declared in the report.

### **Delivery of test object**

The test object was delivered 2013-10-10.

### **Manufacturer's representative**

Christer Gustavsson, Ericsson AB.

### **Test engineers**

Andreas Johnson, Hyder Khalaf, Kexin Chen, Tomas Lennhager, Tomas Isbring and Jörgen Wassholm, SP.

### **Test participant**

None.

Appendix 1

**Measurement equipment**

	Calibration Due	SP number
Test site Tesla	2014-01	503 881
R&S FSIQ 40	2014-07	503 738
R&S ESU 26	2014-05	901 553
R&S FSQ 40	2014-03	504 143
Control computer with R&S software EMC32 version 8.52.0	-	503 899
High pass filter	2014-07	901 501
High pass filter	2014-07	901 502
High pass filter	2014-07	504 199
High pass filter	2014-09	901 373
High pass filter	2014-09	503 739
High pass filter	2014-07	503 740
RF attenuator	2014-07	504 159
RF attenuator	2014-07	900 233
RF attenuator	2014-07	900 691
RF attenuator	2014-07	901 384
RF attenuator	2013-12	901 508
Chase Bilog Antenna CBL 6111A	2014-10	503 182
EMCO Horn Antenna 3115	2015-09	502 175
Std.gain horn FLANN model 20240-20	-	503 674
µComp Nordic, Low Noise Amplifier	2014-04	901 545
Miteq Low Noise Amplifier	2014-09	503 285
Schwartzbeck preamplifier BBV 9742	2014-14	504 085
Temperature and humidity meter, Testo 635	2014-06	504 203
Temperature and humidity meter, Testo 625	2014-06	504 188
Temperature Chamber	2013-11	501 031
Multimeter Fluke 87	2014-08	502 190

Appendix 1

**Test frequencies used for radiated measurements**

1 – Carrier:

Port A ARFCN (Frequency) Downlink	Port B ARFCN (Frequency) Downlink	Symbolic Name
513 (1930.4 MHz)	538 (1935.4 MHz)	B
648 (1957.4 MHz)	673 (1962.4 MHz)	M-13
809 (1989.6 MHz)	784 (1984.6 MHz)	T

2 – Carrier:

Port A ARFCN (Frequency) Downlink	Port B ARFCN (Frequency) Downlink	Symbolic name
513 (1930.4 MHz)	533 (1934.4 MHz)	B2
523 (1932.4 MHz)	543 (1936.4 MHz)	
809 (1989.6 MHz)	789 (1985.6 MHz)	T2
799 (1987.6 MHz)	779 (1983.6 MHz)	

4 – Carrier:

Port A ARFCN (Frequency) Downlink	Port B ARFCN (Frequency) Downlink	Symbolic name
513 (1930.4 MHz)	533 (1934.4 MHz)	B4
518 (1931.4 MHz)	538 (1935.4 MHz)	
523 (1932.4 MHz)	543 (1936.4 MHz)	
528 (1933.4 MHz)	548 (1937.4 MHz)	

Appendix 1

**Test frequencies used for conducted measurements**

1 – Carrier:

Port A + B ARFCN (Frequency) Downlink	Symbolic name
513 (1930.4 MHz)	B
661 (1960.0 MHz)	M
809 (1989.6 MHz)	T

2 – Carrier:

Port A + B ARFCN (Frequency) Downlink	Symbolic name
513 (1930.4 MHz)	B2im1
522 (1932.2 MHz)	
561 (1940 MHz)	B2im2
617 (1951.2 MHz)	
659 (1959.6 MHz)	M2
664 (1960.6 MHz)	
809 (1989.6 MHz)	T2im1
800 (1987.8 MHz)	
761 (1980.0 MHz)	T2im2
705 (1968.8 MHz)	



Appendix 1

4 – Carrier:

Port A + B ARFCN (Frequency) Downlink	Symbolic name
513 (1930.4 MHz)	B4
522 (1932.2 MHz)	
531 (1934.0 MHz)	
540 (1935.8 MHz)	
809 (1989.6 MHz)	T4
800 (1987.8 MHz)	
791 (1986.0 MHz)	
782 (1984.2 MHz)	

All RX frequencies were configured 80 MHz below the corresponding TX frequency according the applicable duplex offset for the operating band.

Appendix 1

**Test setup conducted measurements GSM**

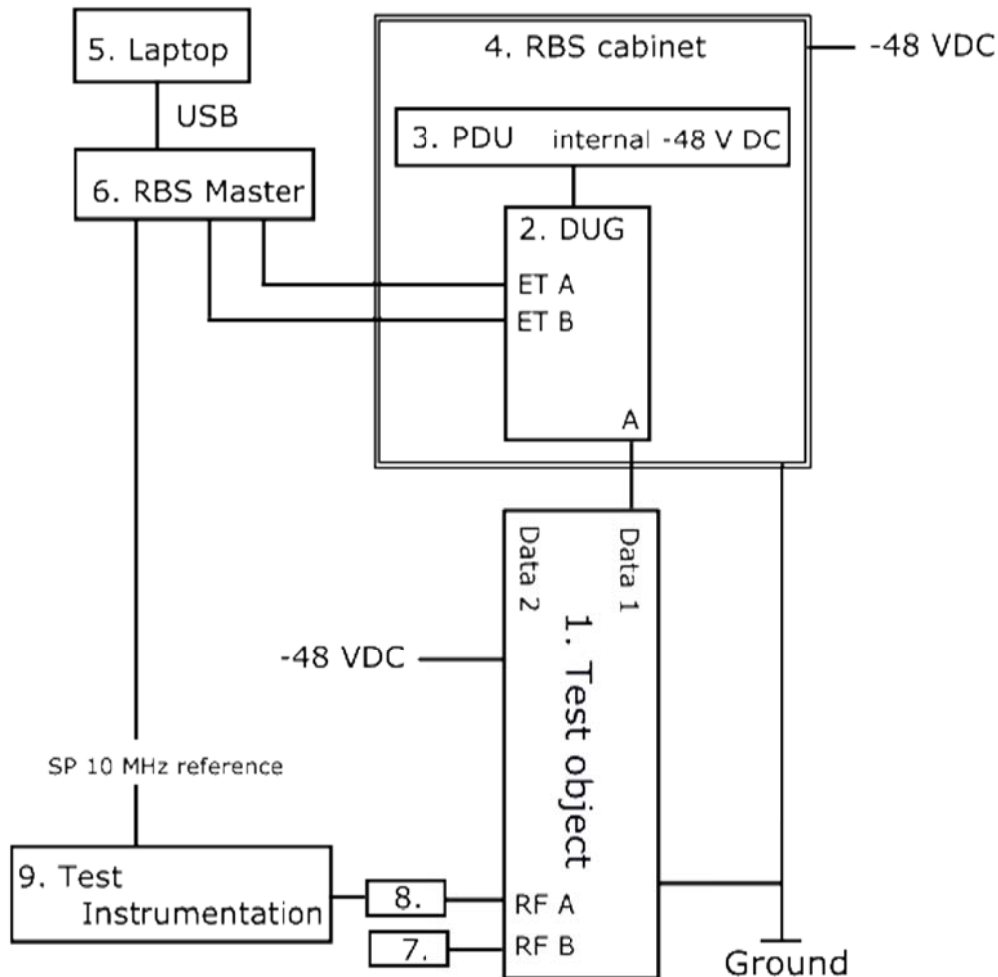

**Test object:**

1.	AIR 21 B2A B12P B8P, KRC 118 055/1, revision R1A, s/n: TM30003022 (FCC ID: TA8AKRC118055-1 / IC: 287AB-AS1180551) with software (PIS): CXP 901 7316/1 rev. R49FF Transceiver, ARUS B2, 1/KRC 118 054, revision R1A
----	--

**Functional test equipment**

2.	DUG 20 01 KDU 137 569/1, R3A, s/n: C826374728
3.	PDU 02 01, BMG 980 336/4, rev: R2A, s/n: BJ31528316
4.	RBS 6201 cabinet, BAMS – 1000778792
5.	Controlling laptop HP EliteBook 8560 w, BAMS – 1001236856
6.	RBS master 2E, LPY 107 1007/3, BAMS – 1001195171
7.	Terminator, 50 ohm
8.	Attenuator, according respective appendix
9.	SP Test Instrumentation according to measurement equipment list

Appendix 1

Test setup radiated measurements GSM

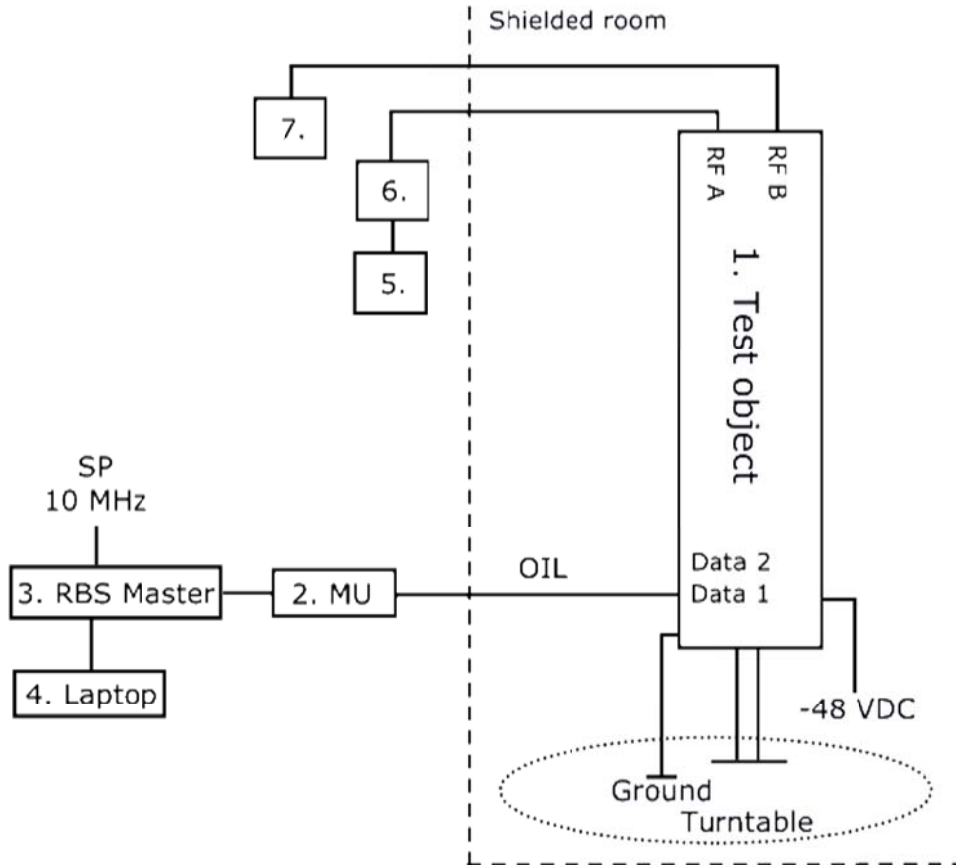

Test object:

1.	AIR 21 B2A B12P B8P, KRC 118 055/1, revision R1A, s/n: TM30003020 (FCC ID: TA8AKRC118055-1 / IC: 287AB-AS1180551) with software (PIS): CXP 901 7316/1 rev. R49FF Transceiver, ARUS B2, 1/KRC 118 054, revision R1A
----	---

Functional test equipment:

2.	Main Unit SUP 6601, 1/BFL 901 009/4, rev. R1E, s/n: BR88236818 DUG 20 01 KDU 137 569/1, R3E, s/n: D169821246
3.	RBS master 2E, LPY 107 1007/3, BAMS – 1000735211
4.	Laptop, EliteBook 8560w, BAMS – 1001236854
5.	ESI 26, SP number: 503 292, for supervision purpose only
6.	Attenuator
7.	Terminator 50 ohm

Appendix 1

<b>Interfaces:</b>	<b>Type of port:</b>
Power: -48 VDC	DC Power
Antenna port (A), (passive antenna), 7/16-connector	Antenna
Antenna port (B), (passive antenna), 7/16-connector	Antenna
Data 1, Optical Interface Link, single mode opto fibre	Signal
Data 2, Optical Interface Link, single mode opto fibre, not in use	Signal
Ground wire	Ground

**RBS software:**

<b>Software</b>	<b>Revision</b>
DXPR73LZ	R50B

Appendix 2

**RF power output measurements according to CFR 47 §24.232 / IC RSS-133 6.4**

Date	Temperature	Humidity
2013-10-21	23 °C ± 3 °C	28 % ± 5 %
2013-10-22	23 °C ± 3 °C	39 % ± 5 %
2013-10-23	23 °C ± 3 °C	46 % ± 5 %
2013-11-03	27 °C ± 3 °C	33 % ± 5 %
2013-11-14	22 °C ± 3 °C	30 % ± 5 %
2013-11-18	22 °C ± 3 °C	26 % ± 5 %

**Test set-up and procedure**

The test object was connected to a signal analyzer measuring peak and RMS output power in CDF mode. A resolution bandwidth of 50 MHz was used.

Measurement equipment	SP number
R&S FSQ 40	504 143
RF attenuator	901 508
Testo 635, temperature and humidity meter	504 203

**Measurement uncertainty:** 1.1 dB

**Results**

Single carrier

Rated output power 1x 44.8 dBm per RF port.

Tested configuration	[RMS dBm/ PAR dB]	
	Port RF A	Port RF B
GMSK, B	44.81/ 0.91	44.77/ 0.91
GMSK, M	44.88/ 0.89	44.87/ 0.89
8PSK, M	44.87/ 3.58	44.86/ 3.61
16QAM, M	44.81/ 4.78	44.80/ 4.83
32QAM, M	44.74/ 4.86	44.75/ 4.83
AQPSK, M	44.42/ 4.01	44.19/ 3.99
GMSK, T	44.85/ 0.91	44.75/ 0.91

Note: The PAR value is the 0.1 % Peak to Average Ratio.

Appendix 2

Multi Carrier

Rated output power 2x 41.8 dBm per RF port.

Tested configuration	Transmitter power [RMS dBm/ PAR dB]
Modulation and symbolic name	Port RF A
GMSK, B2im1	44.79/ 3.61
GMSK M2	44.84/ 3.61
8 PSK, M2	44.82/ 6.08
16 QAM, M2	44.54/ 7.45
GMSK, T2im1	44.79/ 3.61

Rated output power 4 x 38.8 dBm per RF port.

Tested configuration	Transmitter power [RMS dBm/ PAR dB]
Modulation and symbolic name	Port RF A
GMSK, B4	44.80/ 6.18
GMSK, T4	44.89/ 6.20

Single carrier

Measured output power per 1 MHz.

Tested configuration	[RMS dBm]	
	Port RF A	Port RF B
Modulation and symbolic name		
GMSK, B	44.85	44.49
GMSK, M	44.89	44.58
8PSK, M	44.84	44.78
16QAM, M	44.88	44.85
32QAM, M	44.60	44.61
AQPSK, M	44.33	44.33
GMSK, T	44.96	44.66



## Appendix 2

### Limits

§24.232 The maximum output power may not exceed 3280 W/MHz (EIRP).  
The Peak to Average Ratio (PAR) may not exceed 13 dB.

RSS-133 Base station transmitters operating in the band 1930-1995 MHz shall not have output power exceeding 100 watts. When the transmitter power is measured in terms of average value, the peak-to-average ratio(PAR) of the power shall not exceed 13 dB

There is no EIRP limit specified for base station equipment in the RSS-133.

EIRP compliance is addressed at the time of licensing, as required by the responsible IC Bureau. Licensee's are required to take into account the antenna gain to get the maximum usable power settings to prevent the radiated output power to exceed the EIRP limits specified in SRSP-510

Complies?	Yes
-----------	-----

Appendix 3

**Occupied bandwidth measurements according to 47 CFR 2.1049 / IC RSS-Gen 4.6.1**

Date	Temperature	Humidity
2013-10-21	23 °C ± 3 °C	28 % ± 5 %
2013-11-14	22 °C ± 3 °C	30 % ± 5 %

**Test set-up and procedure**

The measurements were made per definition in RSS-Gen 4.6.1. The output was connected to a signal analyzer with the RMS detector activated. The signal analyzer was connected to an external 10 MHz reference standard during the measurements.

Measurement equipment	SP number
R&S FSQ	504 143
RF attenuator	901 508
Testo 635, temperature and humidity meter	504 203

Measurement uncertainty: 3.7 dB

**Results**

Single carrier

Diagram	Modulation	Symbolic name	Tested Port	Occupied BW (99%) [kHz]
1	GMSK	B	RF A	241
2	GMSK	M	RF A	241
3	GMSK	M	RF B	241
4	8PSK	M	RF A	238
5	16QAM	M	RF A	241
6	32QAM	M	RF A	241
7	AQPSK	M	RF A	242
8	GMSK	T	RF A	241



Appendix 3

Diagram 1:

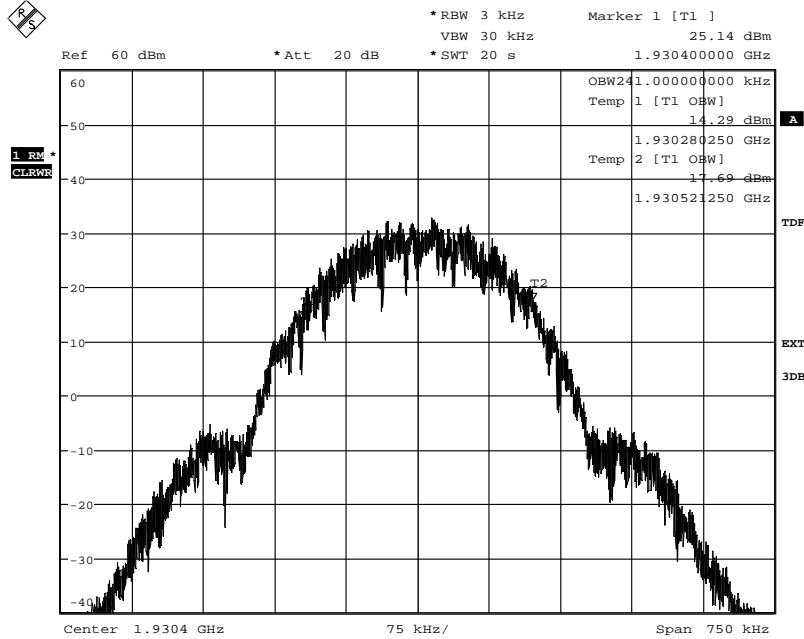

Date: 21.OCT.2013 14:15:25

Diagram 2:

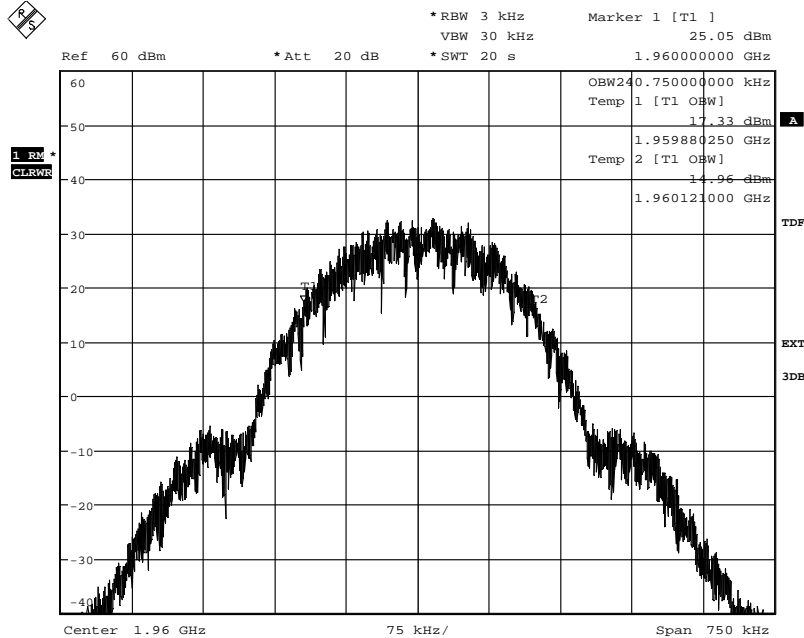

Date: 21.OCT.2013 14:10:22

Appendix 3

Diagram 3:

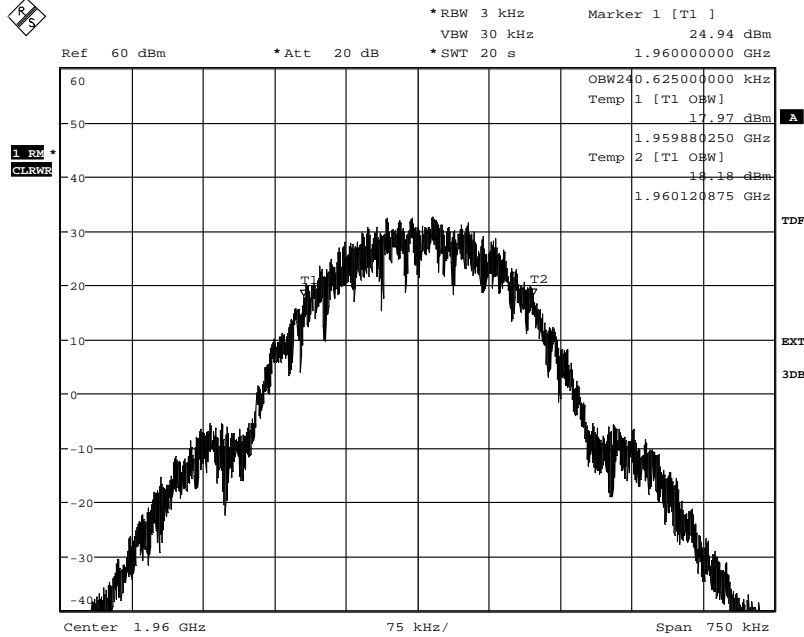

Date: 21.OCT.2013 14:28:17

Diagram 4:

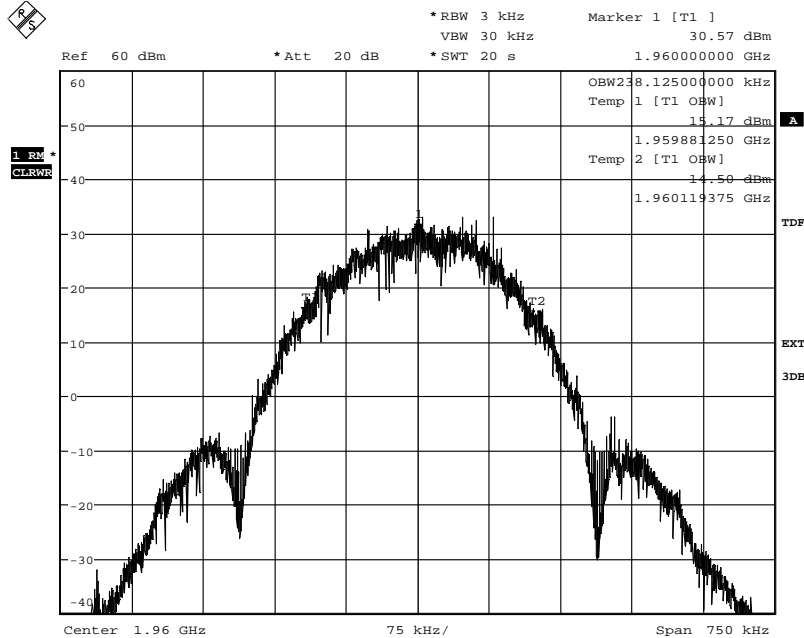

Date: 21.OCT.2013 14:05:45

Appendix 3

Diagram 5:

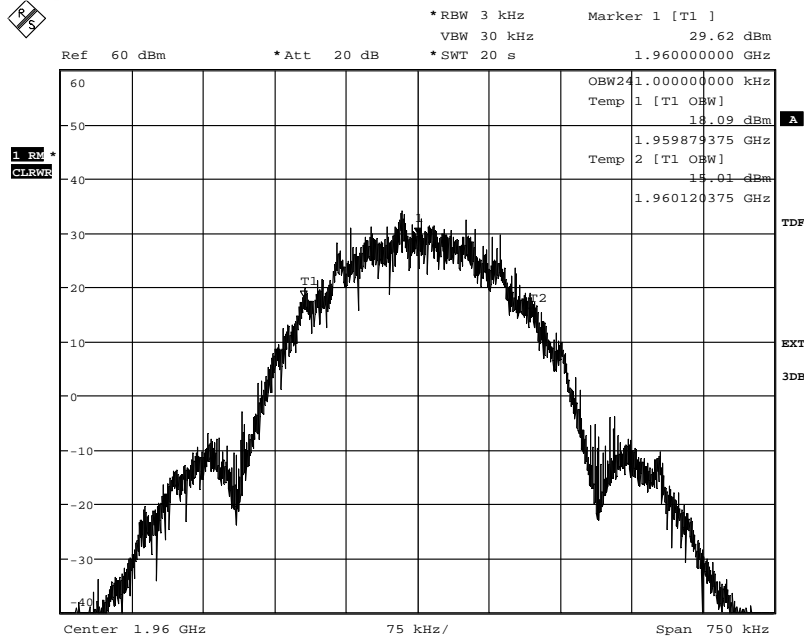

Date: 21.OCT.2013 14:02:23

Diagram 6:

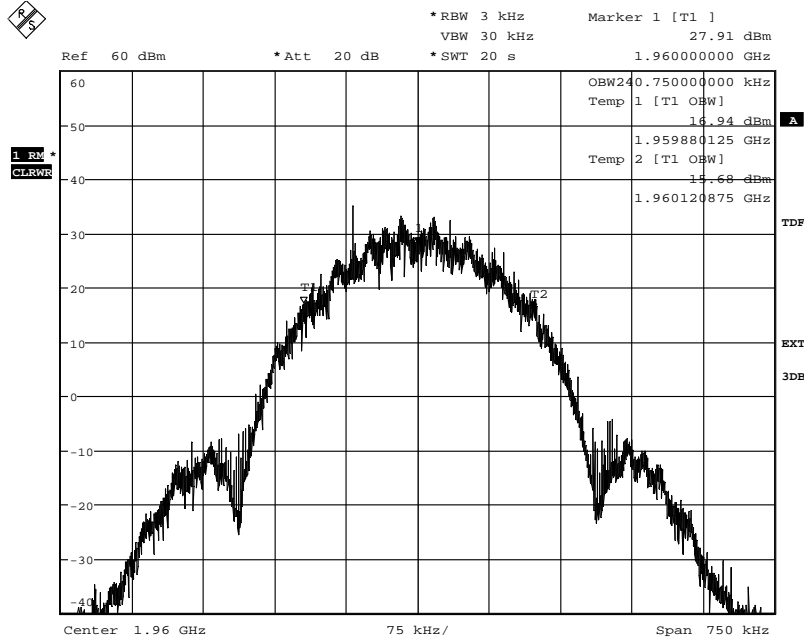

Date: 21.OCT.2013 13:59:41

Appendix 3

Diagram 7:

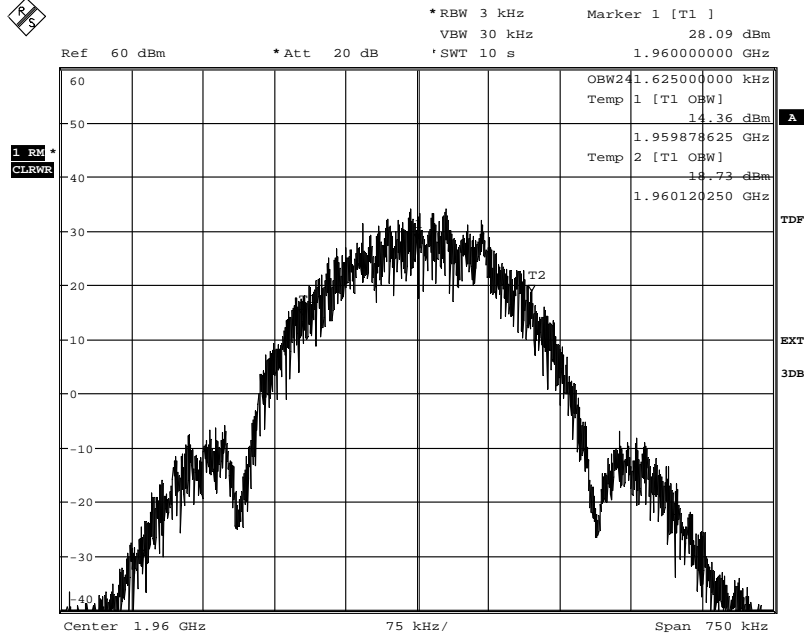

Date: 14.NOV.2013 15:39:17

Diagram 8:

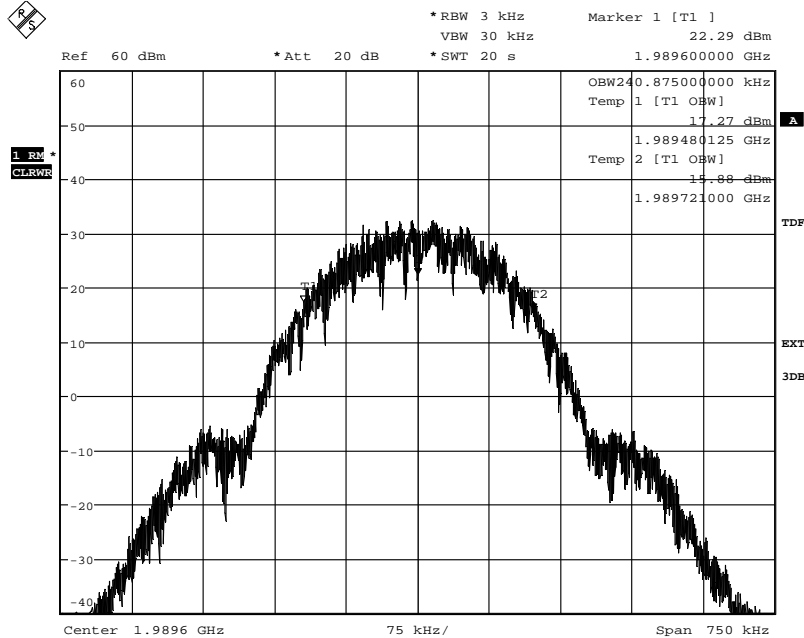

Date: 21.OCT.2013 14:19:35

## Appendix 4

**Band edge measurements according to CFR 47 §24.238 / IC RSS-133 6.5**

Date	Temperature	Humidity
2013-10-21	23 °C ± 3 °C	28 % ± 5 %
2013-10-22	23 °C ± 3 °C	39 % ± 5 %
2013-10-23	23 °C ± 3 °C	46 % ± 5 %

**Test set-up and procedure**

The measurements were made per definition in §24.238. The output was connected to a spectrum analyzer with the RMS detector activated. The spectrum analyzer was connected to an external 10 MHz reference standard during the measurements. A RBW of 3 kHz (>1% of EBW) was used up to 1 MHz away from the band edges, from 1 MHz to 6 MHz away from the band edges a RBW of 50 kHz and 200kHz was used. To compensate for the reduced RBW the limit was adjusted by 13 dB to -26 dBm and -20dBm in this frequency range.

From 1 MHz to 6 MHz away from the band edges a RBW of 200 kHz was used. To compensate for the reduced RBW the limit was adjusted by 13 dB to -26 dBm in this frequency range. A RBW of 1 MHz was used from 6 to 15 MHz away from the band edges.

Measurement equipment	SP number
R&S FSQ 40	504 143
RF attenuator	901 508
Testo 635, temperature and humidity meter	504 203

Measurement uncertainty: 3.7 dB

## Appendix 4

**Results**

## Single carrier

Diagram	Modulation	Symbolic name	Tested Port
1 a-c	GMSK	B	RF A
2 a-c	GMSK	B	RF B
3 a-c	16QAM	B	RF A
4 a-c	GMSK	T	RF A
5 a-c	GMSK	T	RF B
6 a-c	16QAM	T	RF A

## Multi carrier

Diagram	Modulation	Symbolic name	Tested Port
7 a-c	GMSK	B2im1	RF A
8 a-c	GMSK	T2im1	RF A

**Remark**

The channel adjacent to the lower and higher band edge cannot be used. The lowest usable channel is 513 (1930.4 MHz) and the highest usable channel is 809 (1989.6 MHz).

**Limits**

CFR 47 §24.238 and RSS-133 6.5

Outside a licensee's frequency band(s) of operation the power of any emission shall be attenuated below the transmitter power (P) by at least  $43 + 10 \log (P)$  dB, resulting in a limit of -13 dBm.

Complies?	Yes
-----------	-----

Appendix 4

Diagram 1 a:

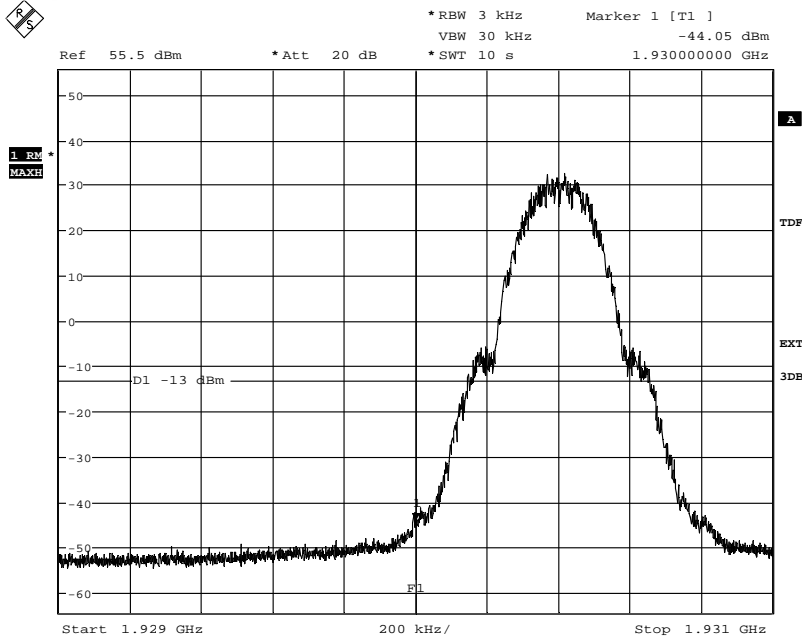

Date: 21.OCT.2013 15:14:52

Diagram 1 b:

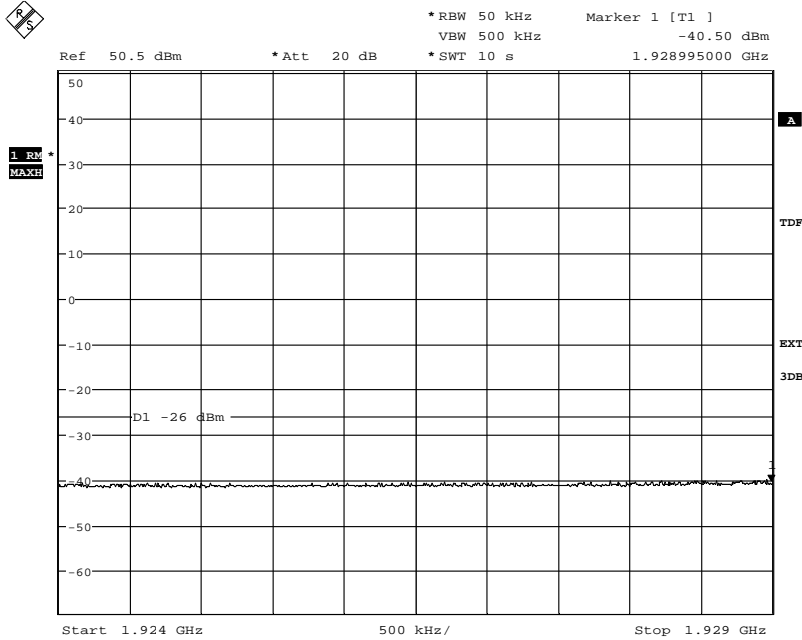

Date: 21.OCT.2013 15:20:34



Appendix 4

Diagram 1 c:

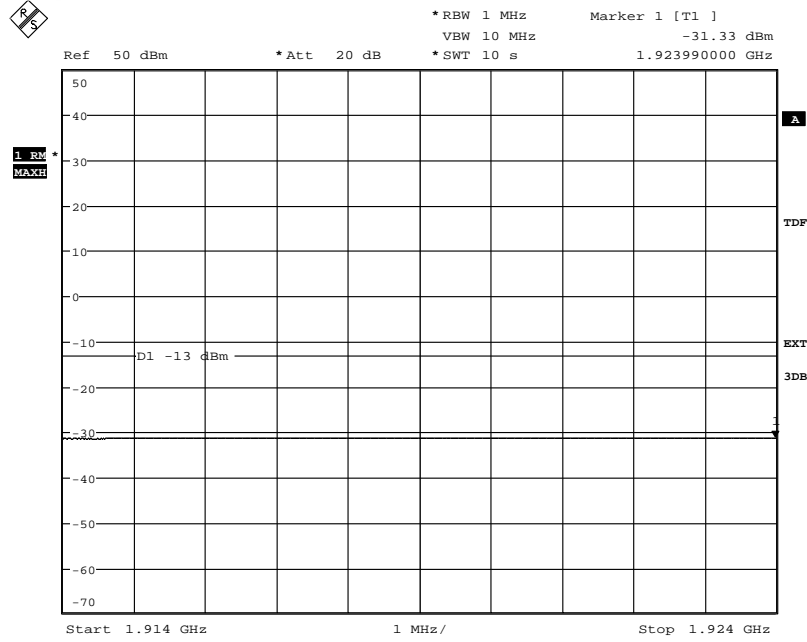

Date: 21.OCT.2013 15:21:44



Appendix 4

Diagram 2 a:

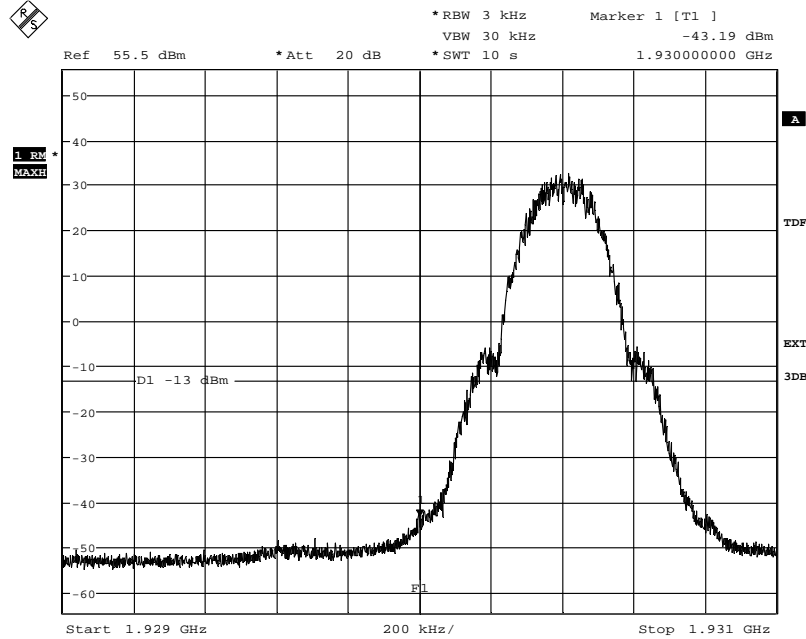

Date: 21.OCT.2013 14:38:39

Diagram 2 b:

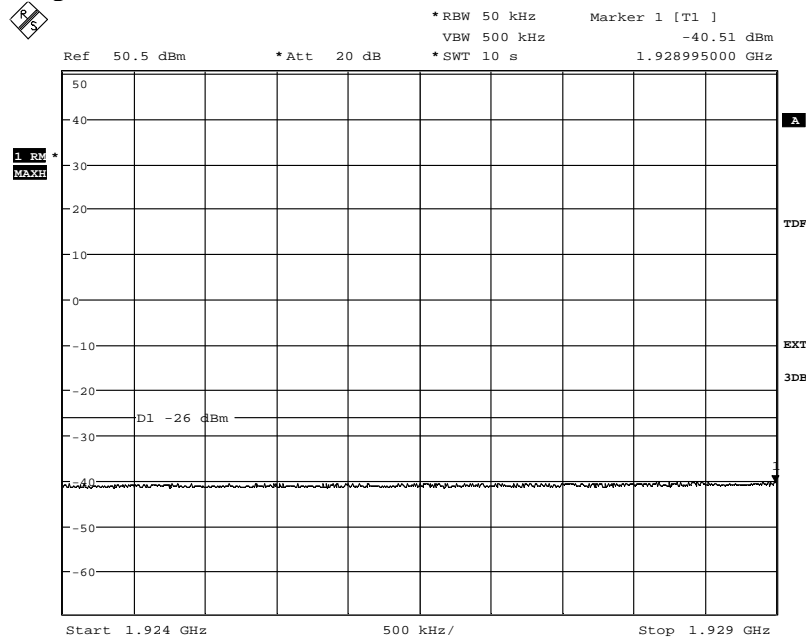

Date: 21.OCT.2013 15:01:16



Appendix 4

Diagram 2 c:

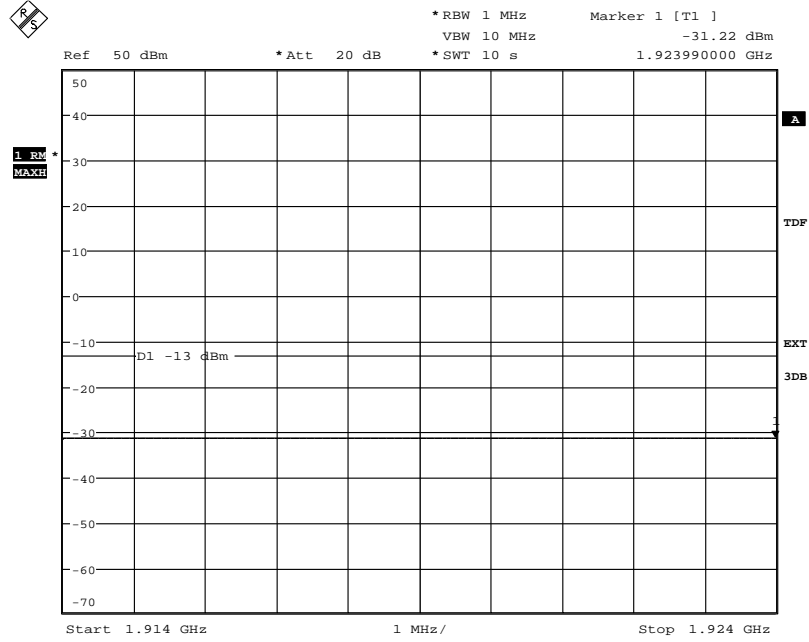

Date: 21.OCT.2013 14:48:29



Appendix 4

Diagram 3 a:

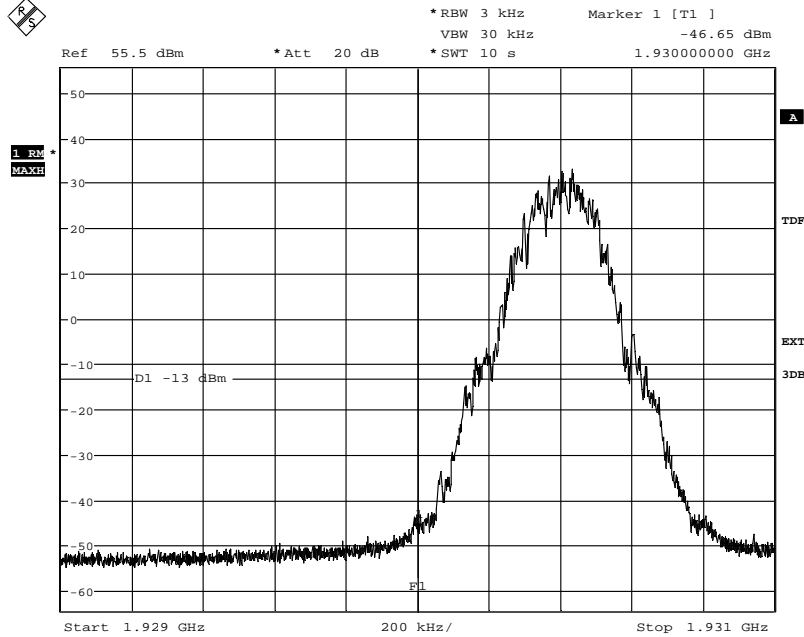

Date: 21.OCT.2013 15:18:14

Diagram 3 b:

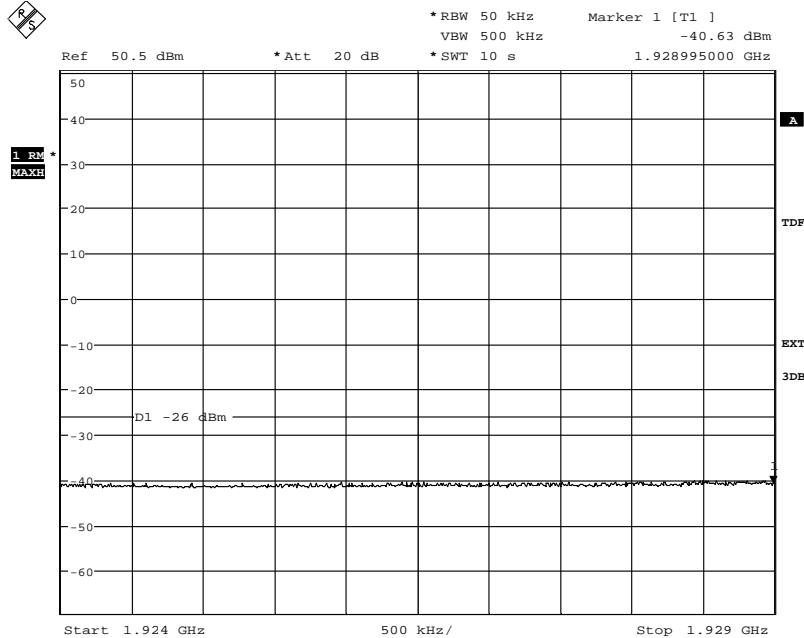

Date: 21.OCT.2013 15:19:15



Appendix 4

Diagram 3 c:

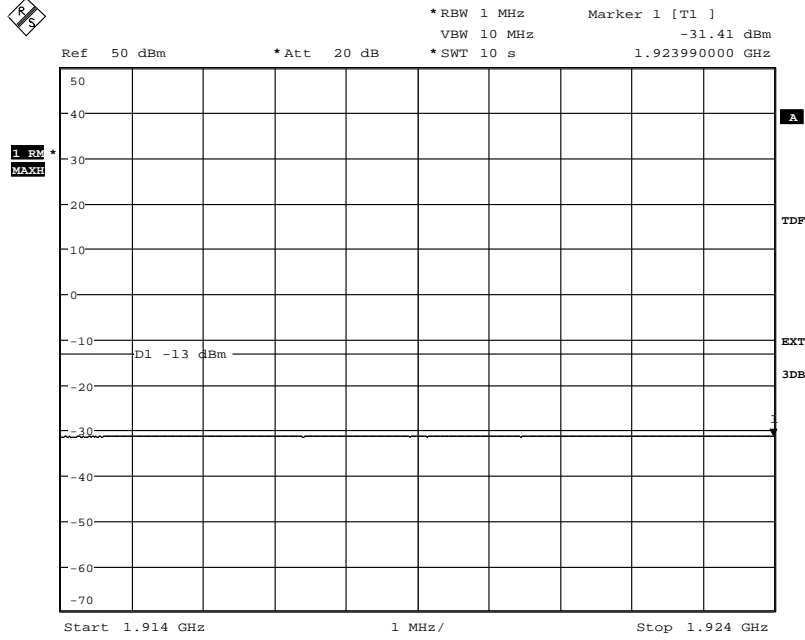

Date: 21.OCT.2013 15:22:47



Appendix 4

Diagram 4 a:

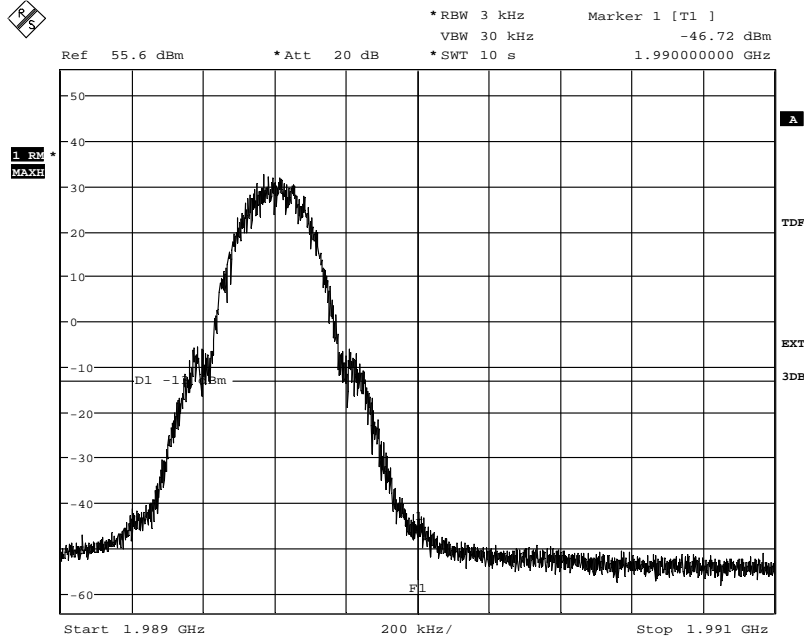

Date: 21.OCT.2013 15:27:27

Diagram 4 b:

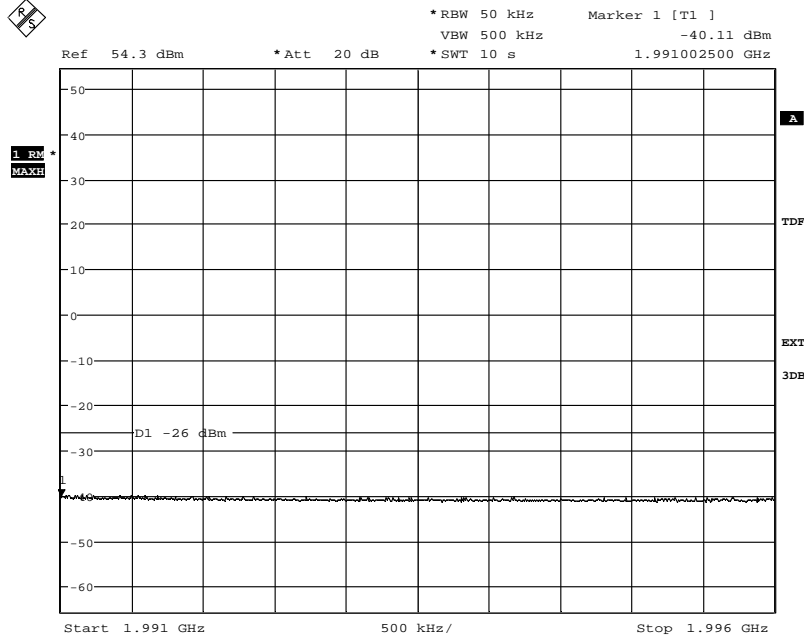

Date: 21.OCT.2013 15:28:48

Appendix 4

Diagram 4 c:

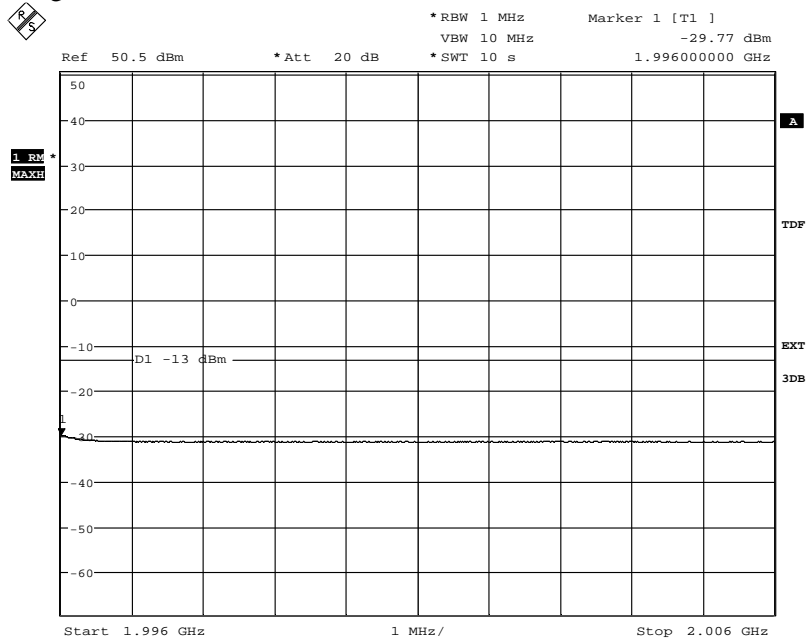

Date: 21.OCT.2013 15:34:14

Appendix 4

Diagram 5 a:

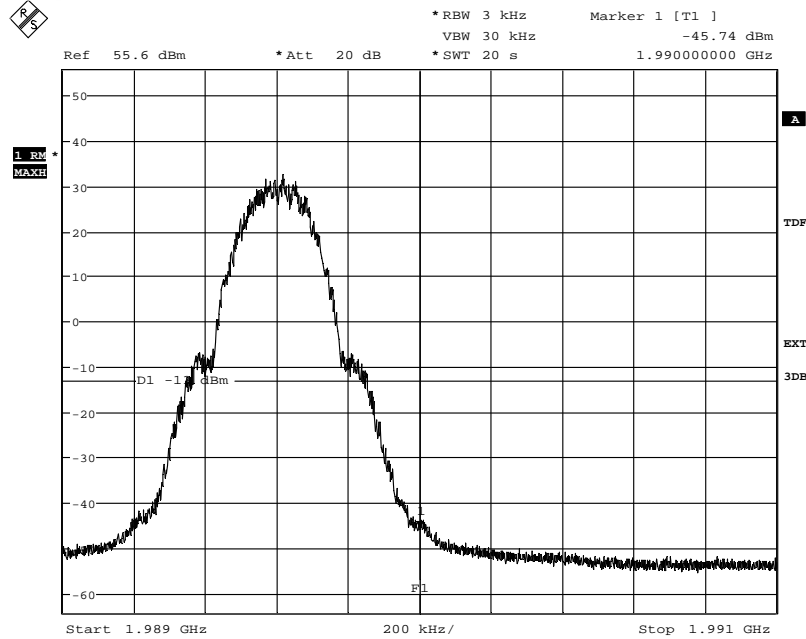

Date: 21.OCT.2013 14:53:27

Diagram 5 b:

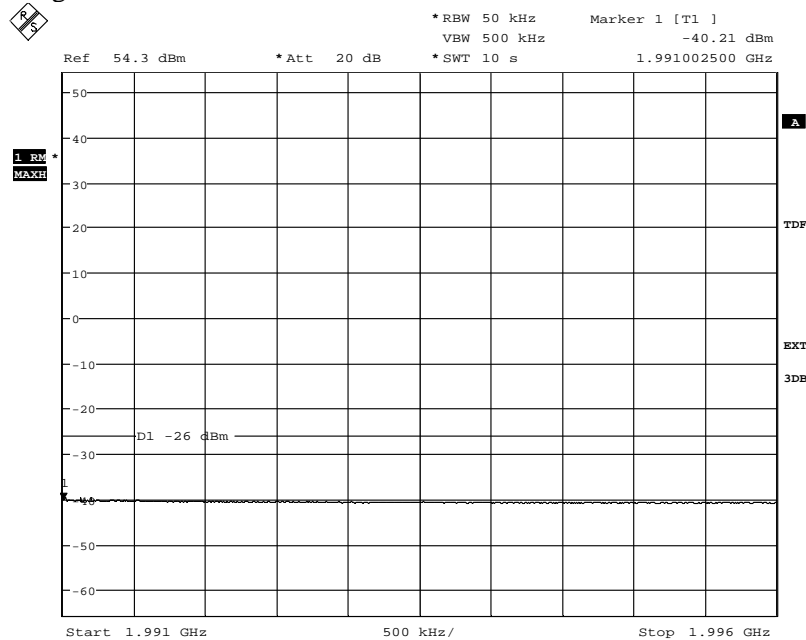

Date: 21.OCT.2013 14:57:35



Appendix 4

Diagram 5 c:

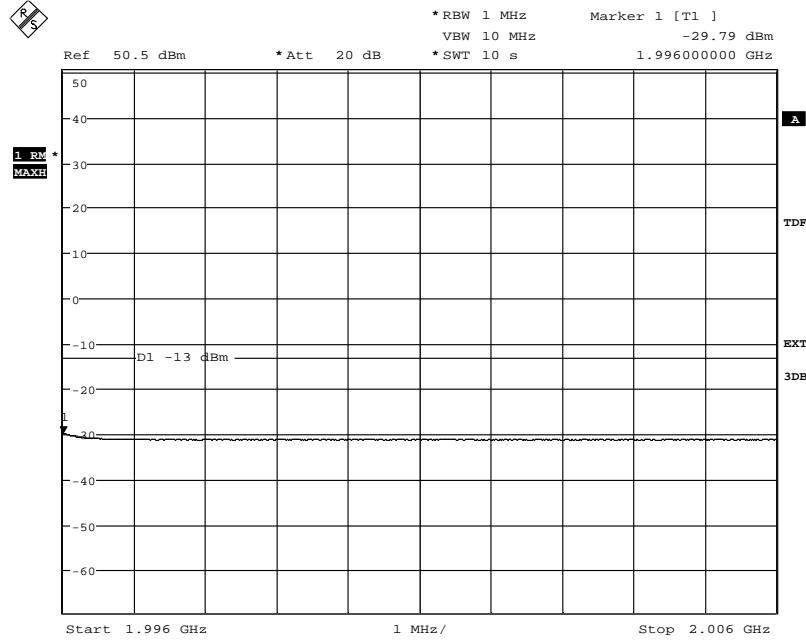

Date: 21.OCT.2013 14:58:49



Appendix 4

Diagram 6 a:

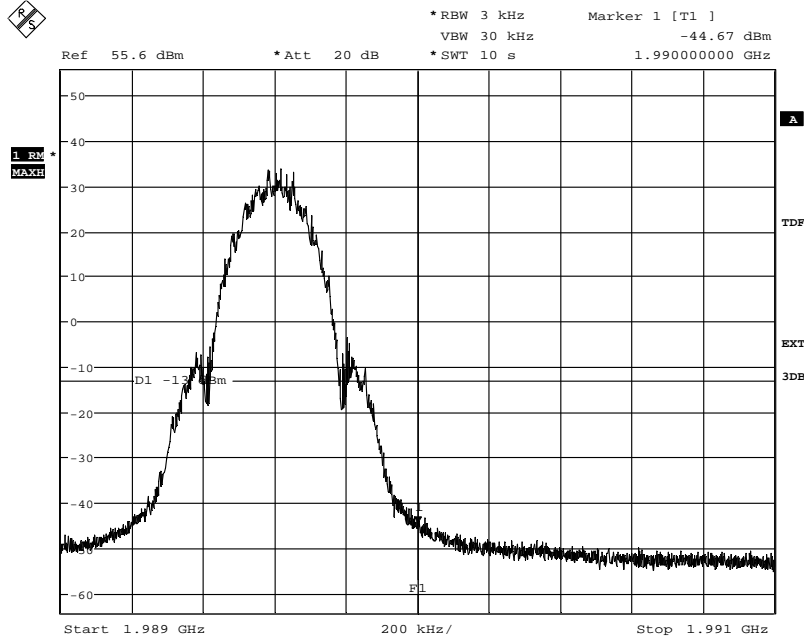

Date: 21.OCT.2013 15:26:02

Diagram 6 b:

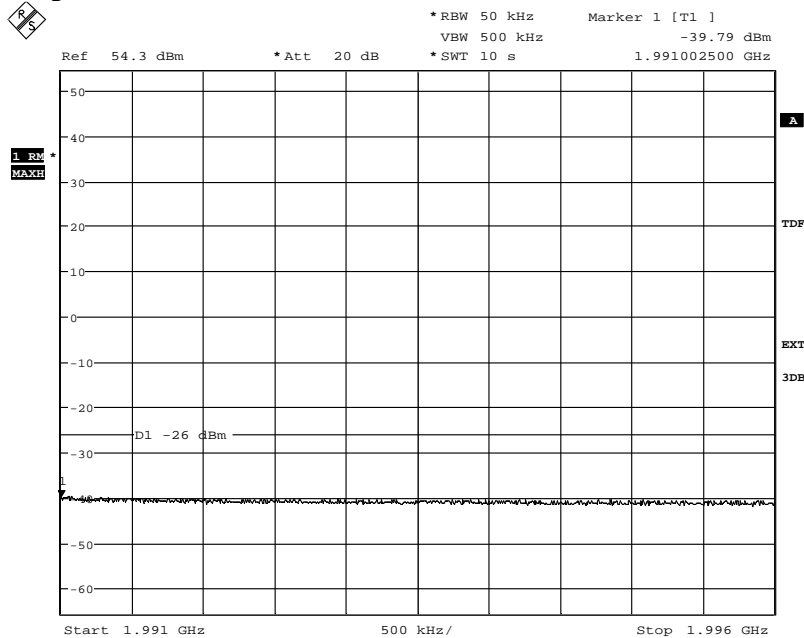

Date: 21.OCT.2013 15:30:05



### Appendix 4

Diagram 6 c:

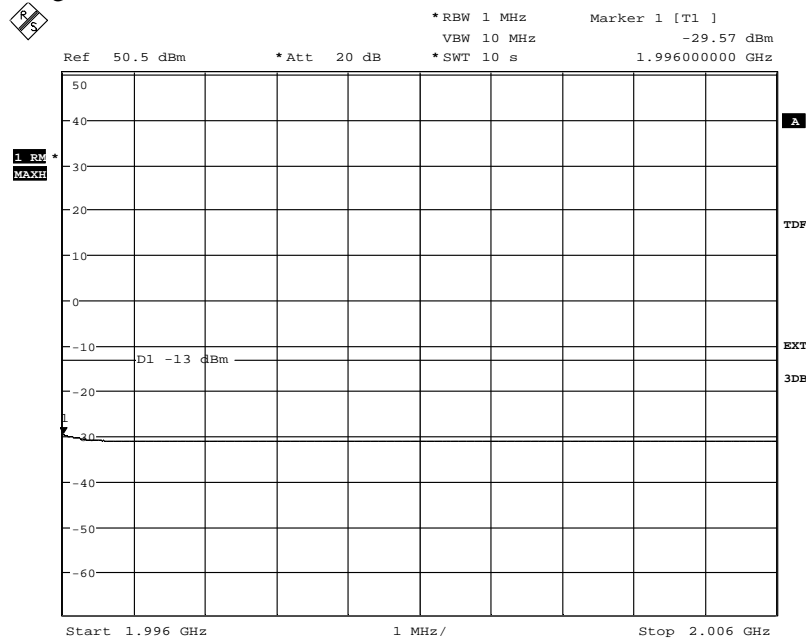

Date: 21.OCT.2013 15:32:48

Appendix 4

Diagram 7 a:

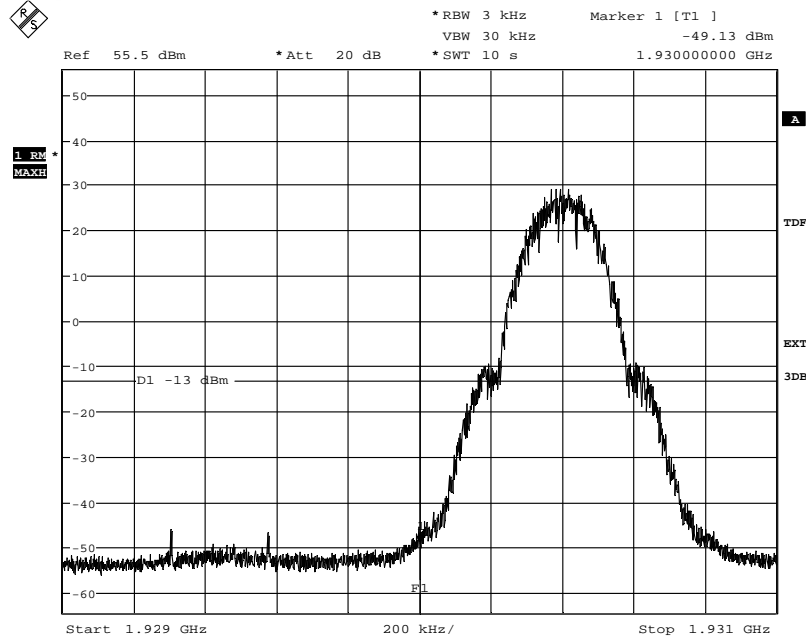

Date: 22.OCT.2013 13:11:52

Diagram 7 b:

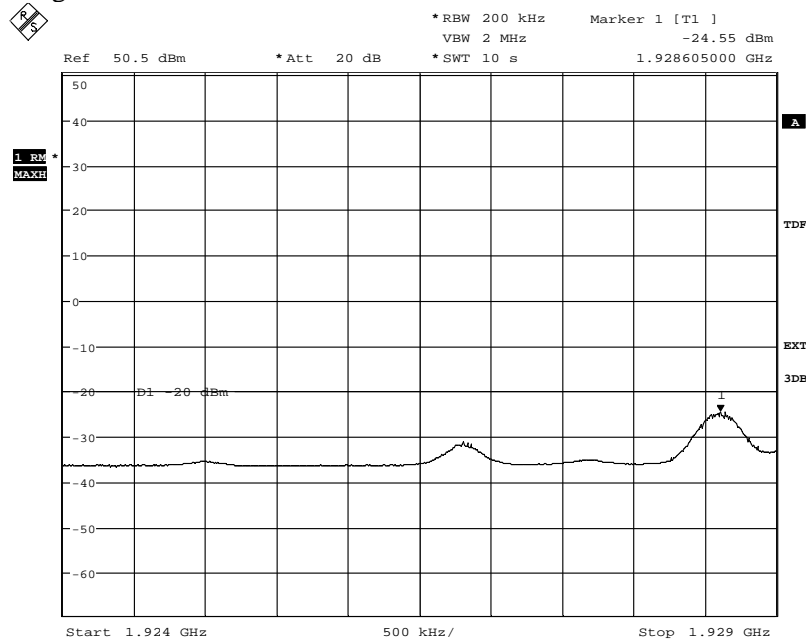

Date: 22.OCT.2013 13:13:01



Appendix 4

Diagram 7 c:

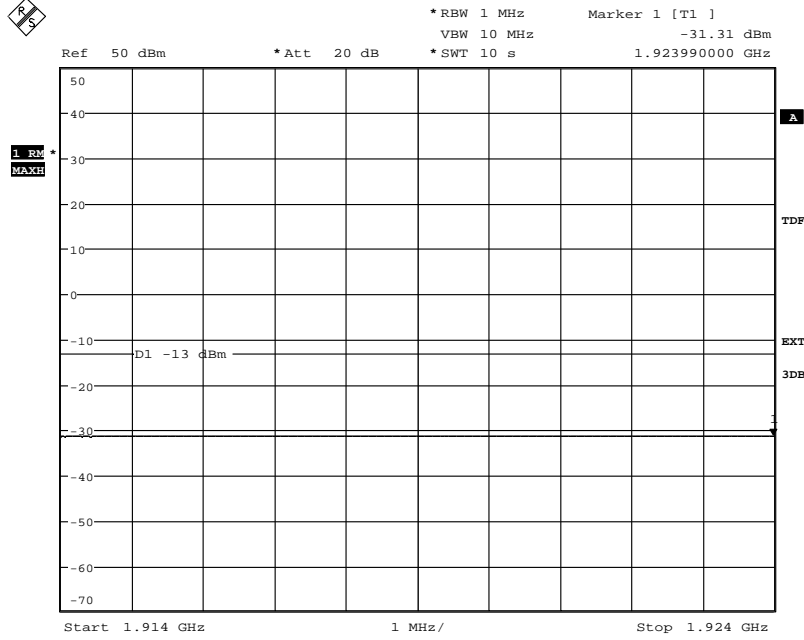

Date: 22.OCT.2013 13:14:12

Appendix 4

Diagram 8 a:

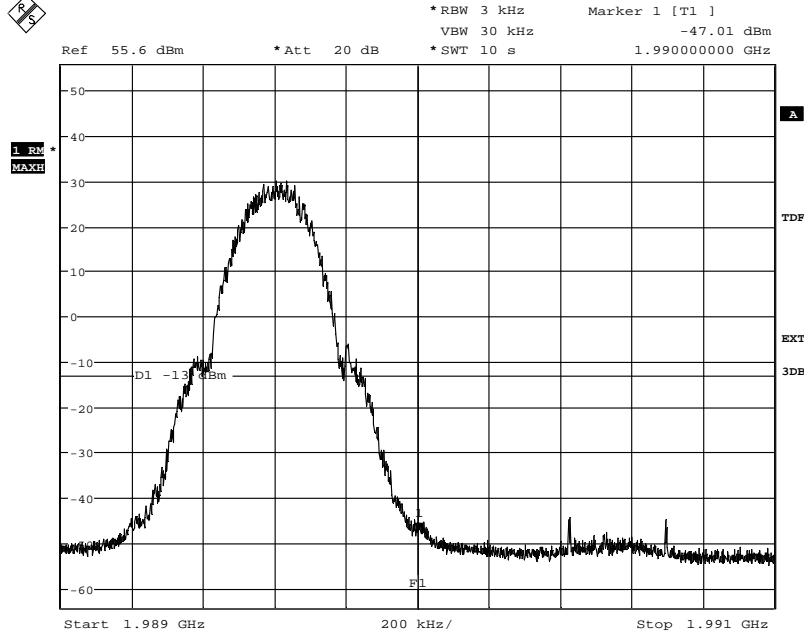

Date: 22.OCT.2013 13:18:31

Diagram 8 b:

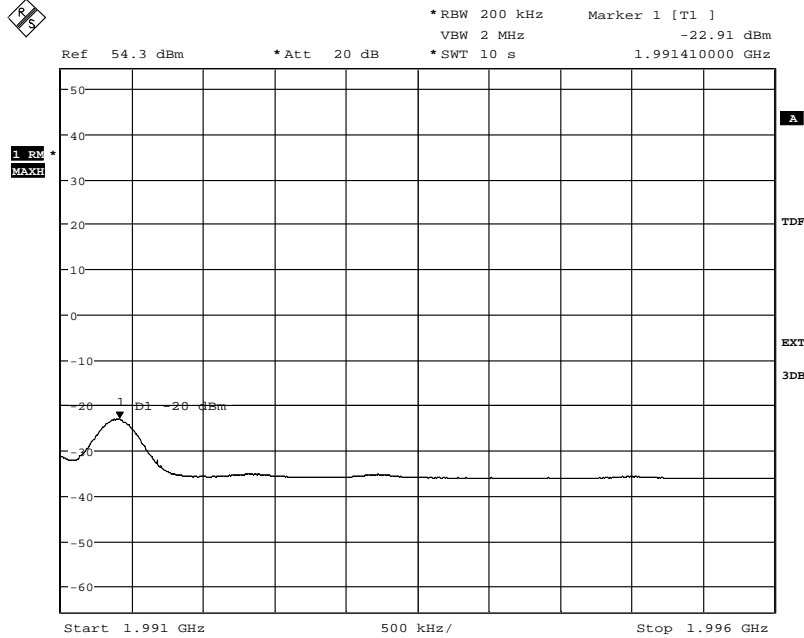

Date: 22.OCT.2013 13:00:04



### Appendix 4

Diagram 8 c:

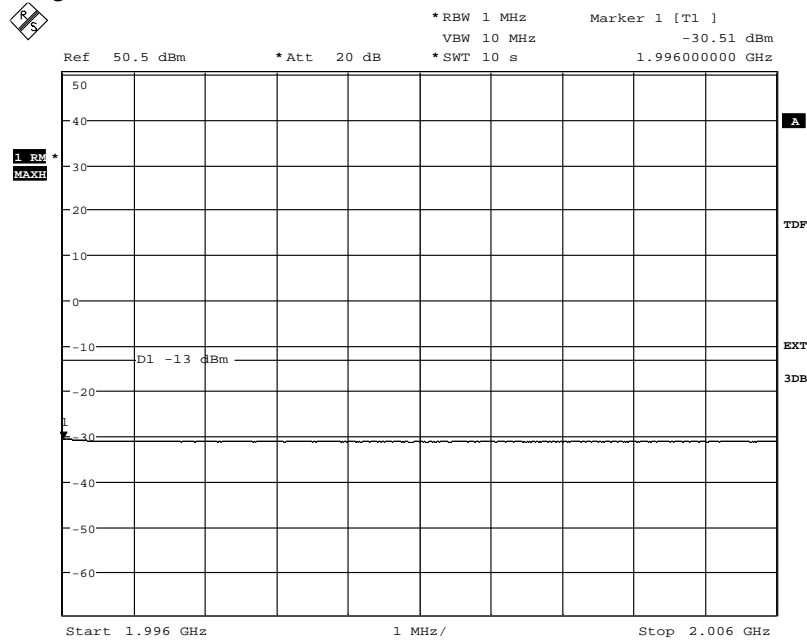

Date: 22.OCT.2013 13:01:34

Appendix 5

**Conducted spurious emission measurements according to CFR 47 §24.238 / IC RSS-133 6.5**

Date	Temperature	Humidity
2013-10-21	23 °C ± 3 °C	28 % ± 5 %
2013-10-22	23 °C ± 3 °C	39 % ± 5 %
2013-10-23	23 °C ± 3 °C	46 % ± 5 %
2013-11-18	22 °C ± 3 °C	26 % ± 5 %

**Test set-up and procedure**

The measurements were made per definition in §24.238. The output was connected to a spectrum analyzer with a RBW setting of 1 MHz and RMS detector activated. The spectrum analyzer was connected to an external 10 MHz reference standard during the measurements.

Measurement equipment	SP number
R&S FSQ 40	504 143
RF attenuator	901 508
HP filter	901 502
Testo 635, temperature and humidity meter	504 203

Measurement uncertainty: 3.7 dB

**Results**

Single carrier

Diagram	Modulation	Symbolic name	Tested Port
1 a+b+c+d	GMSK	B	RF A
2 a+b+c+d	GMSK	M	RF A
3 a+b+c+d	GMSK	M	RF B
4 a+b+c+d	GMSK	T	RF A

## Appendix 5

**Multi carrier**

Diagram	Modulation	Symbolic name	Tested Port
5 a+b+c+d+e	GMSK	B2im1	RF A
6 a+b+c+d+e	GMSK	B2im2	RF A
7 a+b+c+d+e	GMSK	T2im1	RF A
8 a+b+c+d+e	GMSK	T2im2	RF A
9 a+b+c+d+e	GMSK	B4	RF A
10 a+b+c+d+e	GMSK	T4	RF A

Note: Measurements were limited to port RF A due to the measurement result in single carrier mode that shows that the ports are electrical identical as declared by the client.

**Remark**

The emission at 9 kHz on the plots was not generated by the test object. A complementary measurement with a smaller RBW showed that it was related to the LO feed-through.

The highest internal frequency as declared by the client was 1990 GHz, thus the choice of the upper frequency boundary was set to  $10 \times 2 \text{ GHz} = 20 \text{ GHz}$  for emission measurements.

**Limits**

§24.238 and RSS-133 6.5

Outside a licensee's frequency band(s) of operation the power of any emission shall be attenuated below the transmitter power (P) by at least  $43 + 10 \log (P)$  dB, resulting in a limit of -13 dBm per 1 MHz RBW.

Complies?	Yes
-----------	-----



Appendix 5

Diagram 1 a:

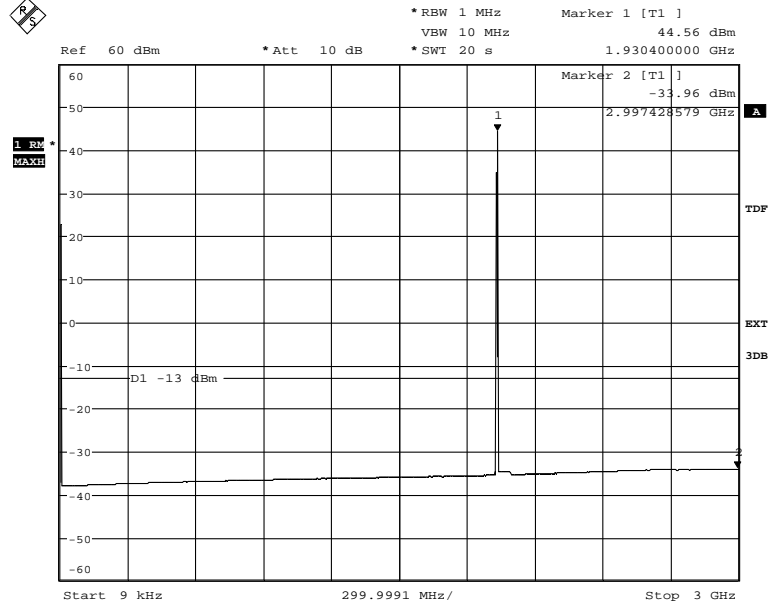

Date: 21.OCT.2013 15:57:53

Diagram 1 b:

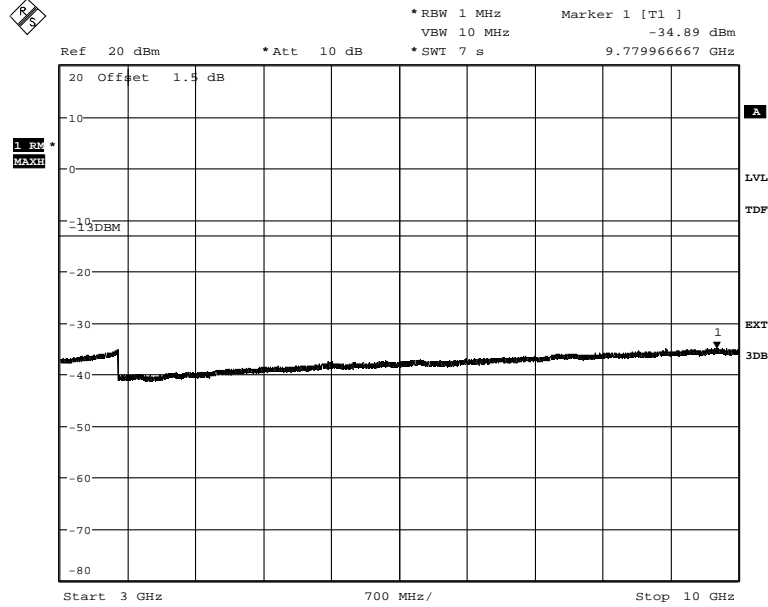

Date: 21.OCT.2013 15:56:18

Appendix 5

Diagram 1 c:

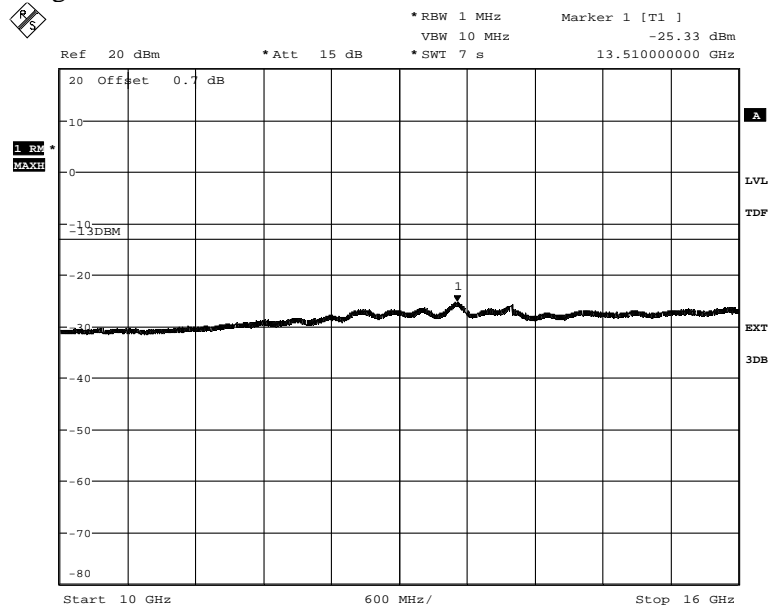

Date: 21.OCT.2013 15:55:24

Diagram 1 d:

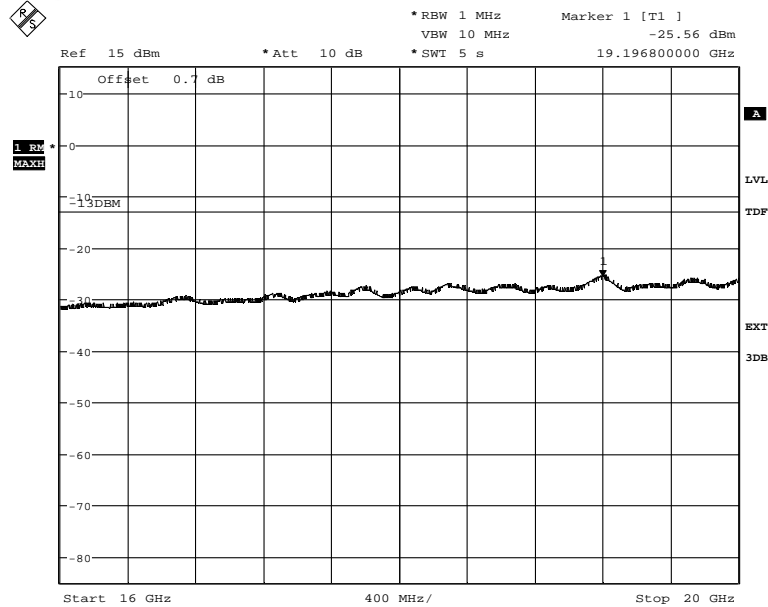

Date: 21.OCT.2013 15:54:19

Appendix 5

Diagram 2 a:

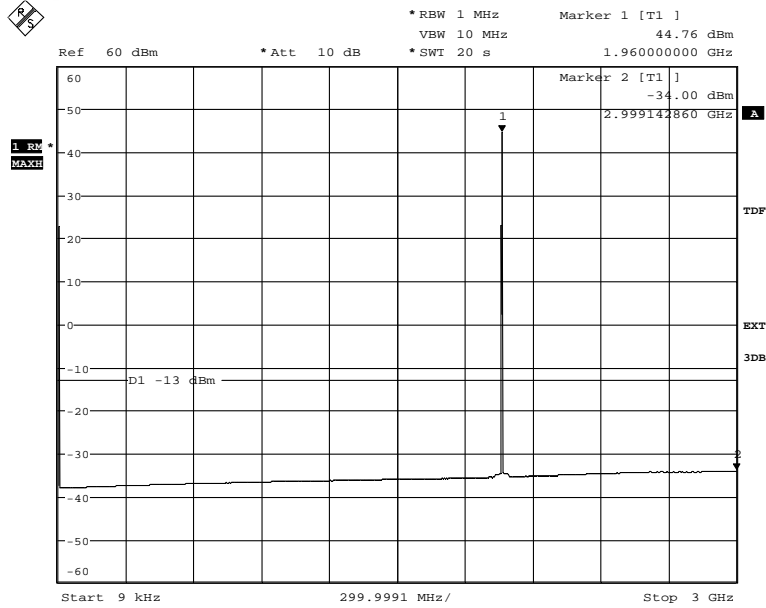

Date: 21.OCT.2013 16:00:47

Diagram 2 b:

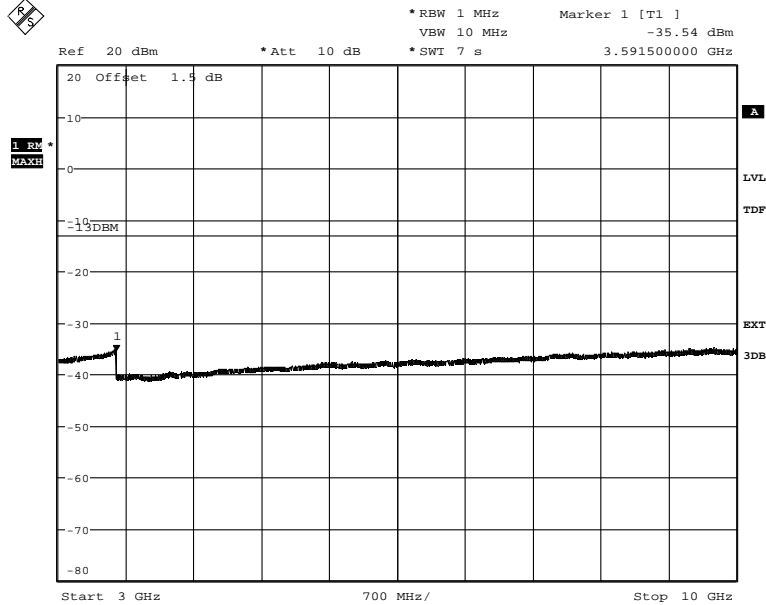

Date: 21.OCT.2013 16:02:21



Appendix 5

Diagram 2 c:

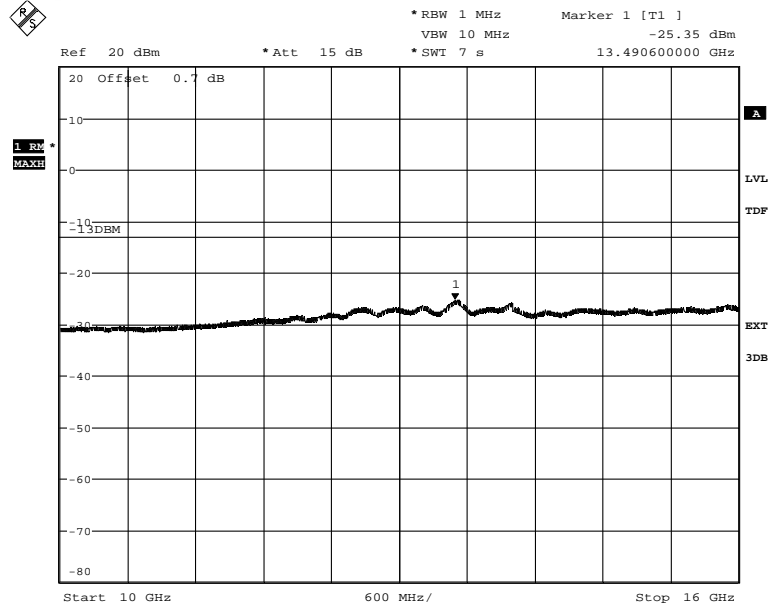

Date: 21.OCT.2013 16:03:15

Diagram 2 d:

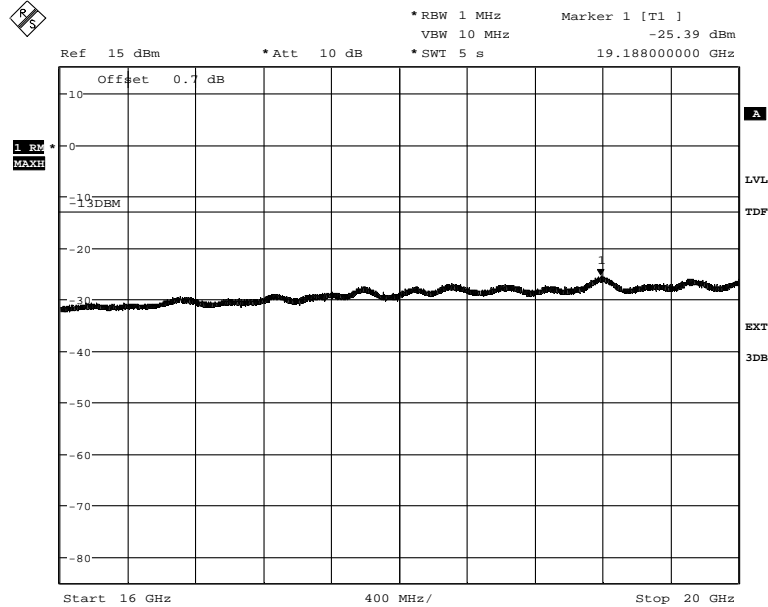

Date: 21.OCT.2013 16:04:20

Appendix 5

Diagram 3 a:

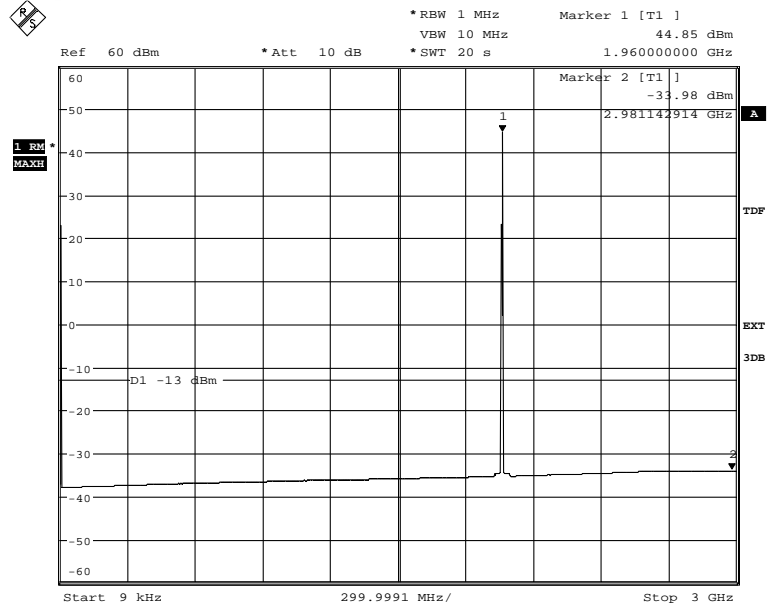

Date: 21.OCT.2013 16:15:46

Diagram 3 b:

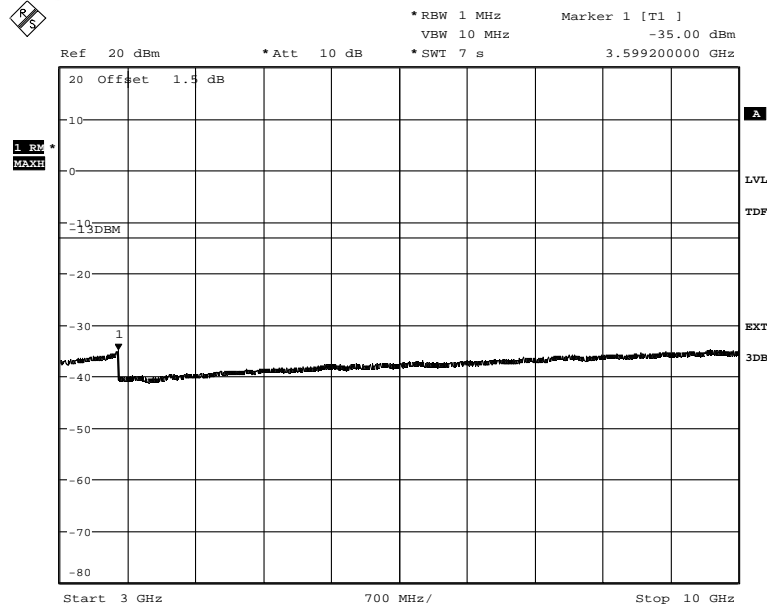

Date: 21.OCT.2013 16:11:40



Appendix 5

Diagram 3 c:

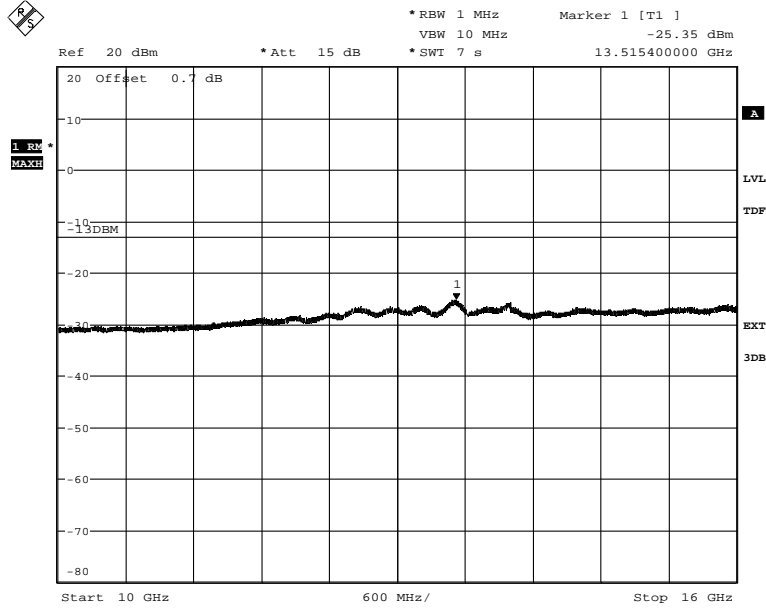

Date: 21.OCT.2013 16:09:53

Diagram 3 d:

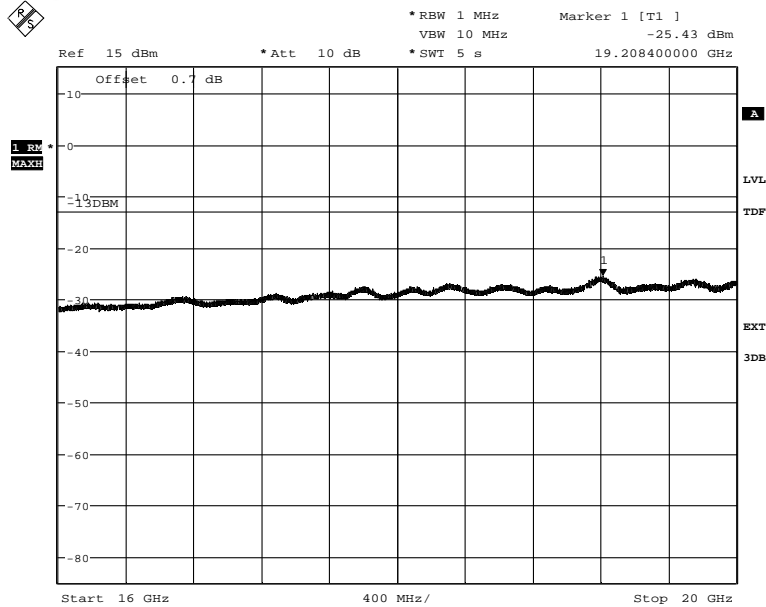

Date: 21.OCT.2013 16:08:57

Appendix 5

Diagram 4 a:

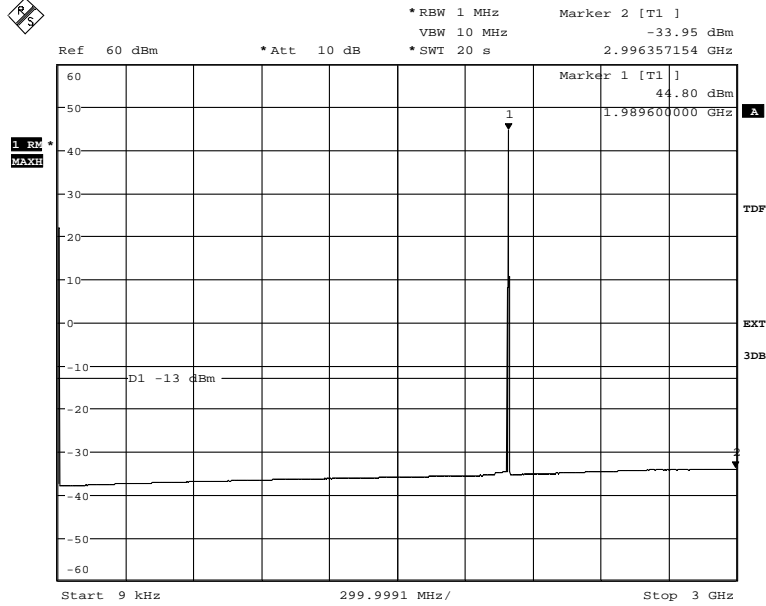

Date: 21.OCT.2013 15:45:25

Diagram 4 b:

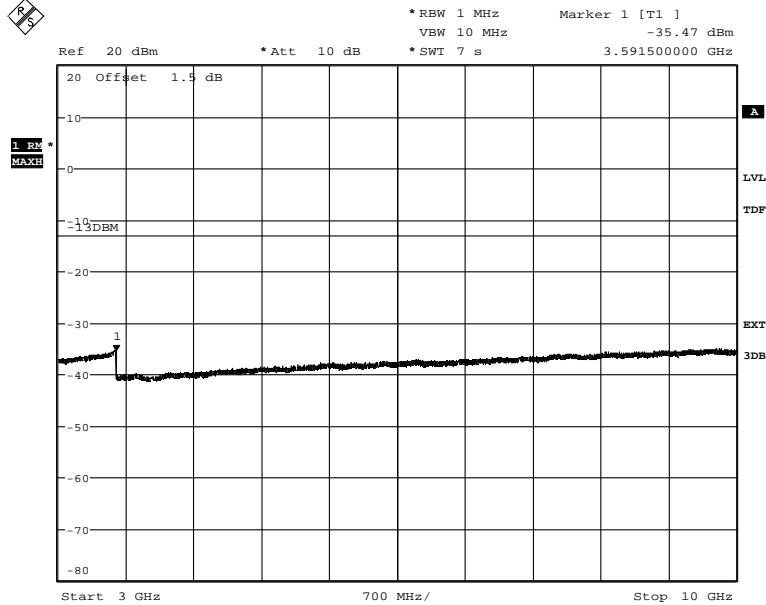

Date: 21.OCT.2013 15:47:17



Appendix 5

Diagram 4 c:

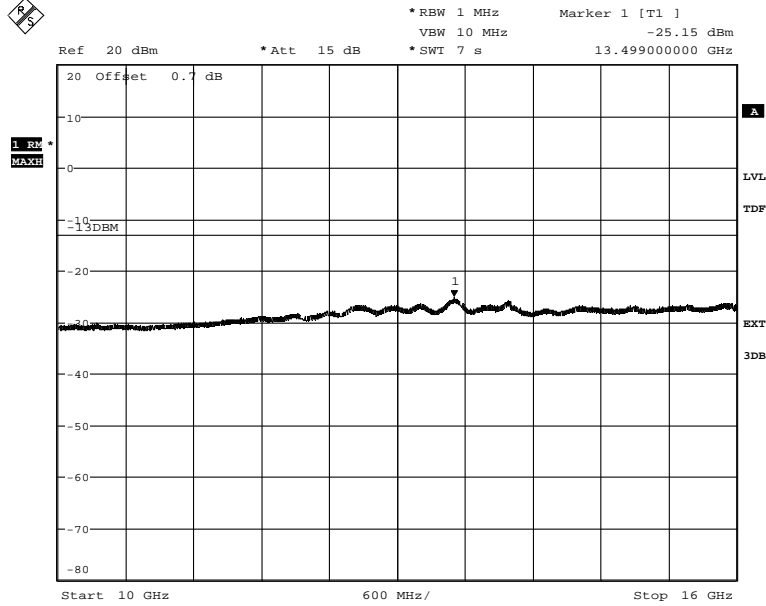

Date: 21.OCT.2013 15:48:59

Diagram 4 d:

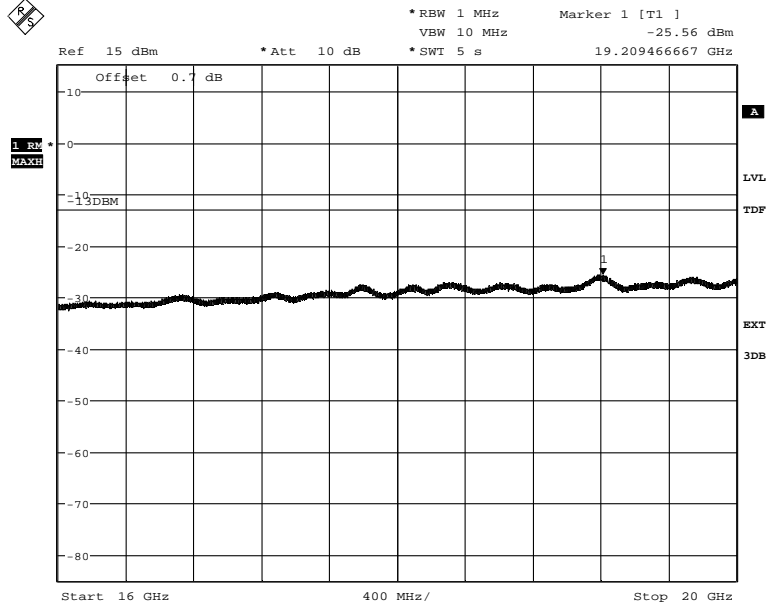

Date: 21.OCT.2013 15:49:50



Appendix 5

Diagram 5 a:

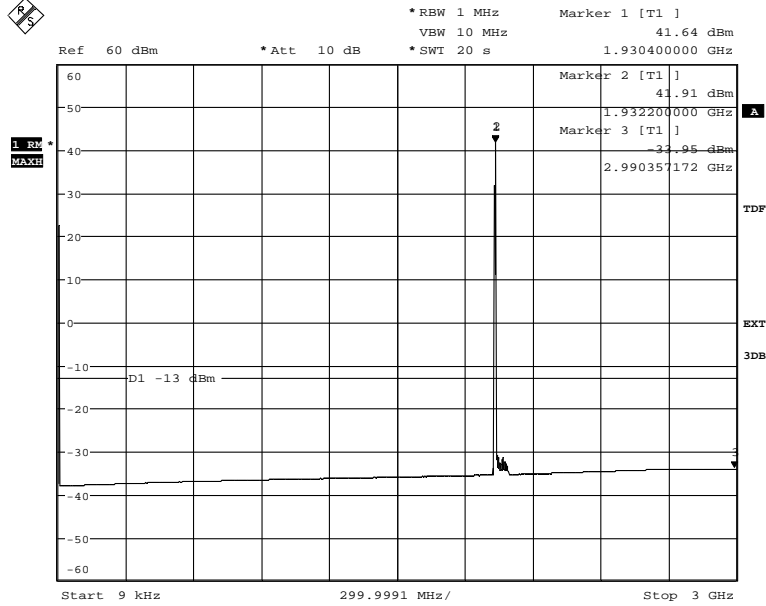

Date: 22.OCT.2013 15:12:40

Diagram 5 b:

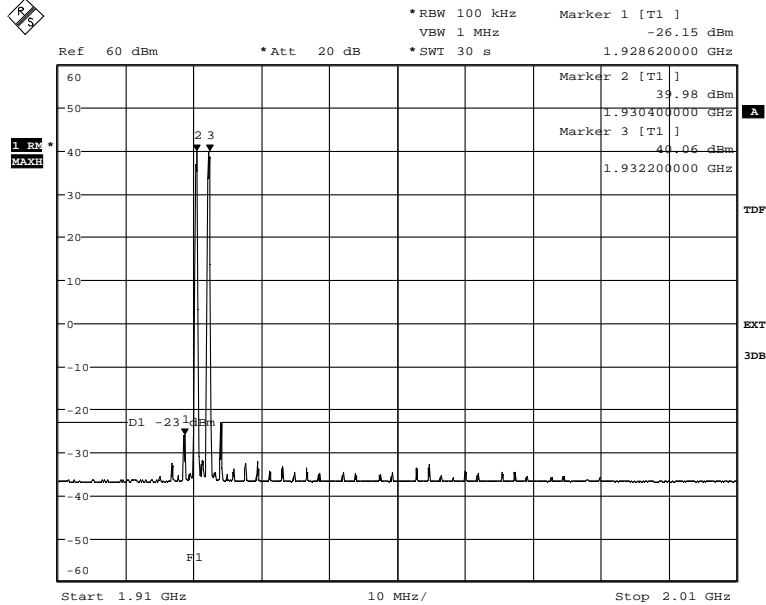

Date: 18.NOV.2013 13:33:39

The emission at 1928.62 MHz was -23.38 dBm measured with the channel power method with 1 MHz channel bandwidth.

Appendix 5

Diagram 5 c:

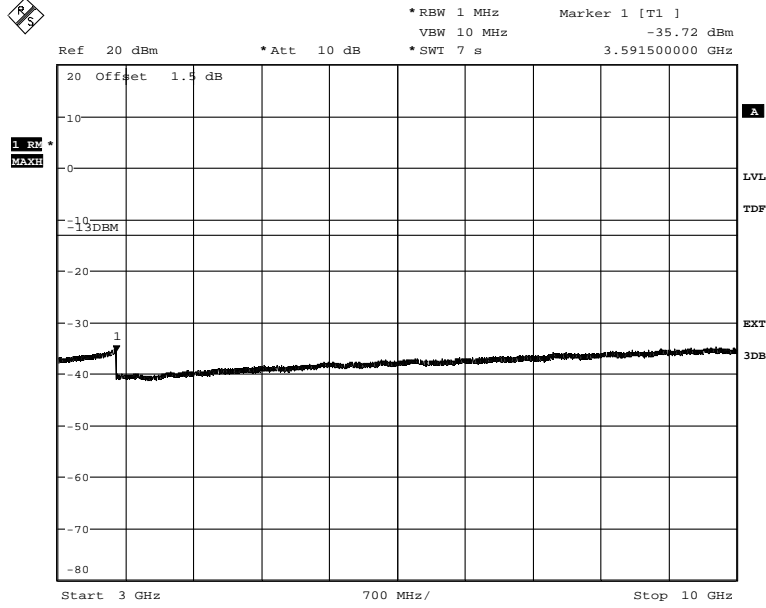

Date: 22.OCT.2013 14:12:41

Diagram 5 d:

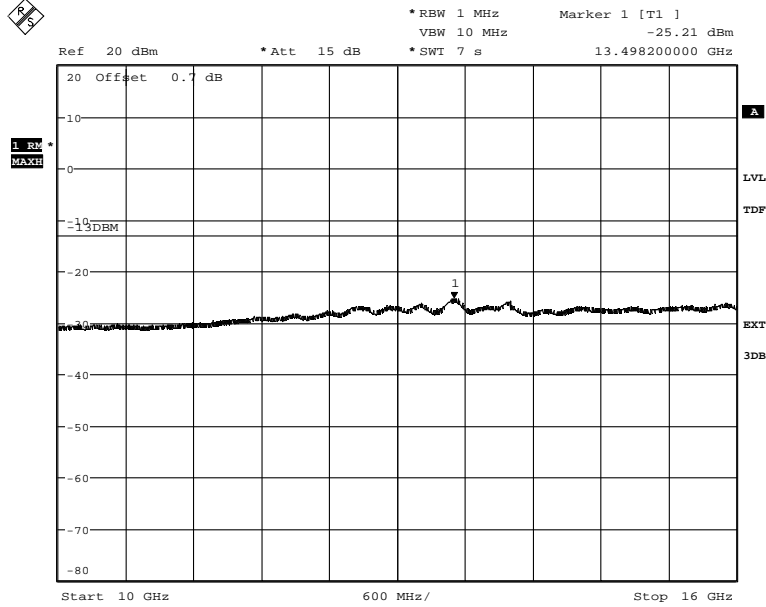

Date: 22.OCT.2013 14:11:42



Appendix 5

Diagram 5 e:

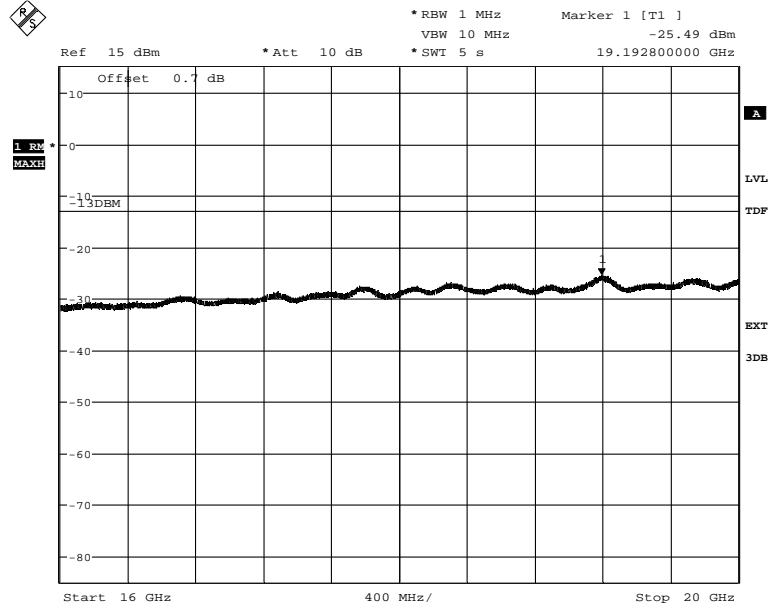

Date: 22.OCT.2013 14:00:07

Appendix 5

Diagram 6 a:

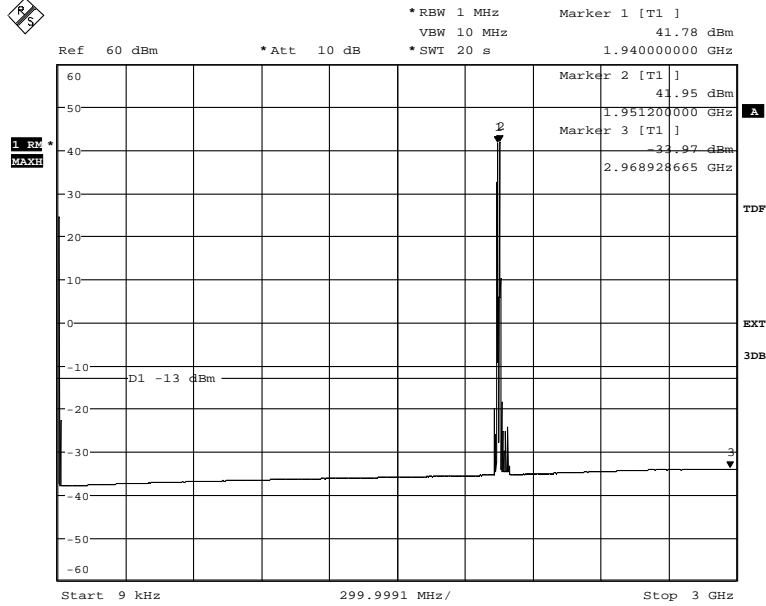

Date: 23.OCT.2013 09:26:44

Diagram 6 b:

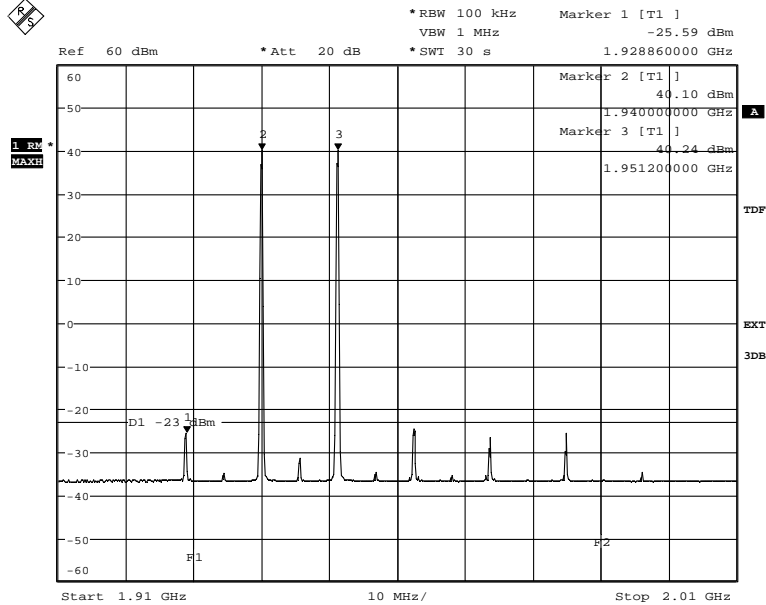

Date: 18.NOV.2013 13:20:04

The emission at 1928.86 MHz was -22.06 dBm measured with the channel power method with 1 MHz channel bandwidth.

Appendix 5

Diagram 6 c:

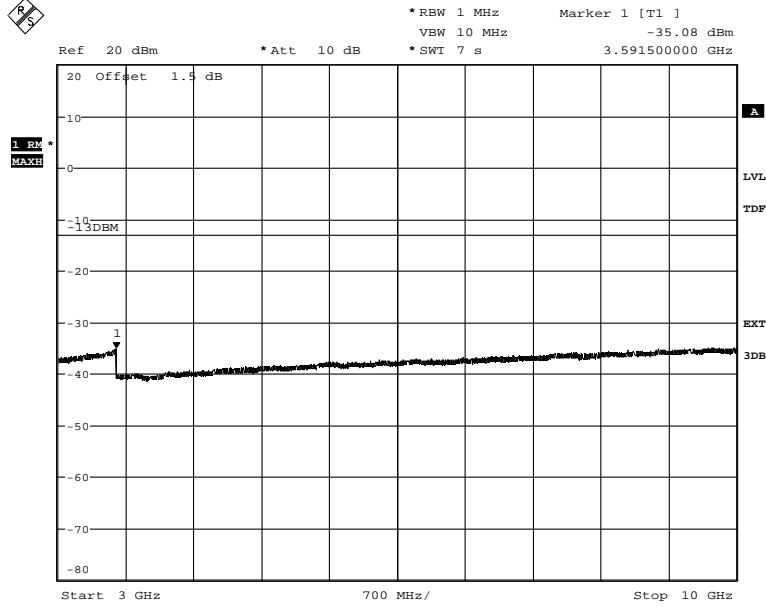

Date: 23.OCT.2013 09:22:26

Diagram 6 d:

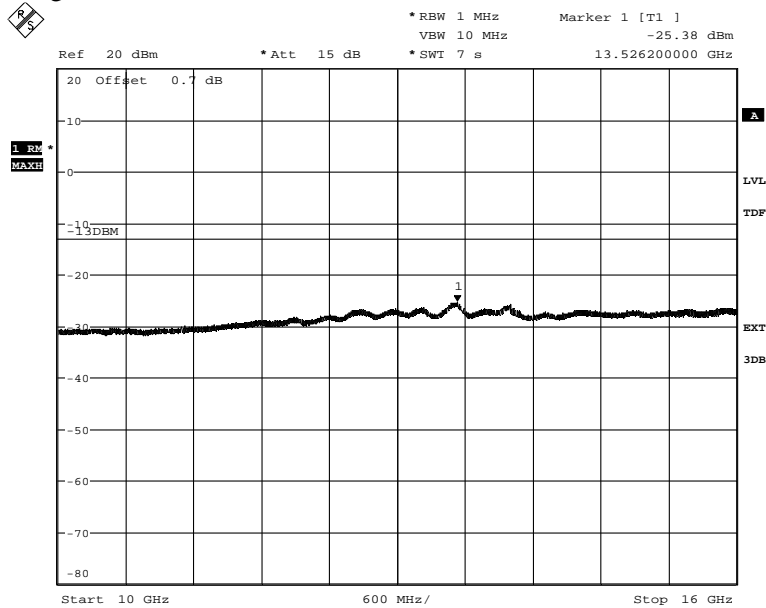

Date: 23.OCT.2013 09:21:29



Appendix 5

Diagram 6 e:

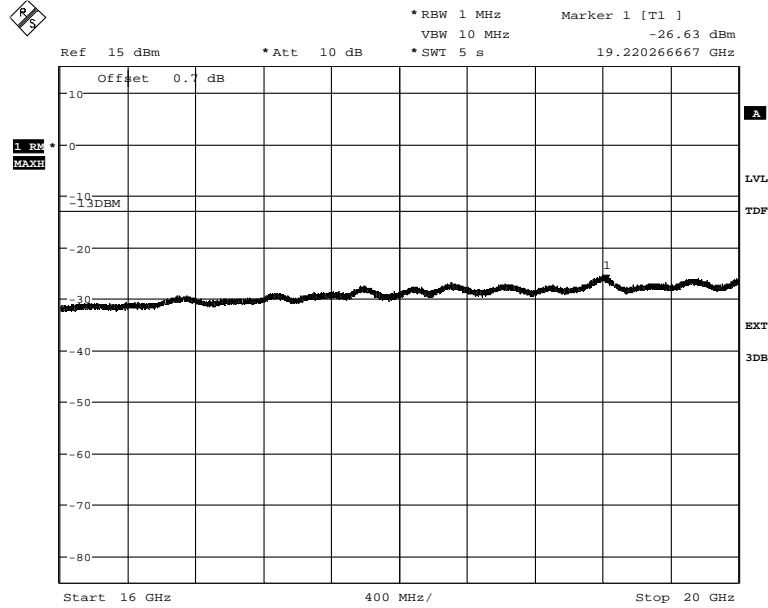

Date: 23.OCT.2013 09:20:30

Appendix 5

Diagram 7 a:

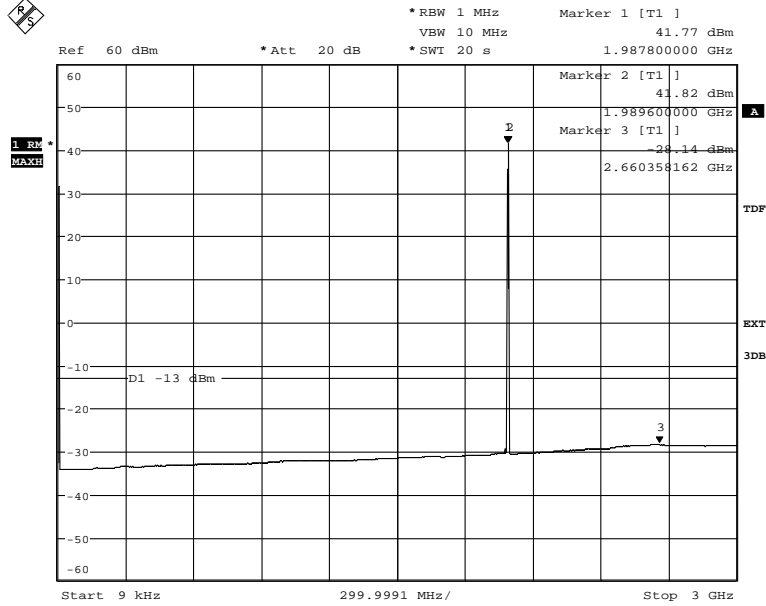

Date: 22.OCT.2013 13:39:43

Diagram 7 b:

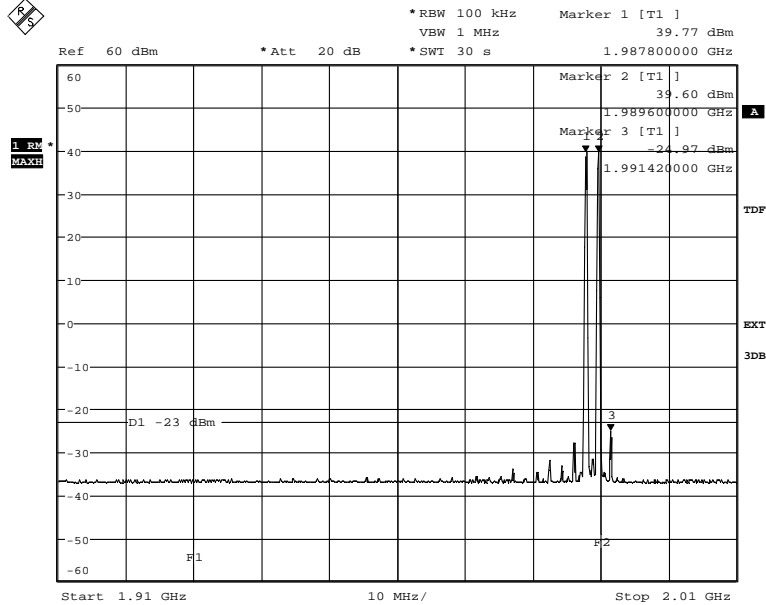

Date: 18.NOV.2013 13:03:08

The emission at 1991.42 MHz was  $-23.29$  dBm measured with the channel power method with 1 MHz channel bandwidth.

Appendix 5

Diagram 7 c:

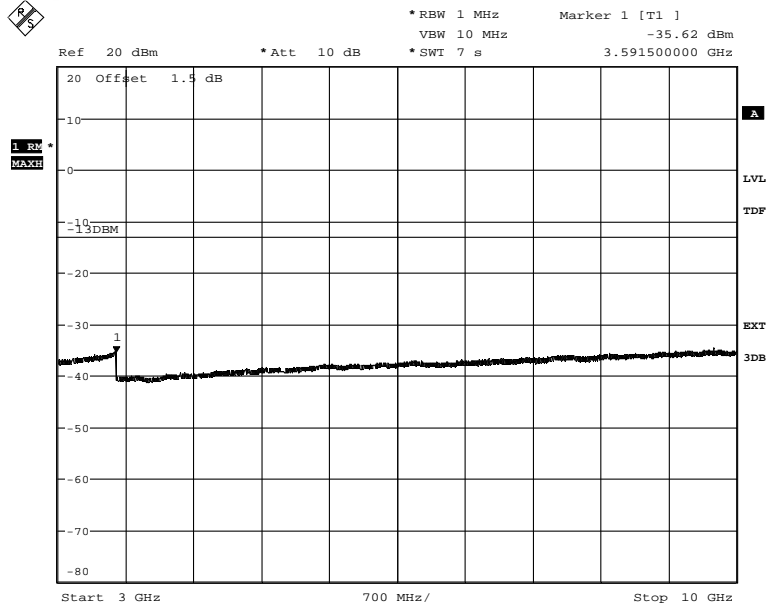

Date: 22.OCT.2013 13:54:31

Diagram 7 d:

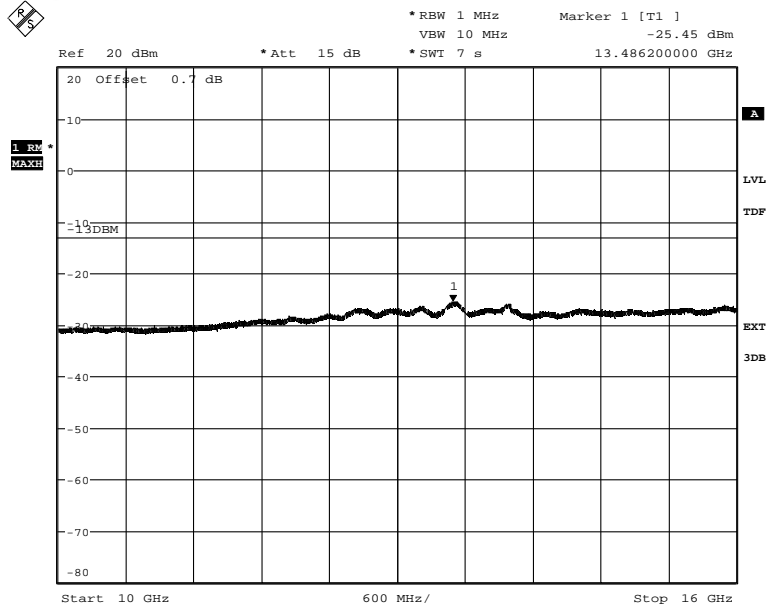

Date: 22.OCT.2013 13:55:39





Appendix 5

Diagram 7 e:

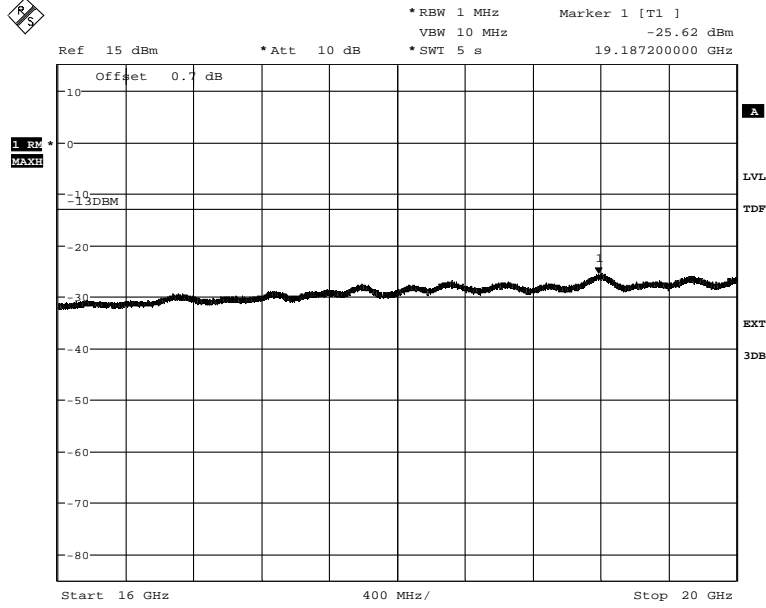

Date: 22.OCT.2013 13:56:35



Appendix 5

Diagram 8 a:

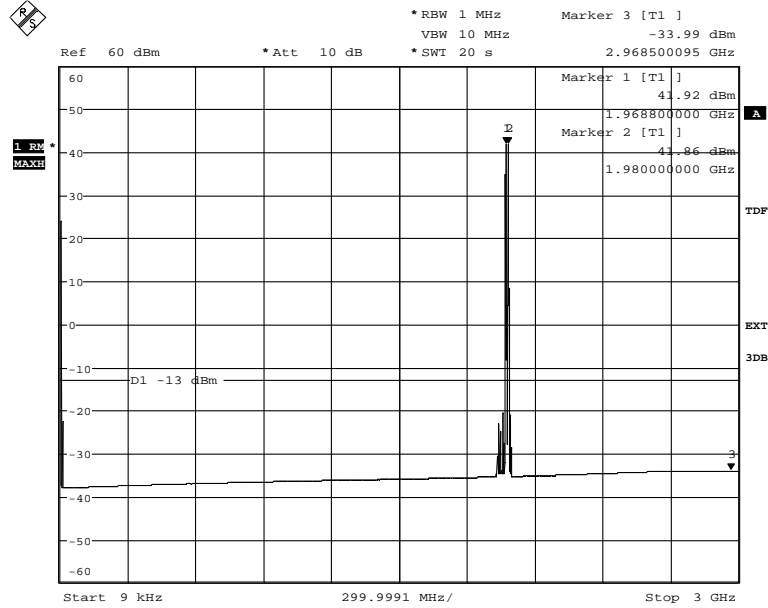

Date: 23.OCT.2013 09:12:08



Appendix 5

Diagram 8 b:

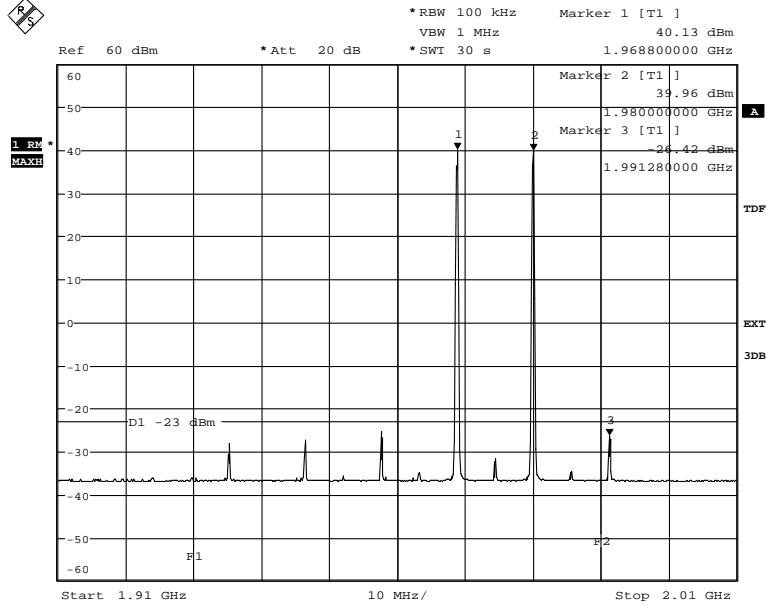

Date: 18.NOV.2013 13:56:55

Diagram 8 c:

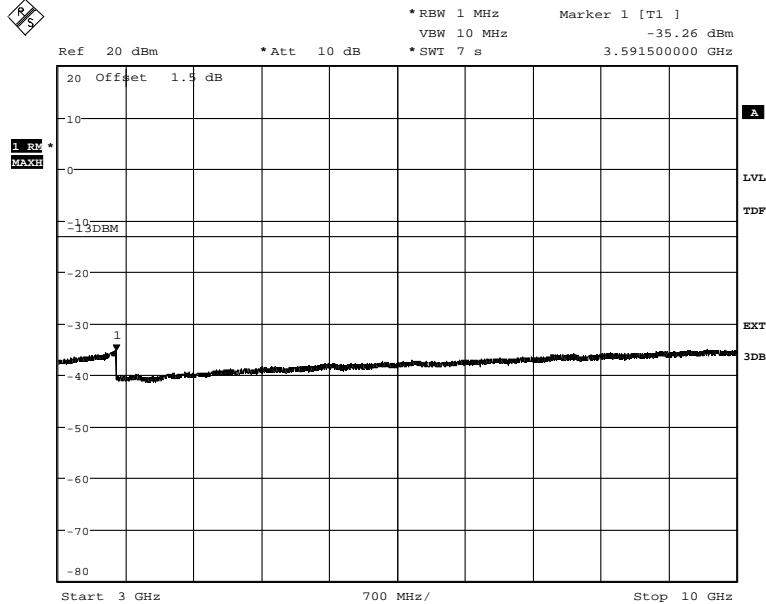

Date: 23.OCT.2013 09:13:46

Appendix 5

Diagram 8 d:

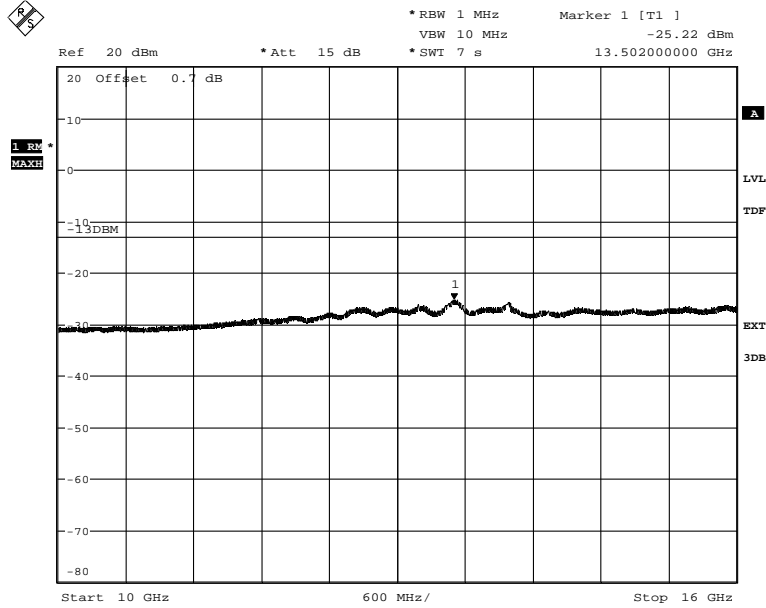

Date: 23.OCT.2013 09:14:53

Diagram 8 e:

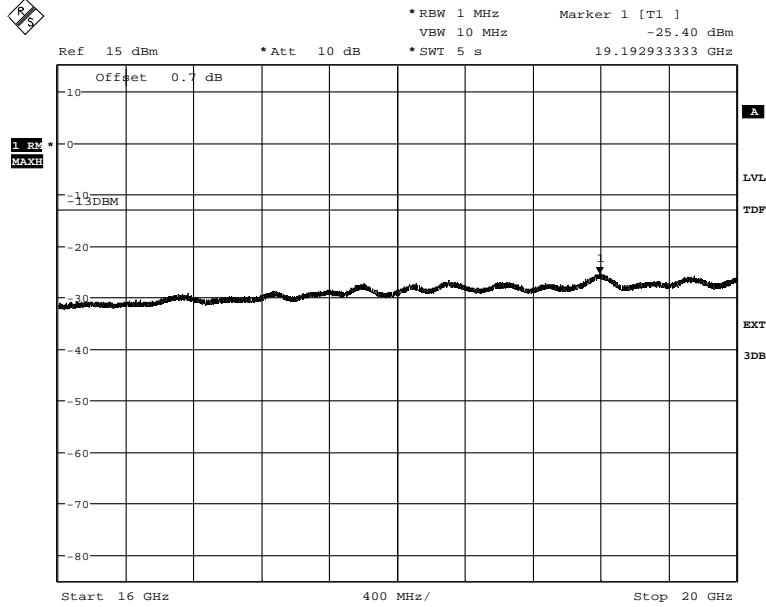

Date: 23.OCT.2013 09:16:00

Appendix 5

Diagram 9 a:

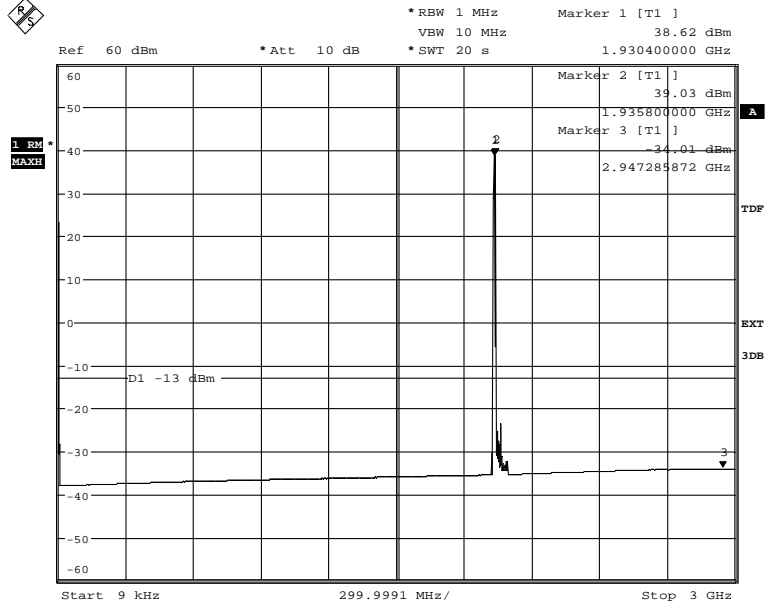

Date: 18.NOV.2013 14:01:21

Diagram 9 b:

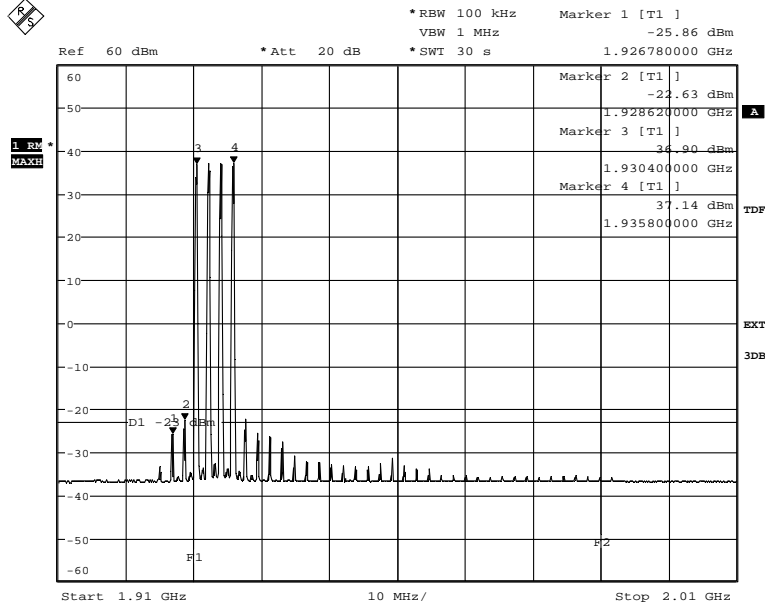

Date: 18.NOV.2013 12:40:20

The emission at 1926.78 MHz was -24.34 dBm and at 1928.62 was -21.64 dBm, measured with the channel power method with 1 MHz channel bandwidth.

Appendix 5

Diagram 9 c:

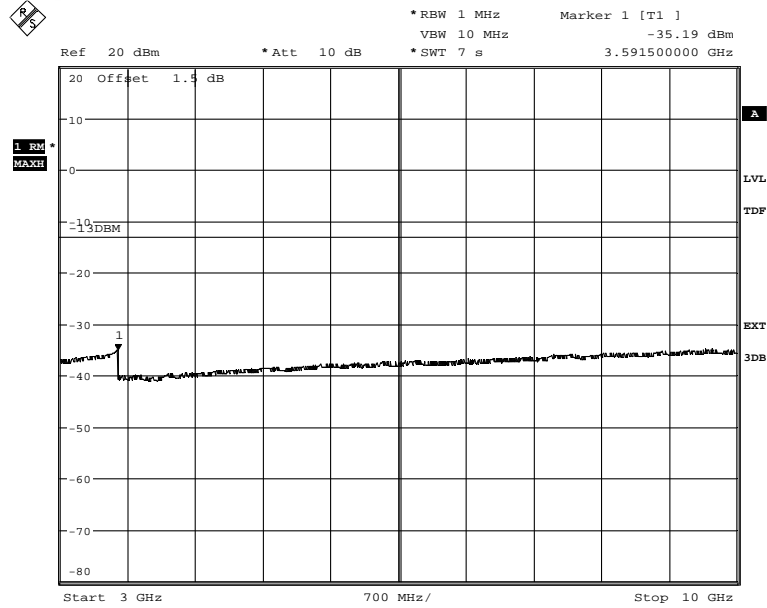

Date: 23.OCT.2013 11:17:06

Diagram 9 d:

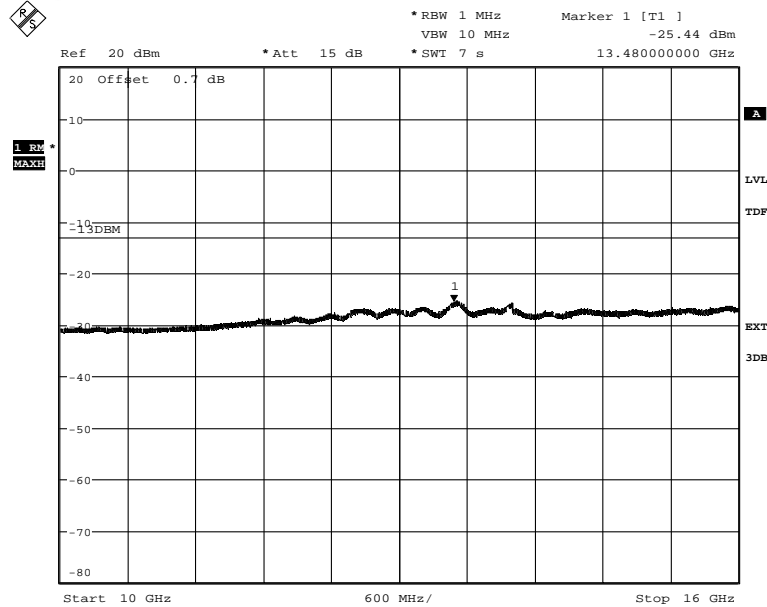

Date: 23.OCT.2013 11:18:10



Appendix 5

Diagram 9 e:

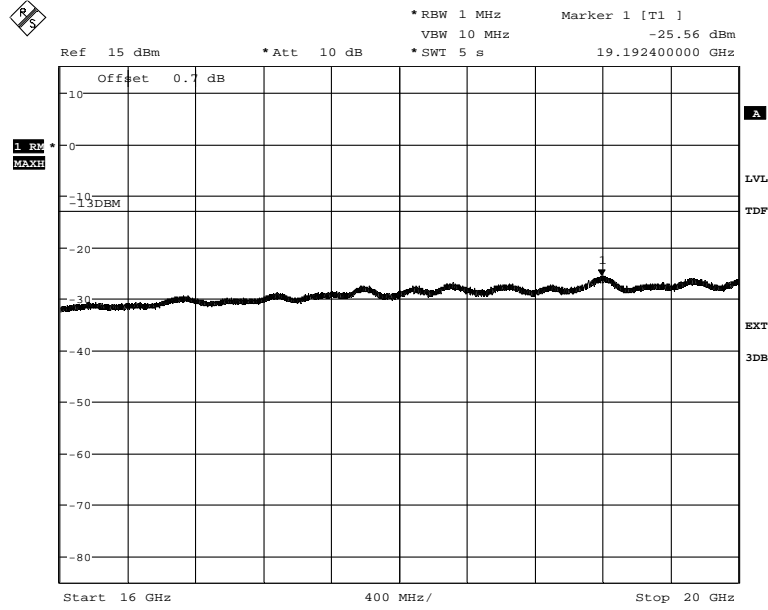

Date: 23.OCT.2013 11:19:01

Appendix 5

Diagram 10 a:

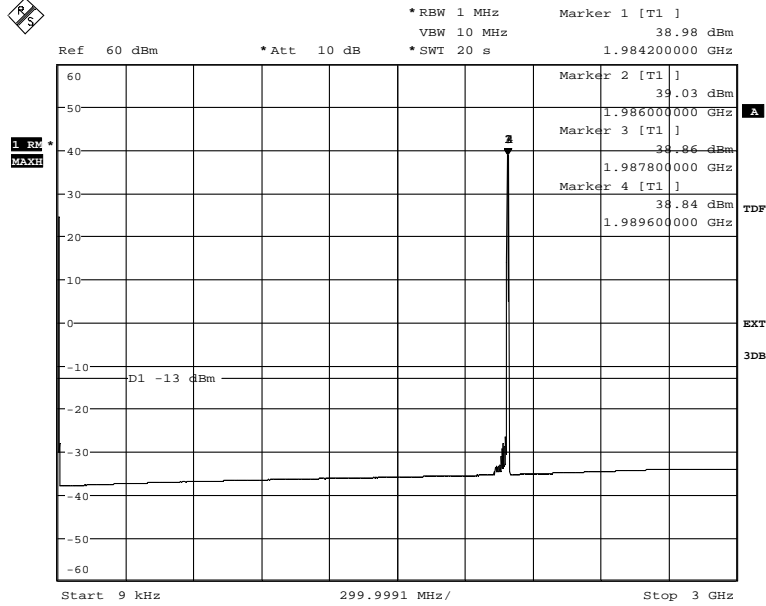

Date: 23.OCT.2013 09:55:29

Diagram 10 b:

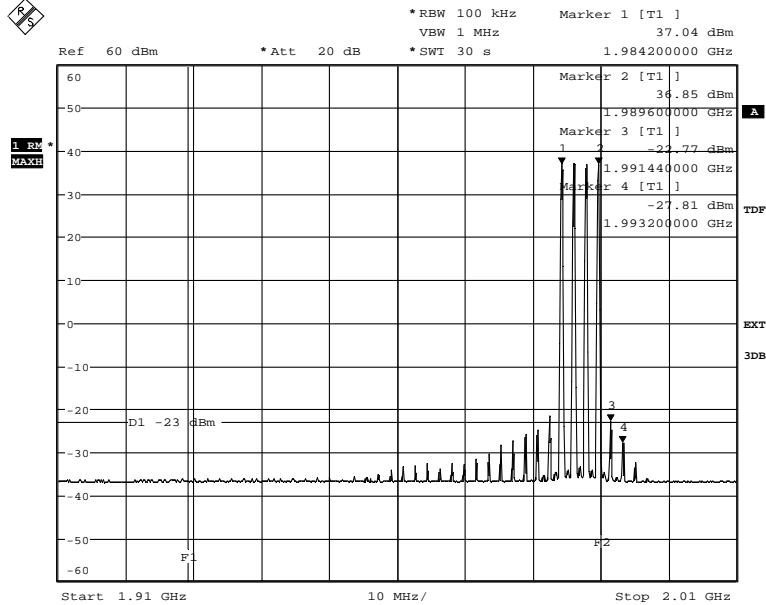

Date: 18.NOV.2013 12:50:35

The emission at 1991.44 MHz was  $-22.22$  dBm measured with the channel power method with 1 MHz channel bandwidth.





Appendix 5

Diagram 10 c:

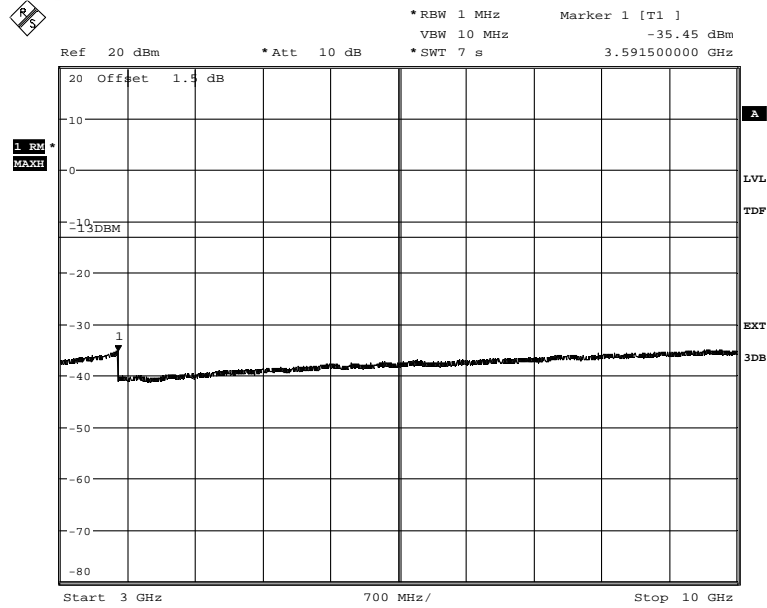

Date: 23.OCT.2013 10:17:35

Diagram 10 d:

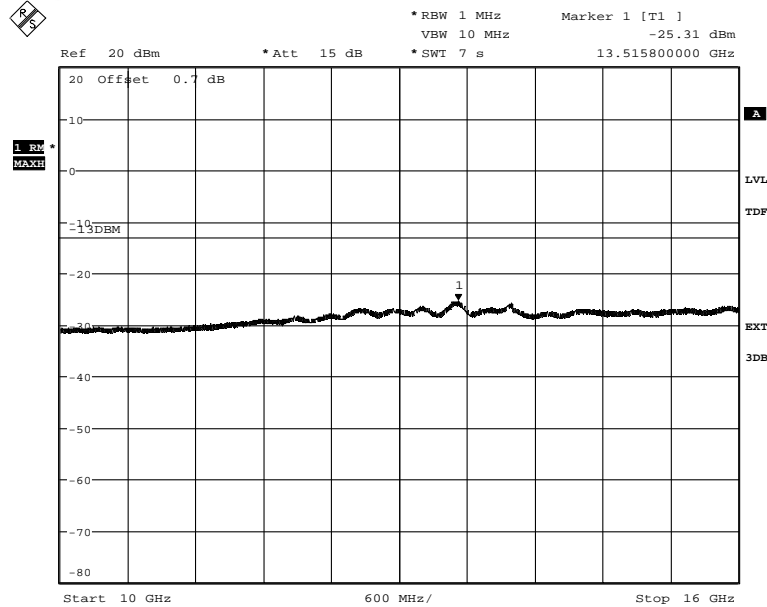

Date: 23.OCT.2013 10:18:30



Appendix 5

Diagram 10 e:

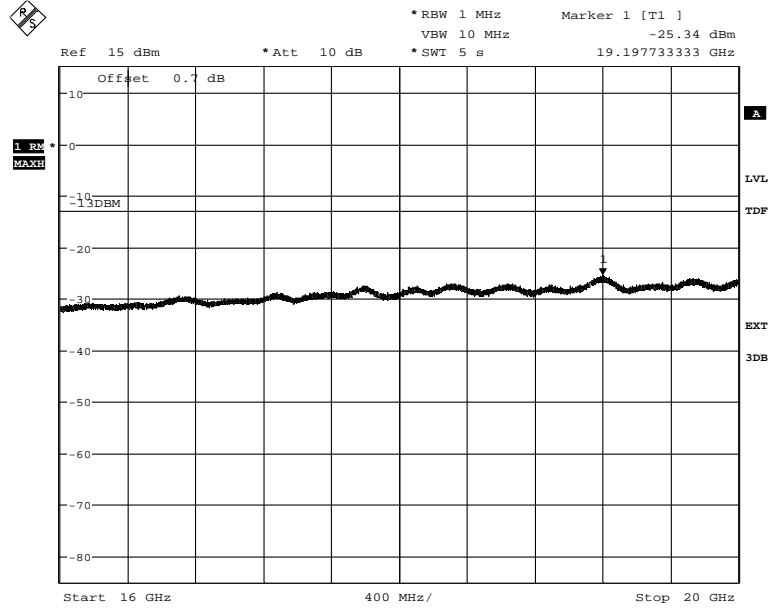

Date: 23.OCT.2013 10:19:28

Appendix 6

**Field strength of spurious radiation measurements according to CFR 47 §24.238 / IC RSS-133 6.5**

Date 2013-10-15	Temperature 23 °C ± 3°C	Humidity 31 % ± 5 %
--------------------	----------------------------	------------------------

**Test set-up and procedure**

The test sites are listed at FCC, Columbia with registration number: 93866. The test site complies with RSS-Gen, Industry Canada file no. 3482A-1.

The measurements were performed with both horizontal and vertical polarization of the antenna. The antenna distance was 3 m in the frequency range 30 MHz – 18 GHz and 1 m in the frequency range 18 - 20 GHz.

In the frequency range 30 MHz - 20 GHz the measurement was performed in power with a RBW of 1 MHz. A propagation loss in free space was calculated. The used formula was

$$\gamma = 20 \log \left( \frac{4\pi D}{\lambda} \right), \gamma \text{ is the propagation loss and } D \text{ is the antenna distance.}$$

The measurement procedure was as the following:

1. The pre-measurement was first performed with peak detector. The EUT was measured in eight directions and with the antenna at three heights, 1.0 m, 1.5 m and 2.0 m.
2. Spurious radiation on frequencies closer than 20 dB to the limit in the pre-measurement is scanned 0-360 degrees and the antenna is scanned 1- 4 m for maximum response. The emission is then measured with the RMS detector and the RMS value is reported. Frequencies closer than 10 dB to the limit when measured with the RMS detector were measured with the substitution method according to the standard.

## Appendix 6

The test set-up during the spurious radiation measurements is shown in the picture below:



### Measurement equipment

Measurement equipment	SP number
Semi anechoic chamber	503 881
R&S ESU 26	901 553
EMC 32 ver. 8.52.0	503 899
Chase Bilog Antenna CBL 6111A	502 182
EMCO Horn Antenna 3115	502 175
Flann STD Gain Horn Antenna 20240-20	503 674
High pass filter, RLC Electronics, 3-18 GHz	503 739
Miteq, Low Noise Amplifier	503 285
Schwartzbeck preamplifier BBV 9742	504 085
µComp Nordic, Low Noise Amplifier	901 545
Temperature and humidity meter, Testo 625	504 188

### Tested configurations

Symbolic name
B
M-13
T
B2
T2
B4

## Appendix 6

**Results**, representing worst case

Diagram	Configuration	Symbolic name
1 a-d	1 - Carrier	B

Frequency (MHz)	Spurious emission level (dBm)	
	Vertical	Horizontal
30-20 000	All emission > 20 dB below limit	All emission > 20 dB below limit

**Measurement uncertainty:**

3.2 dB up to 18 GHz, 3.6 dB above 18 GHz

**Limits**

CFR 47 §24.238 and RSS-133 6.5

Outside a licensee's frequency band(s) of operation the power of any emission shall be attenuated below the transmitter power (P) by at least  $43 + 10 \log (P)$  dB, resulting in a limit of -13 dBm per 1 MHz RBW.

Complies?	Yes
-----------	-----

Appendix 6

Diagram 1a:

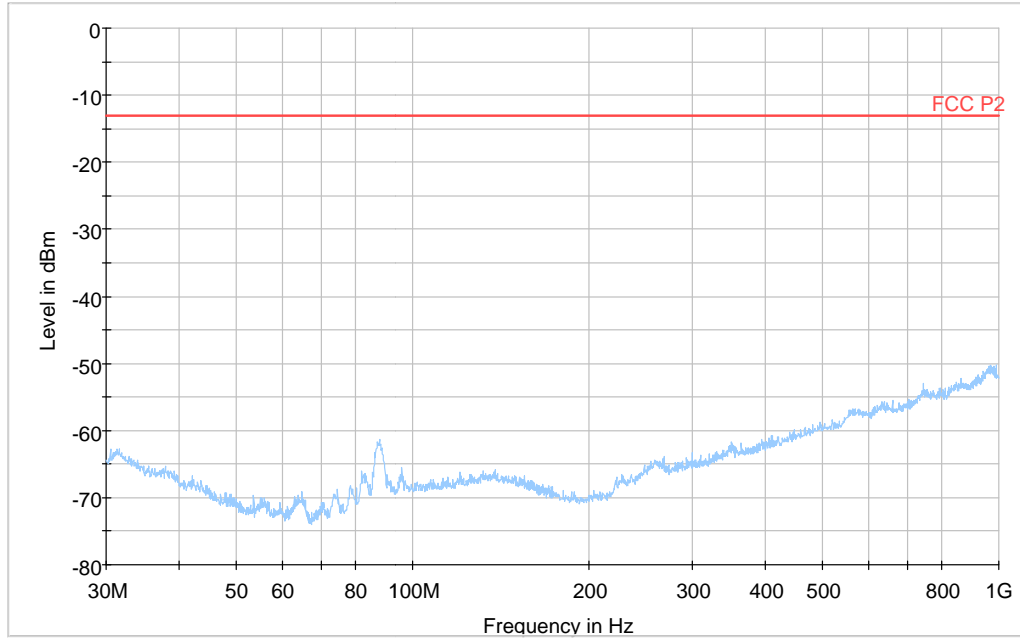
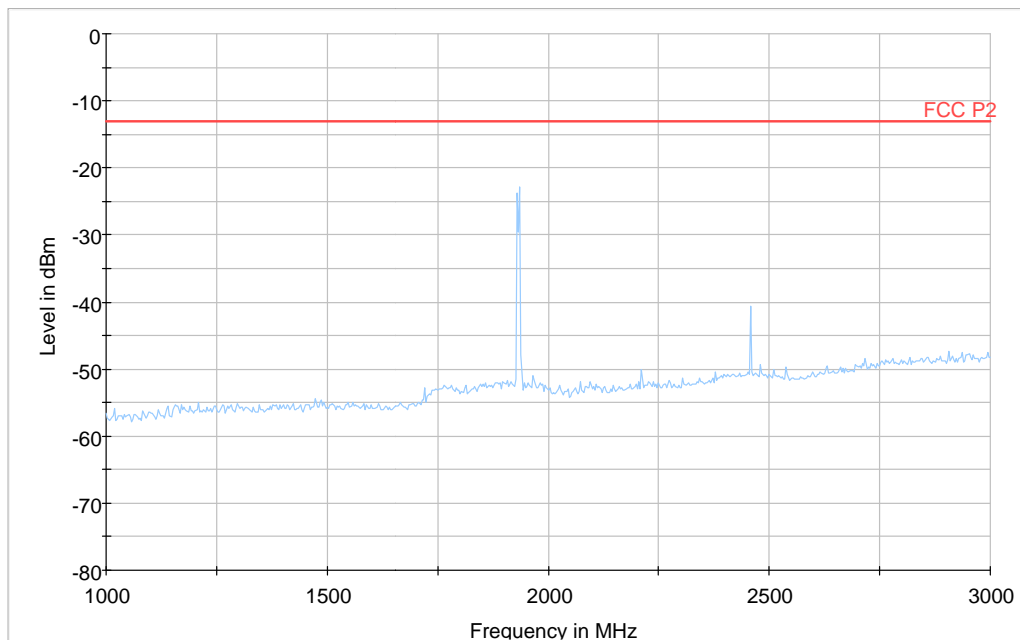

Diagram 1b:



Note: The emission at 1930.4 MHz is the carrier frequency and shall be ignored in the context.

Appendix 6

Diagram 1c:

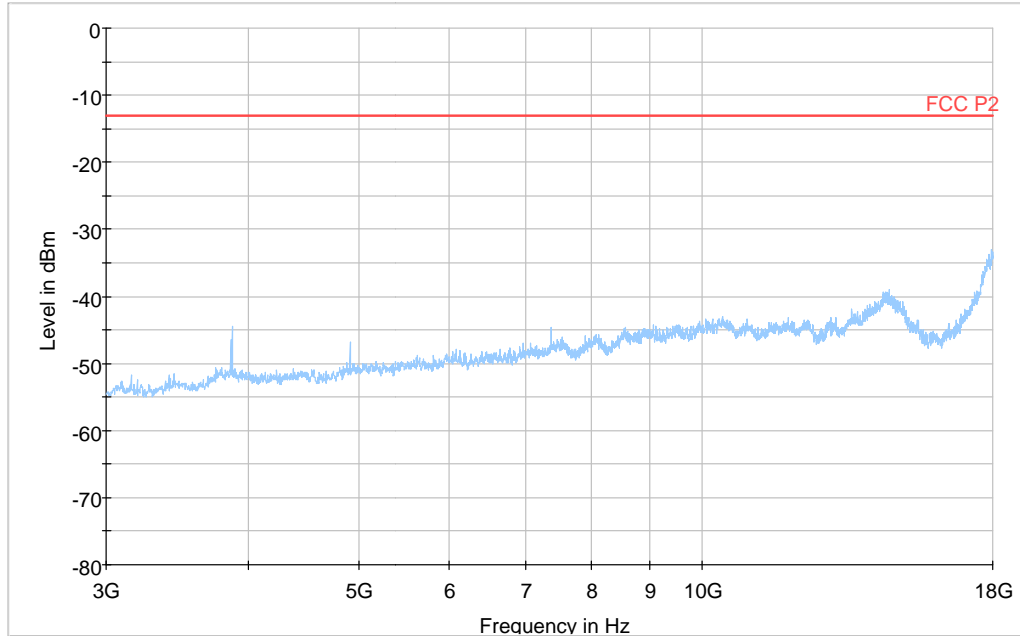
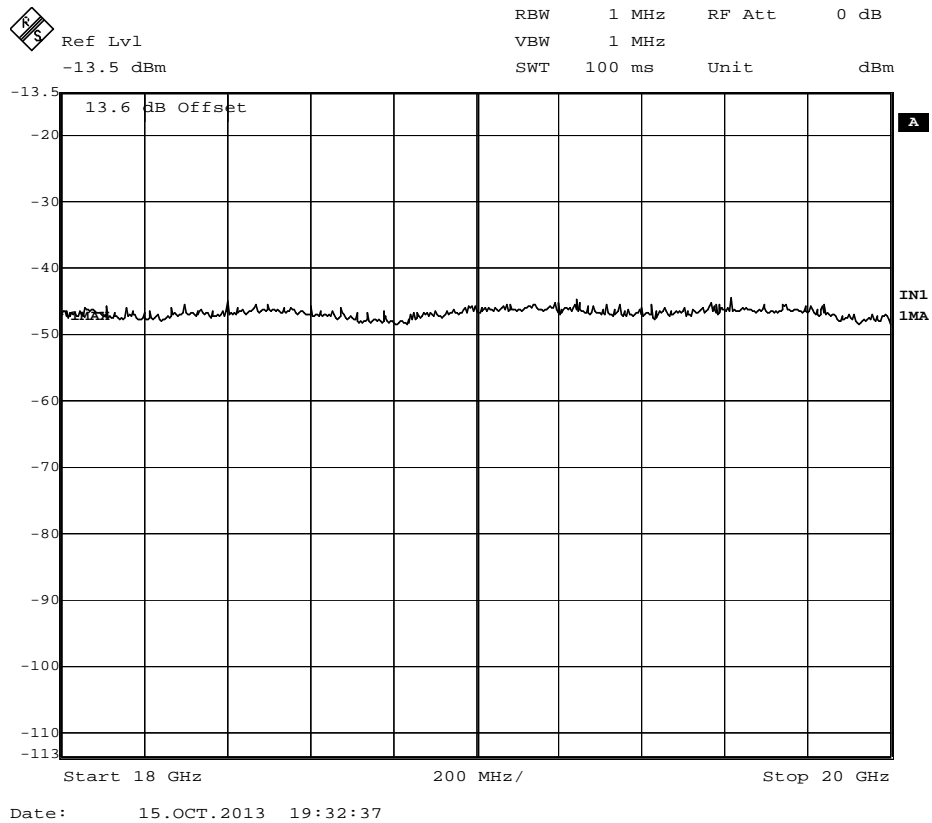

Diagram 1d:



Appendix 7

**Frequency stability measurements according to CFR 47 §24.235 / IC RSS 133 6.3**

Date 2013-10-24 to 2013-10-27	Temperature (test equipment) 22-23 °C ± 3 °C	Humidity (test equipment) 35-41 % ± 5 %
----------------------------------	---	--

**Test set-up and procedure**

The measurement was made per 3GPP TS 25.141. The output was connected to a spectrum analyzer. The spectrum analyzer was connected to an external 10 MHz reference standard during the measurements.

Measurement equipment	SP number
Rohde & Schwarz signal analyzer FSQ40	504 143
RF attenuator	503 870
Testo 635, Temperature and humidity meter	504 203
Temperature cabinet	503 360

**Results**

Nominal Voltage -48 V DC

Maximum output power at mid channel (M)

Test conditions		Frequency error (Hz)
Supply voltage DC (V)	Temp. (°C)	
-48.0	+20	-9
-55.2	+20	-6
-40.8	+20	-6
-48.0	+30	-3
-48.0	+40	-2
-48.0	+50	-12
-48.0	+10	-8
-48.0	0	-9
-48.0	-10	-8
-48.0	-20	+9
-48.0	-30	-11
Maximum freq. error (Hz)		12
Measurement uncertainty		$< \pm 1 \times 10^{-7}$





Appendix 7

**Remark**

It was deemed sufficient to test one combination of TX frequency modulation, as all combinations share a common internal reference to derive the TX frequency from.

Limit according to:

§24.235

The frequency stability shall be sufficient to ensure that the fundamental emission stays within the authorized frequency block.

RSS-133 6.3 Frequency stability:

The carrier frequency shall not depart from the reference frequency in excess of  $\pm 1.0$  ppm ( $\pm 1960$  Hz) for base stations when tested to the temperature and supply voltage variations specified in RSS-Gen.

Complies?	Yes
-----------	-----

Appendix 8

External photos

Front side



Rear side



Appendix 8

Left side



Right side



## Appendix 8

Top side



Bottom side

