



REPORT

Issued by a FCC listed Laboratory Reg. no 93866
The test site complies with RSS-Gen, IC file no. 3482A-1

Contact person
Jörgen Wassholm
Electronics
+46 10 516 57 06
jorgen.wassholm@sp.se

Date
2014-02-07

Reference
3P07323-05-F24

Page
1 (2)



Ericsson AB
Klaes Holm
PDU HW
164 80 Stockholm

Radio measurements on AIR 21 B2A B12P B5P 1900 MHz radio equipment with FCC ID TA8AKRC118054-1 and IC 287AB-AS1180541 (5 appendices)

Test object

Product name: AIR 21 B2A B12P B5P
Product number: KRC 118 054/1, R1A

Summary

See appendix 1 for general information and appendix 5 for external photos.

Standard	Compliant	Appendix
FCC CFR 47 / IC RSS-133 Issue 6		
2.1046 / RSS-133 6.4 RF power output	Yes	2
2.1051 / RSS-133 6.5 Spurious emission at antenna terminals	Yes	3
2.1053 / RSS-133 6.5 Field strength of spurious radiation	Yes	4

Note: Above RSS-133 items are given as cross-reference only. Measurements were performed according to ANSI procedures referenced by FCC and covered by SP's accreditation.

SP Technical Research Institute of Sweden

Electronics – EMC

Performed by

Jörgen Wassholm

Examined by

Anders Nordlöf

SP Technical Research Institute of Sweden

Postal address

SP
Box 857
SE-501 15 BORÅS
Sweden

Office location

Västeråsen
Brinellgatan 4
SE-504 62 BORÅS

Phone / Fax / E-mail

+46 10 516 50 00
+46 33 13 55 02
info@sp.se

Laboratories are accredited by the Swedish Board for Accreditation and Conformity Assessment (SWEDAC) under the terms of Swedish legislation. This report may not be reproduced other than in full, except with the prior written approval of the issuing laboratory.

Table of contents

Description of the test object	Appendix 1
Operation modes during measurements	Appendix 1
Test frequencies and setups	Appendix 1
Purpose of test	Appendix 1
RF power output	Appendix 2
Spurious emission at antenna terminals	Appendix 3
Field strength of spurious radiation	Appendix 4
External photos	Appendix 5

Appendix 1

Description of the test object

Equipment:	Product name: AIR 21 B2A B12P B5P Product number KRC 118 054/1 FCC ID: TA8AKRC118054-1 IC: 287AB-AS1180541 IC MODEL NO: AS1180541
Tested configuration:	Multi RAT (MR) LTE+GSM
Frequency range:	TX: 1930 – 1990 MHz RX: 1850 – 1910 MHz
Antenna ports:	2 TX/RX ports, , (Internally connected to integrated Cross-Polarized antenna elements.)
RF configurations: Multi RAT	GSM + LTE, MIMO 2x2 (MIMO LTE only)
Maximum nominal RF output power	RF port A: 1-2 carriers LTE (total power 41.8 dBm, 15 W) RF port B: 1-2 carriers LTE + 1-3 carriers GSM (total power 44.8dBm, 30W)
Antenna type:	Cross- polarized antenna
Antenna gain:	17 dBi
GSM Modulations:	GMSK, 16QAM, 32QAM, AQPSK and 8PSK
LTE Modulations:	QPSK, 16QAM and 64QAM
LTE Channel bandwidths:	1.4 MHz, 3 MHz, 5 MHz, 10 MHz, and 15 MHz
Nominal supply voltage:	-48VDC

Appendix 1

Operation modes during measurements

MR, LTE + GSM

LTE measurements were performed with the test object transmitting test models as defined in 3GPP TS 36.141. Test model E-TM1.1 represent QPSK modulation, test model E-TM3.2 represent 16QAM modulation and test model E-TM3.1 represent 64QAM modulation. All measurements were performed with the test object configured for the maximum transmit power applicable for the tested configuration.

GSM measurements were performed with the test object transmitting pseudorandom data in all timeslots and settings for maximum transmitter output power applicable for each configuration. For AQPSK modulation the SCPIR is 0 dB.

The settings below were deemed representative for all traffic scenarios when settings with different modulations, channel bandwidths, number of carriers and RF configurations has been tested to find the worst case setting. The settings below were used for all measurements if not otherwise noted.

LTE: MIMO mode, E-TM1.1

GSM: GMSK modulation

Conducted measurements

The conducted measurements were performed on AIR 21 B2A B12P B8P with product number KRC 118 055/1 including the radio unit ARUS 1/KRC 118 054 which is identical for AIR 21 B2A B12P B5P and is representative for conducted TX performance measurements.

The test object was pole mounted and powered with -48 VDC by an external power supply, unless noted otherwise. All TX parameters were measured at port RF B with port RF A terminated into 50 ohm. Complete measurements were made on RF B with additional measurements on RF A.

Radiated measurements

The test object was pole mounted and powered with -48 VDC by an external power supply. Both RF ports were terminated into 50 ohm.

Purpose of test

The purpose of the tests is to verify compliance to the performance characteristics specified in applicable items of FCC CFR 47 and Industry Canada RSS-133 and RSS-Gen.

Appendix 1

References

Measurements were done according to relevant parts of the following standards:

ANSI C63.4-2009

ANSI/TIA/EIA-603-C-2004

3GPP TS 36.141, version 11.4.0

CFR 47 part 2, October 1st, 2012

CFR 47 part 24 Subpart E, October 1st, 2012

RSS-Gen Issue 3

RSS-133 Issue 6

Uncertainties

Measurement and test instrument uncertainties are described in the quality assurance documentation "SP-QD 10885". The uncertainties are calculated with a coverage factor $k=2$ (95% level of confidence).

Compliance evaluation is based on a shared risk principle with respect to the measurement uncertainty.

Reservation

The test results in this report apply only to the particular test object as declared in the report.

Delivery of test object

The test object was delivered 2013-10-18.

Manufacturer's representative

Christer Gustavsson, Ericsson AB.

Test engineers

Andreas Johnson, Tomas Isbring, Tomas Lennhager, Kexin Chen, Jörgen Wassholm and Hyder Khalaf, SP.

Test participant

None.

Appendix 1

Measurement equipment

	Calibration Due	SP number
Test site Tesla	2014-01	503 881
R&S FSIQ 40	2014-07	503 738
R&S ESU 26	2014-05	901 553
R&S FSQ 40	2014-03	504 143
Control computer with R&S software EMC32 version 8.52.0	-	503 899
High pass filter	2014-07	901 501
High pass filter	2014-07	901 502
High pass filter	2014-07	504 199
High pass filter	2014-09	901 373
High pass filter	2014-09	503 739
High pass filter	2014-07	503 740
RF attenuator	2014-07	504 159
RF attenuator	2014-07	900 233
RF attenuator	2014-07	900 691
RF attenuator	2014-07	901 384
RF attenuator	2013-12	901 508
Chase Bilog Antenna CBL 6111A	2014-10	503 182
EMCO Horn Antenna 3115	2015-09	502 175
Std.gain horn FLANN model 20240-20	2014-03	503 674
µComp Nordic, Low Noise Amplifier	2014-04	901 545
Miteq Low Noise Amplifier	2014-09	503 285
Schwartzbeck preamplifier BBV 9742	2014-14	504 085
Temperature and humidity meter, Testo 635	2014-06	504 203
Temperature and humidity meter, Testo 625	2014-06	504 188
Multimeter Fluke 87	2014-08	502 190

Appendix 1

Test frequencies used for conducted and radiated measurements

Configuration 1:

RAT	LTE BW 1.4 MHz	LTE BW 1.4 MHz	GSM
Port	RF A	RF B	RF B
Power	15 W	15 W	15 W
Downlink (Frequency)	750 (1945.0 MHz)	750 (1945.0 MHz)	513 (1930.4 MHz)
Uplink (Frequency)	18750 (1865.0 MHz)	18750 (1865.0 MHz)	513 (1850.4 MHz)

Configuration 2:

RAT	LTE BW 1.4 MHz	LTE BW 1.4 MHz	GSM
Port	RF A	RF B	RF B
Power	15 W	15 W	15 W
Downlink (Frequency)	760 (1946.0 MHz)	760 (1946.0 MHz)	513 (1930.4 MHz)
Uplink (Frequency)	18648 (1854.8 MHz)	18648 (1854.8 MHz)	513 (1850.4 MHz)

Configuration 3:

RAT	LTE BW 1.4 MHz	LTE BW 1.4 MHz	GSM
Port	RF A	RF B	RF B
Power	15 W	15 W	15 W
Downlink (Frequency)	1066 (1976.6 MHz)	1066 (1976.6 MHz)	801 (1988.0 MHz)
Uplink (Frequency)	19066 (1896.6 MHz)	19066 (1896.6 MHz)	801 (1908.0 MHz)

Configuration 4:

RAT	LTE BW 1.4 MHz	LTE BW 1.4 MHz	GSM
Port	RF A	RF B	RF B
Power	15 W	15 W	15 W
Downlink (Frequency)	764 (1946.4 MHz)	764 (1946.4 MHz)	564 (1940.6 MHz)
Uplink (Frequency)	18764 (1866.4 MHz)	18764 (1866.4 MHz)	564 (1860.6 MHz)

Appendix 1

Configuration 5:

RAT	LTE BW 1.4 MHz	LTE BW 1.4 MHz	GSM
Port	RF A	RF B	RF B
Power	15 W	15 W	15 W
Downlink (Frequency)	1036 (1973.6 MHz)	1036 (1973.6 MHz)	699 (1967.6 MHz)
Uplink (Frequency)	19036 (1893.6 MHz)	19036 (1893.6 MHz)	699 (1887.6 MHz)

Configuration 6:

RAT	LTE BW 1.4 MHz	LTE BW 1.4 MHz	GSM
Port	RF A	RF B	RF B
Power	15 W	15 W	15 W
Downlink (Frequency)	1 (15 W) 1170 (1987.0 MHz)	1 (15 W) 1170 (1987.0 MHz)	801 (1988.0 MHz)
Uplink (Frequency)	19170 (1907.0 MHz)	19170 (1907.0 MHz)	801 (1908.0 MHz)

Configuration 7:

RAT	LTE BW 5 MHz	LTE BW 5 MHz	GSM
Port	RF A	RF B	RF B
Power	15 W	15 W	15 W
Downlink (Frequency)	648 (1934.8 MHz)	648 (1934.8 MHz)	513 (1930.4 MHz)
Uplink (Frequency)	18648 (1954.8 MHz)	18648 (1954.8 MHz)	801 (1850.4 MHz)

Configuration 8:

RAT	LTE BW 1.4 MHz	LTE BW 1.4 MHz	GSM	GSM
Port	RF A	RF B	RF B	RF B
Power	15 W	15 W	7.5 W	7.5 W
Downlink (Frequency)	648 (1934.8 MHz)	648 (1934.8 MHz)	513 (1930.4 MHz)	521 (1932.0 MHz)
Uplink (Frequency)	18648 (1854.8 MHz)	18648 (1854.8 MHz)	513 (1850.4 MHz)	521 (1852.0 MHz)

Appendix 1

Configuration 9:

RAT	LTE BW 1.4 MHz	LTE BW 1.4 MHz	GSM	GSM
Port	RF A	RF B	RF B	RF B
Power	15 W	15 W	7.5 W	7.5 W
Downlink (Frequency)	1066 (1976.6 MHz)	1066 (1976.6 MHz)	801 (1988.0 MHz)	809 (1989.6 MHz)
Uplink (Frequency)	19066 (1896.6 MHz)	19066 (1896.6 MHz)	801 (1908.0 MHz)	809 (1909.6 MHz)

Configuration 10:

RAT	LTE BW 1.4 MHz	LTE BW 1.4 MHz	GSM	GSM
Port	RF A	RF B	RF B	RF B
Power	15 W	15 W	7.5 W	7.5 W
Downlink (Frequency)	764 (1946.4 MHz)	764 (1946.4 MHz)	564 (1940.6 MHz)	623 (1952.4 MHz)
Uplink (Frequency)	18764 (1866.4 MHz)	18764 (1866.4 MHz)	564 (1860.6MHz)	623 (1872.4 MHz)

Configuration 11:

RAT	LTE BW 1.4 MHz	LTE BW 1.4 MHz	GSM	GSM
Port	RF A	RF B	RF B	RF B
Power	15 W	15 W	7.5 W	7.5 W
Downlink (Frequency)	1036 (1973.6 MHz)	1036 (1973.6 MHz)	758 (1979.4 MHz)	699 (1967.6 MHz)
Uplink (Frequency)	19036 (1893.6 MHz)	19036 (1893.6 MHz)	758 (1899.4MHz)	699 (1887.6 MHz)

Appendix 1

Test set-up conducted measurements MR LTE + GSM

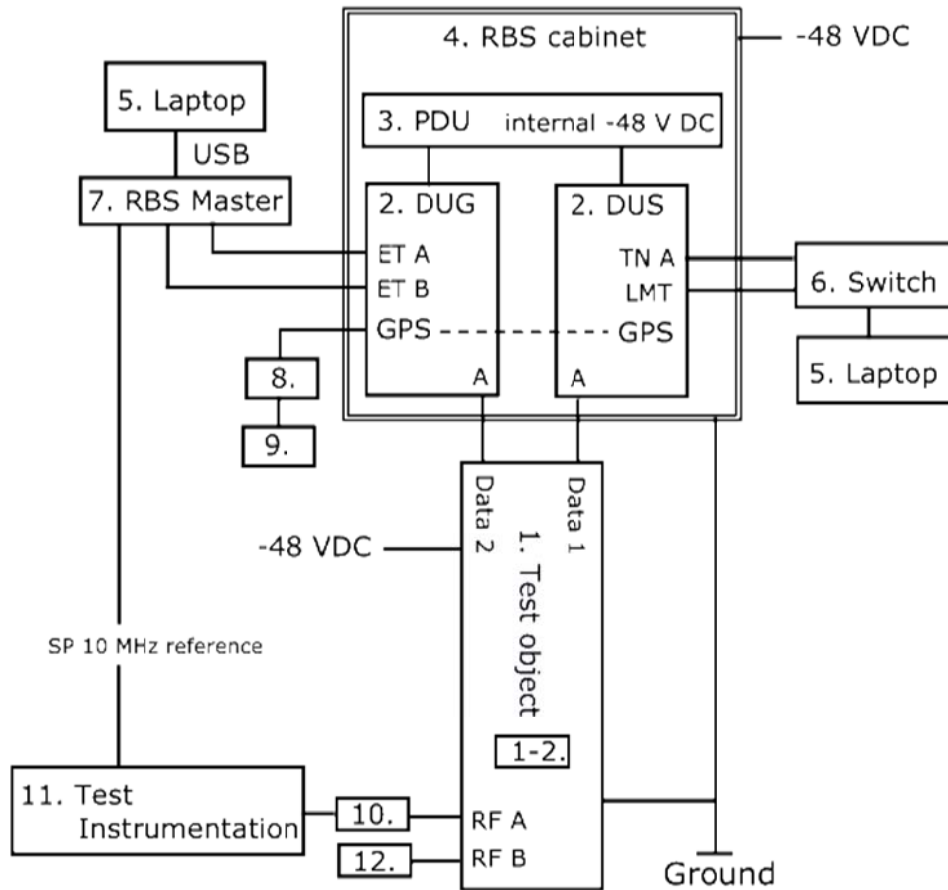

Test object:

1.	AIR 21 B2A B12P B8P, KRC 118 055/1, revision R1A, s/n: TM30003022 with software (PIS): CXP 901 3268/6 rev. R51NE 1-2. Transceiver, ARUS 1/KRC 118 054, revision R1A
----	--

Functional test equipment

2.	DUG 20 01 KDU 137 569/1, R2B, s/n: C823856118 DUS 41 01, KDU 137 624/1, rev. R6A, s/n: A401981392
3.	PDU 02 01, BMG 980 336/4, rev. R2A, s/n: BJ31528316
4.	RBS 6201 cabinet, BAMS – 1000778792
5.	Controlling laptop HP EliteBook 8560 w, BAMS – 1001236858
6.	Fast Ethernet switch, Netgear FS726T
7.	RBS master 2E, LPY 107 1007/3, BAMS – 1001195172
8.	GPS 02 01, NCD 901 41/1, rev. R1D, s/n: TU8K474887
9.	GPS Active Antenna, KRE 101 2082/1
10.	Attenuator, according respective appendix
11.	SP Test Instrumentation according to measurement equipment list
12.	Terminator, 50 ohm

Appendix 1

Test setup radiated measurements MR LTE + GSM

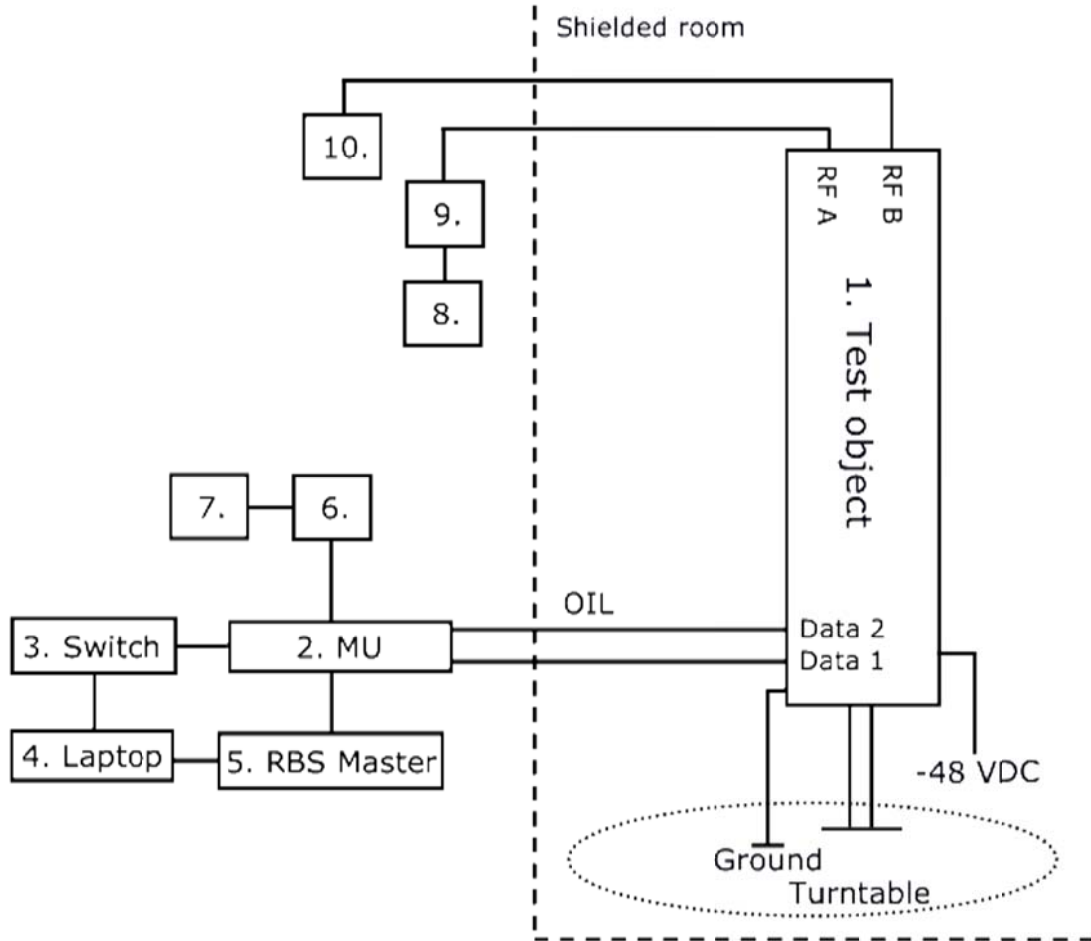

Test object:

1.	AIR 21 B2A B12P B5P, KRC 118 054/1, revision R1A, s/n: CQ301 13021 (FCC ID: TA8AKRC118054-1 / IC: 287AB-AS1180541) with software (PIS): CXP 901 3268/6 rev. R51NE Transceiver, ARUS 1/KRC 118 054, revision R1A
----	--

Functional test equipment:

2.	Main Unit SUP 6601, 1/BFL 901 009/4, rev. R1E, s/n: BR88236818 DUG 20 01 KDU 137 569/1, R2B, s/n: C823856118 DUS 41 01, KDU 137 624/1, rev. R6A, s/n: A401981869
3.	Fast Ethernet switch, Netgear FS726T
4.	Laptop, EliteBook 8560w, BAMS – 1001236854
5.	RBS master 2E, LPY 107 1007/3, BAMS – 1000735211
6.	GPS 02 01, NCD 901 41/1, rev. R1D, s/n: TU8K357393
7.	GPS Active Antenna, KRE 101 2082/1
8.	FSIQ 40, SP number: 503 738, for supervision purpose only
9.	Attenuator
10.	Terminator 50 ohm

Appendix 1

Interfaces:	Type of port:
Power: -48 VDC	DC Power
Antenna port (A), (passive antenna), 7/ 16- connector	Antenna
Antenna port (B), (passive antenna), 7/ 16- connector	Antenna
Data 1, Optical Interface Link, single mode opto fibre	Signal
Data 2, Optical Interface Link, single mode opto fibre, not in use	Signal
Ground wire	Ground

RBS software:

RAT	Software	Revision
GSM	DXPR73LZ	R50B
LTE	CXP 102 051/19	R22EU

Appendix 2

RF power output measurements according to CFR 47 §24.232 / IC RSS-133 6.4

Date	Temperature	Humidity
2013-10-31	23 °C ± 3 °C	41% ± 5 %
2013-11-26	24 °C ± 3 °C	15% ± 5 %

Test set-up and procedure

The test object was connected to a signal analyzer measuring peak and RMS output power in CDF mode. A RBW of 50 MHz was used.

Measurement equipment	SP number
Rohde & Schwarz signal analyzer FSQ40	504 143
RF attenuator	901 508
Testo 635 temperature and humidity meter	504 203

Measurement uncertainty: 1.1 dB

Results

Measured total output power.

Nominal output power at RF A: 41.8 dBm

Nominal output power at RF B: 44.8 dBm

Tested configuration	RF A	RF B
	L [RMS dBm/ dB PAR]	L+G [RMS dBm/ dB PAR]
1	41.97/ 8.05	44.90/ 6.90
2	42.00/ 8.05	44.89/ 6.90
3	42.01/ 8.03	44.97/ 6.71
4	41.95/ 8.05	44.98/ 6.75
5	41.97/ 8.03	44.98/ 6.75
6	41.83/ 8.03	45.00/ 6.56
8	42.07/ 8.05	44.98/ 7.07
9	41.78/ 8.05	44.98/ 7.12
10	41.96/ 8.05	44.90/ 6.97
11	41.98/ 8.05	44.96/ 6.95

Note: The PAR value is the 0.1 % Peak to Average Ratio.

Appendix 2

Measured output power per 1 MHz

Tested configuration	RF A L [RMS dBm]	RF B L+G [RMS dBm]	Total power of LTE ¹⁾ [RMS dBm]
1	L=40.88	L=41.00, G=41.64	44.00
2	L=40.92	L=41.01, G=41.59	44.01
3	L=40.95	L=40.89, G=41.92	43.95
4	L=40.89	L=40.92, G=42.05	43.92
5	L=40.86	L=40.89, G=42.12	43.89
6	L=40.58	L=41.39, G=42.58	44.39
8	L=40.94	L=40.80, G=38.99, G=39.16	43.94
9	L=40.82	L=40.86, G=39.01, G=39.04	43.86
10	L=40.88	L=40.80, G=38.93, G=39.11	43.88
11	L=40.86	L=40.69, G=39.03, G=39.00	43.88

¹⁾: Measured according to FCC KDB662911 D01 Multiple Transmitter Output v02r01. Method E), 2), c), “measure and add $10 \log(N_{ANT})$ ”.

Limits

§24.232 The maximum output power may not exceed 3280 W/MHz (EIRP).
The Peak to Average Ratio (PAR) may not exceed 13 dB.

RSS-133 Base station transmitters operating in the band 1930-1995 MHz shall not have output power exceeding 100 watts. When the transmitter power is measured in terms of average value, the peak-to-average ratio(PAR) of the power shall not exceed 13 dB

There is no EIRP limit specified for base station equipment in the RSS-133.

EIRP compliance is addressed at the time of licensing, as required by the responsible IC Bureau. Licensee’s are required to take into account the antenna gain to get the maximum usable power settings to prevent the radiated output power to exceed the EIRP limits specified in SRSP-510

Complies?	Yes
-----------	-----

Appendix 3

Conducted spurious emission measurements according to CFR 47 §24.238 / IC RSS-133 6.5

Date	Temperature	Humidity
2013-10-31	23 °C ± 3 °C	41% ± 5 %
2013-11-26	24 °C ± 3 °C	15% ± 5 %

Test set-up and procedure

The measurements were made per definition in §24.238. The output was connected to a spectrum analyzer with a RBW setting of 1 MHz and RMS detector activated. The spectrum analyzer was connected to an external 10 MHz reference standard during the measurements.

Before comparing the results to the limit, 3 dB [10 log (2)] should be added according to method E), 3), a), (iii) Measure and add 10 log(N_{ANT})” of FCC KDB662911 D01 Multiple Transmitter Output v02r01.

Measurement equipment	SP number
Rohde & Schwarz signal analyzer FSQ40	504 143
RF attenuator	901 508
High pass filter	901 501
Testo 635 temperature and humidity meter	504 203

Measurement uncertainty: 3.7 dB

Results

Diagram	Tested configuration	Tested Port
1 a-e	1	RF B
2 a-e	2	RF B
3 a-e	3	RF B
4 a-e	4	RF B
5 a-e	5	RF B
6 a-e	6	RF B
7 a-e	8	RF B
8 a-e	9	RF B
9 a-e	10	RF B
10 a-e	11	RF B



Appendix 3

Remarks

The emission at 9 kHz on the plots was not generated by the test object. A complementary measurement with a smaller RBW showed that it was related to the LO feed-through.

Limits

§24.238 and RSS-133 6.5

Outside a licensee's frequency band(s) of operation the power of any emission shall be attenuated below the transmitter power (P) by at least $43 + 10 \log (P)$ dB, resulting in a limit of -13 dBm per 1 MHz RBW.

Complies?	Yes
-----------	-----

Appendix 3

Diagram 1 a:

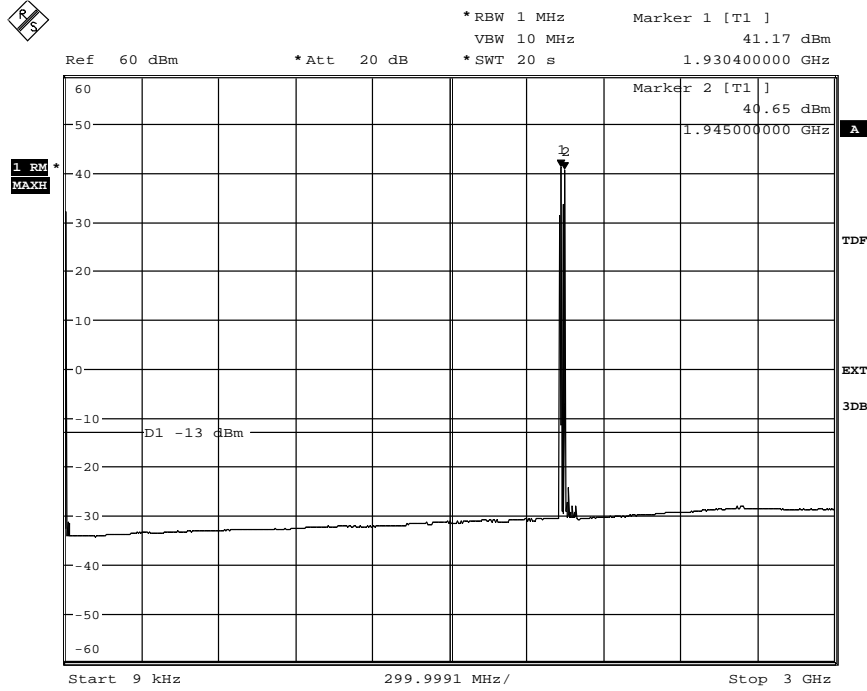

Date: 31.OCT.2013 17:27:11

Diagram 1 b:

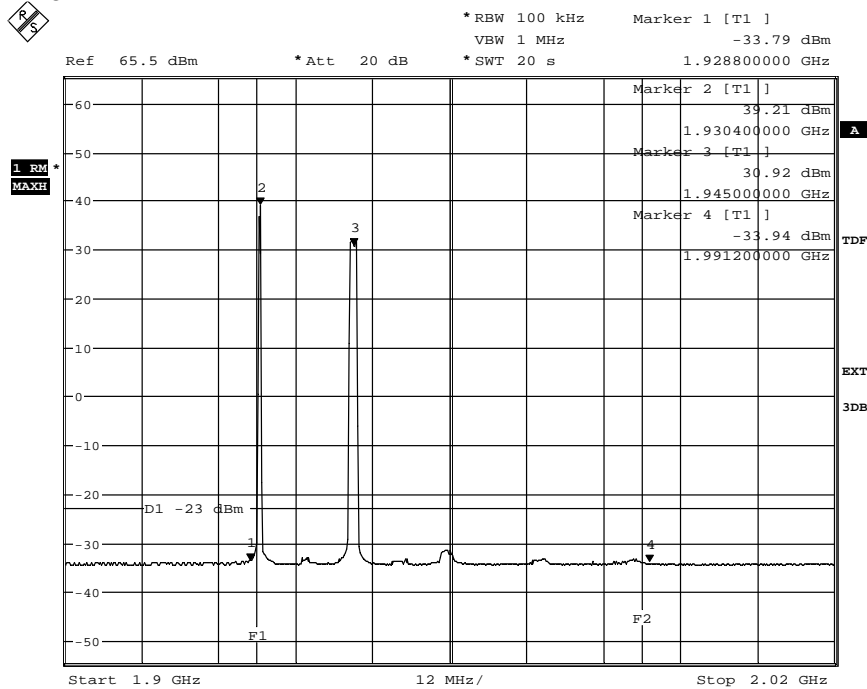

Date: 31.OCT.2013 17:28:56

Appendix 3

Diagram 1 c:

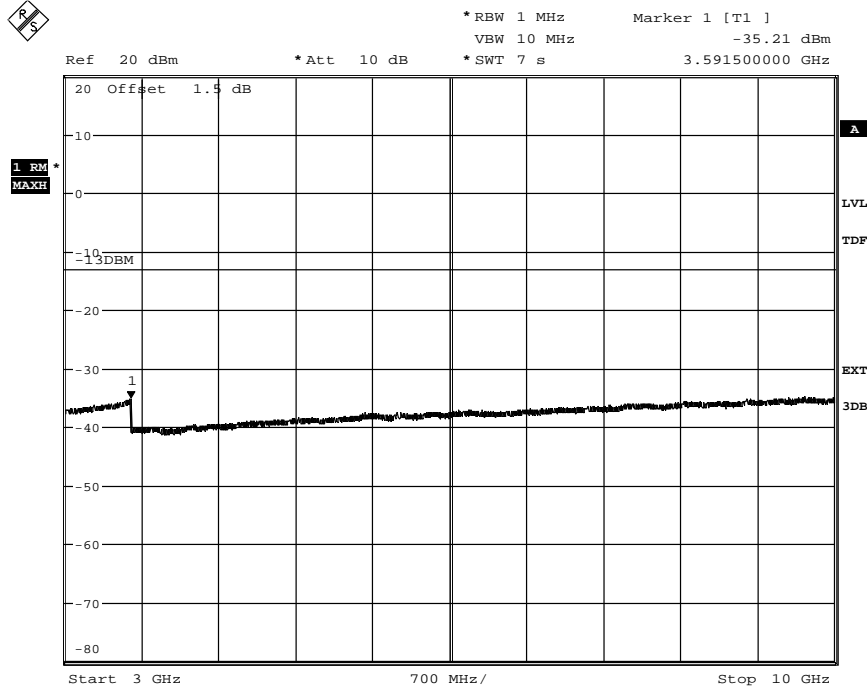

Date: 31.OCT.2013 17:32:41

Diagram 1 d:

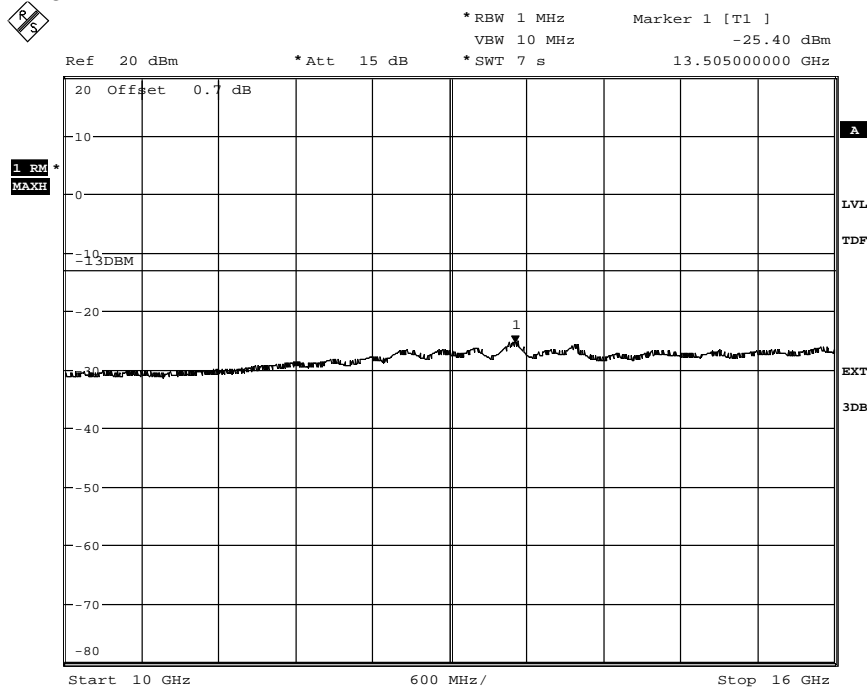

Date: 31.OCT.2013 17:34:29

Appendix 3

Diagram 1 e:

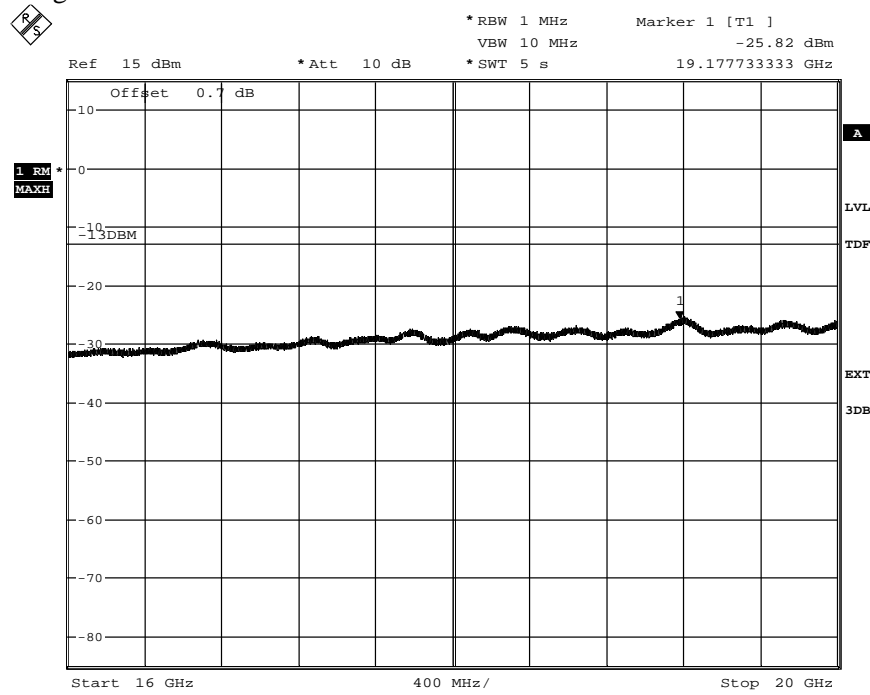

Date: 31.OCT.2013 17:35:07

Appendix 3

Diagram 2 a:

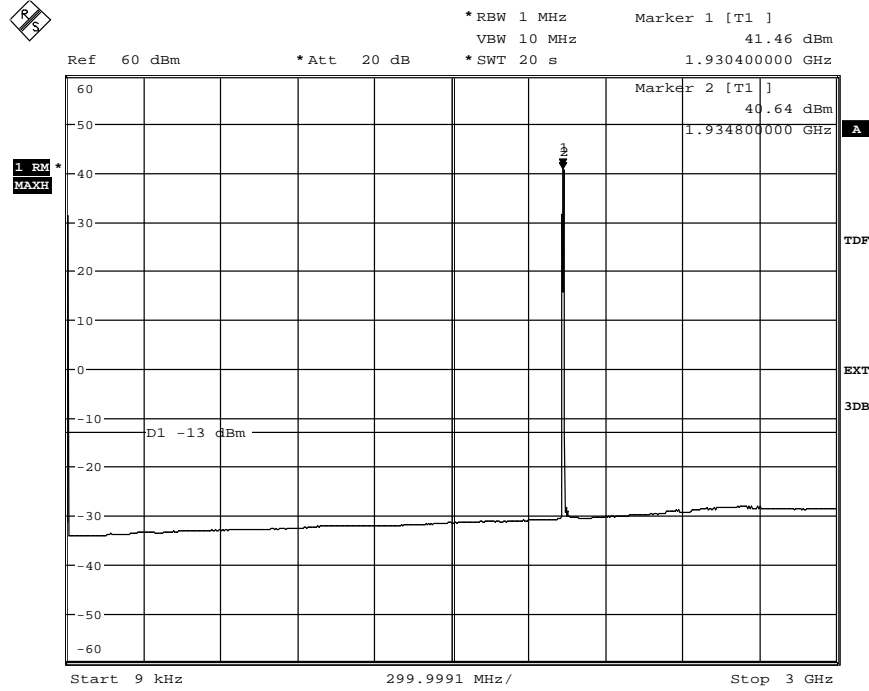

Date: 31.OCT.2013 17:51:32

Diagram 2 b:

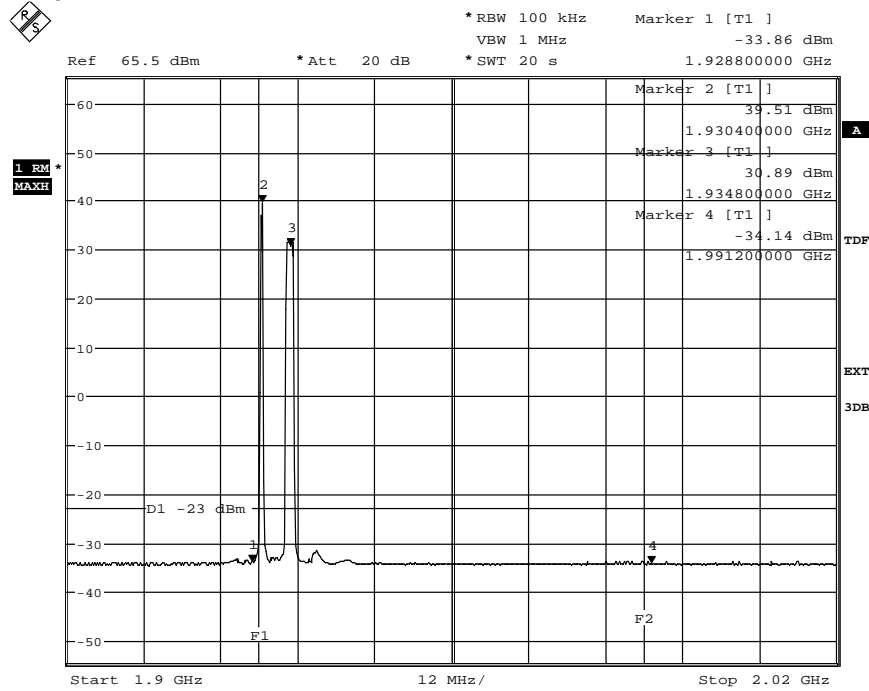

Date: 31.OCT.2013 21:25:34

Appendix 3

Diagram 2 c:

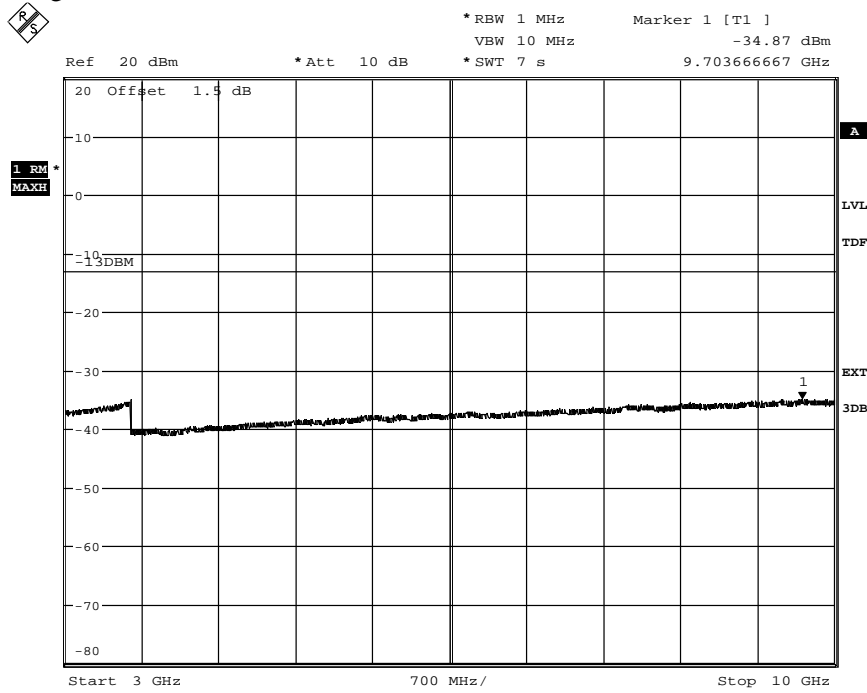

Date: 31.OCT.2013 17:55:44

Diagram 2 d:

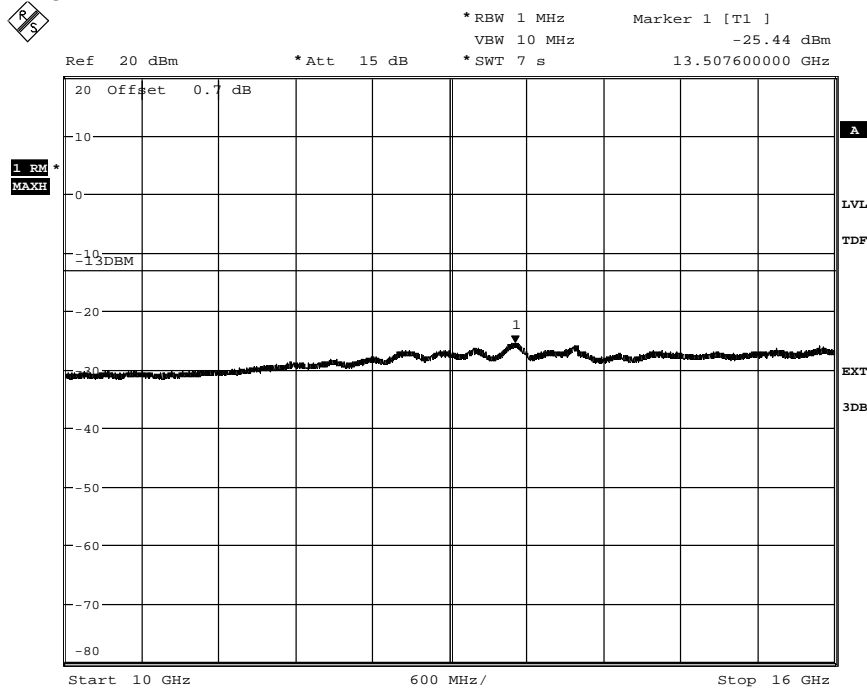

Date: 31.OCT.2013 17:56:57

Appendix 3

Diagram 2 e:

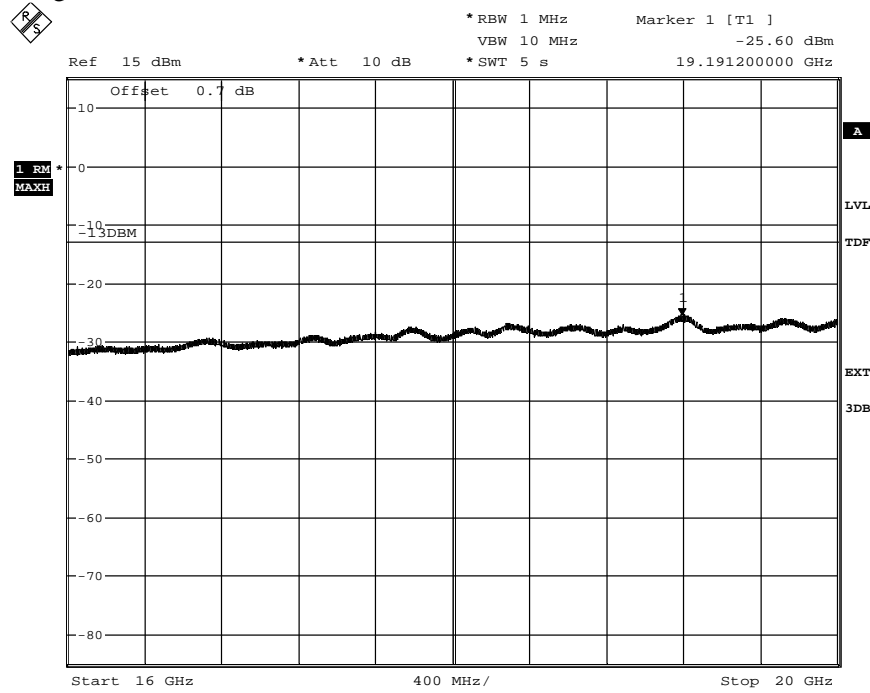

Date: 31.OCT.2013 17:58:10

Appendix 3

Diagram 3 a:

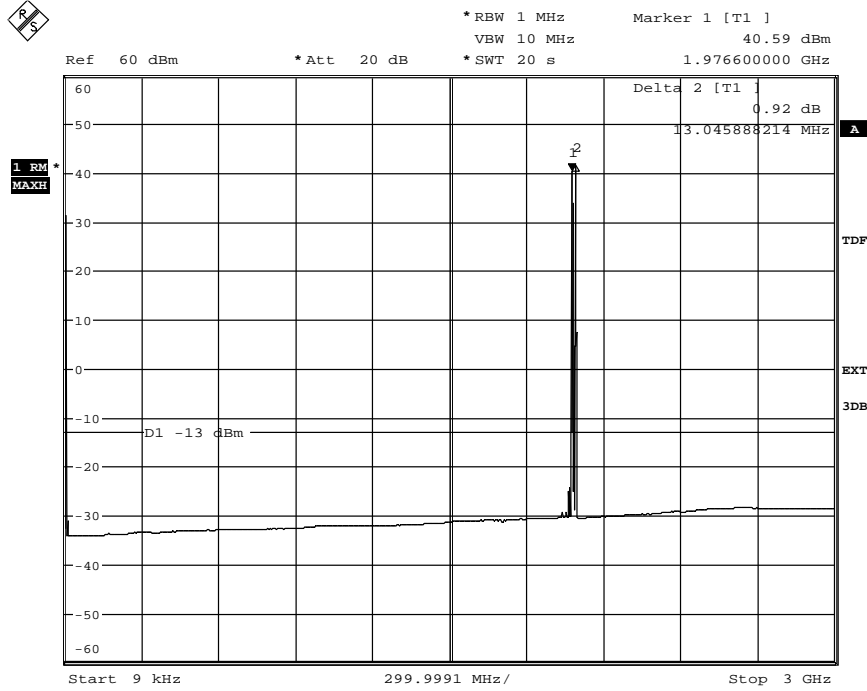

Date: 31.OCT.2013 19:11:15

Diagram 3 b:

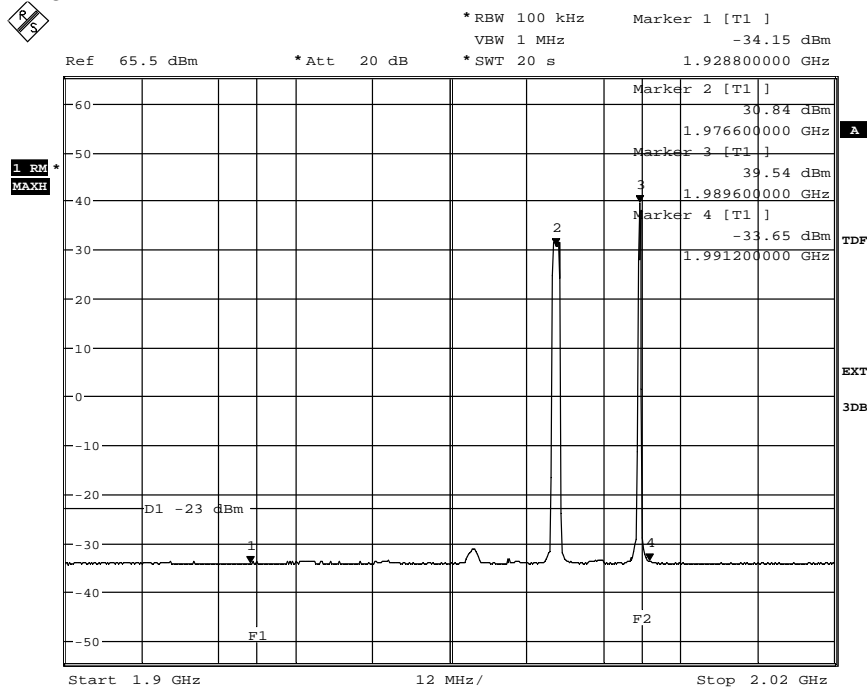

Date: 31.OCT.2013 18:10:14

Appendix 3

Diagram 3 c:

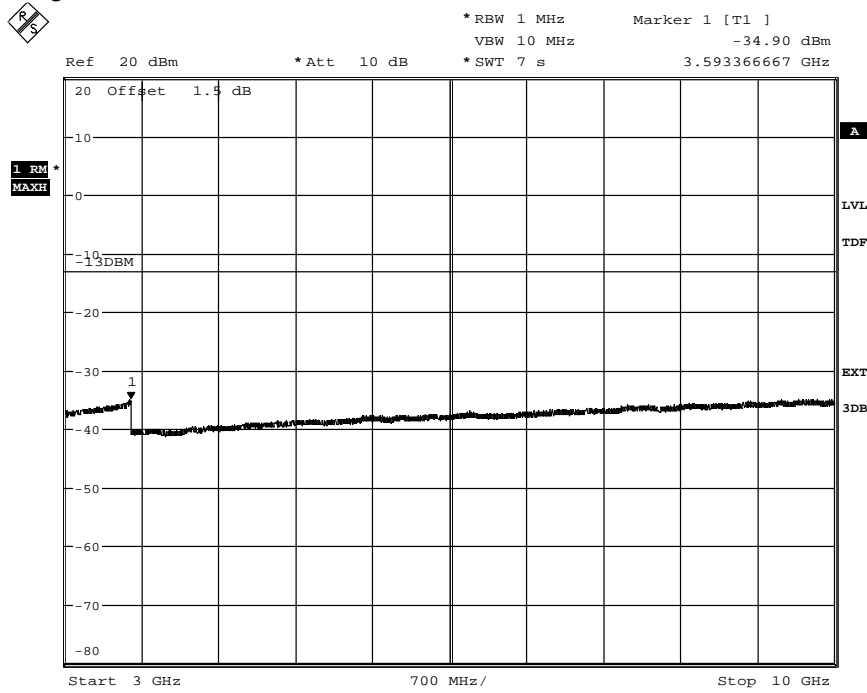

Date: 31.OCT.2013 18:04:25

Diagram 3 d:

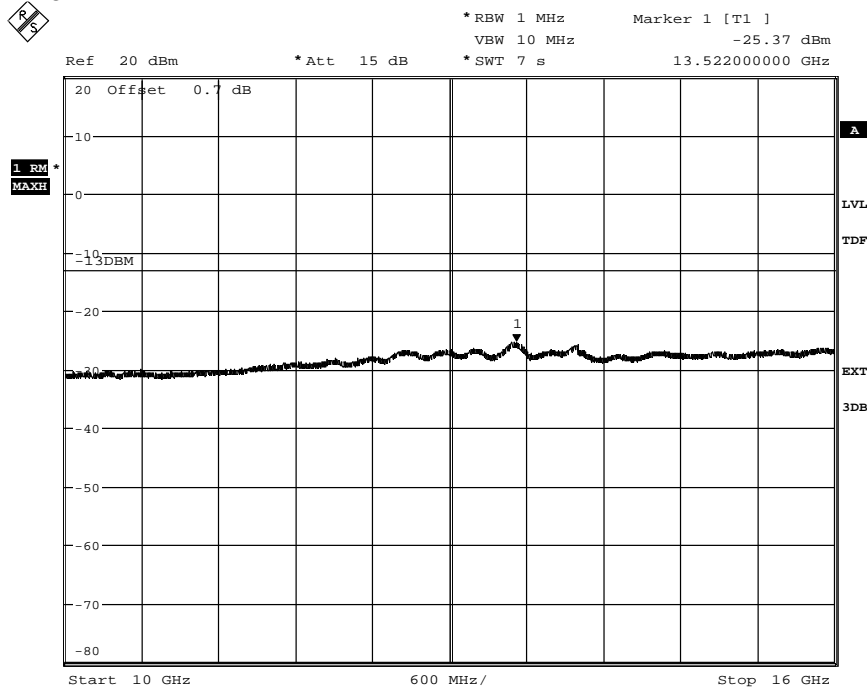

Date: 31.OCT.2013 18:03:05

Appendix 3

Diagram 3 e:

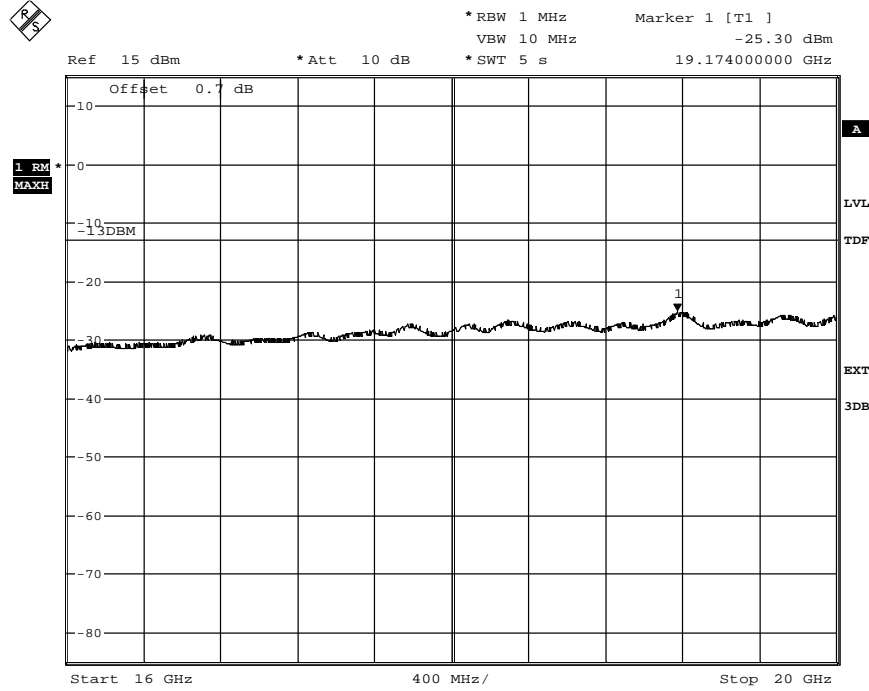

Date: 31.OCT.2013 18:01:28

Appendix 3

Diagram 4 a:

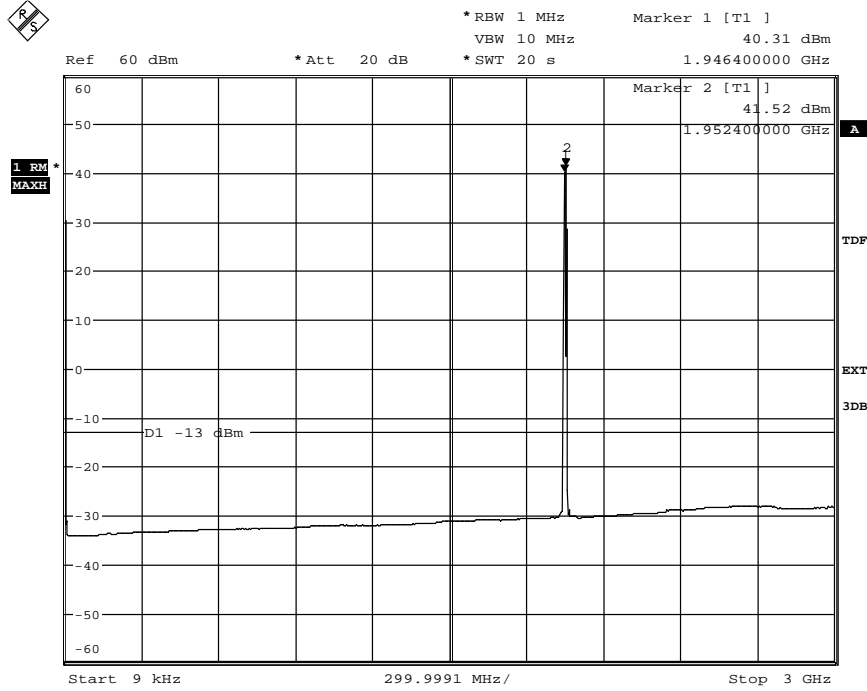

Date: 31.OCT.2013 19:43:52

Diagram 4 b:

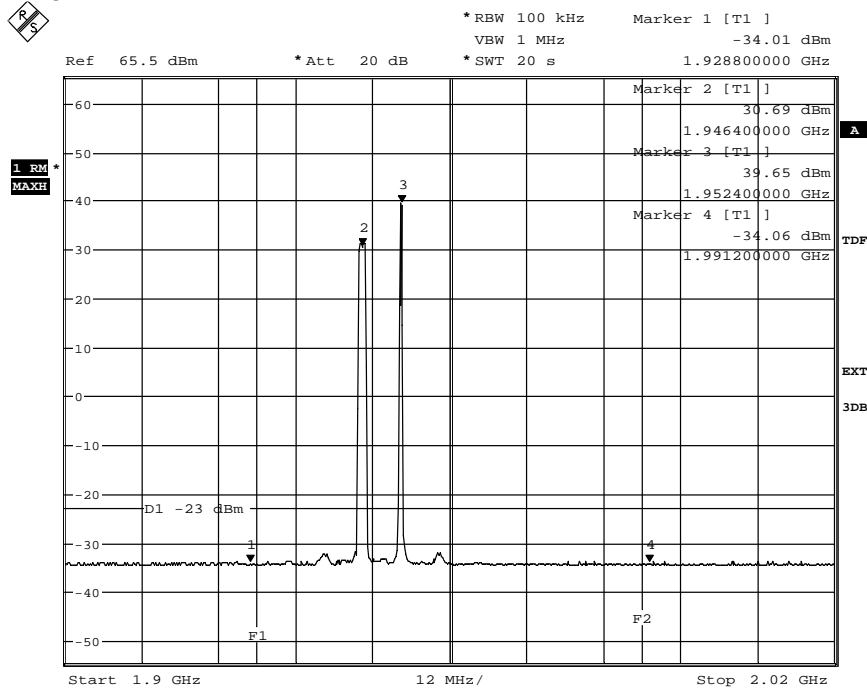

Date: 31.OCT.2013 19:45:28

Appendix 3

Diagram 4 c:

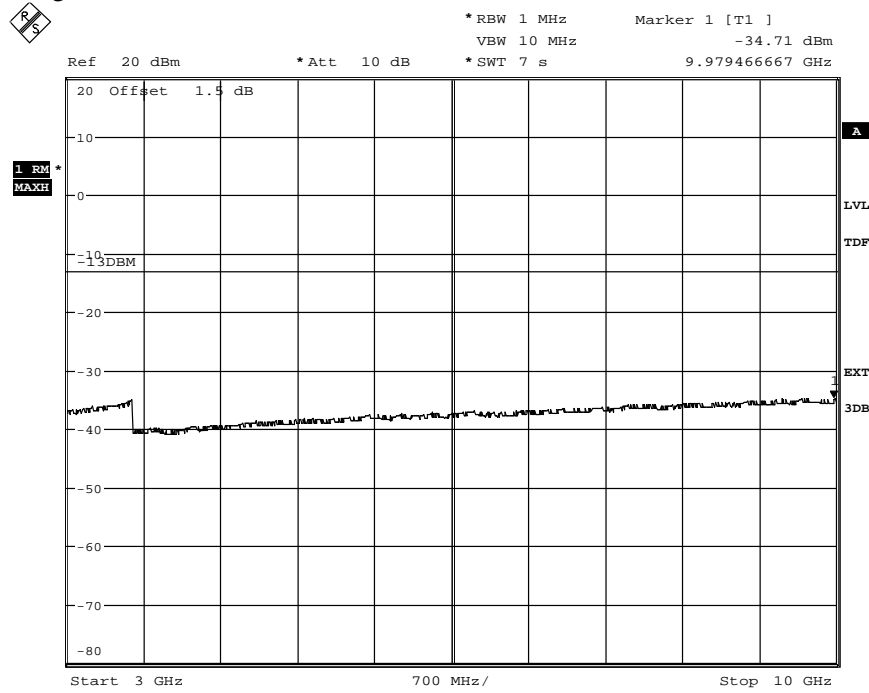

Date: 31.OCT.2013 20:01:16

Diagram 4 d:

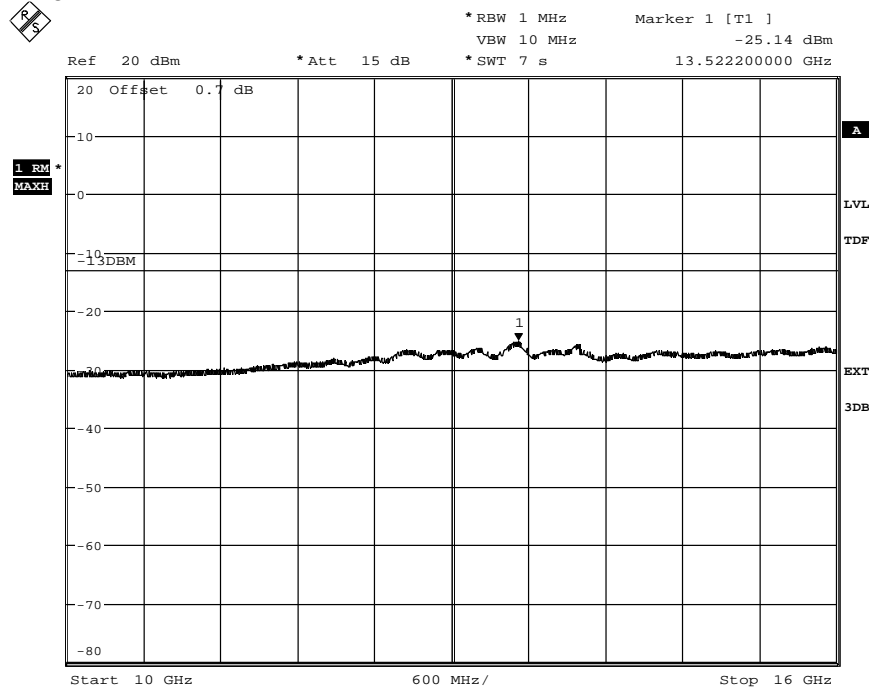

Date: 31.OCT.2013 20:03:06

Appendix 3

Diagram 4 e:

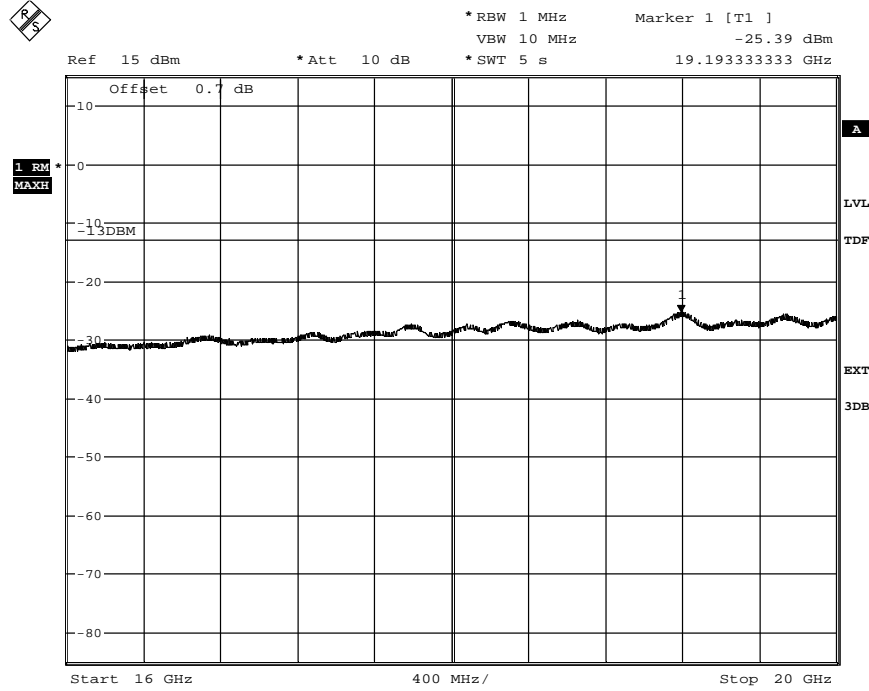

Date: 31.OCT.2013 20:05:28

Appendix 3

Diagram 5 a:

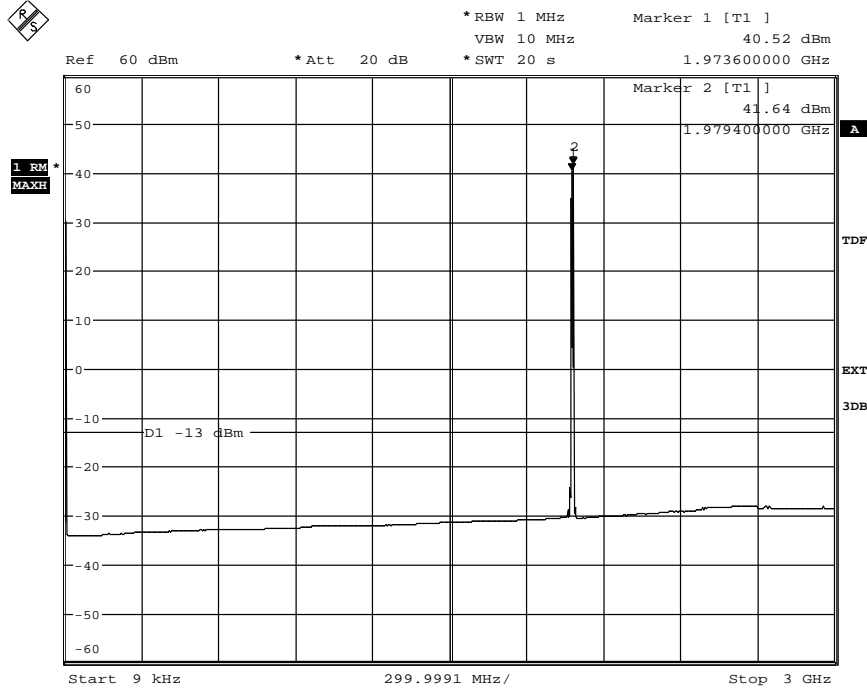

Date: 31.OCT.2013 20:33:45

Diagram 5 b:

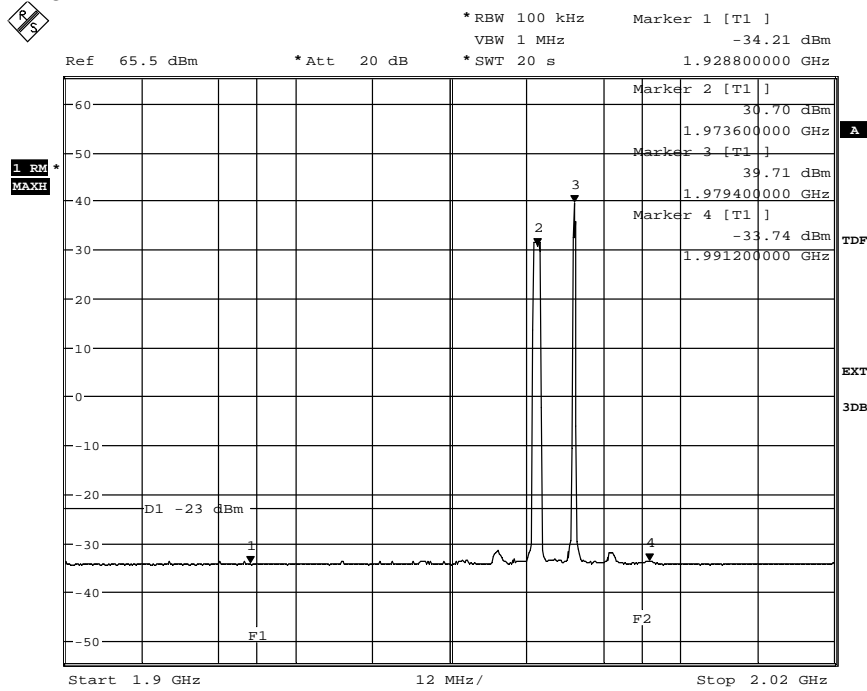

Date: 31.OCT.2013 20:31:02

Appendix 3

Diagram 5 c:

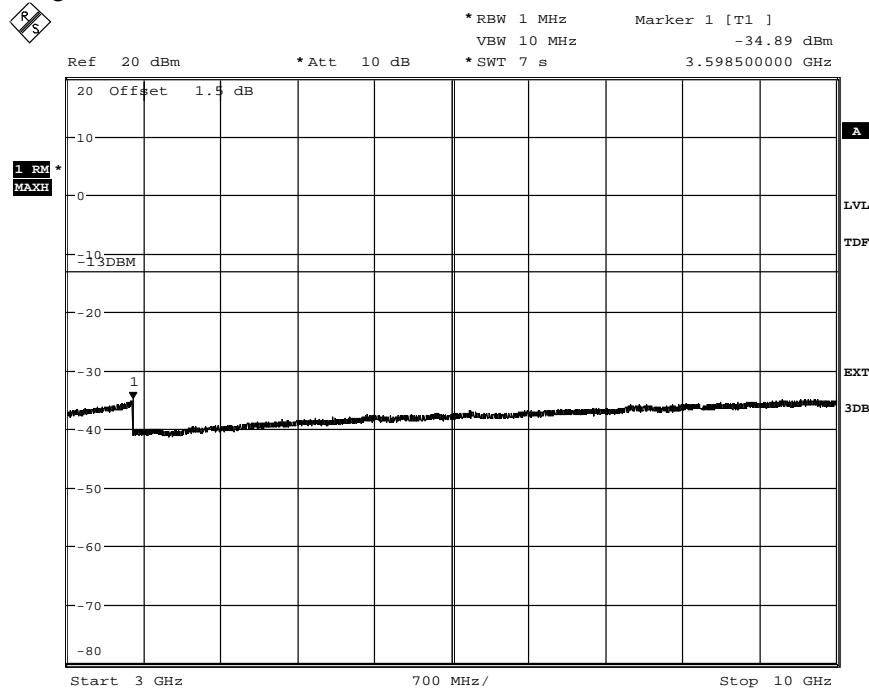

Date: 31.OCT.2013 20:28:24

Diagram 5 d:

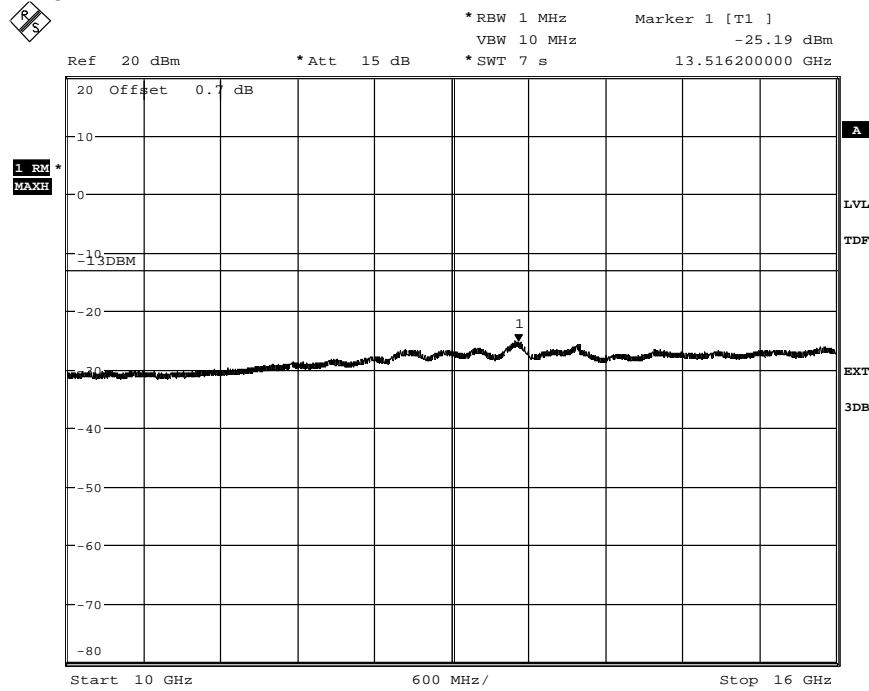

Date: 31.OCT.2013 20:27:10

Appendix 3

Diagram 5 e:

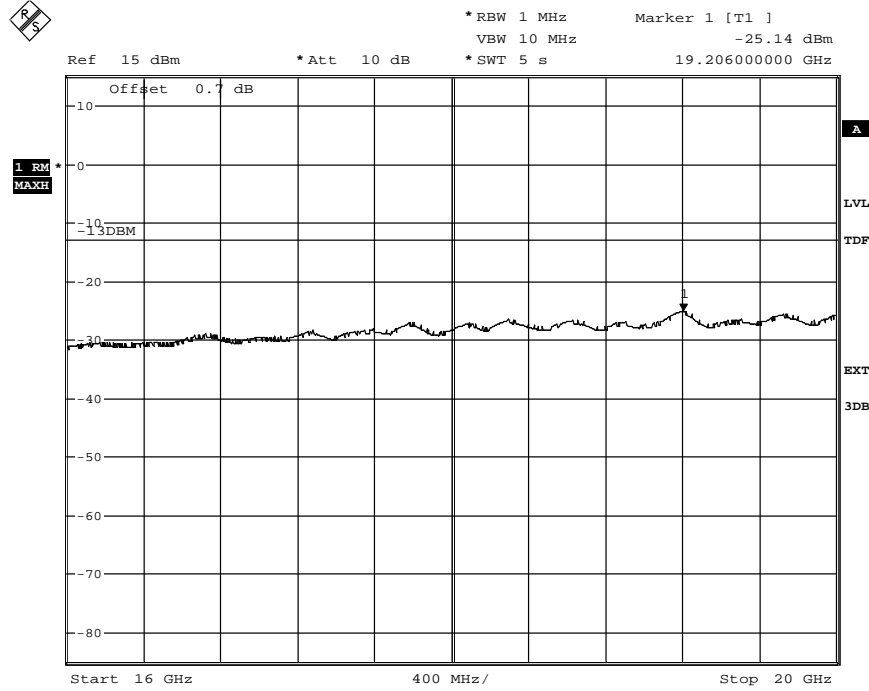

Date: 31.OCT.2013 20:25:41

Appendix 3

Diagram 6 a:

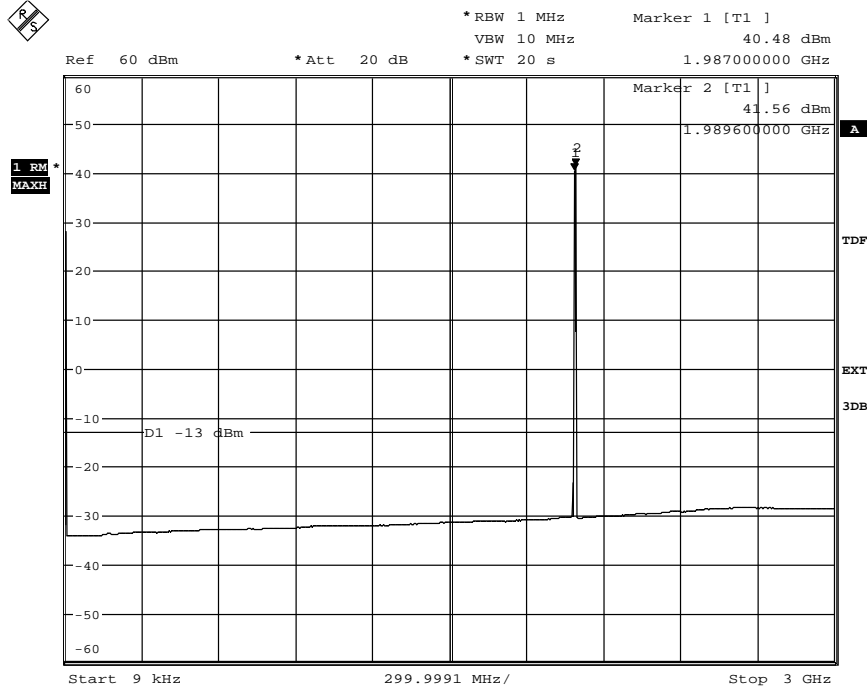

Date: 31.OCT.2013 21:11:35

Diagram 6 b:

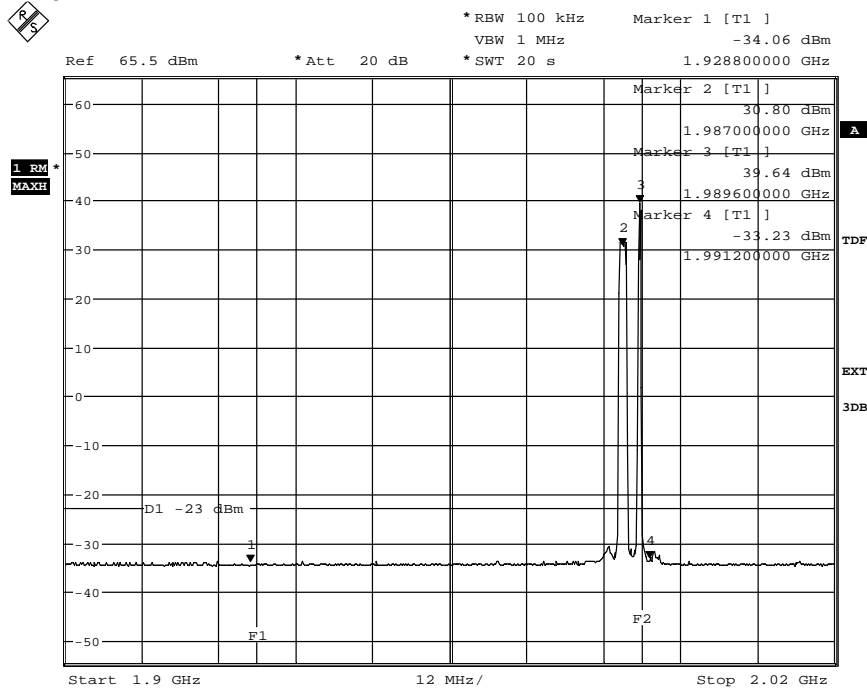

Date: 31.OCT.2013 21:13:17

Appendix 3

Diagram 6 c:

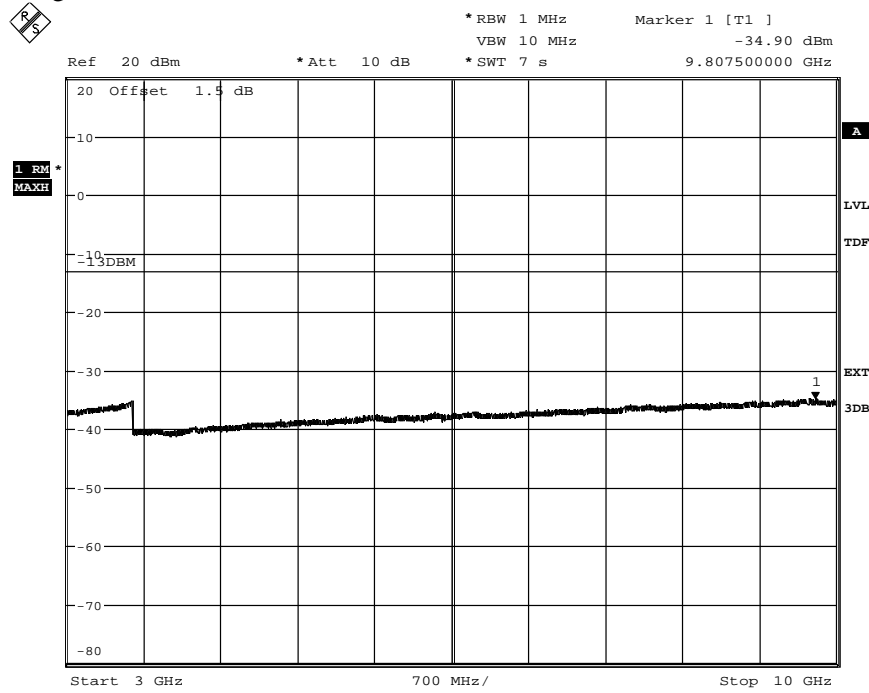

Date: 31.OCT.2013 21:15:49

Diagram 6 d:

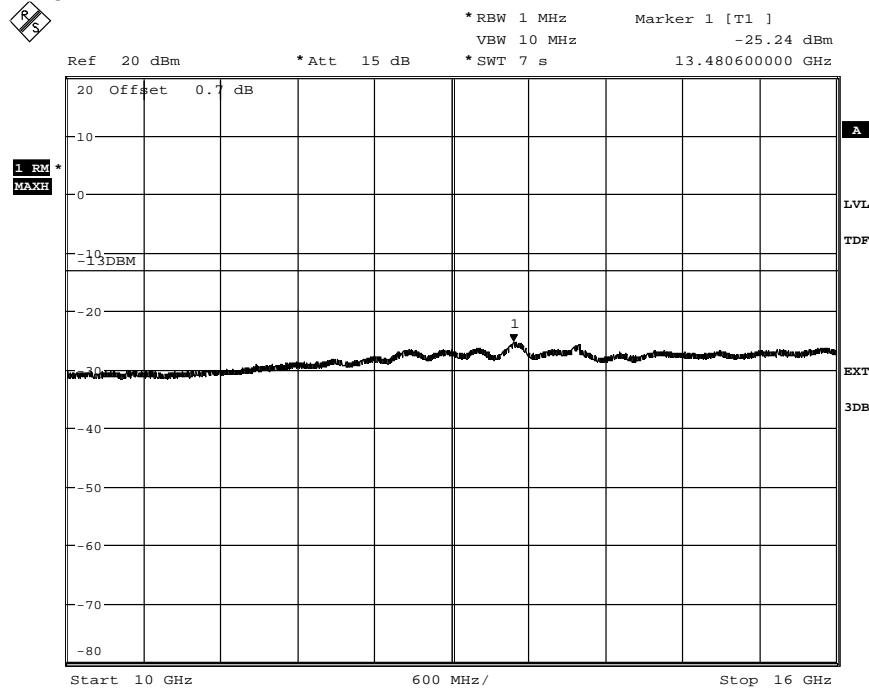

Date: 31.OCT.2013 21:17:21

Appendix 3

Diagram 6 e:

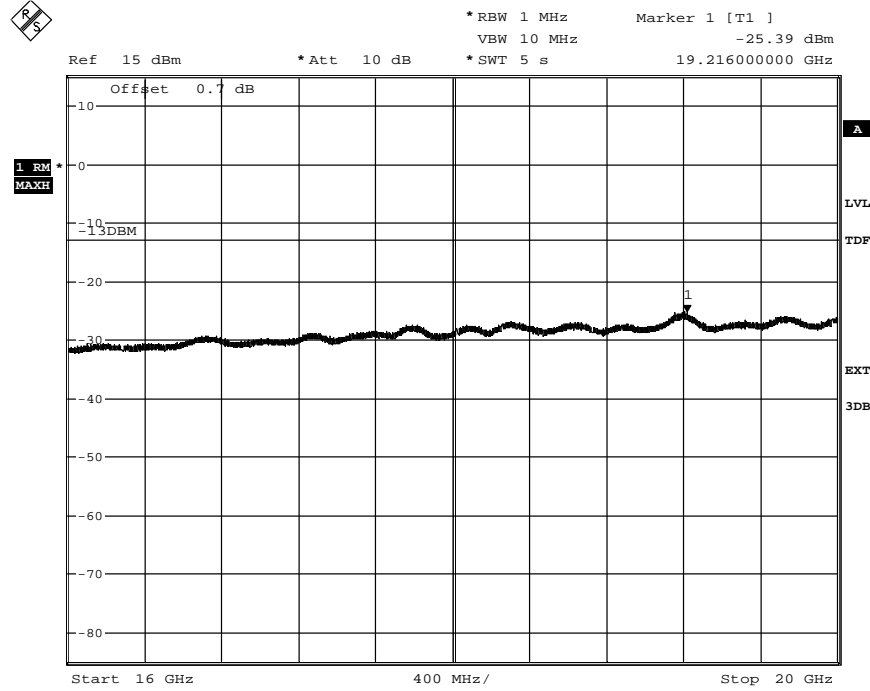

Date: 31.OCT.2013 21:18:39

Appendix 3

Diagram 7 a:

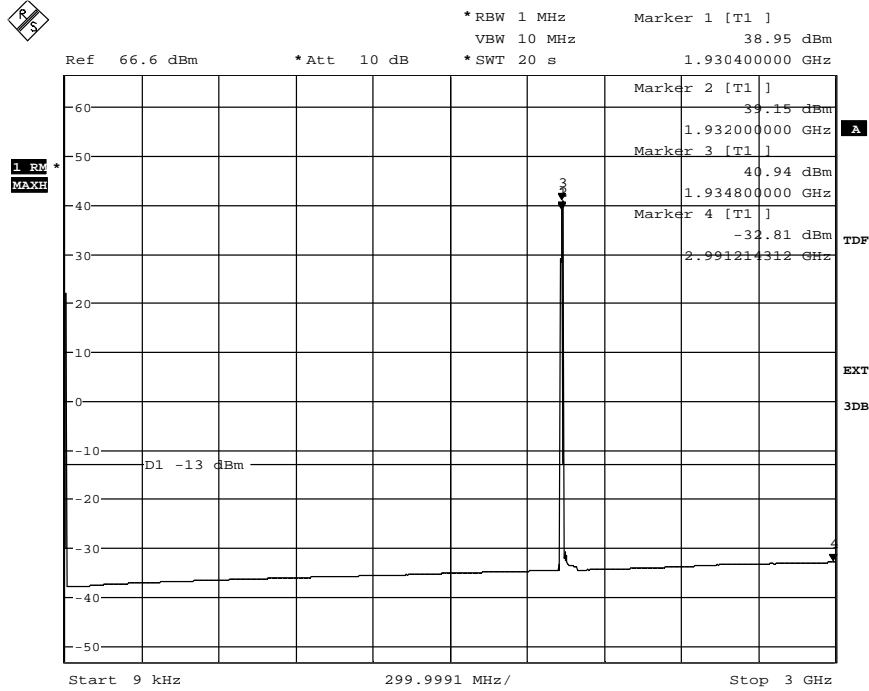

Date: 26.NOV.2013 12:26:31

Diagram 7 b:

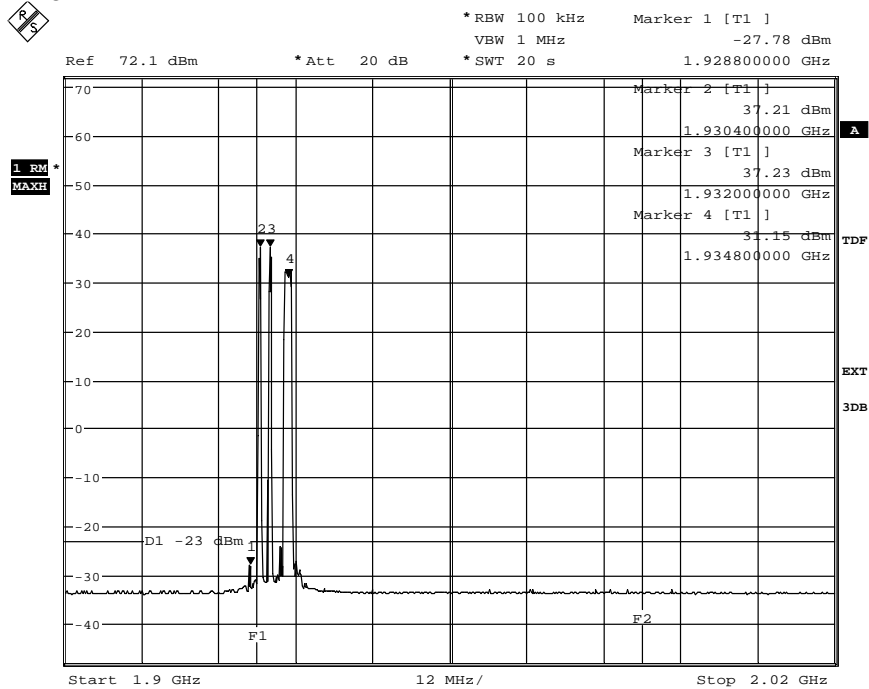

Date: 26.NOV.2013 12:29:42

Appendix 3

Diagram 7 c:

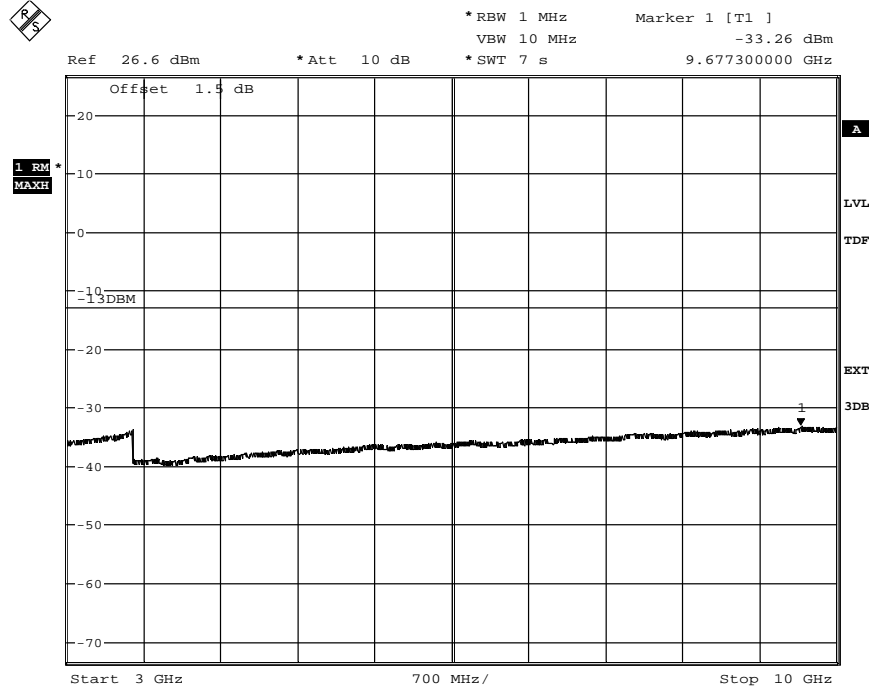

Date: 26.NOV.2013 12:32:41

Diagram 7 d:

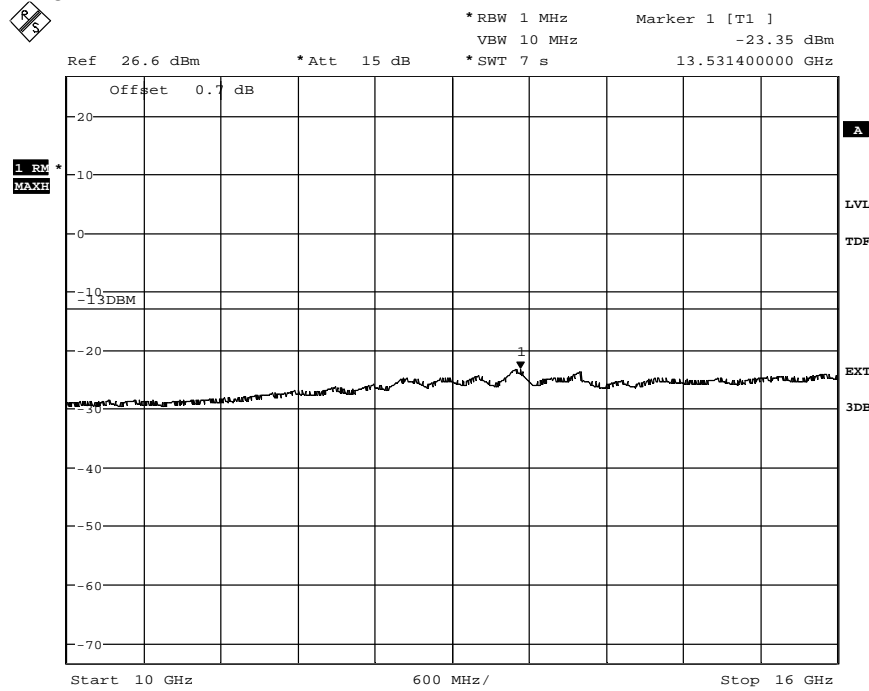

Date: 26.NOV.2013 12:34:59

Appendix 3

Diagram 7 e:

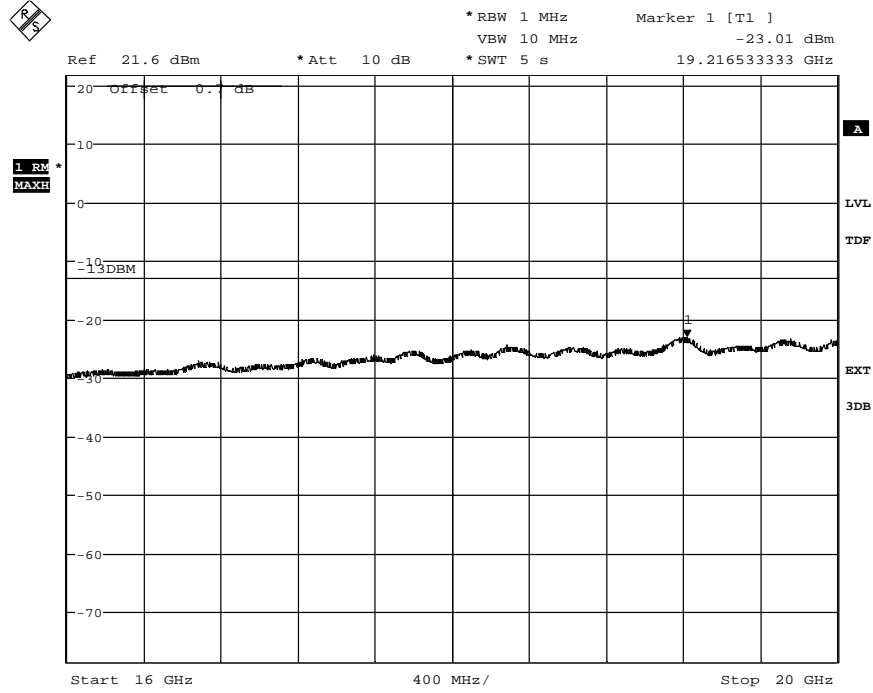

Date: 26.NOV.2013 12:37:49

Appendix 3

Diagram 8 a:

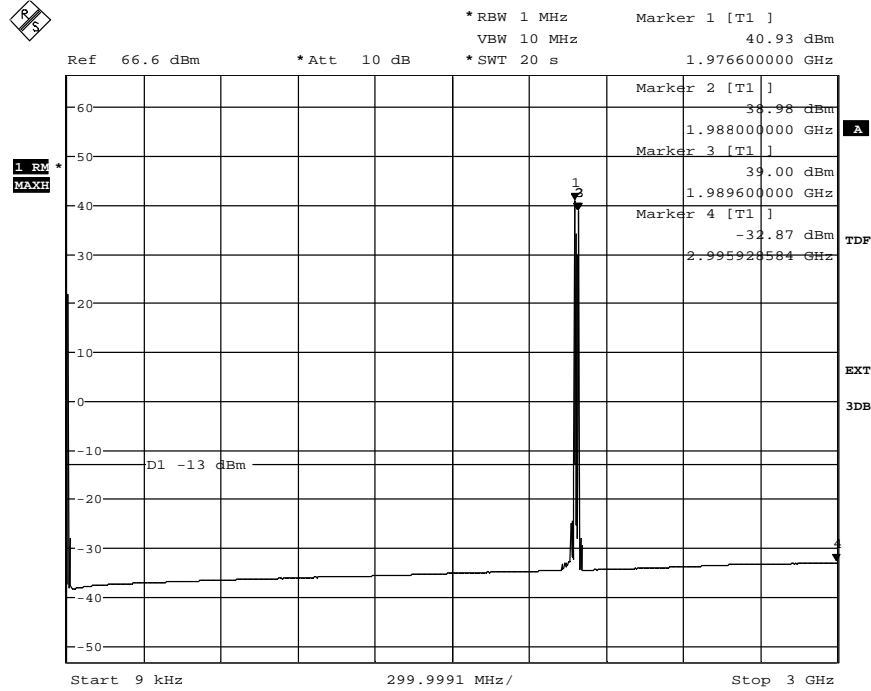

Date: 26.NOV.2013 15:30:05

Diagram 8 b:

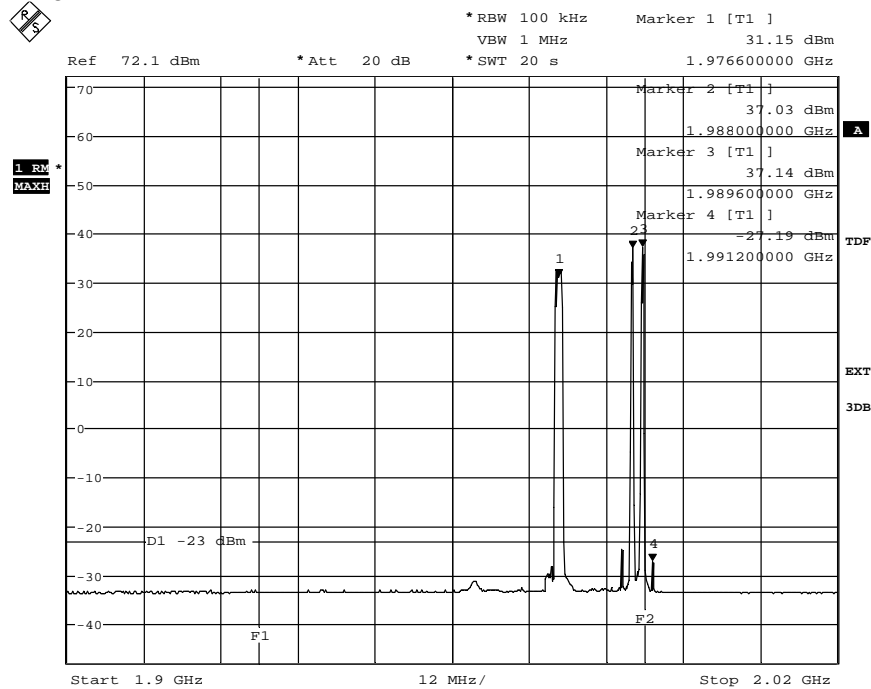

Date: 26.NOV.2013 15:33:13

Appendix 3

Diagram 8 c:

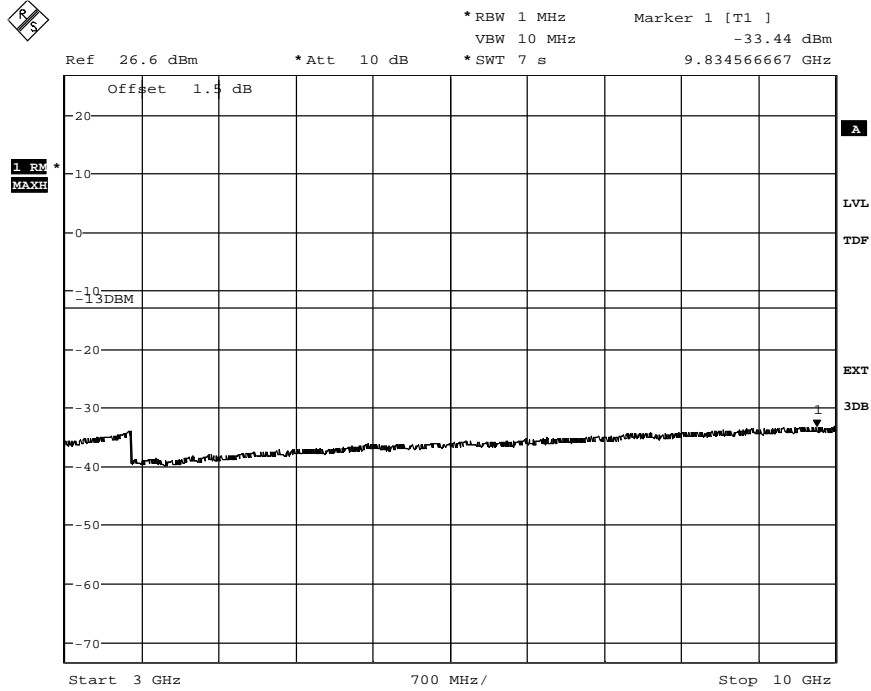

Date: 26.NOV.2013 15:36:25

Diagram 8 d:

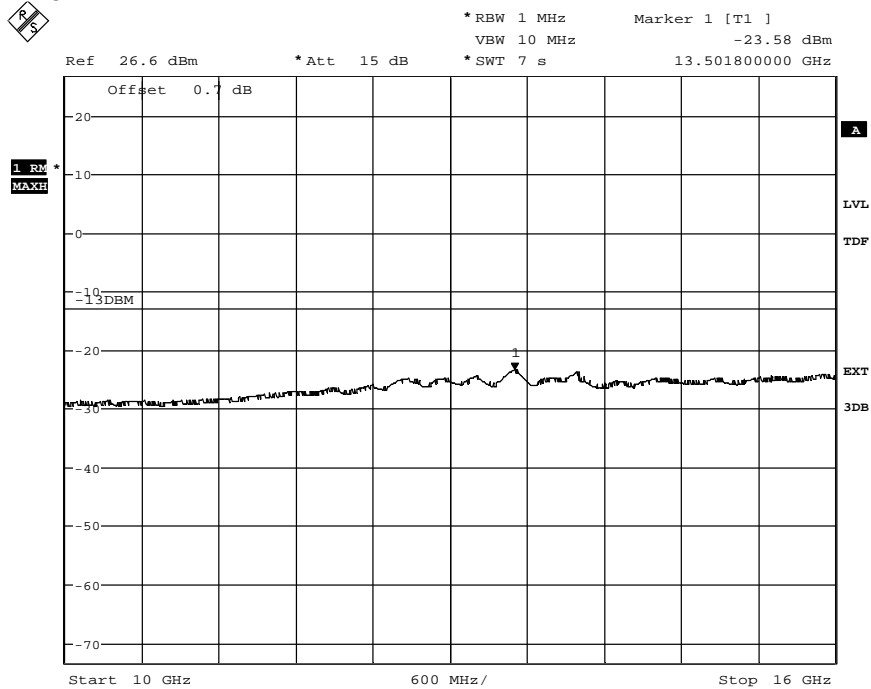

Date: 26.NOV.2013 15:38:53

Appendix 3

Diagram 8 e:

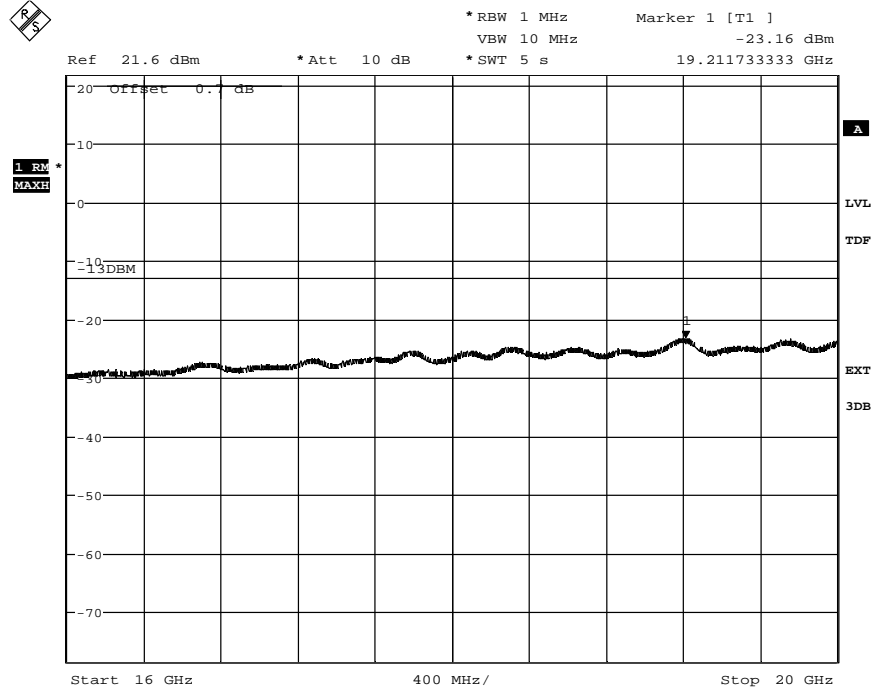

Date: 26.NOV.2013 15:39:57

Appendix 3

Diagram 9 a:

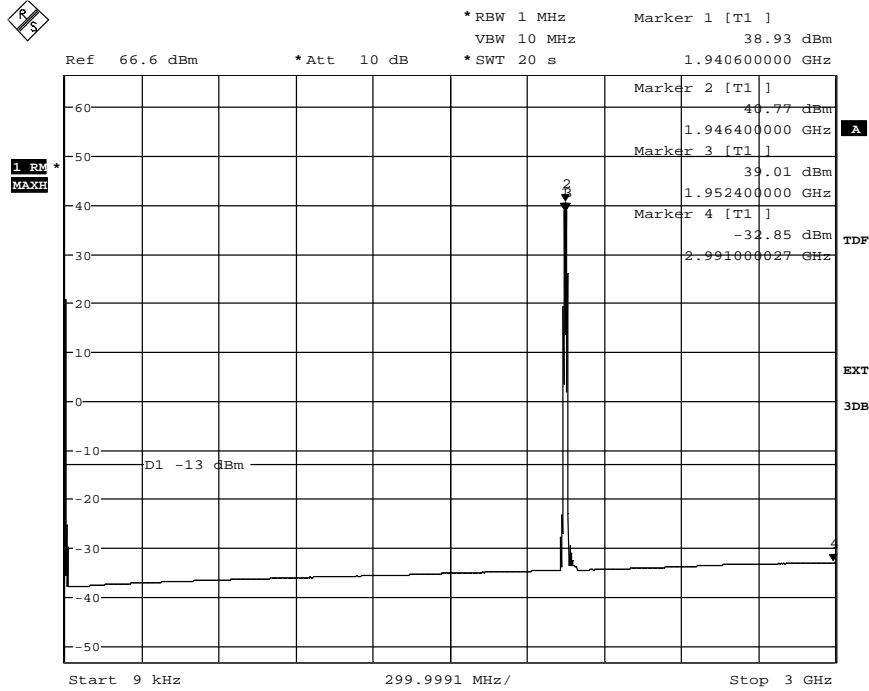

Date: 26.NOV.2013 15:02:23

Diagram 9 b:

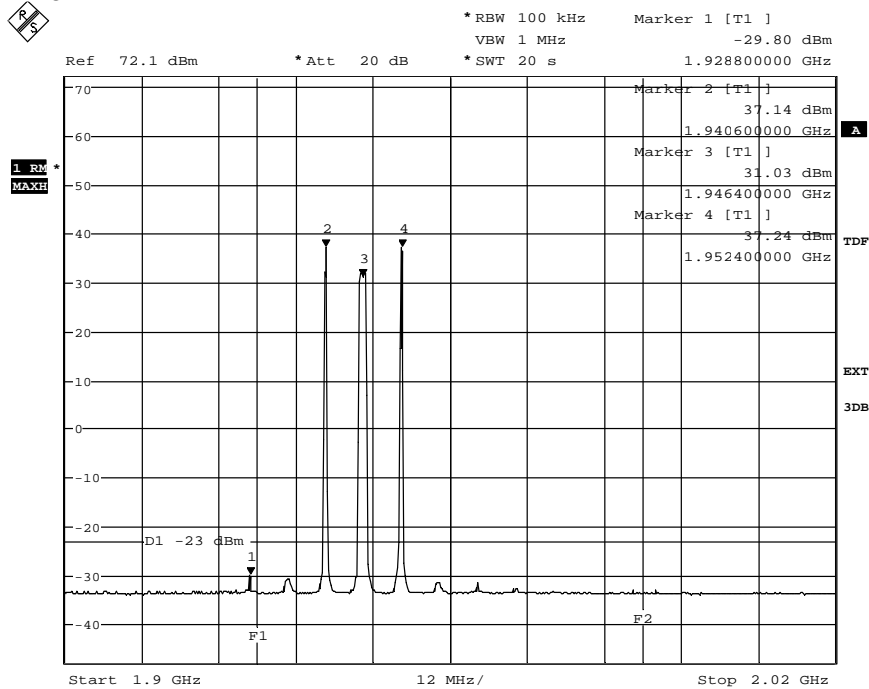

Date: 26.NOV.2013 15:11:24

Appendix 3

Diagram 9 c:

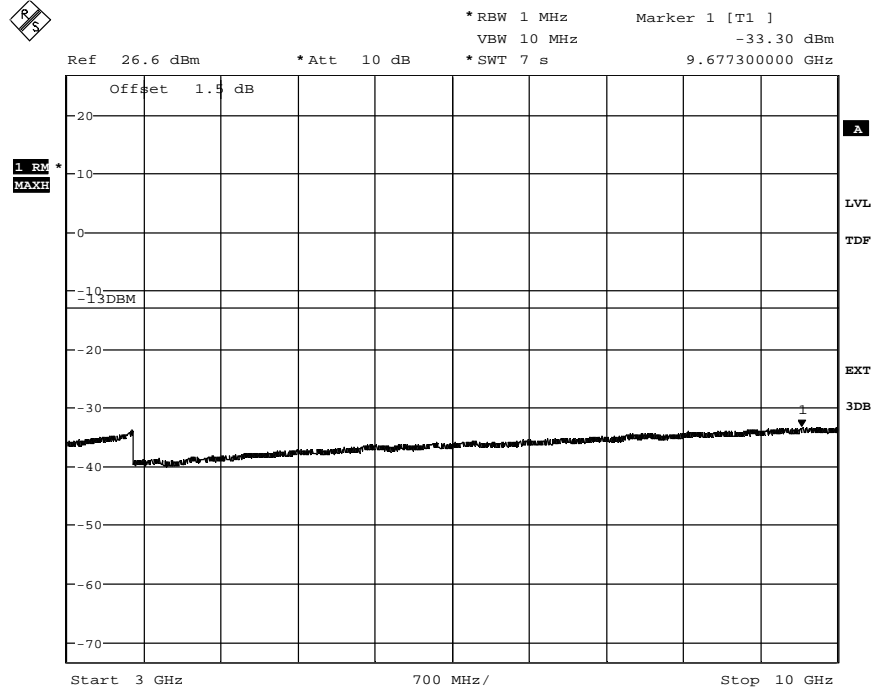

Date: 26.NOV.2013 15:13:15

Diagram 9 d:

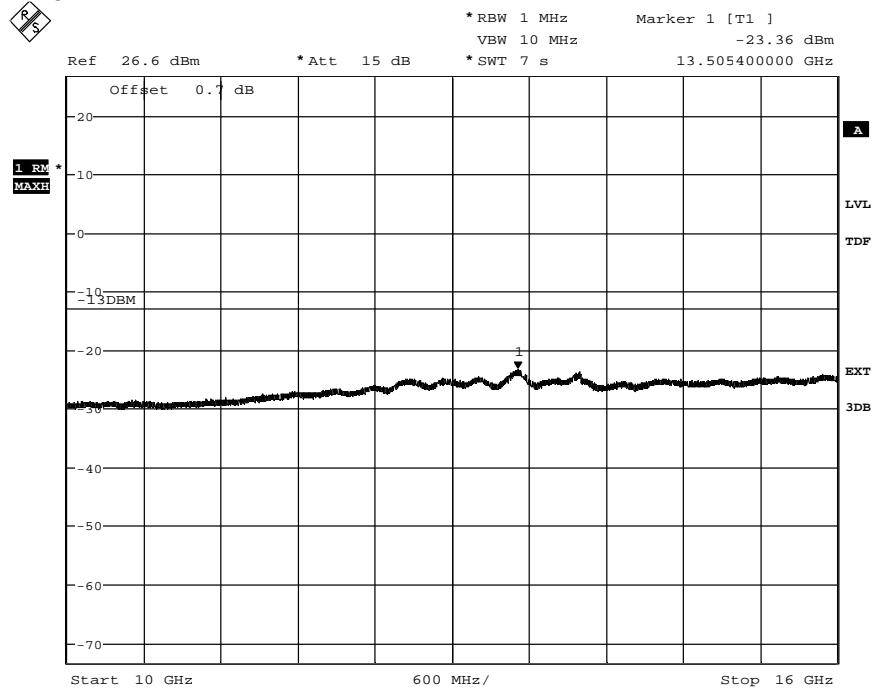

Date: 26.NOV.2013 15:14:02

Appendix 3

Diagram 9 e:

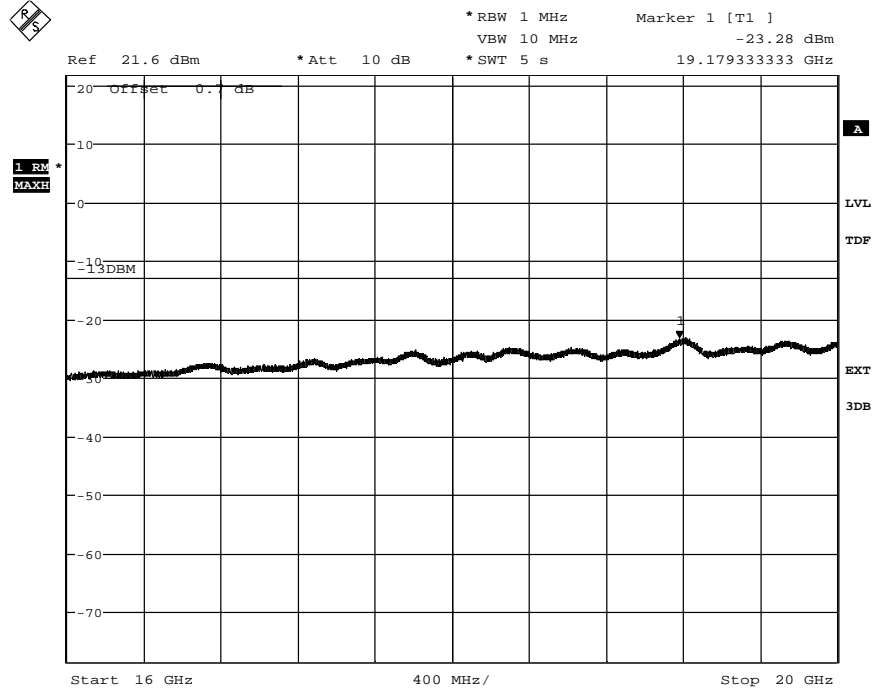

Date: 26.NOV.2013 15:14:39

Appendix 3

Diagram 10 a:

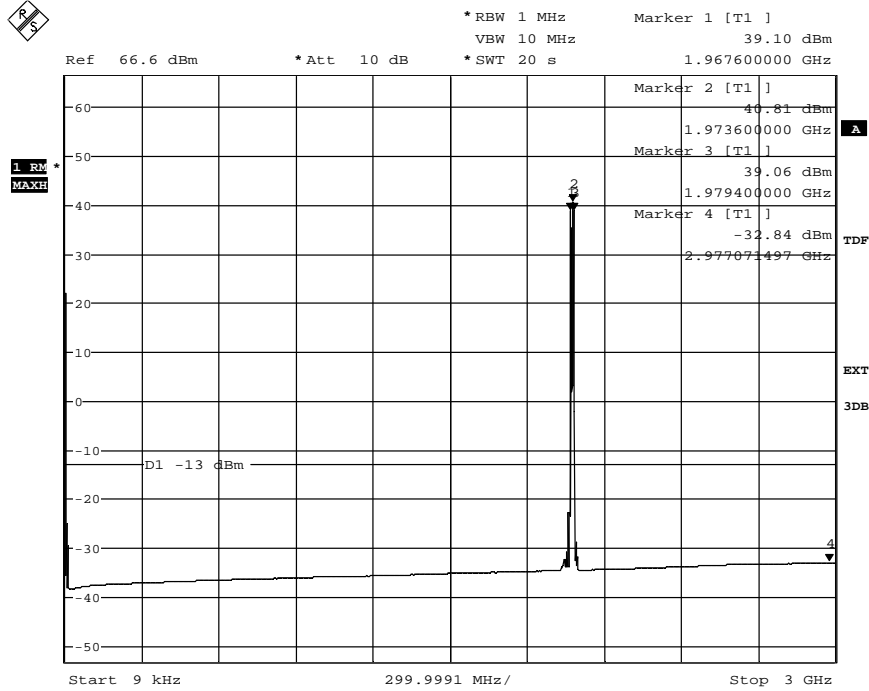

Date: 26.NOV.2013 15:21:56

Diagram 10 b:

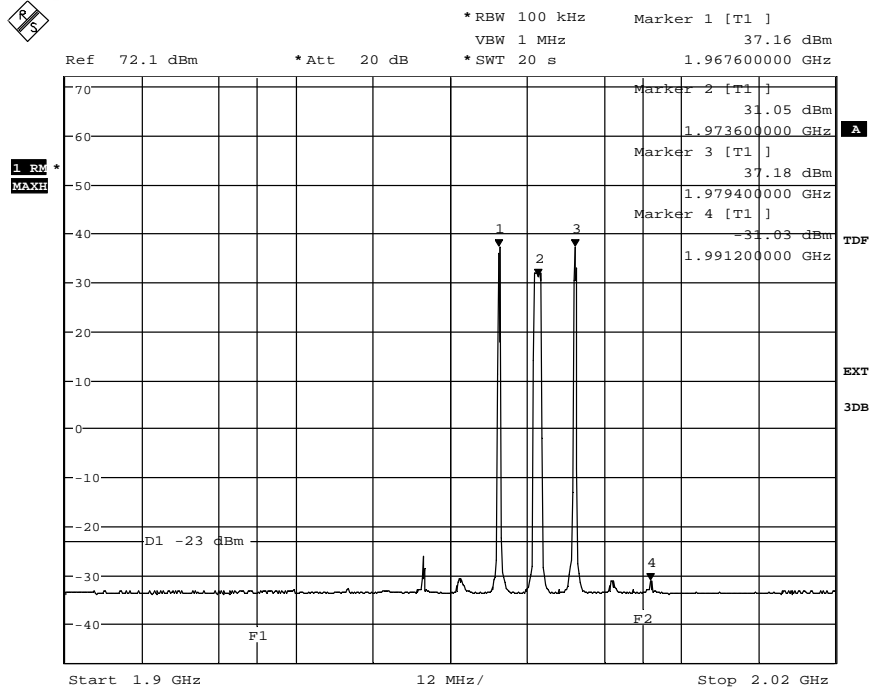

Date: 26.NOV.2013 15:23:05

Appendix 3

Diagram 10 c:

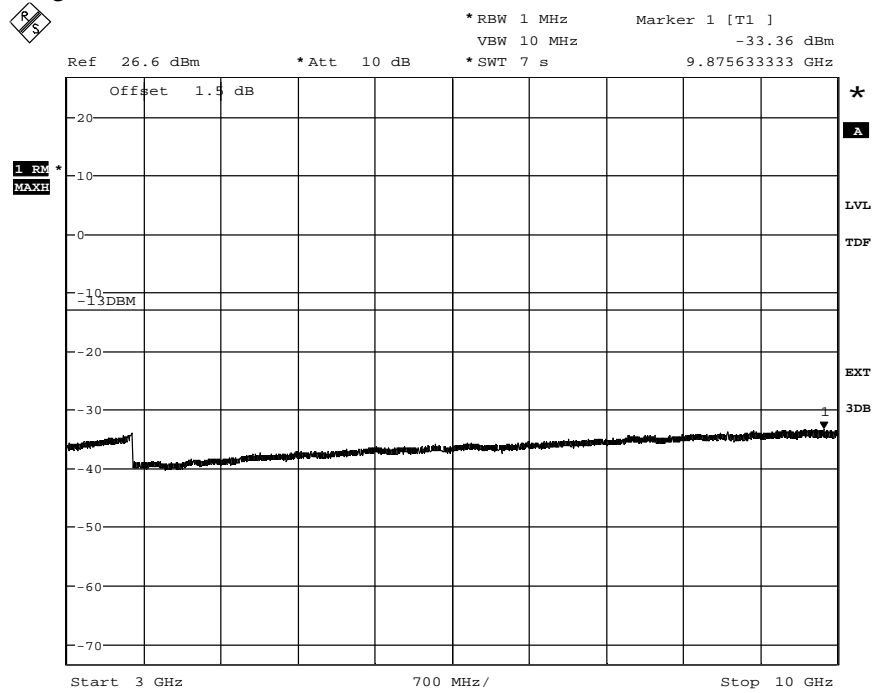

Date: 26.NOV.2013 15:20:09

Diagram 10 d:

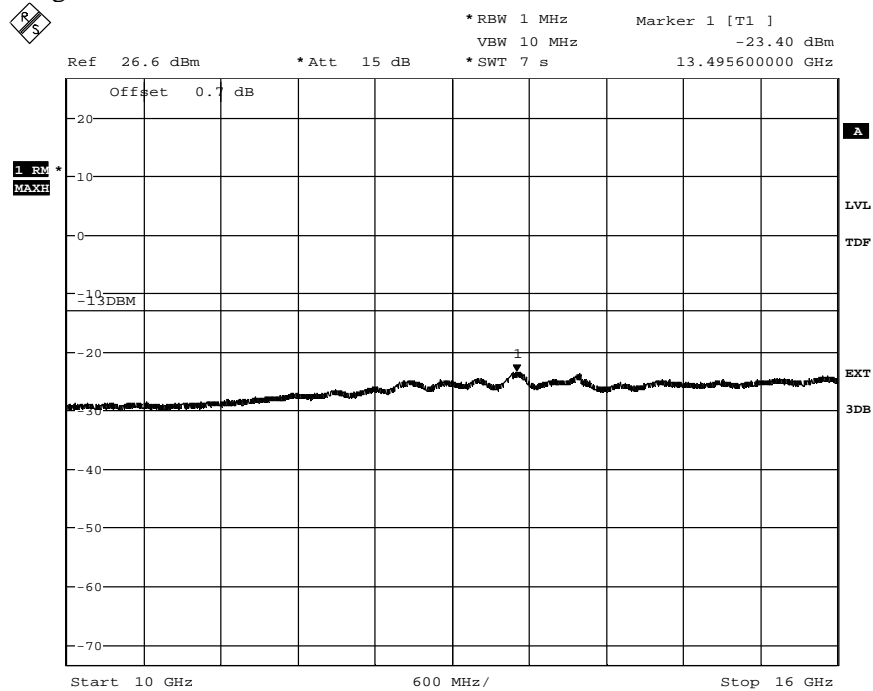

Date: 26.NOV.2013 15:19:34

Appendix 3

Diagram 10 e:

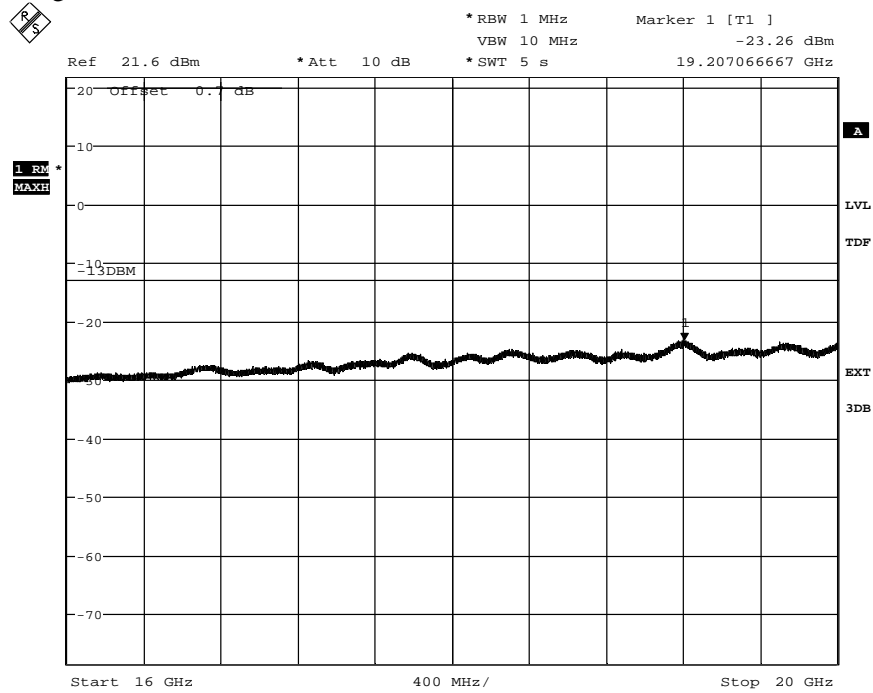

Date: 26.NOV.2013 15:18:53

Appendix 4

Field strength of spurious radiation measurements according to CFR 47 §24.238 / IC RSS-133 6.5

Date	Temperature	Humidity
2013-10-23	24 °C ± 3°C	45 % ± 5 %

Test set-up and procedure

The test sites are listed at FCC, Columbia with registration number: 93866. The test site complies with RSS-Gen, Industry Canada file no. 3482A-1.

The measurements were performed with both horizontal and vertical polarization of the antenna. The antenna distance was 3 m in the frequency range 30 MHz – 18 GHz and 1 m in the frequency range 18 - 20 GHz.

In the frequency range 30 MHz - 20 GHz the measurement was performed in power with a RBW of 1 MHz. A propagation loss in free space was calculated. The used formula was

$$\gamma = 20 \log \left(\frac{4\pi D}{\lambda} \right), \gamma \text{ is the propagation loss and } D \text{ is the antenna distance.}$$

The measurement procedure was as the following:

1. The pre-measurement was first performed with peak detector. The EUT was measured in eight directions and with the antenna at three heights, 1.0 m, 1.5 m and 2.0 m.
2. Spurious radiation on frequencies closer than 20 dB to the limit in the pre-measurement is scanned 0-360 degrees and the antenna is scanned 1- 4 m for maximum response. The emission is then measured with the RMS detector and the RMS value is reported. Frequencies closer than 10 dB to the limit when measured with the RMS detector were measured with the substitution method according to the standard.

Appendix 4

Representative test set-up during the spurious radiation measurements is shown in the picture below:



Measurement equipment

Measurement equipment	SP number
Semi anechoic chamber	503 881
R&S ESU 26	901 553
EMC 32 ver. 8.52.0	503 899
Chase Bilog Antenna CBL 6111A	502 182
EMCO Horn Antenna 3115	502 175
Flann STD Gain Horn Antenna 20240-20	503 674
High pass filter, RLC Electronics, 3-18 GHz	503 739
Miteq, Low Noise Amplifier	503 285
µComp Nordic, Low Noise Amplifier	901 545
Temperature and humidity meter, Testo 625	504 188

Appendix 4

Tested configurations

Configuration
1
2
3
4
5
7

Results, representing worst case

Diagram	BW configuration[MHz]	Symbolic name
1 a-d	5 MHz	Configuration 7

Frequency (MHz)	Spurious emission level (dBm)	
	Vertical	Horizontal
30 – 20 000	All emissions > 20 dB below limit	All emissions > 20 dB below limit

Measurement uncertainty:

3.2 dB up to 18 GHz, 3.6 dB above 18 GHz

Remarks

The upper frequency bound for verification was chosen as 20 GHz in order to cover 10 x the maximum fundamental TX frequency.

Limits

CFR 47 §24.238 and RSS-133 6.5

Outside a licensee's frequency band(s) of operation the power of any emission shall be attenuated below the transmitter power (P) by at least $43 + 10 \log (P)$ dB, resulting in a limit of -13 dBm per 1 MHz RBW.

Complies?	Yes
-----------	-----

Appendix 4

Diagram 1 a:

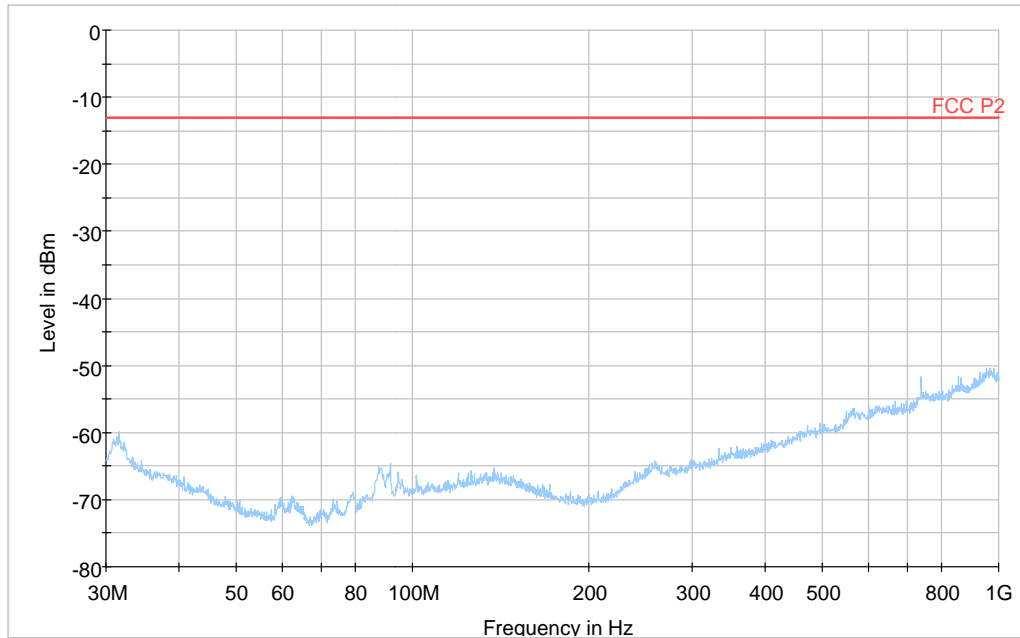
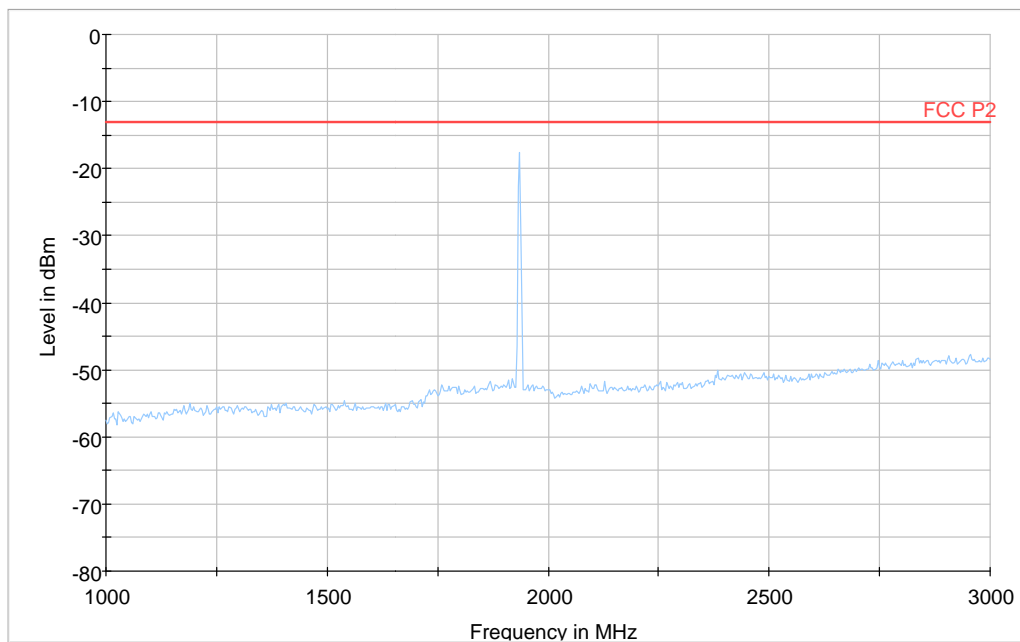

Diagram 1 b:



Note: The emission between 1930 and 1936 MHz are the carrier frequencies and shall be ignored in the context.

Appendix 4

Diagram 1 c:

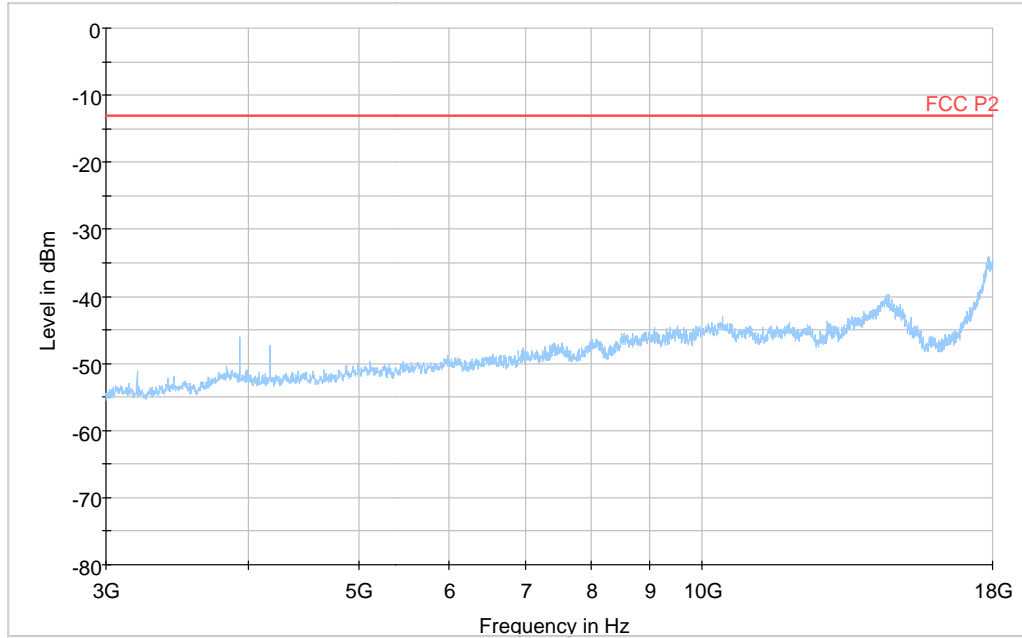
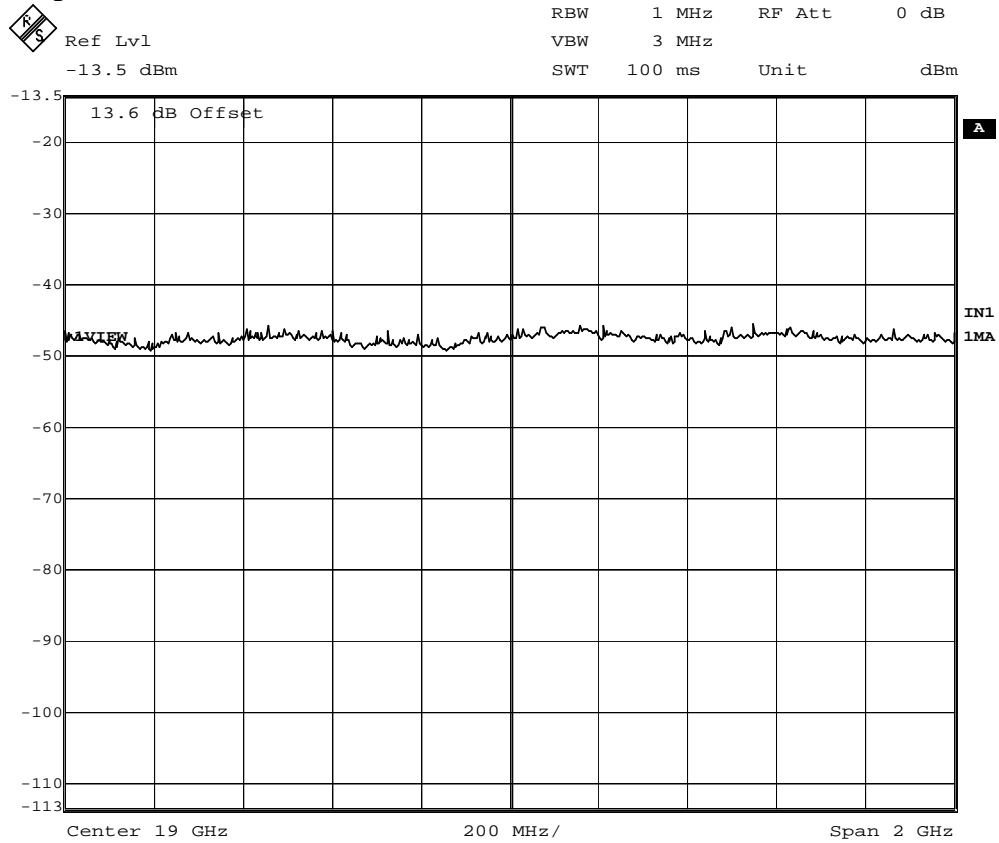

Diagram 1 d:



Date: 23.OCT.2013 13:02:02

Appendix 5

External photos

Front side



Rear side

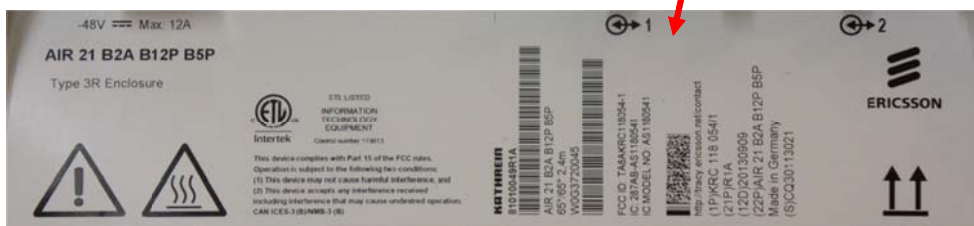

Appendix 5

Left side



Right side



Appendix 5

Top side

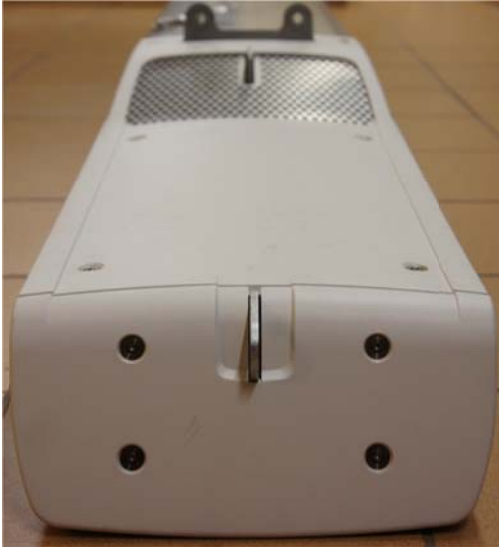

Bottom side

