

Ericsson AB
Klaes Holm
PDU HW
164 80 Stockholm

Radio measurements on AIR 21 B2A B12P B5P 1900 MHz radio equipment with FCC ID: TA8AKRC118054-1 and IC: 287AB-AS1180541 (8 appendices)

Test object

Product name: AIR 21 B2A B12P B5P
Product number: KRC 118 054/1, R1A

Summary

See appendix 1 for general information and appendix 8 for external photos.

Standard	Compliant	Appendix
FCC CFR 47 / IC RSS-133 Issue 6		
2.1046 / RSS-133 6.4 RF power output	Yes	2
2.1049 / RSS-Gen 4.6.1 Occupied bandwidth	Yes	3
2.1051 / RSS-133 6.5 Band edge	Yes	4
2.1051 / RSS-133 6.5 Spurious emission at antenna terminals	Yes	5
2.1053 / RSS-133 6.5 Field strength of spurious radiation	Yes	6
2.1055 / RSS-133 6.3 Frequency stability	Yes	7

Note: Above RSS-133 items are given as cross-reference only. Measurements were performed according to ANSI procedures referenced by FCC and covered by SP's accreditation.

SP Technical Research Institute of Sweden

Electronics – EMC

Performed by



Jörgen Wassholm

Examined by

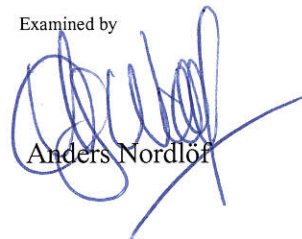

Anders Nordlöf

SP Technical Research Institute of Sweden

Postal address
SP
Box 857
SE-501 15 BORÅS
Sweden

Office location
Västeråsen
Brinellgatan 4
SE-504 62 BORÅS

Phone / Fax / E-mail
+46 10 516 50 00
+46 33 13 55 02
info@sp.se

Laboratories are accredited by the Swedish Board for Accreditation and Conformity Assessment (SWEDAC) under the terms of Swedish legislation. This report may not be reproduced other than in full, except with the prior written approval of the issuing laboratory.

Table of contents

Description of the test object	Appendix 1
Operation modes during measurements	Appendix 1
Test frequencies and setups	Appendix 1
Purpose of test	Appendix 1
RF power output	Appendix 2
Occupied bandwidth	Appendix 3
Band edge	Appendix 4
Spurious emission at antenna terminals	Appendix 5
Field strength of spurious radiation	Appendix 6
Frequency stability	Appendix 7
External photos	Appendix 8

Appendix 1

Description of the test object

Equipment:	Product name: AIR 21 B2A B12P B5P Product number KRC 118 054/1 FCC ID: TA8AKRC118054-1 IC: 287AB-AS1180541 IC MODEL NO: AS1180541
Tested configuration:	LTE single RAT
Frequency range:	TX: 1930 – 1990 MHz RX: 1850 – 1910 MHz
Antenna ports:	2 TX/RX ports, (internally connected to integrated Cross-Polarized antenna elements)
RF configuration:	Single carrier, multi carrier and MIMO 2x2
Nominal RF output power per antenna port:	Single carrier: 1x 44.8 dBm (1x 30W) Multi carrier: 2x 41.8 dBm (2x 15W)
Antenna type:	Cross- polarized antenna
Antenna gain:	17 dBi
Channel bandwidths:	1.4 MHz, 3 MHz, 5 MHz, 10 MHz, 15 MHz and 20 MHz
Modulations:	QPSK, 16QAM and 64QAM
Nominal supply voltage:	-48VDC

Appendix 1

Operation mode during measurements

Measurements were performed with the test object transmitting test models as defined in 3GPP TS 36.141. Test model E-TM1.1 represent QPSK modulation, test model E-TM3.2 represent 16QAM modulation and test model E-TM3.1 represent 64QAM modulation.

The settings below were deemed representative for all traffic scenarios when settings with different modulations, channel bandwidths, number of carriers and RF configurations has been tested to find the worst case setting. All measurements were performed with the test object configured for maximum transmit power. The settings below were used for all measurements if not otherwise noted.

MIMO mode, single carrier, E-TM1.1

MIMO mode, multi carrier, 2 carriers, E-TM1.1

Conducted measurements

The conducted measurements were performed on AIR 21 B2A B12P B8P with product number KRC 118 055/1 including the radio unit ARUS B2, 1/KRC 118 054 which is identical for AIR 21 B2A B12P B5P and is representative for conducted TX performance measurements.

The test object was pole mounted and powered with -48 VDC by an external power supply, unless noted otherwise. All TX parameters were measured at port RF A with port RF B terminated into 50 ohm. Complete measurements were made on RF A with additional measurements on RF B to verify that the ports are identical.

Radiated measurements

The test object was pole mounted and powered with -48 VDC by an external power supply. Both RF ports were terminated into 50 ohm.

Purpose of test

The purpose of the tests is to verify compliance to the performance characteristics specified in applicable parts of FCC CFR 47, IC RSS-133 and IC RSS-Gen.

References

Measurements were done according to relevant parts of the following standards:

ANSI C63.4-2009

ANSI/TIA/EIA-603-C-2004

3GPP TS 36.141, version 11.4.0

CFR 47 part 2, October 1st, 2012

CFR 47 part 24 Subpart E, October 1st, 2012

RSS-Gen Issue 3

RSS-133 Issue 6

Appendix 1

Uncertainties

Measurement and test instrument uncertainties are described in the quality assurance documentation "SP-QD 10885". The uncertainties are calculated with a coverage factor $k=2$ (95% level of confidence).

Compliance evaluation is based on a shared risk principle with respect to the measurement uncertainty.

Reservation

The test results in this report apply only to the particular test object as declared in the report.

Delivery of test object

The test object was delivered 2013-10-18.

Manufacturer's representative

Christer Gustavsson, Ericsson AB.

Test engineers

Andreas Johnson, Kexin Chen, Hyder Khalaf, Tomas Lennhager, Tomas Isbring and Jörgen Wassholm, SP.

Test participant

None.

Appendix 1

Measurement equipment

	Calibration Due	SP number
Test site Tesla	2014-01	503 881
R&S FSIQ 40	2014-07	503 738
R&S ESU 26	2014-05	901 553
R&S FSQ 40	2014-03	504 143
Control computer with R&S software EMC32 version 8.52.0	-	503 899
High pass filter	2014-07	901 501
High pass filter	2014-07	901 502
High pass filter	2014-07	504 199
High pass filter	2014-09	901 373
High pass filter	2014-09	503 739
High pass filter	2014-07	503 740
RF attenuator	2014-07	504 159
RF attenuator	2014-07	900 233
RF attenuator	2014-07	900 691
RF attenuator	2014-07	901 384
RF attenuator	2013-12	901 508
Chase Bilog Antenna CBL 6111A	2014-10	503 182
EMCO Horn Antenna 3115	2015-09	502 175
Std.gain horn FLANN model 20240-20	-	503 674
µComp Nordic, Low Noise Amplifier	2014-04	901 545
Miteq Low Noise Amplifier	2014-09	503 285
Schwartzbeck preamplifier BBV 9742	2014-14	504 085
Temperature and humidity meter, Testo 635	2014-06	504 203
Temperature and humidity meter, Testo 625	2014-06	504 188
Temperature Chamber	2013-11	501 031
Multimeter Fluke 87	2014-08	502 190

Appendix 1

Test frequencies used for conducted and radiated measurements

EARFCN Downlink	Frequency [MHz]	Symbolic name	Comment
607	1930.7	B	TX bottom frequency in 1.4 MHz BW configuration.
607 657	1930.7 1935.7	B2	TX bottom frequency in 1.4 MHz BW configuration 2 carriers.
615 665	1931.5 1936.5	B3	TX bottom frequency in 3 MHz BW configuration 2 carriers.
607 621	1930.7 1932.1	B2im1	TX bottom frequency in 1.4 MHz BW configuration 2 carriers.
700 812	1940.0 1951.2	B2im2	TX bottom frequency in 1.4 MHz BW configuration 2 carriers.
615	1931.5	B	TX bottom frequency in 3 MHz BW configuration.
625	1932.5	B	TX bottom frequency in 5 MHz BW configuration.
650	1935.0	B	TX bottom frequency in 10 MHz BW configuration.
675	1937.5	B	TX bottom frequency in 15 MHz BW configuration.
700	1940.0	B	TX bottom frequency in 20 MHz BW configuration.
900	1960.0	M	TX band mid frequency in all BW configurations.
850 950	1955.0 1965.0	M2	TX band mid frequency in 5 MHz BW configuration 2 carriers.
875 925	1957.5 1962.5	M3	TX band mid frequency in 1.4 MHz BW configuration 2 carriers.
1100	1980.0	T	TX top frequency in 20 MHz BW configuration.
1125	1982.5	T	TX top frequency in 15 MHz BW configuration.
1150	1985.0	T	TX top frequency in 10 MHz BW configuration.
1175	1987.5	T	TX top frequency in 5 MHz BW configuration.
1185	1988.5	T	TX top frequency in 3 MHz BW configuration.
1193	1989.3	T	TX top frequency in 1.4 MHz BW configuration.
1193 1143	1989.3 1984.3	T2	TX top frequency in 1.4 MHz BW configuration 2 carriers.
1185 1135	1988.5 1983.5	T3	TX top frequency in 3 MHz BW configuration 2 carriers.
1193 1179	1989.3 1987.9	T2im1	TX top frequency in 1.4 MHz BW configuration 2 carriers.
1100 988	1980.0 1968.8	T2im2	TX top frequency in 1.4 MHz BW configuration 2 carriers.

All RX frequencies were configured 80 MHz below the corresponding TX frequency according to the applicable duplex offset for the operating band.

Appendix 1

Test set-up conducted measurements LTE

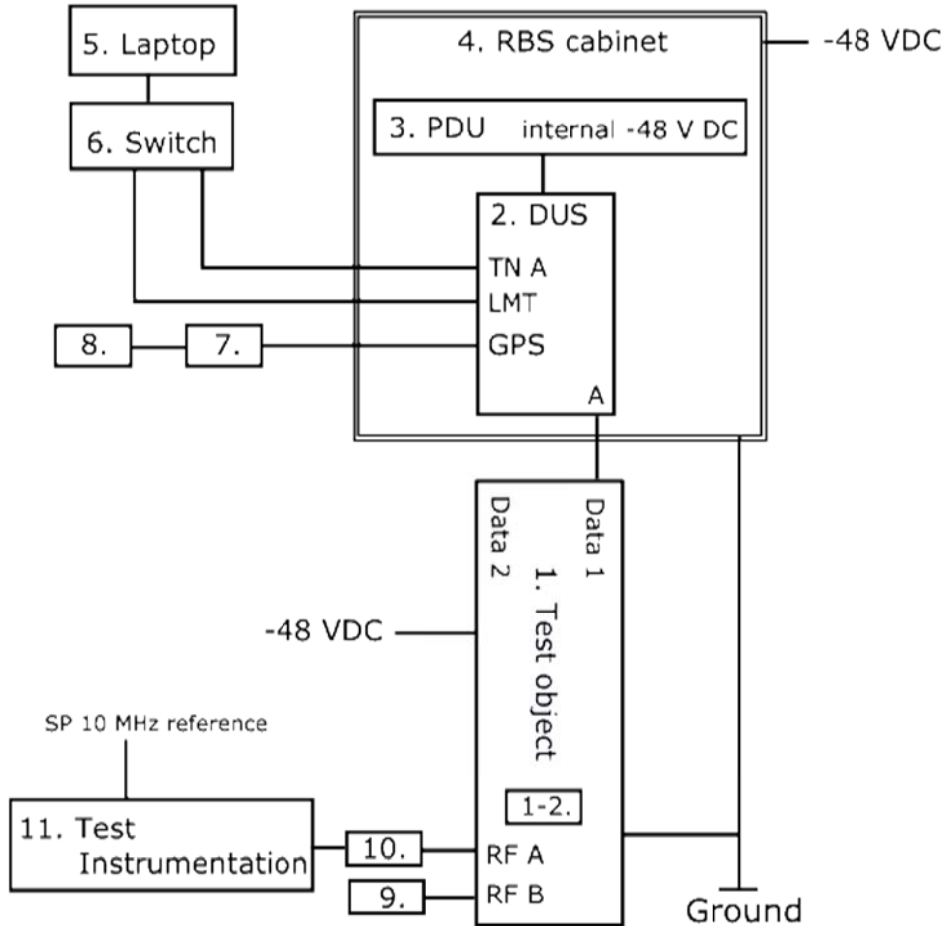

Test object:

1.	AIR 21 B2A B12P B8P, KRC 118 055/1, revision R1A, s/n: TM30003022 with software (PIS): CXP 901 7316/1 rev. R49FF 1-2. Transceiver, ARUS B2, 1/KRC 118 054, revision R1A
----	--

Functional test equipment

2.	DUS 41 01, KDU 137 624/1, rev:R6A, s/n: A401981869
3.	PDU 02 01, BMG 980 336/4, rev: R2A, s/n: BJ31528316
4.	RBS 6201 cabinet, BAMS – 1000778792
5.	Controlling laptop HP EliteBook 8560w, BAMS – 1001236856
6.	Fast Ethernet switch, Netgear FS726T
7.	GPS 02 01, NCD 901 41/1, rev. R1D, s/n: TU8K475230
8.	GPS Active Antenna, KRE 101 2082/1
9.	Terminator, 50 ohm
10.	Attenuator, according respective appendix
11.	SP Test Instrumentation according to measurement equipment list

Appendix 1

Test setup radiated measurements LTE

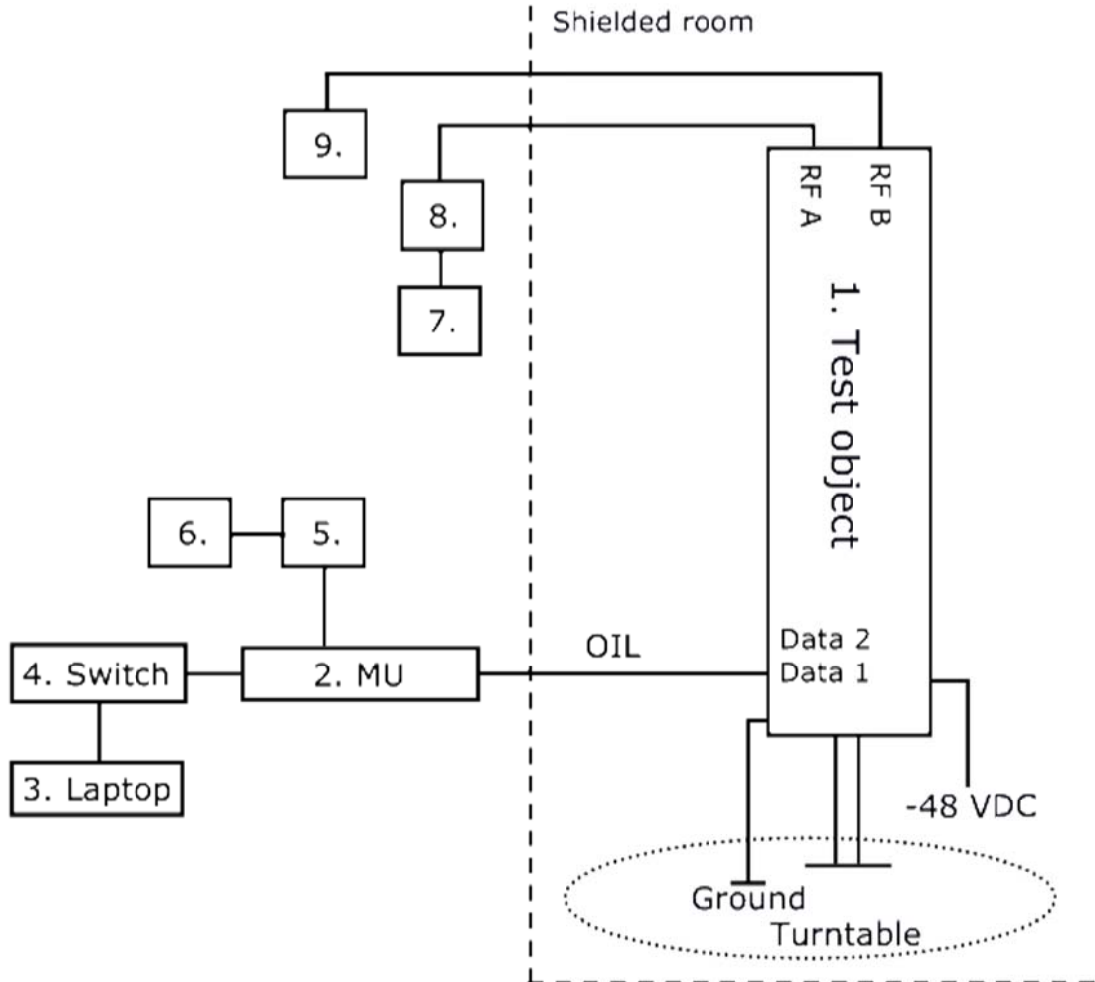

Test object:

1.	AIR 21 B2A B12P B5P, KRC 118 054/1, revision R1A, s/n: CQ30113021 (FCC ID: TA8AKRC118054-1 / IC: 287AB-AS1180541) with software (PIS): CXP 901 7316/1 rev. R49FF Transceiver, ARUS B2, 1/KRC 118 054, revision R1A
----	---

Functional test equipment:

2.	Main Unit SUP 6601, 1/BFL 901 009/4, rev. R1E, s/n: BR88236818 DUS 41 01, KDU 137 624/1, rev. R6A, s/n: A401981869
3.	Laptop, EliteBook 8560w, BAMS – 1001236854
4.	Netgear switch GS108E
5.	GPS 02 01, NCD 901 41/1, rev. R1D, s/n: TU8K357393
6.	GPS Active Antenna, KRE 101 2082/1
7.	FSIQ 40, SP number: 503 738, for supervision purpose only
8.	Attenuator
9.	Terminator 50 ohm

Appendix 1

Interfaces:	Type of port:
Power: -48 VDC	DC Power
Antenna port (A), (passive antenna), 7/16-connector	Antenna
Antenna port (B), (passive antenna), 7/16-connector	Antenna
Data 1, Optical Interface Link, single mode opto fibre	Signal
Data 2, Optical Interface Link, single mode opto fibre, not in use	Signal
Ground wire	Ground

RBS software:

Software	Revision
CXP 102 051/19	R22EU

Appendix 2

RF power output measurements according to CFR 47 §24.232 / IC RSS-133 6.4

Date	Temperature	Humidity
2013-10-15	23 °C ± 3 °C	28 % ± 5 %
2013-10-18	23 °C ± 3 °C	19 % ± 5 %
2013-11-03	27 °C ± 3 °C	33 % ± 5 %

Test set-up and procedure

The test object was connected to a signal analyzer measuring peak and RMS output power in CDF mode. A resolution bandwidth of 50 MHz was used.

Measurement equipment	SP number
R&S FSQ	504 143
RF attenuator	901 508
Testo 635, temperature and humidity meter	504 203

Measurement uncertainty: 1.1 dB

Results

MIMO mode, single carrier

Rated output power level at RF connector 1x 44.8 dBm.

Carrier BW [MHz]	Symbolic name	[RMS dBm/ PAR dB]		
		Port RF A	Port RF B	Total power ¹⁾
1.4	B	44.84/ 7.19	44.79/ 7.19	47.83
20	B	44.94/ 7.43	44.91/ 7.48	47.94
1.4	M	44.90/ 7.19	44.86/ 7.19	47.89
3.0	M	44.97/ 7.26	44.95/ 7.26	47.97
5.0	M	44.97/ 7.33	44.97/ 7.33	47.98
10.0	M	44.94/ 7.28	44.93/ 7.28	47.95
15.0	M	44.93/ 7.28	44.92/ 7.28	47.94
20.0	M	44.96/ 7.28	44.97/ 7.31	47.98
1.4	T	44.86/ 7.19	44.79/ 7.19	47.84
20	T	44.96/ 7.36	44.87/ 7.36	47.93

¹⁾: Summed output power according to FCC KDB662911 Multiple transmitter output v02r01.

Note: The PAR value is the 0.1 % Peak to Average Ratio.

MIMO mode, multicarrier

Appendix 2

Rated output power level at RF connector 2x 41.8 dBm.

Carrier BW [MHz]	Symbolic name	[RMS dBm/ PAR dB]		
		Port RF A	Port RF B	Total power ¹⁾
1.4	B2	44.90/ 7.09	44.69/ 7.12	47.81
1.4	M3	44.89/ 7.09	44.71/ 7.12	47.81
1.4	T2	44.77/ 7.09	44.59/ 7.12	47.69

¹⁾: Summed output power according to FCC KDB662911 Multiple transmitter output v02r01.

Note: The PAR value is the 0.1 % Peak to Average Ratio.

MIMO mode, single carrier

Measured output power per 1 MHz.

Carrier BW [MHz]	Symbolic name	[RMS dBm]		Total power ¹⁾ [RMS dBm]
		Port RF A	Port RF B	
1.4	B	43.88	43.74	46.88
20	B	33.29	33.20	36.29
1.4	M	43.84	43.85	46.85
3.0	M	41.13	41.05	44.13
5.0	M	38.98	39.06	42.06
10.0	M	36.03	36.05	39.05
15.0	M	34.38	34.33	37.38
20.0	M	33.29	33.17	36.29
1.4	T	43.95	43.67	46.95
20	T	33.23	33.10	36.23

¹⁾: Measured according to FCC KDB662911 D01 Multiple Transmitter Output v02r01. Method E), 2), c). "Measure and add $10 \log(N_{Ant})$ ".



Appendix 2

Limits

§24.232 The maximum output power may not exceed 3280 W/MHz (EIRP).
The Peak to Average Ratio (PAR) may not exceed 13 dB.

RSS-133 Base station transmitters operating in the band 1930-1995 MHz shall not have output power exceeding 100 watts. When the transmitter power is measured in terms of average value, the peak-to-average ratio(PAR) of the power shall not exceed 13 dB

There is no EIRP limit specified for base station equipment in the RSS-133.

EIRP compliance is addressed at the time of licensing, as required by the responsible IC Bureau. Licensee's are required to take into account the antenna gain to get the maximum usable power settings to prevent the radiated output power to exceed the EIRP limits specified in SRSP-510

Complies?	Yes
-----------	-----

Appendix 3

Occupied bandwidth measurements according to CFR 472.1049 / IC RSS-Gen 4.6.1

Date	Temperature	Humidity
2013-10-15	23 °C ± 3 °C	28 % ± 5 %
2013-10-18	23 °C ± 3 °C	19 % ± 5 %

Test set-up and procedure

The measurements were made per definition in §2.1049. The output was connected to a signal analyzer with the RMS detector activated. The signal analyzer was connected to an external 10 MHz reference standard during the measurements.

Measurement equipment	SP number
R&S FSQ	504 143
RF attenuator	901 508
Testo 635, temperature and humidity meter	504 203

Measurement uncertainty: 3.7 dB

Results

MIMO mode, single carrier

Diagram	BW configuration	Symbolic name	Tested Port	Occupied BW (99%) [MHz]
1	1.4 MHz	B	RF A	1.09
2	20 MHz	B	RF A	17.86
3	1.4 MHz	M	RF A	1.09
4	1.4 MHz	M	RF B	1.09
5	3 MHz	M	RF A	2.69
6	5 MHz	M	RF A	4.48
7	10 MHz	M	RF A	8.94
8	15 MHz	M	RF A	13.42
9	20 MHz	M	RF A	17.87
10	20 MHz	M	RF B	17.86
11	1.4 MHz	T	RF A	1.09
12	20 MHz	T	RF A	17.86

Appendix 3

Diagram 1:

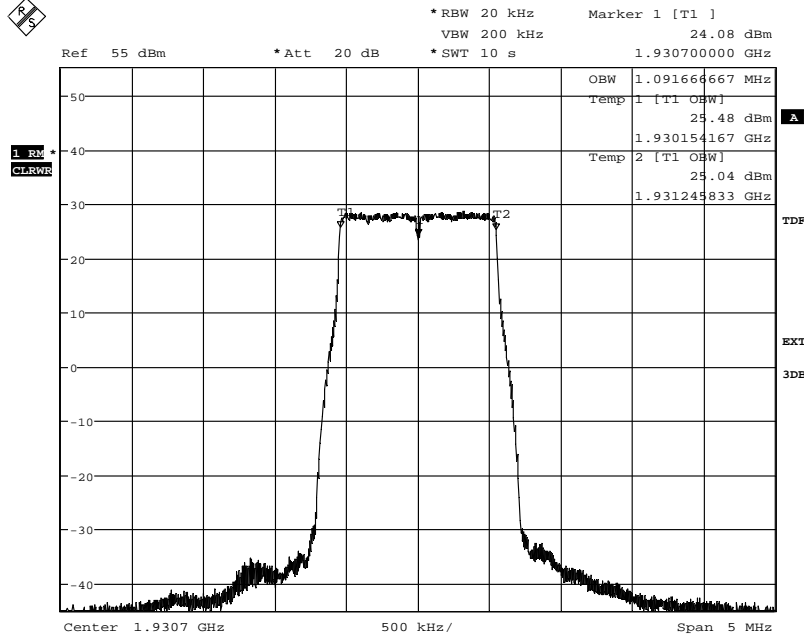

Date: 15.OCT.2013 14:27:44

Diagram 2:

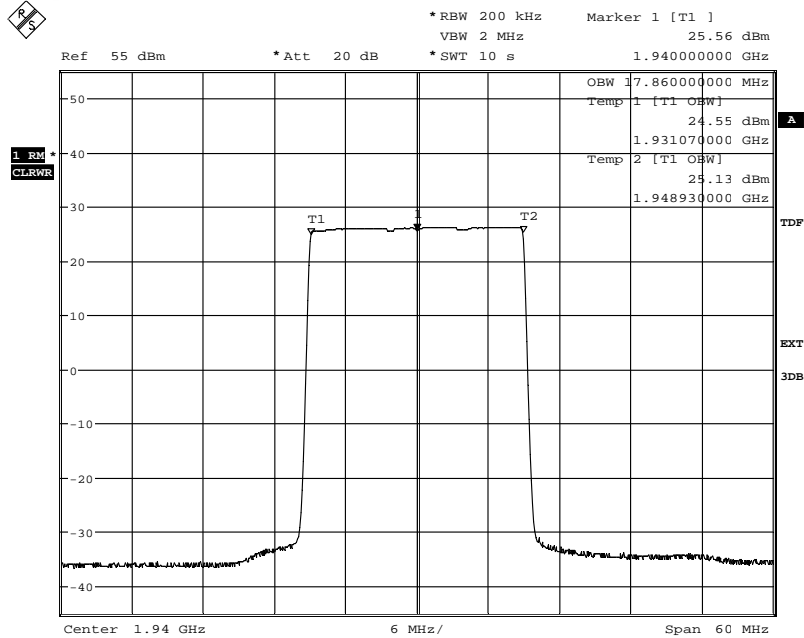

Date: 15.OCT.2013 14:45:43

Appendix 3

Diagram 3:

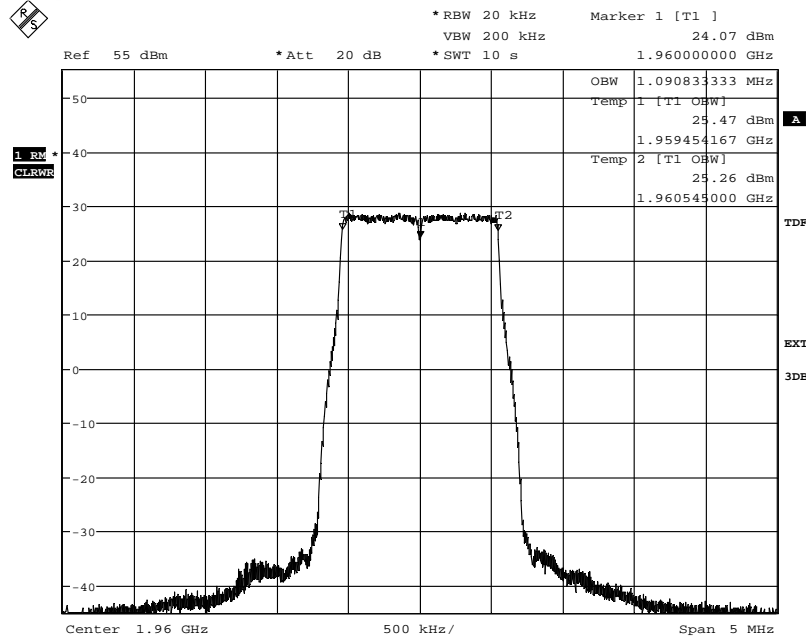

Date: 15.OCT.2013 14:29:25

Diagram 4:

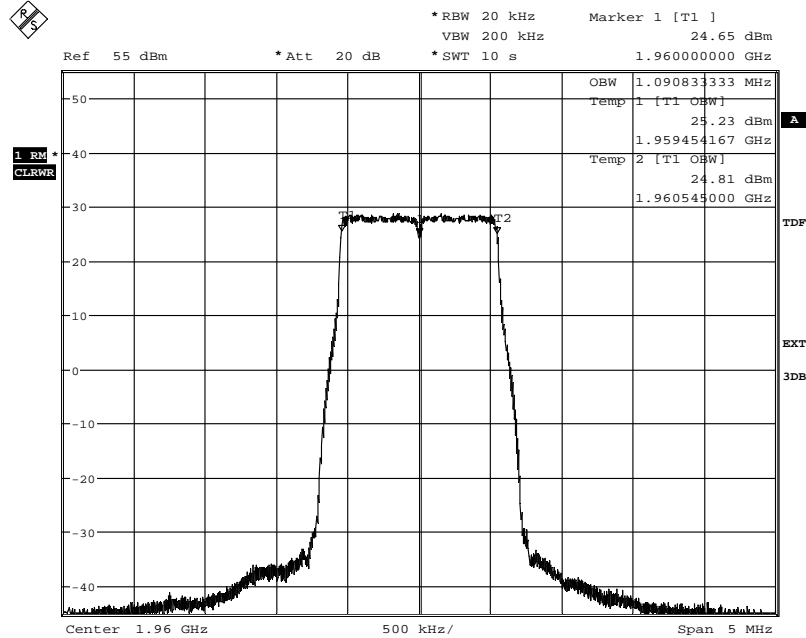

Date: 15.OCT.2013 15:01:03

Appendix 3

Diagram 5:

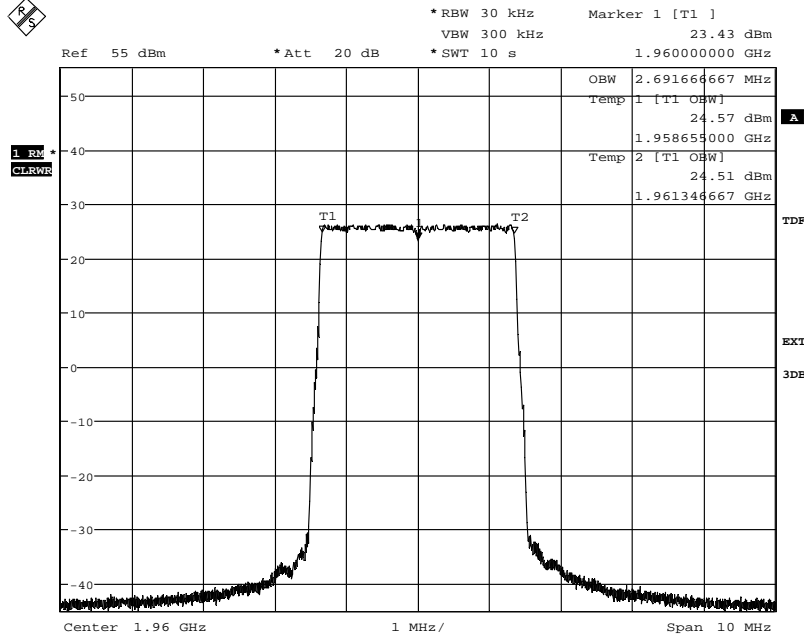

Date: 15.OCT.2013 14:34:43

Diagram 6:

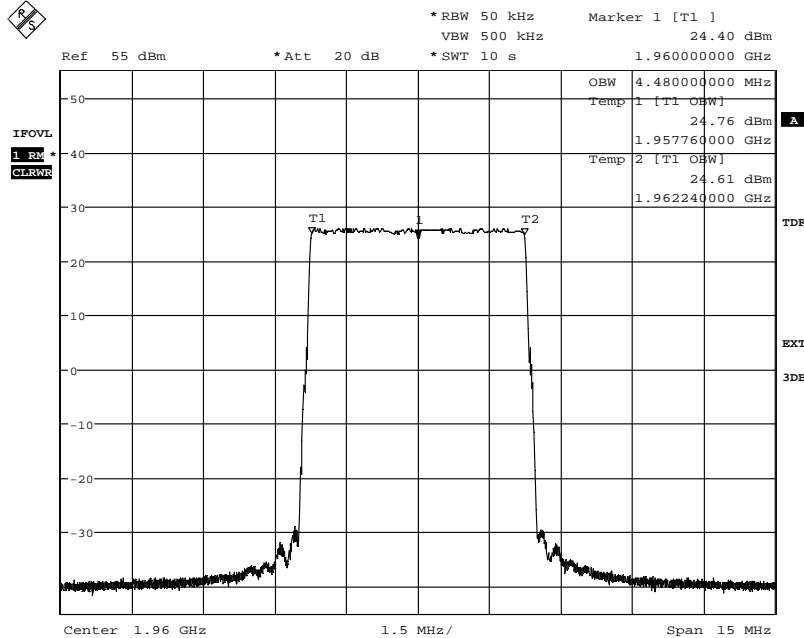

Date: 15.OCT.2013 14:36:56

Appendix 3

Diagram 7:

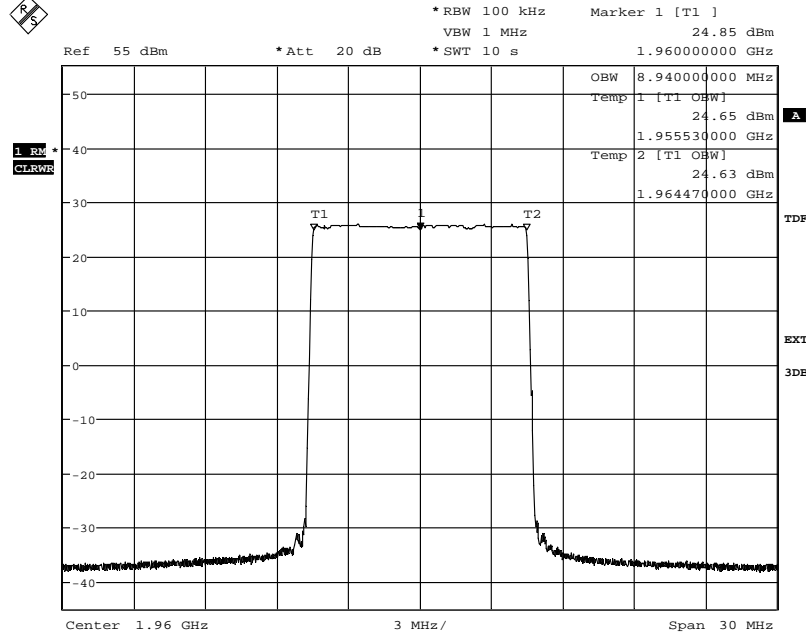

Date: 15.OCT.2013 14:40:55

Diagram 8:

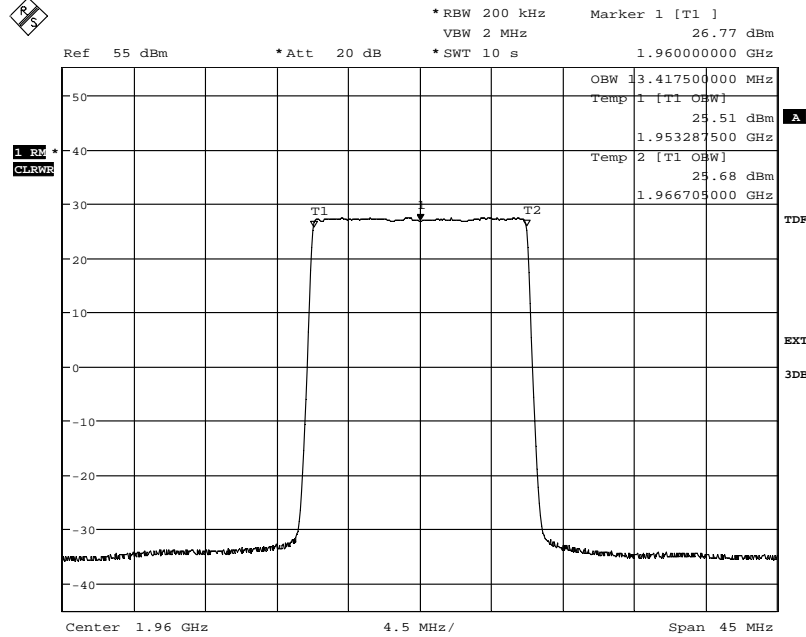

Date: 15.OCT.2013 14:42:20

Appendix 3

Diagram 9:

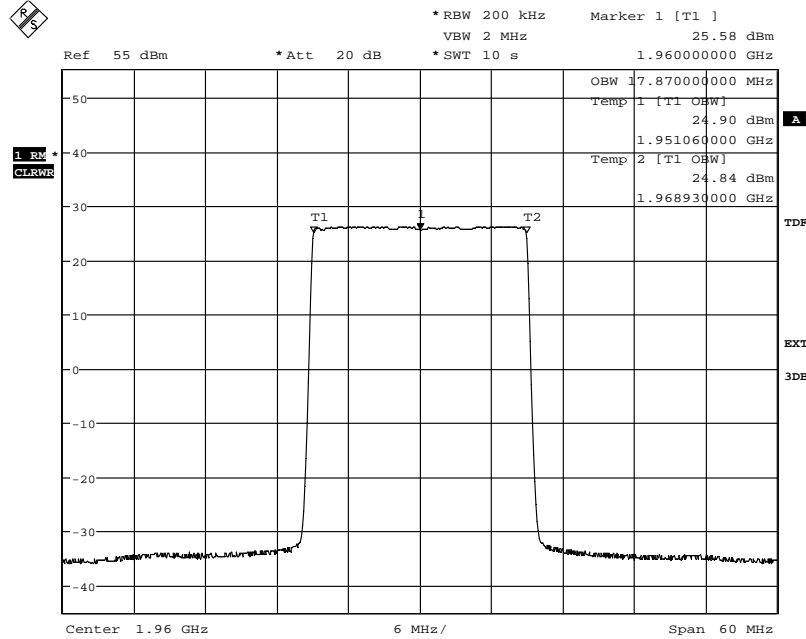

Date: 15.OCT.2013 14:44:20

Diagram 10:

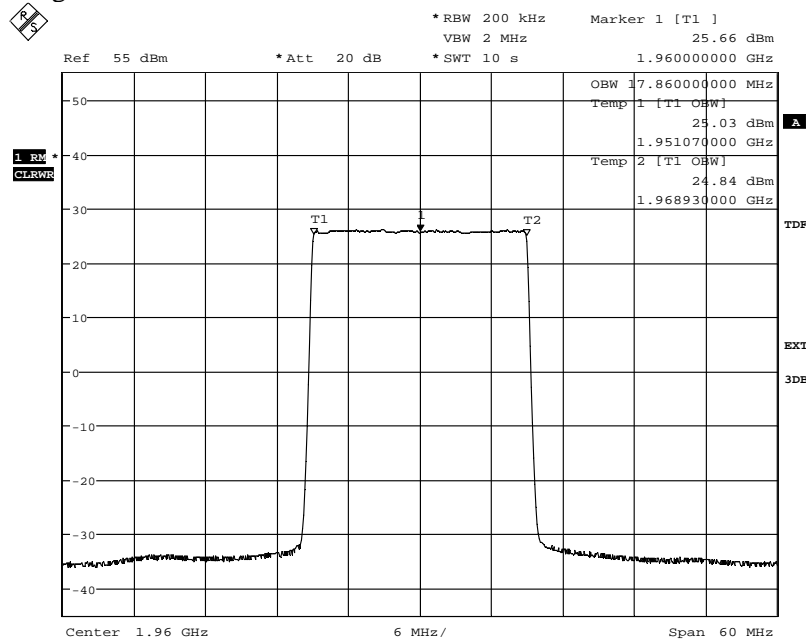

Date: 15.OCT.2013 14:59:14

Appendix 3

Diagram 11:

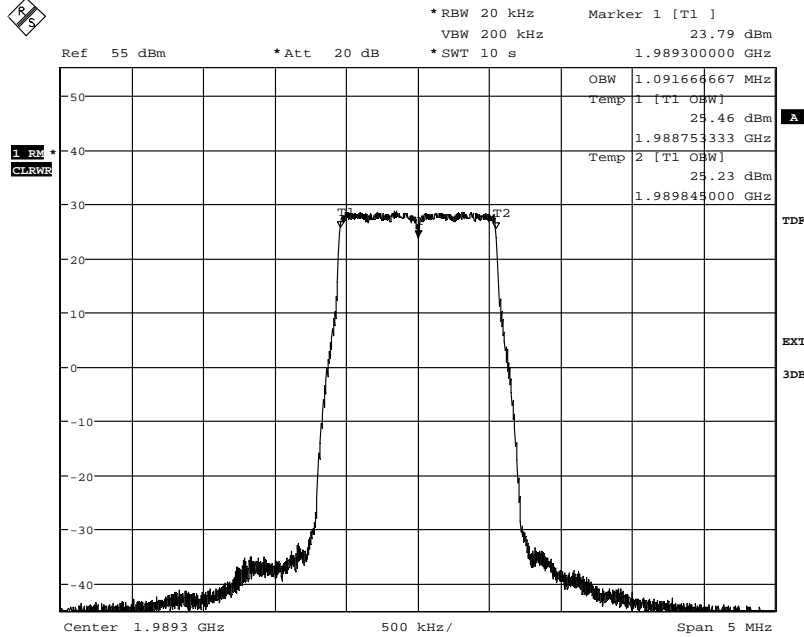

Date: 15.OCT.2013 14:31:21

Diagram 12:

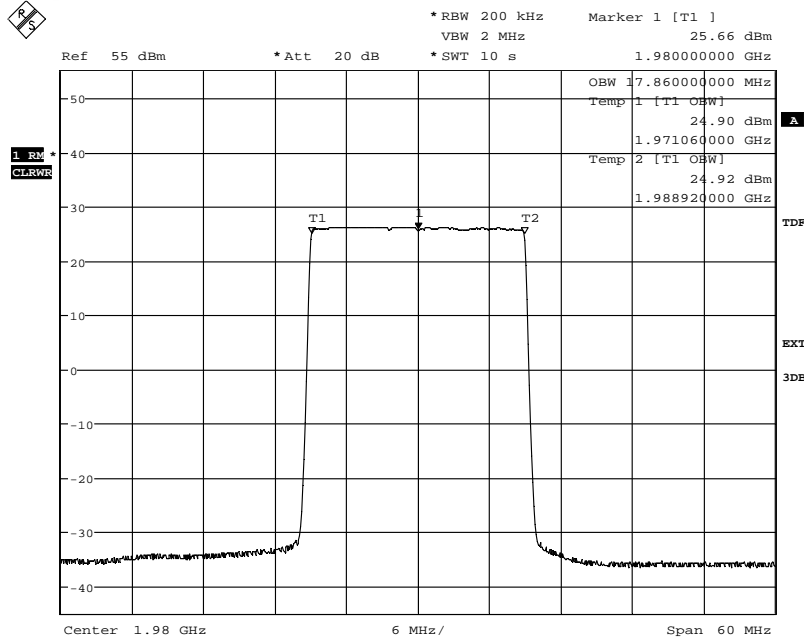

Date: 15.OCT.2013 14:55:34

Appendix 4

Band edge measurements according to CFR 47 §24.238 / IC RSS-133 6.5

Date	Temperature	Humidity
2013-10-17	22 °C ± 3 °C	37 % ± 5 %
2013-10-18	23 °C ± 3 °C	19 % ± 5 %

Test set-up and procedure

The measurements were made per definition in §24.238 The test object was connected to a spectrum analyzer with the RMS detector activated. The spectrum analyzer was connected to an external 10 MHz reference standard during the measurements.

Beyond the 1st MHz off the band edges the limit was adjusted to compensate for reduced measurement bandwidths pursuant to the FCC rules, specifying a RBW of at least 1% of the fundamental emission bandwidth up to 1 MHz away from the band edges and a RBW of 1 MHz for measurements of emissions more than 1 MHz away from the band edges.

Where a smaller RBW was used as compared to the rules, the limit in the plot is adjusted by $10 \log (RBW_{used}/RBW_{specified})$ [dB].

BW configuration [MHz]	Emission BW [MHz]	RBW _{used} [kHz]	Adjusted limit to [dBm]
1.4	1.12	10	-13.5
3	2.73	10	-17.4

A resolution bandwidth of 200 kHz was used 1 MHz to 6 MHz away from the band edges, to compensate for the reduced resolution bandwidth the limit was adjusted by 7 dB to -20 dBm.

Before comparing the results to the limit, 3 dB [10 log (2)] should be added according to method E), 3), a), (iii) Measure and add 10 log(N_{ANT})” of FCC KDB662911 D01 Multiple Transmitter Output v02r01.

Measurement equipment	SP number
R&S FSQ	504 143
RF attenuator	901 508
Testo 635, temperature and humidity meter	504 203

Measurement uncertainty: 3.7 dB

Appendix 4

MIMO mode, single carrier

Diagram	BW configuration	Symbolic name	Tested Port
1 a-c	1.4 MHz	B	RF A
2 a-c	3 MHz	B	RF A
3 a-c	3 MHz	B	RF B
4 a-c	5 MHz	B	RF A
5 a-c	10 MHz	B	RF A
6 a-c	15 MHz	B	RF A
7 a-c	20 MHz	B	RF A
8 a-c	1.4 MHz	T	RF A
9 a-c	3 MHz	T	RF A
10 a-c	3 MHz	T	RF B
11 a-c	5 MHz	T	RF A
12 a-c	10 MHz	T	RF A
13 a-c	15 MHz	T	RF A
14 a-c	20 MHz	T	RF A

MIMO mode, multi carrier

Diagram	BW configuration	Symbolic name	Tested Port
15 a-c	1.4 MHz	B2	RF A
16 a-c	3 MHz	B2	RF A
17 a-c	1.4 MHz	T2	RF A
18 a-c	3 MHz	T2	RF A

Limits

CFR 47 §24.238 and RSS-133 6.5

Outside a licensee's frequency band(s) of operation the power of any emission shall be attenuated below the transmitter power (P) by at least $43 + 10 \log (P)$ dB, resulting in a limit of -13 dBm.

Complies?	Yes
-----------	-----

Appendix 4

Diagram 1 a:

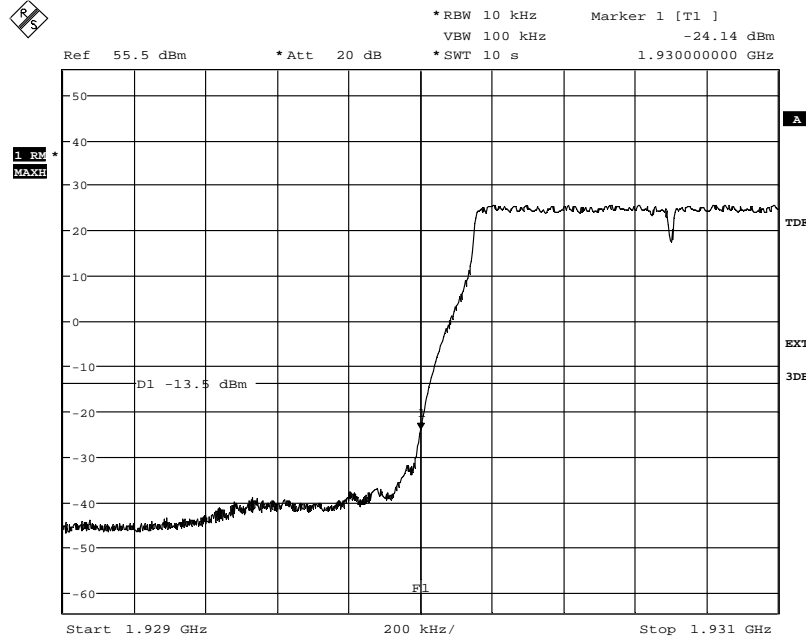

Date: 17.OCT.2013 14:55:50

Diagram 1 b:

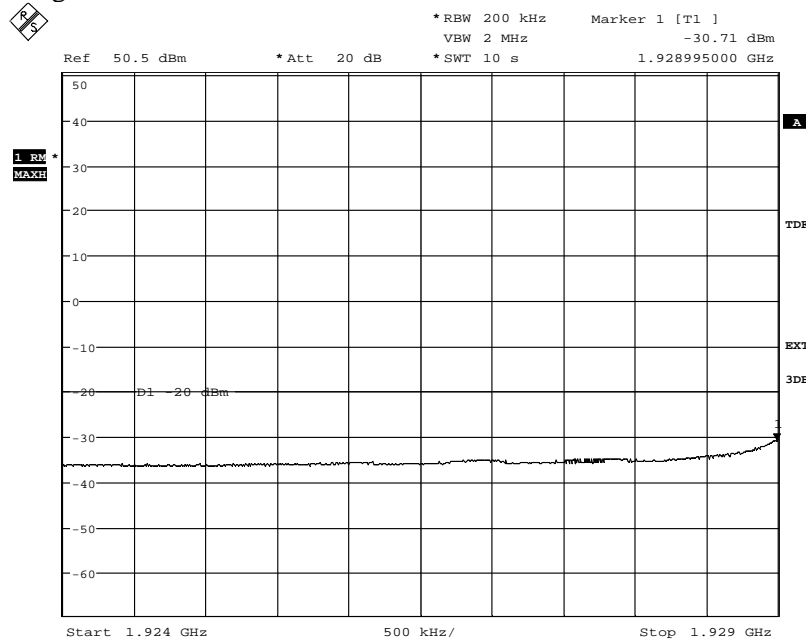

Date: 17.OCT.2013 14:57:44

Appendix 4

Diagram 1 c:

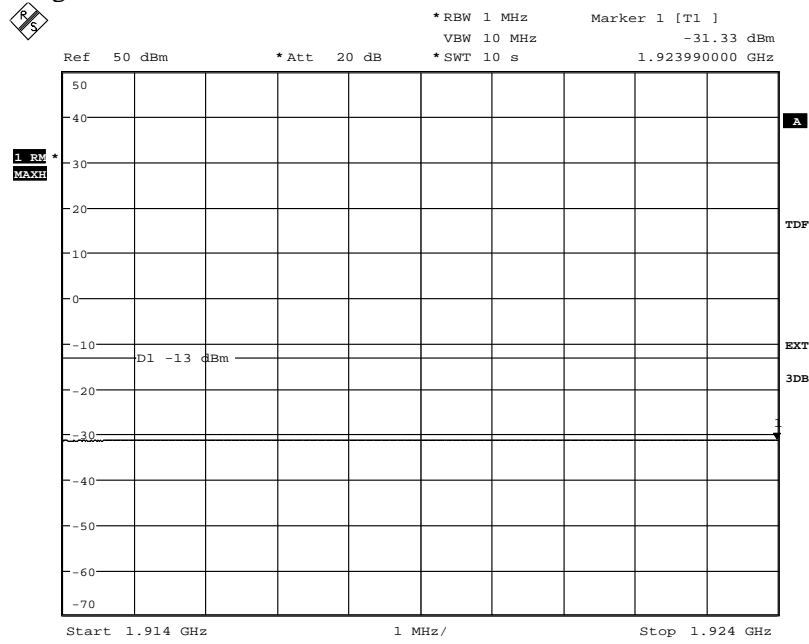

Date: 17.OCT.2013 15:05:25

Appendix 4

Diagram 2 a:

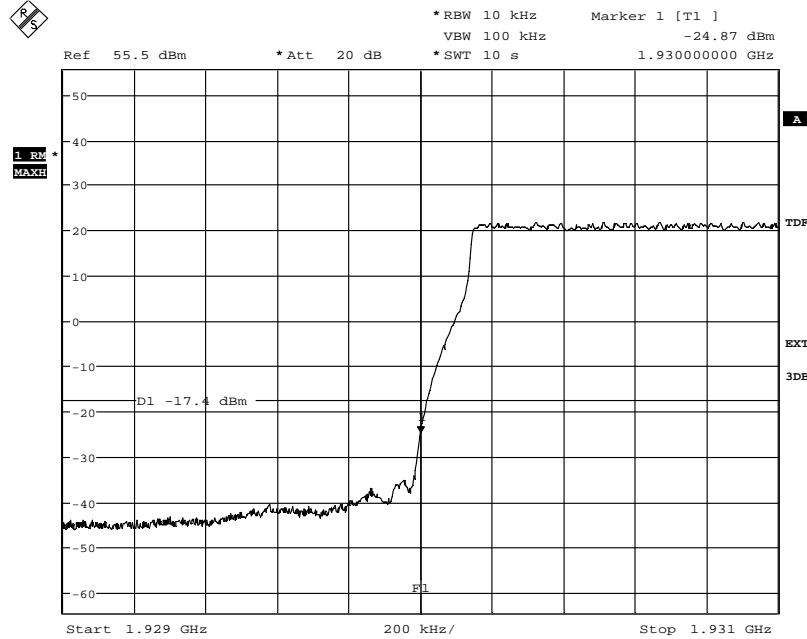

Date: 17.OCT.2013 15:10:15

Diagram 2 b:

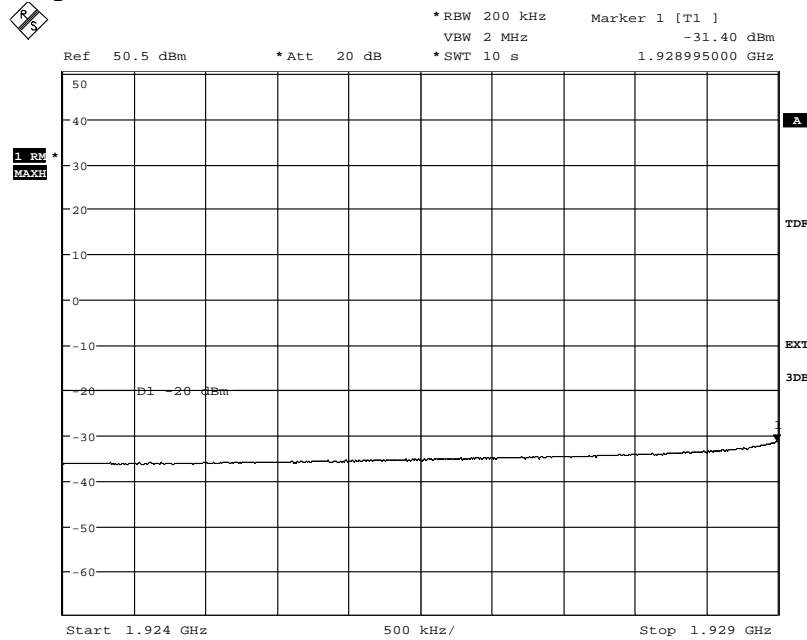

Date: 17.OCT.2013 15:08:34

Appendix 4

Diagram 2 c:

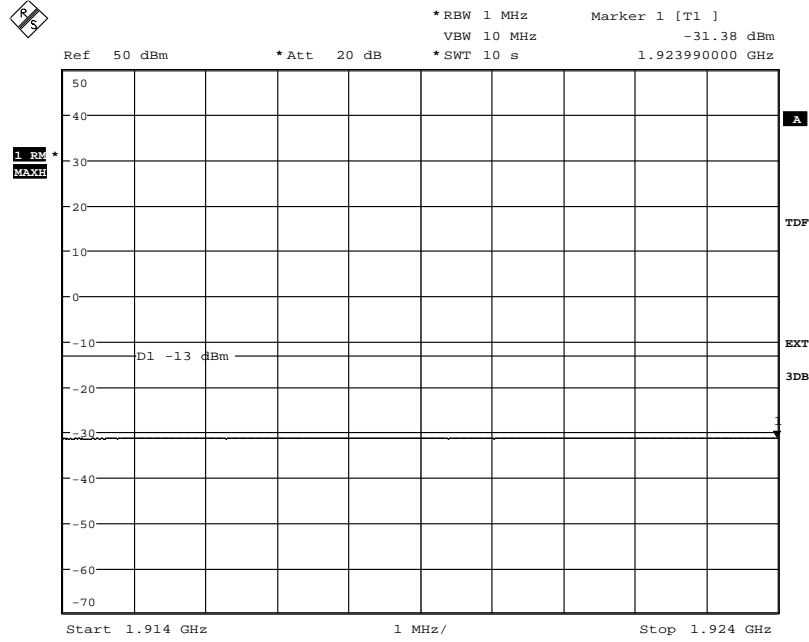

Date: 17.OCT.2013 15:06:45

Appendix 4

Diagram 3 a:

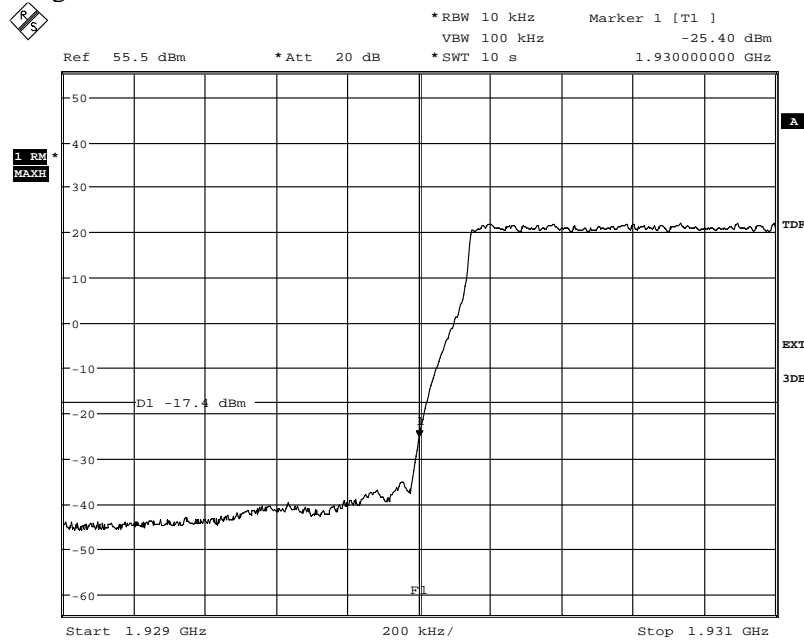

Date: 17.OCT.2013 13:54:45

Diagram 3 b:

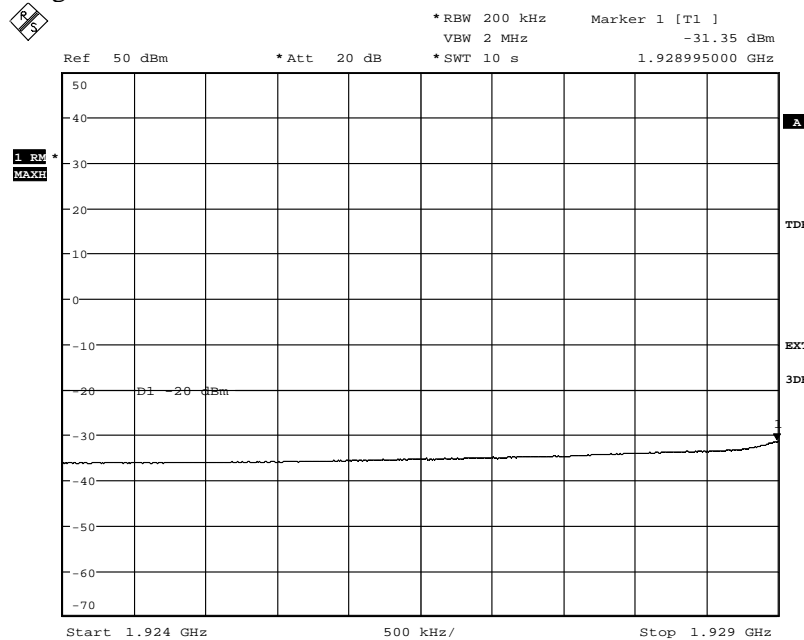

Date: 17.OCT.2013 13:59:09

Appendix 4

Diagram 3 c:

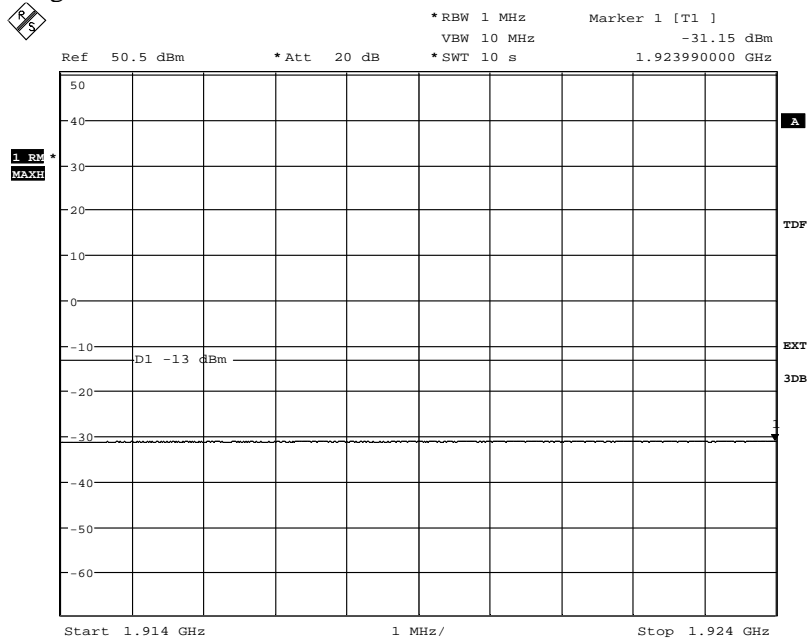

Date: 17.OCT.2013 14:05:02

Appendix 4

Diagram 4 a:

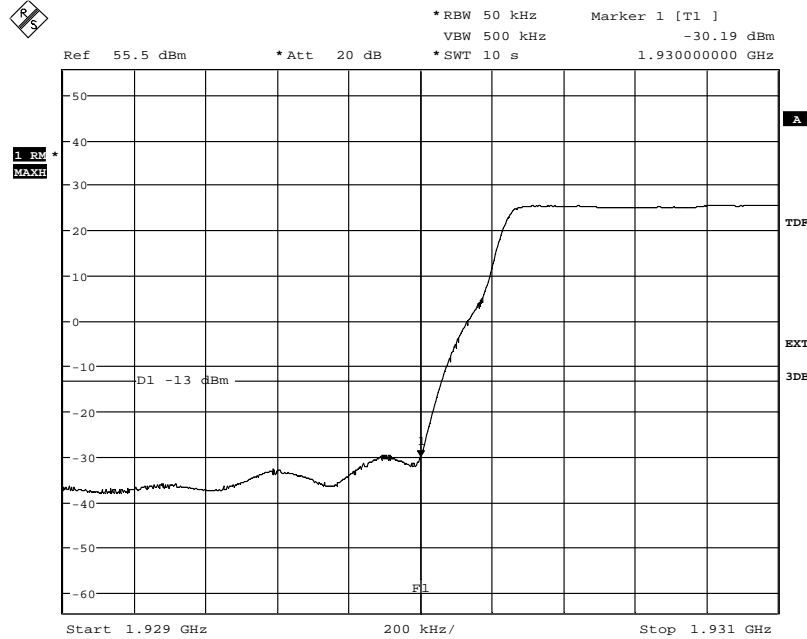

Date: 17.OCT.2013 15:13:35

Diagram 4 b:

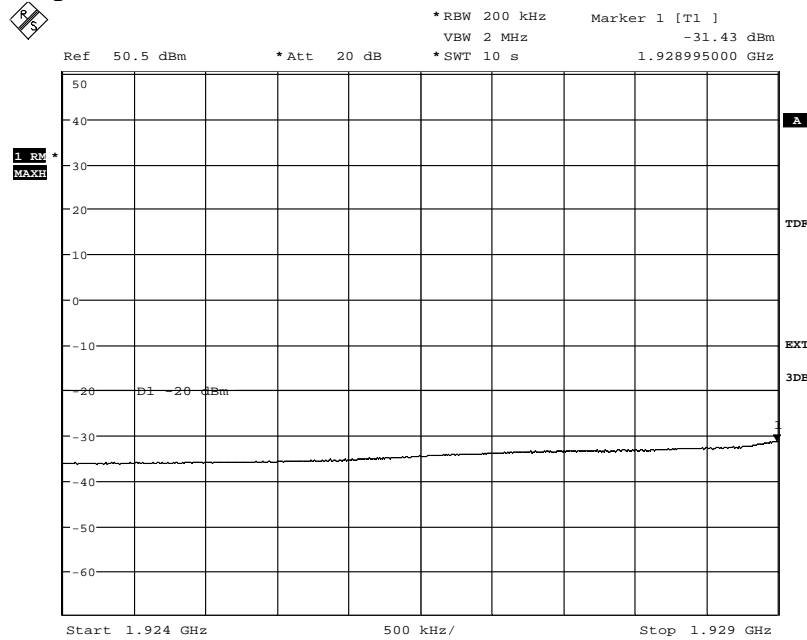

Date: 17.OCT.2013 15:15:11

Appendix 4

Diagram 4 c:

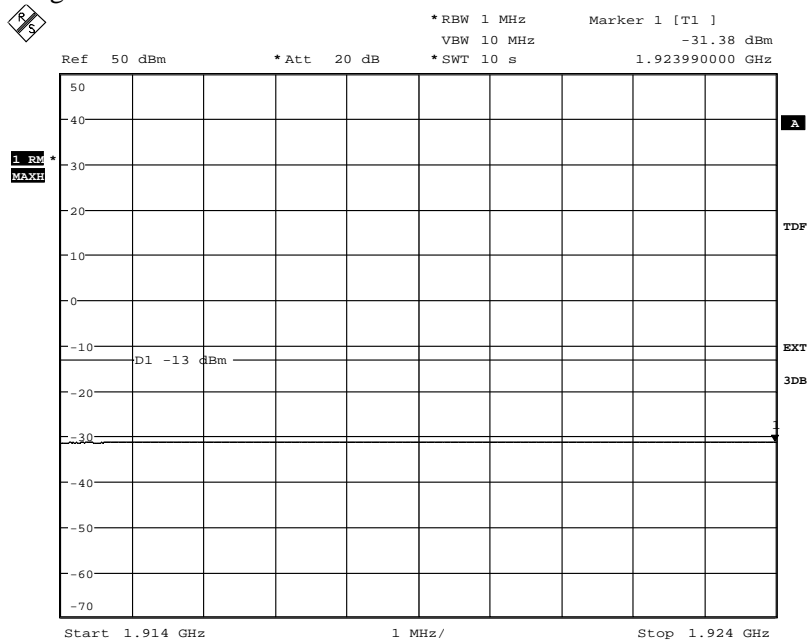

Date: 17.OCT.2013 15:16:25

Appendix 4

Diagram 5 a:

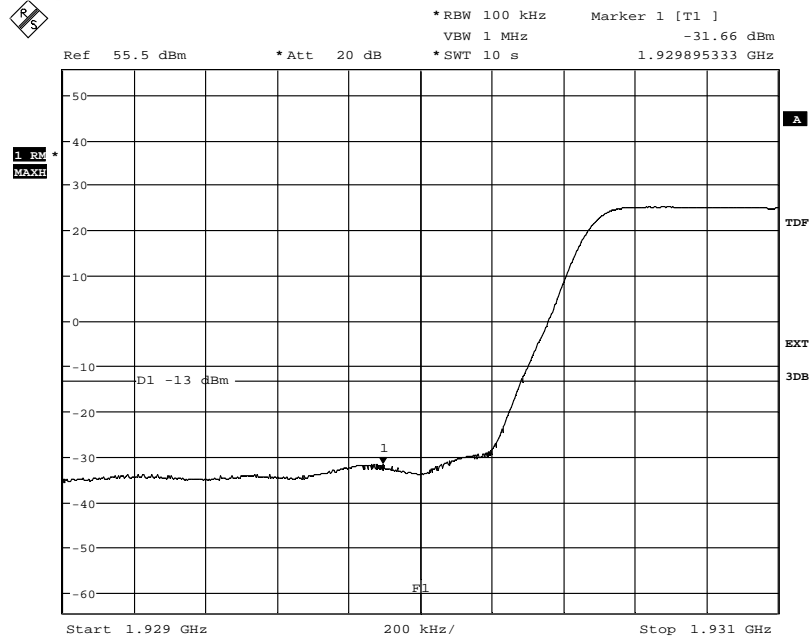

Date: 17.OCT.2013 15:35:01

Diagram 5 b:

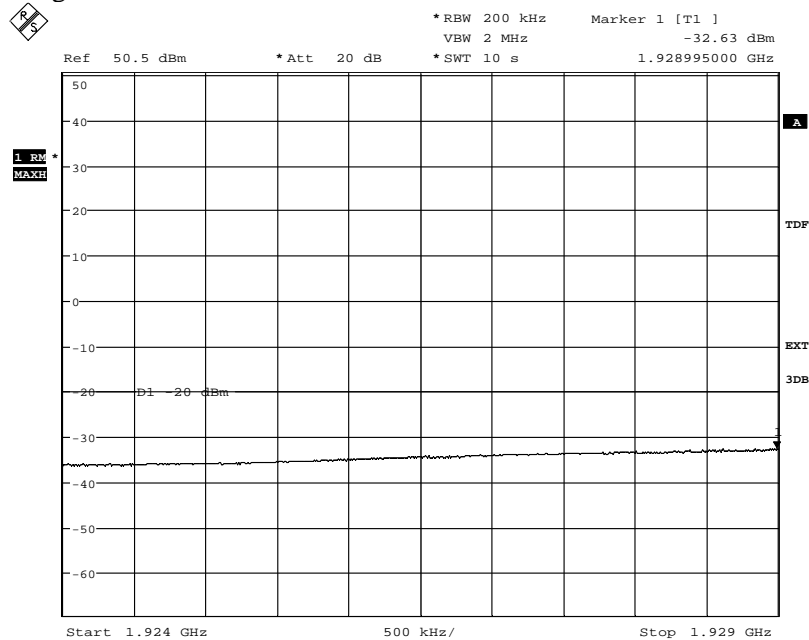

Date: 17.OCT.2013 15:19:06

Appendix 4

Diagram 5 c:

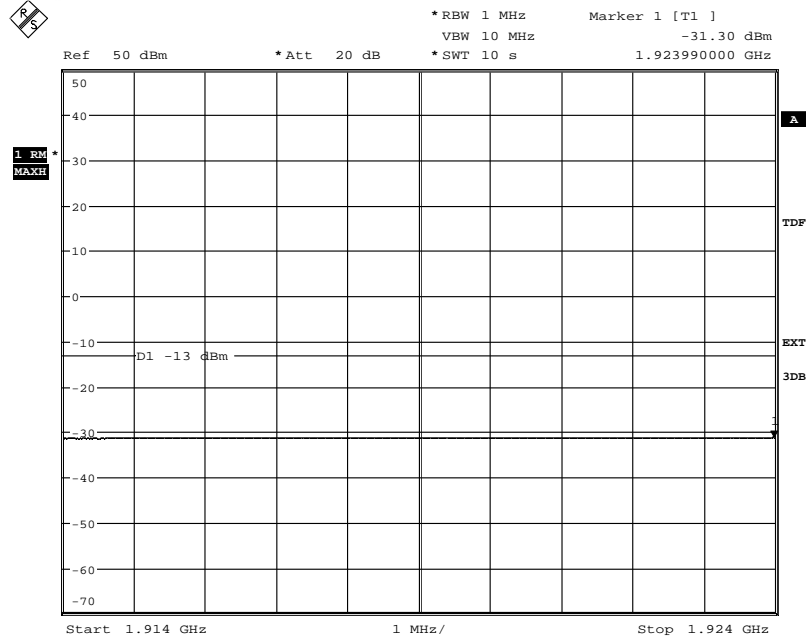

Date: 17.OCT.2013 15:17:54

Appendix 4

Diagram 6 a:

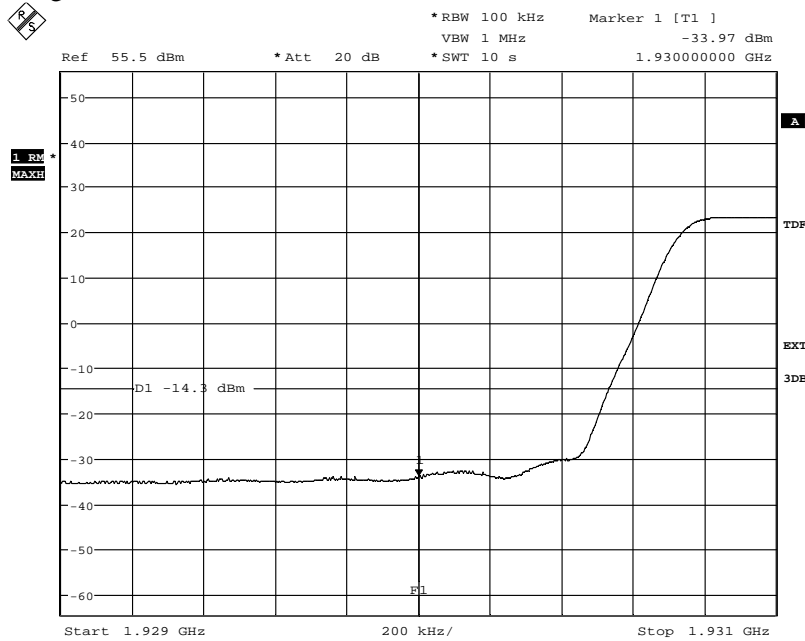

Date: 17.OCT.2013 15:24:15

Diagram 6 b:

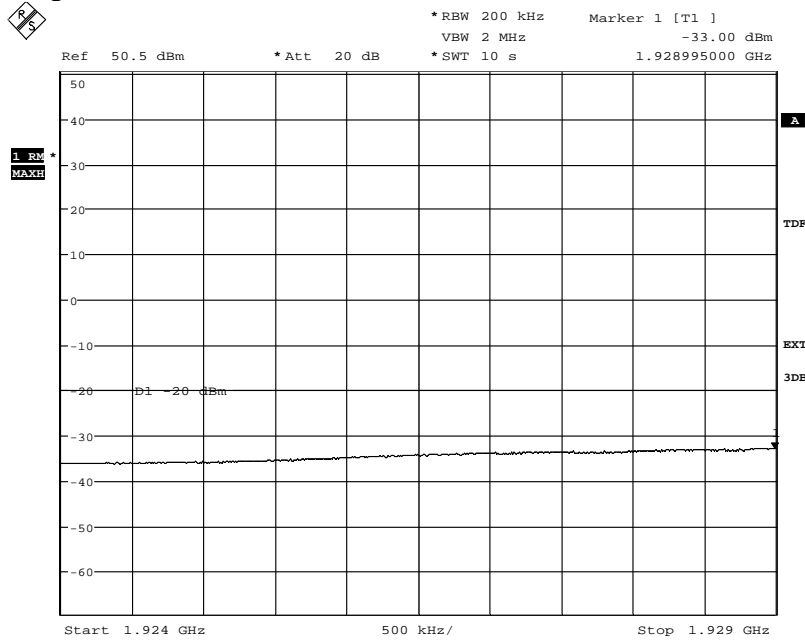

Date: 17.OCT.2013 15:26:08

Appendix 4

Diagram 6 c:

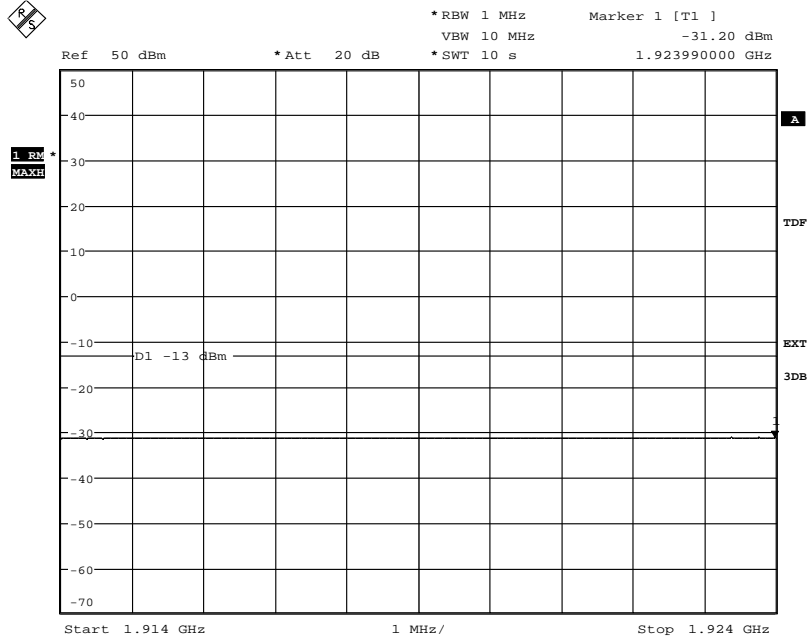

Date: 17.OCT.2013 15:29:25

Appendix 4

Diagram 7 a:

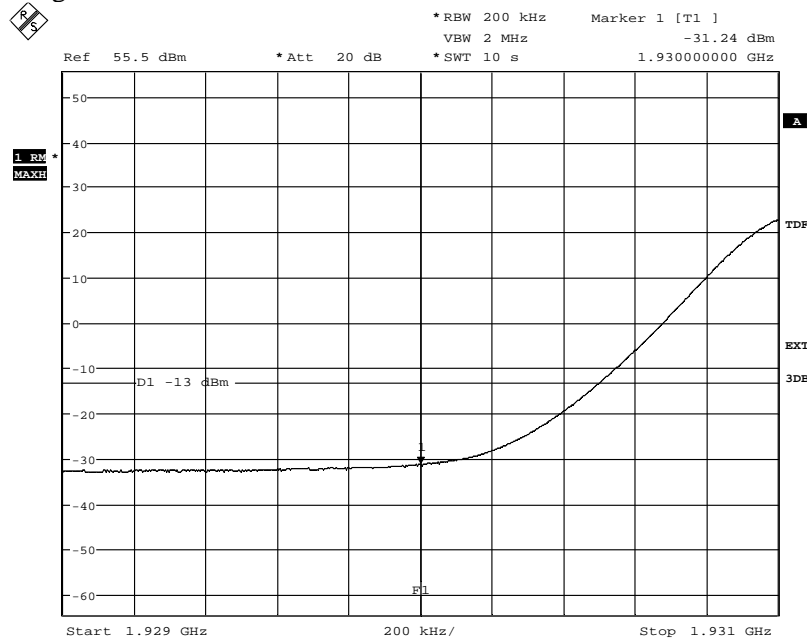

Date: 17.OCT.2013 15:33:13

Diagram 7 b:

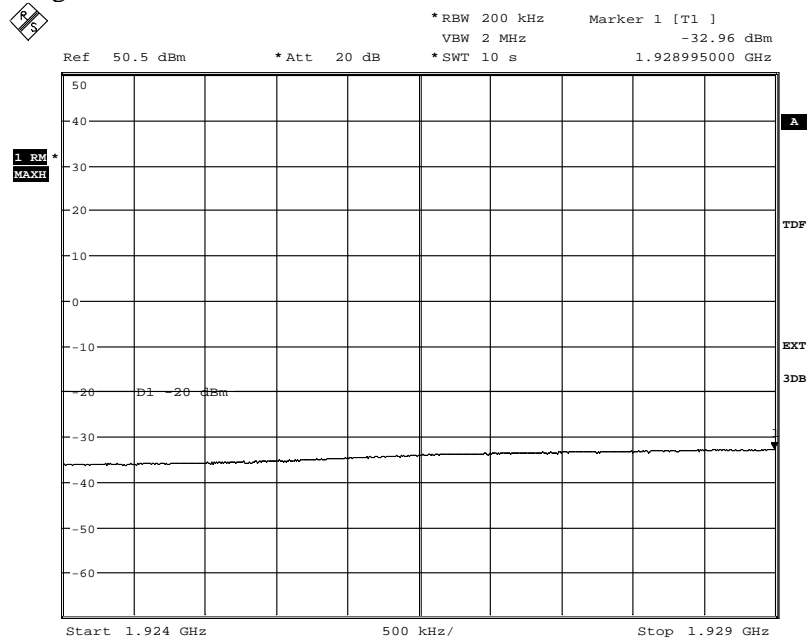

Date: 17.OCT.2013 15:32:04

Appendix 4

Diagram 7 c:

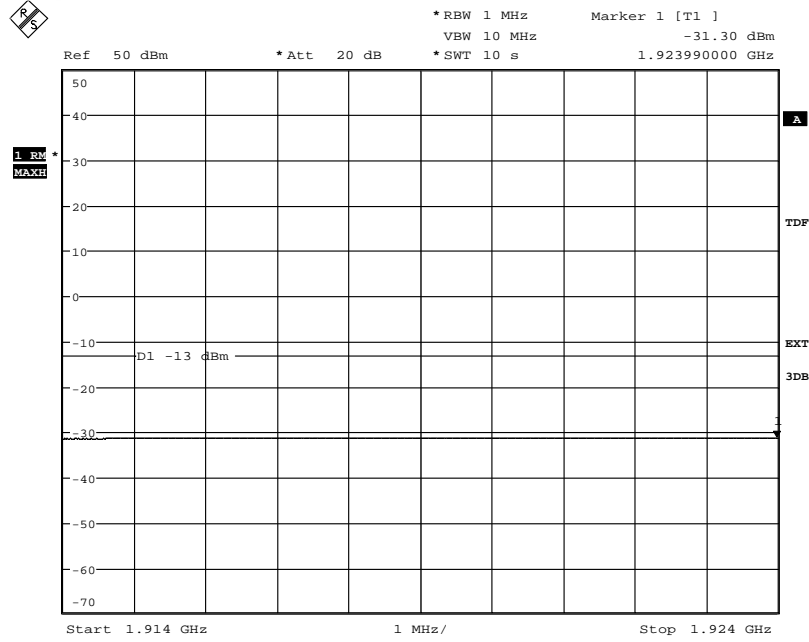

Date: 17.OCT.2013 15:30:48

Appendix 4

Diagram 8 a:

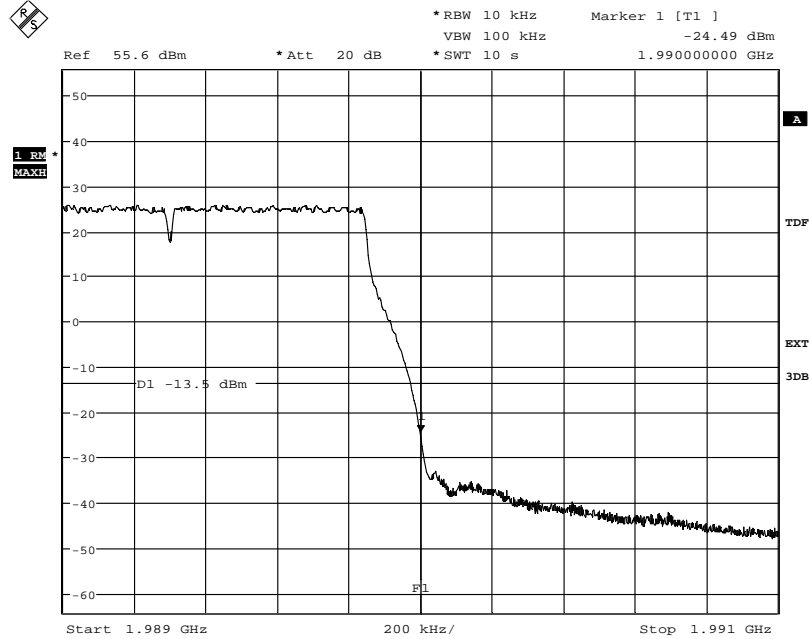

Date: 17.OCT.2013 16:02:52

Diagram 8 b:

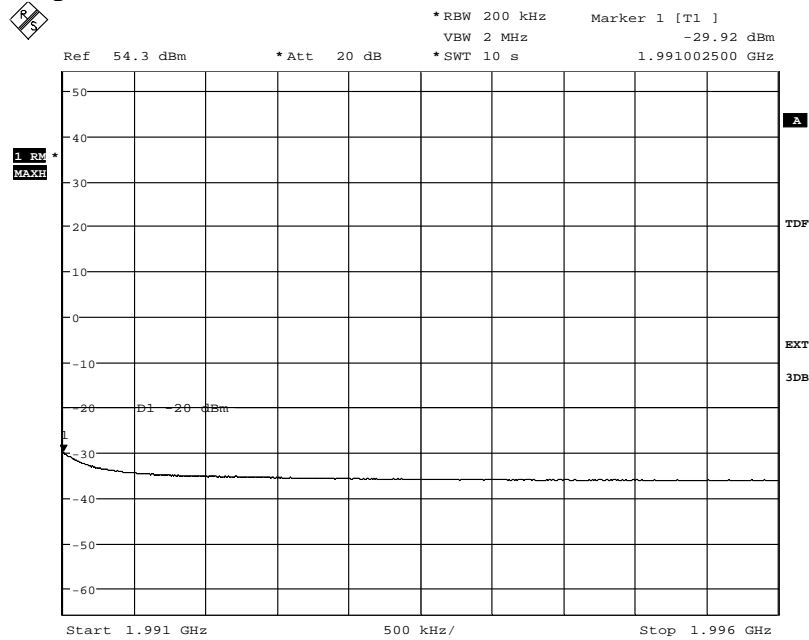

Date: 17.OCT.2013 16:04:06

Appendix 4

Diagram 8 c:

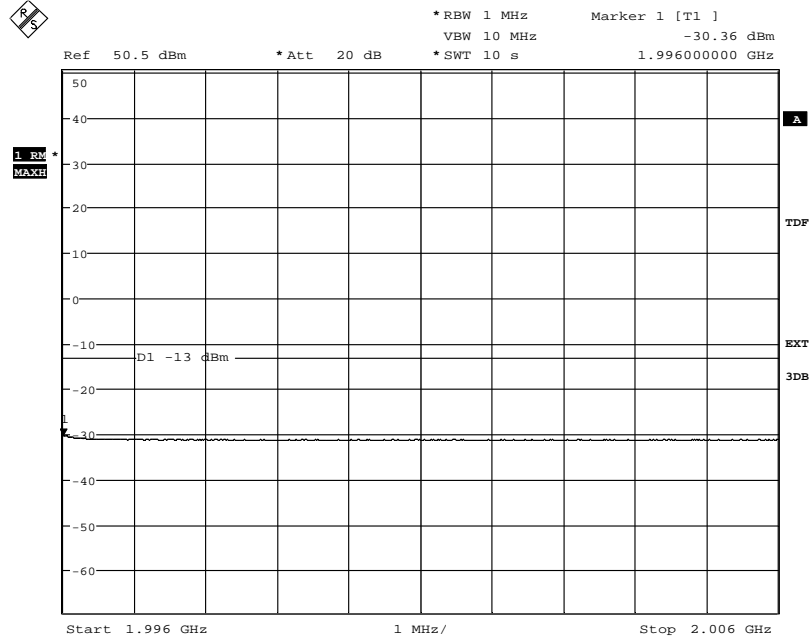

Date: 17.OCT.2013 16:20:19

Appendix 4

Diagram 9 a:

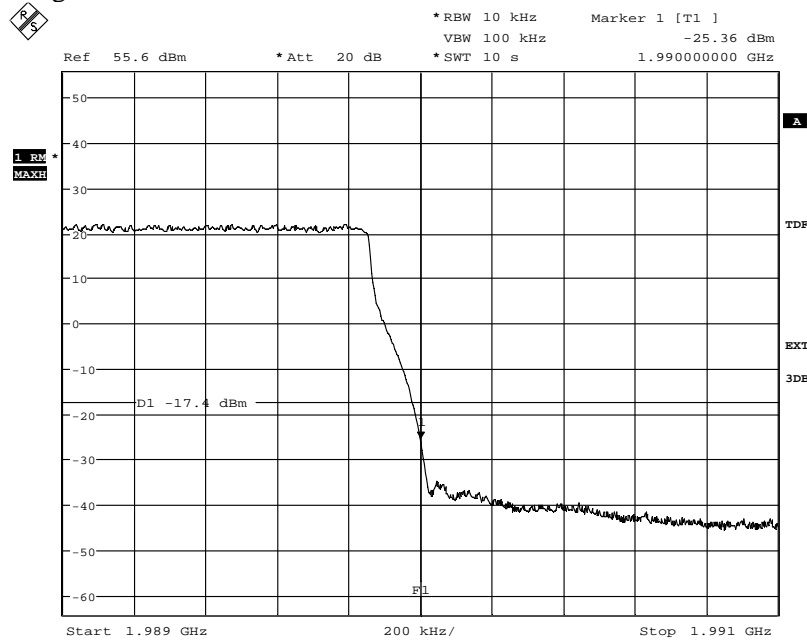

Date: 17.OCT.2013 15:56:12

Diagram 9 b:

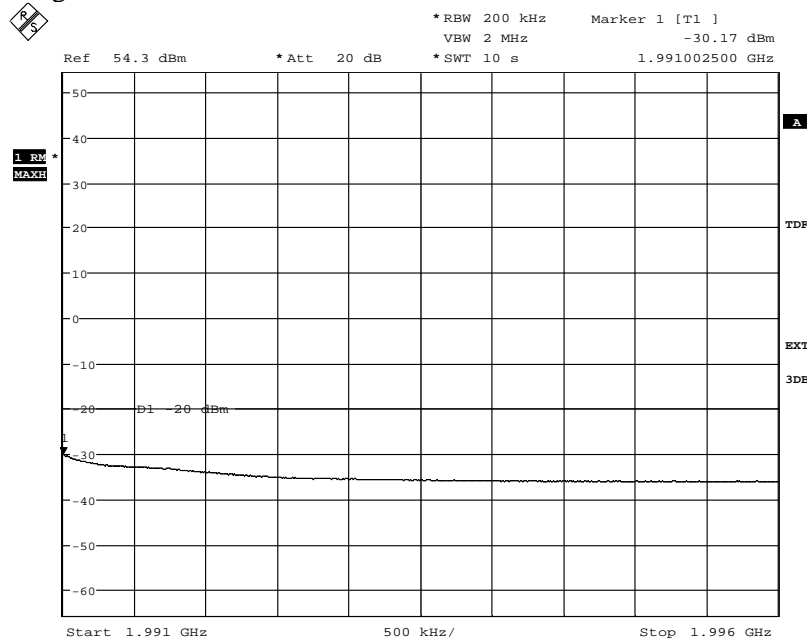

Date: 17.OCT.2013 15:50:23

Appendix 4

Diagram 9 c:

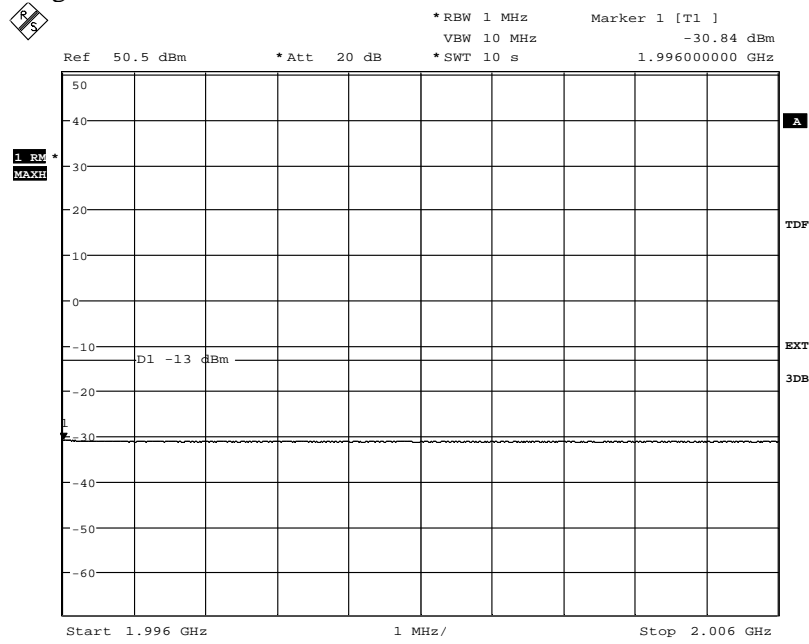

Date: 17.OCT.2013 15:51:12

Appendix 4

Diagram 10 a:

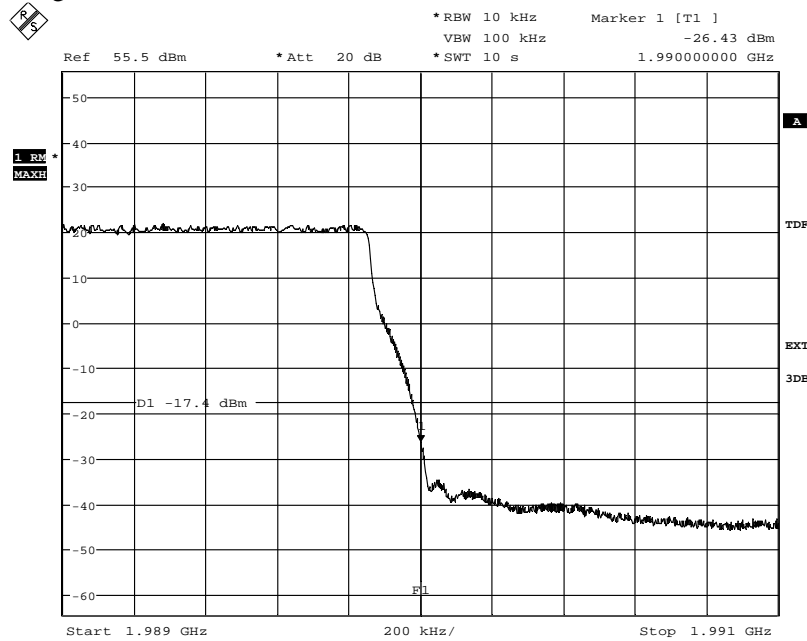

Date: 17.OCT.2013 14:13:22

Diagram 10 b:

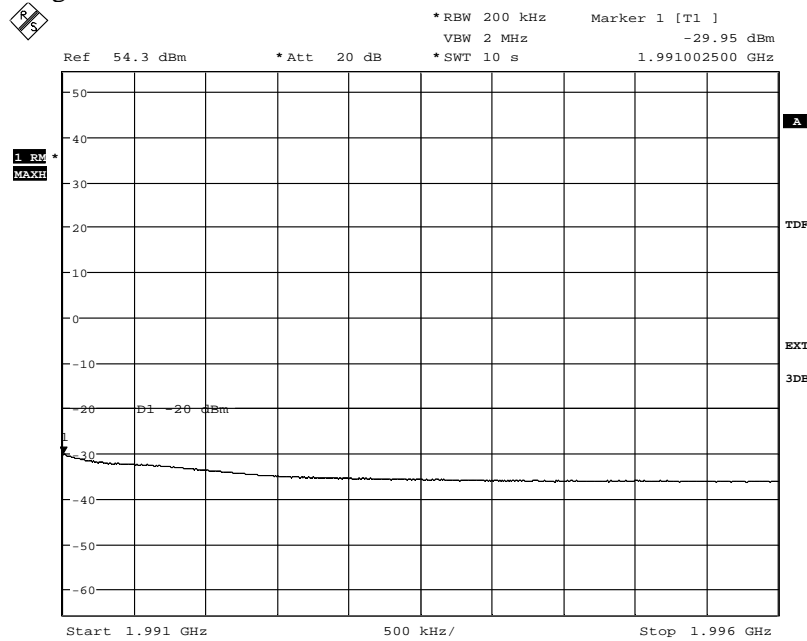

Date: 17.OCT.2013 14:23:42

Appendix 4

Diagram 10 c:

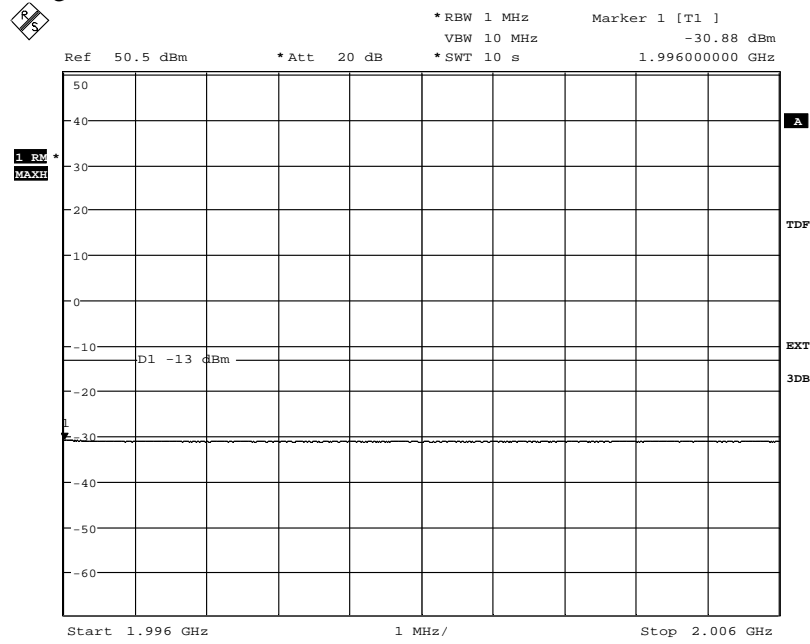

Date: 17.OCT.2013 14:26:13

Appendix 4

Diagram 11 a:

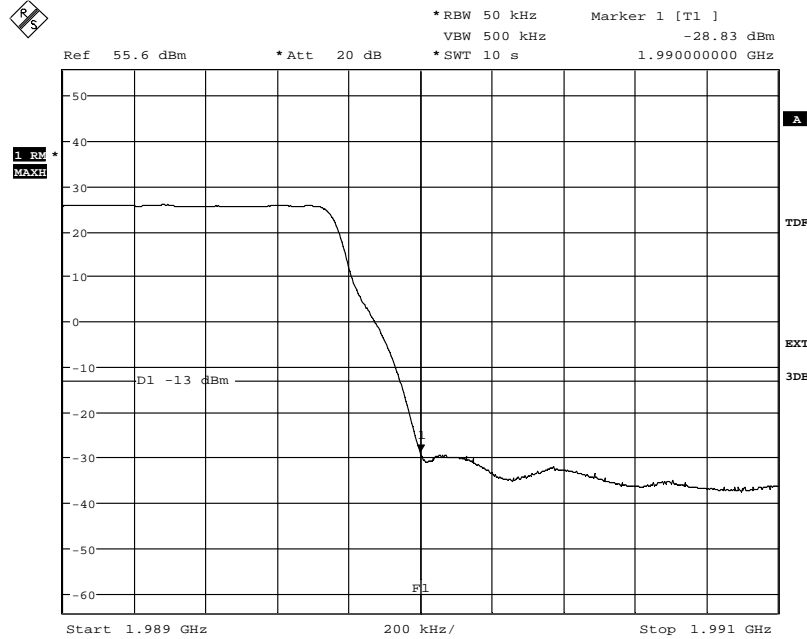

Date: 17.OCT.2013 16:13:12

Diagram 11 b:

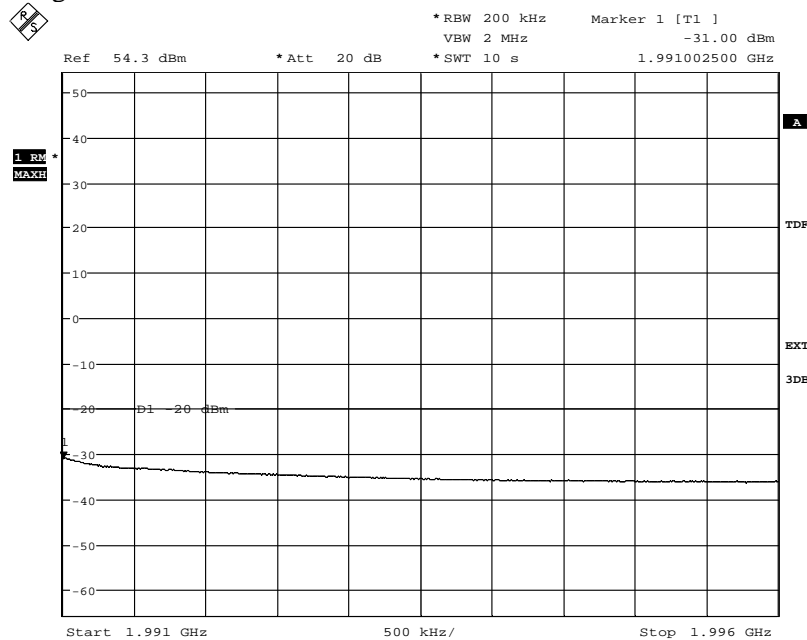

Date: 17.OCT.2013 16:10:42

Appendix 4

Diagram 11 c:

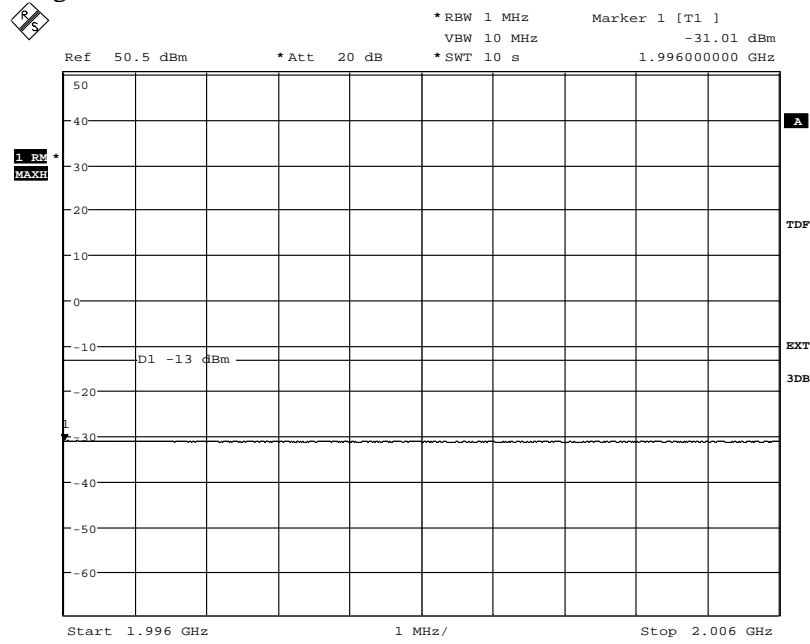

Date: 17.OCT.2013 16:09:33

Appendix 4

Diagram 12 a:

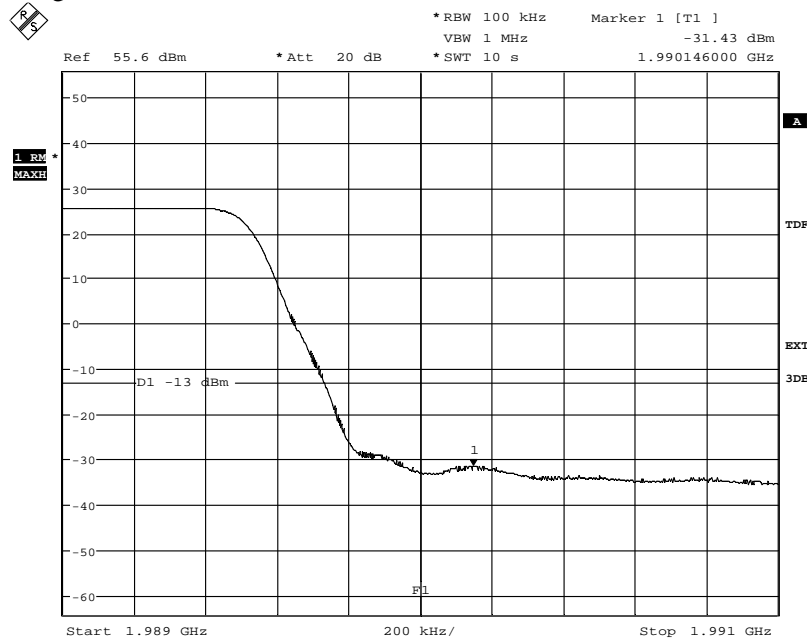

Date: 17.OCT.2013 16:15:22

Diagram 12 b:

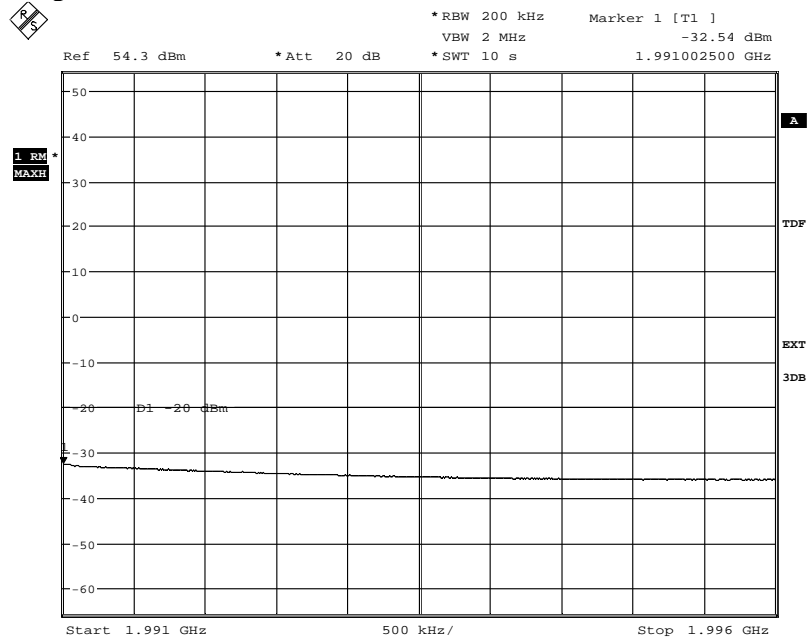

Date: 17.OCT.2013 16:18:17

Appendix 4

Diagram 12 c:

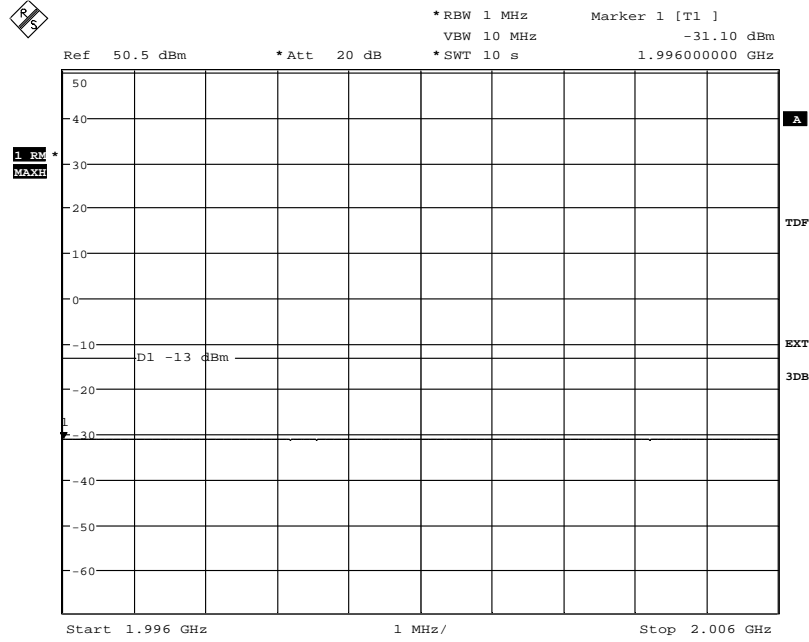

Date: 17.OCT.2013 16:19:19

Appendix 4

Diagram 13 a:

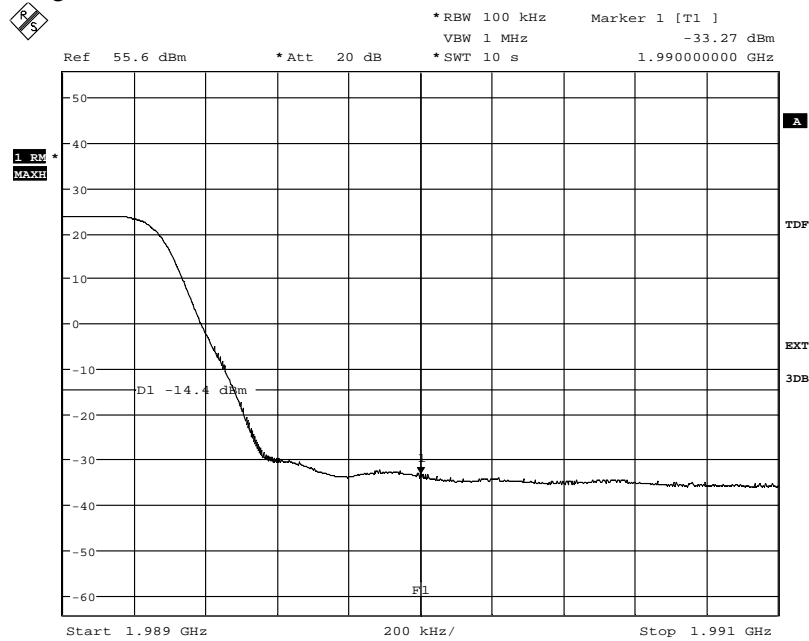

Date: 17.OCT.2013 16:24:15

Diagram 13 b:

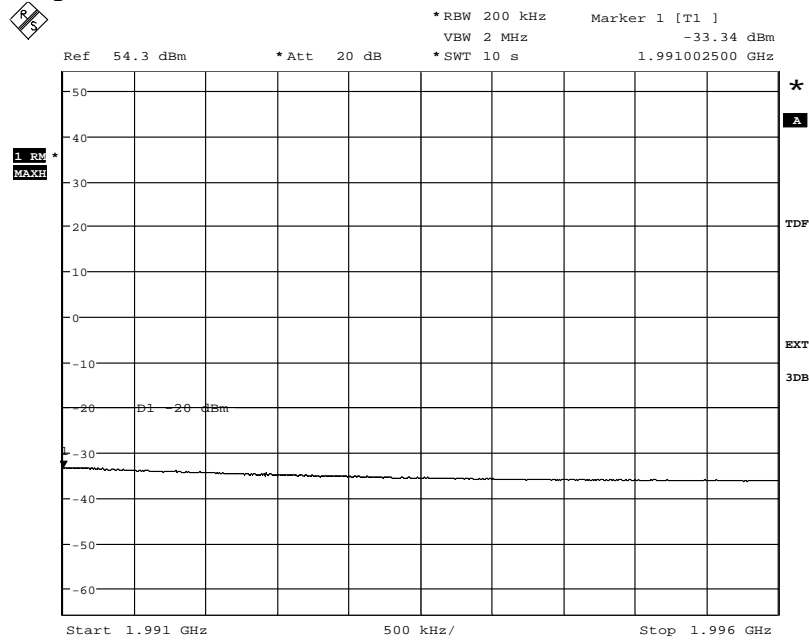

Date: 17.OCT.2013 16:23:05

Appendix 4

Diagram 13 c:

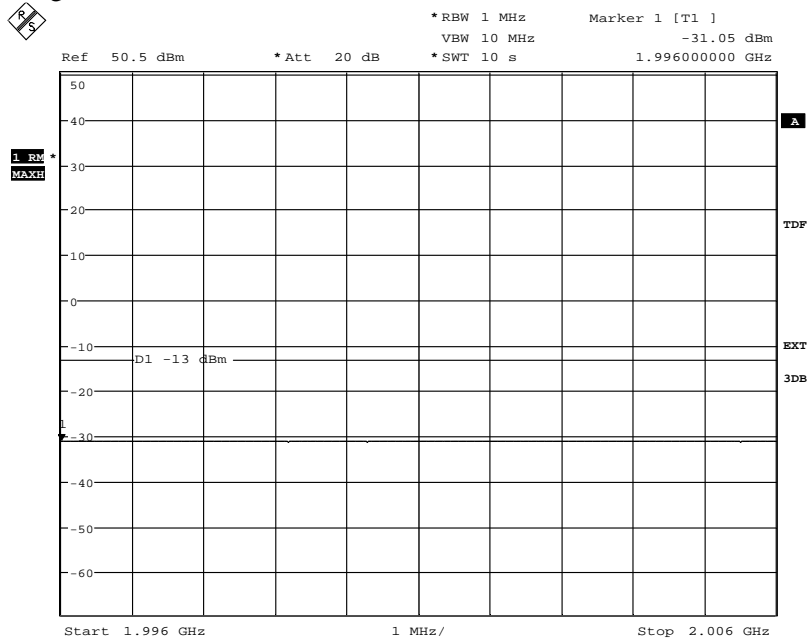

Date: 17.OCT.2013 16:22:16

Appendix 4

Diagram 14 a:

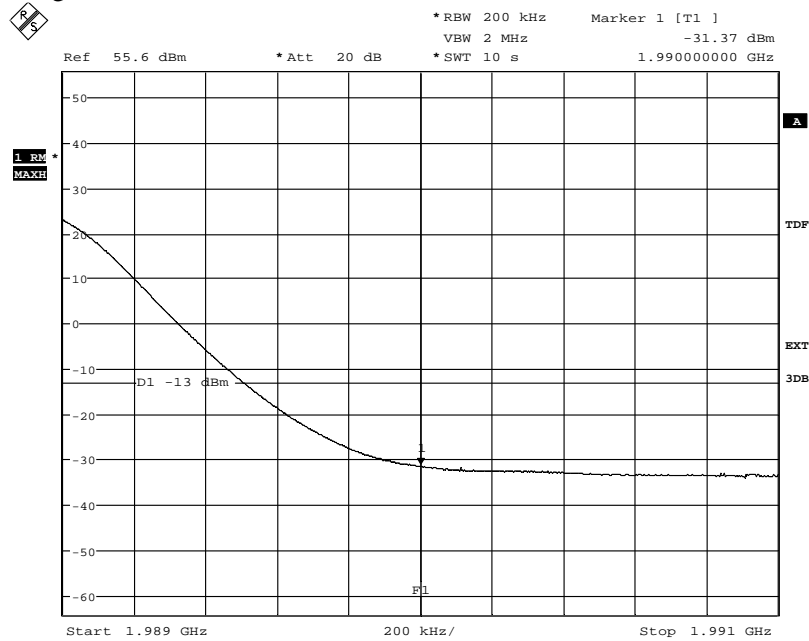

Date: 17.OCT.2013 16:26:02

Diagram 14 b:

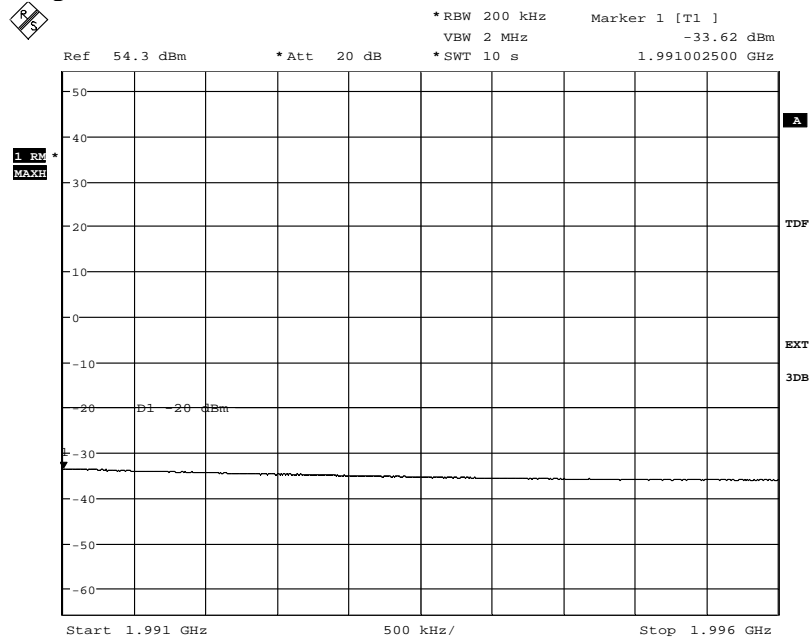

Date: 17.OCT.2013 16:27:08

Appendix 4

Diagram 14 c:

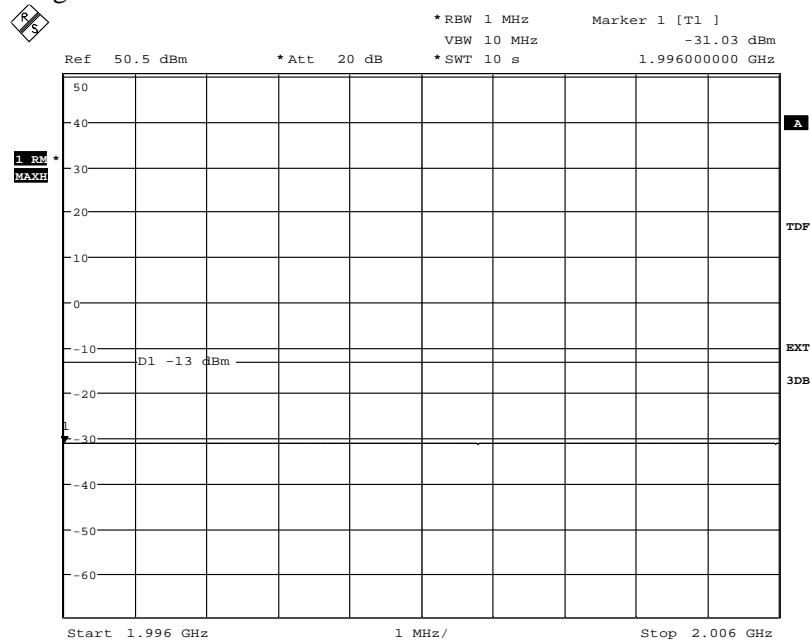

Date: 17.OCT.2013 16:28:13

Appendix 4

Diagram 15 a:

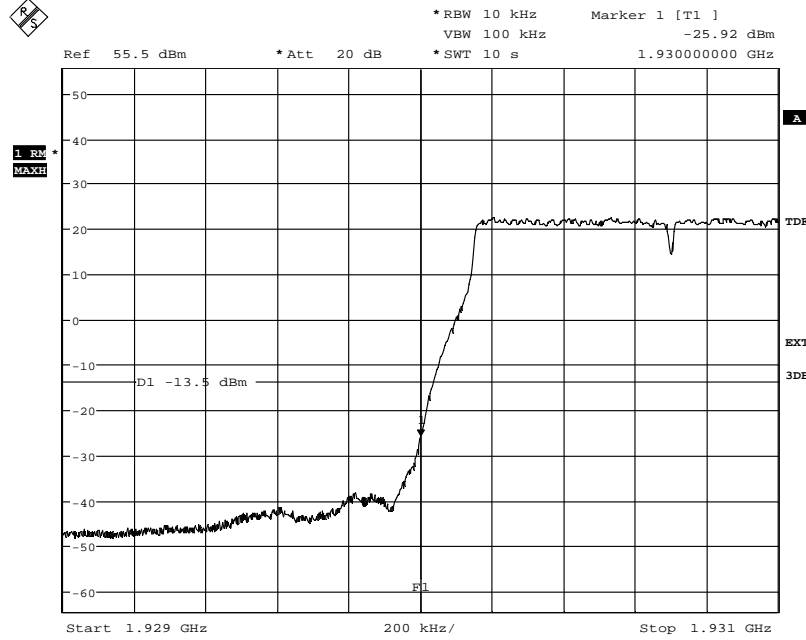

Date: 18.OCT.2013 15:09:42

Diagram 15 b:

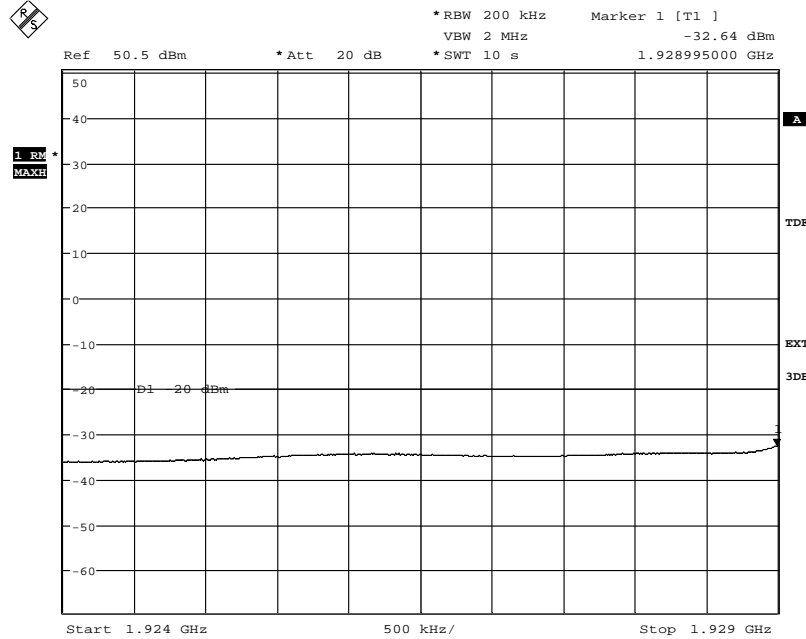

Date: 18.OCT.2013 15:22:39

Appendix 4

Diagram 15 c:

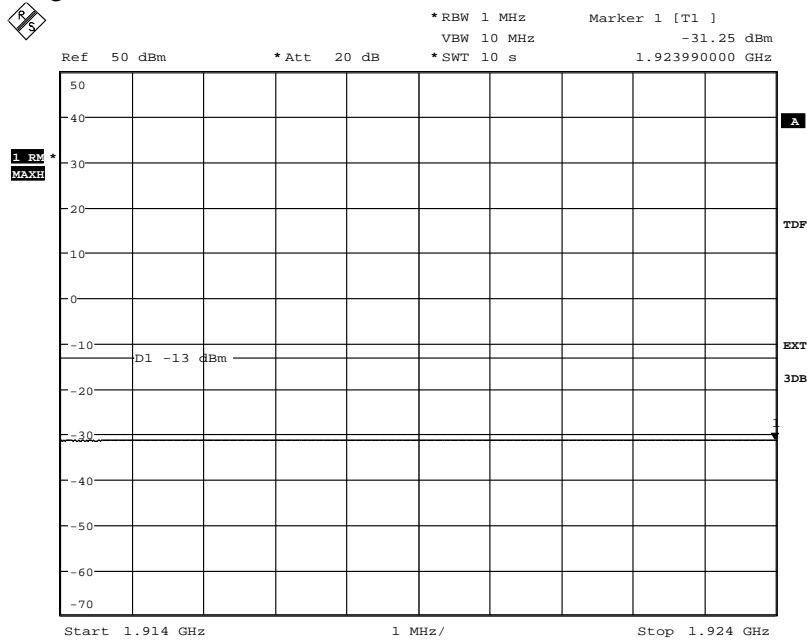

Date: 18.OCT.2013 15:23:54

Appendix 4

Diagram 16 a:

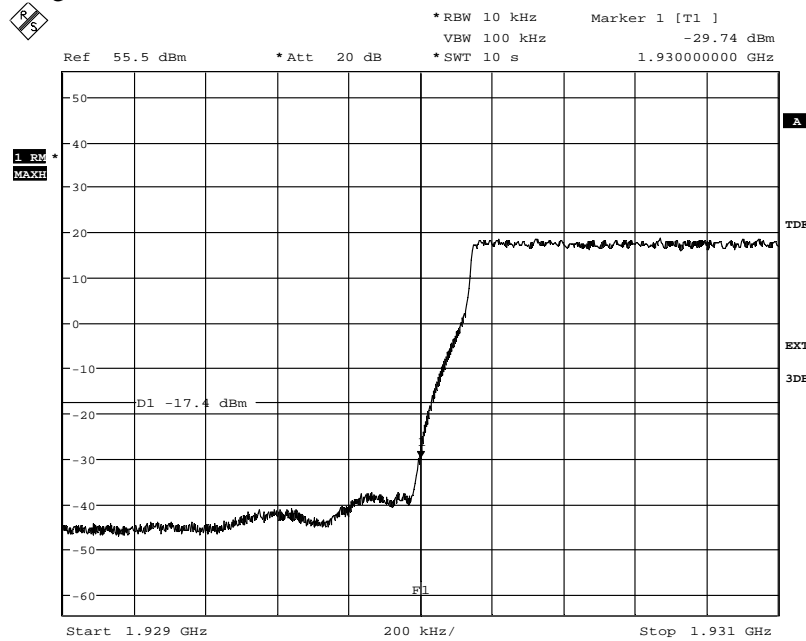

Date: 18.OCT.2013 15:42:08

Diagram 16 b:

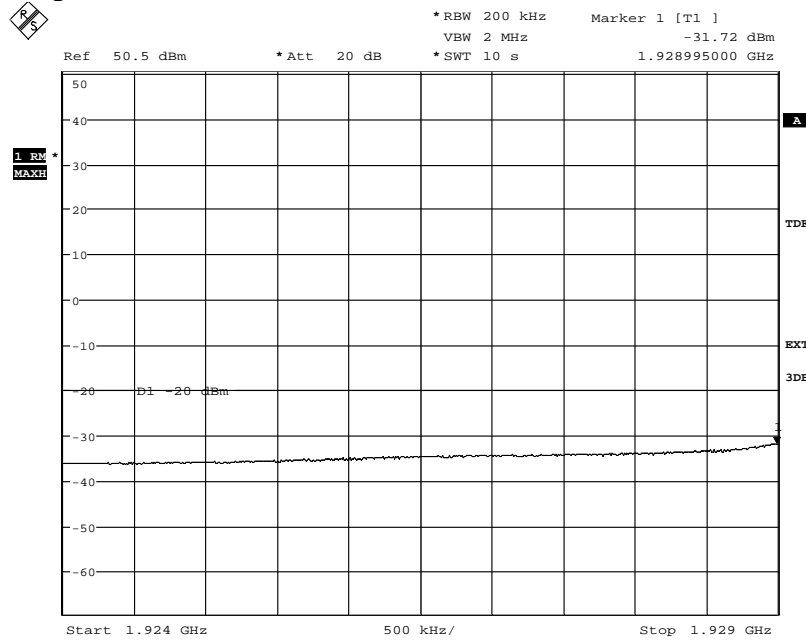

Date: 18.OCT.2013 15:41:16

Appendix 4

Diagram 16 c:

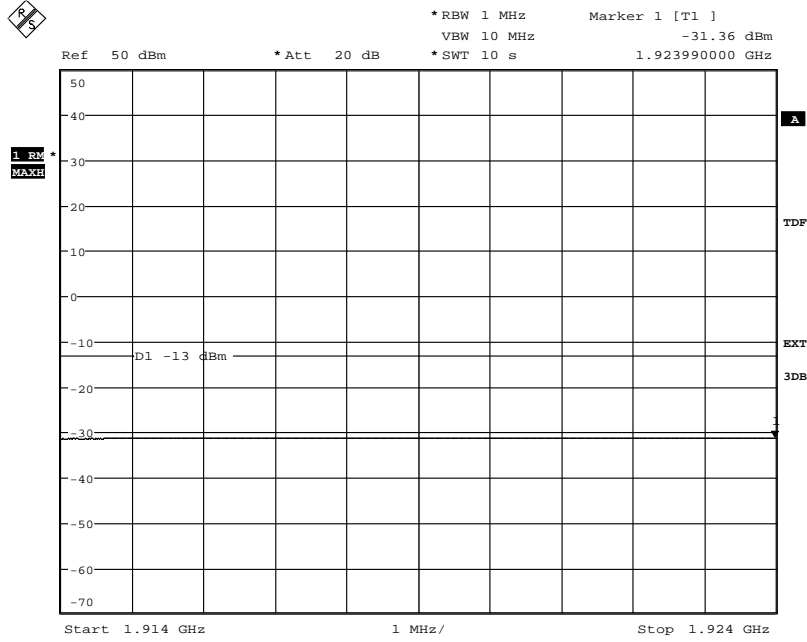

Date: 18.OCT.2013 15:36:48

Appendix 4

Diagram 17 a:

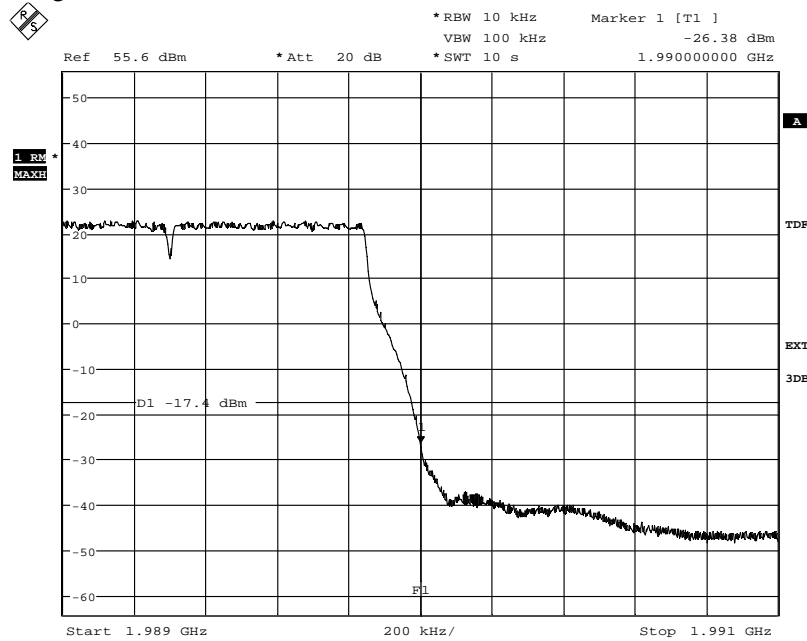

Date: 18.OCT.2013 15:54:35

Diagram 17 b:

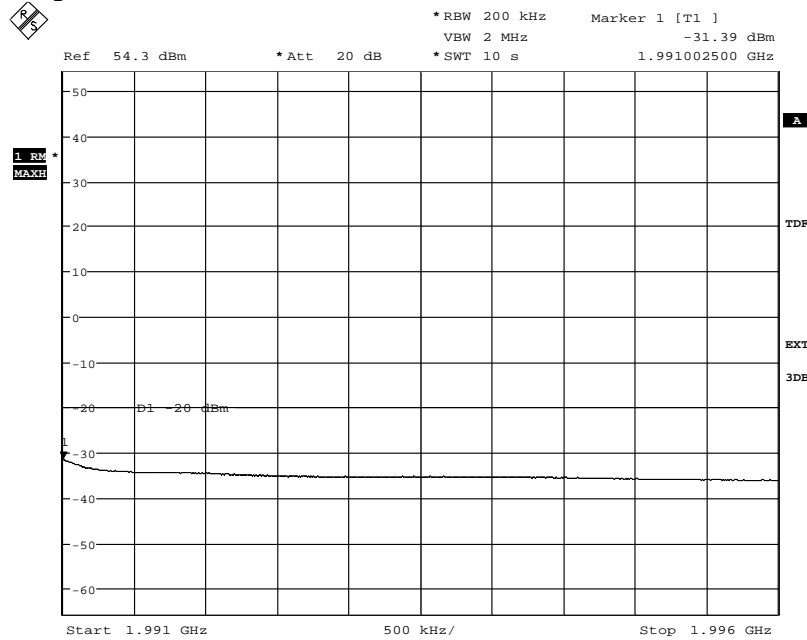

Date: 18.OCT.2013 15:53:49

Appendix 4

Diagram 17 c:

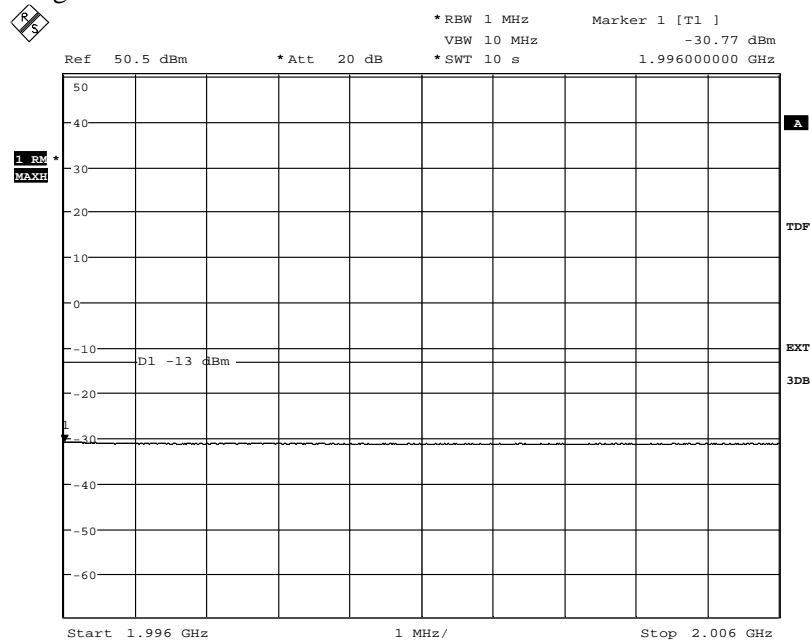

Date: 18.OCT.2013 15:52:59

Appendix 4

Diagram 18 a:

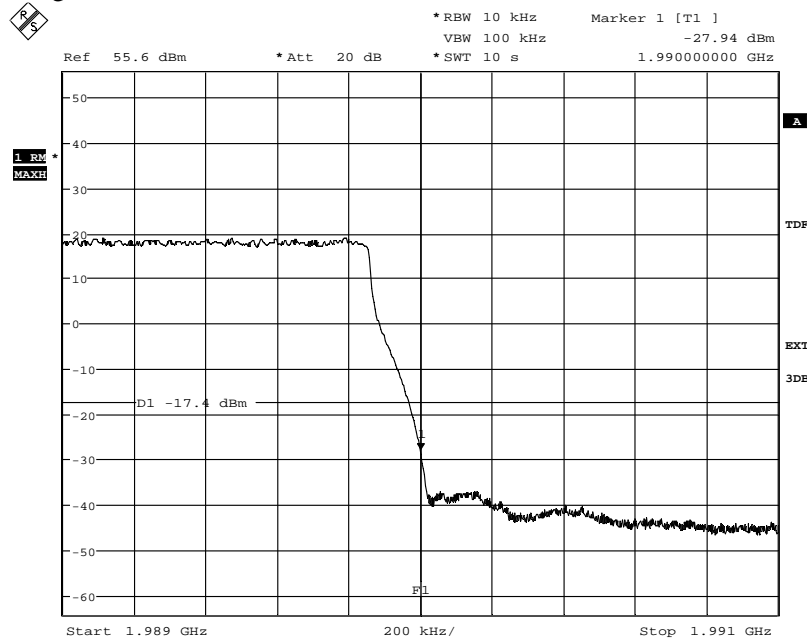

Date: 18.OCT.2013 15:46:29

Diagram 18 b:

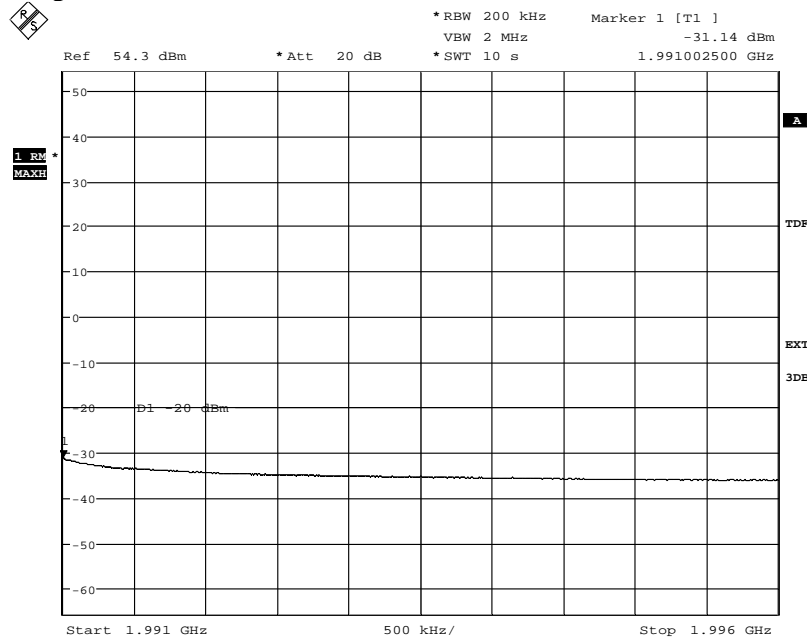

Date: 18.OCT.2013 15:47:26

Appendix 4

Diagram 18 c:

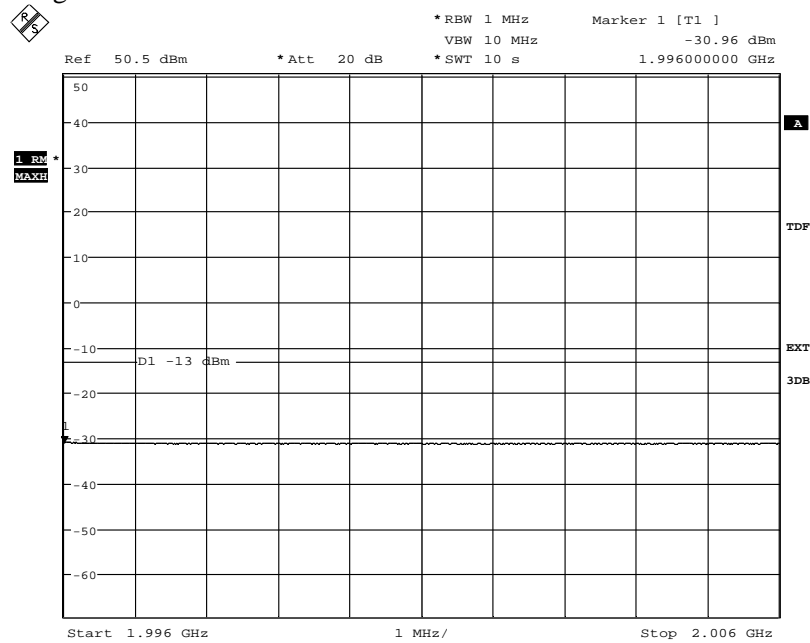

Date: 18.OCT.2013 15:48:23

Appendix 5

Conducted spurious emission measurements according to CFR 47 §24.238 / IC RSS-133 6.5

Date	Temperature	Humidity
2013-10-15	23 °C ± 3 °C	28 % ± 5 %
2013-10-17	22 °C ± 3 °C	37 % ± 5 %
2013-10-18	23 °C ± 3 °C	19 % ± 5 %
2013-10-21	23 °C ± 3 °C	28 % ± 5 %

Test set-up and procedure

The measurements were made per definition in §24.238. The output was connected to a spectrum analyzer with a RBW setting of 1 MHz and RMS detector activated. The spectrum analyzer was connected to an external 10 MHz reference standard during the measurements. Before comparing the results to the limit, 3 dB [10 log (2)] should be added according to method E), 3), a), (iii) Measure and add 10 log(N_{ANT})” of FCC KDB662911 D01 Multiple Transmitter Output v02r01.

Measurement equipment	SP number
R&S FSQ 40	504 143
RF attenuator	901 508
HP filter	901 502
Testo 635, temperature and humidity meter	504 203

Measurement uncertainty: 3.7 dB

Appendix 5

Results

MIMO mode, single carrier

Diagram	BW configuration	Symbolic name	Tested Port
1 a+b+c+d	1.4 MHz	B	RF A
2 a+b+c+d	20 MHz	B	RF A
3 a+b+c+d	1.4 MHz	M	RF A
4 a+b+c+d	1.4 MHz	M	RF B
5 a+b+c+d	3 MHz	M	RF A
6 a+b+c+d	5 MHz	M	RF A
7 a+b+c+d	10 MHz	M	RF A
8 a+b+c+d	15 MHz	M	RF A
9 a+b+c+d	20 MHz	M	RF A
10 a+b+c+d	20 MHz	M	RF B
11 a+b+c+d	1.4 MHz	T	RF A
12 a+b+c+d	20 MHz	T	RF A

MIMO mode, multi carrier

Diagram	BW configuration	Symbolic name	Tested Port
13 a+b+c+d+e	1.4 MHz	B2im1	RF A
14 a+b+c+d+e	1.4 MHz	B2im2	RF A
15 a+b+c+d	1.4 MHz	M3	RF A
16 a+b+c+d+e	1.4 MHz	T2im1	RF A
17 a+b+c+d+e	1.4 MHz	T2im2	RF A

Note: Measurements were limited to port RF A due to the measurement result in single carrier mode that shows that the ports are electrical identical as declared by the client.

Appendix 5

Remark

The highest internal frequency as declared by the client was 1.990 GHz, thus the choice of the upper frequency boundary was set to $10 \times 2 \text{ GHz} = 20 \text{ GHz}$ for emission measurements.

Limits

§24.238 and RSS-133 6.5

Outside a licensee's frequency band(s) of operation the power of any emission shall be attenuated below the transmitter power (P) by at least $43 + 10 \log (P) \text{ dB}$, resulting in a limit of -13 dBm per 1 MHz RBW.

Complies?	Yes
-----------	-----

Appendix 5

Diagram 1 a:

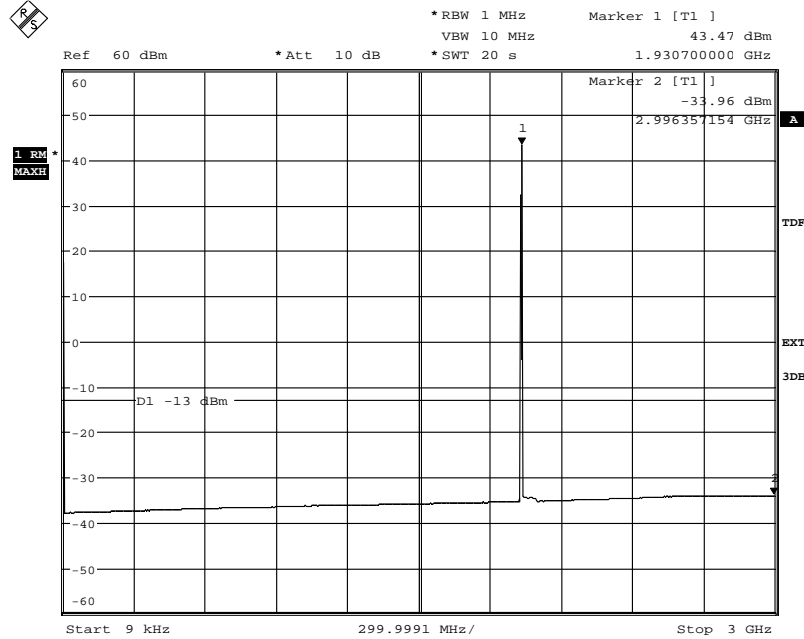

Date: 17.OCT.2013 12:21:32

Diagram 1 b:

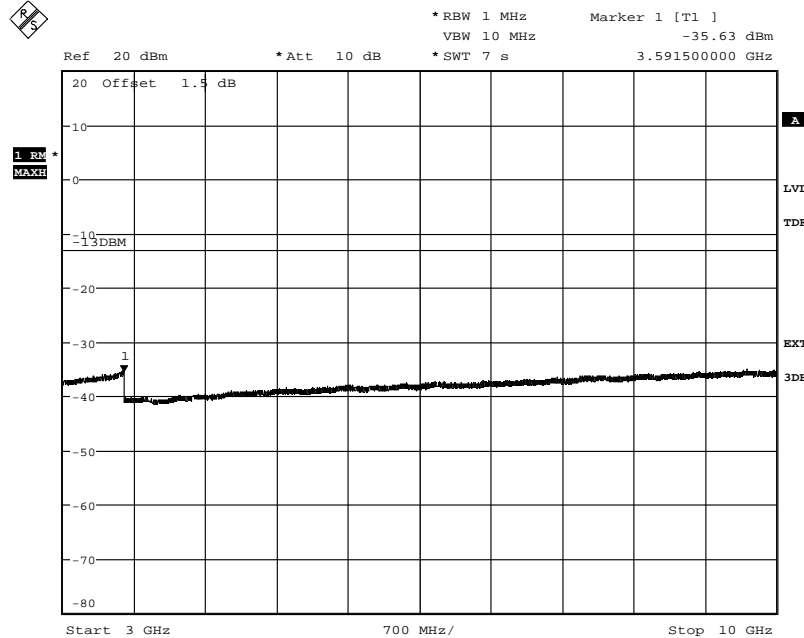

Date: 15.OCT.2013 16:03:59

Appendix 5

Diagram 1 c:

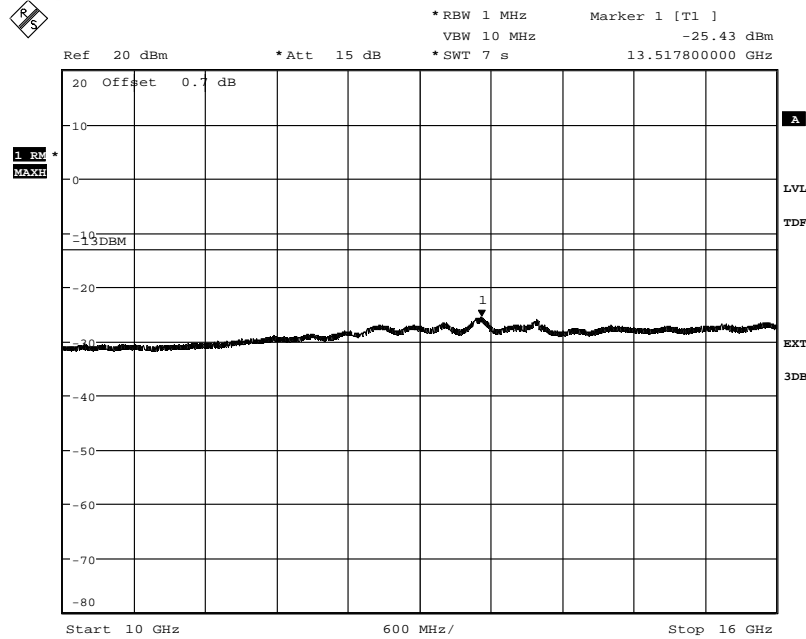

Date: 15.OCT.2013 16:02:53

Diagram 1 d:

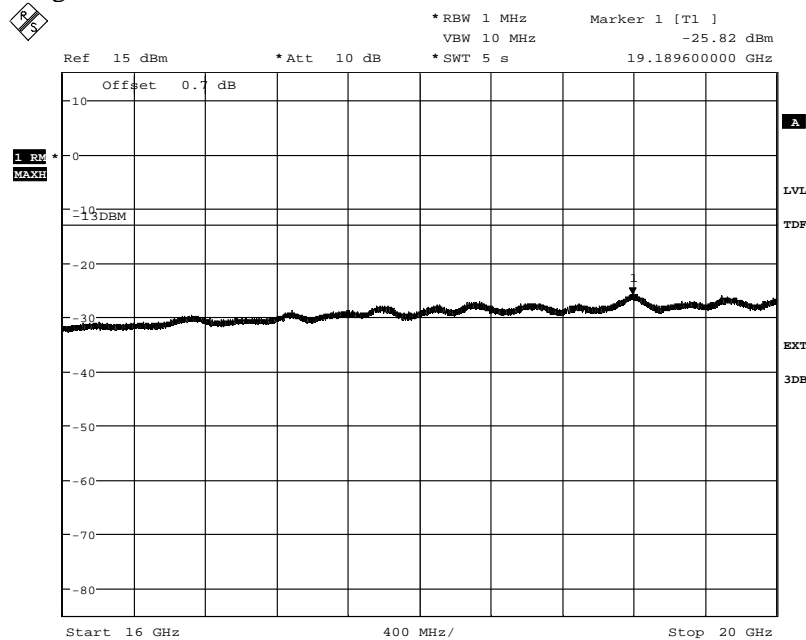

Date: 15.OCT.2013 16:01:45

Appendix 5

Diagram 2 a:

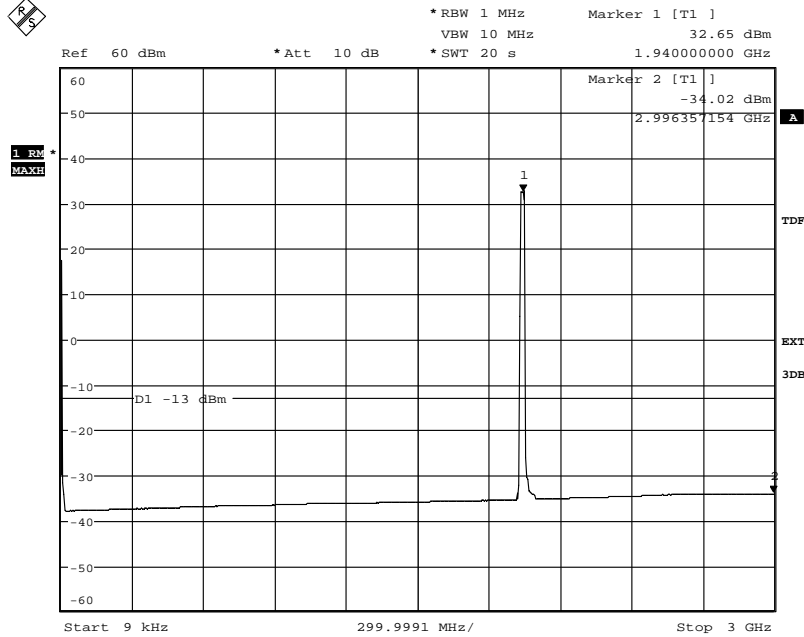

Date: 17.OCT.2013 12:20:08

Diagram 2 b:

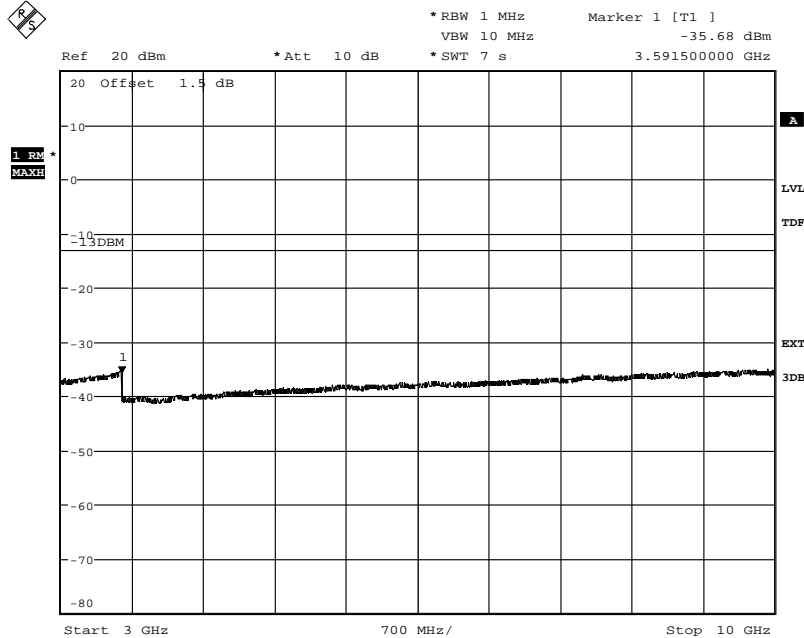

Date: 15.OCT.2013 16:09:51

Appendix 5

Diagram 2 c:

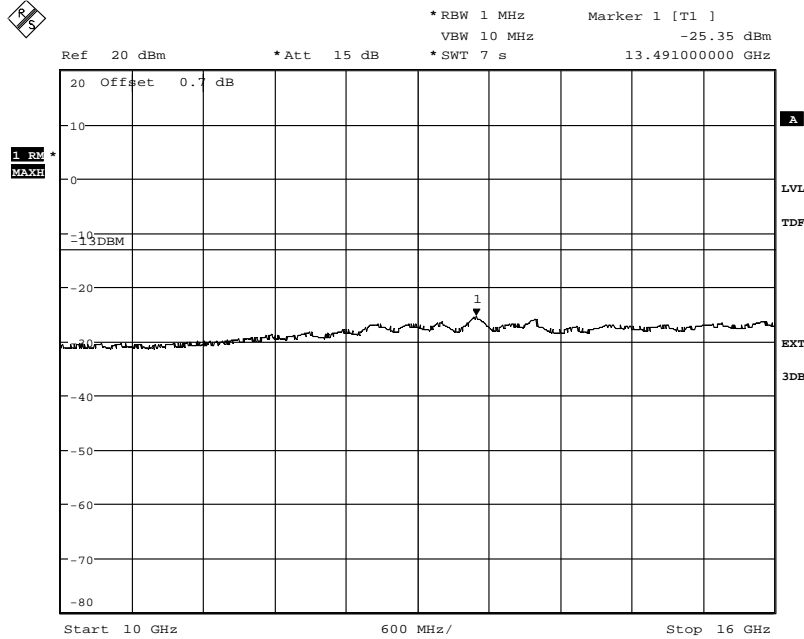

Date: 15.OCT.2013 16:16:23

Diagram 2 d:

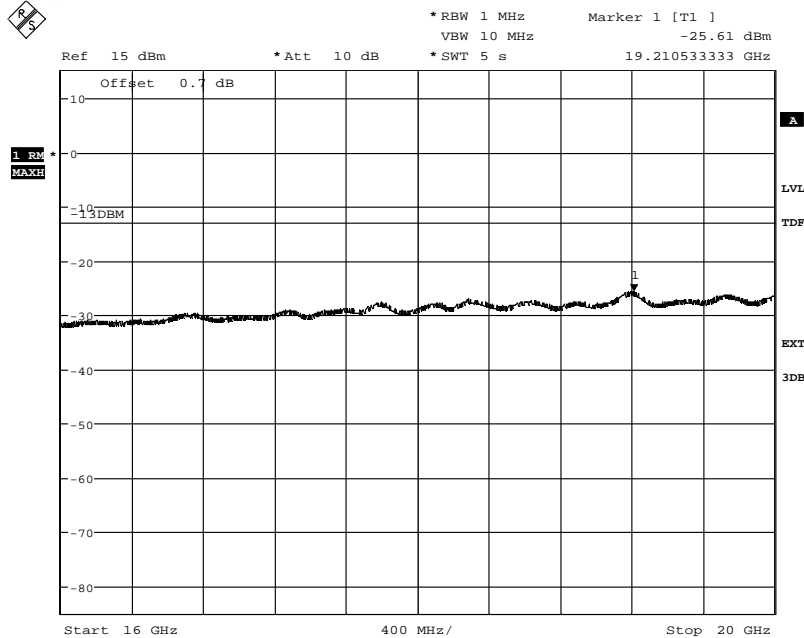

Date: 15.OCT.2013 16:18:25

Appendix 5

Diagram 3 c:

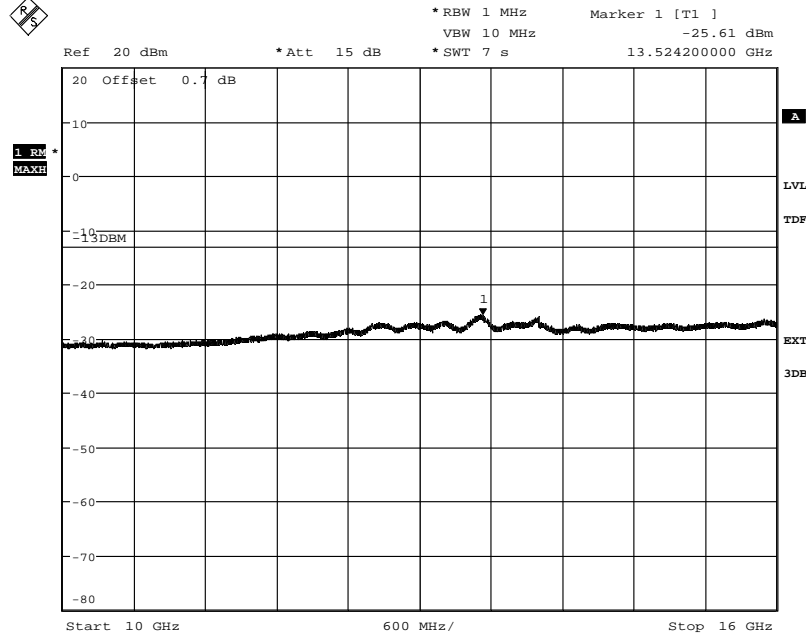

Date: 15.OCT.2013 16:28:14

Diagram 3 d:

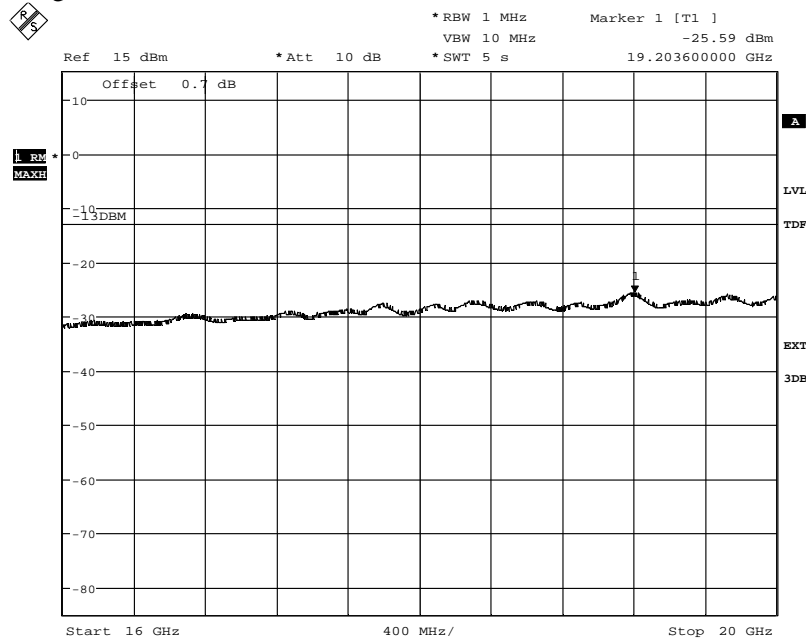

Date: 15.OCT.2013 16:32:40

Appendix 5

Diagram 4 a:

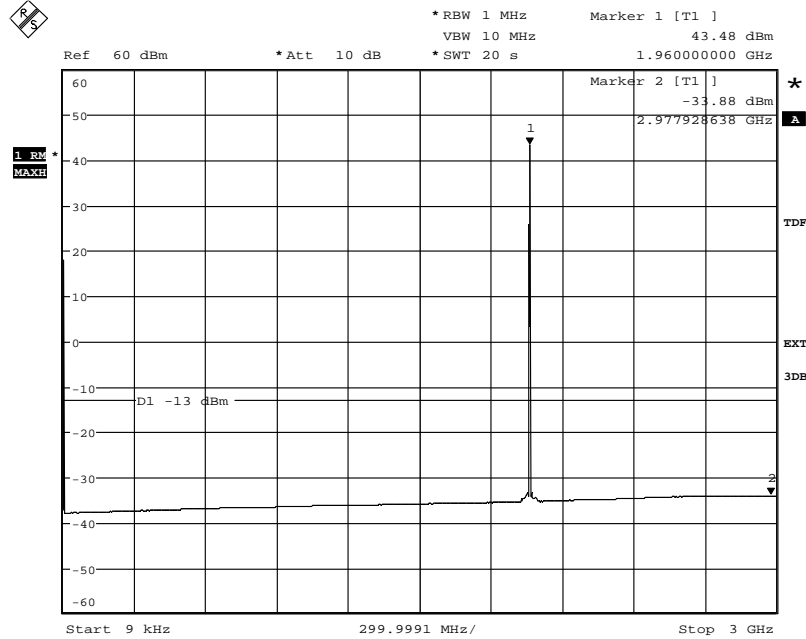

Date: 17.OCT.2013 13:17:07

Diagram 4 b:

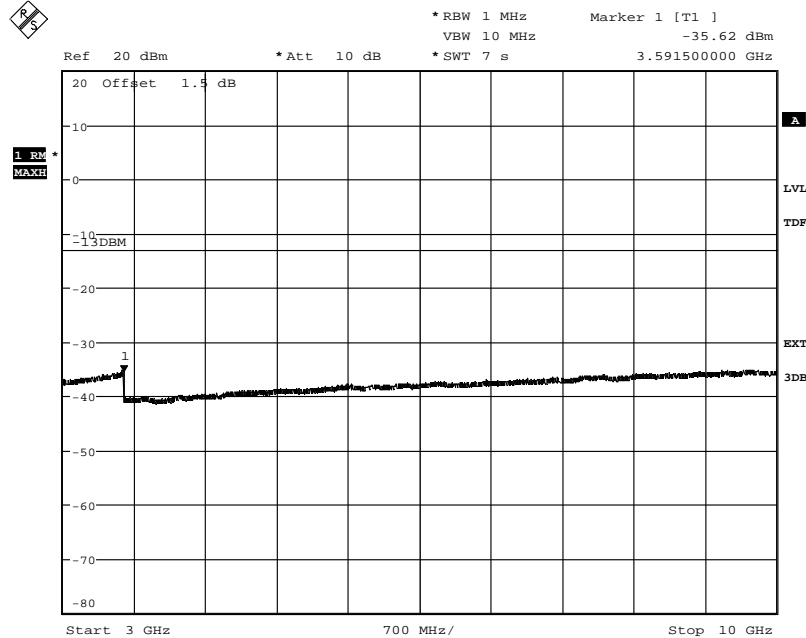

Date: 15.OCT.2013 15:40:04

Appendix 5

Diagram 4 c:

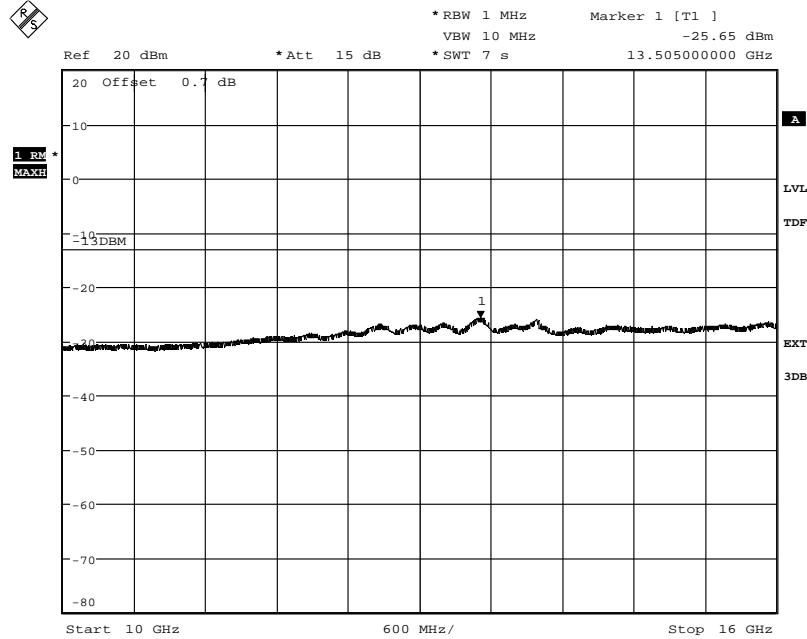

Date: 15.OCT.2013 15:39:01

Diagram 4 d:

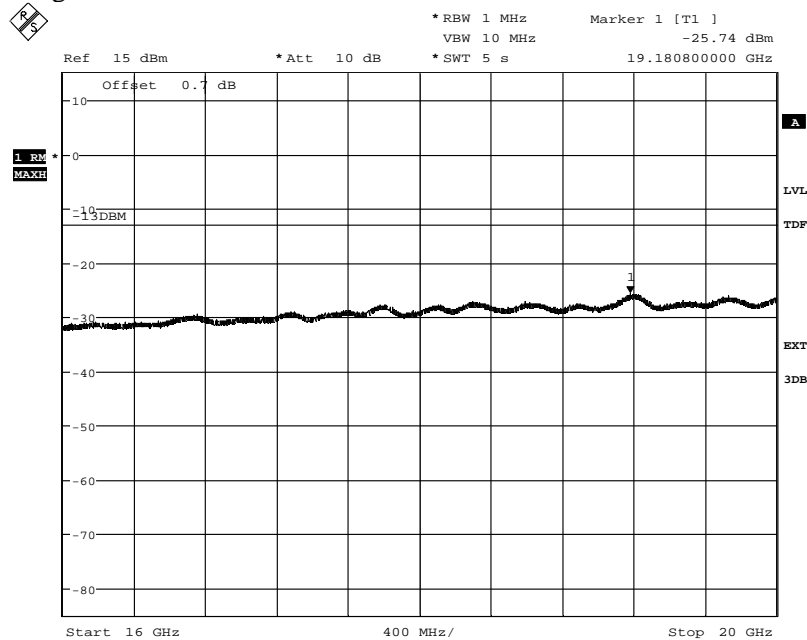

Date: 15.OCT.2013 15:41:18

Appendix 5

Diagram 5 a:

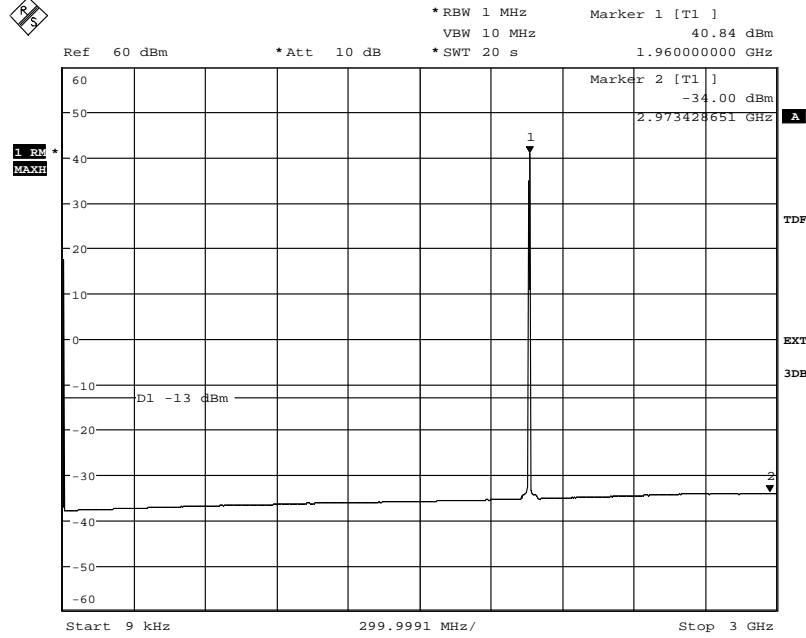

Date: 17.OCT.2013 12:28:41

Diagram 5 b:

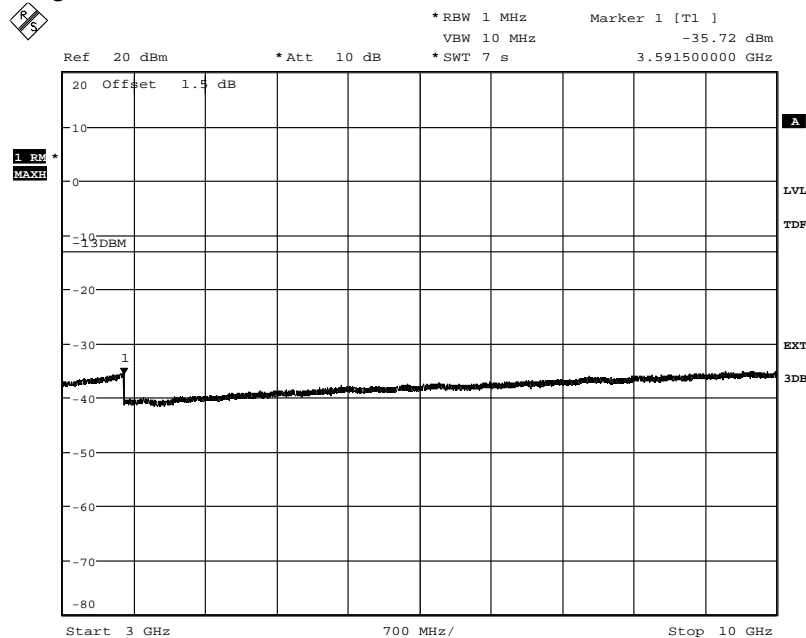

Date: 15.OCT.2013 16:37:29

Appendix 5

Diagram 5 c:

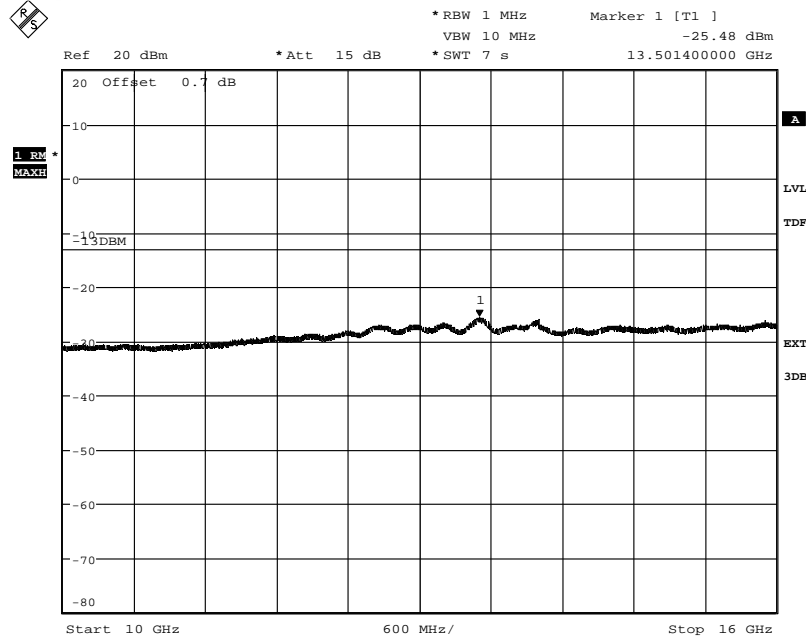

Date: 15.OCT.2013 16:36:46

Diagram 5 d:

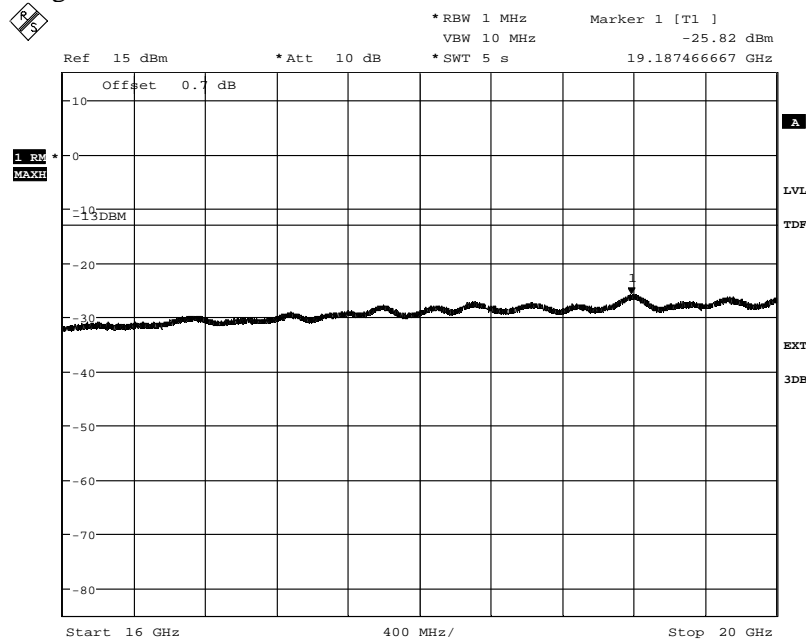

Date: 15.OCT.2013 16:35:49

Appendix 5

Diagram 6 a:

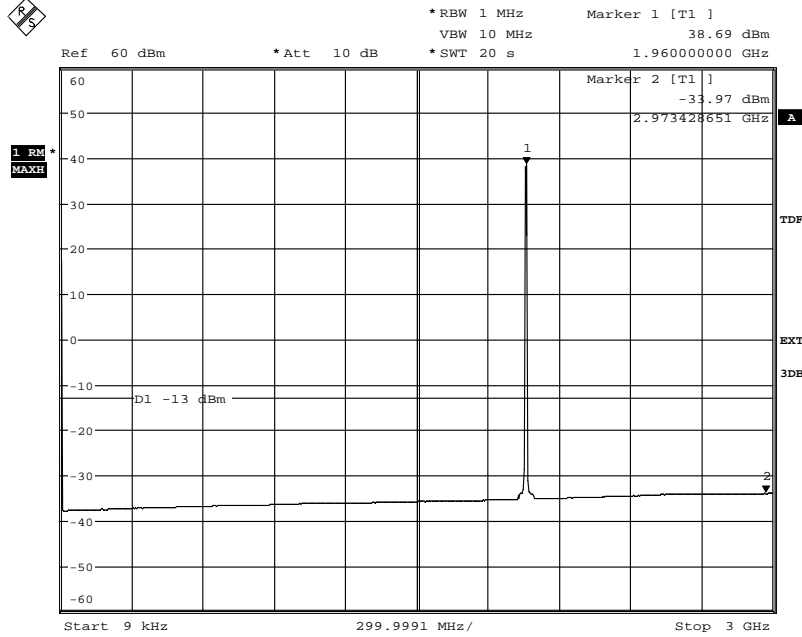

Date: 17.OCT.2013 12:26:09

Diagram 6 b:

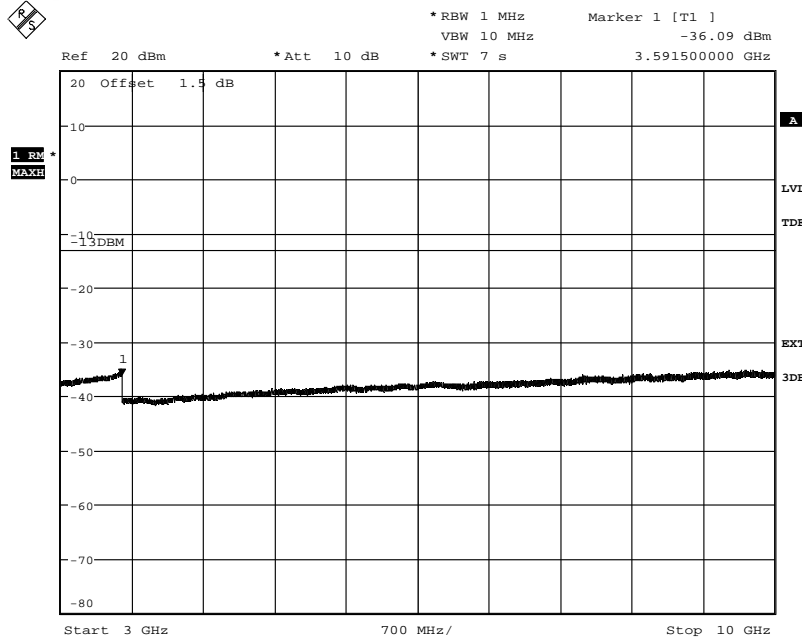

Date: 17.OCT.2013 12:32:43

Appendix 5

Diagram 6 c:

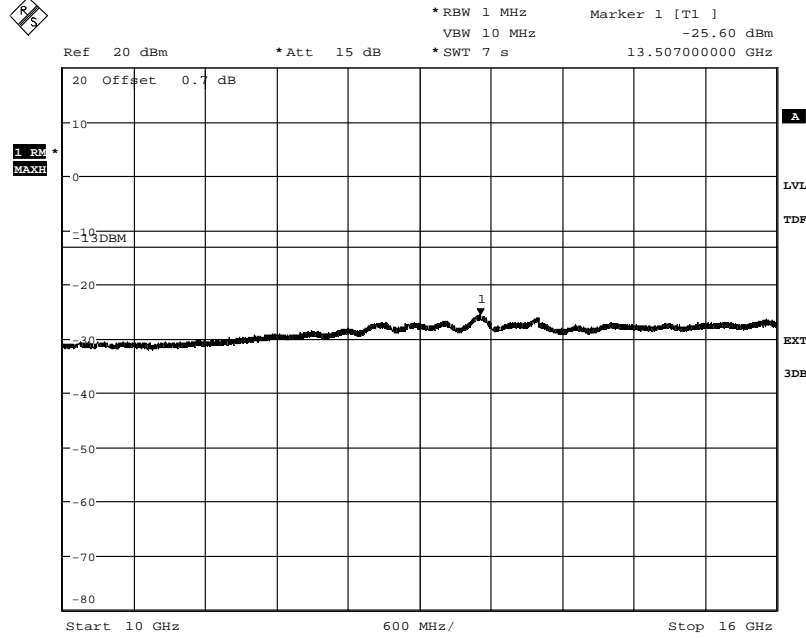

Date: 17.OCT.2013 12:34:01

Diagram 6 d:

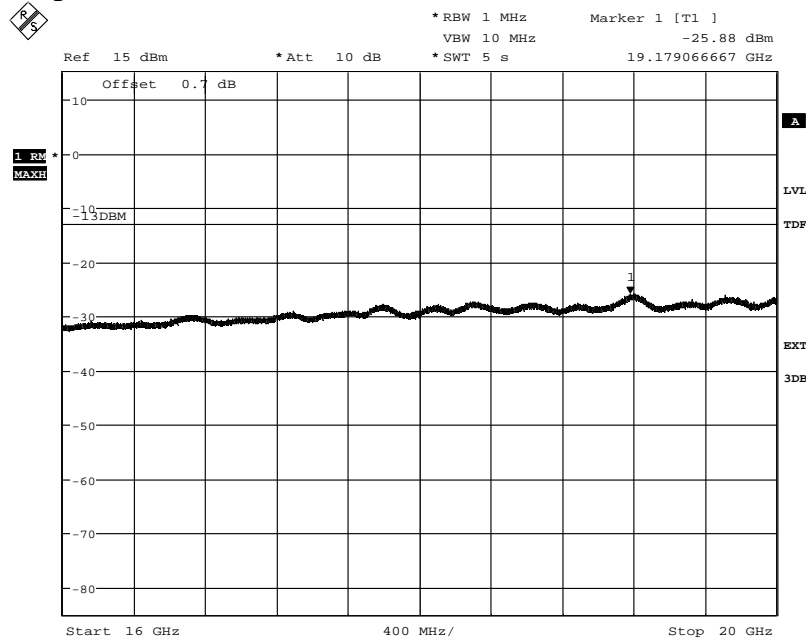

Date: 17.OCT.2013 12:34:55

Appendix 5

Diagram 7 a:

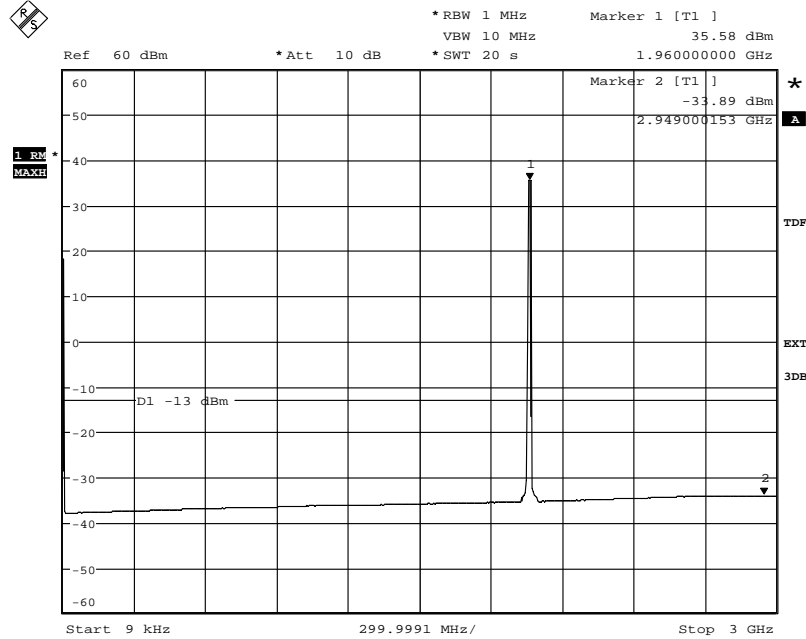

Date: 17.OCT.2013 12:50:04

Diagram 7 b:

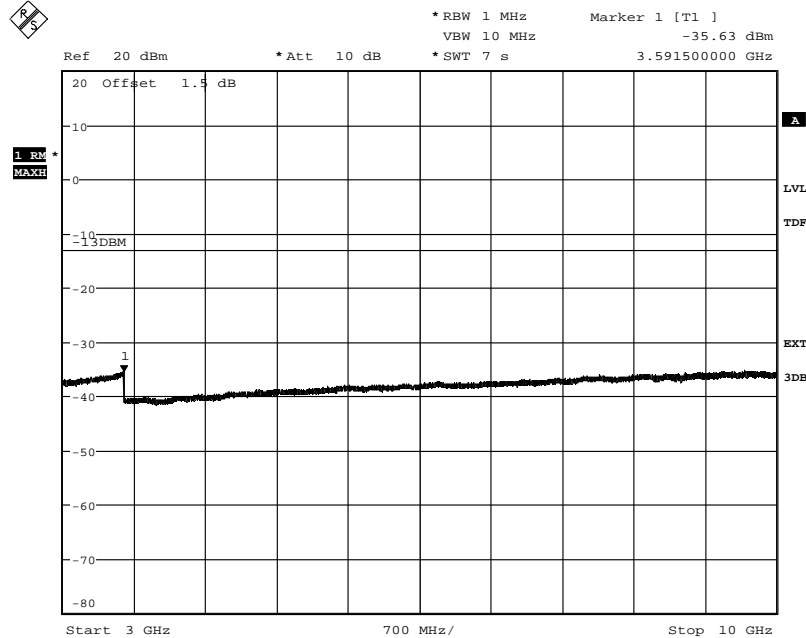

Date: 17.OCT.2013 12:47:28

Appendix 5

Diagram 7 c:

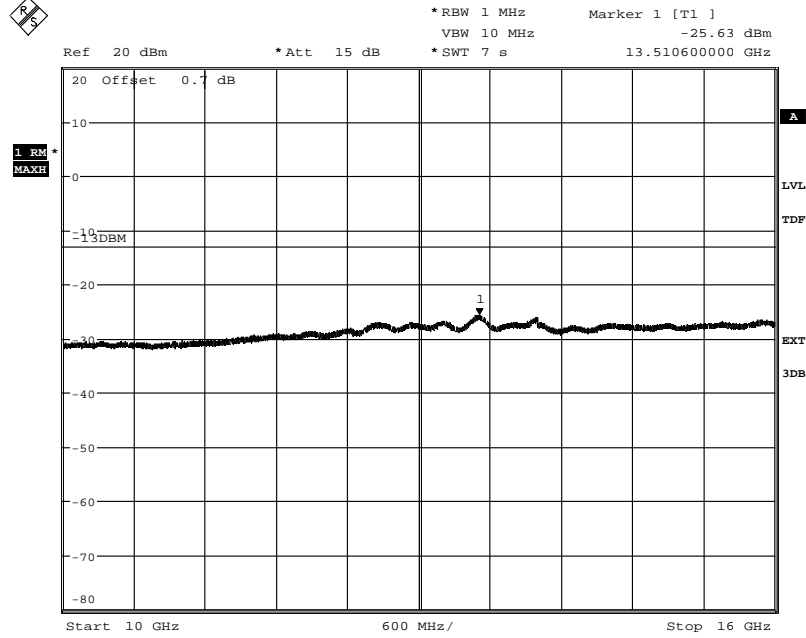

Date: 17.OCT.2013 12:46:25

Diagram 7 d:

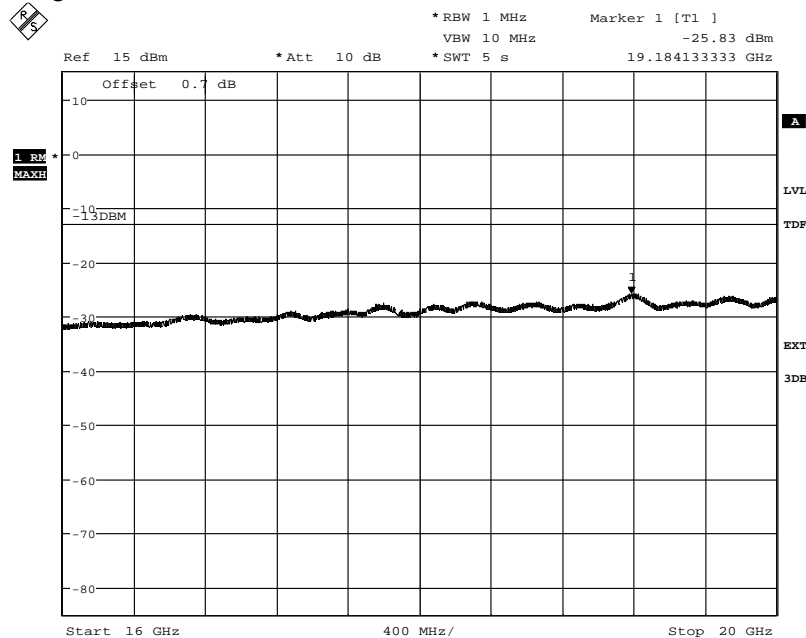

Date: 17.OCT.2013 12:44:22

Appendix 5

Diagram 8 a:

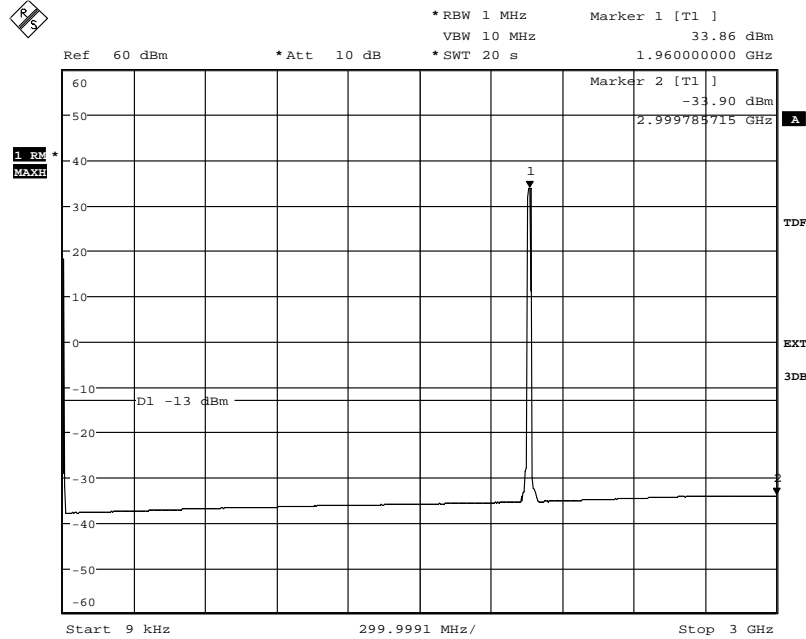

Date: 17.OCT.2013 12:51:46

Diagram 8 b:

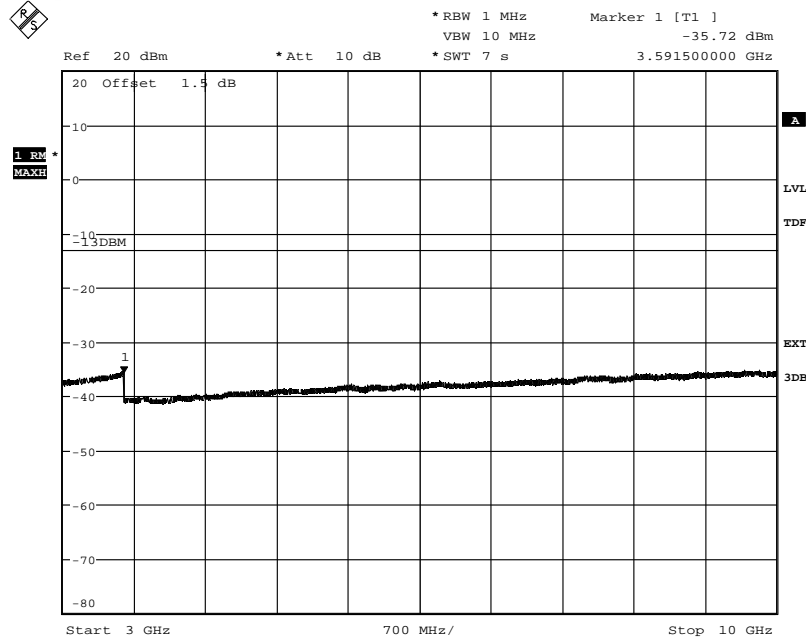

Date: 17.OCT.2013 12:53:12

Appendix 5

Diagram 8 c:

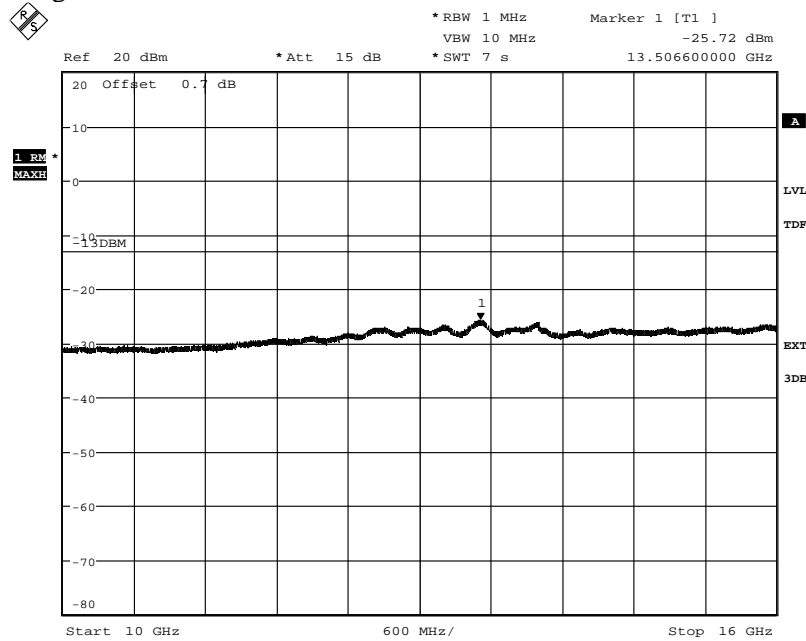

Date: 17.OCT.2013 12:57:31

Diagram 8 d:

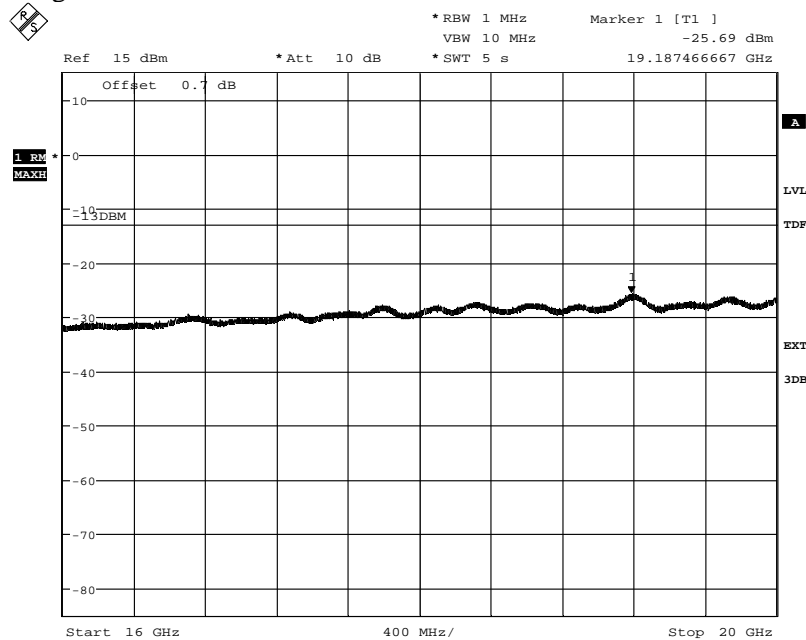

Date: 17.OCT.2013 12:58:49

Appendix 5

Diagram 9 a:

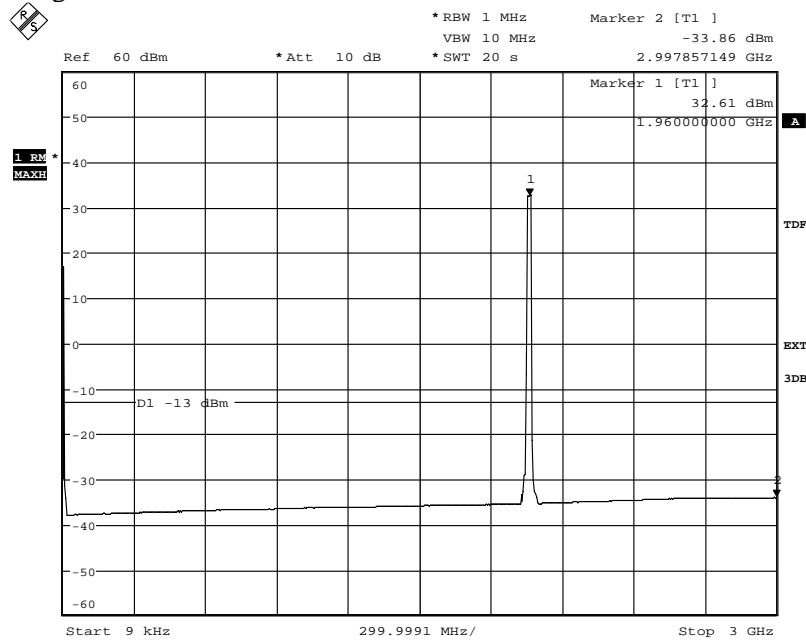

Date: 17.OCT.2013 13:03:29

Diagram 9 b:

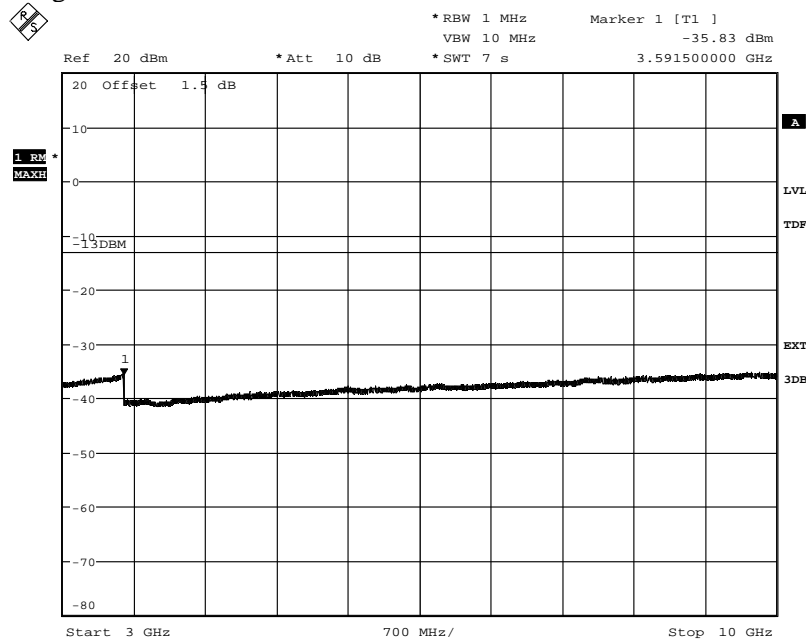

Date: 17.OCT.2013 13:02:03

Appendix 5

Diagram 9 c:

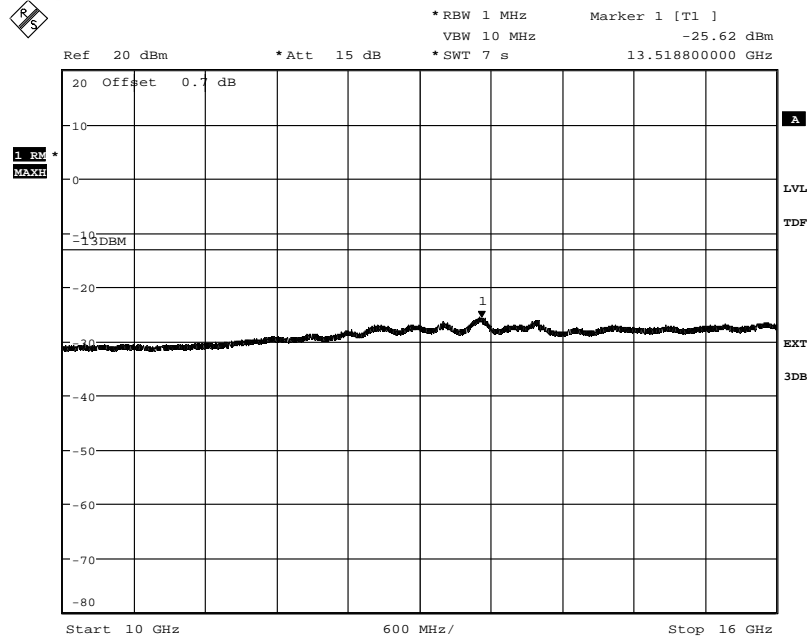

Date: 17.OCT.2013 13:01:08

Diagram 9 d:

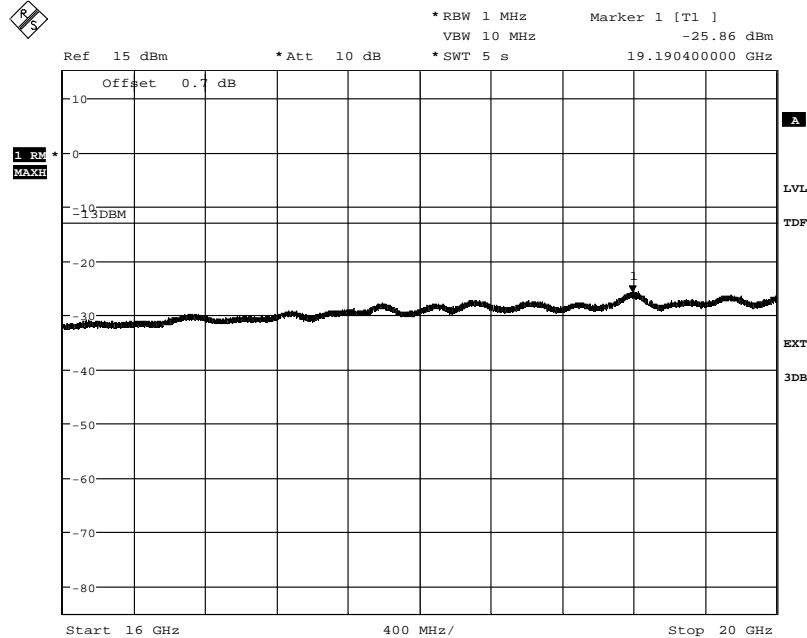

Date: 17.OCT.2013 13:00:14

Appendix 5

Diagram 10 a:

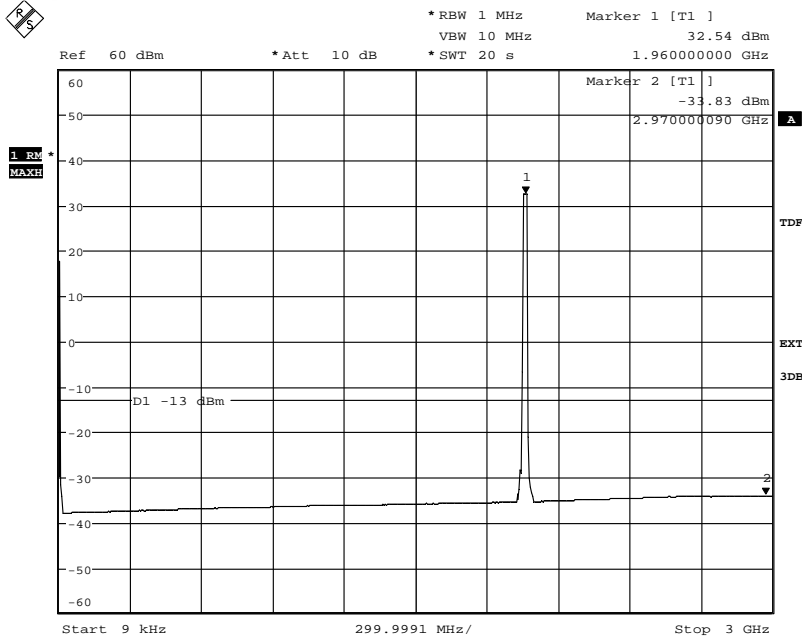

Date: 17.OCT.2013 13:18:49

Diagram 10 b:

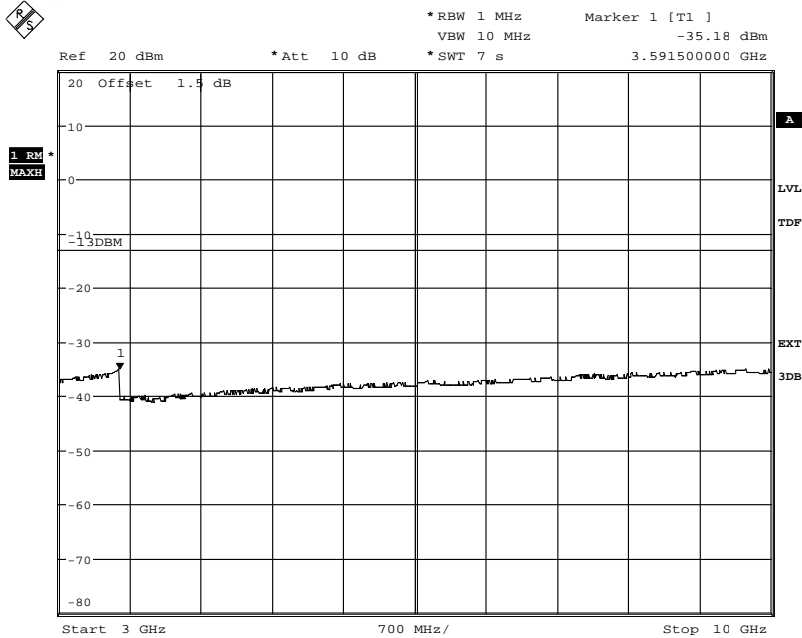

Date: 15.OCT.2013 15:53:59

Appendix 5

Diagram 10 c:

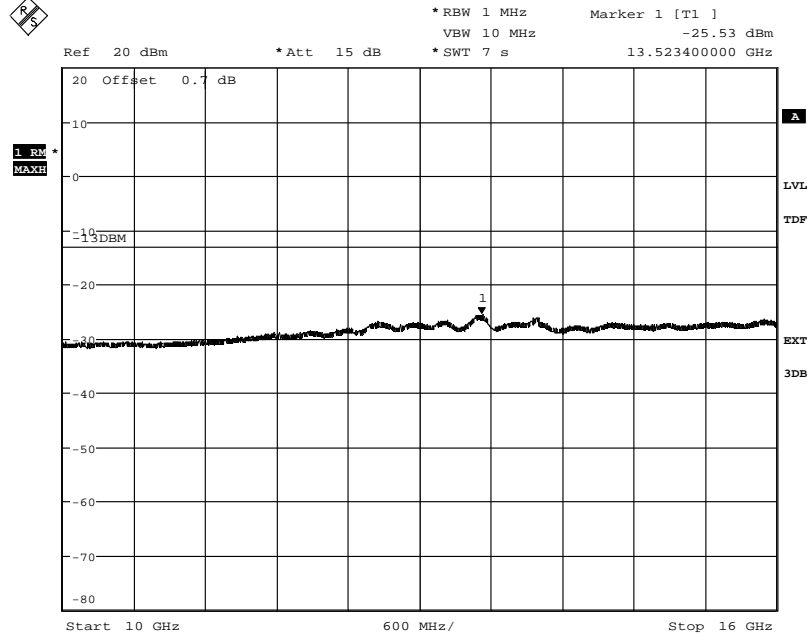

Date: 15.OCT.2013 15:55:22

Diagram 10 d:

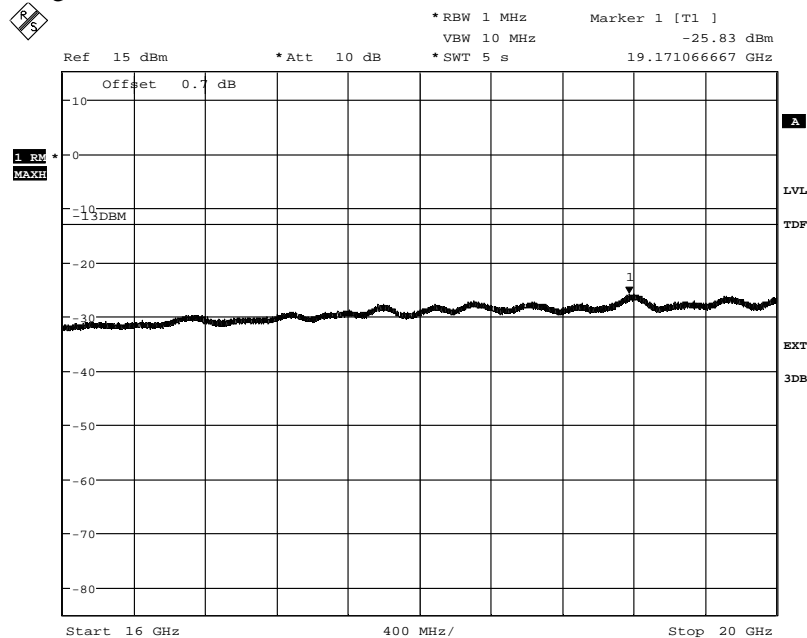

Date: 15.OCT.2013 15:56:17

Appendix 5

Diagram 11 a:

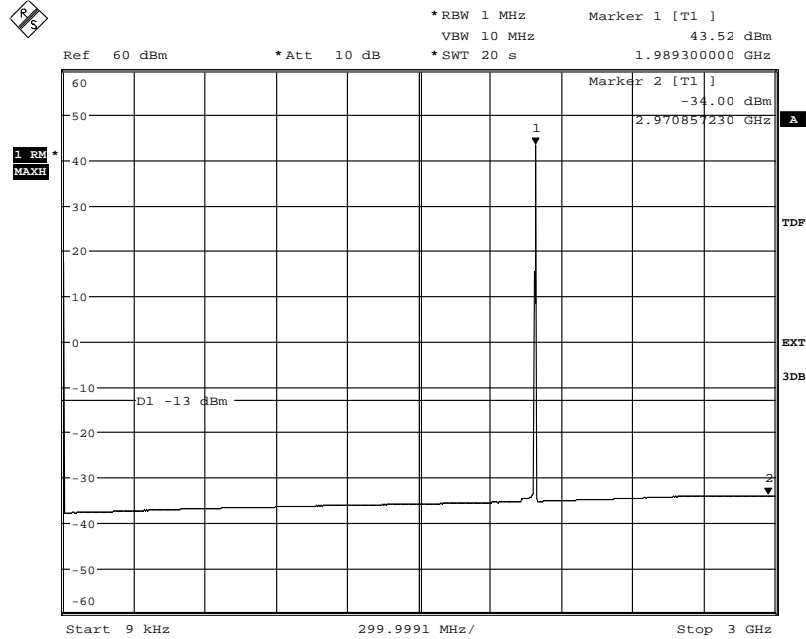

Date: 17.OCT.2013 13:07:18

Diagram 11 b:

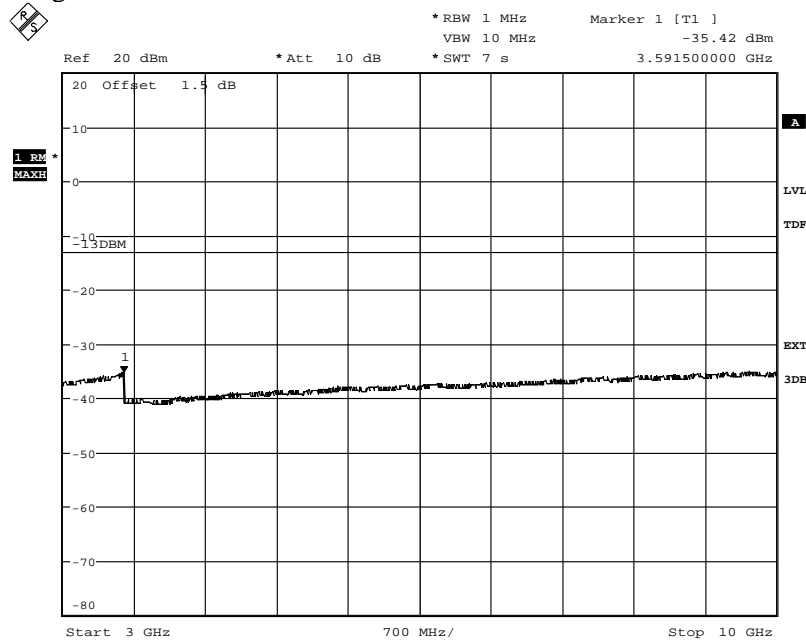

Date: 17.OCT.2013 13:10:29

Appendix 5

Diagram 11 c:

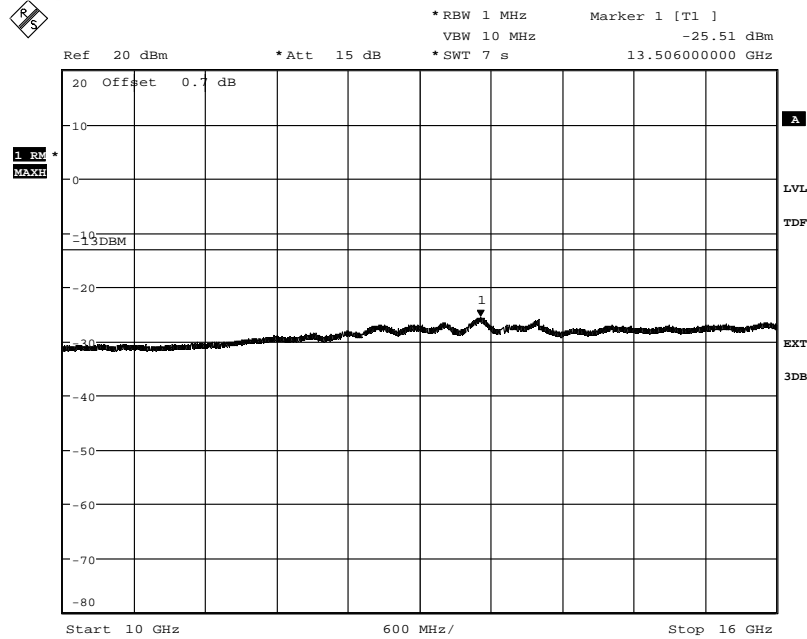

Date: 17.OCT.2013 13:11:35

Diagram 11 d:

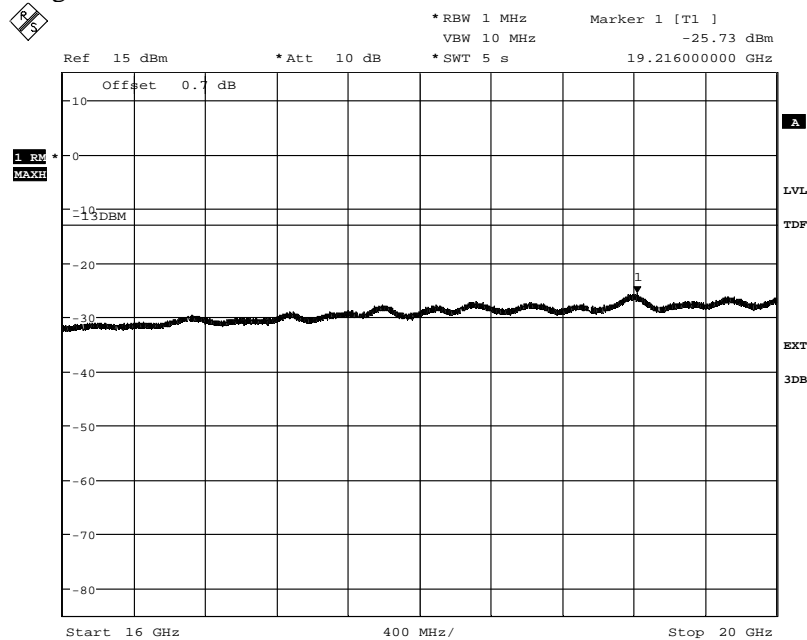

Date: 17.OCT.2013 13:12:50

Appendix 5

Diagram 12 a:

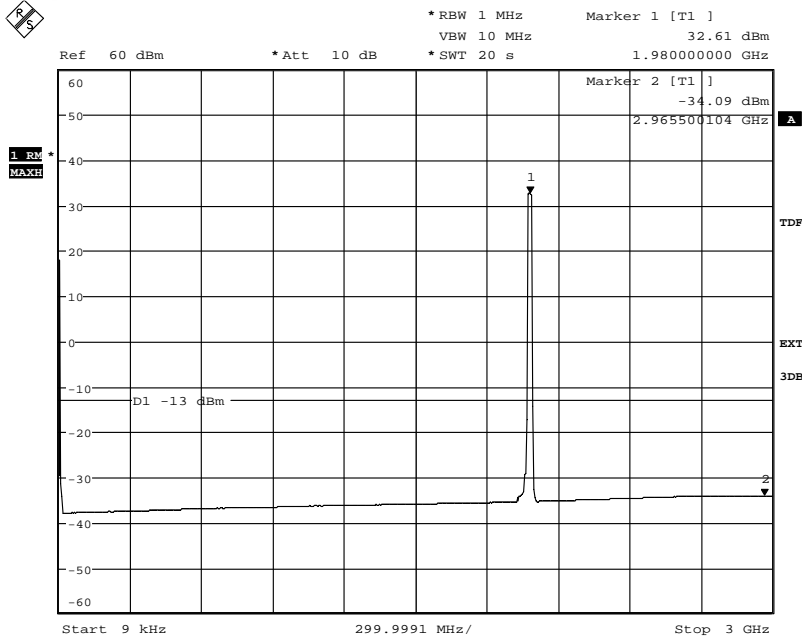

Date: 17.OCT.2013 13:05:38

Diagram 12 b:

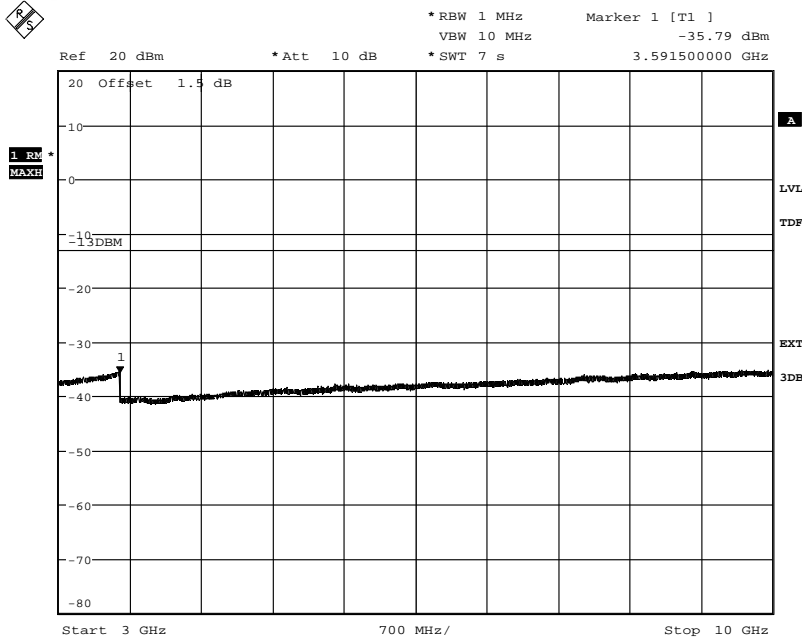

Date: 15.OCT.2013 16:22:25

Appendix 5

Diagram 12 c:

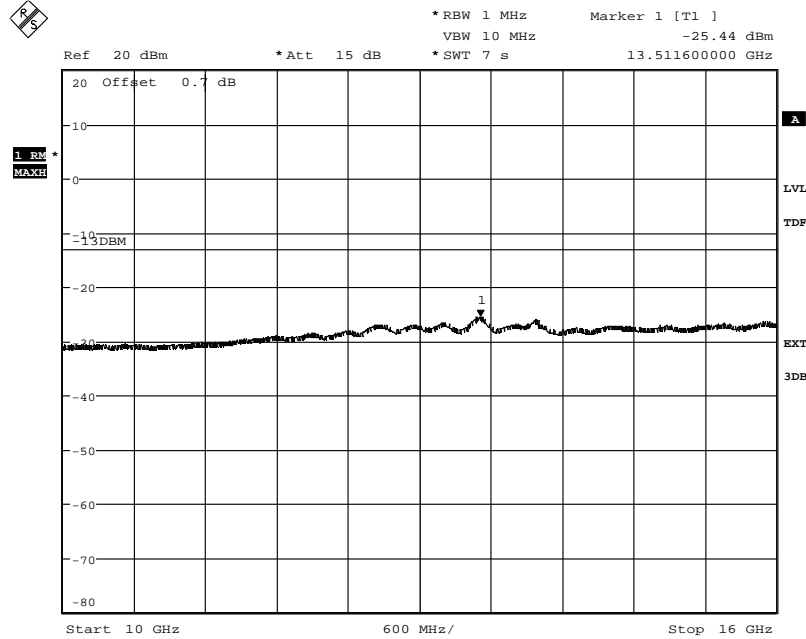

Date: 15.OCT.2013 16:21:19

Diagram 12 d:

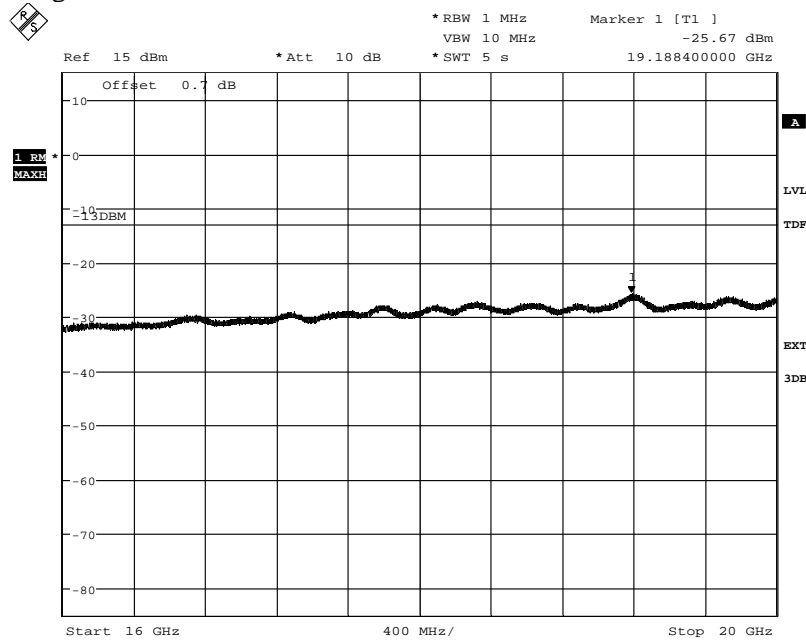

Date: 15.OCT.2013 16:20:02

Appendix 5

Diagram 13 a:

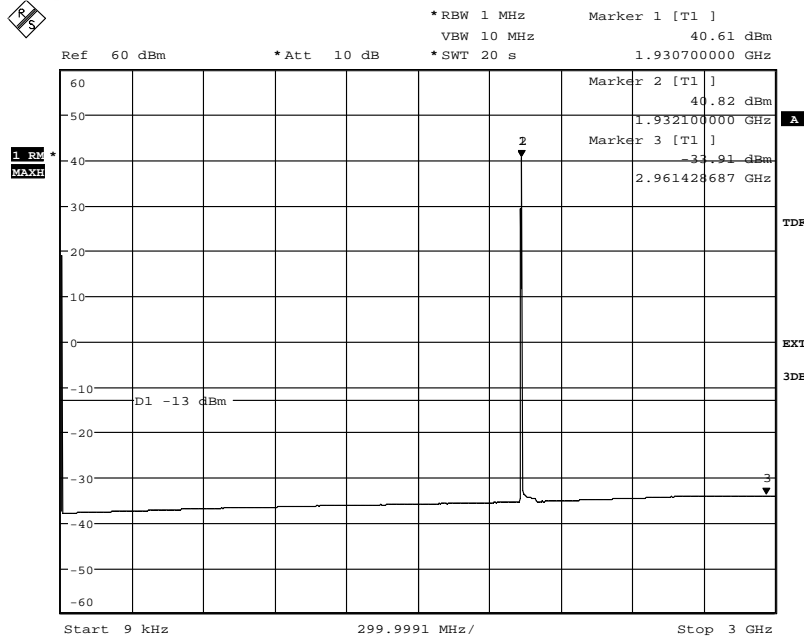

Date: 21.OCT.2013 08:54:00

Diagram 13 b:

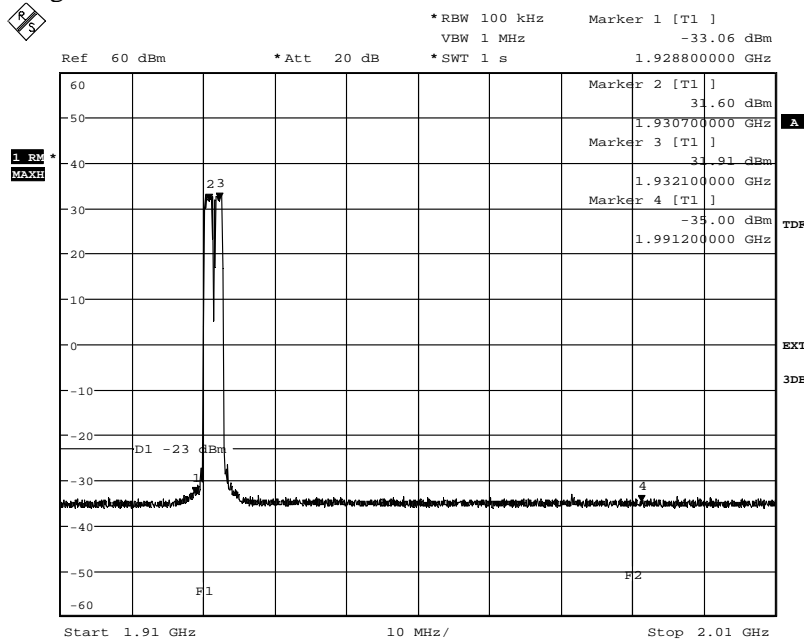

Date: 21.OCT.2013 08:55:36

Appendix 5

Diagram 13 c:

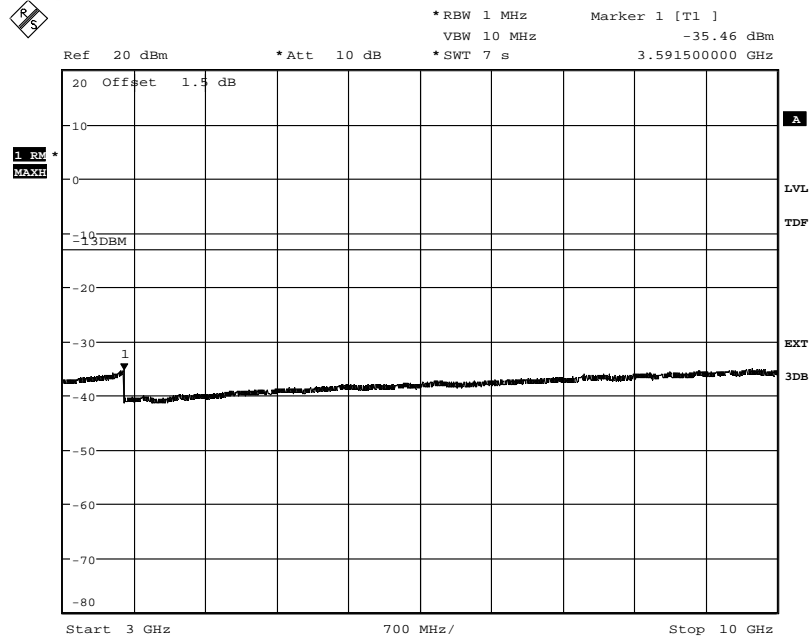

Date: 21.OCT.2013 08:51:43

Diagram 13 d:

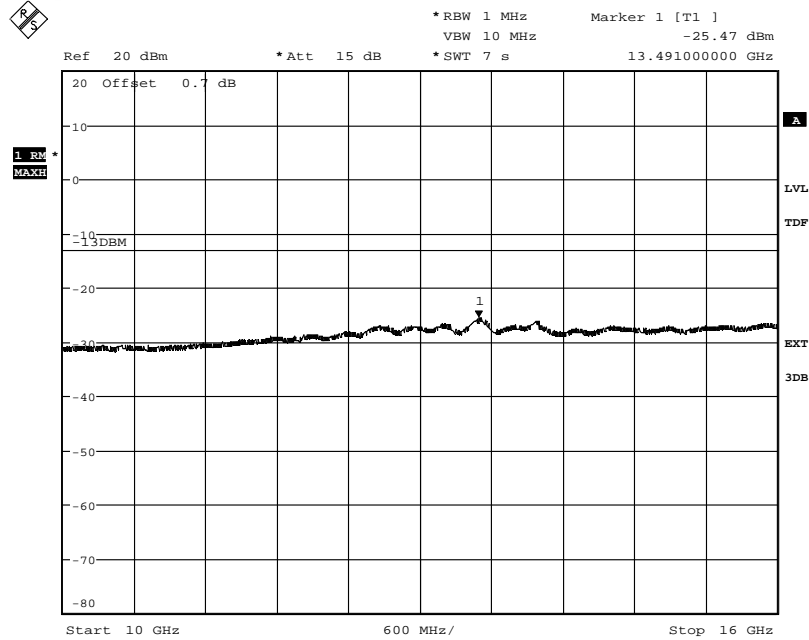

Date: 21.OCT.2013 08:49:16

Appendix 5

Diagram 13 e:

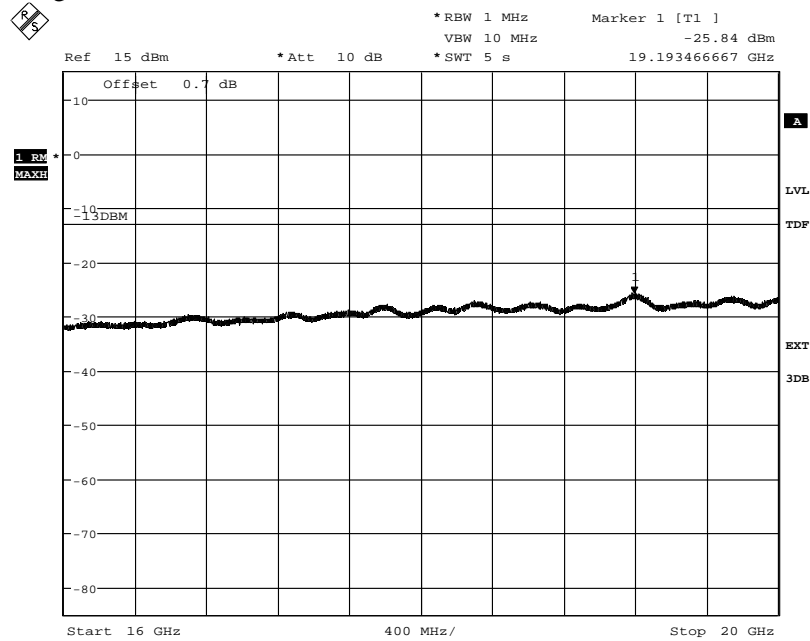

Date: 21.OCT.2013 08:50:40

Appendix 5

Diagram 14 a:

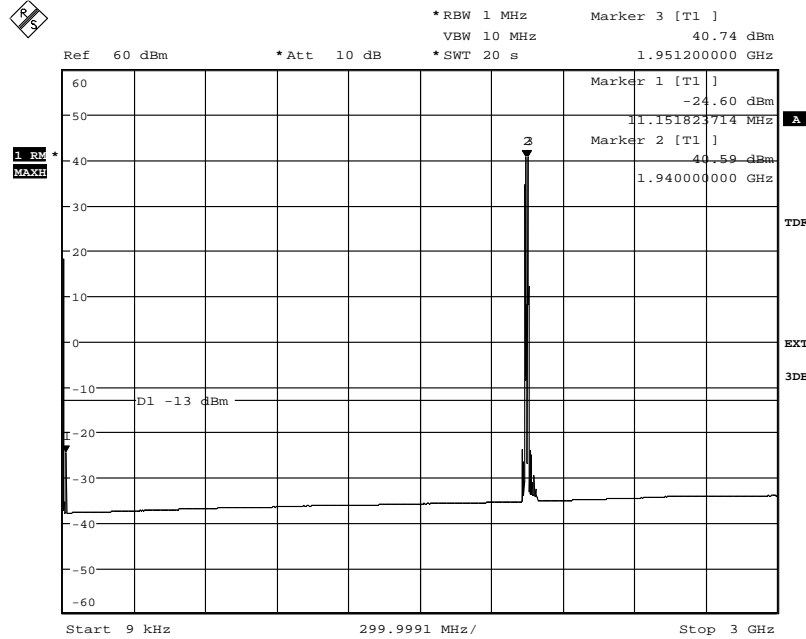

Date: 21.OCT.2013 09:10:19

Diagram 14 b:

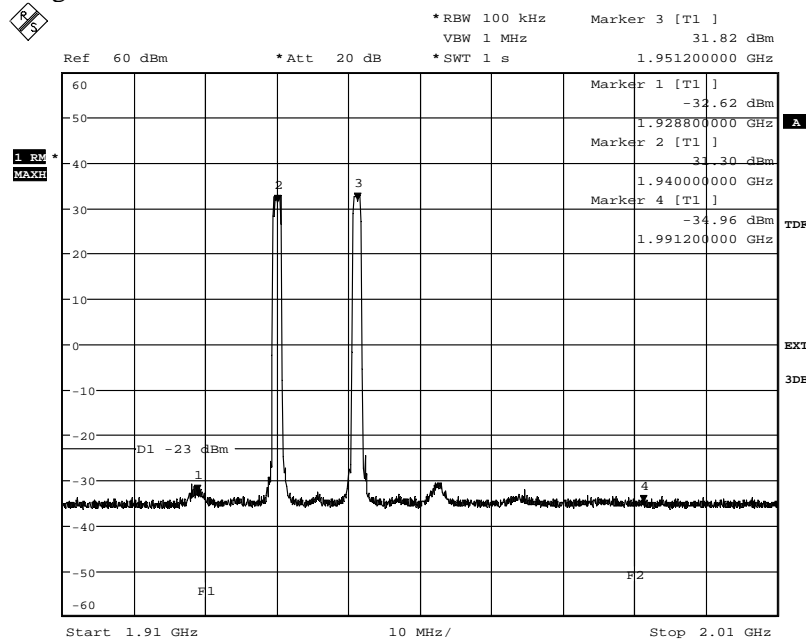

Date: 21.OCT.2013 08:59:33

Appendix 5

Diagram 14 c:

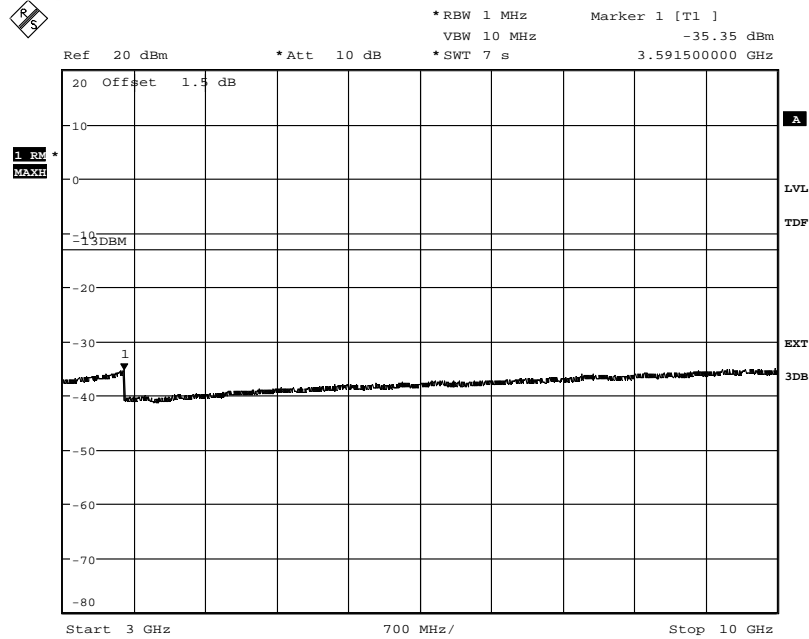

Date: 21.OCT.2013 09:03:49

Diagram 14 d:

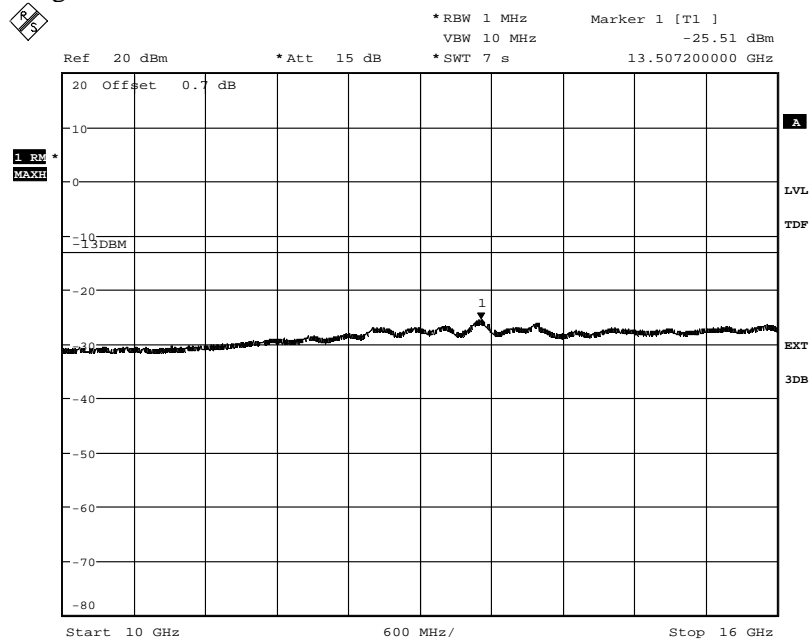

Date: 21.OCT.2013 09:04:56

Appendix 5

Diagram 14 e:

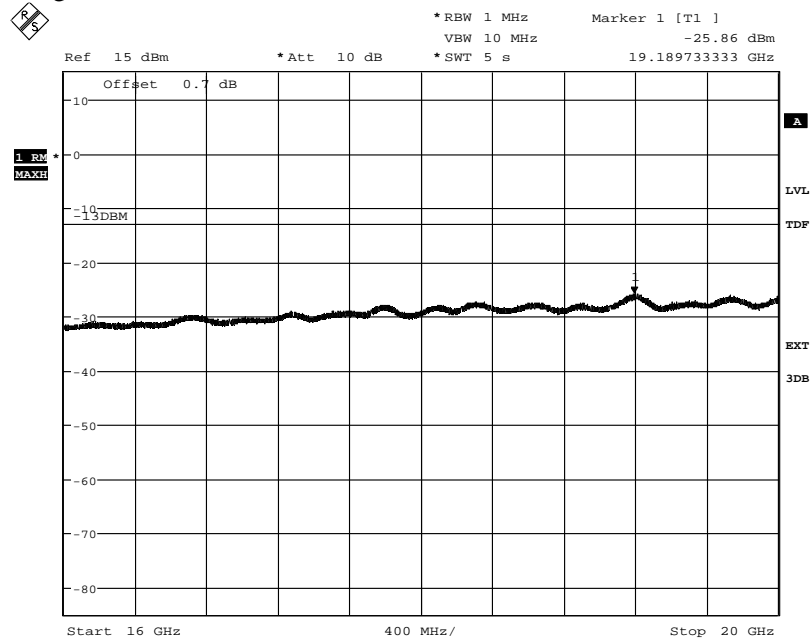

Date: 21.OCT.2013 09:06:22

Appendix 5

Diagram 15 a:

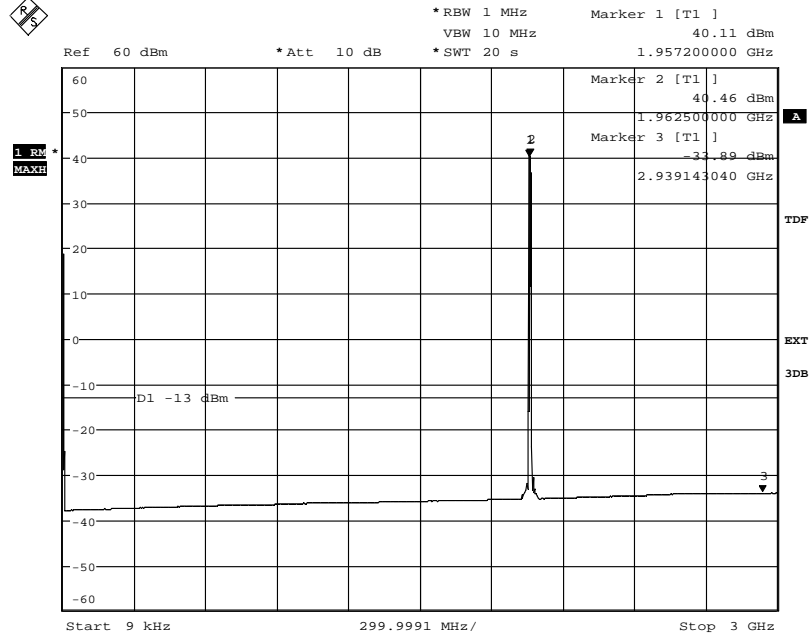

Date: 18.OCT.2013 16:05:05

Diagram 15 b:

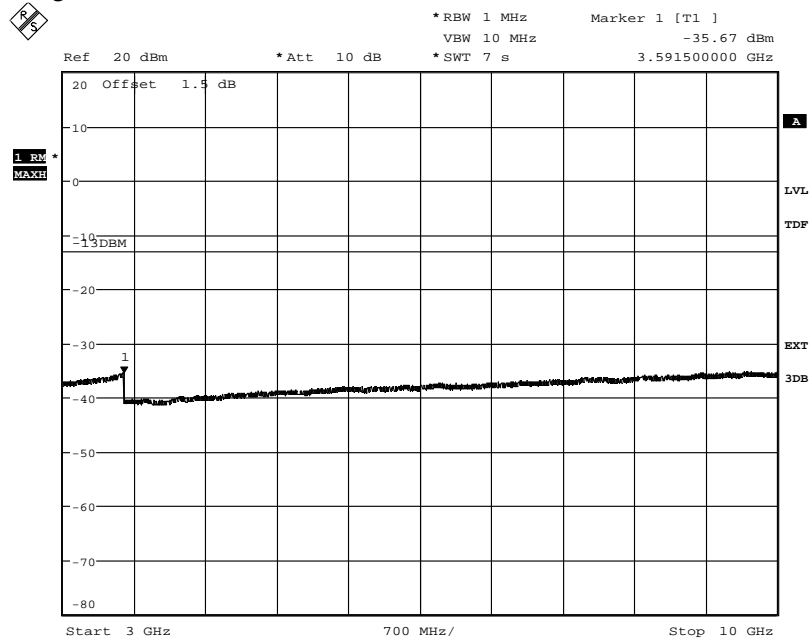

Date: 18.OCT.2013 16:06:37

Appendix 5

Diagram 15 c:

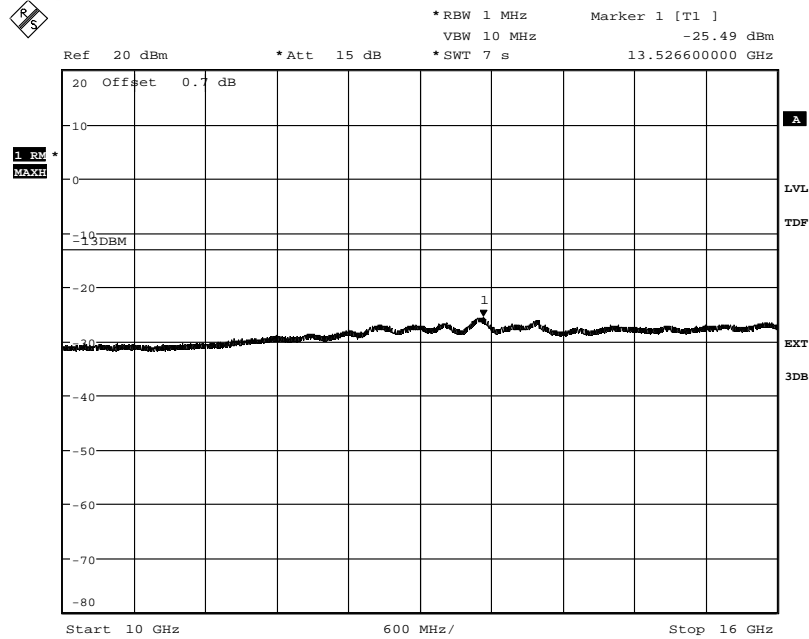

Date: 18.OCT.2013 16:09:18

Diagram 15 d:

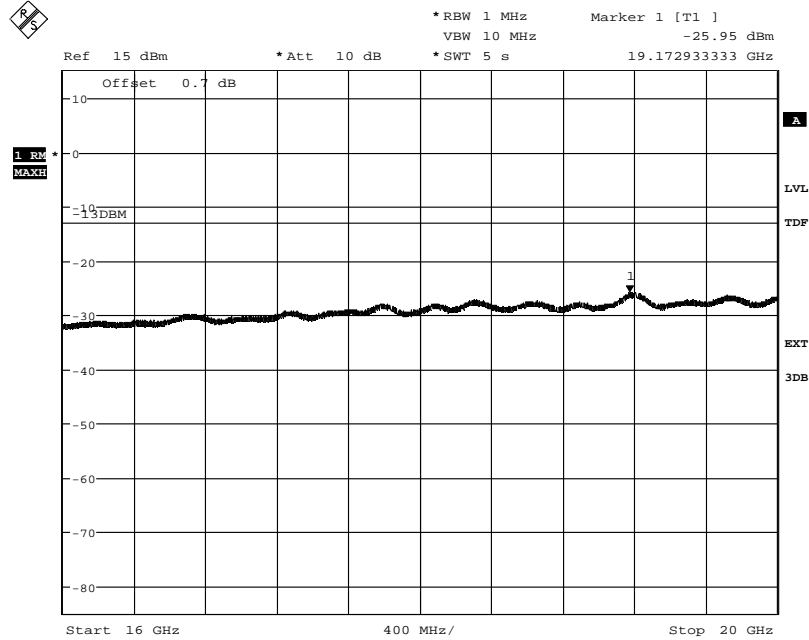

Date: 18.OCT.2013 16:08:34

Appendix 5

Diagram 16 a:

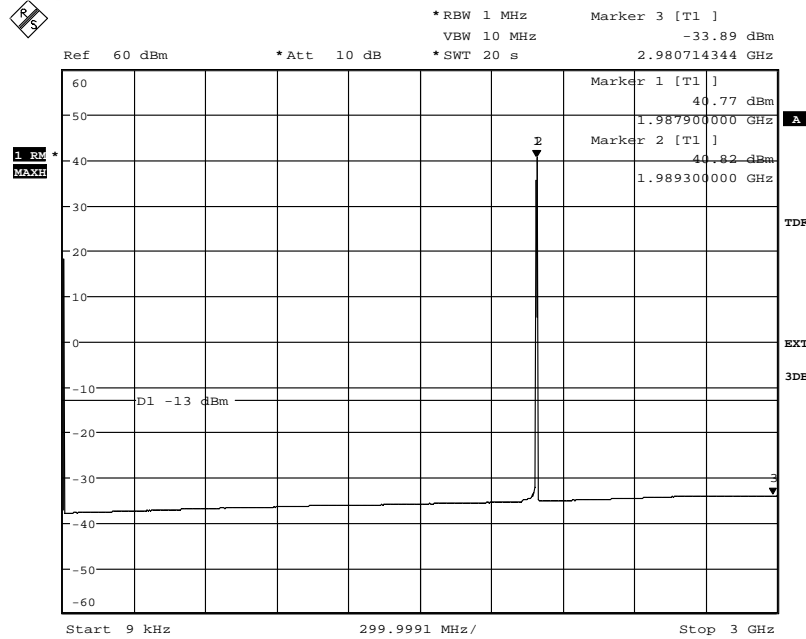

Date: 21.OCT.2013 09:29:52

Diagram 16 b:

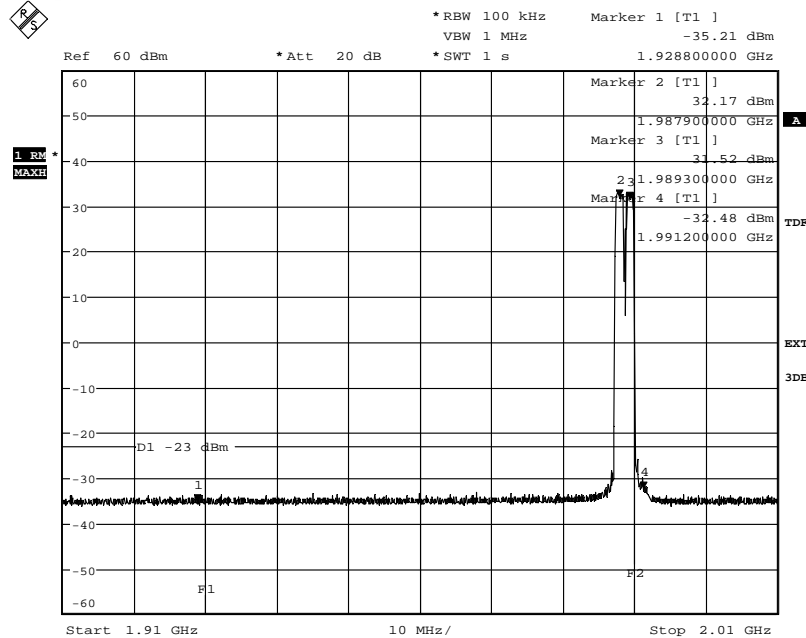

Date: 21.OCT.2013 09:31:38

Appendix 5

Diagram 16 c:

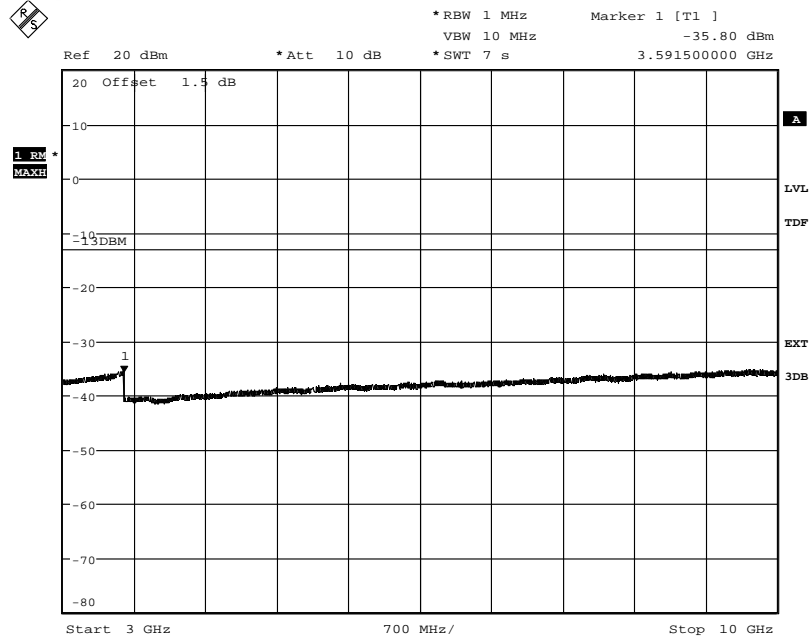

Date: 21.OCT.2013 09:26:56

Diagram 16 d:

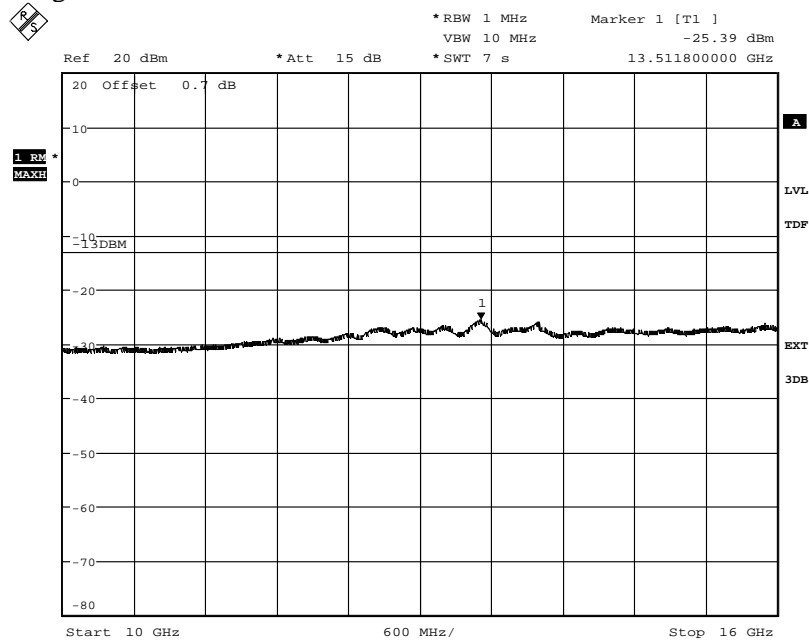

Date: 21.OCT.2013 09:25:56

Appendix 5

Diagram 16 e:

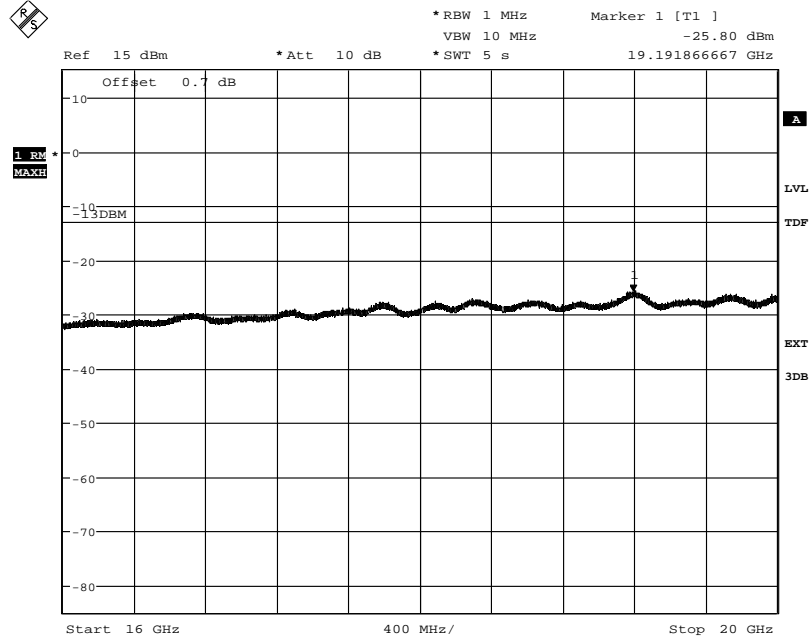

Date: 21.OCT.2013 09:24:45

Appendix 5

Diagram 17 a:

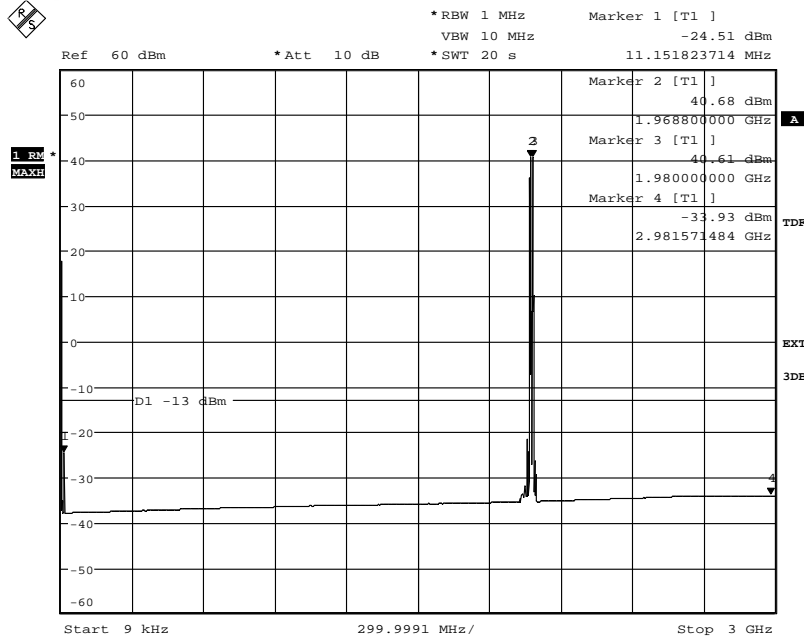

Date: 21.OCT.2013 09:15:36

Diagram 17 b:

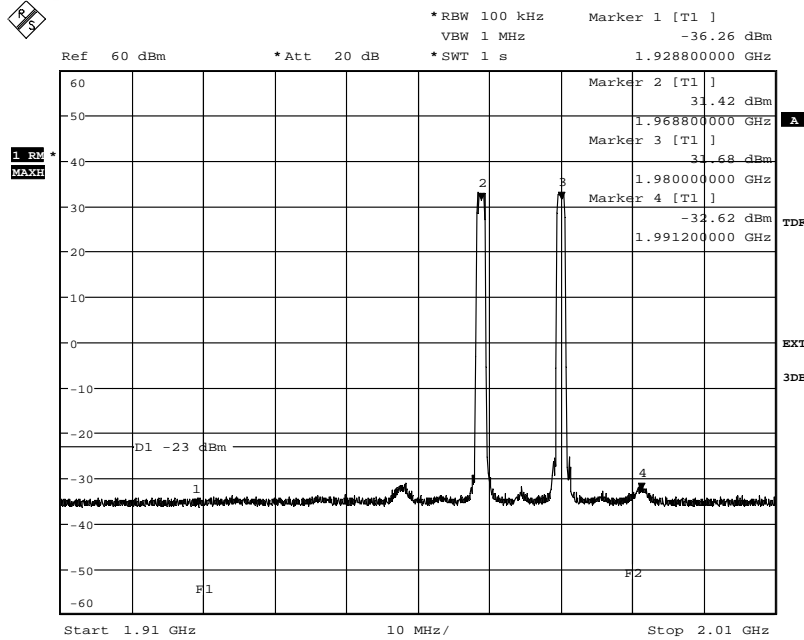

Date: 21.OCT.2013 09:16:35

Appendix 5

Diagram 17 c:

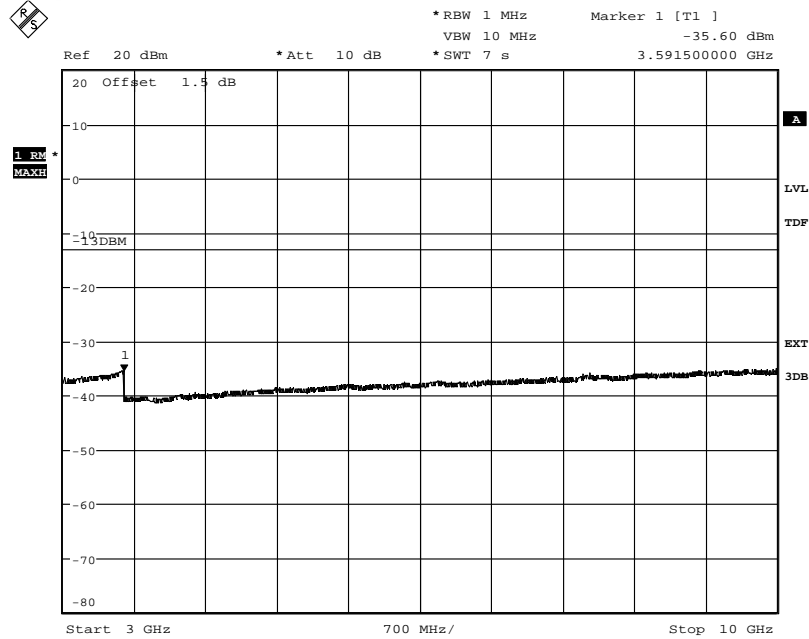

Date: 21.OCT.2013 09:19:34

Diagram 17 d:

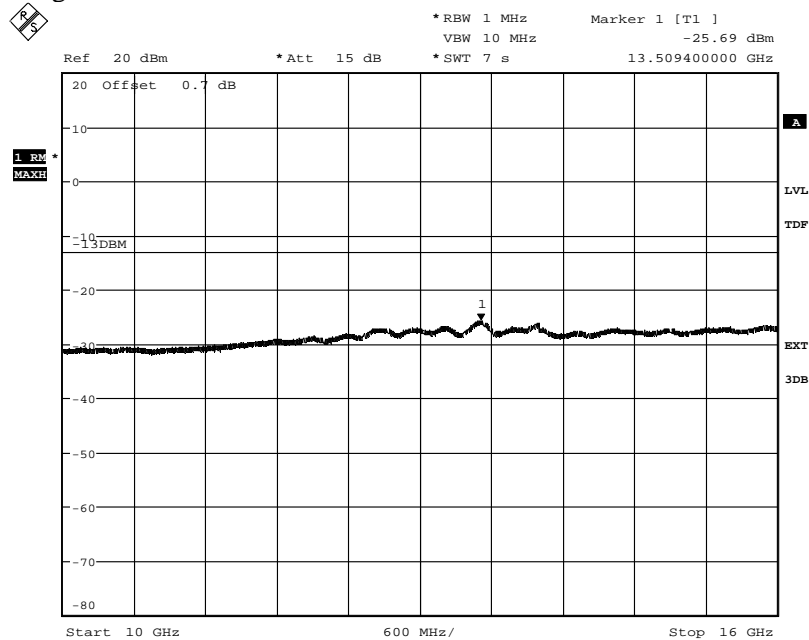

Date: 21.OCT.2013 09:21:00

Appendix 5

Diagram 17 e:

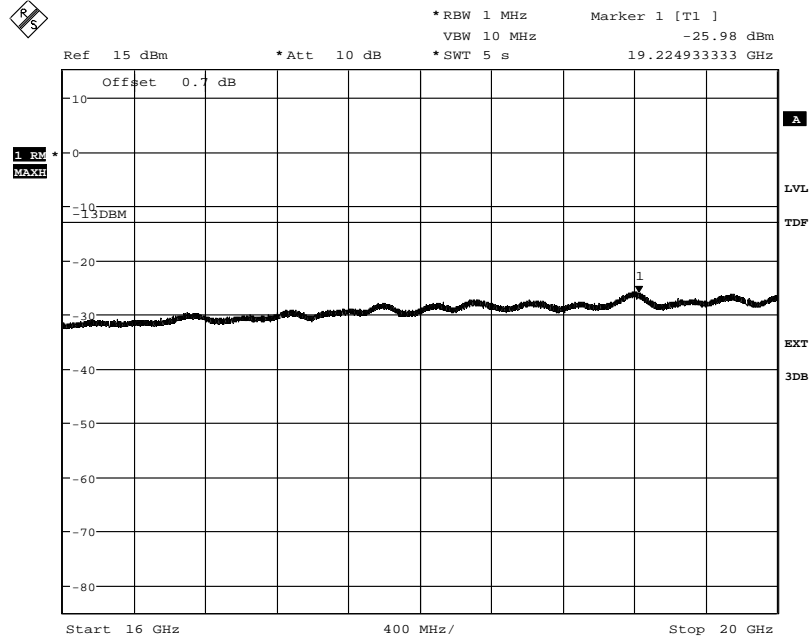

Date: 21.OCT.2013 09:21:41

Appendix 6

Field strength of spurious radiation measurements according to CFR 47 §24.238 / IC RSS-133 6.5

Date	Temperature	Humidity
2013-10-23	24 °C ± 3°C	45 % ± 5 %

Test set-up and procedure

The test sites are listed at FCC, Columbia with registration number: 93866. The test site complies with RSS-Gen, Industry Canada file no. 3482A-1.

The measurements were performed with both horizontal and vertical polarization of the antenna. The antenna distance was 3 m in the frequency range 30 MHz – 18 GHz and 1 m in the frequency range 18 - 20 GHz.

In the frequency range 30 MHz - 20 GHz the measurement was performed in power with a RBW of 1 MHz. A propagation loss in free space was calculated. The used formula was

$$\gamma = 20 \log \left(\frac{4\pi D}{\lambda} \right), \gamma \text{ is the propagation loss and } D \text{ is the antenna distance.}$$

The measurement procedure was as the following:

1. The pre-measurement was first performed with peak detector. The EUT was measured in eight directions and with the antenna at three heights, 1.0 m, 1.5 m and 2.0 m.
2. Spurious radiation on frequencies closer than 20 dB to the limit in the pre-measurement is scanned 0-360 degrees and the antenna is scanned 1- 4 m for maximum response. The emission is then measured with the RMS detector and the RMS value is reported. Frequencies closer than 10 dB to the limit when measured with the RMS detector is measured with the substitution method according to the standard.

Appendix 6

The test set-up during the spurious radiation measurements is shown in the picture below:



Measurement equipment

Measurement equipment	SP number
Semi anechoic chamber	503 881
R&S ESU 26	901 553
EMC 32 ver. 8.52.0	503 899
Chase Bilog Antenna CBL 6111A	502 182
EMCO Horn Antenna 3115	502 175
Flann STD Gain Horn Antenna 20240-20	503 674
High pass filter, RLC Electronics	503 739
Miteq, Low Noise Amplifier	503 285
Schwarzbeck preamplifier BBV 9742	504 085
µComp Nordic, Low Noise Amplifier	901 545
Temperature and humidity meter, Testo 625	504 188

Appendix 6

Tested configurations

Symbolic name
B
M
M2
T

Results, representing worst case

Diagram	BW [MHz]	Symbolic name
1 a-d	5 MHz	M

	Spurious emission level (dBm)	
Frequency (MHz)	Vertical	Horizontal
30-20 000	All emission > 20 dB below limit	All emission > 20 dB below limit

Measurement uncertainty:

3.2 dB up to 18 GHz, 3.6 dB above 18 GHz

Limits

CFR 47 §24.238 and RSS-133 6.5

Outside a licensee's frequency band(s) of operation the power of any emission shall be attenuated below the transmitter power (P) by at least $43 + 10 \log (P)$ dB, resulting in a limit of -13 dBm per 1 MHz RBW.

Complies?	Yes
-----------	-----

Appendix 6

Diagram 1a:

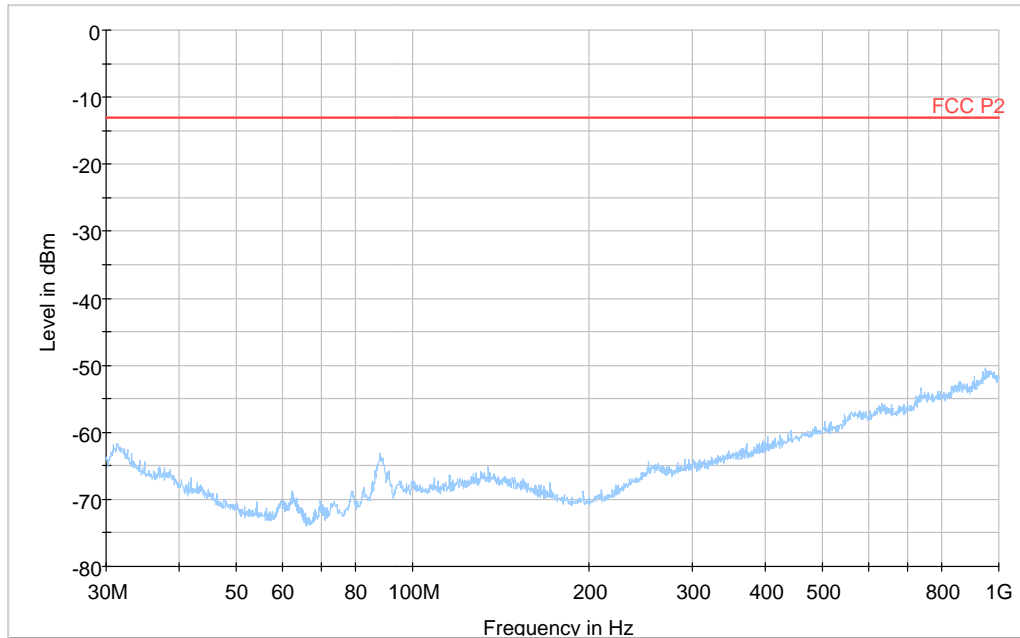
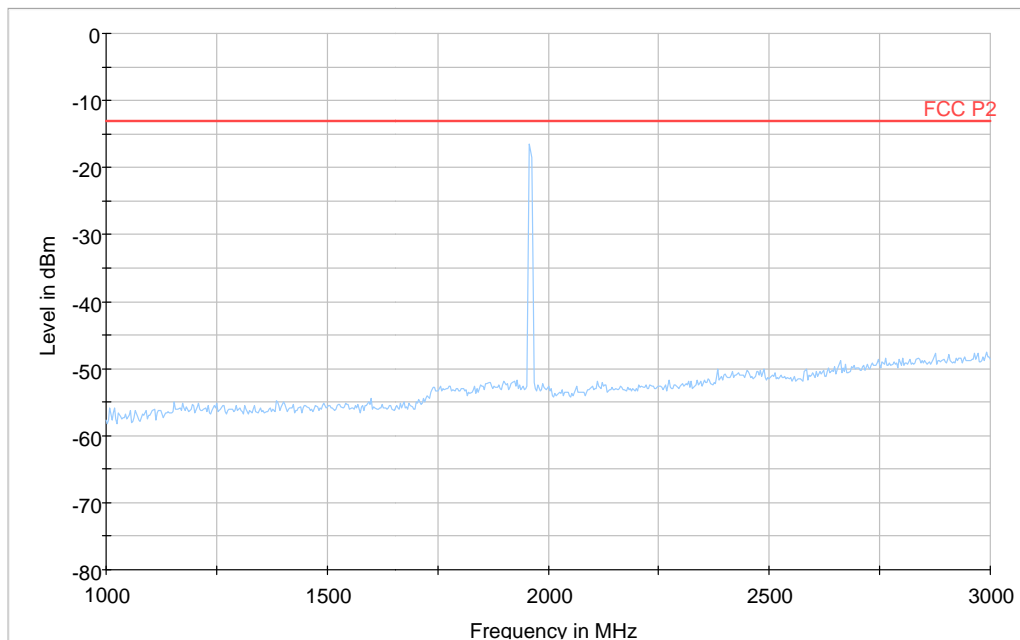

Diagram 1b:



Note: The emission at 1960 MHz is the carrier frequencies and shall be ignored in the context.

Appendix 6

Diagram 1c:

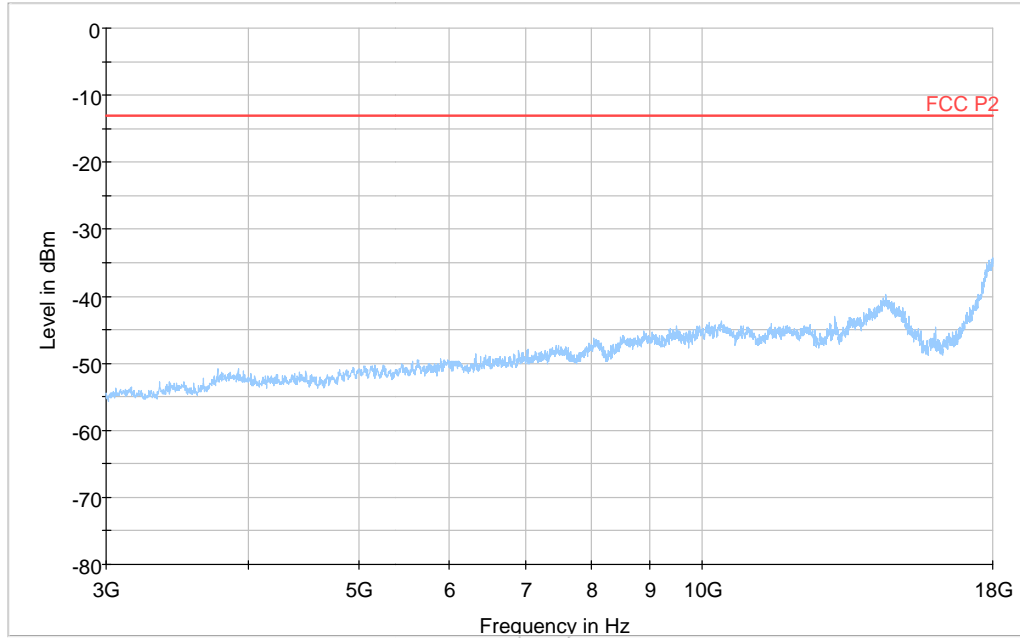
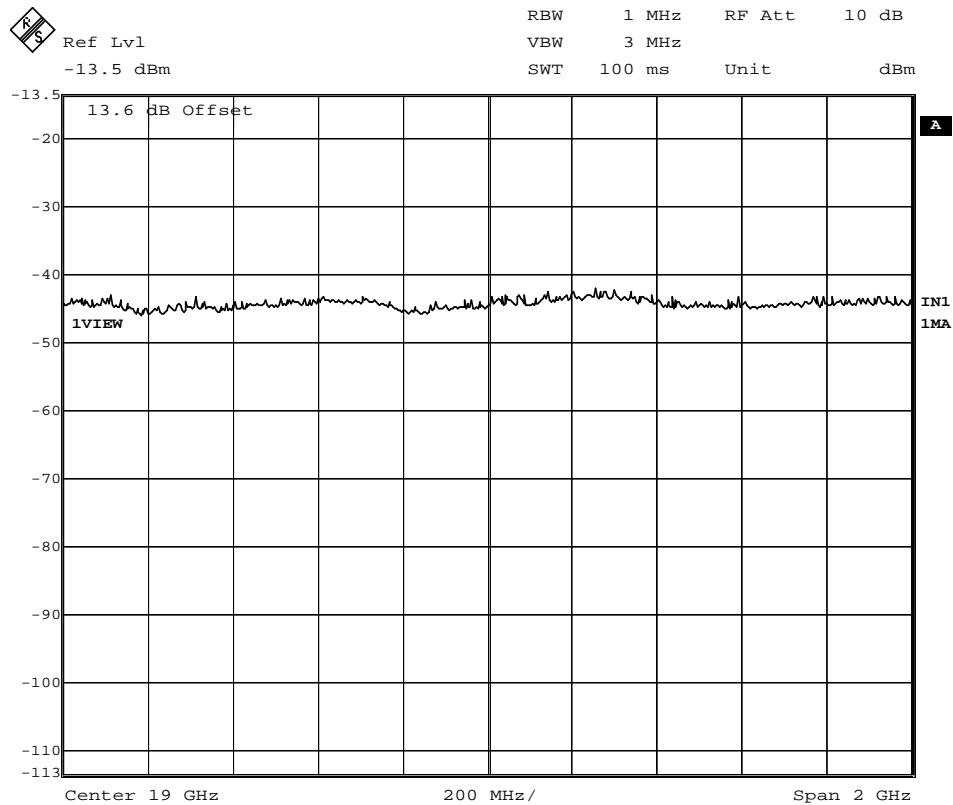

Diagram 1d:



Date: 23.OCT.2013 10:28:16

Appendix 7

Frequency stability measurements according to CFR 47 §24.235 / IC RSS 133 6.3

Date 2013-10-24 to 2013-10-27	Temperature (test equipment) 22-23 °C ± 3 °C	Humidity (test equipment) 35-41 % ± 5 %
----------------------------------	---	--

Test set-up and procedure

The measurement was made per 3GPP TS 36.141. The output was connected to a spectrum analyzer. The spectrum analyzer was connected to an external 10 MHz reference standard during the measurements.

Measurement equipment	SP number
Rohde & Schwarz signal analyzer FSQ40	504 143
RF attenuator	503 870
Testo 635, Temperature and humidity meter	504 203
Temperature cabinet	503 360

Results

Nominal transmitter frequency was 1960.0 MHz with a bandwidth of 5 MHz. Rated output power level at connector RF A (maximum): 44.8 dBm (30 W).

Test conditions		Frequency error (Hz)
Supply voltage DC (V)	Temp. (°C)	
-48.0	+20	-6
-55.2	+20	-5
-40.8	+20	-5
-48.0	+30	-2
-48.0	+40	+4
-48.0	+50	+6
-48.0	+10	+2
-48.0	0	+4
-48.0	-10	+5
-48.0	-20	+2
-48.0	-30	+4
Maximum freq. error (Hz)		6
Measurement uncertainty		$< \pm 1 \times 10^{-7}$

Appendix 7

Remark

It was deemed sufficient to test one combination of TX frequency, channel bandwidth configuration and test model (modulation), as all combinations share a common internal reference to derive the TX frequency from.

Limits

According to 3GPP TS 36.141, section 6.5.1.5:

The frequency Error shall be within $\pm(0.05 \text{ PPM} + 12 \text{ Hz})$ ($\pm 110 \text{ Hz}$).

§24.235 The frequency stability shall be sufficient to ensure that the fundamental emission stays within the authorized frequency block.

RSS-133 The carrier frequency shall not depart from the reference frequency, in excess of ± 1.0 ppm for base stations.

Complies?	Yes
-----------	-----

Appendix 8

External photos

Front side



Rear side

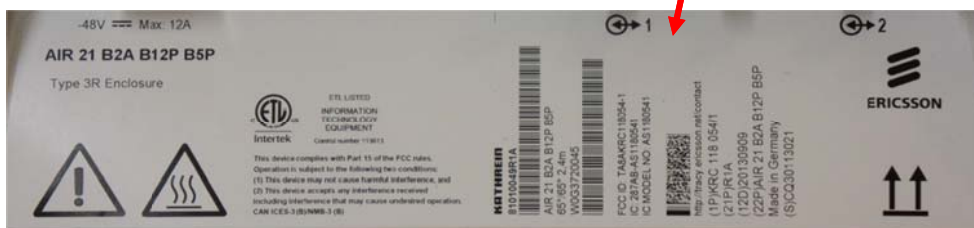

Appendix 8

Left side



Right side



Appendix 8

Top side

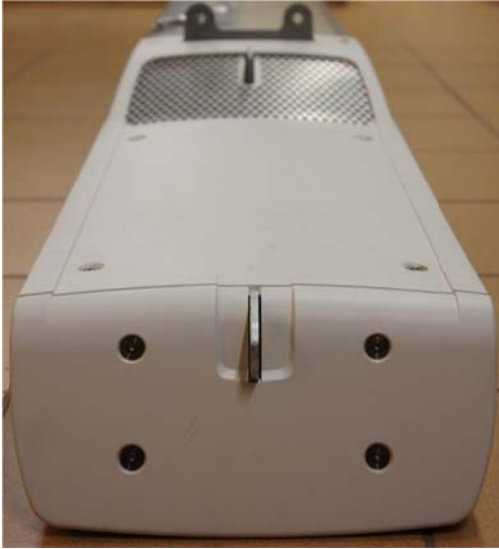

Bottom side

