



# REPORT

Issued by an FCC listed Laboratory Reg. no. 93866.  
The test site complies with RSS-Gen, IC file no. 3482A-1



Contact person  
**Tomas Lennhager**  
Electronics  
+46 10 516 54 09  
Tomas.Lennhager@sp.se

Date  
2013-12-02

Reference  
3P07327-03-F27

Page  
1 (2)

Ericsson AB  
Klaes Holm  
PDU HW  
164 80 Stockholm

## Class II permissive change on AIR 21 B4A B2P 1700/2100 MHz radio equipment with FCC ID: TA8AKRC118046-1 and IC: 287AB-AS1180461 (5 appendices)

### Test object

Product name: AIR 21 B4A B2P  
Product number: KRC 118 046/1, R3B

### Summary

See appendix 1 for general information and appendix 5 for external photos.

Standard	Compliant	Appendix
<b>FCC CFR 47 / IC RSS-139 Issue 2</b>		
2.1046 / RSS-139 6.4 RF power output	Yes	2
2.1051 / RSS-139 6.5 Spurious emission at antenna terminals	Yes	3
2.1053 / RSS-139 6.5 Field strength of spurious radiation	Yes	4

Note: Above RSS-139 items are given as cross-reference only. Measurements were performed according to ANSI procedures referenced by FCC and covered by SP's accreditation.

### SP Technical Research Institute of Sweden Electronics - EMC

Performed by

Examined by

  
Tomas Lennhager

  
Bengt Andersson

### SP Technical Research Institute of Sweden

Postal address

SP  
Box 857  
SE-501 15 BORÅS  
Sweden

Office location

Västeråsen  
Brinellgatan 4  
SE-504 62 BORÅS

Phone / Fax / E-mail

+46 10 516 50 00  
+46 33 13 55 02  
info@sp.se

Laboratories are accredited by the Swedish Board for Accreditation and Conformity Assessment (SWEDAC) under the terms of Swedish legislation. This report may not be reproduced other than in full, except with the prior written approval of the issuing laboratory.

## Table of contents

Description of the test object	Appendix 1
Operation mode during measurements	Appendix 1
Test setups	Appendix 1
Purpose of test	Appendix 1
RF power output	Appendix 2
Spurious emission at antenna terminals	Appendix 3
Field strength of spurious radiation	Appendix 4
External photos	Appendix 5

Appendix 1

**Description of the test object**

Equipment:	Product name: AIR 21 B4A B2P Product number: KRC 118 046/1, R3B FCC ID TA8AKRC118046-1 IC 287AB-AS1180461 IC MODEL NO: AS1180461
Tested configuration:	Multi RAT (MR) WCDMA + LTE
Frequency bands:	TX: 2110 – 2155 MHz RX: 1710 – 1755 MHz
Antenna ports:	2 TX/RX ports, (internally connected to integrated Cross-Polarized antenna elements).
RF configurations Multi RAT:	WCDMA + LTE, MIMO 2x2
Maximum nominal RF output power:	RF port A: 1-3 carriers WCDMA or 1-2 carriers LTE (total power 41.8 dBm, 15W) RF port B: 1-3 carriers WCDMA + 1-2 carriers LTE (total power 44.8 dBm, 30W)
Antenna type:	Cross- polarized antenna
Antenna gain:	18 dBi
WCDMA modulations:	QPSK, 16QAM and 64QAM
WCDMA channel bandwidths:	4.2 to 5 MHz (configurable in steps of 100/200 kHz)
WCDMA channel spacing:	4.4 to 5 MHz (configurable in steps of 100/200 kHz)
LTE Modulations:	QPSK, 16QAM and 64QAM
LTE Channel bandwidths:	1.4 MHz, 3 MHz, 5 MHz, 10 MHz and 15 MHz.
Nominal supply voltage:	-48VDC

## Appendix 1

**Operation mode during measurements**

MR, WCDMA + LTE

WCDMA measurements were performed with the test object transmitting test models as defined in 3GPP TS 25.141. Test model 1 (TM1) represent QPSK modulation. Test model 5 (TM5) represent 16QAM modulation and Test model 6 (TM6) represent 64QAM modulation.

LTE measurements were performed with the test object transmitting test models as defined in 3GPP TS 36.141. Test model E-TM1.1 represent QPSK modulation, test model E-TM3.2 represent 16QAM modulation and test model E-TM3.1 represent 64QAM modulation.

The settings below were deemed representative for all traffic scenarios when settings with different modulations, channel bandwidths, number of carriers and RF configurations has been tested to find the worst case setting. The settings below were used for all measurements if not otherwise noted.

WCDMA MIMO mode

TM5:8 HS-PDSCH at 240ksps + 30 DPCH:s at 30 ksps (SF=128)

Channel bandwidth 5 MHz

LTE

E-TM1.1

Channel bandwidth 1.4MHz.

Measurements were performed with the test object configured for the maximum transmit power applicable for the tested configuration.

**Conducted measurements**

The conducted measurements were performed on AIR 21 B4A B12P B8P with product number KRC 118 056/1 including the radio unit ARUS B4 1/KRC 118 046 which is identical for AIR 21 B4 B2P and is representative for conducted TX performance measurements.

The test object was pole mounted and powered with -48 VDC by an external power supply. All RF conducted measurements were performed with the test object configured for maximum transmit power. Complete measurements were made on RF B with additional measurements on RF A.

**Radiated measurements**

The test object was pole mounted and powered with -48 VDC by an external power supply. All measurements were performed with the test object configured for maximum transmit power

**Purpose of test**

The purpose of test is to justify a Class II Permissive Change of the test object with hardware update and to include the use of Multi RAT, by verifying compliance to the performance characteristics specified in applicable parts of FCC CFR 47, IC RSS-139 and IC RSS-Gen.

## Appendix 1

## References

Measurements were done according to relevant parts of the following standards:

ANSI 63.4-2009  
ANSI/TIA/EIA-603-C-2004  
CFR 47 part 2, October 1<sup>st</sup>, 2012  
CFR 47 part 27, October 1<sup>st</sup>, 2012  
3GPP TS 25.141, version 11.4.0  
3GPP TS 36.141, version 11.4.0  
3GPP TS 37.141, version 11.3.0  
RSS-Gen Issue 3  
RSS-139 Issue 2

## Uncertainties

Measurement and test instrument uncertainties are described in the quality assurance documentation "SP-QD 10885". The uncertainties are calculated with a coverage factor  $k=2$  (95% level of confidence).

Compliance evaluation is based on a shared risk principle with respect to the measurement uncertainty.

## Reservation

The test results in this report apply only to the particular test object as declared in the report.

## Delivery of test object

The test object was delivered 2013-10-18.

## Manufacturer's representative

Christer Gustavsson, Ericsson AB.

## Test engineers

Andreas Johnson, Tomas Isbring, Tomas Lennhager, Kexin Chen, Jörgen Wassholm and Hyder Khalaf, SP.

## Test participant

None.

## Appendix 1

**Measurement equipment**

	Calibration Due	SP number
Test site Tesla	2014-01	503 881
R&S FSIQ 40	2014-07	503 738
R&S ESU 26	2014-05	901 553
R&S FSQ 40	2014-03	504 143
Control computer with R&S software EMC32 version 8.52.0	-	503 899
High pass filter	2014-07	901 501
High pass filter	2014-07	901 502
High pass filter	2014-07	504 199
High pass filter	2014-09	901 373
High pass filter	2014-09	503 739
High pass filter	2014-07	503 740
RF attenuator	2014-07	504 159
RF attenuator	2014-07	900 233
RF attenuator	2014-07	900 691
RF attenuator	2014-07	901 384
RF attenuator	2013-12	901 508
Chase Bilog Antenna CBL 6111A	2014-10	503 182
EMCO Horn Antenna 3115	2015-09	502 175
Std.gain horn FLANN model 20240-20	2014-03	503 674
µComp Nordic, Low Noise Amplifier	2014-04	901 545
Miteq Low Noise Amplifier	2014-09	503 285
Schwartzbeck preamplifier BBV 9742	2014-14	504 085
Temperature and humidity meter, Testo 635	2014-06	504 203
Temperature and humidity meter, Testo 625	2014-06	504 188
Multimeter Fluke 87	2014-08	502 190

Appendix 1

**Test frequencies during radiated and conducted measurements**

TX test frequencies: MR WCDMA+ LTE

RF A + RF B		RF B		Symbolic name	Comment
WCDMA		LTE			
UARFCN (Frequency) Downlink	BW [MHz]	EARFCN (Frequency) Downlink	BW [MHz]		
1537 (2112.4 MHz)	5	2124 (2127.4 MHz)	1.4	B1.4	TX bottom constellation per LTE BW
1600 (2125 MHz)	5	2268 (2141.8 MHz)	1.4	M1.4	TX mid constellation per LTE BW
		2260 (2141 MHz)	3	M3	
		2250 (2140 MHz)	5	M5	
		2225 (2137.5 MHz)	10	M10	
		2200 (2135 MHz)	15	M15	
1670 (2139.0 MHz)	5	2393 (2154.3 MHz)	1.4	T1.4	TX top constellation per LTE BW

All RX frequencies were configured 400 MHz below the corresponding TX frequency according the applicable duplex offset for the operating band.

Appendix 1

Test set-up conducted measurements MR WCDMA + LTE

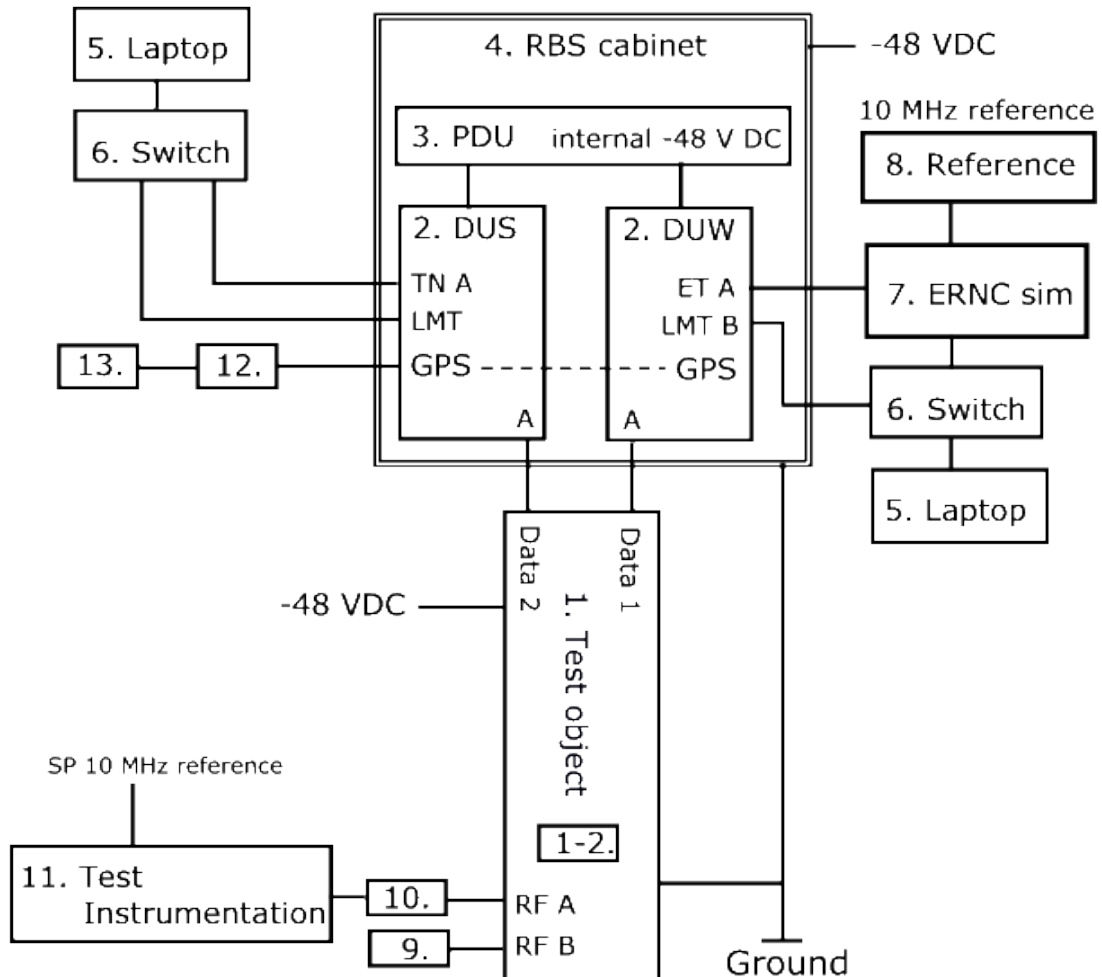

Test object:

1.	AIR 21 B4A B12P B8P, KRC 118 056/1, revision R1A, s/n: CQ30112763 with software: CXP 901 3268/6, revision R51NE 1-2. Transceiver, ARUS B4 1/KRC 118 046, revision R1C
----	---

Functional test equipment

2.	DUW 30 01, KDU 127 161/3, revision R4F, s/n: TU8XB20902 DUS 41 01, KDU 137 624/1, revision R6A, s/n: A401981869
3.	PDU 02 01, BMG 980 336/4, revision R2A, s/n: BJ31528316
4.	RBS 6201 cabinet, BAMS – 1000778792
5.	Controlling laptop HP EliteBook 8560 w, BAMS – 1001236858
6.	Fast Ethernet switch, Netgear FS726T
7.	ERNC Sim 130, BAMS – 100066091
8.	Symmetricon 8040 reference, BAMS – 1000714189
9.	Terminator, 50 ohm
10.	Attenuator, according respective appendix
11.	SP Test Instrumentation according to measurement equipment list
12.	GPS 02 01, NCD 901 41/1, revision R1D, s/n: TU8K474887
13.	GPS Active Antenna, KRE 101 2082/1



Appendix 1

Test setup radiated measurements MR WCDMA + LTE

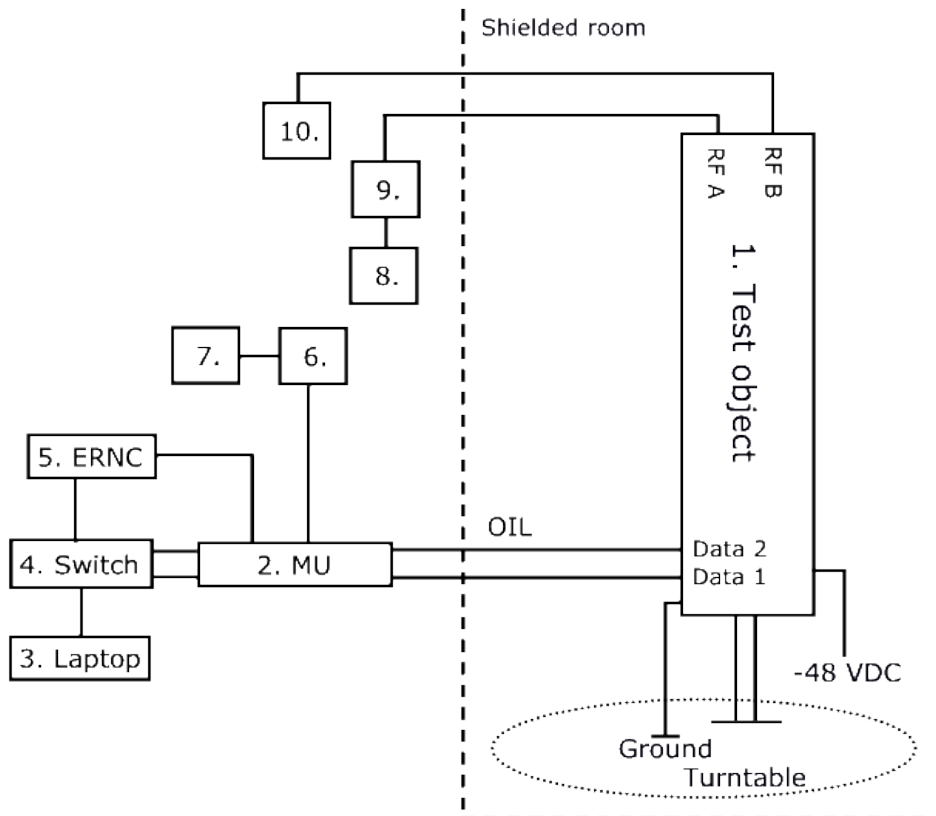

Test object:

1.	AIR 21 B4A B2P, KRC 118 046/1, revision R3B, s/n: D240048797 (FCC ID TA8AKRC118046-1 and IC 287AB-AS1180461) with software: CXP 901 3268/6, revision R51NE Transceiver, ARUS B4 1/KRC 118 046, revision R1C
----	--

Functional test equipment:

2.	Main Unit SUP 6601, 1/BFL 901 009/4, revision R1E, s/n: BR88236818 DUW 30 01, KDU 127 161/3, revision R4F, s/n: TU8XB20902 DUS 41 01, KDU 137 624/1, revision R6A, s/n: A401981869
3.	Laptop, EliteBook 8560w, BAMS – 1001236854
4.	Fast Ethernet switch, Netgear FS726T
5.	ERNC-SIM 131, BAMS – 1000660992
6.	GPS 02 01, NCD 901 41/1, revision R1D, s/n: TU8K357393
7.	GPS Active Antenna, KRE 101 2082/1
8.	FSIQ 40, SP number: 503 738, for supervision purpose only
9.	Attenuator
10.	Terminator 50 ohm

Appendix 1

<b>Interfaces:</b>	<b>Type of port:</b>
Power: -48 VDC	DC Power
Antenna port (A), (passive antenna), 7/16-connector	Antenna
Antenna port (B), (passive antenna), 7/16-connector	Antenna
Data 1, Optical Interface Link, single mode opto fibre	Signal
Data 2, Optical Interface Link, single mode opto fibre	Signal
Ground wire	Ground

**RBS software:**

<b>RAT</b>	<b>Software</b>	<b>Revision</b>
WCDMA	CXP 902 1719	R4F/5
LTE	CXP 102 051/19	R22EU

## Appendix 2

**RF power output measurements according to CFR 47 §27.50 / IC RSS-139 6.4**

Date	Temperature	Humidity
2013-11-13	22 °C ± 3 °C	28 % ± 5 %
2013-11-14	22 °C ± 3 °C	30 % ± 5 %

**Test set-up and procedure**

The test object was connected to a signal analyzer measuring peak and RMS output power in CDF mode. A resolution bandwidth of 50 MHz was used.

Measurement equipment	SP number
R&S FSQ 40	504 143
RF attenuator	901 508
Testo 635, temperature and humidity meter	504 203

**Measurement uncertainty:** 1.1 dB

**Results**

Measured total output power.

Nominal output power at RF A: 41.8 dBm.

Nominal output power at RF B: 44.8 dBm.

Symbolic name	RF A W [RMS dBm/ dB PAR]	RF B L+W [RMS dBm/ dB PAR]
B1.4	41.65/ 8.10	44.47/ 6.90
M1.4	41.75/ 8.10	44.45/ 6.90
M3	41.75/ 8.10	44.59/ 6.92
M5	41.75/ 8.10	44.57/ 7.00
M10	41.75/ 8.10	44.55/ 7.00
M15	41.76/ 8.10	44.52/ 6.97
T1.4	41.68/ 8.10	44.38/ 6.90

Note: The PAR value is the 0.1 % Peak to Average Ratio.

Appendix 2

Measured output power per 1 MHz

Symbolic name	RF A W [RMS dBm/ dB PAR]	RF B L+W [RMS dBm/ dB PAR]	Total power of WCDMA <sup>1)</sup> [RMS dBm]
B1.4	W=36.59	W=36.45, L=40.70	39.59
M1.4	W=36.67	W=36.36, L=40.54	39.67
M3	W=36.76	W=36.37, L=37.81	39.76
M5	W=36.71	W=36.60, L=36.67	39.71
M10	W=36.72	W=36.47, L=32.87	39.72
M15	W=36.71	W=36.63, L=31.08	39.71
T1.4	W=36.59	W=36.24, L=40.14	36.59

<sup>1)</sup>: Measured according to FCC KDB662911 D01 Multiple Transmitter Output v02r01. Method E), 2), c). "Measure and add  $10 \log(N_{Ant})$ ".

**Limits**

§27.50: The maximum output power may not exceed 1640 W (EIRP)/ MHz. The Peak to Average Ratio (PAR) may not exceed 13 dB.

RSS-139 6.4: The average equivalent isotropically radiated power (e.i.r.p.) limits in SRSP-513 apply, resulting in a maximum EIRP of 1640 W/ MHz for the scope of this report. The peak-to-average ratio of the power shall not exceed 13 dB.

Complies?	Yes
-----------	-----

Appendix 3

**Conducted spurious emission measurements according to CFR 47 §27.53(h)/ IC RSS-139 6.5**

Date	Temperature	Humidity
2013-11-12	21 °C ± 3 °C	35 % ± 5 %
2013-11-13	22 °C ± 3 °C	28 % ± 5 %

**Test set-up and procedure**

The measurements were made per definition in §27.53(h). The output was connected to a spectrum analyzer with a RBW setting of 1 MHz and RMS detector activated. The spectrum analyzer was connected to an external 10 MHz reference standard during the measurements.

Before comparing the results to the limit, 3 dB [10 log (2)] should be added according to method E), 3), (iii) “measure and add 10 log(N<sub>ANT</sub>)” of FCC KDB662911 D01 Multiple Transmitter Output v02r01.

Measurement equipment	SP number
R&S FSW 43	902 073
RF attenuator	902 282
HP filter	901 502
Testo 635, temperature and humidity meter	504 203

Measurement uncertainty: 3.7 dB

**Results**

Diagram	Symbolic name	Tested Port
1 a-e	B1.4	RF B
2 a-e	M1.4	RF B
3 a-e	M3	RF B
4 a-e	M5	RF B
5 a-e	M10	RF B
6 a-e	M15	RF B
7 a-e	T1.4	RF B

## Appendix 3

**Remark**

The emission at 9 kHz on the plots was not generated by the test object. A complementary measurement with a smaller RBW showed that it was related to the LO feed-through.

The highest fundamental frequency is 2.155 GHz. The measurements were made up to 22 GHz ( $10 \times 2.155 \text{ GHz} = 21.55 \text{ GHz}$ ).

**Limits**

§27.53(h) and RSS-139 6.5

Outside a licensee's frequency band(s) of operation the power of any emission shall be attenuated below the transmitter power (P) by at least  $43 + 10 \log(P)$  dB, resulting in a limit of -13 dBm per 1 MHz RBW.

Complies?	Yes
-----------	-----

Appendix 3

Diagram 1 a:

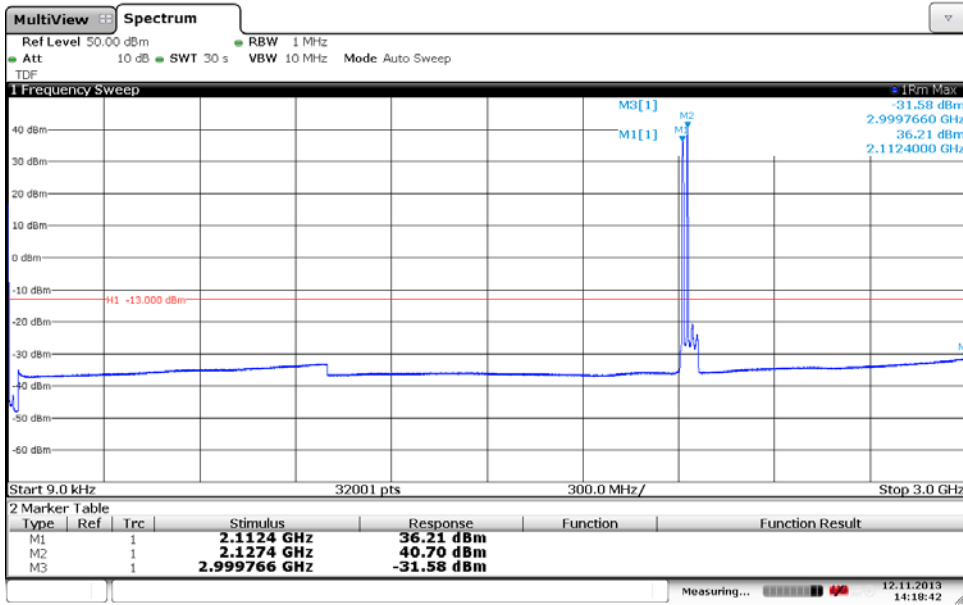
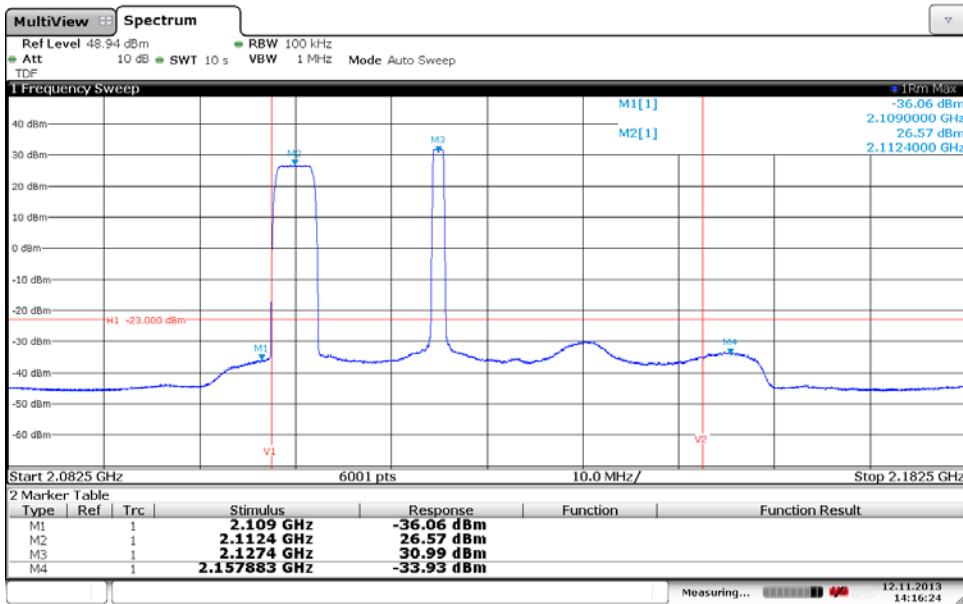
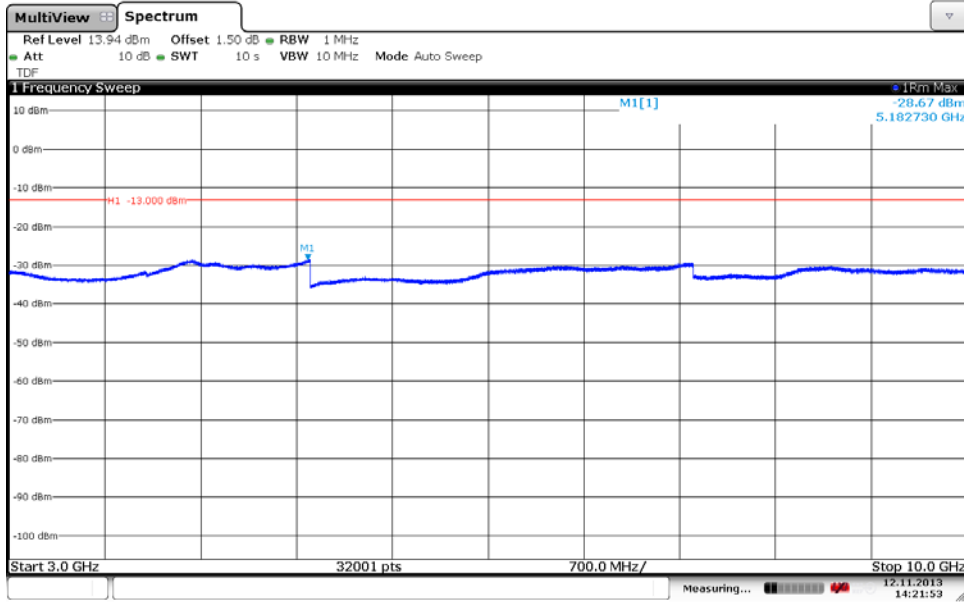

Diagram 1 b:



Appendix 3

Diagram 1 c:



Date: 12 NOV. 2013 14:21:52

Diagram 1 d:

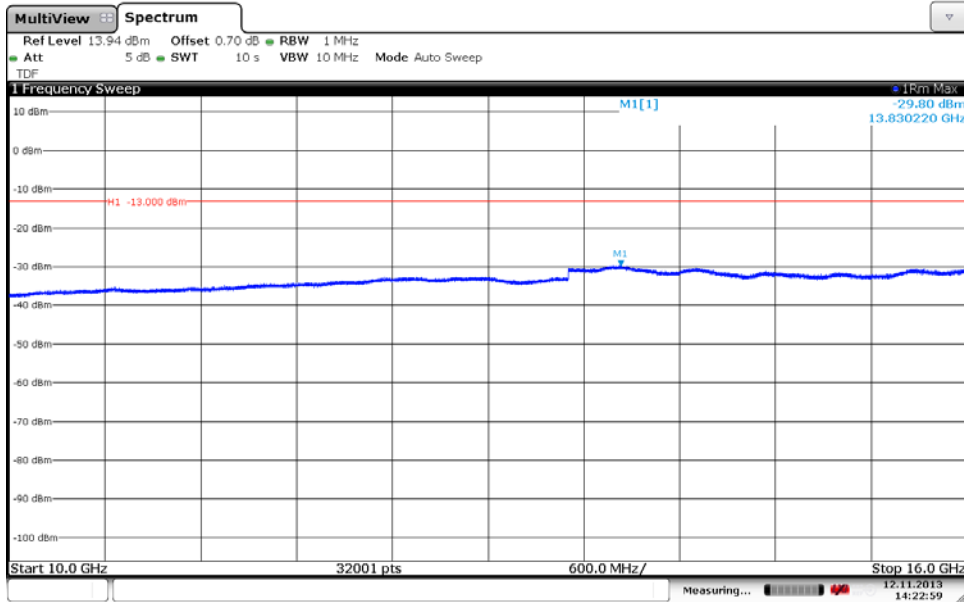

Date: 12 NOV. 2013 14:23:00



Appendix 3

Diagram 1 e:

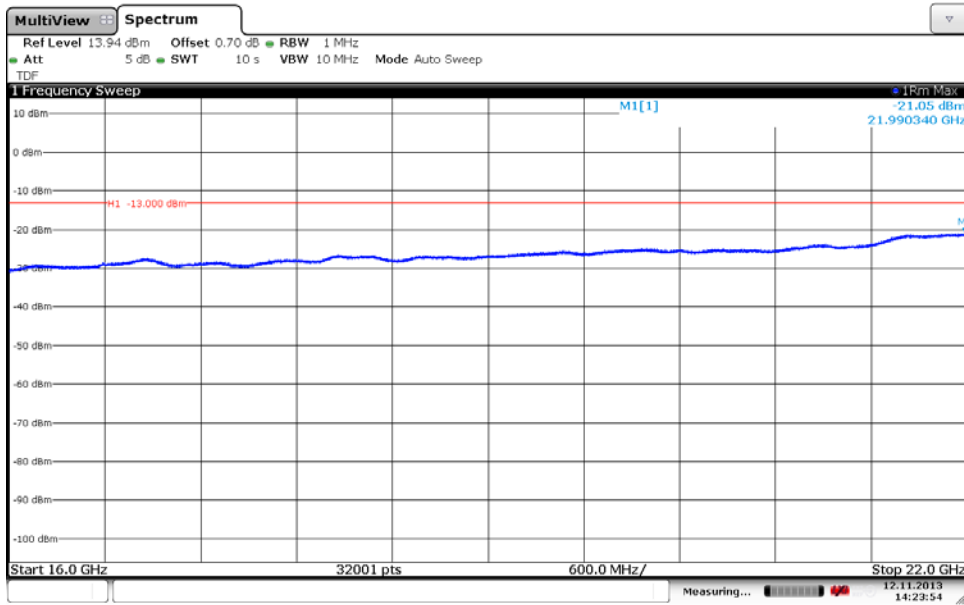

Date: 12 NOV. 2013 14:23:54

Appendix 3

Diagram 2 a:

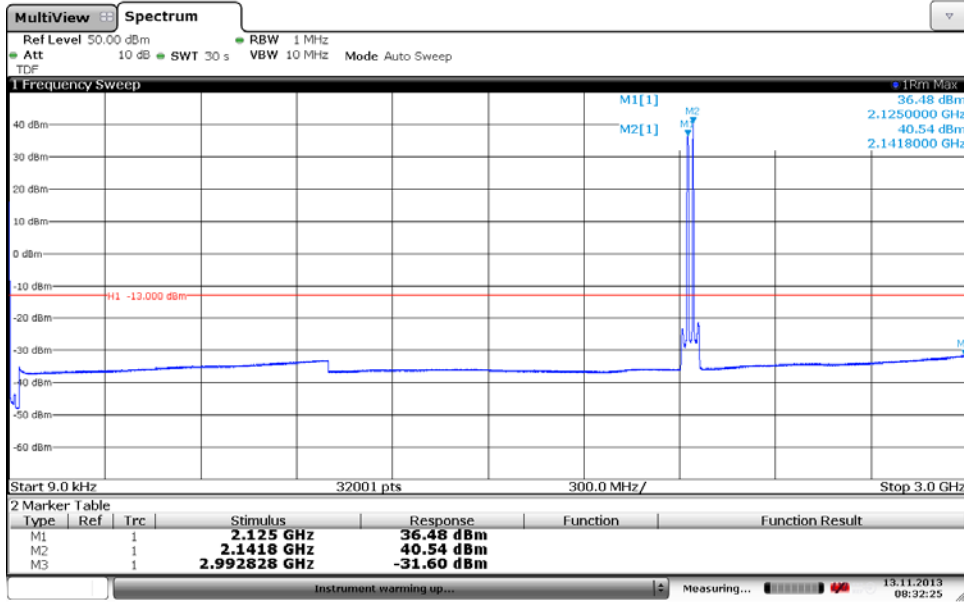

Date: 13 NOV.2013 08:32:25

Diagram 2 b:

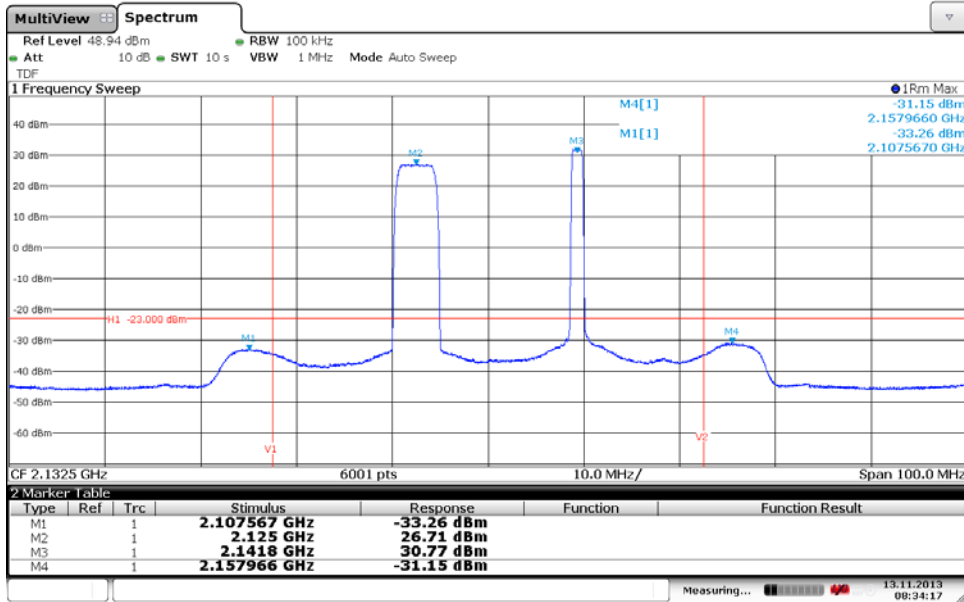

Date: 13 NOV.2013 08:34:18

Appendix 3

Diagram 2 c:

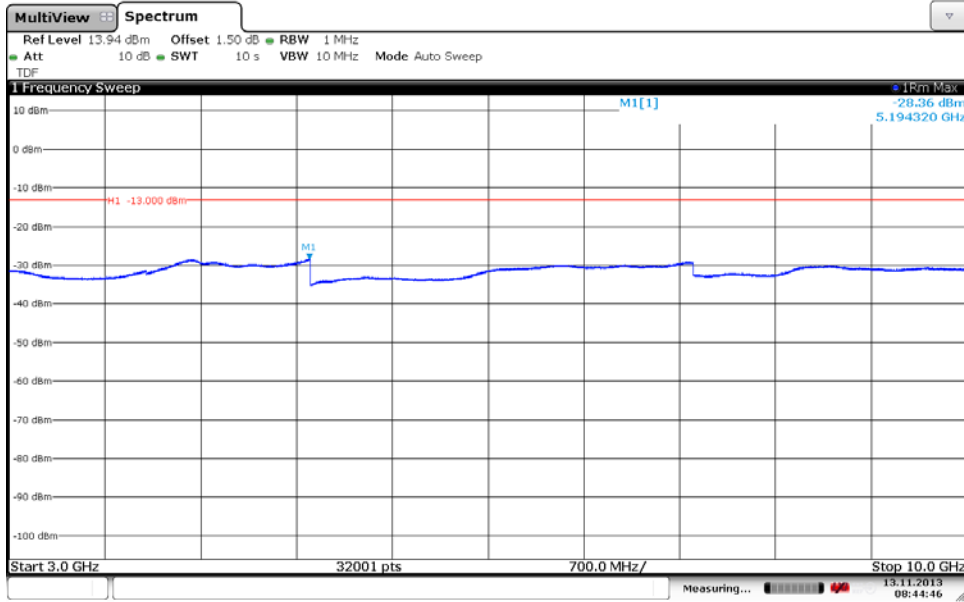

Date: 13 NOV.2013 08:44:46

Diagram 2 d:

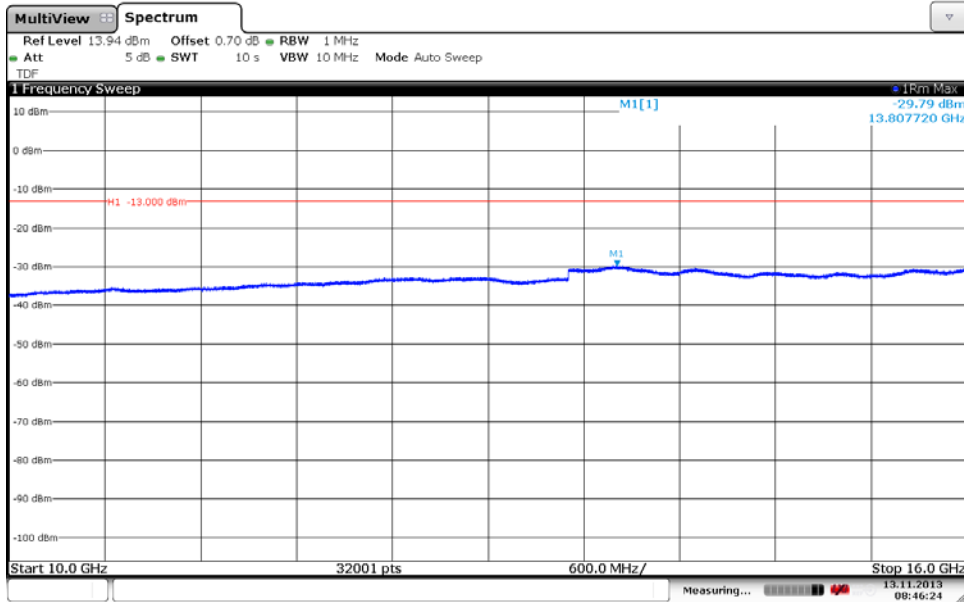

Date: 13 NOV.2013 08:46:24

Appendix 3

Diagram 2 e:

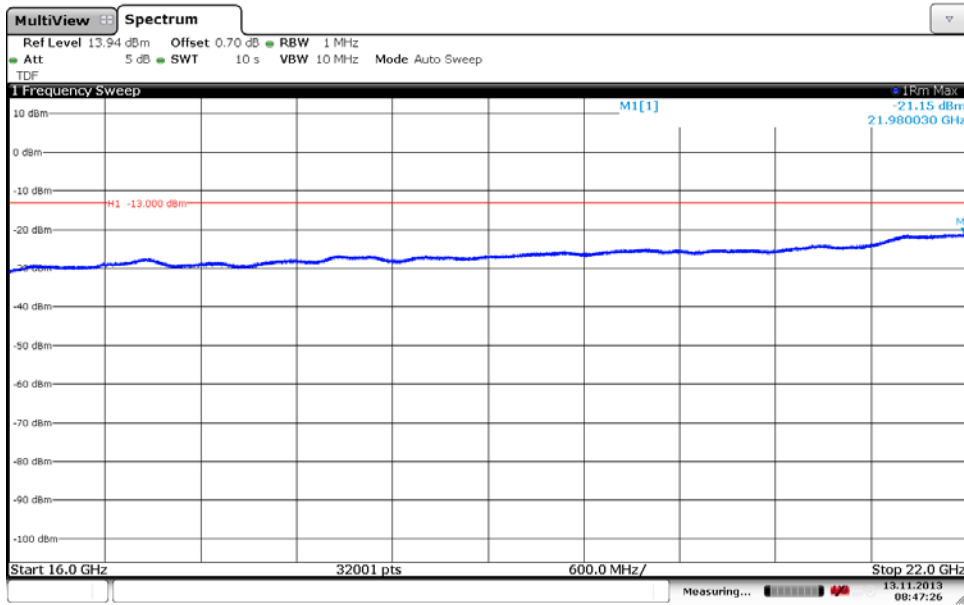

Date: 13 NOV. 2013 08:47:26

Appendix 3

Diagram 3 a:

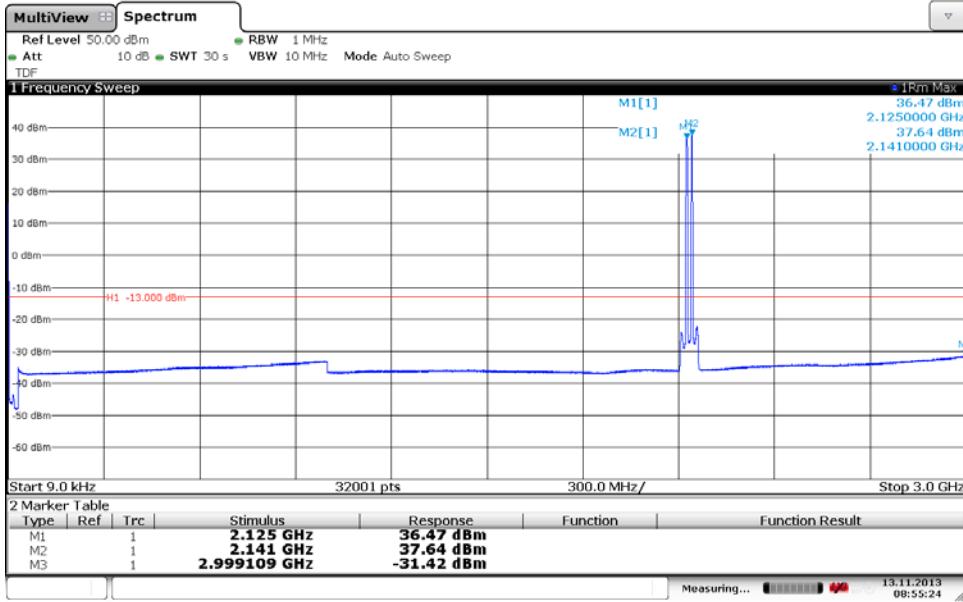
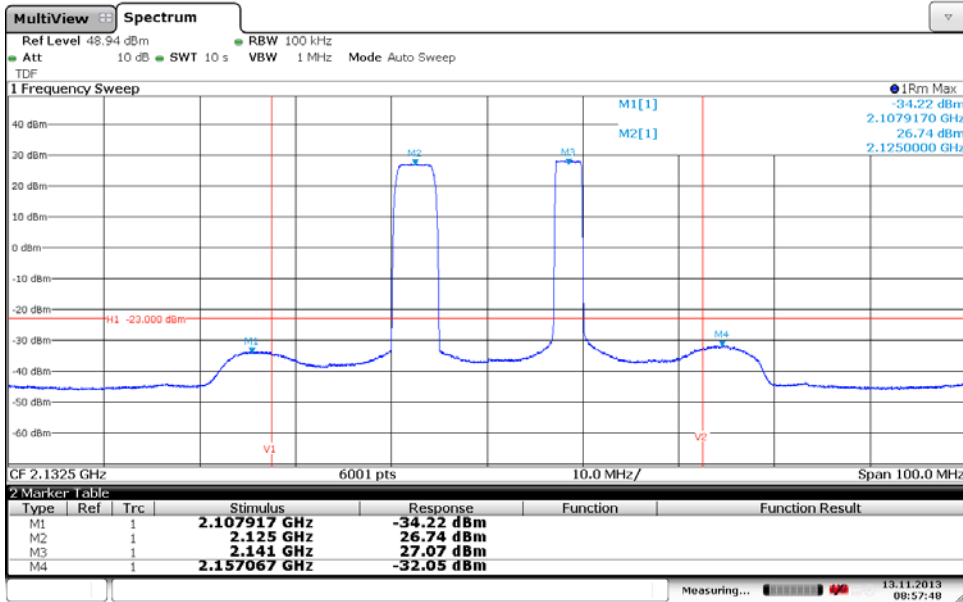
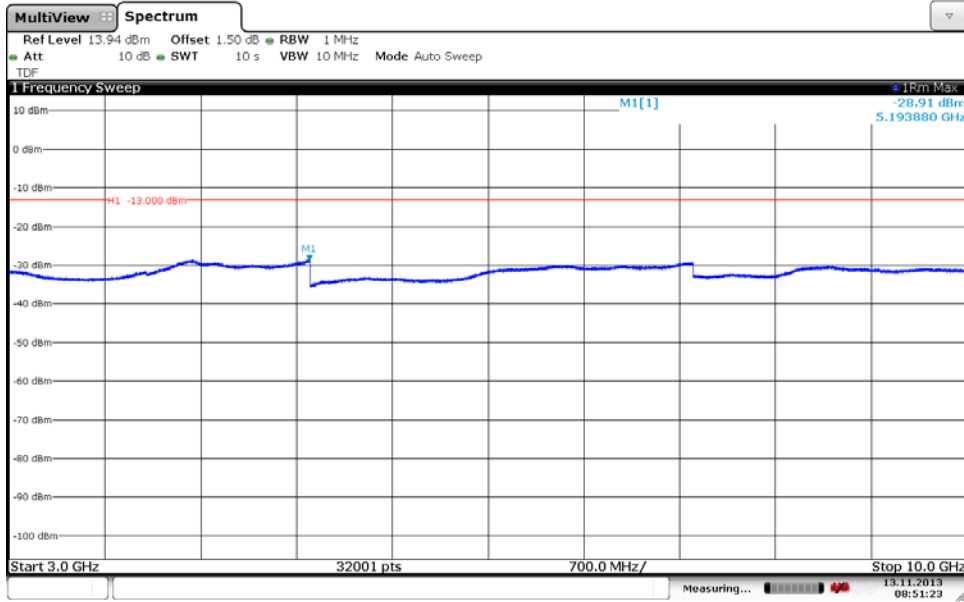

Diagram 3 b:



Appendix 3

Diagram 3 c:



Date: 13 NOV.2013 08:51:22

Diagram 3 d:

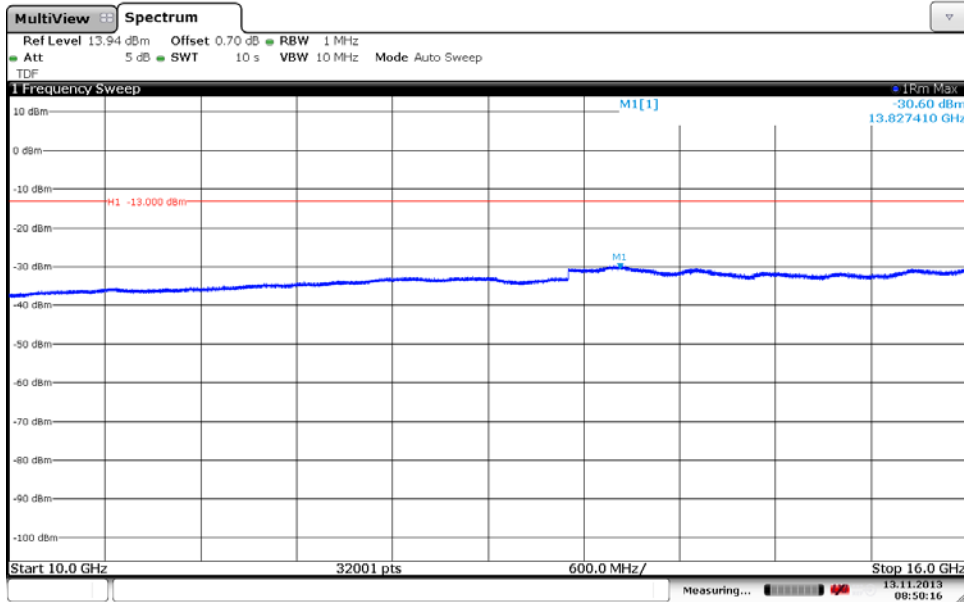

Date: 13 NOV.2013 08:50:16

Appendix 3

Diagram 3 e:

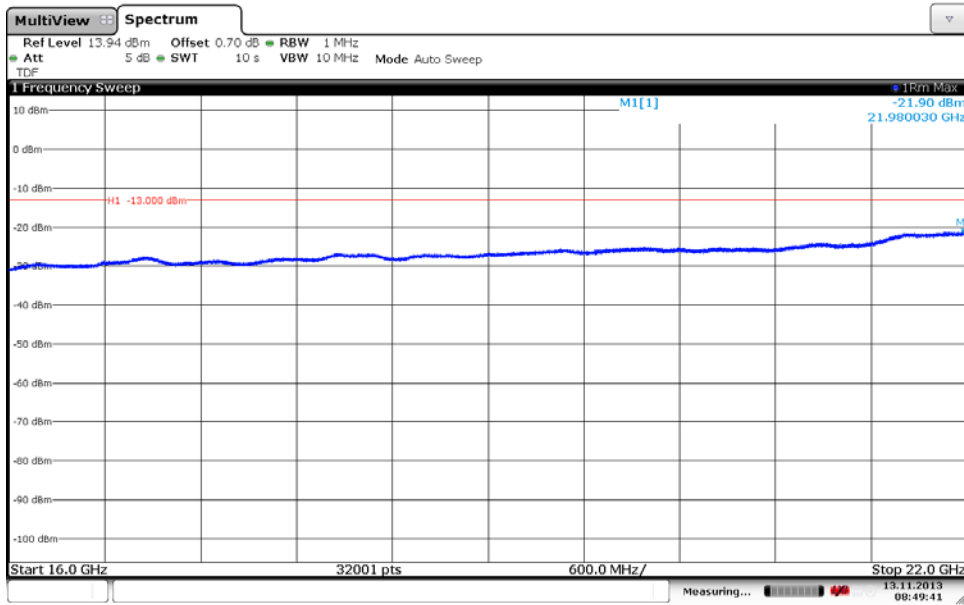

Appendix 3

Diagram 4 a:

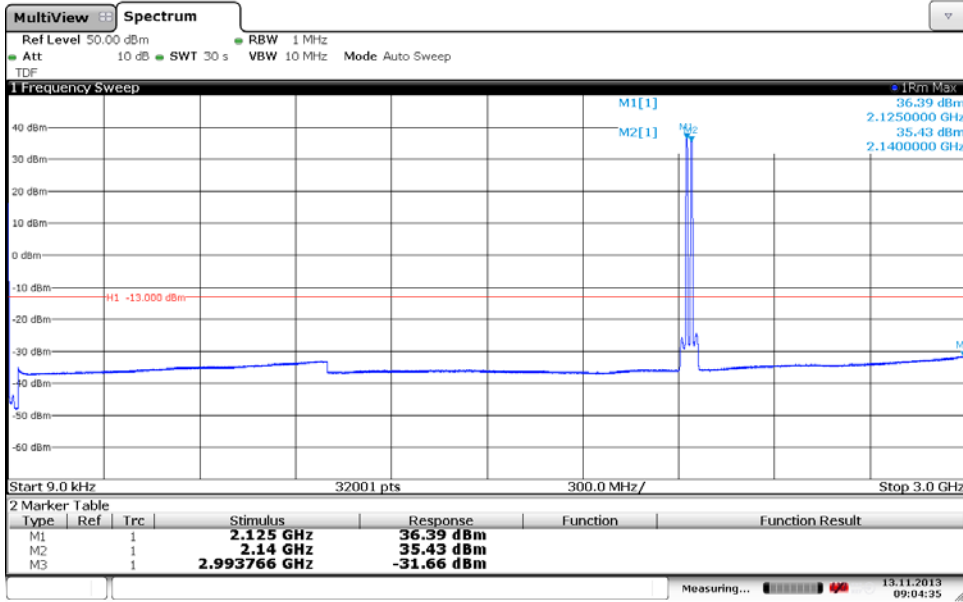

Date: 13 NOV.2013 09:04:35

Diagram 4b:

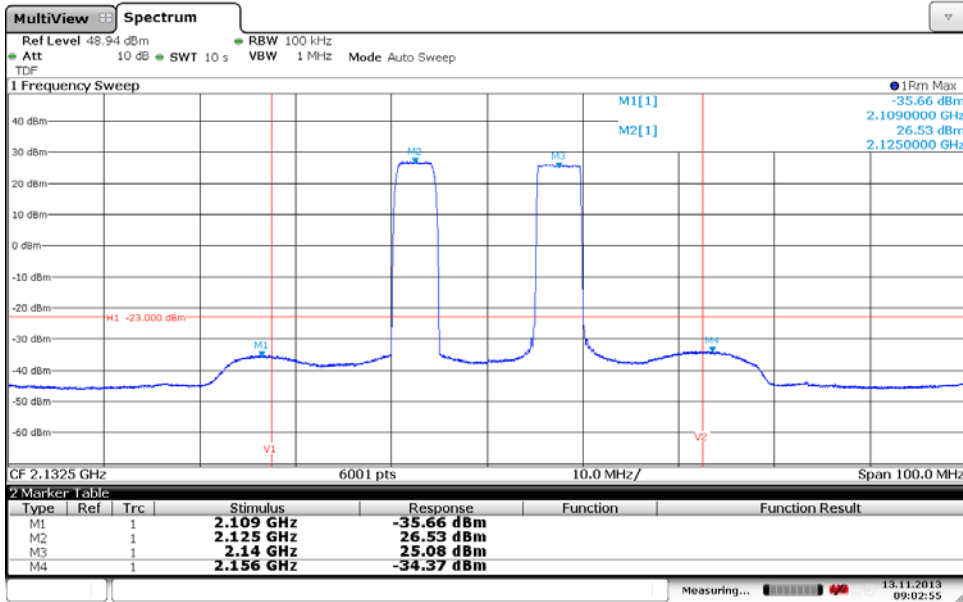

Date: 13 NOV.2013 09:02:55



Appendix 3

Diagram 4 c:

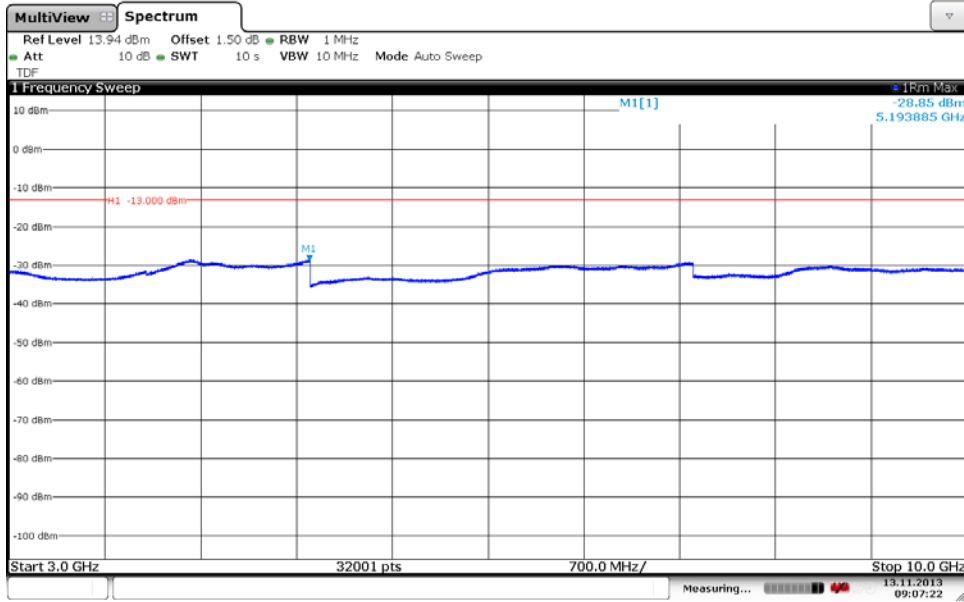
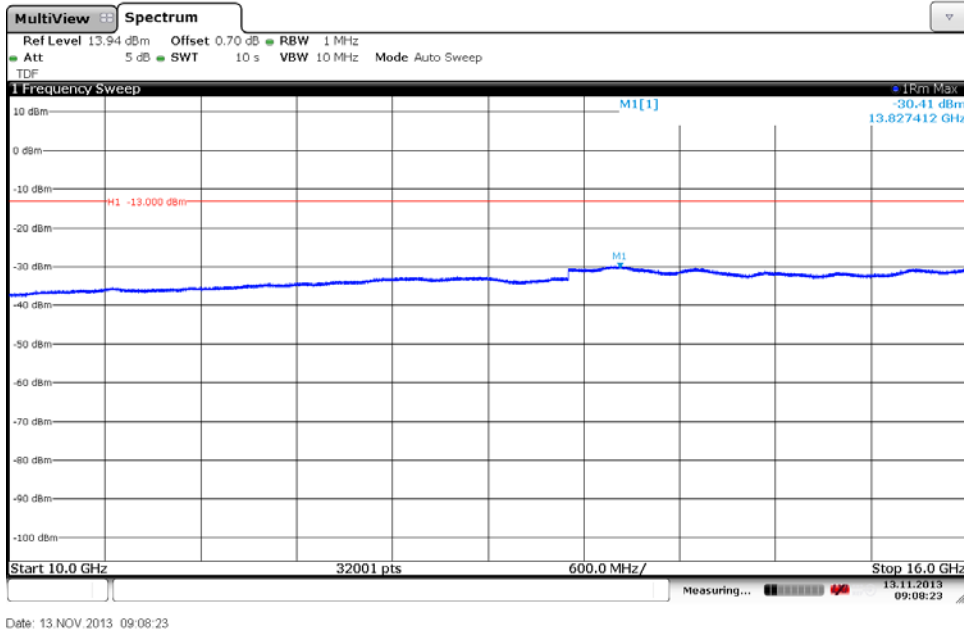
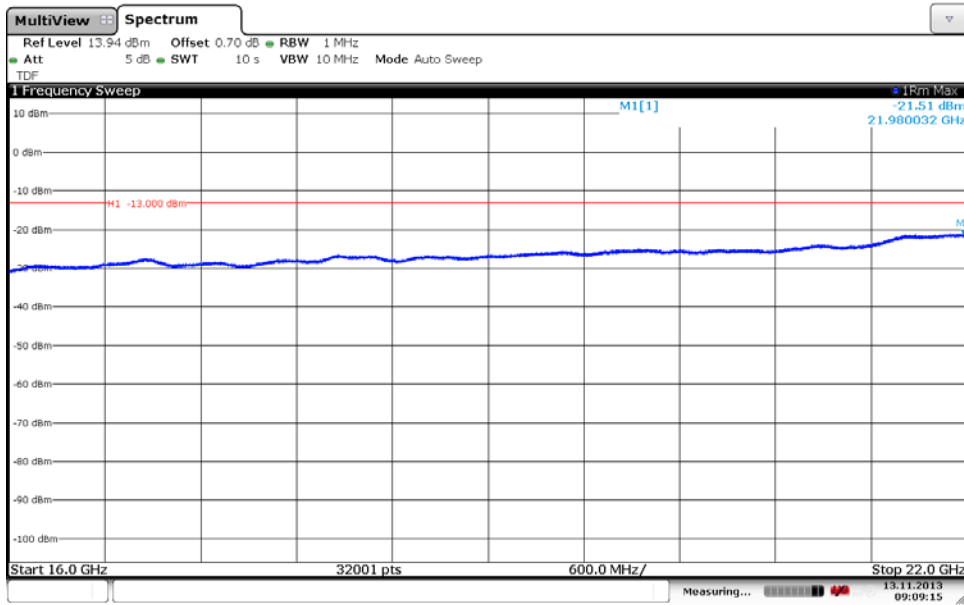

Diagram 4 d:



Appendix 3

Diagram 4 e:



Date: 13 NOV. 2013 09:09:16

Appendix 3

Diagram 5 a:

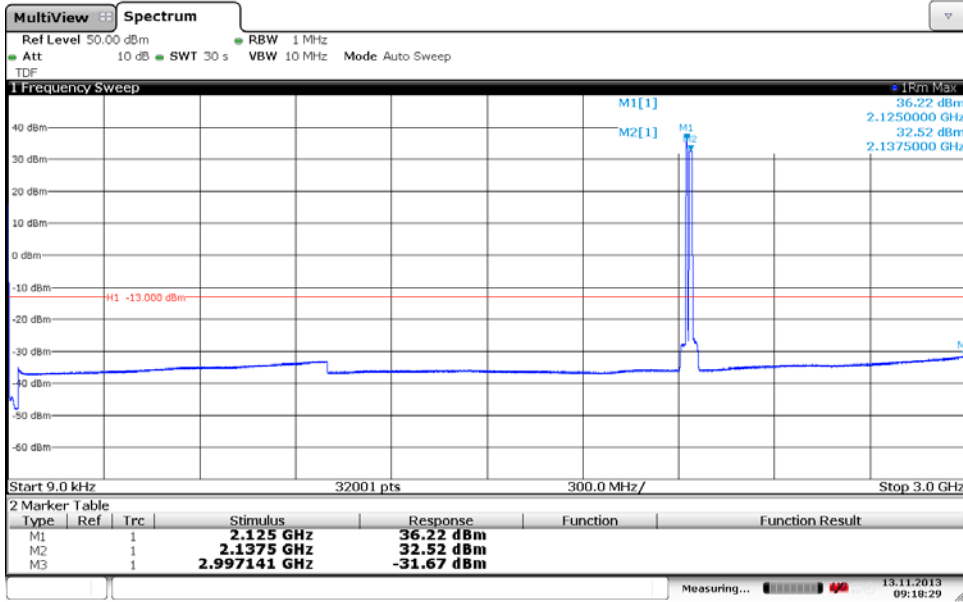

Date: 13 NOV.2013 09:18:29

Diagram 5 b:

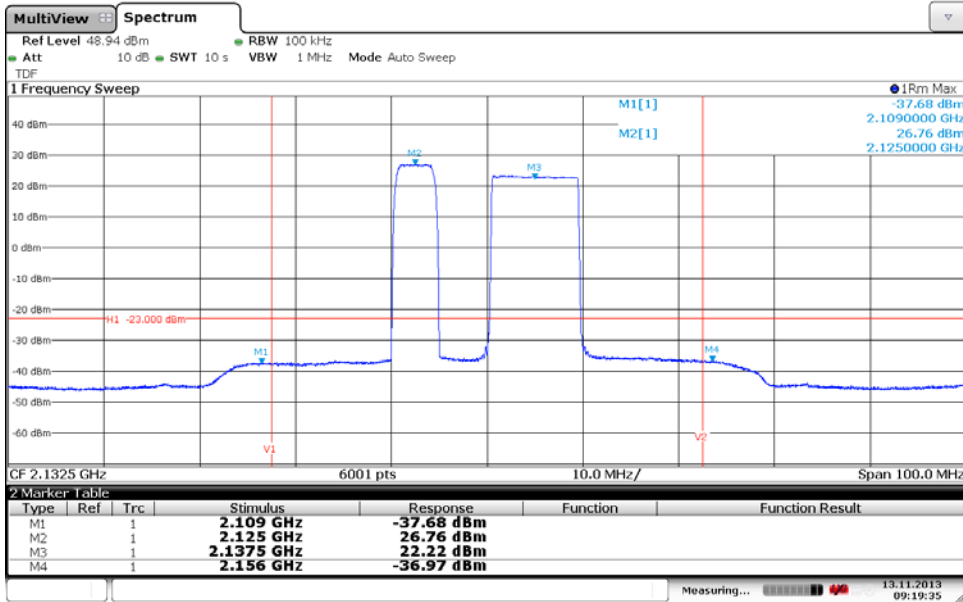

Date: 13 NOV.2013 09:19:35

Appendix 3

Diagram 5 c:

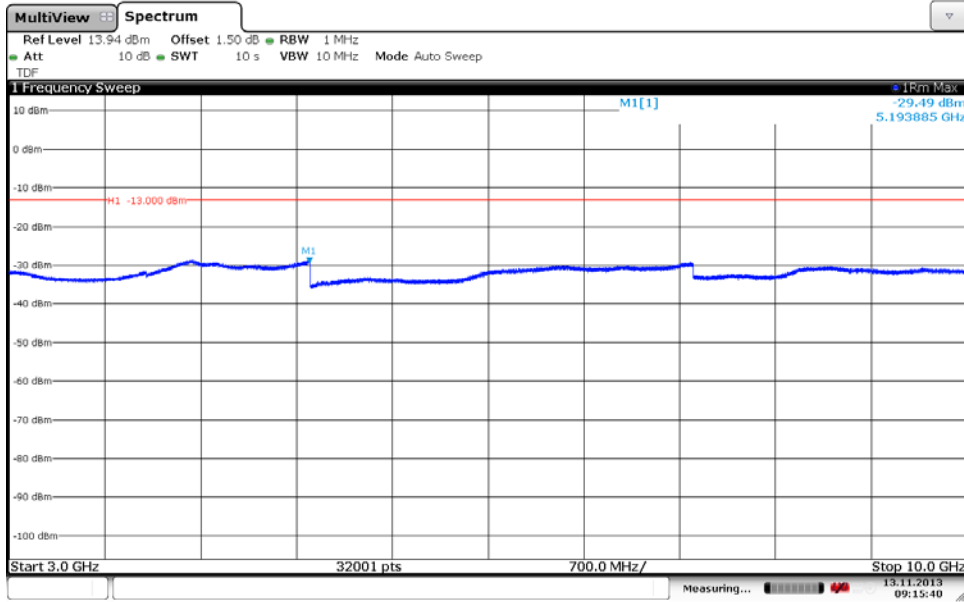
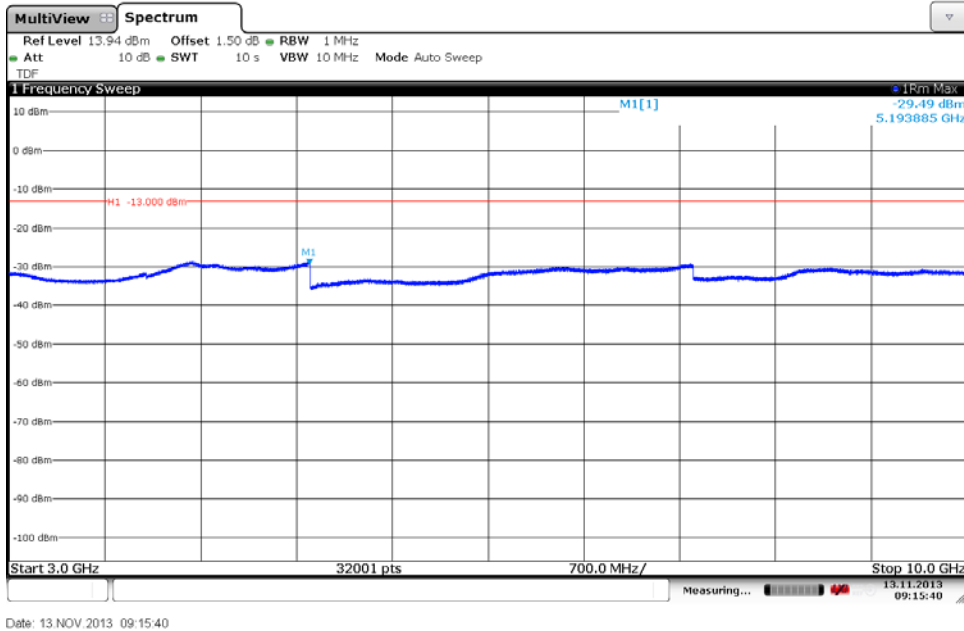
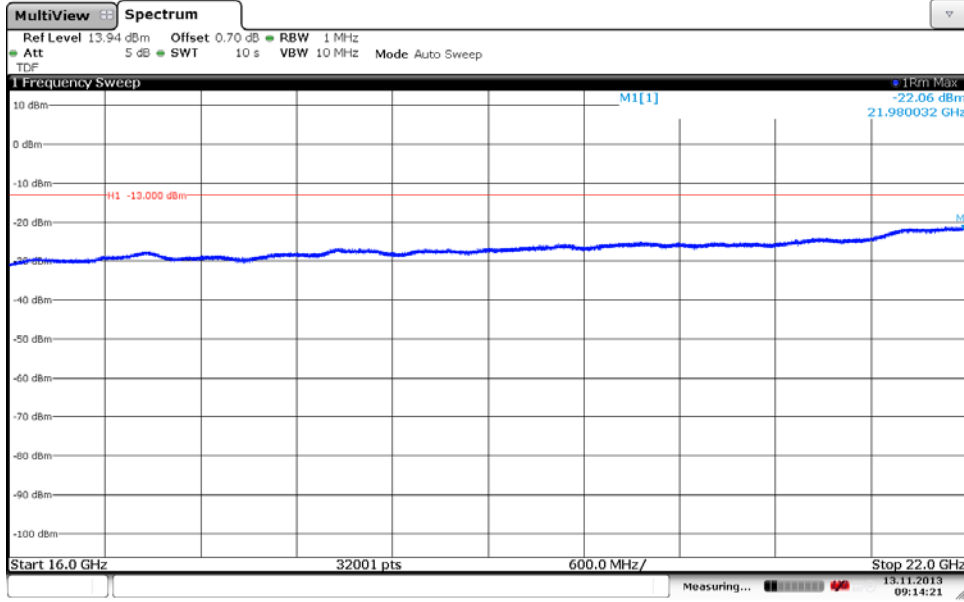

Diagram 5 d:



Appendix 3

Diagram 5 e:



Date: 13 NOV. 2013 09:14:20

Appendix 3

Diagram 6 a:

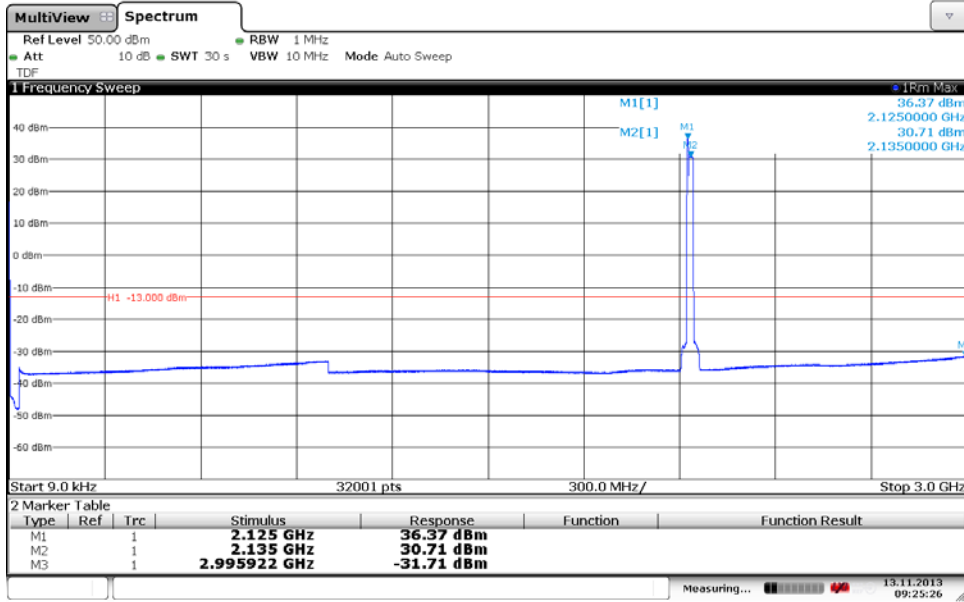

Date: 13 NOV.2013 09:25:26

Diagram 6 b:

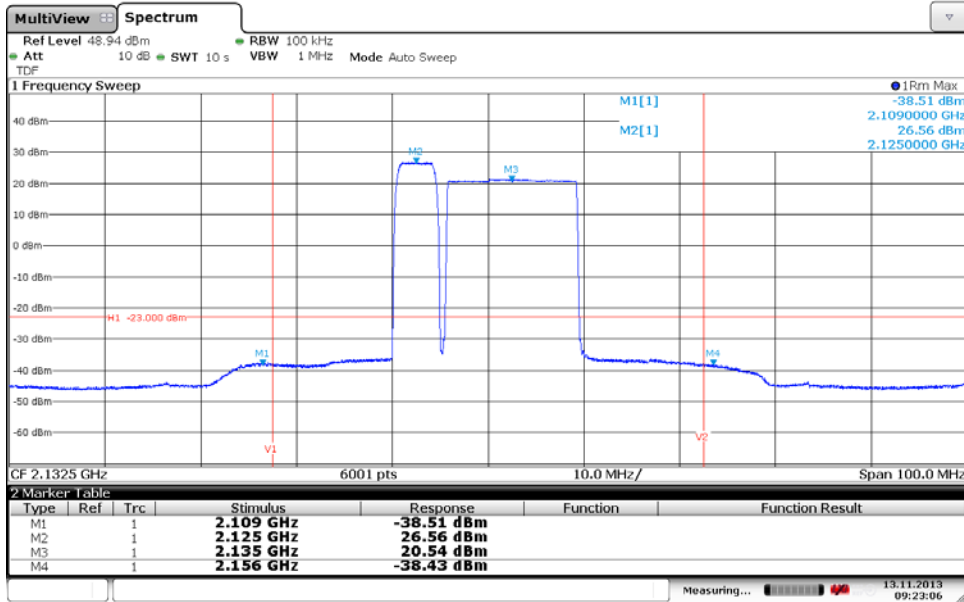

Date: 13 NOV.2013 09:23:06

Appendix 3

Diagram 6 c:

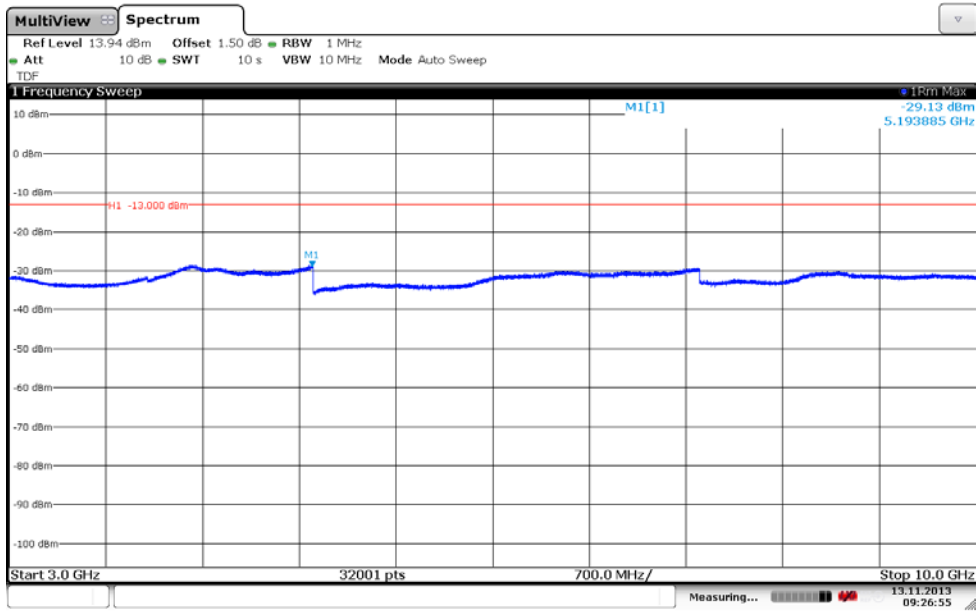
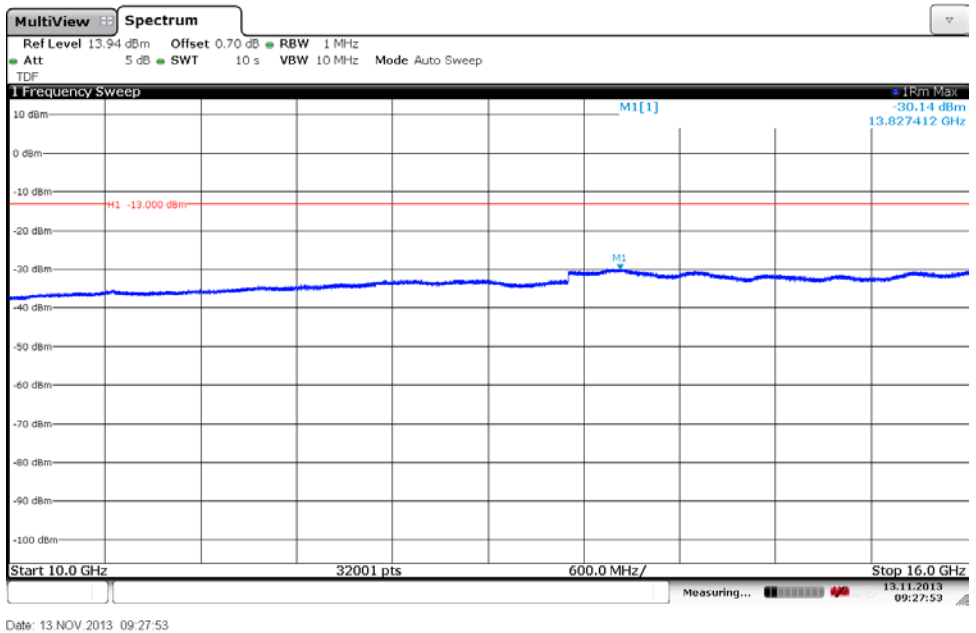
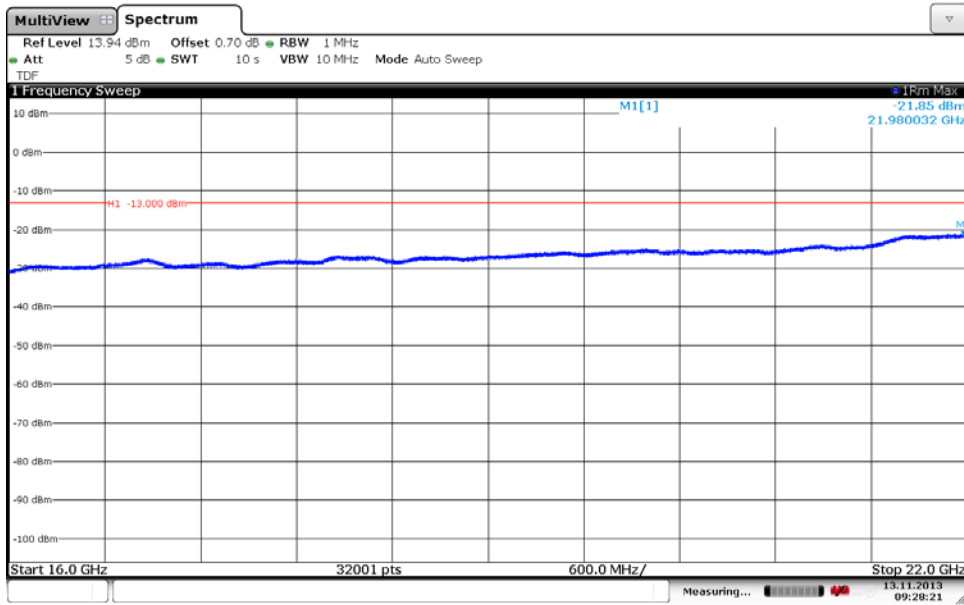

Diagram 6 d:



Appendix 3

Diagram 6 e:



Date: 13 NOV. 2013 09:28:21



Appendix 3

Diagram 7 a:

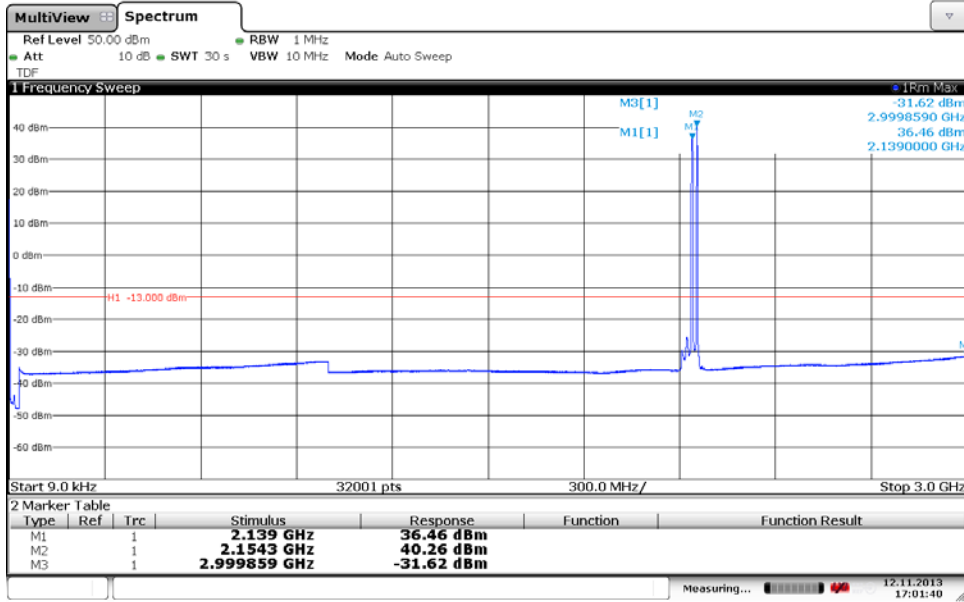
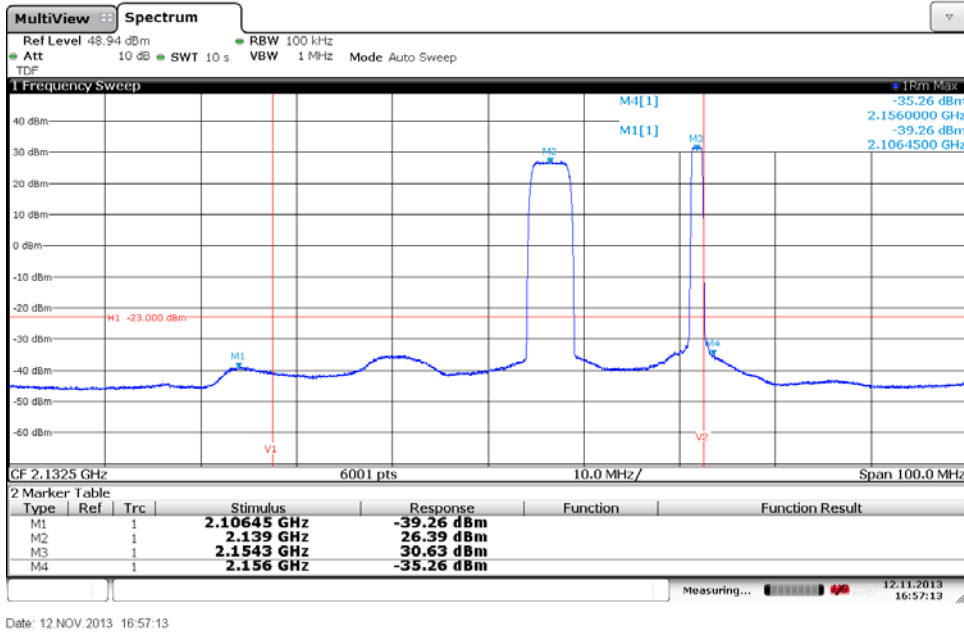
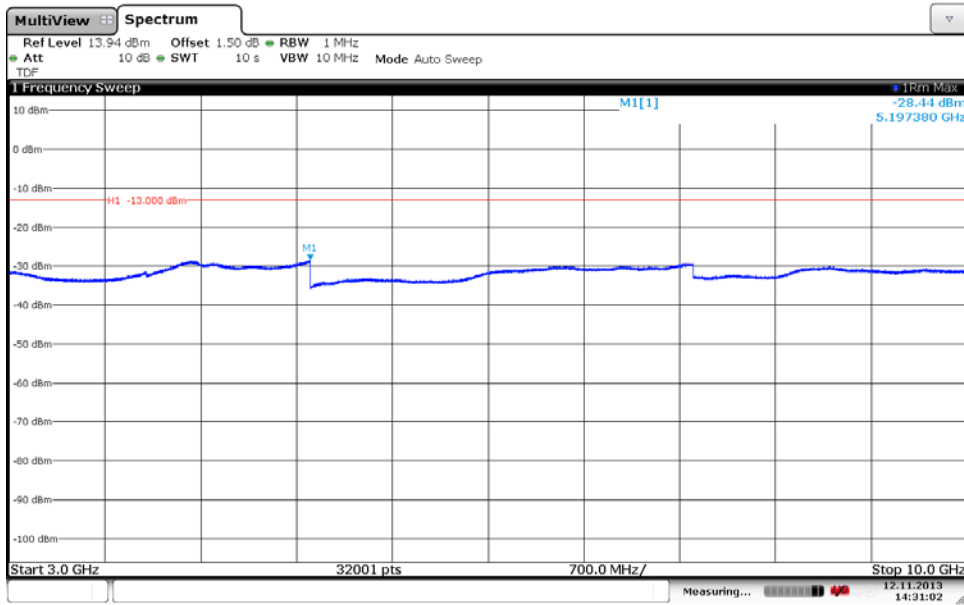

Diagram 7 b:



Appendix 3

Diagram 7 c:



Date: 12 NOV. 2013 14:31:02

Diagram 7 d:

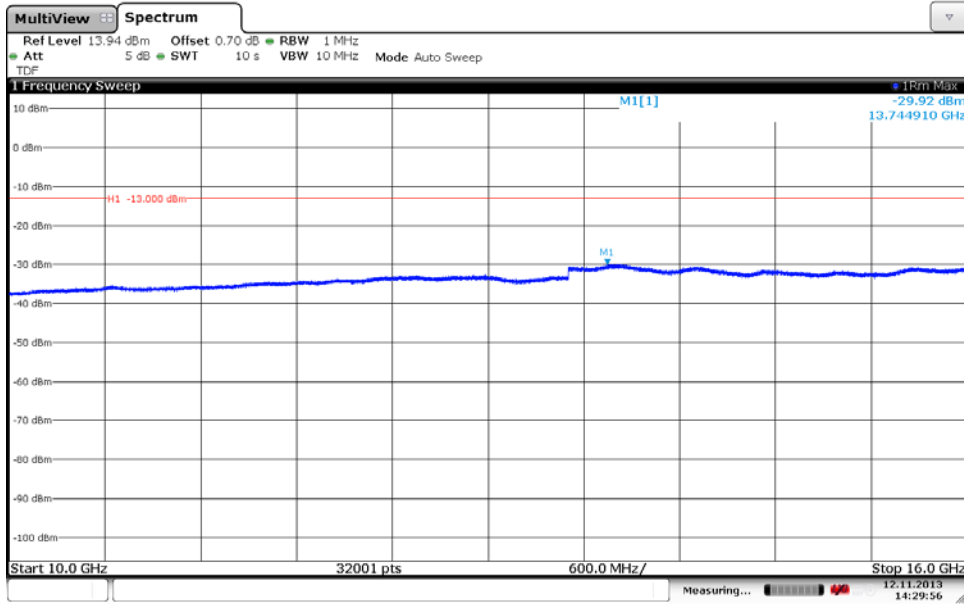

Date: 12 NOV. 2013 14:29:56

Appendix 3

Diagram 7 e:

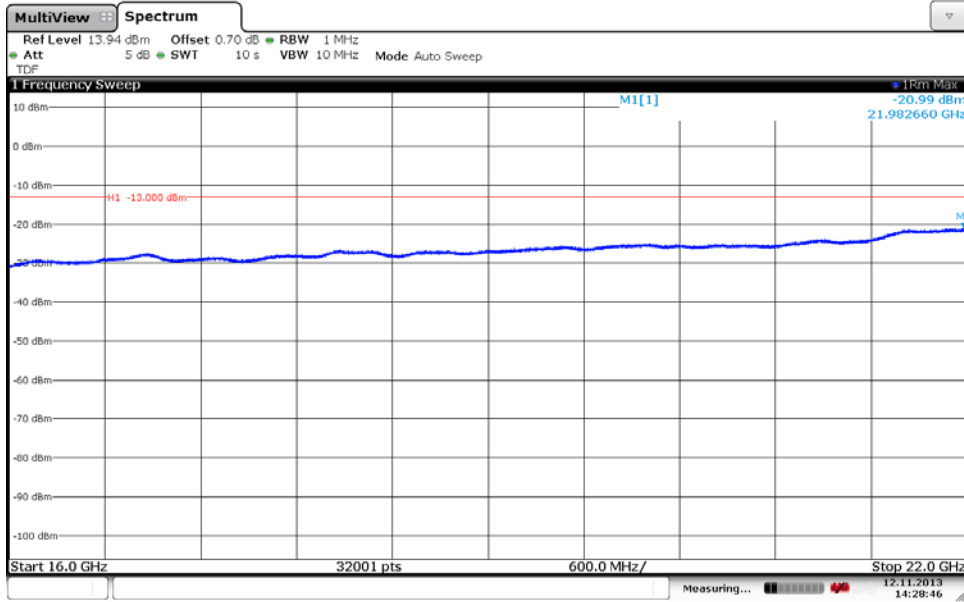

Appendix 4

**Field strength of spurious radiation measurements according to 47 CFR 27.53 (h) / IC RSS-139 6.5**

Date	Temperature	Humidity
2013-11-03	23°C ± 3°C	42 % ± 5 %
2013-11-04	23°C ± 3°C	35 % ± 5 %

**Test set-up and procedure**

The test sites are listed at FCC, Columbia with registration number: 93866. The test site complies with RSS-Gen, Industry Canada file no. 3482A-1.

The measurements were performed with both horizontal and vertical polarization of the antenna. The antenna distance was 3 m in the frequency range 30 MHz – 18 GHz and 1m in the frequency range 18 - 22 GHz.

In the frequency range 30 MHz – 22 GHz the measurement was performed in power with a RBW of 1 MHz. A propagation loss in free space was calculated. The used formula was

$$\gamma = 20 \log \left( \frac{4\pi D}{\lambda} \right), \gamma \text{ is the propagation loss and } D \text{ is the antenna distance.}$$

The measurement procedure was as the following:

1. The pre-measurement was first performed with peak detector. The EUT was measured in eight directions and with the antenna at three heights, 1.0 m, 1.5 m and 2.0 m.
2. Spurious radiation on frequencies closer than 20 dB to the limit in the pre-measurement is scanned 0-360 degrees and the antenna is scanned 1- 4 m for maximum response. The emission is then measured with the RMS detector and the RMS value is reported. Frequencies closer than 10 dB to the limit when measured with the RMS detector were measured with the substitution method according to the standard.

## Appendix 4

Representative test set-up during the spurious radiation measurements is shown in the picture below:



### Measurement equipment

Measurement equipment	SP number
Semi anechoic chamber	503 881
R&S ESU 26	901 553
EMC 32 ver. 8.52.0	503 899
Chase Bilog Antenna CBL 6111A	502 182
EMCO Horn Antenna 3115	502 175
Flann STD Gain Horn Antenna 20240-20	503 674
High pass filter, RLC Electronics, 3-18 GHz	503 739
Miteq, Low Noise Amplifier	503 285
Schwartzbeck preamplifier BBV 9742	504 085
µComp Nordic, Low Noise Amplifier	901 545
Temperature and humidity meter, Testo 625	504 188

### Tested configurations

LTE BW [MHz]	Symbolic name
1.4	B
1.4	M
3	M
5	M
10	M
15	M
1.4	T

Appendix 4

**Results**, representing worst case

Diagram	BW [MHz]	Symbolic name
1 a-d	1.4 MHz	M

Frequency (MHz)	Spurious emission level (dBm)	
	Vertical	Horizontal
30-22 000	All emission > 20 dB below limit	All emission > 20 dB below limit

**Measurement uncertainty:**

3.2 dB up to 18 GHz, 3.6 dB above 18 GHz

**Limits**

§27.53(h) and RSS-139 6.5

Outside a licensee's frequency band(s) of operation the power of any emission shall be attenuated below the transmitter power (P) by at least  $43 + 10 \log (P)$  dB, resulting in a limit of -13 dBm per 1 MHz RBW.

Complies?	Yes
-----------	-----

Appendix 4

Diagram 1a:

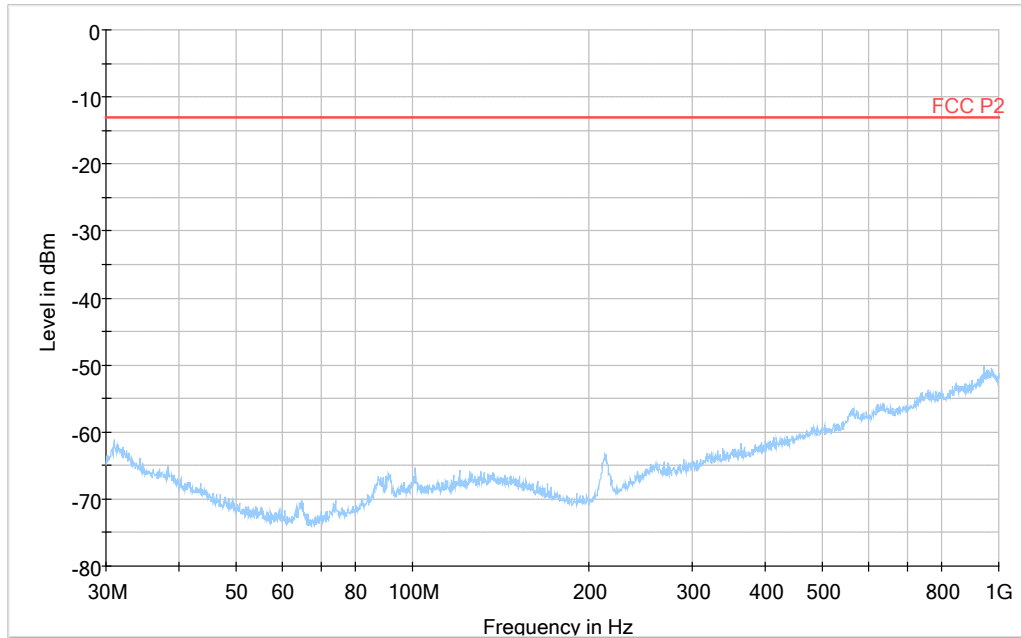
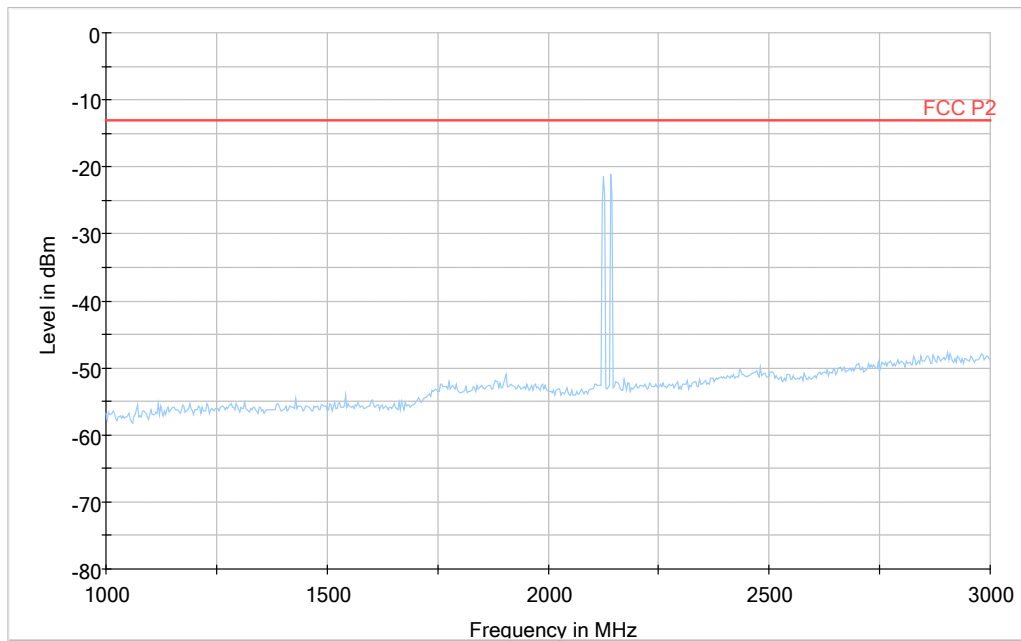

Diagram 1b:



Note: The emission between 2125 and 2141.8 MHz are the carrier frequencies and shall be ignored in the context.

Appendix 4

Diagram 1c:

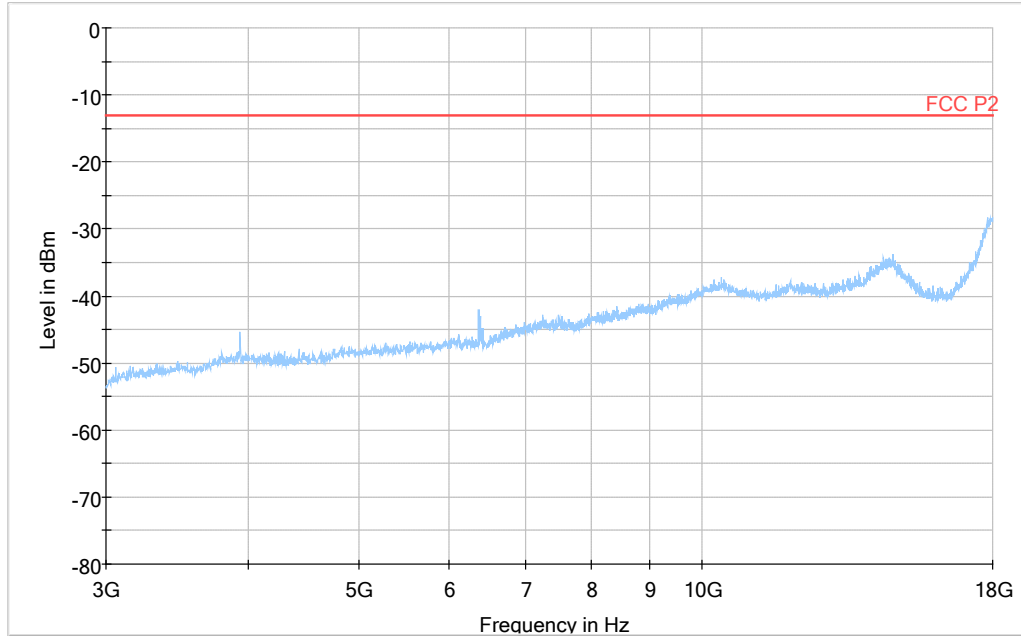
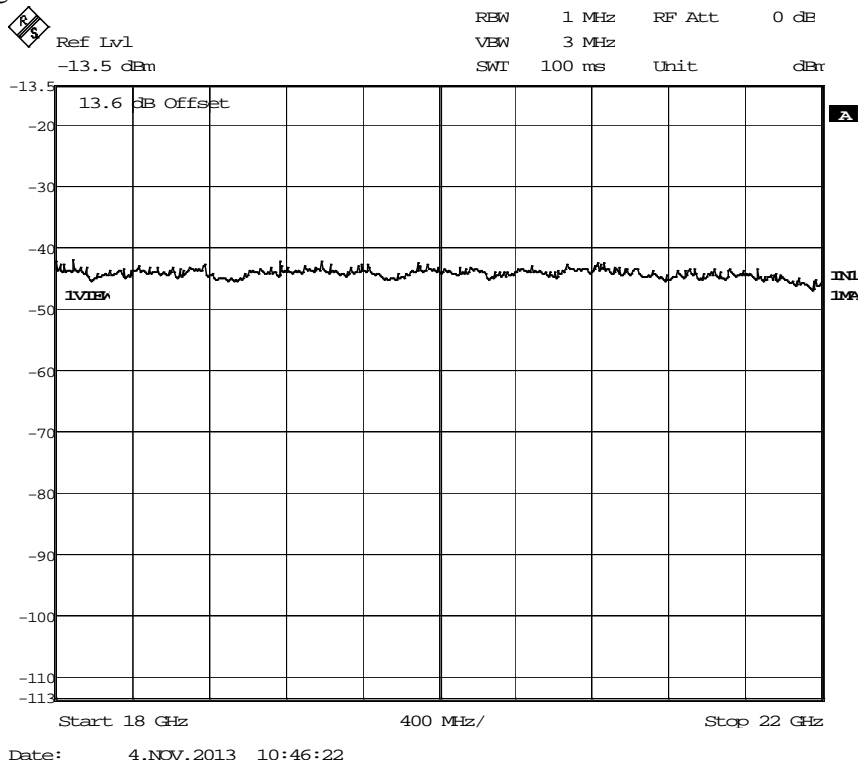

Diagram 1d:





Appendix 5

External photos

Front side



Rear side

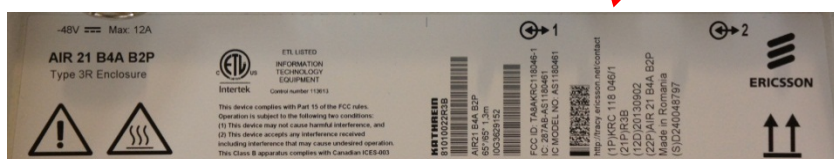

Appendix 5

Left side

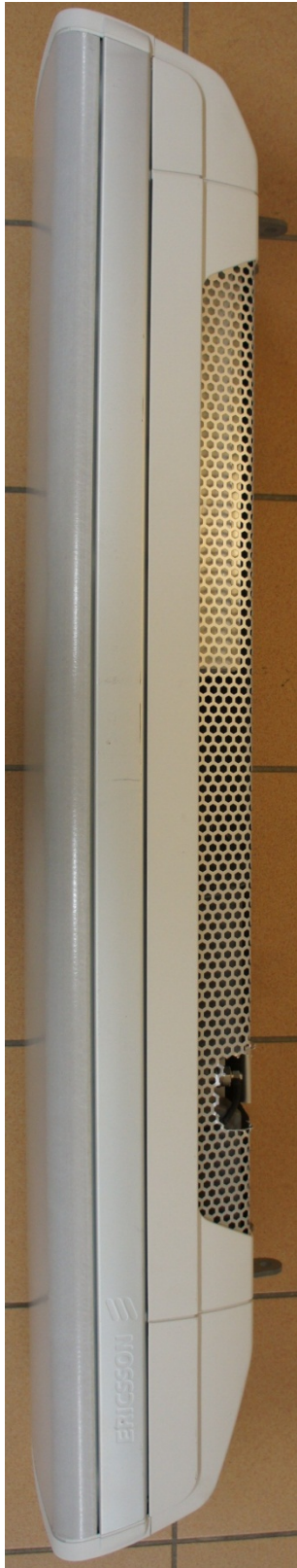

Right side



Appendix 5

Top side



Bottom side

