



RADIO TEST REPORT

Test Report No.: 14690768H-A

Customer	ASAHI DENSO CO.,LTD.
Description of EUT	CONTROL UNIT ASSY
Model Number of EUT	CZ197
FCC ID	T8VCZ197
Test Regulation	FCC Part 15 Subpart C
Test Result	Complied (Refer to SECTION 3)
Issue Date	April 3, 2023
Remarks	-

Representative test engineer

Tetsuro Yoshida
Engineer

Approved by

Shinichi Miyazono
Engineer



CERTIFICATE 5107.02

- The testing in which "Non-accreditation" is displayed is outside the accreditation scopes in UL Japan, Inc.
 There is no testing item of "Non-accreditation".

Report Cover Page - Form-ULID-003532 (DCS:13-EM-F0429) Issue# 21.0

ANNOUNCEMENT

- This test report shall not be reproduced in full or partial, without the written approval of UL Japan, Inc.
- The results in this report apply only to the sample tested. (Laboratory was not involved in sampling.)
- This sample tested is in compliance with the limits of the above regulation.
- The test results in this test report are traceable to the national or international standards.
- This test report must not be used by the customer to claim product certification, approval, or endorsement by the A2LA accreditation body.
- This test report covers Radio technical requirements.
It does not cover administrative issues such as Manual or non-Radio test related Requirements. (if applicable)
- The all test items in this test report are conducted by UL Japan, Inc. Ise EMC Lab.
- The opinions and the interpretations to the result of the description in this report are outside scopes where UL Japan, Inc. has been accredited.
- The information provided from the customer for this report is identified in Section 1.
- For test report(s) referred in this report, the latest version (including any revisions) is always referred.

REVISION HISTORY

Original Test Report No.: 14690768H-A

Revision	Test Report No.	Date	Page Revised Contents
- (Original)	14690768H-A	April 3, 2023	-

Reference: Abbreviations (Including words undescribed in this report)

A2LA	The American Association for Laboratory Accreditation	ICES	Interference-Causing Equipment Standard
AC	Alternating Current	IEC	International Electrotechnical Commission
AFH	Adaptive Frequency Hopping	IEEE	Institute of Electrical and Electronics Engineers
AM	Amplitude Modulation	IF	Intermediate Frequency
Amp, AMP	Amplifier	ILAC	International Laboratory Accreditation Conference
ANSI	American National Standards Institute	ISED	Innovation, Science and Economic Development Canada
Ant, ANT	Antenna	ISO	International Organization for Standardization
AP	Access Point	JAB	Japan Accreditation Board
ASK	Amplitude Shift Keying	LAN	Local Area Network
Atten., ATT	Attenuator	LIMS	Laboratory Information Management System
AV	Average	MCS	Modulation and Coding Scheme
BPSK	Binary Phase-Shift Keying	MRA	Mutual Recognition Arrangement
BR	Bluetooth Basic Rate	N/A	Not Applicable
BT	Bluetooth	NIST	National Institute of Standards and Technology
BT LE	Bluetooth Low Energy	NS	No signal detect.
BW	BandWidth	NSA	Normalized Site Attenuation
Cal Int	Calibration Interval	NVLAP	National Voluntary Laboratory Accreditation Program
CCK	Complementary Code Keying	OBW	Occupied Band Width
Ch., CH	Channel	OFDM	Orthogonal Frequency Division Multiplexing
CISPR	Comite International Special des Perturbations Radioelectriques	P/M	Power meter
CW	Continuous Wave	PCB	Printed Circuit Board
DBPSK	Differential BPSK	PER	Packet Error Rate
DC	Direct Current	PHY	Physical Layer
D-factor	Distance factor	PK	Peak
DFS	Dynamic Frequency Selection	PN	Pseudo random Noise
DQPSK	Differential QPSK	PRBS	Pseudo-Random Bit Sequence
DSSS	Direct Sequence Spread Spectrum	PSD	Power Spectral Density
EDR	Enhanced Data Rate	QAM	Quadrature Amplitude Modulation
EIRP, e.i.r.p.	Equivalent Isotropically Radiated Power	QP	Quasi-Peak
EMC	ElectroMagnetic Compatibility	QPSK	Quadri-Phase Shift Keying
EMI	ElectroMagnetic Interference	RBW	Resolution Band Width
EN	European Norm	RDS	Radio Data System
ERP, e.r.p.	Effective Radiated Power	RE	Radio Equipment
EU	European Union	RF	Radio Frequency
EUT	Equipment Under Test	RMS	Root Mean Square
Fac.	Factor	RSS	Radio Standards Specifications
FCC	Federal Communications Commission	Rx	Receiving
FHSS	Frequency Hopping Spread Spectrum	SA, S/A	Spectrum Analyzer
FM	Frequency Modulation	SG	Signal Generator
Freq.	Frequency	SVSWR	Site-Voltage Standing Wave Ratio
FSK	Frequency Shift Keying	TR	Test Receiver
GFSK	Gaussian Frequency-Shift Keying	Tx	Transmitting
GNSS	Global Navigation Satellite System	VBW	Video BandWidth
GPS	Global Positioning System	Vert.	Vertical
Hori.	Horizontal	WLAN	Wireless LAN

CONTENTS	PAGE
SECTION 1: Customer Information	5
SECTION 2: Equipment Under Test (EUT)	5
SECTION 3: Test specification, procedures & results	6
SECTION 4: Operation of EUT during testing	9
SECTION 5: Radiated emission (Fundamental and Spurious Emission)	10
SECTION 6: -20 dB Bandwidth	12
SECTION 7: 99 % emission bandwidth	12
APPENDIX 1: Test data	13
Radiated Emission (Fundamental and Spurious Emission).....	13
-20 dB Bandwidth / 99 % emission bandwidth	15
APPENDIX 2: Test instruments	17
APPENDIX 3: Photographs of test setup	18
Radiated Emission	18
Worst Case Position	19

SECTION 1: Customer Information

Company Name	ASAHI DENSO CO.,LTD.
Address	6-2-1 Somejidai, Hamakita-ku, Hamamatsu, Shizuoka 434-0046, Japan
Telephone Number	+81-53-586-7383
Contact Person	Hiroyuki Kawakami

The information provided from the customer is as follows;

- Customer, Description of EUT, Model Number of EUT, FCC ID on the cover and other relevant pages
 - Operating/Test Mode(s) (Mode(s)) on all the relevant pages
 - SECTION 1: Customer Information
 - SECTION 2: Equipment Under Test (EUT) other than the Receipt Date and Test Date
 - SECTION 4: Operation of EUT during testing
- * The laboratory is exempted from liability of any test results affected from the above information in SECTION 2 and 4.

SECTION 2: Equipment Under Test (EUT)

2.1 Identification of EUT

Description	CONTROL UNIT ASSY
Model Number	CZ197
Serial Number	Refer to SECTION 4.2
Condition	Production prototype (Not for Sale: This sample is equivalent to mass-produced items.)
Modification	No Modification by the test lab
Receipt Date	March 1, 2023
Test Date	March 9, 2023

2.2 Product Description

General Specification

Rating	DC 9.0 V to DC 30.0 V
--------	-----------------------

Radio Specification

Equipment Type	Transceiver
Frequency of Operation	134.2 kHz
Type of Modulation	ASK

SECTION 3: Test specification, procedures & results

3.1 Test Specification

Test Specification	FCC Part 15 Subpart C The latest version on the first day of the testing period
Title	FCC 47CFR Part15 Radio Frequency Device Subpart C Intentional Radiators Section 15.207 Conducted limits Section 15.209 Radiated emission limits; general requirements.

3.2 Procedures and results

Item	Test Procedure	Specification	Remarks	Deviation	Worst margin	Results
Conducted Emission	<FCC> ANSI C63.10:2013 6 Standard test methods <ISED> RSS-Gen 8.8	<FCC> Section 15.207 <ISED> RSS-Gen 8.8	-	N/A	N/A	N/A *1)
Electric Field Strength of Fundamental Emission	<FCC> ANSI C63.10:2013 6 Standard test methods <ISED> RSS-Gen 6.5, 6.12	<FCC> Section 15.209 <ISED> RSS-210 7.2 RSS-Gen 8.9	Radiated	N/A	19.3 dB 134.2 kHz, 0 deg. Peak with Duty factor	Complied a)
Electric Field Strength of Spurious Emission	<FCC> ANSI C63.10:2013 6 Standard test methods <ISED> RSS-Gen 6.5, 6.6, 6.13	<FCC> Section 15.209 <ISED> RSS-210 7.3 RSS-Gen 8.9	Radiated	N/A	6.8 dB 53.684 MHz, Vertical, QP	Complied a)
-20 dB Bandwidth	<FCC> ANSI C63.10:2013 6 Standard test methods <ISED> -	<FCC> Reference data <ISED> -	Radiated	N/A	N/A	Complied b)

Note: UL Japan, Inc.'s EMI Work Procedures: Work Instructions-ULID-003591 and Work Instructions-ULID-003593.

*1) The test is not applicable since the EUT is not the device that is designed to be connected to the public utility (AC) power line.

a) Refer to APPENDIX 1 (data of Radiated emission)

b) Refer to APPENDIX 1 (data of -20 dB Bandwidth / 99 % emission bandwidth)

FCC Part 15.31 (e)

The EUT provides stable voltage constantly to the wireless transmitter regardless of input voltage.

Instead of a new battery, DC power supply was used for the test.

That does not affect the test result, therefore the EUT complies with the requirement.

FCC Part 15.203 Antenna requirement

It is impossible for end users to replace the antenna, because the antenna is mounted inside of the vehicle.

Therefore, the equipment complies with the antenna requirement of Section 15.203.

3.3 Addition to standard

Item	Test Procedure	Specification	Remarks	Deviation	Worst margin	Results
99 % emission bandwidth	RSS-Gen 6.7	-	Radiated	N/A	N/A	-

Other than above, no addition, exclusion nor deviation has been made from the standard.

3.4 Uncertainty

Measurement uncertainty is not taken into account when stating conformity with a specified requirement.

Note: When margins obtained from test results are less than the measurement uncertainty, the test results may exceed the limit.

The following uncertainties have been calculated to provide a confidence level of 95 % using a coverage factor $k=2$.

Test Item		Frequency range		Uncertainty (+/-)
Conducted emission AMN (LISN)		0.15 MHz to 30 MHz		3.3 dB
Radiated emission	3 m	9 kHz to 30 MHz		3.2 dB
	10 m			3.0 dB
	3 m	30 MHz to 200 MHz	Horizontal	4.8 dB
			Vertical	5.0 dB
		200 MHz to 1000 MHz	Horizontal	5.1 dB
			Vertical	6.2 dB
	10 m	30 MHz to 200 MHz	Horizontal	4.8 dB
			Vertical	4.8 dB
		200 MHz to 1000 MHz	Horizontal	5.0 dB
			Vertical	5.0 dB
	3 m	1 GHz to 6 GHz	4.9 dB	
		6 GHz to 18 GHz	5.2 dB	
	1 m	10 GHz to 26.5 GHz	5.4 dB	
26.5 GHz to 40 GHz		5.4 dB		
10 m	1 GHz to 18 GHz	5.4 dB		
-20 dB Bandwidth / 99 % emission bandwidth		-		0.96 %

3.5 Test Location

UL Japan, Inc. Ise EMC Lab.

*A2LA Certificate Number: 5107.02 / FCC Test Firm Registration Number: 884919

ISED Lab Company Number: 2973C / CAB identifier: JP0002

4383-326 Asama-cho, Ise-shi, Mie-ken 516-0021 Japan

Telephone: +81-596-24-8999

Test site	Width x Depth x Height (m)	Size of reference ground plane (m) / horizontal conducting plane	Other rooms	Maximum measurement distance
No.1 semi-anechoic chamber	19.2 x 11.2 x 7.7	7.0 x 6.0	No.1 Power source room	10 m
No.2 semi-anechoic chamber	7.5 x 5.8 x 5.2	4.0 x 4.0	-	3 m
No.3 semi-anechoic chamber	12.0 x 8.5 x 5.9	6.8 x 5.75	No.3 Preparation room	3 m
No.3 shielded room	4.0 x 6.0 x 2.7	N/A	-	-
No.4 semi-anechoic chamber	12.0 x 8.5 x 5.9	6.8 x 5.75	No.4 Preparation room	3 m
No.4 shielded room	4.0 x 6.0 x 2.7	N/A	-	-
No.5 semi-anechoic chamber	6.0 x 6.0 x 3.9	6.0 x 6.0	-	-
No.5 measurement room	6.4 x 6.4 x 3.0	6.4 x 6.4	-	-
No.6 shielded room	4.0 x 4.5 x 2.7	4.0 x 4.5	-	-
No.6 measurement room	4.75 x 5.4 x 3.0	4.75 x 4.15	-	-
No.7 shielded room	4.7 x 7.5 x 2.7	4.7 x 7.5	-	-
No.8 measurement room	3.1 x 5.0 x 2.7	3.1 x 5.0	-	-
No.9 measurement room	8.8 x 4.6 x 2.8	2.4 x 2.4	-	-
No.10 shielded room	3.8 x 2.8 x 2.8	3.8 x 2.8	-	-
No.11 measurement room	4.0 x 3.4 x 2.5	N/A	-	-
No.12 measurement room	2.6 x 3.4 x 2.5	N/A	-	-
Large Chamber	16.9 x 22.1 x 10.17	16.9 x 22.1	-	10 m
Small Chamber	5.3 x 6.69 x 3.59	5.3 x 6.69	-	-

3.6 Test data, Test instruments, and Test set up

Refer to APPENDIX.

SECTION 4: Operation of EUT during testing

4.1. Operating Mode(s)

Test mode	Remarks
1) Transmitting mode	-
<p>*Power of the EUT was set by the software as follows; Software: CZ197-860 Version: 1.00 (Date: 2023.01.20, Storage location: EUT memory)</p> <p>*This setting of software is the worst case. Any conditions under the normal use do not exceed the condition of setting. In addition, end users cannot change the settings of the output power of the product.</p> <p>Justification: The system was configured in typical fashion (as a user would normally use it) for testing.</p>	

*This EUT has two modes which transponder key is inserted or not. The worst case was confirmed with and without transponder key inserted, as a result, the test without transponder key inserted was the worst case. Therefore the test without transponder key inserted was performed only.

4.2. Configuration and peripherals

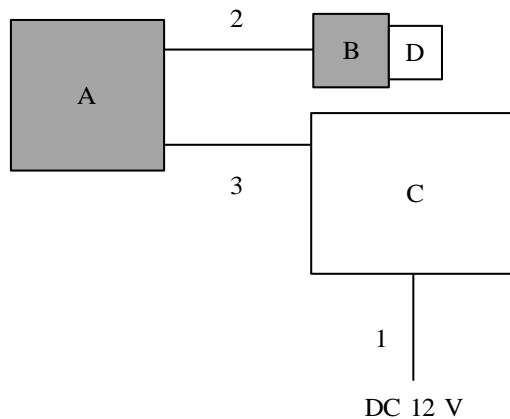

* Cabling and setup(s) were taken into consideration and test data was taken under worse case conditions.

* As a result of comparing DC 12 V and DC 24 V at pre-check, the test was performed with DC 12 V of the worst voltage as representative.

Description of EUT and Support equipment

No.	Item	Model number	Serial number	Manufacturer	Remarks
A	CONTROL UNIT ASSY	CZ197	322801	ASAHI DENSO CO.,LTD.	EUT
B	Antenna Unit	CZ198-082	15Y2	ASAHI DENSO CO.,LTD.	EUT
C	Jig	-	-	-	-
D	Immobilizer Key	CZ197-902X	322802	ASAHI DENSO CO.,LTD.	-

List of cables used

No.	Name	Length (m)	Shield		Remarks
			Cable	Connector	
1	DC Cable	2.6	Unshielded	Unshielded	-
2	Signal Cable	0.7	Unshielded	Unshielded	-
3	Signal Cable	2.0	Unshielded	Unshielded	-

SECTION 5: Radiated emission (Fundamental and Spurious Emission)

Test Procedure

EUT was placed on a urethane platform of nominal size, 1.0 m by 1.5 m, raised 0.8 m above the conducting ground plane.

The Radiated Electric Field Strength has been measured in a Semi Anechoic Chamber with a ground plane.

[Limit conversion]

The limits in CFR 47, Part 15, Subpart C, paragraph 15.209(a), are identical to those in RSS-Gen section 8.9, Table 6, since the measurements are performed in terms of magnetic field strength and converted to electric field strength levels (as reported in the table) using the free space impedance of 377 Ohms. For example, the measurement at frequency 9 kHz resulted in a level of 45.5 dBuV/m, which is equivalent to 45.5 - 51.5 = -6.0 dBuA/m, which has the same margin, 3 dB, to the corresponding RSS-Gen Table 6 limit as it has to 15.209(a) limit.

[Frequency: From 9 kHz to 30 MHz]

The EUT was rotated a full revolution in order to obtain the maximum value of the electric field intensity.

The measurements were performed for vertical polarization (antenna angle: 0 deg., 45 deg., 90 deg., and 135 deg.) and horizontal polarization.

*Refer to Figure 22 about Direction of the Loop Antenna.

Although these tests were performed other than open field test site, adequate comparison measurements were confirmed against 30 m open field test site. Therefore, sufficient tests were made to demonstrate that the alternative site produces results that correlate with the ones of tests made in an open field based on KDB 414788.

These tests were performed in semi anechoic chamber. Therefore, the measured level of emissions may be higher than if measurements were made without a ground plane. However, test results were confirmed to pass against standard limit.

[Frequency: From 30 MHz to 1 GHz]

The measuring antenna height varied between 1 and 4 m and EUT was rotated a full revolution in order to obtain the maximum value of the electric field intensity.

The measurements were performed for both vertical and horizontal antenna polarization.

[Test instruments and test settings]

Frequency	Below 30 MHz	30 MHz to 200 MHz	200 MHz to 1 GHz
Antenna Type	Loop	Biconical	Logperiodic

The test was made with the detector (RBW/VBW) in the following table.

When using Spectrum analyzer, the test was made with adjusting span to zero by using peak hold.

Frequency	From 9 kHz to 90 kHz and From 110 kHz to 150 kHz	From 90 kHz to 110 kHz	From 150 kHz to 490 kHz	From 490 kHz to 30 MHz	From 30 MHz to 1 GHz
Instrument used	Test Receiver				
Detector	PK / AV	QP	PK / AV	QP	QP
IF Bandwidth	200 Hz	200 Hz	9 kHz	9 kHz	120 kHz
Test Distance	3 m *1)	3 m *1)	3 m *1)	3 m *2)	3 m

*1) Distance Factor: $40 \times \log(3 \text{ m} / 300 \text{ m}) = -80 \text{ dB}$

*2) Distance Factor: $40 \times \log(3 \text{ m} / 30 \text{ m}) = -40 \text{ dB}$

Figure 1: Test Setup

Below 1 GHz

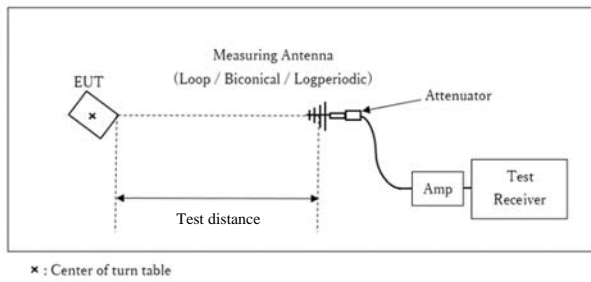

Test Distance: 3 m

Figure 2: Direction of the Loop Antenna

Side View (Vertical)

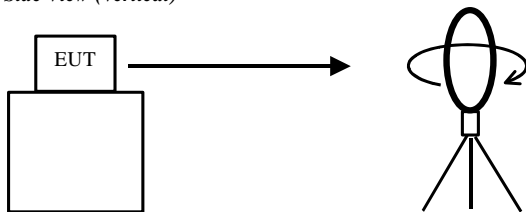

Top View (Horizontal)

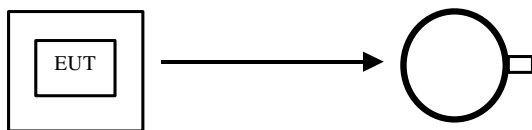

Antenna was not rotated.

Top View (Vertical)

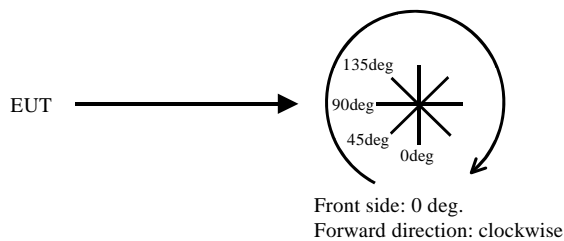

- The carrier level and noise levels were confirmed at each position of X, Y and Z axes of EUT to see the position of maximum noise, and the test was made at the position that has the maximum noise.

The test results and limit are rounded off to one decimal place, so some differences might be observed.

Measurement range : 9 kHz to 1 GHz
Test data : APPENDIX
Test result : Pass

SECTION 6: -20 dB Bandwidth

Test Procedure

The test was measured with a spectrum analyzer.

Test	Span	RBW	VBW	Sweep	Detector	Trace	Instrument used
-20 dB Bandwidth	Enough width to display emission skirts	1 to 5 % of OBW	Three times of RBW	Auto	Peak	Max Hold	Spectrum Analyzer

Test data : APPENDIX
Test result : Pass

SECTION 7: 99 % emission bandwidth

Test Procedure

The test was measured with a spectrum analyzer.

Test	Span	RBW	VBW	Sweep	Detector	Trace	Instrument used
99 % emission bandwidth	Enough width to display emission skirts	1 to 5 % of OBW	Three times of RBW	Auto	Peak	Max Hold	Spectrum Analyzer

Peak hold was applied as Worst-case measurement.

Test data : APPENDIX
Test result : Pass

APPENDIX 1: Test data

Radiated Emission (Fundamental and Spurious Emission)

Test place Ise EMC Lab.
Semi Anechoic Chamber No.3
Date March 9, 2023
Temperature / Humidity 20 deg. C / 33 % RH
Engineer Tetsuro Yoshida
Mode Mode 1

PK or QP

Ant Deg [deg] or Polarity [Hori/Vert]	Frequency [MHz]	Detector	Reading [dBuV]	Ant Factor [dB/m]	Loss [dB]	Gain [dB]	Duty Factor [dB]	Result [dBuV/m]	Limit [dBuV/m]	Margin [dB]	Remark
Odeg	0.13420	PK	92.9	19.1	-74.1	32.2	-	5.7	45.0	39.3	Fundamental
Odeg	0.26840	PK	34.7	19.1	-64.3	32.2	-	-42.7	39.0	81.7	
Odeg	0.40260	PK	44.0	19.0	-64.4	32.2	-	-33.6	35.5	69.1	
Odeg	0.53680	QP	24.2	19.0	-24.4	32.2	-	-13.4	33.0	46.4	
Odeg	0.67100	QP	28.1	19.1	-24.4	32.2	-	-9.4	31.1	40.5	
Odeg	0.80520	QP	22.3	19.1	-24.3	32.2	-	-15.1	29.5	44.6	
Odeg	0.93940	QP	31.5	19.1	-24.3	32.2	-	-5.9	28.1	34.0	
Odeg	1.07360	QP	22.0	19.0	-24.3	32.2	-	-15.5	26.9	42.4	
Odeg	1.20780	QP	26.9	19.1	-24.3	32.2	-	-10.5	25.9	36.4	
Odeg	1.34200	QP	21.4	19.1	-24.3	32.2	-	-16.0	25.0	41.0	
Hori.	39.288	QP	30.9	15.1	7.2	32.2	-	21.0	40.0	19.0	
Hori.	53.684	QP	34.9	9.9	7.4	32.2	-	20.0	40.0	20.0	
Hori.	96.067	QP	38.7	9.6	8.0	32.1	-	24.2	43.5	19.3	
Hori.	128.089	QP	39.1	13.6	8.4	32.1	-	29.0	43.5	14.5	
Hori.	208.150	QP	38.3	11.3	9.2	32.0	-	26.8	43.5	16.7	
Hori.	224.150	QP	35.0	11.6	9.4	32.0	-	24.0	46.0	22.0	
Vert.	39.288	QP	39.4	15.1	7.2	32.2	-	29.5	40.0	10.5	
Vert.	53.684	QP	48.1	9.9	7.4	32.2	-	33.2	40.0	6.8	
Vert.	96.067	QP	47.6	9.6	8.0	32.1	-	33.1	43.5	10.4	
Vert.	128.089	QP	43.6	13.6	8.4	32.1	-	33.5	43.5	10.0	
Vert.	208.150	QP	43.5	11.3	9.2	32.0	-	32.0	43.5	11.5	
Vert.	224.150	QP	41.1	11.6	9.4	32.0	-	30.1	46.0	15.9	

Result = Reading + Ant Factor + Loss (Cable + Attenuator + D.Factor) - Gain(Amplifier)

PK with Duty factor

Ant Deg [deg] or Polarity [Hori/Vert]	Frequency [MHz]	Detector	Reading [dBuV]	Ant Factor [dB/m]	Loss [dB]	Gain [dB]	Duty Factor [dB]	Result [dBuV/m]	Limit [dBuV/m]	Margin [dB]	Remark
Odeg	0.13420	PK	92.9	19.1	-74.1	32.2	0.0	5.7	25.0	19.3	Fundamental
Odeg	0.26840	PK	34.7	19.1	-64.3	32.2	0.0	-42.7	19.0	61.7	
Odeg	0.40260	PK	44.0	19.0	-64.4	32.2	0.0	-33.6	15.5	49.1	

Result = Reading + Ant Factor + Loss (Cable + Attenuator + D.Factor) - Gain(Amplifier) + Duty factor *

* Since the peak emission result satisfied the average limit, duty factor was omitted.

Result of the fundamental emission at 3 m without Distance factor

Ant Deg [deg]	Frequency [MHz]	Detector	Reading [dBuV]	Ant Factor [dB/m]	Loss [dB]	Gain [dB]	Duty Factor [dB]	Result [dBuV/m]	Limit [dBuV/m]	Margin [dB]	Remark
Odeg	0.13420	PK	92.9	19.1	5.9	32.2	-	85.7	-	-	Fundamental

Result = Reading + Ant Factor + Loss (Cable+Attenuator) - Gain(Amplifier)

If Gain 0.0dB shown in the above table, pre-amplifier was not used to avoid the influence of carrier power.
The pre-amplifier used for carrier frequency measurement was not saturated.
Other frequency noises omitted in this report were not seen or had enough margin (more than 20 dB).

Radiated Spurious Emission (Plot data, Worst case for Spurious Emission)

Test place	Ise EMC Lab.
Semi Anechoic Chamber	No.3
Date	March 9, 2023
Temperature / Humidity	20 deg. C / 33 % RH
Engineer	Tetsuro Yoshida
Mode	Mode 1

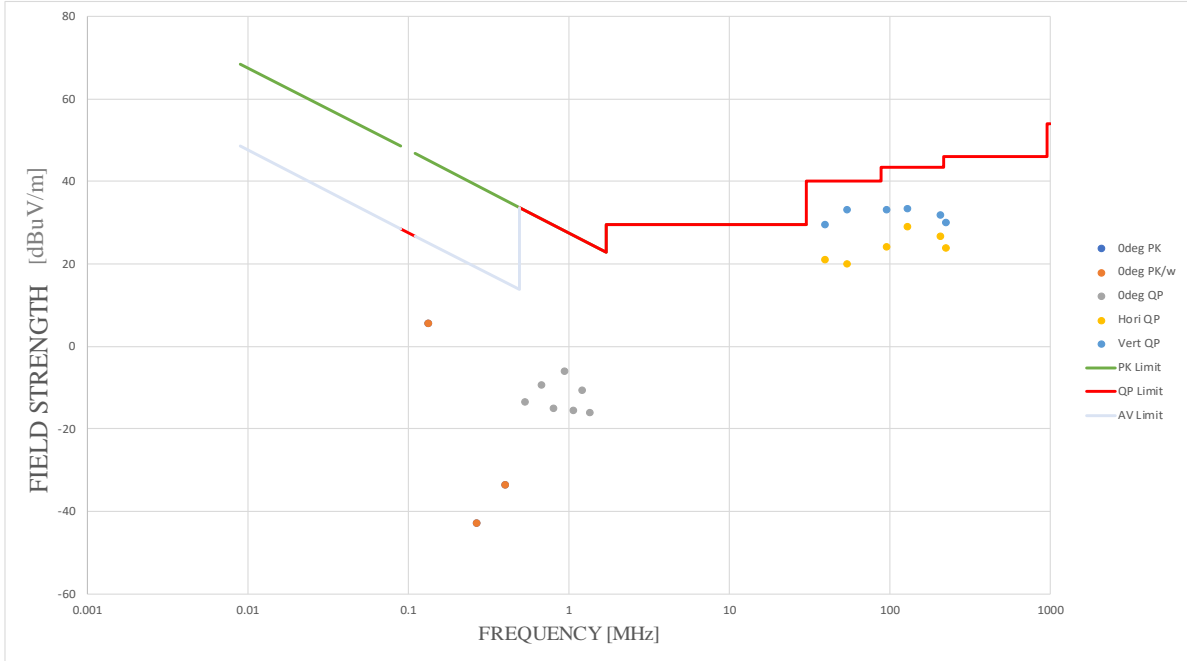

-20 dB Bandwidth / 99 % emission bandwidth

Test place Ise EMC Lab.
Semi Anechoic Chamber No.3
Date March 9, 2023
Temperature / Humidity 20 deg. C / 33 % RH
Engineer Tetsuro Yoshida
Mode With transponder key

-20 dB Bandwidth [kHz]	99 % emission bandwidth [kHz]
7.866	10.3895

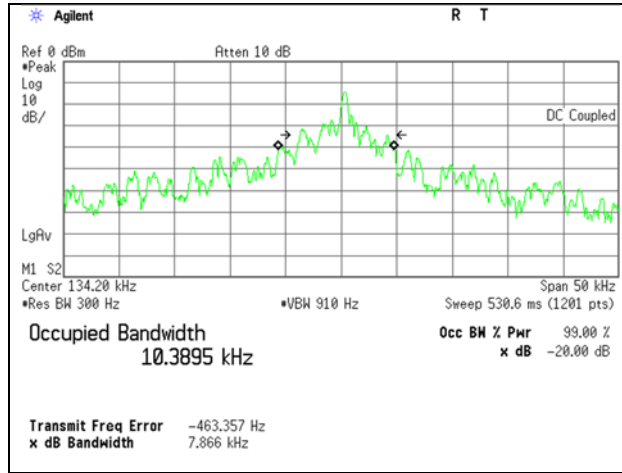

-20 dB Bandwidth / 99 % emission bandwidth

Test place Ise EMC Lab.
Semi Anechoic Chamber No.3
Date March 9, 2023
Temperature / Humidity 20 deg. C / 33 % RH
Engineer Tetsuro Yoshida
Mode Without transponder key

-20 dB Bandwidth [kHz]	99 % emission bandwidth [kHz]
6.147	10.4687

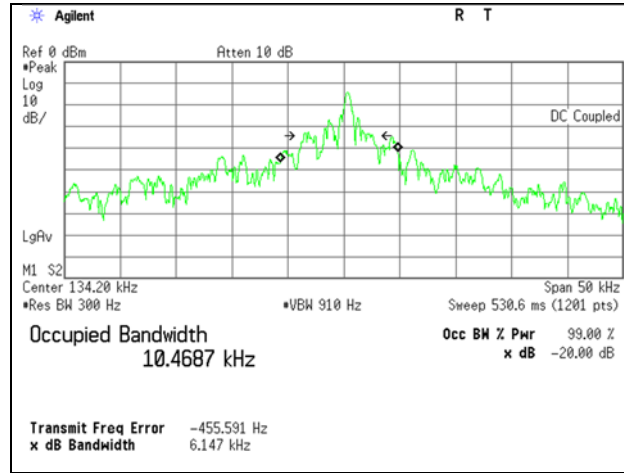

APPENDIX 2: Test instruments

Test equipment

Test Item	Local ID	LIMS ID	Description	Manufacturer	Model	Serial	Last Calibration Date	Cal Int
RE	COTS-MEMI-02	178648	EMI measurement program	TSJ (Techno Science Japan)	TEPTO-DV	-	-	-
RE	MAEC-03	142008	AC3_Semi Anechoic Chamber(NSA)	TDK	Semi Anechoic Chamber 3m	DA-10005	05/23/2022	24
RE	MAT-95	142314	Attenuator	Pasternack Enterprises	PE7390-6	D/C 1504	06/13/2022	12
RE	MBA-05	141425	Biconical Antenna	Schwarzbeck Mess-Elektronik OHG	VHA9103+ BBA9106	VHA 91031302	08/26/2022	12
RE	MCC-112	141216	Coaxial cable	Fujikura/Suhner/TSJ	5D-2W/SFM14/ sucoform141-PE/ 421-010/ RFM-E321(SW)	-/00640	07/09/2022	12
RE	MCC-255	207745	Coaxial Cable	UL Japan	-	-	05/17/2022	12
RE	MCC-51	141323	Coaxial cable	UL Japan	-	-	09/27/2022	12
RE	MHF-24	141295	High Pass Filter 0.15-30MHz	Rohde & Schwarz	EZ-25/3	100041	02/01/2023	12
RE	MJM-16	142183	Measure	KOMELON	KMC-36	-	10/03/2022	12
RE	MLA-22	141266	Logperiodic Antenna (200-1000MHz)	Schwarzbeck Mess-Elektronik OHG	VUSLP9111B	9111B-191	08/26/2022	12
RE	MLPA-01	141254	Loop Antenna	Rohde & Schwarz	HFH2-Z2	100017	05/31/2022	12
RE	MMM-08	141532	DIGITAL HiTESTER	HIOKI E.E. CORPORATION	3805	51201197	01/17/2023	12
RE	MOS-13	141554	Thermo-Hygrometer	CUSTOM. Inc	CTH-201	1301	01/13/2023	12
RE	MPA-13	141582	Pre Amplifier	SONOMA INSTRUMENT	310	260834	02/07/2023	12
RE	MSA-16	141903	Spectrum Analyzer	Keysight Technologies Inc	E4440A	MY46186390	01/16/2023	12
RE	MTR-08	141949	Test Receiver	Rohde & Schwarz	ESCI	100767	07/29/2022	12

***Hyphens for Last Calibration Date and Cal Int (month) are instruments that Calibration is not required (e.g. software), or instruments checked in advance before use.**

The expiration date of the calibration is the end of the expired month.

As for some calibrations performed after the tested dates, those test equipment have been controlled by means of an unbroken chains of calibrations.

All equipment is calibrated with valid calibrations. Each measurement data is traceable to the national or international standards.

Test item: RE: Radiated Emission