

# TEXA eTRUCK



MANUALE TECNICO  
TECHNICAL MANUAL  
MANUEL TECHNIQUE  
TECHNISCHE BEDIENUNGSANLEITUNG  
MANUAL TECNICO  
MANUAL TECNICO  
INSTRUKCJA OBSŁUGI TECHNICZNEJ  
ТЕХНИЧЕСКОЕ РУКОВОДСТВО

Rev.01

**TEXA**



# SUMMARY

REVISION OF THE MANUAL.....	5
INTRODUCTION.....	6
1 LEGEND OF THE SYMBOLS USED.....	7
2 GLOSSARY.....	8
3 GENERAL SAFETY REGULATIONS.....	9
3.1 Glossary.....	9
3.2 Operator Safety Regulations.....	9
3.2.1 General Safety Regulations.....	9
3.2.2 Risk of Asphyxiation.....	9
3.2.3 Risk of Impact and Crushing.....	9
3.2.4 Hazards Caused by Moving Parts.....	10
3.2.5 Risk of Burning or Scalding.....	10
3.2.6 Fire and Explosion Hazard.....	11
3.2.7 Noise Hazard.....	11
3.2.8 High Voltage Hazard.....	11
3.2.9 Poisoning Hazard.....	12
3.3 General User and Maintenance Warnings.....	12
4 SPECIFIC USER SAFETY RULES FOR TEXA eTRUCK.....	13
4.1 General Rules.....	13
4.2 User Safety.....	13
4.3 Vehicle Safety.....	13
4.4 Device Safety.....	14
5 ENVIRONMENTAL INFORMATION.....	16
6 OPERATION OF THE RADIO DEVICES.....	17
7 REGULATORY INFORMATION.....	18
8 TEXA eTRUCK.....	19
9 DESCRIPTION.....	20
10 TECHNICAL FEATURES .....	21
11 INSTALLATION AND CONFIGURATION.....	23
11.1 Preliminary operations.....	23

11.2	Configuration through the App.....	23
11.3	Installation in the Vehicle.....	24
11.3.1	Installation through 9-pin Deutsch Adapter.....	24
12	eTRUCK INSTALLATION KIT FOR VOLVO EURO IV-V (ACCESSORY).....	26
13	USE.....	32
14	POWER SUPPLY .....	32
15	BLINK CODES.....	33
16	MAINTENANCE.....	34
17	TROUBLESHOOTING.....	35
18	LEGAL NOTICES.....	36

## **REVISION OF THE MANUAL**

This document is **revision 01** of the **TEXA eTRUCK technical manual**.

**Issue date:** 11/10/2017

# INTRODUCTION

Dear Customer,

We would like to thank you for choosing a TEXA product for your workshop.

We are certain that you will get the greatest satisfaction from it and receive a great deal of help in your work.

Please read through the instructions in this manual carefully and keep it for future reference.

Reading and understanding the following manual will help you to avoid damage or personal injury caused by improper use of the product to which it refers.

TEXA S.p.A reserves the right to make any changes deemed necessary to improve the manual for any technical or marketing requirement; the company may do so at any time without prior notice.

This product is intended for use by technicians specialised in the automotive field only. Reading and understanding the information in this manual cannot replace adequate specialised training in this field.

The sole purpose of the manual is to illustrate the operation of the product sold. It is not intended to offer technical training of any kind and technicians will therefore carry out any interventions under their own responsibility and will be accountable for any damage or personal injury caused by negligence, carelessness, or inexperience, regardless of the fact that a TEXA S.p.A. tool has been used based on the information within this manual.

Any additions to this manual, useful in describing the new versions of the program and the new functions associated to it, may be sent to you through our TEXA technical bulletin service.

This manual is to be considered an essential part of the product it refers to. If it is resold, the original buyer is therefore required to forward the manual to the new owner.











Reproduction, whole or in part, of this manual in any form without written authorisation by the manufacturer is strictly forbidden.

The original manual was written in Italian, every other language is a translation of the original manual.

© **copyright and database rights 2018.** The material contained in this document is protected by copyright and database rights. All rights reserved by Law and under International Conventions.

# 1 LEGEND OF THE SYMBOLS USED

The symbols used in the manual are described in this chapter.

	Asphyxiation Risk
	Explosion Risk
	High Voltage Hazard
	Fire / Burn risk
	Poisoning Hazard
	Corrosive Substances Risk
	Noise Hazard
	Moving Parts Risk
	Crushing Risk
	General Risk
	Important information

## 2 GLOSSARY

This chapter provides the meaning of the technical terms used in the manual:

- **Device:** *any TEXA eTRUCK device.*
- **WORKSHOP:** *the workshop that sells and installs TEXA eTRUCK devices.*
- **FLEET MANAGER:** *the manager of the vehicle fleet who subscribed the Fleet Contract in order to use the services associated with TEXA eTRUCK.*
- **DRIVER:** *the driver of a vehicle of the fleet.*
- **Fleet:** *the group of vehicles managed by the FLEET MANAGER, where TEXA eTRUCK is installed.*
- **TEXA eTRUCK FLEET MANAGER WEB Portal:** *the WEB portal owned by TEXA through which the FLEET MANAGER can view the data related to the vehicles of her/his fleet.*
- **TEXA eTRUCK WORKSHOP WEB Portal:** *the WEB portal owned by TEXA through which the WORKSHOP can view the data related to the vehicles of its customers.*
- **Coverage list:** *the official document that indicates only the vehicles on which you can safely install the device.*
- **16-pin OBD socket:** *the diagnostic socket specific for European EURO 4, EURO 5, EURO 6 vehicles, some American heavy duty vehicles and for light commercial vehicles.*
- **9-pin Deutsch OBD socket:** *the diagnostic socket specific for American heavy duty vehicles.*
- **Pairing:** *the mutual recognition process that takes place when two Bluetooth devices must establish communication for the first time. It could require you to enter an identification code (PIN).*



## 3 GENERAL SAFETY REGULATIONS

### 3.1 Glossary

- **Operator:** *qualified individual, in charge of using the device / tool.*
- **Equipment / device / tool:** *the purchased product.*
- **Workplace:** *the place where the operator must carry out her/his work.*

### 3.2 Operator Safety Regulations

#### 3.2.1 General Safety Regulations

- *The operator must be completely clear-headed and sober when using the device; taking drugs or alcohol before or when operating the device is strictly forbidden.*
- *The operator must not smoke during device operation.*
- *The operator must carefully read all the information and instructions in the technical documents provided with the device.*
- *The operator must follow all the instructions provided in the technical documents.*
- *The operator must always watch over the device during the various operating phases.*
- *The operator must make sure she/he is working in an environment which is suitable for the operations that must be carried out.*
- *The operator must report any faults or potentially hazardous situation in connection with the workplace or the device.*
- *The operator must carefully follow the safety regulations required for the workplace in which she/he is working and required by the operations she/he has been asked to carry out.*

#### 3.2.2 Risk of Asphyxiation

	<p>Exhaust gases from internal combustion engines, whether petrol or diesel, are hazardous to your health and can cause serious harm to your body.</p>
---	--

#### Safety Precautions:

- *The workplace must be equipped with an appropriate ventilation and air extraction system and must be in compliance with standards according to current national laws.*
- *Always activate the air extraction system when working in closed environments.*

#### 3.2.3 Risk of Impact and Crushing

	<p>The vehicles which are undergoing A/C system recharging operations and the devices must be properly blocked using the specific mechanical brakes/blocks while being serviced.</p>
---	--

### Safety Precautions:

- *Always make sure that the vehicle is in neutral gear (or that it is set in parking position in case of a vehicle equipped with automatic transmission).*
- *Always activate the hand brake or parking brake on the vehicle.*
- *Always block the wheels on the vehicle with the specific mechanical blocks.*
- *Make sure the device is stable, on a flat surface and that the wheels are locked with the specific mechanical blocks.*



#### 3.2.4 Hazards Caused by Moving Parts

	Vehicle engines include parts that move, both while running and not running (e.g.: the cooling fan is controlled by a thermal switch in connection with the coolant temperature and can be activated even when the vehicle is off), that can injure the operator.
---	---

### Safety Precautions:

- *Keep hands away from moving parts.*
- *Disconnect the engine cooling fan each time the engine you are working on is still hot. This will avoid the fan from becoming activated unexpectedly even when the engine is off.*
- *Do not wear ties, loose clothes, wrist jewellery or watches when working on a vehicle.*
- *Keep connection cables, probes and similar devices away from the moving parts of the engine.*

#### 3.2.5 Risk of Burning or Scalding

 	The parts that are exposed to high temperatures in engines that are moving or have just stopped could burn the operator. Remember that catalytic mufflers reach very high temperatures, able to cause serious burns or even start fires. Acid in the vehicle batteries is another potential hazard.
--	---

### Safety Precautions:

- *Protect your face, hands, and feet by using suitable protection.*
- *Avoid contact with hot surfaces, such as spark plugs, exhaust pipes, radiators and connections within the cooling system.*
- *Make sure there are no oil stains, rags, paper or other inflammable material near the muffler.*
- *Avoid splashing electrolyte onto your skin, eyes and clothes, as it is a corrosive and highly toxic compound.*

### 3.2.6 Fire and Explosion Hazard

	<p>The following are potential fires and / or explosion hazards:</p> <ul style="list-style-type: none"> <li>• <i>The types of fuel used by the vehicle and the vapours released by these fuels.</i></li> <li>• <i>The refrigerants used by the A/C system.</i></li> <li>• <i>The acid in the vehicle batteries.</i></li> </ul>
---	--

#### Safety Precautions:

- *Let the engine cool down.*
- *Do NOT smoke near the vehicle.*
- *Do NOT expose the vehicle to open flames.*
- *Make sure that the electrical connections are all well insulated.*
- *Collect any fuel that might have spilled.*
- *Collect any refrigerant that might have spilled.*
- *Make sure you are always working in an environment equipped with a good ventilation and air extraction system.*
- *Always activate the air extraction system when working in closed environments.*
- *Cover the openings of the batteries with a wet cloth in order to stifle the explosive gases before proceeding in testing or recharging.*
- *Avoid causing sparks when connecting cables to the battery.*

### 3.2.7 Noise Hazard

	<p>Loud noises that may occur within the workplace, especially during service operations, may damage the operator's hearing.</p>
---	--

#### Safety Precautions:

- *Protect your ears with suitable protective ear wear.*

### 3.2.8 High Voltage Hazard

	<p>The voltage supply from the mains that powers the devices in the workplace and the voltage within the vehicle starter system is a potential shock hazard to the operator.</p>
---	--

#### Safety Precautions:

- *Make sure the electrical system in the workplace is compliant to current national standards.*
- *Make sure the device being used is connected to ground.*
- *Cut off the power supply voltage before connecting or disconnecting cables.*
- *Do NOT touch the high voltage cables when the engine is on.*

- *Operate in conditions of insulation from ground.*
- *Work with dry hands only.*
- *Keep conductive liquids away from the engine while working.*
- *Never leave tools on the battery in order to avoid accidental contacts.*

### 3.2.9 Poisoning Hazard

	<p>The hoses used to extract the gases can release toxic gases, dangerous to the operator if exposed to temperatures higher than 250 °C or in case of a fire.</p>
---	---

#### **Safety Precautions:**

- *Should you inhale these gases, seek medical advice immediately.*
- *Use neoprene or PVC gloves when eliminating combustion deposits.*

### **3.3 General User and Maintenance Warnings**

When using the device or carrying out ordinary maintenance (e.g. fuse replacement) on the device, carefully follow the information provided below.

- *Do not remove or damage the labels/tags and the warnings on the device; do NOT in any case make them illegible.*
- *Do not remove, or block, any safety devices the device is equipped with.*
- *Only use original spare parts or spare parts approved by the manufacturer.*
- *Contact your retailer for any extraordinary maintenance.*
- *Periodically check the electrical connections of the device, making sure they are in good condition and replacing any damaged cables.*
- *Periodically check parts that are subject to wear and replace them if necessary.*
- *Do not open or disassemble the device.*

## 4 SPECIFIC USER SAFETY RULES FOR TEXA eTRUCK

The technology used for the design and manufacturing control of **TEXA eTRUCK** makes it a reliable, simple and safe device to use.

Users of **TEXA eTRUCK** are required to follow the general safety rules, to use the device for its intended use only and to take care of it as indicated in this manual.

### 4.1 General Rules

- *The user must have carefully read all the information and instructions indicated in the technical documents provided with the device.*

### 4.2 User Safety

	The device was designed and created in order to allow an easy, fast and safe installation; nevertheless, it is impossible to completely eliminate some of the risks connected to this operation.
---	--

#### Safety Measures:

- *Make sure the vehicle's instrument panel is off before starting the installation.*
- *Make sure the vehicle on which you wish to install the device is on a flat surface and with the parking brake engaged.*
- *Make sure there are not any damaged cables around the diagnostic socket.*
- *Be careful not to injure yourself on sharp plastic edges or metal plates around the diagnostic socket.*

	The position in which the device is placed and the behaviour of its LEDs were designed to avoid any possible obstacle or interference for the driver. Lack of concentration while driving puts both the driver and the vehicle in danger.
---	--

#### Safety Measures:

- *Do not drive the vehicle before reassembling the plastic parts and panels previously removed.*
- *Do not get distracted by checking the status of the device or interacting with it neither directly or through the display unit.*

### 4.3 Vehicle Safety

	The device was designed and created in order to allow an easy, fast and safe installation; nevertheless, it is best to be sure not to compromise any vehicle function during this operation.
---	--

## Safety Measures:

- *Delicately remove any plastic part, cover or bulkhead that might cover the diagnostic socket, being careful not to loose any screw or fastening hook.*
- *Be careful not to damage or disconnect any plastic part or cable near the diagnostic cable.*
- *Carefully reposition and close any plastic part, cover or bulkhead once the device's installation and configuration phase is completed.*
- *Do not install the device on vehicles that are not supported.*

## 4.4 Device Safety

	<p>The device was designed to be used in specific environmental conditions.</p> <p>Using the device in environments with temperatures and humidity that differ from those specified may impair its efficiency.</p>
---	--

### Safety measures:

- *Always place the device in a dry area.*
- *Do not expose or use the device close to heat sources.*
- *Position the device in order to guarantee its proper ventilation.*
- *Do not use corrosive chemicals, solvents or harsh detergents to clean the device.*

	<p>The device was created to be mechanically resistant and suitable for the use it was designed for.</p> <p>Careless use and excessive mechanical strain may impair its efficiency.</p>
---	---

### Safety measures:

- *Do not drop, shake or knock the device.*
- *Do not carry out any type of intervention that may damage the device.*
- *Do not open or disassemble the device.*
- *Do not force the device or the connectors and take the utmost care during all connecting and disconnecting operations.*
- *Connect the device properly and securely in order to avoid it from accidentally disconnecting during use.*
- *Do not use screwdrivers or other tools to lever and disconnect the device.*

	<p>The device was manufactured to be electrically safe and to work with specific supply voltage levels.</p> <p>Failure to comply with the specifications related to the power supply may impair the device's efficiency.</p>
---	--

**Safety measures:**

- *Do not wet the device with water or other liquids.*
- *Use the device on vehicles with a 12-24 V DC power supply, chassis connected to the negative pole, and in any case only on supported vehicles.*
- *The connection for the device's power supply must always be with the battery-operated system of the vehicle being tested.*



The electromagnetic compatibility tests carried out on the device guarantee that it can be adapted to the technologies normally used on vehicles (ex.: engine control, ABS, airbag, etc.). Nevertheless, if malfunctions occur, contact the vehicle's dealer.

## 5 ENVIRONMENTAL INFORMATION



For information regarding the disposal of this product please see the pamphlet supplied.



## 6 OPERATION OF THE RADIO DEVICES

### Wireless connection with Bluetooth® technology

The wireless connection with Bluetooth technology is a technology that supplies a standard and reliable method to exchange information between different devices, using radio waves. Products such as cellular phones, portable devices, computers, printers, cameras, pocket PCs etc. use this type of technology.

The Bluetooth interface searches for compatible electronic devices according to the radio signal they generate and establishes a connection between them. The tools operate a selection suggesting only compatible / enabled devices. This does not exclude the presence of other sources of communication or interference.

THE EFFICIENCY AND THE QUALITY OF THE BLUETOOTH COMMUNICATION MAY BE INFLUENCED BY THE PRESENCE OF RADIO DISTURBANCE SOURCES. THE COMMUNICATION PROTOCOL HAS BEEN DEVELOPED TO MANAGE THESE TYPES OF ERRORS; HOWEVER, IN THESE CASES COMMUNICATION MAY BECOME DIFFICULT AND CONNECTION MAY REQUIRE SEVERAL ATTEMPTS.

SHOULD THE WIRELESS CONNECTION ENCOUNTER SERIOUS PROBLEMS THAT MAY COMPROMISE A REGULAR COMMUNICATION, THE SOURCE OF THE ENVIRONMENTAL ELECTROMAGNETIC INTERFERENCE MUST BE IDENTIFIED AND ITS INTENSITY REDUCED.

Position the product in order to guarantee the correct operation of its radio devices. In particular, do not cover it with any shielding or metal materials in general.

## 7 REGULATORY INFORMATION

### Simplified EU Declaration of Conformity

	<p>The manufacturer, TEXA S.p.A, declares that the type of radio equipment <b>TEXA eTRUCK</b> is compliant with the RED 2014/53/EU directive.</p> <p>The complete text of the EU declaration of conformity is available at the following Internet address <a href="http://www.texa.it/download">http://www.texa.it/download</a>.</p>
---	--

### FCC Conformity

The E-truck complies with the following requirements: - FCC (Federal Communications Commission) Part 15

Operation is subject to the following two conditions: (1) This device may not cause harmful interference, and (2) This device must accept any interference received, including interference that may cause undesired operation.

Changes or modification not expressly approved by the party responsible for compliance could void the user's authority to operate the equipment.

FCC ID: T8RET17

## 8 TEXA eTRUCK

**TEXA eTRUCK** is a compact device that allows the workshop to constantly monitor the vehicle status remotely, managing its maintenance from a predictive point of view and carrying out adjustment functions that allow restoring the optimal vehicle conditions.

**For the WORKSHOP: eTRUCK** is the linking element between the mechanic and the industrial vehicle, fostering customer loyalty through a continuous assistance service.

**For the DRIVER and FLEET MANAGER: eTRUCK** is the ideal solution for DRIVERS and FLEET MANAGERS who want to be constantly updated on the conditions of their vehicles, as it allows them to realise specific actions for cost reduction and vehicle use optimisation, thanks to a dedicated app and management portal.



The device is able to acquire the required data from the vehicle and to transmit it in real time via Bluetooth to the smartphone selected as a display unit.

For this to occur, a specific app must be installed in the smartphone.

The app can be downloaded directly from the Internet through



and



Furthermore, because of its small size, the device takes up little space and does not interfere with driving.

## 9 DESCRIPTION

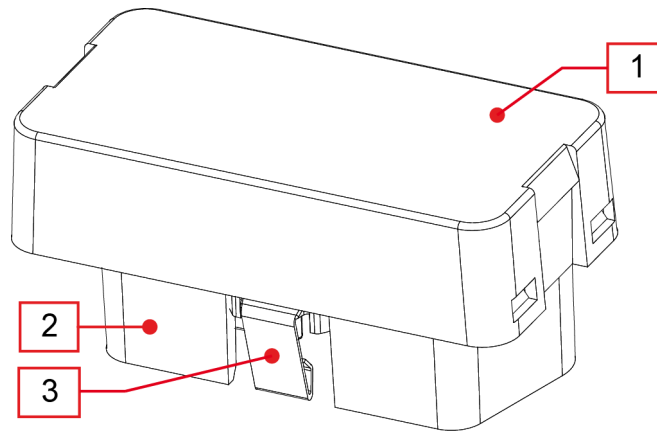

1. *LED*

- *Red / green LED*
- *Blue LED*

2. *OBD connector*

3. *Retention hook*

**(\*) For further information see the Blink Codes chapter.**

## 10 TECHNICAL FEATURES

<b>Manufacturer</b>	TEXA S.p.A.
<b>Model</b>	TEXA eTRUCK
<b>Processor</b>	ARM Cortex M4 (STM32F439ZIY6)
<b>Memory</b>	<ul style="list-style-type: none"> <li>• <i>SDRAM: 8 MB</i></li> <li>• <i>Flash NAND: 4 GB</i></li> </ul>
<b>Communication</b>	<ul style="list-style-type: none"> <li>• <i>Bluetooth Classic (2.1)</i></li> <li>• <i>Bluetooth 4.0 Low Energy (Smart Ready)</i></li> </ul>
<b>Diagnostic connector</b>	OBD socket ISO15031-03 for 24 V systems
<b>Supported automotive bus types</b>	<ul style="list-style-type: none"> <li>• <i>4 HS CAN transceivers connected to OBD pins 3-11, 1-9, 12-13, 6-14 that can be enabled individually</i></li> <li>• <i>1 J1708 transceiver connected to pins 12-13</i></li> <li>• <i>1 ISO9141-2, ISO14230 transceiver with 60mA current protection connected to pins 3 or 7</i></li> </ul>
<b>Visual warnings</b>	<ul style="list-style-type: none"> <li>• <i>1 green/red bi-coloured LED</i></li> <li>• <i>1 blue LED</i></li> </ul>
<b>Inertial sensor</b>	<ul style="list-style-type: none"> <li>• <i>Accelerometer: 3 axis, <math>\pm 16</math> G F.S.</i></li> <li>• <i>Gyroscope: 3 axis, <math>\pm 2000</math> DPS G F.S.</i></li> </ul>
<b>Supply voltage</b>	12 / 24 Vdc
<b>Consumptions</b>	<ul style="list-style-type: none"> <li>• <i>Normal mode: 60 / 120 mA (12 / 24 Vdc)</i></li> <li>• <i>Standby: &lt; 6 mA</i></li> </ul>
<b>Device activation</b>	Possible from OBD pins 1 and 8 or by monitoring the battery voltage
<b>Operating temperature</b>	- 20 °C – 60 °C
<b>Storage temperature</b>	- 40 °C – 85 °C
<b>ISM operating frequency band</b>	2400 - 2483.5 MHz
<b>Maximum transmit power in frequency band</b>	4 dBm
<b>Relative humidity</b>	10% – 80% without condensation

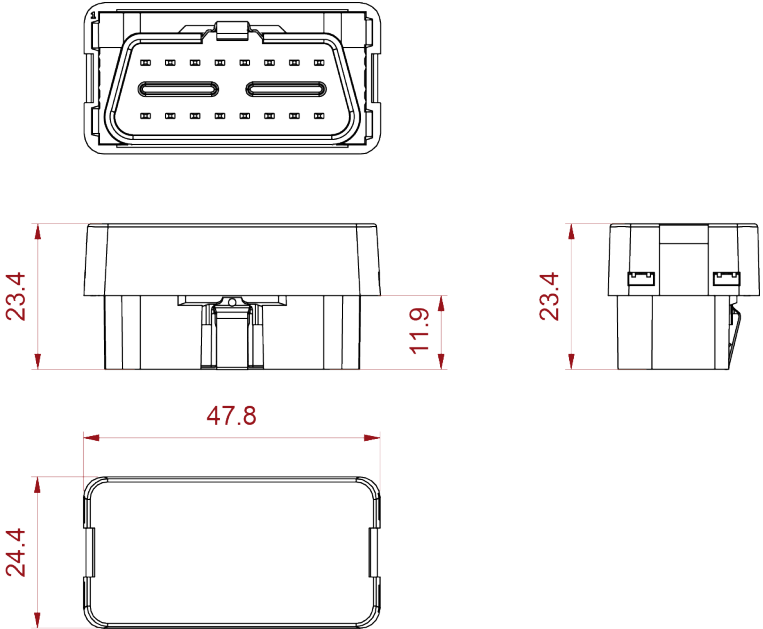
<p><b>Dimensions in [mm]</b></p>	 <p>Technical drawings of a rectangular connector. The top view shows a rectangular shape with rounded corners and a central slot. The side view shows a height of 23.4 mm and a depth of 11.9 mm. The bottom view shows a length of 47.8 mm and a width of 24.4 mm.</p>
<p><b>Weight</b></p>	<p>15 g</p>
<p><b>Directives</b></p>	<p>RED 2014 / 53 / EU ROHS 2011 / 65 / EU</p>
<p><b>Product standards</b></p>	<p>EN 301 489-1 V2.1.1 EN 301 489-17 3.1.1 EN 300 328 V2.1.1 EN 62311:2008 EN 60950-1:2006 / A11+A1+A12+AC:2001+A2:2013 ISO 7637-1:2002 ISO 7637-2:2011</p>
<p><b>Regulations</b></p>	<p>UN / ECE R10</p>

# 11 INSTALLATION AND CONFIGURATION

The following chapters illustrate how to install and configure a device or a series of devices in sequence.

At the end of the installation and configuration procedures, the device is able to work only on the vehicle on which it is installed.



**Do not install the device on vehicles that do not meet the compatibility requirements established by TEXA S.p.A.**



**Do not move the device onto any other vehicle without performing the installation and configuration procedure.**

## 11.1 Preliminary operations

- Sign up on the **eTRUCK WORKSHOP Web Portal**
- Get the **FLEET MANAGER** email address
- Download the **WORKSHOP** app from **Google Play Store** or **Apple App Store**
- Keep the devices to be installed at hand

## 11.2 Configuration through the App

The following procedure must be performed respecting the times and requests of the device installation app.

Proceed as follows:

1. Launch the **WORKSHOP** app.
2. Enter the **FLEET MANAGER** email address.
3. Identify the device with one of the following modes:
  - Scan the QR Code on the device to get its serial number, wait for the app to get the PIN code via the Internet (default and recommended mode)
  - Manually enter the serial number indicated on the device, wait for the app to get the PIN code via the Internet (use this mode if scanning the QR Code is not possible)
  - Manually enter the serial number and PIN code indicated on the device (use this mode if no Internet connection is available)
4. Enter the vehicle's license plate number when requested to by the app.
5. Select the **Make** and **Model** using the specific drop-down menus.
6. Connect the device to the vehicle as explained in the section **Installation in the Vehicle**.
7. Launch the Bluetooth configuration.

The configuration procedure is complete.

The app gives the possibility to install other devices in sequence or finish the installations.

### 11.3 Installation in the Vehicle

**!** A screwdriver may be needed to loosen the screws that fasten the panels that cover the diagnostic socket.

**!** Make sure the device is securely connected to the diagnostic socket to avoid it from accidentally disconnecting during use.

Proceed as follows:

1. Turn off the vehicle (instrument panel off).
2. Locate the diagnostic socket.
3. Carefully remove any panel covering the diagnostic socket.
4. Connect the device to the diagnostic socket.

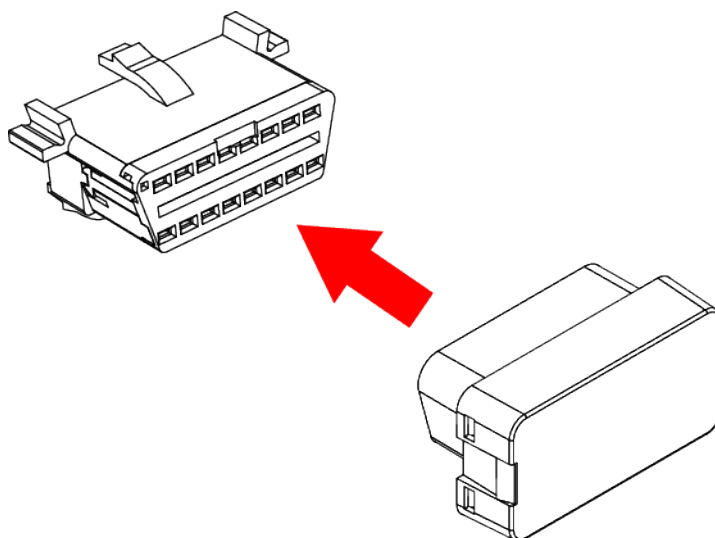

5. Turn on the vehicle (instrument panel on).
6. Carefully reposition any removed panel.

**!** Make sure that the various components around the diagnostic socket do not damage the device during installation.

**!** Make sure that the position of the device does not interfere with driving.

**!** Do not start driving before the plastic parts and panels removed are repositioned correctly.

#### 11.3.1 Installation through 9-pin Deutsch Adapter

The device can also be installed on vehicles with a 9-pin Deutsch socket through the specific adapter supplied by TEXA S.p.A. (code: 3907794).



**For this installation mode, all the warnings in the previous section apply.**

Proceed as follows:

1. Turn off the vehicle (instrument panel off).
2. Locate the diagnostic socket.
3. Carefully remove any panel covering the diagnostic socket.
4. Connect the device to the adapter.
5. Connect the adapter to the diagnostic socket.
6. If necessary, fasten the adapter to the dashboard using screws, in order not to compromise driving.

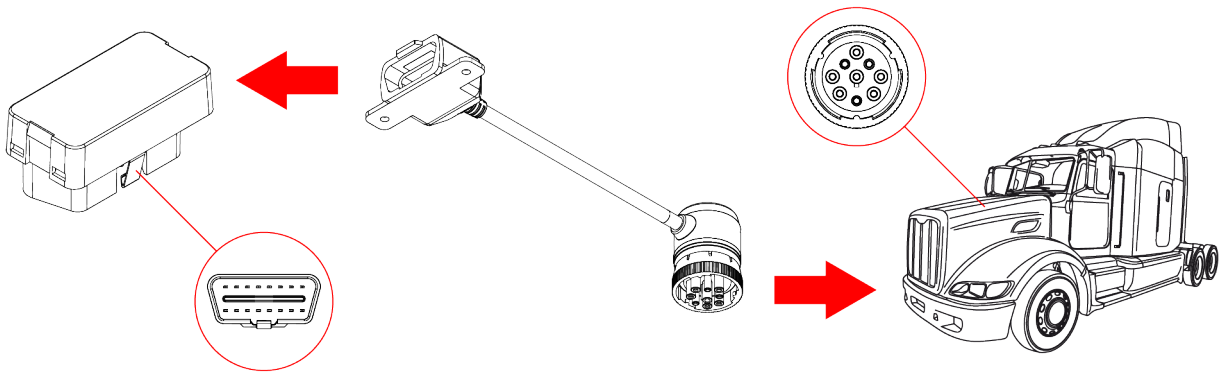

7. Turn on the vehicle (instrument panel on).
8. Carefully reposition any removed panel.

## 12 eTRUCK INSTALLATION KIT FOR VOLVO EURO IV-V (ACCESSORY)

The industrial vehicles of the Swedish manufacturer Volvo Truck, with approval class Euro IV and Euro V, were created in different configurations, many of which have two diagnostic sockets.

One is the EOBD connection, the other is the Volvo Truck proprietary diagnostic socket (Texa ref.: connection cable 3151 / T11B).

In order to use the eTRUCK device to its fullest potential, the electrical wiring needs to be modified in this series of vehicles.

This is because the installed EOBD diagnostic socket does not allow analysing all the values, but only the parameters of the EOBD standard protocol.

The modification does not require special technical skills, and the installation kit contains the material and information that are needed to carry out the modification.

However, the work should be performed by technical personnel with all the necessary knowledge to perform it properly.

Following is a step-by-step description of the procedure operations, accompanied by explanatory images.

### **NOTES:**

*This technical information sheet is ONLY for the vehicles with the two diagnostic sockets.*

*The vehicles with only the EOBD socket are already 100% compatible with the eTRUCK device.*

The installation kit includes:



- A. Cable joints
- B. Cable terminals
- C. Electrical cables

To install the kit properly and access all TEXA eTRUCK functions, carefully follow the instructions below.

1. Make sure the parking brake is engaged.
2. Disconnect the batteries.
3. Locate the diagnostic sockets.



4. Remove the 3 screws and the plastic nut.
5. Remove the heating air duct.

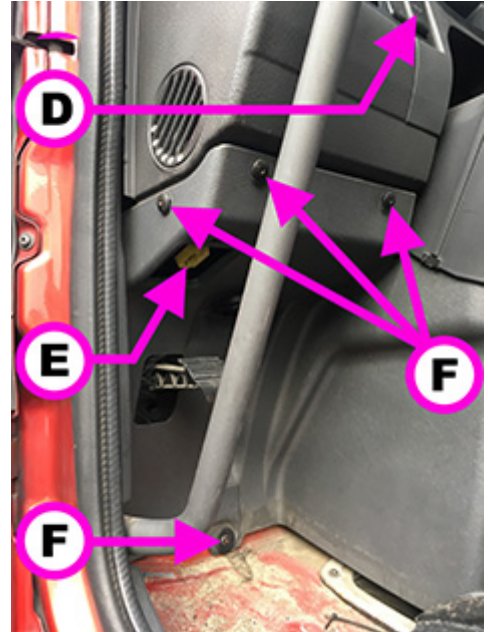

- D. EOBD socket
- E. Volvo Truck proprietary socket
- F. Fastening screws and nuts

6. Remove both the yellow diagnostic socket and the EOBD socket from their housings, acting on the fasteners.
7. Make sure the EOBD diagnostic socket pin 16 (black wire of the original wiring) is powered by a direct battery positive (+30) and not a key-on (+15).

**If necessary, restore the EOBD socket wiring. Otherwise, full functionality of TEXA eTRUCK is not guaranteed.**

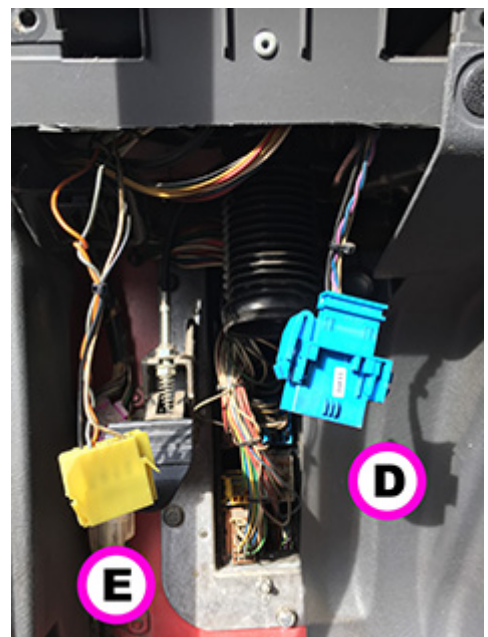

- D. EOBD socket
- E. Volvo Truck proprietary socket

8. On the EOBD socket (light blue connector), locate pins 12 and 13 (with no cables installed).

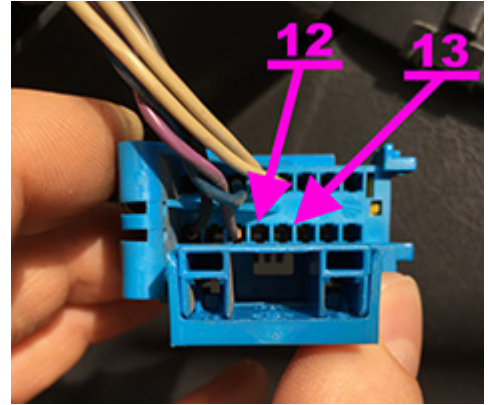

9. Remove the yellow fastener from the EOBD socket.

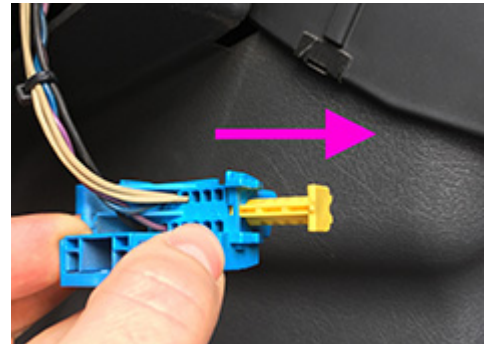

10. Using the supplied red/black cables and terminals, crimp the terminals on the wires.

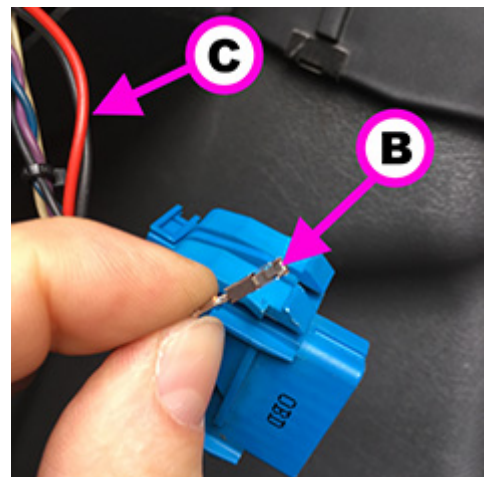

B. Cable terminals  
C. Electrical cables

11. Insert the black cable into pin 12 and the red cable into pin 13 of the EOBD socket.

Cable colour: black - Pin: 12

Cable colour: red - Pin: 13

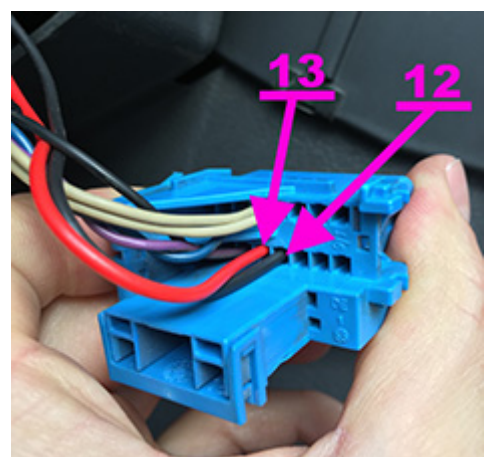

12. Reinsert the yellow fastener.

13. Fasten the two red and black cables together with the existing wiring, following it up to the yellow diagnostic socket.

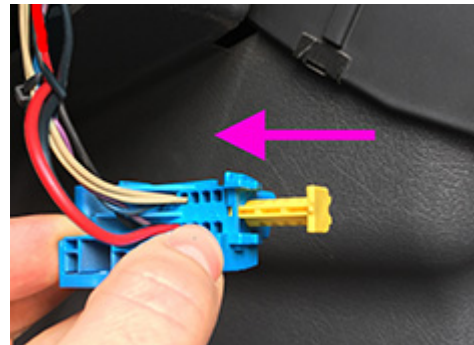

14. On the Volvo Truck proprietary socket (yellow connector), locate pins 2 (grey cable) and 3 (orange cable).

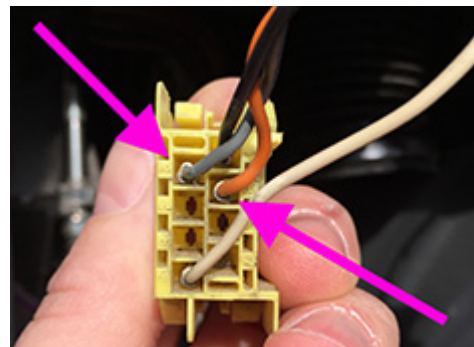

15. Using the supplied cable joints, connect the black wire to the grey wire and the red wire to the orange wire of the yellow diagnostic socket.

**WARNING: to be able to use the cable joint, you need to cut the grey and orange wires.**

Cable matching:

- *Black + grey*
- *Red + orange*

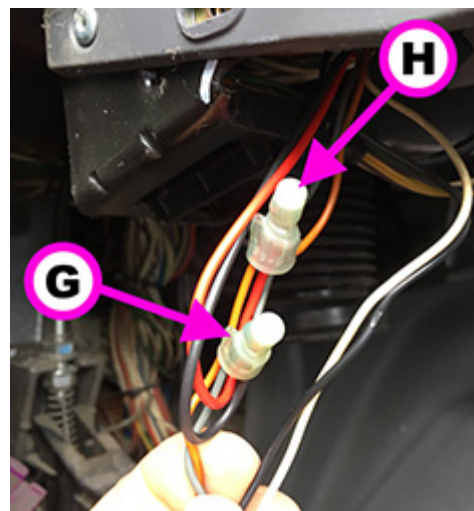

G. Cable joint with black and grey wires

H. Cable joint with red and orange wires

16. Install the yellow diagnostic socket back onto its bracket.



17. Install the EOBD socket back onto its bracket.



21. Reconnect the batteries

22. TEXA eTRUCK can now be installed in the EOBD socket and used at its fullest potential.



## 13 USE

No further action must be carried out after installing and configuring the device. Any interaction occurs through the smartphone.

The device activates as soon as the vehicle's instrument panel is turned on and it connects automatically to the smartphone if it is within the operating range of the device's Bluetooth antenna.



**While driving, do not get distracted to check the status of the device or to interact with it either directly or through the smartphone.**

**For further help, contact your Retailer or send a request for assistance through the function TEXA iSupport - eTRUCK.**

## 14 POWER SUPPLY

The device draws its power supply directly from the battery of the vehicle it is connected to through the diagnostic socket.

The vehicle's diagnostic socket is always powered, even when the engine and instrument panel are off.

**The absorption never affects the battery's charge, however you should disconnect the device from the vehicle's diagnostic socket if the vehicle is not used for a long period of time.**



## 15 BLINK CODES

**Starting TEXA eTRUCK by plugging it in (inserting TEXA eTRUCK in the vehicle's diagnostic socket) and with the vehicle stationary.**

LED	Meaning
GREEN - BLUE: quick alternate blink	Device connected to the vehicle, available for pairing.

- *Device connected via Bluetooth:*

LED	Meaning
BLUE: Slow blink	Device configured and connected to the vehicle.
BLUE: 2 blinks	The device is in one of the following situations: <ul style="list-style-type: none"> <li>• <i>configuration check in progress</i></li> <li>• <i>not configured but connected to the vehicle</i></li> <li>• <i>not configured and not connected</i></li> </ul>
BLUE: Quick blink	Device configured but not connected to the vehicle.

- *Device NOT connected via Bluetooth:*

LED	Meaning
GREEN: Slow blink	Device configured and connected to the vehicle.
GREEN: 2 blinks	The device is in one of the following situations: <ul style="list-style-type: none"> <li>• <i>configuration check in progress</i></li> <li>• <i>not configured but connected to the vehicle</i></li> <li>• <i>not configured and not connected</i></li> </ul>
GREEN: Quick blink	Device configured but not connected to the vehicle.

**Starting TEXA eTRUCK by turning on the engine (device already plugged in) and with the vehicle stationary.**

LED	Meaning
BLUE: 2 blinks	Smartphone authentication successful.

**Every time TEXA eTRUCK is started:**

<b>LED</b>	<b>Meaning</b>
GREEN: 2 blinks	User application successfully started.
RED: 4 blinks	Error in starting the user application.

## **16 MAINTENANCE**

This product does not require special maintenance.

For a longer tool life, keep the product clean and follow the instructions detailed in this manual carefully.



**For further help, contact your Retailer or send a request for assistance through the TEXA iSupport function.**

## 17 TROUBLESHOOTING

Contact your supplier / retailer about any technical problem that cannot be resolved by following the instructions below.

<b>Problem</b>	The device is connected to the diagnostic socket. The red LED blinks 4 times.	
	<b>Possible Cause</b>	<b>Possible Solution</b>
	The vehicle is not compatible with the device.	Use the device only on compatible vehicles.
	There is an error condition.	Carefully disconnect and reconnect the device. If the error persists, contact your Retailer or send a request for assistance through the function TEXA iSupport - eTRUCK.
<b>Problem</b>	The smartphone does not communicate with the device.	
	<b>Possible Cause</b>	<b>Possible Solution</b>
	The vehicle's instrument panel is off.	Turn on the vehicle's instrument panel.
	The device is not properly connected and appears as switched off.	Carefully disconnect and reconnect the device to the diagnostic socket making sure it is inserted securely.
	The smartphone's Bluetooth is not active.	Activate the smartphone's Bluetooth
	The smartphone is not within the device's Bluetooth operating range.	Place the smartphone within the device's operating range, that is inside the vehicle or in its immediate surroundings.
	Other wireless communications interfere with the signal.	Wait and try to communicate again. If necessary, move the vehicle into another position.

## 18 LEGAL NOTICES

### TEXA S.p.A.

Via 1 Maggio, 9 - 31050 Monastier di Treviso - ITALY

Tax Code - Company Register of Treviso ID No. - VAT No.: 02413550266

Single-shareholder company subject to the direction and coordination activities of Opera Holding S.r.l.

Paid-up share capital 1,000,000 €- R.E.A. (Economic Administrative Index) No. 208102

Legal Representative Bruno Vianello

Phone +39 0422.791.311

Fax +39 0422.791.300

[www.texa.com](http://www.texa.com)

For information regarding the legal notices, please refer to the **International Warranty Booklet** provided with the product.