



OWNER'S MANUAL

PowerTap SL2.4

CycleOps 
WHERE WINS BEGIN.

Copyright

Copyright 2005. All rights reserved. No part of this publication may be copied, photographed, reproduced, translated, transmitted electronically or placed on digital media without the prior written consent of Saris Cycling Group, Inc.

Trademarks

Saris Cycling Group, Inc., PowerTap and the PowerTap logo, are all registered trademarks of Saris Cycling Group, Inc. All other product, brand, or trade names used in this manual may be trademarks or registered trademarks of their respective owners.

Modifications

Saris Cycling Group, Inc. reserves the right to make improvements and/or updates to the products described herein at any time without notice.

FCC Statement of Compliance:

Statement of Compliance for FCC and Industry Canada:

Saris Cycling Group, Inc.
Model #: PowerTap SL2.4
IC: 6459A-SL2P401
FCC ID: T8P-SL2P401

"This device complies with Industry Canada and Part 15 of the FCC Rules. Operation is subject to the following two conditions: (1) This device may not cause harmful interference, and (2) this device must accept any interference received, including interference that may cause undesired operation."

The term "IC:" before the radio certification number only signifies that Industry Canada technical specifications were met.

Changes or modifications to this device not expressly approved by the party responsible for compliance with FCC regulations (the manufacturer) could void the user's authority to operate the equipment.

This equipment has been tested and found to comply with the limits for a Class B digital device, pursuant to part 15 of the FCC Rules. These limits are designed to provide reasonable protection against harmful interference in a normal installation. This equipment generates, uses and can radiate radio frequency energy and, if not installed and used in accordance with the instructions, may cause harmful interference to radio communications. However, there is no guarantee that interference will not occur in a particular installation

About This Manual

Thank you for your purchase of the CycleOps PowerTap SL2.4. PowerTap technology is the ultimate measure of performance by providing real-time feedback on your training intensity. No other equipment will give you greater performance return on your investment.

This manual describes the proper use and maintenance of the PowerTap SL2.4. **Every** person, independent of skill level, should read at least *PRECAUTION: IMPORTANT* prior to use of the PowerTap.

DEFINITIONS

Bold Letters - Bring special attention to important points and that should be read and understood prior to using the PowerTap.

Italicized Letters - Indicate reference to another section of the manual where further explanations are found.

This manual describes the functions of the PowerTap SL2.4 and the information provided may not apply to all PowerTap models. For the most current owners manual available please consult www.cycleops.com.

Table of Contents

About this Manual

Precautions: Important.....5

System Overview.....7

 The PowerTap System.....7

 Preparing for Installation.....7

 Compatibility.....8

 Wheel Building.....8

 System Installation.....9

General Computer Operation.....12

 Display Levels.....12

 Display Modes.....12

 Finding Sensors

 Clearing Data

 Buttons.....12

 Power Conservation.....13

Computer Navigation.....14

 Power Function.....14

 Torque Function.....15

 Zero Torque.....15

 Speed Function.....16

 Multi-Function.....17

 Cycle Computer Mode.....18

 Heart Rate Monitor Mode.....20

 Interval Mode.....21

 Interval Memory Mode.....22

Computer Setup.....23

 Computer Setup Main Menu.....23

 Computer Setup 1.....24

 Computer Setup 2.....27

 Computer Setup 3.....28

 Computer Setup 4.....29

 Computer Setup 5.....

Maintenance & Specifications.....31

 Bearings.....31

 Freehub.....31

 Freehub Replacement.....31

 Computer Batteries.....33

 Technical Specifications.....33

 Range of Measurement.....33

 Hub Batteries.....34

 Battery Replacement.....34

 Test Mode.....35

Trouble Shooting.....37

Glossary.....39

Precautions: Important

- Before beginning any exercise program, consult your physician.
- Keep your eyes on the road. **Do not** become overly engaged with the PowerTap display. We recommend familiarizing yourself with computer functions while stationary.
- The computer, receiver, and hub are water resistant, **not** water proof. Avoid sustained water contact and do not deliberately place the PowerTap or its components in water or under high-pressure sprays. Therefore caution should be used when riding in rain. Following such rides, special precautions should be taken including removing the PowerTap plastic twist cap and allowing the hub to air dry.
- Wash off dirt with a cloth soaked in a weak mixture of neutral detergent and water and wipe excess water off with a dry cloth. Avoid spraying the unit directly with solvent mixture. Do not use thinner or other solvents to clean parts as they may dissolve the plastic console casings.
- If you are not familiar with bike maintenance please contact a professional bicycle mechanic before servicing. The power measuring components of the PowerTap are highly complex and should only be serviced by Saris Cycling Group.
- The plastic cover on the hub should be removed only when replacing batteries or when allowing the unit to dry after submersion in water. Repeated disassembly may compromise the effectiveness of the O-ring seals. O-rings should be inspected and replaced if necessary when ever the battery cover is removed. Use a light coating of grease when reinstalling the battery cap on the O-rings.
- During the course of repair **do not** remove the torque tube. There are no serviceable parts inside. Special tools are required for reassembly and calibration. If problems are suspected contact Saris Cycling Group directly at 800-783-7257 (001 608 274 6550).

Precautions: Important, cont.

- The PowerTap wheel does not include a quick release skewer. CycleOps recommends using a steel skewer.
- **Both sides of the PowerTap should be built using a 3x spoke lacing pattern.** Because of the design of the PowerTap, torque is transmitted through the hub to the non-drive side. For additional questions please consult *WHEEL BUILDING*.
- Failure to adhere to these precautions may cause premature failure or incorrect operation of the unit and may void the warranty. Please register your PowerTap at www.cycleops.com.

System Overview

THE POWER TAP SYSTEM

The PowerTap system includes a power-measuring hub which measures torque and wheel speed. This information is transmitted to a computer mounted on the handlebar or stem. Heart rate data is transferred via A coded telemetry signal from the chest strap monitor. The data is then integrated to display current, average, and maximum biometric information.

PREPARING FOR INSTALLATION

The PowerTap SL2.4 hub comes either alone or in a pre-built wheel. If purchased alone, the hub must be built into a complete wheel prior to use. Other items necessary for installation and not provided include a cassette, spoke protector, reflectors, skewer, rim strip, tire, and tube (clincher rim) or glue and tubular tire (tubular rim). See TABLE 1 to verify package contents.

TABLE 1

Package Contents	
Qty	Item
1	PowerTap hub (or built wheel)
1	PowerTap computer
1	Chest strap
4	Foam mounting tapes
12	Cable ties
1	Training With Power guide
1	PowerTuned Agent CD
1	Link USB Cable
1	Extra CPU Battery

System Overview cont.

COMPATABILITY

The PowerTap SL2.4 hub is compatible with Shimano 8, 9, and 10 speed systems or Campagnolo 8, 9, and 10 speed systems. Freehub bodies may be interchanged. Reference *FREEHUB REPLACEMENT* for further instructions.

The PowerTap is available in 130mm and 135mm axle lengths. Only insert the correctly spaced PowerTap hub into your frame. For example, only use a 130mm-spaced hub in a 130mm road frame. Do not force the hub into any frame. Doing so may cause failure of the frame, hub, or both, and will void the warranty. Contact your dealer or Saris Cycling Group to address any special compatibility concerns.

WHEEL BUILDING

Contact a wheel building professional or dealer for assistance in building the PowerTap SL2.4 wheel if not purchased as a complete wheel. **Both sides of the PowerTap should be built using only a 3x spoke lacing pattern.** Due to the design of the hub, the load pattern is not the same as a conventional hub. Slotting the hub flanges to accommodate bladed spokes is not recommended and will void the warranty. Complete wheel building hub dimensions are listed in TABLE 2.

Reference a [spoke-length calculator](#) to determine proper spoke length.

TABLE 2 - Wheel Building Dimensions

Measurements	Drive	Non-Drive
Hub Center To Flange	17.4mm	31.7mm
Flange Diameter	70mm	70mm
Spoke Hole Diameter: 2.5		

System Overview cont.

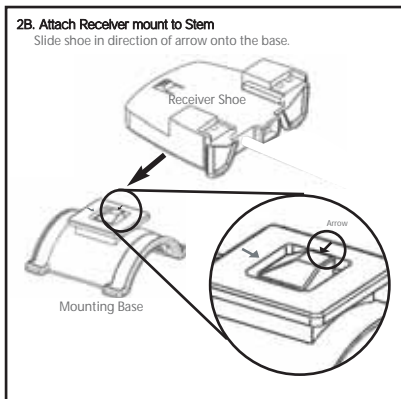
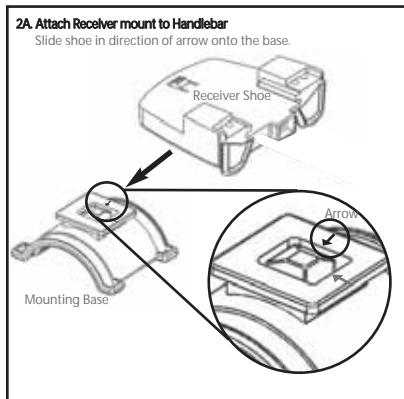
SYSTEM INSTALLATION

1. Insert Wheel Into Frame

Insert the PowerTap SL2.4 wheel into the frame. Make sure the axle is correctly positioned in the dropouts and secure the wheel in place with a steel skewer.

2. Attach Computer Shoe to Handlebar or Stem

The shoe can be mounted on either the handlebar or stem. Secure the receiver shoe with cable ties. Slide the receiver shoe in the direction of the arrow as depicted in either FIGURE 2A or 2B depending on mounting location.



3. Place Computer into Shoe

Place the computer into the mounting shoe on the handlebar or stem. Line up the slots on the base of the computer with the bracket and slide computer toward the rider (FIGURE 5). NOTE: Ensure the computer is fully inserted onto the receiver shoe for proper data transmission.

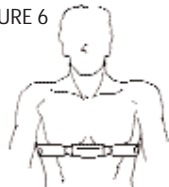
FIGURE 5



4 Heart Rate Monitor Strap

Position the heart rate monitor strap on your torso as pictured in FIGURE 6. The strap should rest just beneath the pectoralis muscles of the chest. For best results slightly moisten the electrodes where contact is made with skin. The heart rate strap **must** be worn to enable the heart rate function. NOTE: The chest strap for the PowerTap SL2.4 uses a coded frequency and is not compatible with other manufacturer's chest straps.

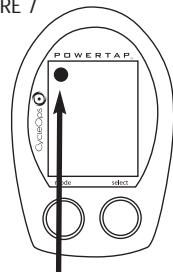
FIGURE 6



5. Verify Installation

Check to make sure all components are properly secured. Spin the rear wheel and verify that in the upper left hand corner of the computer the transmission icon illuminates (FIGURE 7). This indicates the hub is properly transmitting a signal to the receiver and computer. If the transmission icon is not illuminated consult *Finding Section Sensors* for further instructions.

FIGURE 7



General Computer Operation

DISPLAY LEVELS

The computer has three (3) main display levels:



NOTE: These locations only apply to trip and interval modes and **does not** apply to Cycle Computer or Heart Rate Monitor Function. See *COMPUTER SETUP 4* to customize display options.

DISPLAY MODES

The computer has two (2) main modes of operation:

- 1) Trip
- 2) Interval

Hold [MODE] to toggle between display modes.

BUTTONS

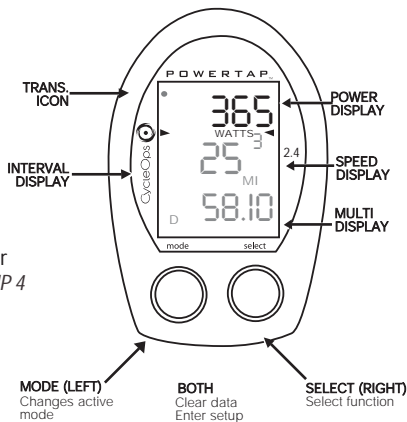
There are two (2) buttons on the computer:

- 1) [Mode]
- 2) [Select]

NOTE: [BRACKETED] words indicate buttons.

There are five (5) types of button presses:

- 1) Press [MODE] or [SELECT] - a single press and release of either [MODE] or [SELECT]. Used for entering different modes and functionality.



2) Hold [MODE] or [SELECT] - a single button press and hold of either [MODE] or [SELECT] for 2 sec. Used for initiating a new Interval.

3) Press [MODE] and [SELECT] - simultaneously press and release of **both** [MODE] and [SELECT].

4) Hold [MODE] and [SELECT] - simultaneously press and hold **both** [MODE] and [SELECT] for 2 sec. NOTE: Continuing to hold longer than 2 sec. and releasing will clear all data.

5) Extended Hold [MODE] and [SELECT] - simultaneously press and hold of **both** [MODE] and [SELECT] for **greater than 5 sec.** Used for initiating scrolling menu.

SCROLLING MENU:

SCROLLING MENU:

Find: If [MODE] and [SELECT] are released
When "Find" is displayed the computer will find
Search for the PowerTap hub.

clr: If [MODE] and [SELECT] are released when
clr is displayed **ALL DATA WILL BE ERASED**

SEt: If [MODE] and [SELECT] are released
When SEt is displayed on the top level of the
Screen, a flashing "E", d and t on the middle
Level and 12345 on the bottom level.

E = exit, return to ride mode
d = restore default settings
T = test mode
1 2 3 4 = setup menus

POWER CONSERVATION

The computer and hub have power saving features to prolong battery life. The computer powers down the display after four (4) minutes of inactivity. Press either [MODE] or [SELECT] to activate the display. Similarly, the hub powers down after five (5) minutes of inactivity. The transmission icon will not be visible when the hub is asleep. To wake the hub spin the wheel and verify the transmission icon is illuminated.

Computer Navigation

POWER FUNCTION

The top level of the main display shows current, max, and average power readings.

- 1) Press [MODE] to scroll the cursor to the top line of the main display
- 2) Press [SELECT] to toggle through the power function options.

For accurate power readings it is important to **frequently** zero the torque, see *ZERO TORQUE*.

Current Power

Power is displayed in watts from 0-1999 in 1 watt increments. Current power readings are displayed only when the word "WATTS" appears below the top line (FIGURE 9). NOTE: If "WATTS" **does not** appear under the top line the computer is in the Cycle Computer Function. To return to power readings see *CYCLE COMPUTER MODE*.

Maximum Power

Both "WATTS" and "MX" displayed simultaneously indicate the highest recorded power output since the last time the data was cleared in trip mode or the selected interval in interval mode. (FIGURE 10)

Average Power

Both "WATTS" and "AVG" displayed simultaneously indicate the average power output since the last time the data was cleared in trip mode or the selected interval in interval mode. (FIGURE 11)

FIGURE 9



FIGURE 10

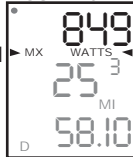
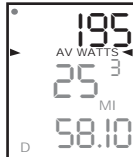


FIGURE 11

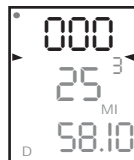


TORQUE FUNCTION

Shows the torque placed on the hub in inch-pounds. To display torque in trip mode:

- 1) Press [MODE] to scroll the cursor to the top line of the main display.
- 2) Press [SELECT] until the current power function is displayed.
- 3) Hold [SELECT] until the word "WATTS" begins to flash. A blinking "WATTS" display indicates the torque function is currently displayed.
- 4) Press [SELECT] to return to the current power function. (FIGURE 12).

FIGURE 12



IMPORTANT: ZERO TORQUE

Frequently the torque must be zeroed to ensure the most accurate power information is displayed. If the current power display is positive or negative while coasting the torque **must** be zeroed. This operations **must** be done while coasting with **no** tension on the chain, **no** tension placed on the pedals, and the transmission icon must be illuminated. To zero torque:

- 1) Press [MODE] to scroll the cursor to the top line of the main display.
- 2) Press [SELECT] until current power function is displayed.
- 3) Hold [SELECT] until the word "WATTS" begins to flash to enter the torque function.
- 4) Hold [SELECT] again until "0" is shown.
- 5) Press [SELECT] to return to current power. The current power function will now read zero while coasting.

SPEED FUNCTION

The middle level of the main display shows current, max, and average speed readings.

- 1) Press [MODE] to scroll the cursor to the middle line of the main display.
- 2) Press [SELECT] to toggle through the speed function options.

Current Speed

Speed is displayed in either miles per hour (MI) or kilometers per hour (KM) up to 99.9 mi/hr or km/hr in 0.1 mi/hr or km/hr increments. Current speed readings are displayed when only "MI" or "KM" appears below the middle line. (FIGURE 13)

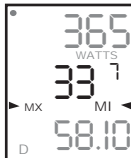
FIGURE 13



Maximum Speed

Either "MI" or "KM" and "MX" displayed simultaneously indicate the highest recorded speed since the last time data was cleared in trip mode or the selected interval in interval mode. (FIGURE 14)

FIGURE 14



Average Power

Either "MI" or "KM" and "AVG" displayed simultaneously indicate the average recorded speed since the last time data was cleared in trip mode or the selected interval in interval mode. (FIGURE 15)

FIGURE 15



MULTI-FUNCTION DISPLAY

Distance (D)

Total trip or the selected interval distance in interval mode is displayed in miles or kilometers from 0.00 to 999.99 (FIGURE 16).

- 1) Press [MODE] to scroll the cursor to the bottom line of the main display.
- 2) Press [SELECT] to toggle through the multi-function displays until the "D" icon is displayed.

NOTE: Distance is displayed in the same units as speed.

FIGURE 16



Trip Time and Time of Day (T)

Total trip time, interval time, and time of day is displayed to 9:59:59 (FIGURE 17).

- 1) Press [MODE] to scroll the cursor to the bottom line of the main display.
- 2) Press [SELECT] to toggle through the multi-function displays until the "T" icon is displayed.
- 3) While in trip time hold [SLECET] to access the real time clock.
- 4) Hold [SELECT] to return to trip or interval time.

NOTE: Auto start and stop with rotation of the wheel is the default setting. To customize auto start and stop see *COMPUTER STETUP 4*.

FIGURE 17



Cadence (C)

Cadence is measured at the hub by analyzing the way a rider applies torque through the pedal stroke since there are natural power differences in the pedal stroke. The rate of pedaling is shown from 20 to 240 RPM.

NOTE: An optional wireless cadence sensor is available to measure cadence at the crank.

FIGURE 18



- 1) Press [MODE] to scroll the cursor to the bottom line of the main display.
- 2) Press [SELECT] to toggle through the multi-function displays until the "C" icon is displayed. (FIGURE 18)

CYCLE COMPUTER MODE

Access to the Cycle Computer Mode is also gained in the cadence function. This function allows the PowerTap SL2.4 computer to function as a cycle computer in the absence of the PowerTap hub. This function is useful when the PowerTap SL2.4 hub is not present such as in racing situations where lighter racing wheels are used. NOTE: In Cycle Computer Mode heart rate is displayed in the top line of the main display and power data is no longer displayed. To enter Cycle Computer Mode:

- 1) Press [MODE] to scroll the cursor to the bottom line of the main display.
- 2) Press [SELECT] to toggle through the multi-function displays until the "C" icon is displayed.
- 3) Hold [SELECT] and the word "WATTS" will disappear from below the top line. Place magnet or rear wheel so it passes the receiver at the line or the sensor.
- 4) To return to current power function hold [SELECT] until the word "WATTS" is displayed under the top line of the main display.

Average Cadence (C & AVG)

The average cadence displays data since the last time data was cleared in trip mode or the selected interval in interval mode. Average cadence is displayed in RPM.

- 1) Press [MODE] to scroll the cursor to the bottom line of the main display.
- 2) Press [SELECT] to toggle through the multi-function displays until the “C” and “AVG” is displayed. (FIGURE 19)

FIGURE 19



Energy Expenditure (E)

The total work done over the course of the trip or interval is shown in kilojoules. This value is a measure of the total energy expended over the course of your ride. This is roughly equivalent to dietary calories expended.

- 1) Press [MODE] to scroll the cursor to the bottom line of the main display.
- 2) Press [SELECT] to toggle through the multi-function displays until the “E” is displayed. (FIGURE 20)

FIGURE 20



Odometer (O)

Total accumulated distance traveled since the last system reset is displayed in miles or kilometers. To manually input the your odometer reading see *COMPUTER SETUP 1*.

- 1) Press [MODE] to scroll the cursor to the bottom line of the main display.
- 2) Press [SELECT] to toggle through the multi-function displays until the “O” is displayed. (FIGURE 21)

FIGURE 21



Heart Rate (♥)

Current heart rate is shown up to 255 beats per minute (BMP). You must wear the heart rate chest strap to enable the heart rate measurement function. NOTE: The PowerTap SL2.4 uses a coded chest strap.

- 1) Press [MODE] to scroll the cursor to the bottom line of the main display.
- 2) Press [SELECT] to toggle through the multi-function displays until the "♥" is displayed. (FIGURE 22)

FIGURE 22



HEART RATE MONITOR MODE

Access to the Heart Rate Monitor Mode is also gained in the current heart rate mode. This function allows the PowerTap computer to function as a heart rate monitor in the absence of the PowerTap hub. NOTE: In Heart Rate Monitor Mode heart rate is displayed on the top line of the main display and power data is no longer displayed.

- 1) Press [MODE] to scroll the cursor to the bottom line of the main display.
- 2) Press [SELECT] to toggle through the multi-function displays until the (♥) icon is displayed.
- 3) Hold [SELECT] and the words "watts" disappears from below the top line.
- 4) To return normal PowerTap functions hold [SELECT] until the word "WATTS" is displayed under the top line of the main display.

Average Heart Rate (♥ AV)

This value is a running average of the heart rate in BPM. If there is no heart rate information this will display as 0.

- 1) Press [MODE] to scroll the cursor to the bottom line of the main display.
- 2) Press [SELECT] to toggle through the multi-function displays until the "♥AV" is displayed. (FIGURE 23)

FIGURE 23



INTERVAL MODE

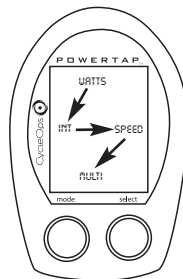
The computer has two display modes. The trip mode shows total trip metrics, and the interval mode displays interval specific information. The interval mode functions as a lap marker and is essentially always on.

To begin the first interval, or advance to the next interval:

Press and release [MODE] and [SELECT] simultaneously. **NOTE: Do not hold both buttons down as you will clear all data from the computer.**

In trip mode "INT" and the new interval number will appear and disappear (FIGURE 24). The computer can mark an unlimited number of intervals although after nine (9) the marker will begin to count back at one (1). For example, interval ten (10) is displayed following interval (9) as one (1).

FIGURE 24



To view interval specific data (power, speed, and multi-function display) from any location on the display:

- 1) Hold [MODE] until "INT" appears on the left hand side of the display. The "INT" and interval number will remain illuminated as a fourth line in the main display (FIGURE 24). The data displayed is that of the current interval number shown.
- 2) To exit back out of interval mode hold [MODE] until "INT" disappears.

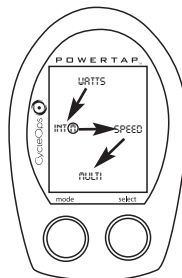
INTERVAL MEMORY MODE

To access stored interval data for the previous 9 intervals only:

- 1) Enter the interval mode hold [MODE] until "INT" appears on the left hand side of the display.
- 2) Press [MODE] to scroll until the "INT" flashes. NOTE: INT now constitutes a fourth level of display.
- 3) Hold [SELECT] and the memory icon ("M") appears next to the interval number (FIGURE 25).
- 4) With "INT" flashing, press [SELECT] to advance to the interval you wish to view.
- 5) Press [MODE] scroll the cursor to the line of information you wish to view. NOTE: Recovery periods as well as work periods are displayed in memory mode.

To exit back out of the interval memory mode hold [SELECT] until the memory icon disappears. The computer is now displayed in the interval mode. To exit from the interval mode from any location on the display hold [MODE] until "INT" disappears.

FIGURE 25



Computer Setup

The setup feature has four (4) main modes. You **do not** have to complete all four to change settings. Please reference each mode to determine the correct location to begin. **NOTE: The computer illustrations for each mode display the factory default settings.**

COMPUTER SETUP MAIN MENU

1) Press either [MODE] or [SELECT] to activate the computer.

NOTE: The version of firmware is displayed upon startup. The most updated firmware version is available at www.cycleops.com. (FIGURE 26)

2) Extended hold of [MODE] and [SELECT] simultaneously enters computer setup function indicates by a flashing "E". NOTE: Continue to hold **through** "clear all" screen. Releasing hold early will clear all current data.

3) The setup mode displays three (3) letters and numbers 1-4. Each letter represents a setup menu. A flashing alphanumeric character indicated current selection. (FIGURE 27)

E = exit, return to ride mode

d = restore default settings

T = test mode

1 2 3 4 5= setup menus

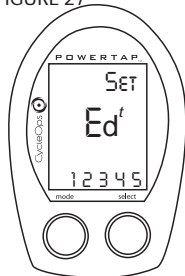
4) Press [SELECT] to scroll to the desired setup mode.

5) Press [MODE] to begin setup.

FIGURE 26

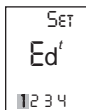


FIGURE 27

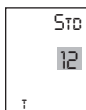


COMPUTER SETUP 1

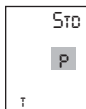
This setup menu includes: time of day, date, storage rate, wheel circumference, units of measure, odometer. NOTE: You are unable to move back to a previously viewed settings. You must restart setup 1 to make corrections. You may hold [MODE] and [SELECT] to save and exit setup.



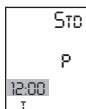
1) From the computer setup main menu press [SELECT] and scroll until the number one (1) is flashing. Press [MODE] to enter setup mode.



2) Press [SELECT] to toggle between a 12 or 24 hour clock. Press [MODE] to save.

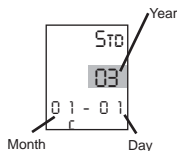


3) Press [SELECT] to toggle between AM (A) or PM (P). Press [MODE] to save.

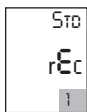


4) Press [SELECT] to toggle through digit values to set hours in time of day. Press [MODE] to save.

5) Press [SELECT] to toggle through digit values to set minutes in time of day. Press [MODE] to save.



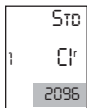
6) Press [SELECT] to toggle through digit values to set year, month, and date. Press [MODE] to save.



7) Press [SELECT] to toggle through storage rate values (1, 2 seconds). Press [MODE] to save. NOTE: Different storage rates yield different amounts of total storage time. Changes to the storage rate **does not** effect display information. Refer to TABLE 3 for appropriate storage rate.

TABLE 3 - PowerTap SL2.4 Storage Rate

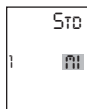
Recording Rate (sec)	1	2
Max Recording Time (hrs)	15	30



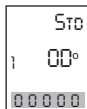
8) Press [SELECT] to toggle through digit values to set the wheel circumference. Press [MODE] to save. Refer to TABLE 4 for common tire information. NOTE: For the most accurate reading perform a roll out measurement (mm) of the rear wheel.

TABLE 4 - Common Wheel Circumferences

Tire Size	Circ. (mm)	Tire Size	Circ (mm)
24 x 1	1753	27 x 1 1/4	2152
26 x 1	1913	700C Tubular	2094
26 x 1.25	1953	700 x 20C	2084
26 x 1.5	1986	700 x 23C	2096
26 x 2.0	2055	700 x 25C	2108
26 x 2.125	2070	700 x 28C	2116
27 x 1	2125	700 x 32C	2136
27 x 1 1/8	2139	700 x 38C	2170



9) Press [SELECT] to toggle between English or Metric units.
Press [MODE] to save.

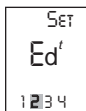


10) Press [SELECT] to set starting odometer reading. Press [MODE] to save.
NOTE: Odometer settings are saved during battery changes.

COMPUTER SETUP 2

This setup menu includes: rate of display for watts, speed, and cadence. NOTE: You are unable to move back to a previously viewed settings. You must restart setup 2 to make corrections. NOTE: These settings **do not** effect the data stored for download.

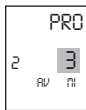
This function can be used to allow better pacing during time trial efforts. A greater rate of display allows for a slower update of the display.



1) From the computer setup main menu press [SELECT] and scroll until the number two (2) is flashing and press [MODE] to enter setup mode.



2) Press [SELECT] to toggle through (1, 2, 3, 5 10, 30) rate of display values in seconds for watts. Press [MODE] to save.



3) Press [SELECT] to toggle between (1, 2, 3, 5 10, 30) rate of display values in seconds for speed. Press [MODE] to save.



4) Press [SELECT] to toggle between (1, 2, 3, 5 10, 30) rate of display values in seconds for cadence. Press [MODE] to save.

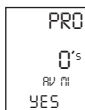
6) Press [SELECT] then [MODE] to reset default settings. Press [MODE] to save changes.

COMPUTER SETUP 3

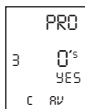
This setup menu includes: zero readings for power, speed, and cadence. NOTE: You are unable to move back to a previously viewed setting. You must restart setup 3 to make corrections. NOTE: These settings are useful for determining you average when pedaling only and **do not** effect the data that is stored for download.



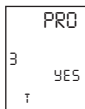
1) Press [SELECT] to toggle between yes and no for zeros included in average of watts. Press [MODE] to save.



2) Press [SELECT] to toggle between yes and no for zeros included in average of speed. Press [MODE] to save.



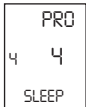
3) Press [SELECT] to toggle between yes and no for zeros included in average of cadence. Press [MODE] to save.



4) Press [SELECT] to toggle between yes and no for auto-zero function. **Normally** leave at yes. NOTE: Auto-zero is used for track bike use where large negative torque may be present. Hub modification to fixed hear is necessary.

COMPUTER SETUP 4

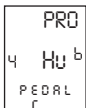
This setup menu includes: sleep time, locations of display, cadence source, cycle computer mode, heart rate monitor, and auto start/stop. You are unable to move back to a previously viewed settings. You must restart setup 4 to make corrections.



1) Press [SELECT] to set how many minutes the computer will stay “awake” after not receiving a valid speed or heart rate signal. Press [MODE] to save. NOTE: The shorter the sleep time the better the battery life.



2) Press [SELECT] to determine what is displayed in the middle line. (mi = speed, c = cadence, ♥ = heart rate). Press [MODE] to save. The selected metric will flash during the ride. NOTE: If heart rate or cadence is selected speed is not displayed. This is useful for intervals when power, heart rate and cadence are most important.



3) Press [SELECT] to determine cadence information source.
Default = pedal then hub
Pedal = crank only
Hub = hub only

NOTE: An optional cadence sensor is available (sold separately). Press [MODE] to save.



4) The PowerTap can be used as a cycle computer or heart rate monitor. Press [SELECT] to toggle through mode options.

watts, mi, and (♥) = power meter mode

mi, and (♥) = cycle computer mode

(♥♥) = heart rate monitor mode

Press [MODE] to save.



5) Press [SELECT] to toggle through auto start options.

mi, and data = allows trip time to count when wheel speed is registering.

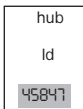
Trip time stops 3 sec. after if speed is not registered.

(♥), and data = allows trip time to count as long as a heart rate signal is registered. This function is useful in the transition from cycling to running and vice versa.

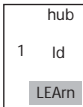
Press [MODE] to save.

COMPUTER SETUP 5

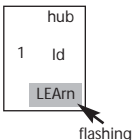
This setup allows the CPU to learn a new device or sensor such as the hub, heart rate strap and optional cadence sensor. NOTE: This process only needs to be used if a new sensor or hub is being used in conjunction with your CPU or vice versa and if batteries are changed in the hub or chest strap. There are 2 Learn sequences, 1 and 2. Learn 1 is used when you have switched sensors or the CPU and there are no other like bikes with PowerTap SL2.4 within a 30' radius. Learn 2 is used if there are other devices in the area but requires you to remove and reinsert the battery before activating the Learn 2 sequence.



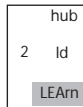
1) To manually change the hub I.D. Push [Select] to toggle through the Hub I.D. Press [Mode] to save.



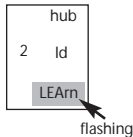
2) In most cases the Hub I.D. will not be known so you can "learn" the I.D. by pressing [Mode] to advance through the Hub I.D. settings to Learn 1. NOTE: Learn 1 will search for any active hub so be sure that there are no other active hubs in the area. If there are, proceed to Learn 2.



3) Learn 1 is initiated by Holding [Select] until "Learn" begins flashing. When the CPU has learned the device I.D. it will display the I.D. Press [Mode] to advance to the next device I.D. If it did not learn the device it will take you back to the most recent Hub I.D. NOTE: Make sure the hub is "awake" by spinning the wheel or axle.



4) Press [Mode] until Learn 2 is displayed. Learn 2 is used when there are other "awake" or active PowerTap SL 2.4 hubs within a 30 foot radius.



5) Initiate Learn 2 by first removing the batteries from the hub for 5 seconds and replacing them. Then hold [Select] until "Learn" begins to flash. When the CPU has learned the hub I.D. it will display the I.D. Press [Mode] to save and proceed to the next device I.D. If it did not learn the device it will take you back to the most recent Hub I.D.

6) Follow the above steps for any additional sensors you may be using, such as the heart rate strap, speed and cadence sensors.

SPd = speed sensor

Cd = cadence sensor

HS = heart rate sensor

Maintenance & Specifications

The following information will help you keep your PowerTap SL2.4 running properly. If you are not familiar with hub maintenance please consult a professional bicycle mechanic before servicing.

During the course of any repair do not remove the torque tube. There are no user serviceable parts inside. Special tools are required for reassembly and calibration. If problems are suspected contact Saris Cycling Group.

BEARINGS

The power measuring components inside the PowerTap SL2.4 are highly complex and should only be serviced by Saris Cycling Group. The bearings are sealed type 6901RS and do not require replacement. Field replacement can cause permanent damage to the power measuring electronics and result in compromised sealing and performance. If bearing problems are suspected please contact Saris Cycling Group at 1-800-783-7257 for a return authorization. The PowerTap SL2.4 uses a modern 4 bearing design and does not require any tensioning adjustment.

FREEHUB

The grease in the freehub pawls should be replaced if it becomes contaminated with water. Replace the seal at the same time, contact Saris Cycling Group for replacement parts. Saris Cycling Group recommends the following types of grease to ensure proper functioning:

- Kluber Isoflex NB52 o
- Dupont Krytox GPL226

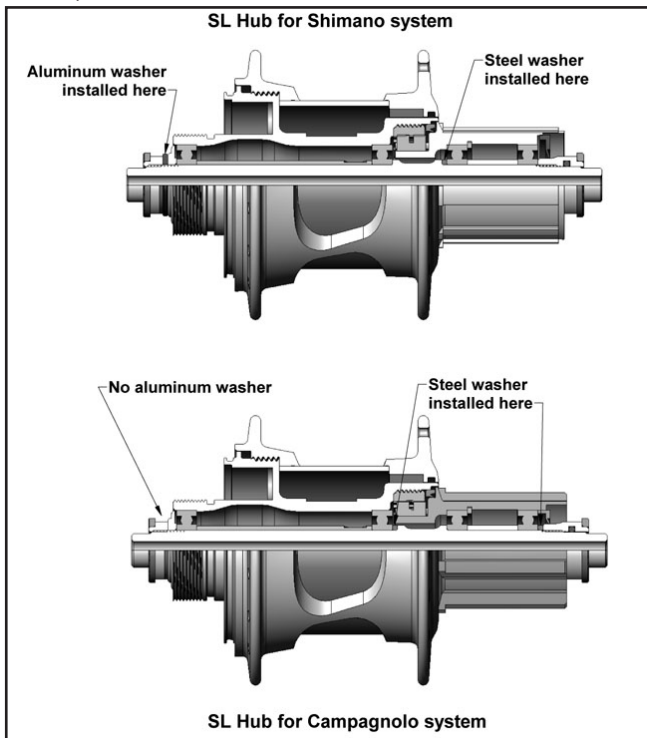
Warning: Failure to use the proper grease on the freehub pawls could result in engagement problems.

FREEHUB REPLACEMENT

- See Figure 28 for illustrations
- Use 5mm hex wrench and 17mm bike wrench and remove both end nuts from the axle.
- Remove the axle
- Remove the freehub and spacers.
- Remove all old grease from the freehub ratchet ring.

- Install spacers per the illustration.
- Install axle.
- Apply 2 grams of high quality freehub grease to the ratchet ring.
- Grease the V seal and place it on the freehub and install onto shaft.
- Replace end nuts. Torque end nuts to 12 lbs-ft.

FIGURE 28



COMPUTER BATTERIES

The PowerTap SL2.4 has batteries in the hub and computer. Computer batteries typically need to be changed every 400 hours of use. The computer will also say "low bat" when the computer battery needs to be changed. This message is displayed after a "clr" is performed. To replace computer battery (Type CR2032), remove the computer from the mount. Remove the battery cover on the back of the computer (use a cone wrench to remove the battery cover), exchange the battery, and replace the cover as shown below (FIGURE 29).

FIGURE 29



TECHNICAL SPECIFICATIONS

Accuracy	+/-1.5%
Signal Transmission	2.4 Ghz
Interval Data Storage	Unlimited
Interval Display	9 Intervals (internal recording)
Operational Temperature	0 to 40 degrees c or 32 to 104 f
Battery Life (Hub)	300 hours approx.
Battery Life (Console)	400 hours approx.
Battery Type (Hub)	Type 357 or EPX 76 (2 ea)
Battery Type (CPU)	ER2032

RANGE OF MEASUREMENT

Power	0-1999 Watts
Torque	0-1999 inch-lbs.
Speed	2-59 mph (3-95 KPH)
Distance	0.00 to 9999.99 (Miles)
Trip Time	0.00.00-999.99 Minutes
Cadence	40-140 RPM
Total energy	0-99999 Kilojoules
Odometer	0-99999 Miles or Kilometers
Heart Rate	0-255 BPM (Beats per Minute)

HUB BATTERIES

Normal battery life in the hub is 400 hours of actual ride time. Use #357 or EPX76 Silver Oxide type batteries and always replace batteries in pairs. Alkaline type batteries give shorter life and poorer performance. NOTE: After replacing batteries in the hub you need to Learn the device codes. *See computer setup 5.*

BATTERY REPLACEMENT

- Unscrew the plastic battery cover. Use a spanner wrench or bench vise opened wide to get it started if stuck. There are O-ring seals that can cause the cover to resist the start of motion. The threading is normal right hand.
- Remove the battery pack. A small screw driver can be used back and forth between the ends to start to lift it out.
- Pop the battery out by bending the plastic retaining tap back and pushing the battery up from the bottom.
- Check that the electrical connector tab from the inside of the hub is perpendicular to the bottom of the battery pocket. If the tab gets bent, gently press it back to perpendicular with a non-sharp tool.
- Slide the battery pack back into position along the center core. As the battery is engaged a small increase of resistance to installation should be felt as the electrical connections are made.
- Thread the cap all the way back on.
- Replacement O-rings and battery packs are available from Saris Cycling Group.

TEST MODE

- 1) From the computer setup main menu press [SELECT] and scroll until the letter "t" is flashing. Press [MODE] to enter setup mode.
- 2) Press [MODE] to scroll through the different test modes as shown by the number. NOTE: Press and hold [MODE] and [SELECT] simultaneously returns to standard operation.

0 - Model and version.

Displays the model on the middle line and version number on the bottom line.

1 - LCD Test

Press [SELECT] all the LCD segments are displayed. Press [SELECT] to return to the normal screen.

2 - Heart Rate Signal Test

NOTE: The heart rate signal is illuminated.

The middle line display flashes "88" with each heart rate blip received.

3- Torque Information

NOTE: The T icon is displayed.

This displays information about the internal workings of the torque readings. The bottom display is the offset torque value directly sent by the hub torque with no correction applied. The hub sends a value of approximately 512 as the zero point. The middle line display is the correction offset value currently stored in the computer. This is the value that is changed when you do a manual zeroing of the torque. The top display is the corrected actual torque (the bottom value minus the middle value).

4 - Standard Test File

This mode writes a small test file to the memory. Press [SELECT] and the bottom lines says "run" and then "yes" when the file is written. This file can then be downloaded.

5 - Communication Loop Back Test

When looking at the front side of the computer, use a coin or paper clip to short out the two pins

on the left side. Press [SELECT]. The bottom line will say "run" and then "yes" if it passes the test correctly. If the pins are not shorted together or there was a problem, the display will say "no". This test can be repeated by pressing [SELECT].

6 - Fast Memory Test

This tests the memory in the computer. Press [SELECT] and "run" is displayed on the bottom line. When the test is completed and it passes, it says "yes". If the test should fail, the bottom line will say "no".

Troubleshooting

No display on computer screen

- Computer is asleep – Press [MODE] or [SELECT] on the computer to wake up the computer.
- Batteries need replacement - replace the computer batteries as shown on pages 14-15 of the User Manual.
- Computer is too cold- operating temp. is 32 to 110 degrees Fahrenheit

Computer display is on, but there is no transmission icon

- Hub is asleep - spin the wheel to wake up the hub.
- Batteries need replacement - replace the hub batteries as shown on page 34 of the User Manual.
- Does the word “watts” appear under the top line? If no than you have entered cycle computer mode. See *cycle computer mode* for further instructions.
- Computer not seated in mount - make sure computer is firmly and correctly mounted in handlebar mount.
- Moisture in hub - remove cover to see if there is any condensation on the battery cover. If there is, leave cover off in a dry place for 12 hours or until moisture disappears.
- Interference with other devices - make sure you are not setting up the PowerTap inside a building with a lot of electrical noise, neon signs, or near power lines. Bring the PowerTap out side or away from the electrical disturbance to see if signal returns. Also make sure you don't have any other devices on your bike such as lights, magnets or cycle computer sensors.
- PowerTap computer's batteries are low, replace batteries as shown on page 34 of the User Manual. We recommend using a Cone Wrench to remove the battery cap, not a coin.

Displayed data blinks or does not function

- Batteries need replacement - replace the computer batteries as shown on pages 34 of the User Manual.
- Computer not seated in mount - make sure computer is firmly and correctly mounted in handlebar mount.
- Interference with other devices - make sure you are not setting up the PowerTap inside a building with a lot of electrical noise, neon signs, or near power lines. Bring the PowerTap outside or away from the electrical disturbance to see if signal returns. Also make sure you don't have any other devices on your bike such as lights, magnets or cycle computer sensors.

Power seems incorrect

· Torque value is not zeroed to manually zero torque go to current watts and hold down the select button until watts disappears. Torque is now being displayed. To zero torque hold down the select button until the value reads zero. To exit torque mode press select once. If read zero the torque does not seem to recalibrate the unit call Saris Cycling Group customer service at 1-800-783-7257.

Speed seems incorrect

· Wheel size incorrect -refer to the chart on page 25 and enter the correct size in setup mode.

Transmission icon flashes rapidly

· Hub batteries need replacement - replace the hub batteries as shown on page 34 of the User Manual.

Glossary

Computer - Refers to the yellow handlebar or stem mounted device.

Heart Rate (HR) - This displays current HR. Max and average values are displayed if [MAX] or [AVG] is selected. NOTE: A non-coded chest strap must be used in order for the console to

pick up heart rate.

Watts - Real-time display of the effort you are putting in to pedaling the bike. This is your power reading. **If you press the [SELECT] while the cursor is pointing to Watts the line changes to "inch-lbs". This is the raw torque value that is being applied to the hub, NOT your power in watts.

Cadence (C) - The number of pedal revolutions per minute. The rate of pedaling is shown from 0 to 140 RPM.

Speed - The estimated speed that you would be traveling on a flat road with no wind is displayed here.

Scroll = to move vertically through available menu or screen options

Toggle = to move horizontally through alphanumeric digits

Cursor = the ® arrow located on console screen

Metrics = a standard of measurement

MAX = Max

RPM = Revolutions Per Minute

MI = Miles Per Hour

KM = Kilometers Per Hour

UI = User Interface

PowerTap SI, Computer Navigation



Saris Cycling Group, Inc.
 5253 Verona Road
 Madison, WI. 53711
 1-800-783-7257

16034D-2.4
 Patents issued and pending.
 Patent#6,418,797