



Wireless test report – 386048-1TRFWL

Applicant:

Dormakaba USA Inc.

Product type:

Fob for electronic locking device

Model:

Switch Fob

Model variant:

1SWFOBxx

FCC ID:

T8H-1SWFOB

ISED Registration number:

7713A-1SWFOB

Specifications:

◆ **FCC 47 CFR Part 15 Subpart C, §15.247**

Operation in the 902–928 MHz, 2400–2483.5 MHz, and 5725–5850 MHz

◆ **RSS-247, Issue 2, Feb 2017, Section 5**

Digital Transmission Systems (DTs), Frequency Hopping Systems (FHSs) and Licence-Exempt Local Area Network (LE-LAN) Devices

5) Standard specifications for frequency hopping systems and digital transmission systems operating in the bands 902–928 MHz, 2400–2483.5 MHz and 5725–5850 MHz

Date of issue: February 2, 2020

Yong Huang, Wireless/EMC Specialist

Tested by

Signature

David Duchesne, Senior EMC/Wireless Specialist

Reviewed by

Signature





Test location(s)

Company name	Nemko Canada Inc.
Site name	Montreal
Address	292 Labrosse Avenue
City	Pointe-Claire
Province	Quebec
Postal code	H9R 5L8
Country	Canada
Telephone	+1 514 694 2684
Facsimile	+1 514 694 3528
Toll free	+1 800 563 6336
Website	www.nemko.com
Site number (3 m SAC)	FCC: CA2041; IC: 2040G-5

Limits of responsibility

Note that the results contained in this report relate only to the items tested and were obtained in the period between the date of initial receipt of samples and the date of issue of the report.

This test report has been completed in accordance with the requirements of ISO/IEC 17025. All results contain in this report are within Nemko Canada's ISO/IEC 17025 accreditation.

Copyright notification

Nemko Canada Inc. authorizes the applicant to reproduce this report provided it is reproduced in its entirety and for use by the company's employees only. Any use which a third party makes of this report, or any reliance on or decisions to be made based on it, are the responsibility of such third parties. Nemko Canada Inc. accepts no responsibility for damages, if any, suffered by any third party as a result of decisions made or actions based on this report.
© Nemko Canada Inc.



Table of contents

Table of contents	3
Section 1. Report summary	4
1.1 Applicant and manufacturer	4
1.2 Test specifications	4
1.3 Test methods.....	4
1.4 Statement of compliance	4
1.5 Exclusions.....	4
1.6 Test report revision history	4
Section 2. Summary of test results	5
2.1 FCC Part 15 Subpart C, general requirements test results.....	5
2.2 FCC Part 15 Subpart C, intentional radiators test results for digital transmission systems (DTS)	5
2.3 ISED RSS-Gen, Issue 5, test results.....	5
2.4 ISED RSS-247, Issue 2, test results for digital transmission systems (DTS).....	5
Section 3. Equipment under test (EUT) details	6
3.1 Sample information.....	6
3.2 EUT information	6
3.3 Technical information	6
3.4 Product description and theory of operation	6
3.5 EUT exercise details.....	6
3.6 EUT setup diagram	7
3.7 EUT sub assemblies	7
Section 4. Engineering considerations	8
4.1 Modifications incorporated in the EUT.....	8
4.2 Technical judgment	8
4.3 Deviations from laboratory tests procedures	8
Section 5. Test conditions	9
5.1 Atmospheric conditions	9
5.2 Power supply range.....	9
Section 6. Measurement uncertainty	10
6.1 Uncertainty of measurement	10
Section 7. Test equipment	11
7.1 Test equipment list.....	11
Section 8. Testing data	12
8.1 FCC 15.31(e) Variation of power source	12
8.2 FCC 15.31(m) and RSS-Gen 6.9 Number of frequencies	13
8.3 FCC 15.203 and RSS-Gen, section 6.8 Antenna requirement.....	14
8.4 FCC 15.247(a)(2) and RSS-247 5.2(a) Minimum 6 dB bandwidth for DTS systems	15
8.5 FCC 15.247(b) and RSS-247 5.4(d) Transmitter output power and e.i.r.p. requirements for DTS in 2 GHz	18
8.6 FCC 15.247(d) and RSS-247 5.5 Spurious (out-of-band) unwanted emissions.....	21
8.7 FCC 15.247(e) and RSS-247 5.2(b) Power spectral density for digitally modulated devices	28
Section 9. Block diagrams of test set-ups	30
9.1 Radiated emissions set-up for frequencies below 1 GHz.....	30
9.2 Radiated emissions set-up for frequencies above 1 GHz.....	30

Section 1. Report summary

1.1 Applicant and manufacturer

Company name	Dormakaba USA Inc.
Address	6161 E. 75th Street 46250 Indianapolis IN USA

1.2 Test specifications

FCC 47 CFR Part 15, Subpart C, Clause 15.247	Operation in the 902–928 MHz, 2400–2483.5 MHz, and 5725–585 MHz
RSS-247, Issue 2, Feb 2017, Section 5	Digital Transmission Systems (DTSs), Frequency Hopping Systems (FHSs) and Licence-Exempt Local Area Network (LE-LAN) Devices

1.3 Test methods

ANSI C63.10 v2013	American National Standard of Procedures for Compliance Testing of Unlicensed Wireless Devices
RSS-Gen, Issue 5 Amendment 1, March 2019	General Requirements for Compliance of Radio Apparatus

1.4 Statement of compliance

In the configuration tested, the EUT was found compliant.

Testing was performed against all relevant requirements of the test standard except as noted in section 1.5 below. Results obtained indicate that the product under test complies in full with the requirements tested. The test results relate only to the items tested.

See “Summary of test results” for full details.

1.5 Exclusions

None

1.6 Test report revision history

Table 1.6-1: Test report revision history

Revision #	Date of issue	Details of changes made to test report
TRF	February 2, 2020	Original report issued

Section 2. Summary of test results

2.1 FCC Part 15 Subpart C, general requirements test results

Table 2.1-1: FCC general requirements results

Part	Test description	Verdict
§15.207(a)	Conducted limits	Not applicable
§15.31(e)	Variation of power source	Pass
§15.31(m)	Number of tested frequencies	Pass
§15.203	Antenna requirement	Pass

Notes: EUT is a battery operated device, the testing was performed using DC power supply in place of fresh batteries.

2.2 FCC Part 15 Subpart C, intentional radiators test results for digital transmission systems (DTS)

Table 2.2-1: FCC 15.247 results for DTS

Part	Test description	Verdict
§15.247(a)(2)	Minimum 6 dB bandwidth	Pass
§15.247(b)(3)	Maximum peak output power in the 902–928 MHz, 2400–2483.5 MHz, and 5725–5850 MHz bands	Pass
§15.247(c)(1)	Fixed point-to-point operation with directional antenna gains greater than 6 dBi	Not applicable
§15.247(c)(2)	Transmitters operating in the 2400–2483.5 MHz band that emit multiple directional beams	Not applicable
§15.247(d)	Spurious emissions	Pass
§15.247(e)	Power spectral density	Pass
§15.247(f)	Time of occupancy for hybrid systems	Not applicable

2.3 ISSED RSS-Gen, Issue 5, test results

Table 2.3-1: RSS-Gen results

Part	Test description	Verdict
7.3	Receiver radiated emission limits	Not applicable
7.4	Receiver conducted emission limits	Not applicable
6.9	Operating bands and selection of test frequencies	Pass
8.8	AC power-line conducted emissions limits	Not applicable

Notes: ¹ According to sections 5.2 and 5.3 of RSS-Gen, Issue 5 the EUT does not have a stand-alone receiver neither scanner receiver, therefore exempt from receiver requirements. EUT is a battery operated device, the testing was performed using DC power supply in place of fresh batteries.

2.4 ISSED RSS-247, Issue 2, test results for digital transmission systems (DTS)

Table 2.4-1: RSS-247 results for DTS

Part	Test description	Verdict
5.2 (a)	Minimum 6 dB bandwidth	Pass
5.2 (b)	Maximum power spectral density	Pass
5.3	Hybrid Systems	
5.3 (a)	Digital modulation turned off	Not applicable
5.3 (b)	Frequency hopping turned off	Not applicable
5.4	Transmitter output power and e.i.r.p. requirements	
5.4 (d)	Systems employing digital modulation techniques	Pass
5.4 (e)	Point-to-point systems in 2400–2483.5 MHz and 5725–5850 MHz band	Not applicable
5.4 (f)	Transmitters which operate in the 2400–2483.5 MHz band with multiple directional beams	Not applicable
5.5	Unwanted emissions	Pass

Section 3. Equipment under test (EUT) details

3.1 Sample information

Receipt date	November 22, 2019
Nemko sample ID number	1

3.2 EUT information

Product type	Fob for electronic locking device
Model	Swtich Fob
Model variant	1SWFOBxx (where xx is the color code)
Serial number	K3163.002282

3.3 Technical information

Applicant ISED company number	7713A
ISED UPN number	1SWFOB
All used IC test site(s) Reg. number	2040G-5
RSS number and Issue number	RSS-247 Issue 2, Feb 2017
Frequency band	2400–2483.5 MHz
Frequency Min (MHz)	2402
Frequency Max (MHz)	2480
RF power Max (W), Conducted	N/A
Field strength, dB μ V/m @ 3 m	94.4
Measured BW (kHz), 99% OBW	1070.5
Type of modulation	GFSK
Emission classification (F1D, G1D, D1D)	F1D
Transmitter spurious, dB μ V/m @ 3 m	50.8 dB μ V/m @ 3 m, at 2483.5 MHz
Power requirements	3 V _{DC} battery
Antenna information	The EUT uses a non-detachable antenna to the intentional radiator.(trace antenna ,inverted F antenna) Antenna max peak gain is 2.2 dBi

3.4 Product description and theory of operation

The Switch Fob is a small battery-operated remote control for the Switch Core electronic lock. It is used to transmit a digital credential wirelessly through Bluetooth communication to the lock. The Switch Fob is normally in a low-power sleep state. When the user wishes to unlock a door, the he first wakes up the Switch Core lock by touching the knob and then presses the switch on the Fob. This initiates BLE communication between the Fob and the Lock and the credential is passed from the Fob to the lock. If the credential is accepted, the electronic lock will unlock the mechanism and allow the user to rotate the knob the same way a user would turn a key in a mechanical lock.

3.5 EUT exercise details

EUT was set with test firmware up by client on site, continuous transmit mode was configured during transmitter tests. The test firmware revision was 0.7.3.243. Note that the coin cell battery was replaced with a power supply during the test to be able to sustain continuous transmission.

3.6 EUT setup diagram

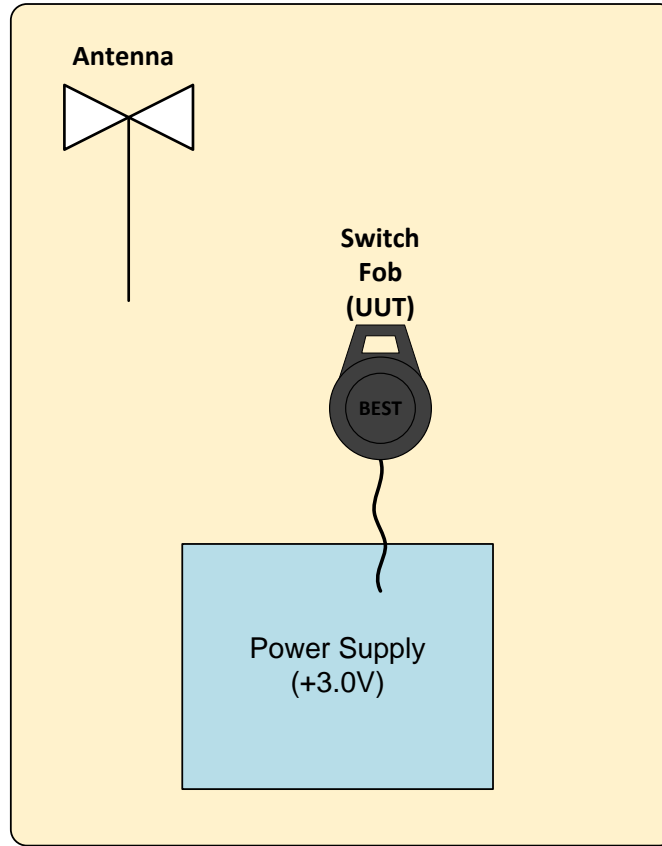

Figure 3.6-1: Setup diagram

3.7 EUT sub assemblies

Table 3.7-1: EUT sub assemblies

Description	Brand name	Model/Part number	Serial number
Fob for electronic lock	BEST	Switch Fob/1SWFOBxx	K3163.0002282

Section 4. Engineering considerations

4.1 Modifications incorporated in the EUT

There were no modifications performed to the EUT during this assessment.

4.2 Technical judgment

None

4.3 Deviations from laboratory tests procedures

No deviations were made from laboratory procedures.

Section 5. Test conditions

5.1 Atmospheric conditions

Temperature	15–30 °C
Relative humidity	20–75 %
Air pressure	860–1060 mbar

When it is impracticable to carry out tests under these conditions, a note to this effect stating the ambient temperature and relative humidity during the tests shall be recorded and stated.

5.2 Power supply range

The normal test voltage for equipment to be connected to the mains shall be the nominal mains voltage. For the purpose of the present document, the nominal voltage shall be the declared voltage, or any of the declared voltages $\pm 5\%$, for which the equipment was designed.

Section 6. Measurement uncertainty

6.1 Uncertainty of measurement

UKAS Lab 34 and TIA-603-B have been used as guidance for measurement uncertainty reasonable estimations with regards to previous experience and validation of data. Nemko Canada, Inc. follows these test methods in order to satisfy ISO/IEC 17025 requirements for estimation of uncertainty of measurement for wireless products.

Measurement uncertainty budgets for the tests are detailed below. Measurement uncertainty calculations assume a coverage factor of $K = 2$ with 95% certainty.

Table 6.1-1: Measurement uncertainty

Test name	Measurement uncertainty, dB
All antenna port measurements	0.55
Conducted spurious emissions	1.13
Radiated spurious emissions	3.78
AC power line conducted emissions	3.55

Section 7. Test equipment

7.1 Test equipment list

Table 7.1-1: Equipment list

Equipment	Manufacturer	Model no.	Asset no.	Cal cycle	Next cal.
3 m EMI test chamber (Emissions)	TDK	SAC-3	FA002532e	2 year	January 10, 2020
Flush mount turntable	Sunol	FM2022	FA002550	—	NCR
Controller	Sunol	SC104V	FA002551	—	NCR
Antenna mast	Sunol	TLT2	FA002552	—	NCR
Receiver/spectrum analyzer	Rohde & Schwarz	ESU 40	FA002071	1 year	December 6, 2019
Bilog antenna (20–2000 MHz)	Sunol	JB1	FA002517	1 year	January 3, 2020
Horn antenna (1–18 GHz)	EMCO	3115	FA001451	1 year	April 12, 2020
Horn antenna (18–40 GHz)	EMCO	3116	FA002487	2 year	September 11, 2020
Pre-amplifier (0.5–18 GHz)	Com-Power	PAM-118A	FA002561	1 year	September 18, 2020
Pre-amplifier (18–40 GHz)	Com-Power	PAM-840	FA002508	1 year	September 20, 2020
50 Ω coax cable	C.C.A.	None	FA002603	1 year	February 5, 2020
Multimeter	AMPPROBE	AM-530	FA002536	1 year	May 6, 2020
50 Ω coax cable	C.C.A.	None	FA002605	—	VOU
50 Ω coax cable	C.C.A.	None	FA002831	—	VOU
DC Power Supply	Sorensen	SGA80X125C-AAA	FA002738	—	NCR

Note: NCR - no calibration required, VOU - verify on use

Section 8. Testing data

8.1 FCC 15.31(e) Variation of power source

8.1.1 Definitions and limits

FCC §15.31:

(e) For intentional radiators, measurements of the variation of the input power or the radiated signal level of the fundamental frequency component of the emission, as appropriate, shall be performed with the supply voltage varied between 85% and 115% of the nominal rated supply voltage. For battery operated equipment, the equipment tests shall be performed using a new battery.

8.1.2 Test date

Start date November 22, 2019

8.1.3 Observations, settings and special notes

The testing was performed as per ANSI C63.10 Section 5.13.

- a) Where the device is intended to be powered from an external power adapter, the voltage variations shall be applied to the input of the adapter provided with the device at the time of sale. If the device is not marketed or sold with a specific adapter, then a typical power adapter shall be used.
- b) For devices where operating at a supply voltage deviating $\pm 15\%$ from the nominal rated value may cause damages or loss of intended function, test to minimum and maximum allowable voltage per manufacturer's specification and document in the report.
- c) For devices with wide range of rated supply voltage, test at 15% below the lowest and 15% above the highest declared nominal rated supply voltage.
- d) For devices obtaining power from an input/output (I/O) port (USB, firewire, etc.), a test jig is necessary to apply voltage variation to the device from a support power supply, while maintaining the functionalities of the device.

For battery-operated equipment, the equipment tests shall be performed using a variable power supply.

8.1.4 Test data

During the tests, a DC power supply was used in place of a fresh battery. It's deemed to be a worst case scenario in respect of radiated emissions tests.



8.2 FCC 15.31(m) and RSS-Gen 6.9 Number of frequencies

8.2.1 Definitions and limits

FCC §15.31:

(m) Measurements on intentional radiators or receivers, other than TV broadcast receivers, shall be performed and, if required, reported for each band in which the device can be operated with the device operating at the number of frequencies in each band specified in the following table:

RSS-Gen Section 6.9:

Except where otherwise specified, measurements shall be performed for each frequency band of operation for which the radio apparatus is to be certified, with the device operating at the frequencies in each band of operation shown in table below. The frequencies selected for measurements shall be reported in the test report.

Table 8.2-1: Frequency Range of Operation

Frequency range over which the device operates (in each band)	Number of test frequencies required	Location of measurement frequency inside the operating frequency range
1 MHz or less	1	Center (middle of the band)
1–10 MHz	2	1 near high end, 1 near low end
Greater than 10 MHz	3	1 near high end, 1 near center and 1 near low end

Note: “near” means as close as possible to or at the centre / low end / high end of the frequency range over which the device operates.

8.2.2 Test date

Start date December 3, 2019

8.2.3 Observations, settings and special notes

Per ANSI C63.10 Subclause 5.6.2.1:

The number of channels tested can be reduced by measuring the center channel bandwidth first and then applying the following relaxations as appropriate:

- a) For each operating mode, if the measured channel bandwidth on the middle channel is at least 150% of the minimum permitted bandwidth, then it is not necessary to measure the bandwidth on the high and low channels.
- b) For multiple-input multiple-output (MIMO) systems, if the measured channel bandwidth on testing the middle channel exceeds the minimum permitted bandwidth by more than 50% on one transmit chain, then it is not necessary to repeat testing on the other chains.
- c) If the measured channel bandwidth on the middle channel is less than 50% of the maximum permitted bandwidth, then it is not necessary to measure the bandwidth on the high and low channels.

Per ANSI C63.10 Subclause 5.6.2.2:

For devices with multiple operating modes, measurements on the middle channel can be used to determine the worst-case mode(s). The worst-case modes are as follows:

- a) Band edge requirements—Measurements on the mode with the widest bandwidth can be used to cover the same channel (center frequency) on modes with narrower bandwidth that have the same or lower output power for each modulation family (e.g., OFDM and direct sequence spread spectrum).
- b) Spurious emissions—Measure the mode with the highest output power and the mode with the highest output power spectral density for each modulation family (e.g., OFDM and direct sequence spread spectrum).
- c) In-band PSD—Measurements on the mode with the narrowest bandwidth can be used to cover all modes within the same modulation family of an equal or lower output power provided the result is less than 50% of the limit.

8.2.4 Test data

Table 8.2-2: Test channels selection

Start of Frequency range, MHz	End of Frequency range, MHz	Frequency range bandwidth, MHz	Low channel, MHz	Mid channel, MHz	High channel, MHz
2400	2483.5	83.5	2402	2440	2480

8.3 FCC 15.203 and RSS-Gen, section 6.8 Antenna requirement

8.3.1 Definitions and limits

FCC §15.203:

An intentional radiator shall be designed to ensure that no antenna other than that furnished by the responsible party shall be used with the device. The use of a permanently attached antenna or of an antenna that uses a unique coupling to the intentional radiator shall be considered sufficient to comply with the provisions of this section. The manufacturer may design the unit so that a broken antenna can be replaced by the user, but the use of a standard antenna jack or electrical connector is prohibited. This requirement does not apply to intentional radiators that must be professionally installed, such as perimeter protection systems and some field disturbance sensors, or to other intentional radiators which, in accordance with §15.31(d), must be measured at the installation site. However, the installer shall be responsible for ensuring that the proper antenna is employed so that the limits in this part are not exceeded.

RSS-Gen Section 6.8:

The applicant for equipment certification shall provide a list of all antenna types that may be used with the transmitter, where applicable (i.e. for transmitters with detachable antenna), indicating the maximum permissible antenna gain (in dBi) and the required impedance for each antenna. The test report shall demonstrate the compliance of the transmitter with the limit for maximum equivalent isotropically radiated power (e.i.r.p.) specified in the applicable RSS, when the transmitter is equipped with any antenna type, selected from this list.

For expediting the testing, measurements may be performed using only the antenna with highest gain of each combination of transmitter and antenna type, with the transmitter output power set at the maximum level. However, the transmitter shall comply with the applicable requirements under all operational conditions and when in combination with any type of antenna from the list provided in the test report.

8.3.2 Test date

Start date December 3, 2019

8.3.3 Observations, settings and special notes

None

8.3.4 Test data

- The EUT has an internal integrated antenna, non-detachable.
- The EUT is not professionally installed.



8.4 FCC 15.247(a)(2) and RSS-247 5.2(a) Minimum 6 dB bandwidth for DTS systems

8.4.1 Definitions and limits

FCC §15.247 (a)(2):

- (a) Operation under the provisions of this Section is limited to frequency hopping and digitally modulated intentional radiators that comply with the following provisions:
 - (2) Systems using digital modulation techniques may operate in the 902–928 MHz, 2400–2483.5 MHz and 5725–5850 MHz bands. The minimum 6 dB bandwidth shall be at least 500 kHz.

RSS-247 Section 5.2 (a):

The minimum 6 dB bandwidth shall be 500 kHz.

8.4.2 Test date

Start date December 3, 2019

8.4.3 Observations, settings and special notes

The test was performed by radiated measurement, as per reference to ANSI C63.10 subclause 11.8.

Spectrum analyser settings, 6 dB bandwidth:

Bandwidth	Resolution: 100 kHz, Video: $\geq 3 \times$ RBW
Frequency span	2 MHz
Detector mode	Peak
Trace mode	Max Hold

Spectrum analyser settings, 99 Percent bandwidth:

Bandwidth	Resolution: 30 kHz, Video: $\geq 3 \times$ RBW
Frequency span	2 MHz
Detector mode	Peak
Trace mode	Max Hold

8.4.4 Test data

Table 8.4-1: 6 dB bandwidth results

Frequency, MHz	6 dB bandwidth, kHz	Limit, kHz	Margin, kHz
2402	708.3	500	208.3
2440	721.2	500	221.2
2480	711.5	500	211.5

Notes: None

Table 8.4-2: 99% bandwidth results

Frequency, MHz	99% bandwidth, kHz
2402	1070.5
2440	1070.5
2480	1067.3

Notes: None

8.4.4 Test data, continued

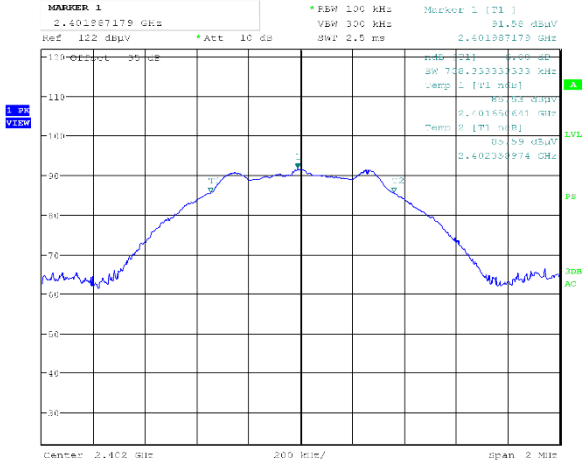

DeLw: 4.DEC.2019 15:52:31

Figure 8.4-1: 6 dB bandwidth on low channel

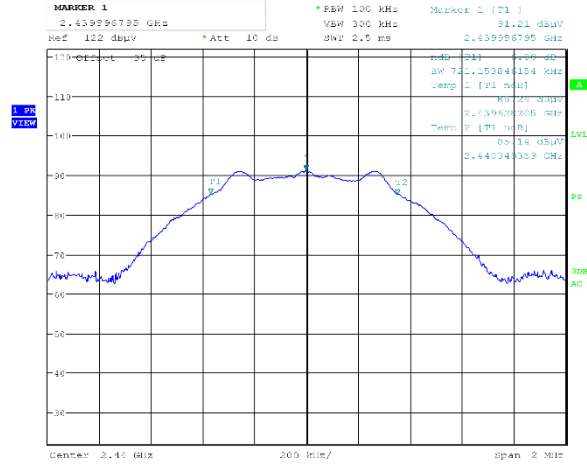

DeLw: 4.DEC.2019 14:57:26

Figure 8.4-2: 6 dB bandwidth on mid channel

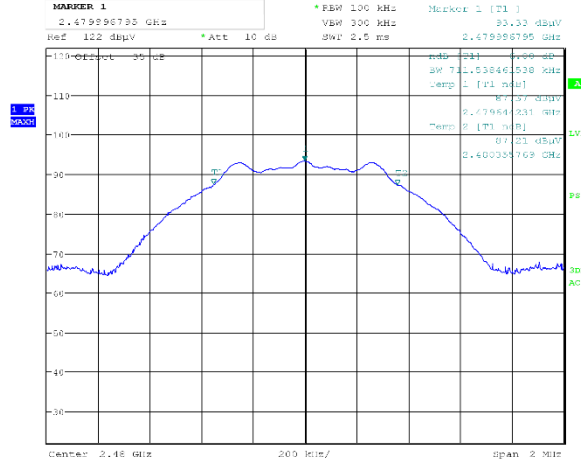

DeLw: 4.DEC.2019 15:24:15

Figure 8.4-3: 6 dB bandwidth on high channel

8.4.4 Test data, continued

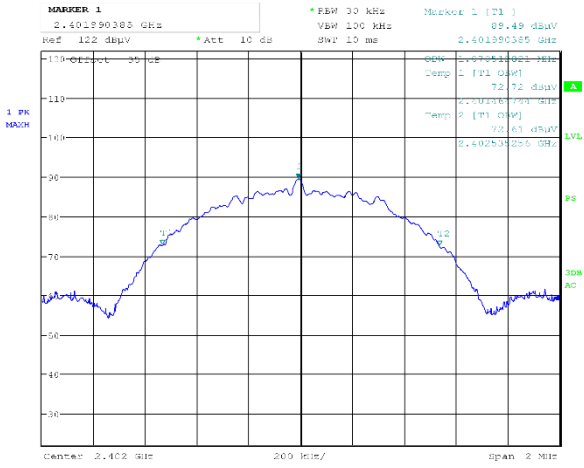

Date: 4.DEC.2019 15:51:34

Figure 8.4-4: 99% bandwidth on low channel

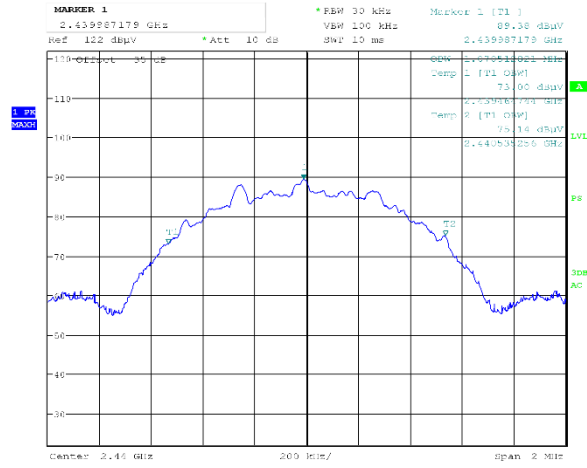

Date: 4.DEC.2019 14:58:42

Figure 8.4-5: 99% bandwidth on mid channel

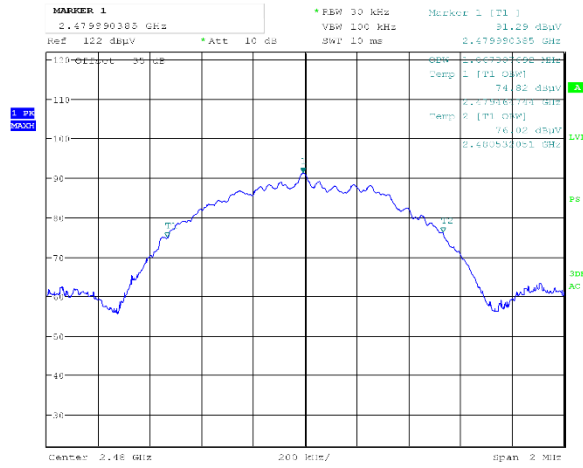

Date: 4.DEC.2019 15:25:27

Figure 8.4-6: 99% bandwidth on high channel



8.5 FCC 15.247(b) and RSS-247 5.4(d) Transmitter output power and e.i.r.p. requirements for DTS in 2 GHz

8.5.1 Definitions and limits

FCC §15.247:

- (b) The maximum peak conducted output power of the intentional radiator shall not exceed the following:
 - (3) For systems using digital modulation in the 902-928 MHz, 2400-2483.5 MHz, and 5725-5850 MHz bands: 1 Watt. As an alternative to a peak power measurement, compliance with the one Watt limit can be based on a measurement of the maximum conducted output power. Maximum Conducted Output Power is defined as the total transmit power delivered to all antennas and antenna elements averaged across all symbols in the signaling alphabet when the transmitter is operating at its maximum power control level. Power must be summed across all antennas and antenna elements. The average must not include any time intervals during which the transmitter is off or is transmitting at a reduced power level. If multiple modes of operation are possible (e.g., alternative modulation methods), the *maximum conducted output power* is the highest total transmit power occurring in any mode.
 - (4) The conducted output power limit specified in paragraph (b) of this section is based on the use of antennas with directional gains that do not exceed 6 dBi. Except as shown in paragraph (c) of this section, if transmitting antennas of directional gain greater than 6 dBi are used, the conducted output power from the intentional radiator shall be reduced below the stated values in paragraphs (b)(1), (b)(2), and (b)(3) of this section, as appropriate, by the amount in dB that the directional gain of the antenna exceeds 6 dBi.

RSS-247 Section 5.4:

- d. For DTSs employing digital modulation techniques operating in the bands 902-928 MHz and 2400-2483.5 MHz, the maximum peak conducted output power shall not exceed 1 W. The e.i.r.p. shall not exceed 4 W, except as provided in section 5.4(e).

As an alternative to a peak power measurement, compliance can be based on a measurement of the maximum conducted output power. The maximum conducted output power is the total transmit power delivered to all antennas and antenna elements, averaged across all symbols in the signalling alphabet when the transmitter is operating at its maximum power control level. Power must be summed across all antennas and antenna elements. The average must not include any time intervals during which the transmitter is off or transmitting at a reduced power level. If multiple modes of operation are implemented, the maximum conducted output power is the highest total transmit power occurring in any mode

8.5.2 Test date

Start date December 3, 2019



8.5.3 Observations, settings and special notes

- The test was performed as per reference to ANSI C63.10 subclause 11.9.1 (peak power)
- The test was performed using method RBW≥DTS bandwidth (Maximum peak conducted output power)

Spectrum analyser settings:

Resolution bandwidth	3 MHz
Video bandwidth	≥3 × RBW
Frequency span	10 MHz
Detector mode	Peak
Trace mode	Max hold

8.5.4 Test data

Table 8.5-1: Output power measurements results

Frequency, MHz	Field Strength at 3 m, dBµV/m	EIRP, dBm	EIRP limit, dBm	EIRP margin, dB	Antenna gain, dBi	Conducted output power, dBm		Margin, dB
						Calculated	Limit	
2402	92.8	-2.4	36.0	38.4	2.2	-4.6	30.0	34.6
2440	92.5	-2.7	36.0	38.7	2.2	-4.9	30.0	34.9
2480	94.4	-0.8	36.0	36.8	2.2	-3.0	30.0	33.0

Note: Tests were performed by radiated measurement, calculation as below:

EIRP = Field Strength at 3 m – 95.2 dB



8.5.4 Test data, continued

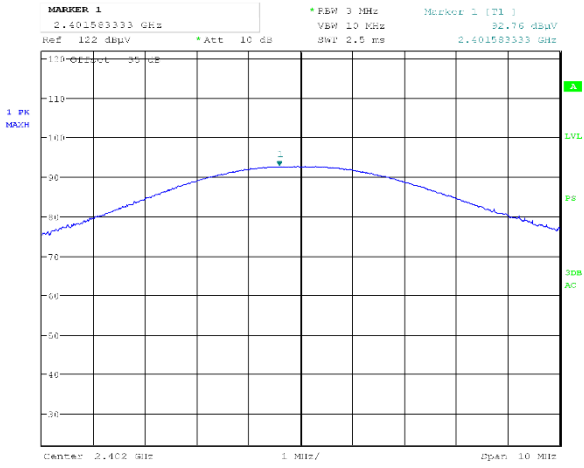

Del: 4.DEC.2019 15:50:16

Figure 8.5-1: Field strength of Fundamental on low channel

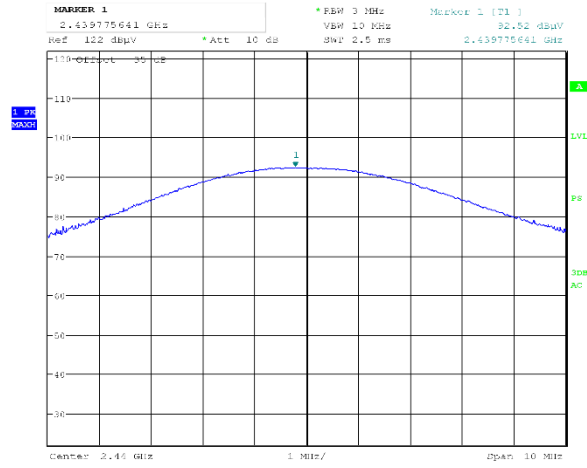

Del: 4.DEC.2019 14:50:45

Figure 8.5-2: Field strength of Fundamental on mid channel

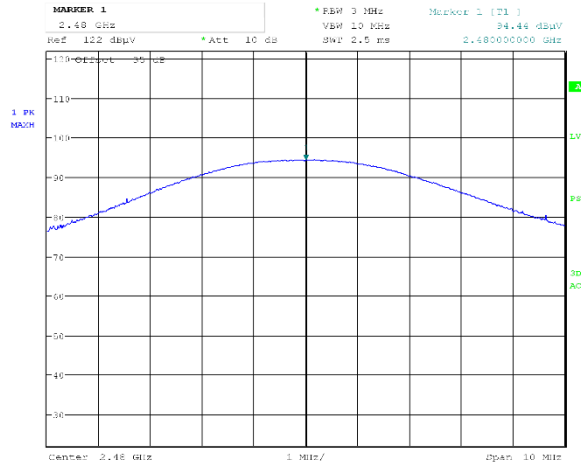

Del: 4.DEC.2019 15:22:41

Figure 8.5-3: Field strength of Fundamental on high channel



8.6 FCC 15.247(d) and RSS-247 5.5 Spurious (out-of-band) unwanted emissions

8.6.1 Definitions and limits

FCC §15.207 (d):

In any 100 kHz bandwidth outside the frequency band in which the spread spectrum or digitally modulated intentional radiator is operating, the radio frequency power that is produced by the intentional radiator shall be at least 20 dB below that in the 100 kHz bandwidth within the band that contains the highest level of the desired power, based on either an RF conducted or a radiated measurement, provided the transmitter demonstrates compliance with the peak conducted power limits. If the transmitter complies with the conducted power limits based on the use of RMS averaging over a time interval, as permitted under paragraph (b)(3) of this section, the attenuation required under this paragraph shall be 30 dB instead of 20 dB. Attenuation below the general limits specified in §15.209(a) is not required. In addition, radiated emissions which fall in the restricted bands, as defined in §15.205(a), must also comply with the radiated emission limits specified in §15.209(a) (see §15.205(c)).

RSS-247 Section 5.5:

In any 100 kHz bandwidth outside the frequency band in which the spread spectrum or digitally modulated device is operating, the RF power that is produced shall be at least 20 dB below that in the 100 kHz bandwidth within the band that contains the highest level of the desired power, based on either an RF conducted or a radiated measurement, provided that the transmitter demonstrates compliance with the peak conducted power limits. If the transmitter complies with the conducted power limits based on the use of root-mean-square averaging over a time interval, as permitted under section 5.4(d), the attenuation required shall be 30 dB instead of 20 dB. Attenuation below the general field strength limits specified in RSS-Gen is not required.

Table 8.6-1: FCC §15.209 and RSS-Gen – Radiated emission limits

Frequency, MHz	Field strength of emissions		Measurement distance, m
	µV/m	dBµV/m	
0.009–0.490	2400/F	67.6 – 20 × log ₁₀ (F)	300
0.490–1.705	24000/F	87.6 – 20 × log ₁₀ (F)	30
1.705–30.0	30	29.5	30
30–88	100	40.0	3
88–216	150	43.5	3
216–960	200	46.0	3
above 960	500	54.0	3

Notes: In the emission table above, the tighter limit applies at the band edges.

For frequencies above 1 GHz the limit on peak RF emissions is 20 dB above the maximum permitted average emission limit applicable to the equipment under test

Table 8.6-2: ISED restricted frequency bands

MHz	MHz	MHz	GHz
0.090–0.110	12.57675–12.57725	399.9–410	7.25–7.75
0.495–0.505	13.36–13.41	608–614	8.025–8.5
2.1735–2.1905	16.42–16.423	960–1427	9.0–9.2
3.020–3.026	16.69475–16.69525	1435–1626.5	9.3–9.5
4.125–4.128	16.80425–16.80475	1645.5–1646.5	10.6–12.7
4.17725–4.17775	25.5–25.67	1660–1710	13.25–13.4
4.20725–4.20775	37.5–38.25	1718.8–1722.2	14.47–14.5
5.677–5.683	73–74.6	2200–2300	15.35–16.2
6.215–6.218	74.8–75.2	2310–2390	17.7–21.4
6.26775–6.26825	108–138	2483.5–2500	22.01–23.12
6.31175–6.31225	149.9–150.05	2655–2900	23.6–24.0
8.291–8.294	156.52475–156.52525	3260–3267	31.2–31.8
8.362–8.366	156.7–156.9	3332–3339	36.43–36.5
8.37625–8.38675	162.0125–167.17	3345.8–3358	
8.41425–8.41475	167.72–173.2	3500–4400	
12.29–12.293	240–285	4500–5150	Above 38.6
12.51975–12.52025	322–335.4	5350–5460	

Note: Certain frequency bands listed in

Table 8.6-2 and above 38.6 GHz are designated for licence-exempt applications. These frequency bands and the requirements that apply to related devices are set out in the 200 and 300 series of RSSS

8.6.1 Definitions and limits, continued

Table 8.6-3: FCC restricted frequency bands

MHz	MHz	MHz	GHz
0.090–0.110	16.42–16.423	399.9–410	4.5–5.15
0.495–0.505	16.69475–16.69525	608–614	5.35–5.46
2.1735–2.1905	16.80425–16.80475	960–1240	7.25–7.75
4.125–4.128	25.5–25.67	1300–1427	8.025–8.5
4.17725–4.17775	37.5–38.25	1435–1626.5	9.0–9.2
4.20725–4.20775	73–74.6	1645.5–1646.5	9.3–9.5
6.215–6.218	74.8–75.2	1660–1710	10.6–12.7
6.26775–6.26825	108–121.94	1718.8–1722.2	13.25–13.4
6.31175–6.31225	123–138	2200–2300	14.47–14.5
8.291–8.294	149.9–150.05	2310–2390	15.35–16.2
8.362–8.366	156.52475–156.52525	2483.5–2500	17.7–21.4
8.37625–8.38675	156.7–156.9	2690–2900	22.01–23.12
8.41425–8.41475	162.0125–167.17	3260–3267	23.6–24.0
12.29–12.293	167.72–173.2	3332–3339	31.2–31.8
12.51975–12.52025	240–285	3345.8–3358	36.43–36.5
12.57675–12.57725	322–335.4	3600–4400	Above 38.6
13.36–13.41			

8.6.2 Test date

Start date December 3, 2019

8.6.3 Observations, settings and special notes

- The spectrum was searched from 30 MHz to the 10th harmonic. No emissions were detected within 6 dB below the limit above 18 GHz.
- EUT was set to transmit with 100 % duty cycle.
- Radiated measurements were performed at a distance of 3 m, with actual antenna.
- DTS emissions in non-restricted frequency bands test was performed as per ANSI C63.10 subclause 11.11.
- Since fundamental power was tested using the maximum peak conducted output power procedure to demonstrate compliance, the spurious emissions limit is –20 dBc/100 kHz. All radiated spurious emissions are found to be more than 20 dB below the fundamental.
- DTS emissions in restricted frequency bands test was performed as per ANSI C63.10 subclause 11.12.
- DTS band-edge emission measurements test was performed as per ANSI C63.10 subclause 11.13.

Spectrum analyser settings for radiated measurements within restricted bands:

Resolution bandwidth:	Frequencies below 1 GHz: 100 kHz, Frequencies above 1 GHz: 1 MHz
Video bandwidth:	Frequencies below 1 GHz: 300 kHz, Frequencies above 1 GHz: 3 MHz
Detector mode:	Peak
Trace mode:	Max Hold

Spectrum analyser settings for average radiated measurements within restricted bands above 1 GHz:

Resolution bandwidth:	1 MHz
Video bandwidth:	10 Hz
Detector mode:	Peak
Trace mode:	Max Hold

Spectrum analyser settings for spurious emissions measurements:

Resolution bandwidth:	100 kHz
Video bandwidth:	300 kHz
Detector mode:	Peak
Trace mode:	Max Hold

8.6.4 Test data

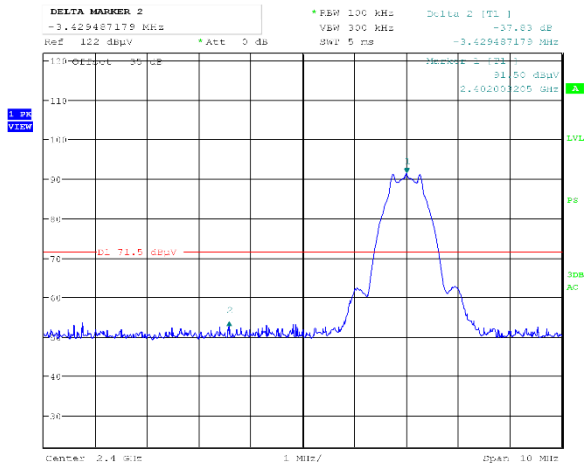

Date: 4.DEC.2019 15:58:43

Figure 8.6-1: Radiated spurious emission at band edge outside restricted band, low channel

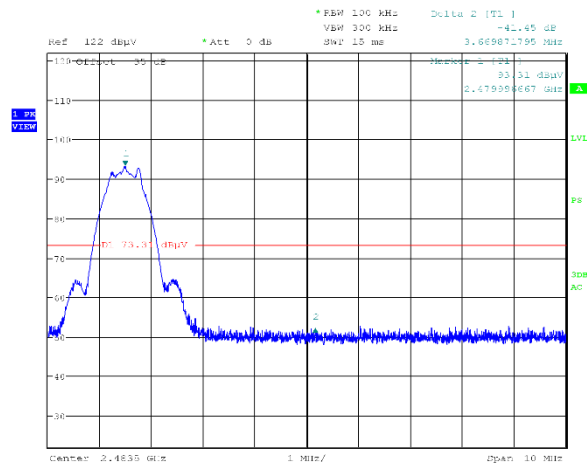

Date: 4.DEC.2019 15:28:27

Figure 8.6-2: Radiated spurious emissions at band edge outside restricted band, High channel

8.6.4 Test data, continued

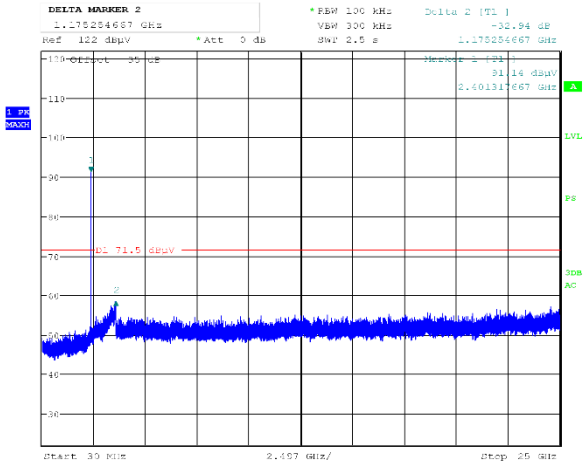

Date: 4.DEC.2019 15:59:50

Figure 8.6-3: Radiated spurious emission outside restricted band, low channel

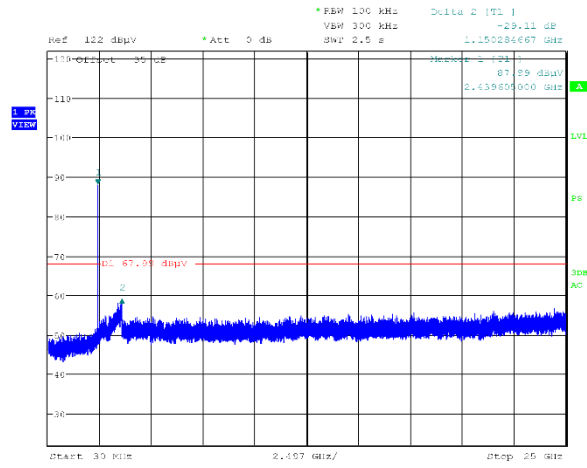

Date: 4.DEC.2019 15:33:27

Figure 8.6-4: Radiated spurious emissions outside restricted band, mid channel

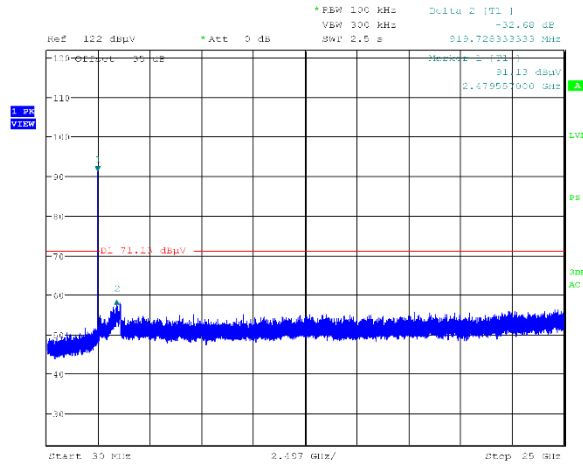

Date: 4.DEC.2019 15:31:26

Figure 8.6-5: Radiated spurious emissions outside restricted band, High channel

8.6.4 Test data, continued

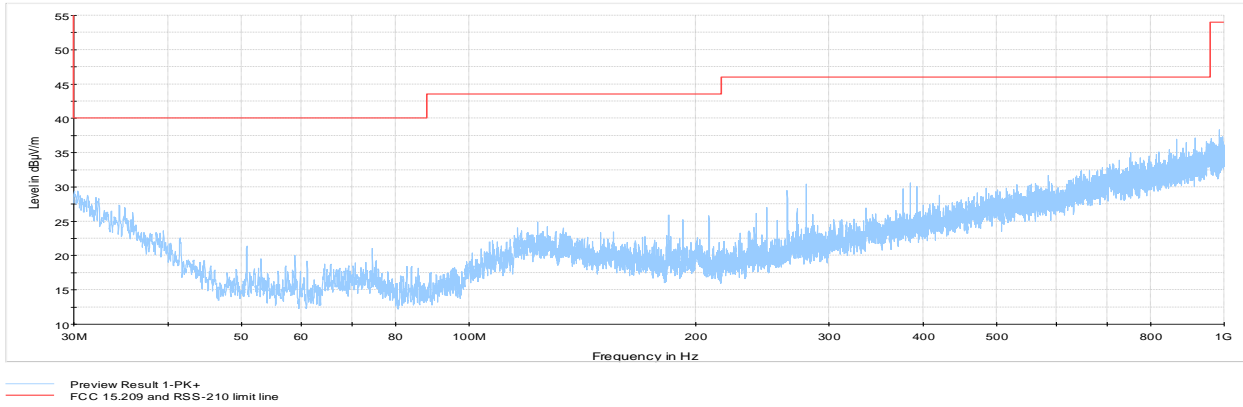

Figure 8.6-6: Radiated spurious emissions 30 MHz to 1 GHz, Low channel

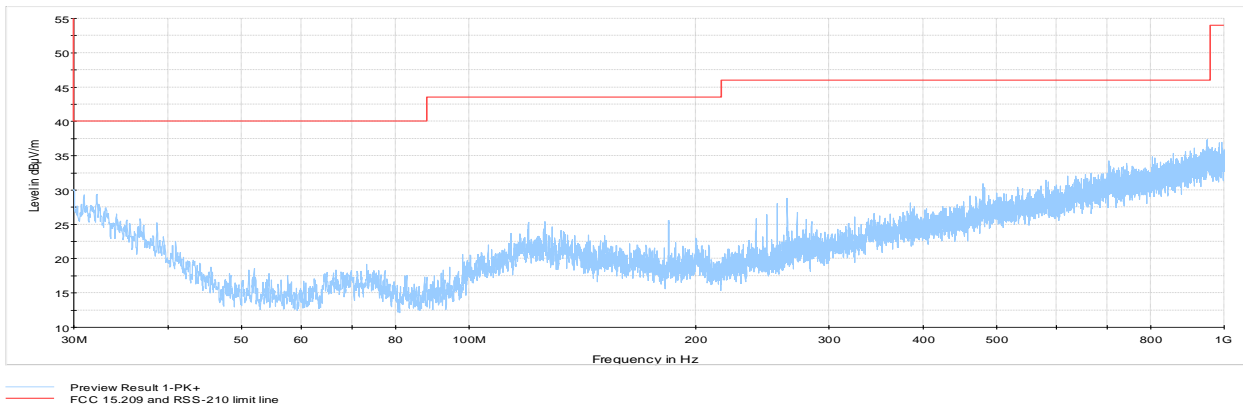

Figure 8.6-7: Radiated spurious emissions 30 MHz to 1 GHz, mid channel

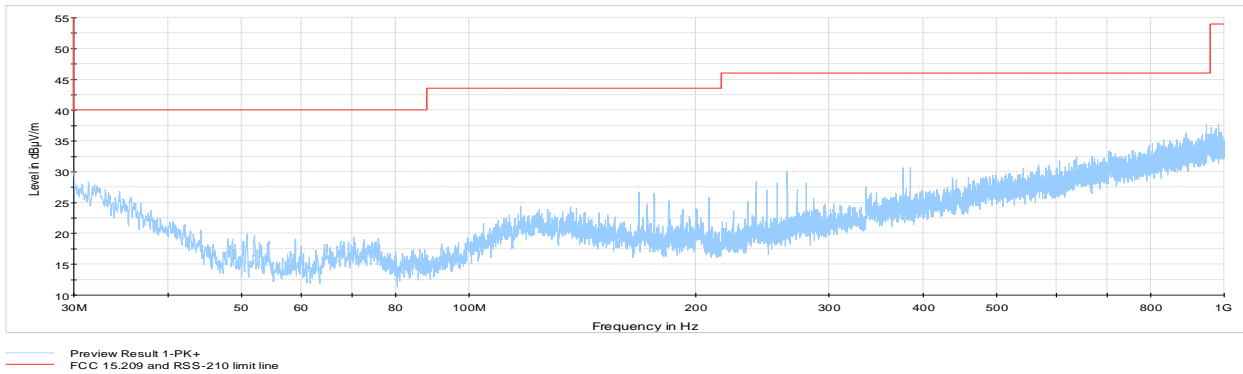

Figure 8.6-8: Radiated spurious emissions 30 MHz to 1 GHz, High channel

8.6.4 Test data, continued

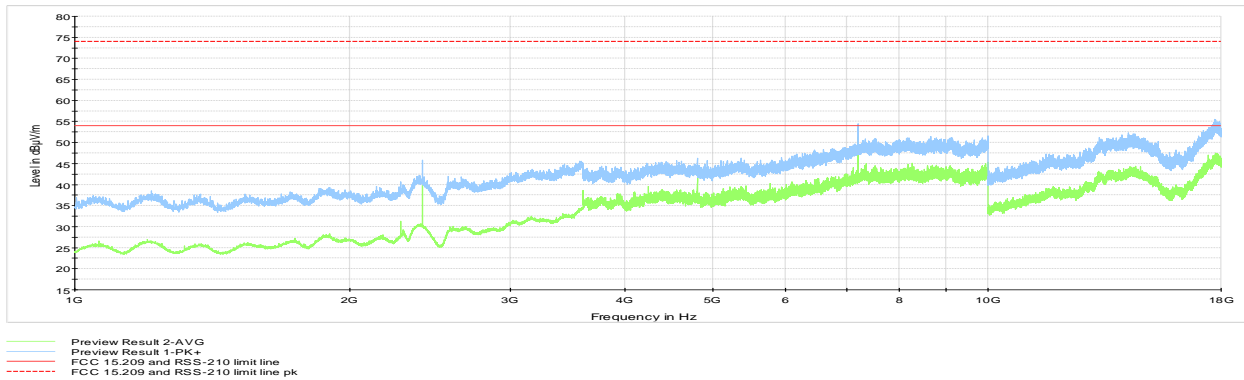

Figure 8.6-9: Radiated spurious emissions 1 to 18 GHz, Low channel

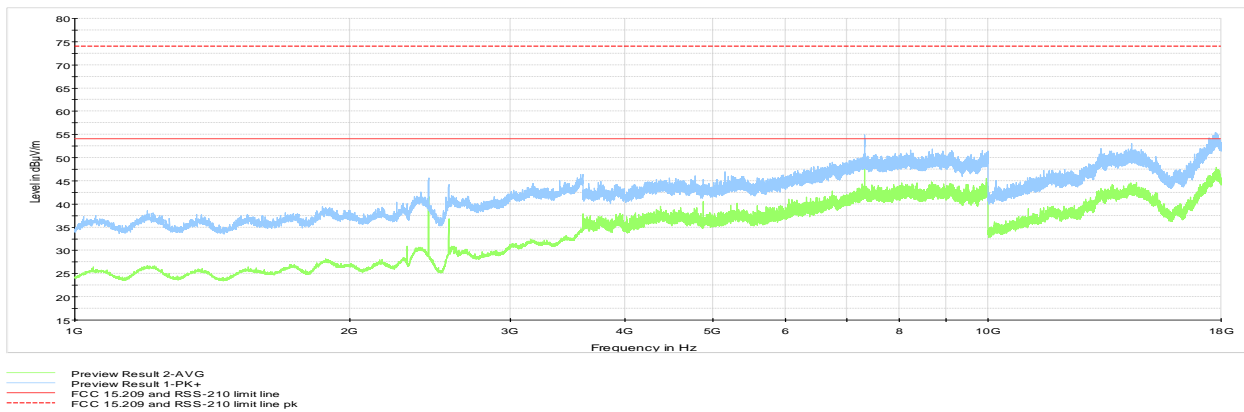

Figure 8.6-10: Radiated spurious emissions 1 to 18 GHz, mid channel

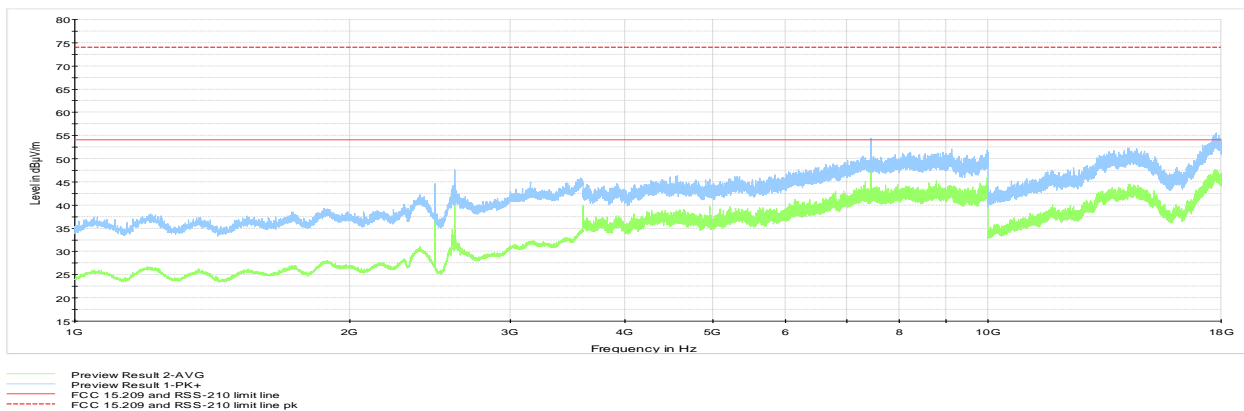

Figure 8.6-11: Radiated spurious emissions 1 to 18 GHz, High channel

Note: Spectrum was investigated from 30 MHz to 25 GHz. Above 18 GHz, no emission related to RF portion were detected within 6 dB below the limit.



8.6.4 Test data, continued

Table 8.6-4: Radiated field strength measurement results within restricted band

Channel	Frequency, MHz	Peak Field strength, dBµV/m		Margin, dB	Average Field strength, dBµV/m		Margin, dB
		Measured	Limit		Measured	Limit	
Low	2390	60.5	74.0	13.5	49.4	54.0	4.6
Low	4804	46.3	74.0	27.7	41.7	54.0	12.3
Low	7206	54.4	74.0	19.6	51.3	54.0	2.7
Mid	7320	54.9	74.0	19.1	50.2	54.0	3.8
High	2483.5	60.1	74.0	13.9	50.8	54.0	3.2
High	7439.5	54.4	74.0	19.6	49.6	54.0	4.4

Notes: Field strength includes correction factor of antenna, cable loss, amplifier, and attenuators where applicable.



8.7 FCC 15.247(e) and RSS-247 5.2(b) Power spectral density for digitally modulated devices

8.7.1 Definitions and limits

FCC §15.247 (e):

For digitally modulated systems, the power spectral density conducted from the intentional radiator to the antenna shall not be greater than 8 dBm in any 3 kHz band during any time interval of continuous transmission. This power spectral density shall be determined in accordance with the provisions of paragraph (b) of this section. The same method of determining the conducted output power shall be used to determine the power spectral density.

RSS-247 Section 5.2 (b):

The transmitter power spectral density conducted from the transmitter to the antenna shall not be greater than 8 dBm in any 3 kHz band during any time interval of continuous transmission. This power spectral density shall be determined in accordance with the provisions of section 5.4(d), (i.e. the power spectral density shall be determined using the same method as is used to determine the conducted output power).

8.7.1 Test date

Start date	December 3, 2019
------------	------------------

8.7.2 Observations, settings and special notes

- Power spectral density test was performed as per ANSI C63.10 subclause 11.10.
- The test was performed using method PKPSD (peak PSD).

Spectrum analyser settings:

Resolution bandwidth:	3 kHz ≤ RBW ≤ 100 kHz
Video bandwidth:	≥3 × RBW
Frequency span:	1.5 times the OBW
Detector mode:	Peak
Trace mode:	Maxhold

8.7.3 Test data

Table 8.7-1: PSD measurements results

Frequency, MHz	Radiated field strength @ 3m, dBµV/m	PSD, dBm/100 kHz	PSD limit, dBm/3 kHz	Margin, dB
2402	91.6	-3.6	8.0	11.6
2440	91.2	-4.0	8.0	12.0
2480	93.3	-1.9	8.0	9.9

Note: Tests were performed by radiated measurement, calculation as below:
 EIRP = Field Strength at 3 m – 95.2 dB

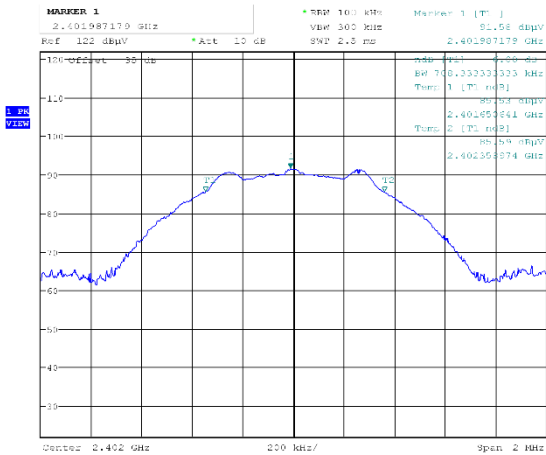

Date: 4.DEC.2019 15:52:31

Figure 8.7-1: PSD plot on Low channel

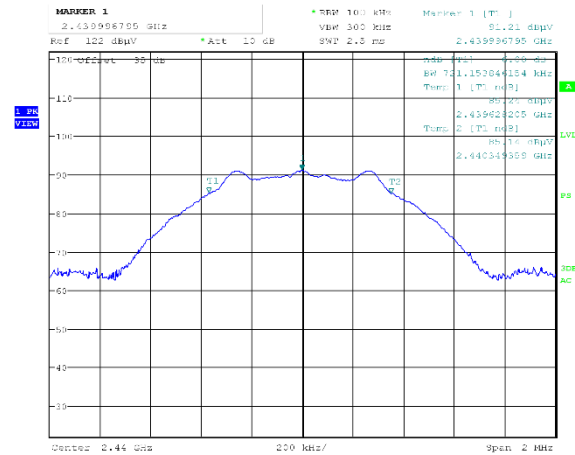

Date: 4.DEC.2019 14:57:26

Figure 8.7-2: PSD plot on Mid channel

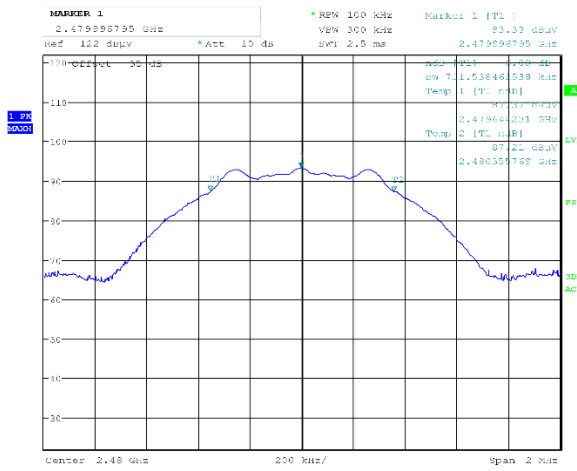

Date: 4.DEC.2019 15:24:15

Figure 8.7-3: PSD plot on High channel

Section 9. Block diagrams of test set-ups

9.1 Radiated emissions set-up for frequencies below 1 GHz

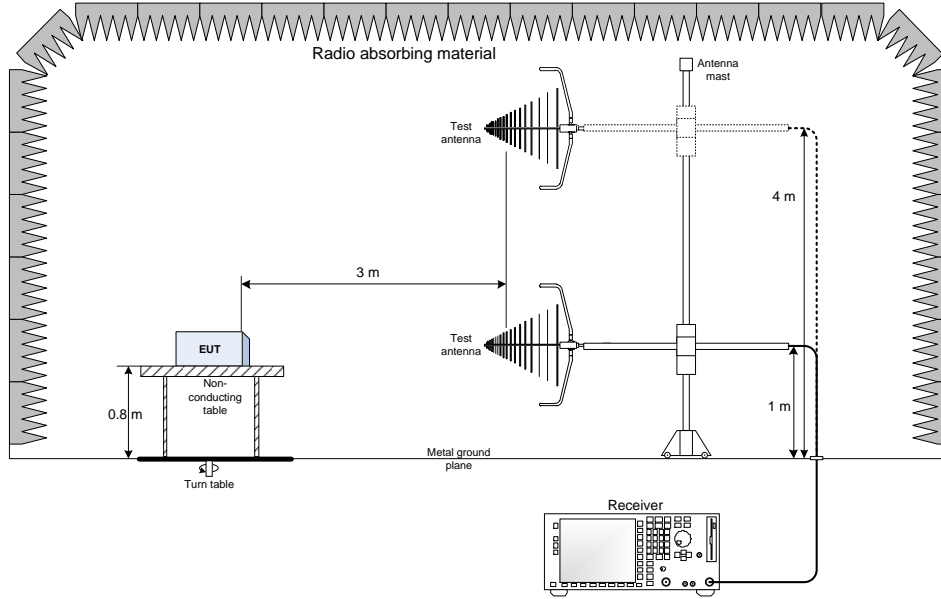

9.2 Radiated emissions set-up for frequencies above 1 GHz

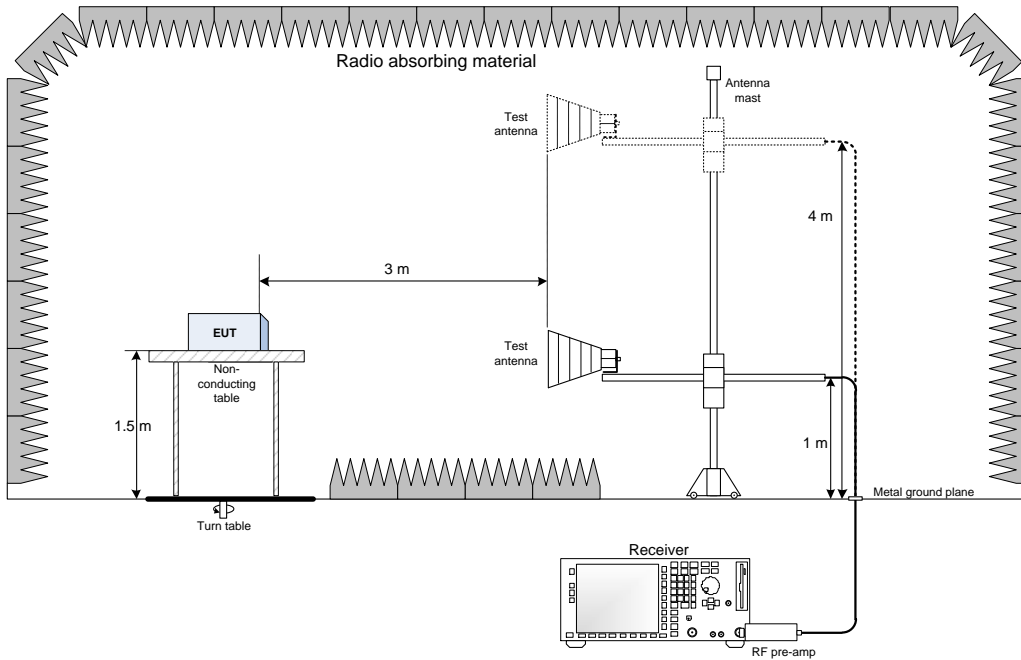

(End of report)