

Antenna Parameters
- 4M0.035.507 -
- 971.035.510.B -

Calculation Formula of Partial Average Gain

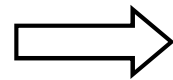
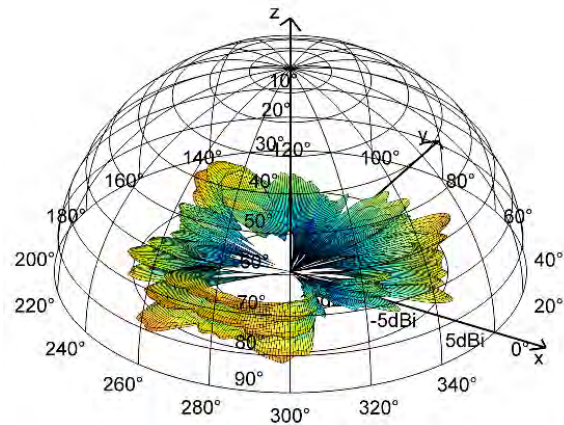

$$\text{p. ave. gain} = 10 \log \left(\frac{\sum_{iPhi=0^\circ}^{360^\circ} \sum_{iTheta=60^\circ}^{90^\circ} G(iTheta, iPhi) \sin(iTheta)}{nPhi \sum_{iTheta=60^\circ}^{90^\circ} \sin(iTheta)} \right) = x \text{ dBi}$$

$nPhi \Rightarrow$ number of elevation cuts

$G \Rightarrow$ total gain ($G_{Theta} + G_{Phi}$)

$p.ave.gain \Rightarrow$ partial average gain

- angular ranges according to LAH.8V0.035.L V06F
- frequency bands according to LAH.8V0.035.L V06F

Monopole Antenna: 4M0.035.507 Measurement Setup

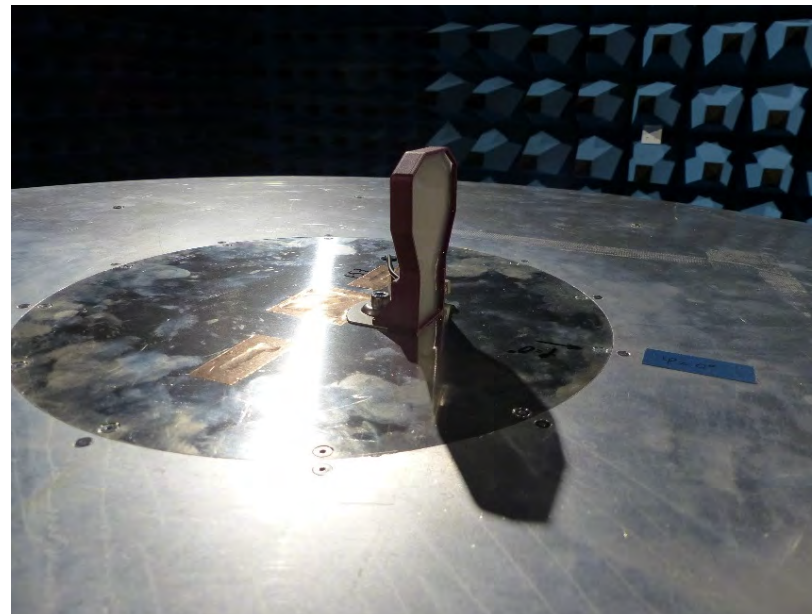

- measurement @ HCC anechoic chamber
- mounted on sirius ground plane
- monopole antenna screwed on ground plane

Monopole Antenna: 4M0.035.507

Partial Average Gain



partial average antenna gain (Theta=[60.00 - 90.00]° ; Phi=[0.00 - 360.00]°)
E_Total, Theta - linear w. spherical area consideration, Phi - linear

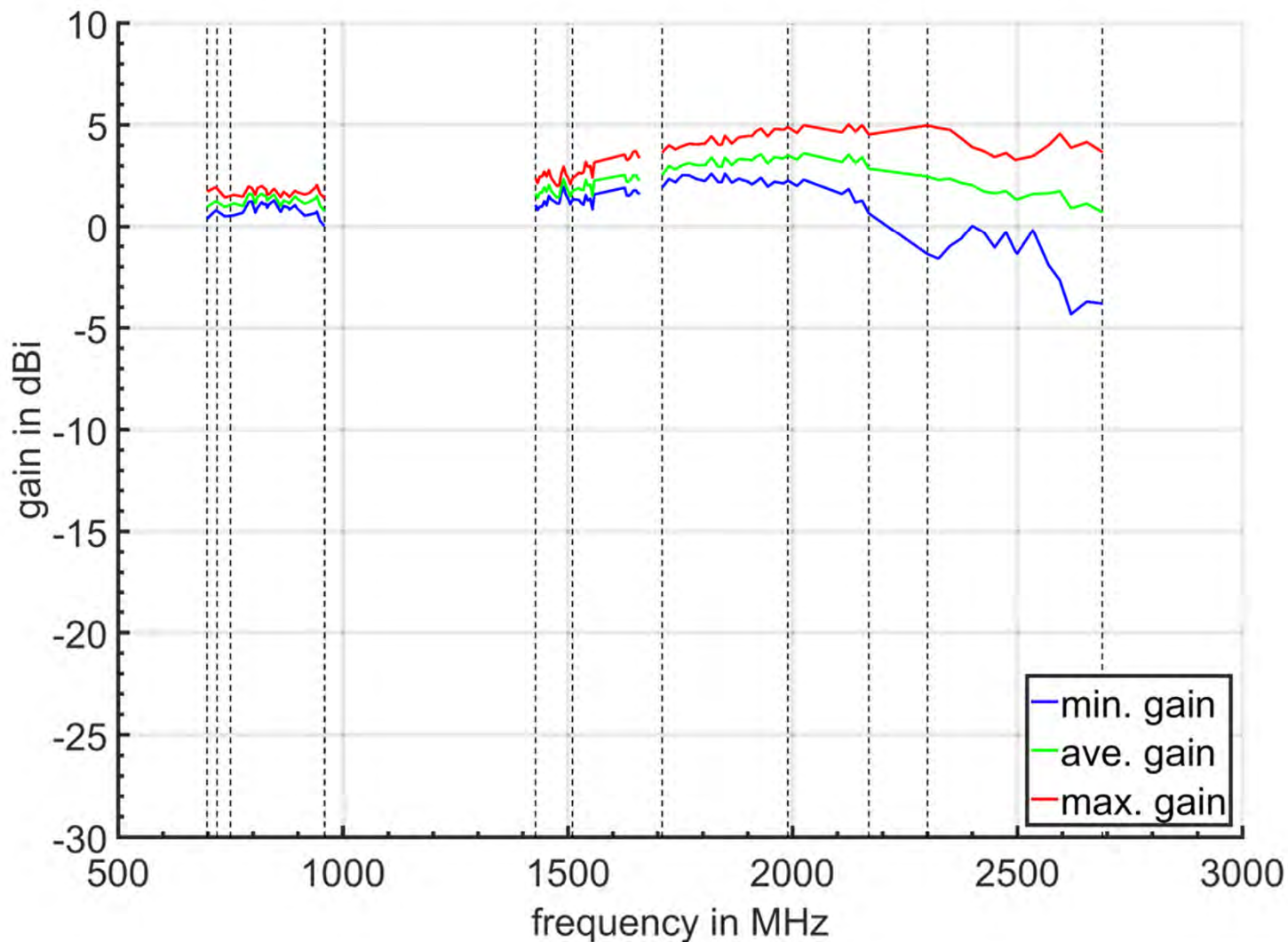

- min./max. → average over theta range
- ave. → average over theta & phi range

Monopole Antenna: 4M0.035.507

Partial Average Gain 2

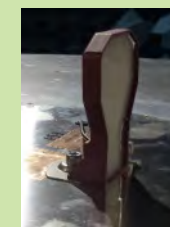

partial average antenna gain (Theta=[60.00 - 90.00]° ; Phi=[0.00 - 360.00]°)
E_Total, Theta - linear w. spherical area consideration, Phi - linear

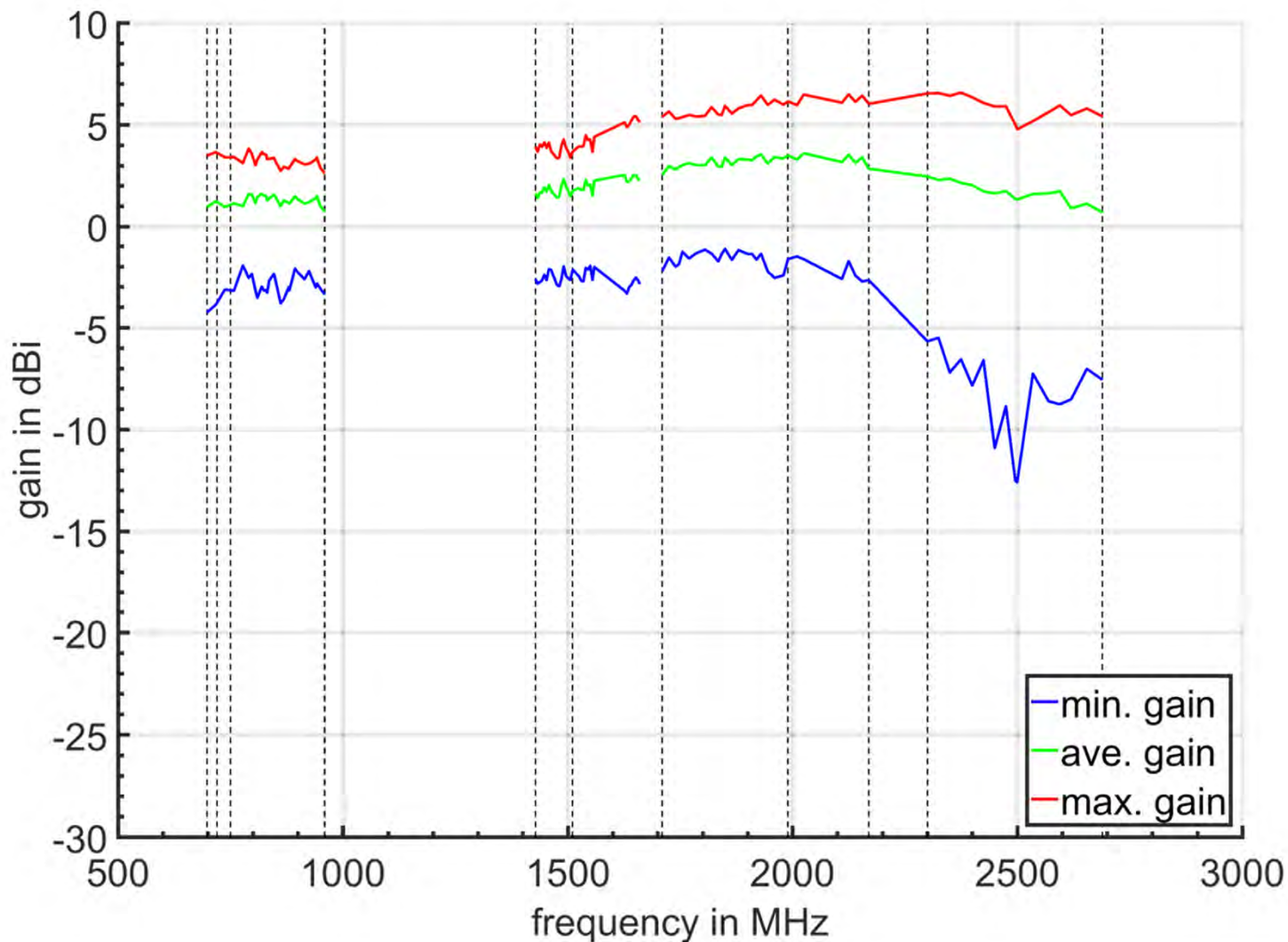

- min./max. → absolute value in theta & phi range
- ave. → average over theta & phi range

Monopole Antenna: 4M0.035.507

Partial Average Gain: Azimuth Plot

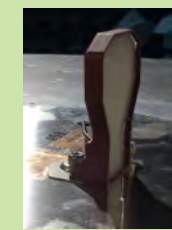

radiation pattern of the antenna
realized partial average gain (E_Total, Theta = [60.00 - 90.00]°)

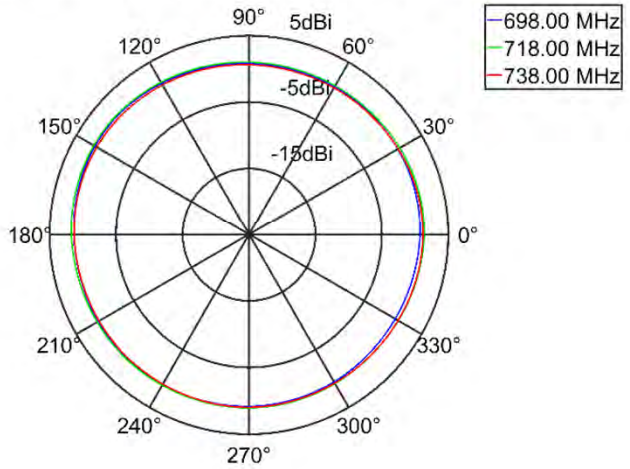

radiation pattern of the antenna
realized partial average gain (E_Total, Theta = [60.00 - 90.00]°)

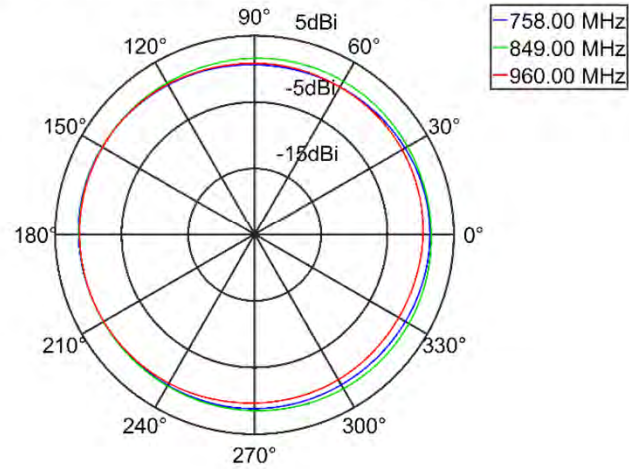

radiation pattern of the antenna
realized partial average gain (E_Total, Theta = [60.00 - 90.00]°)

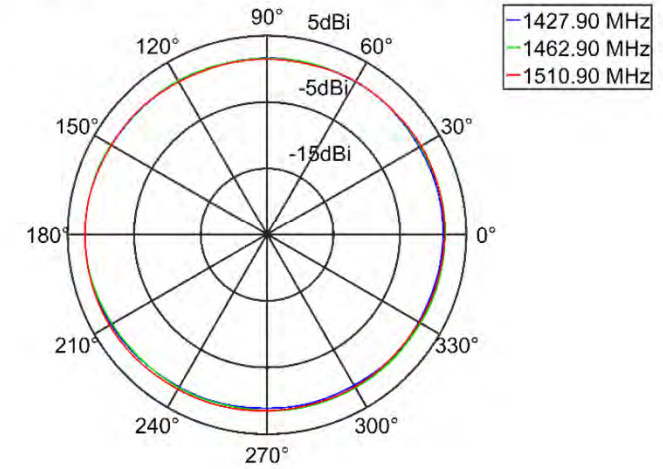

radiation pattern of the antenna
realized partial average gain (E_Total, Theta = [60.00 - 90.00]°)

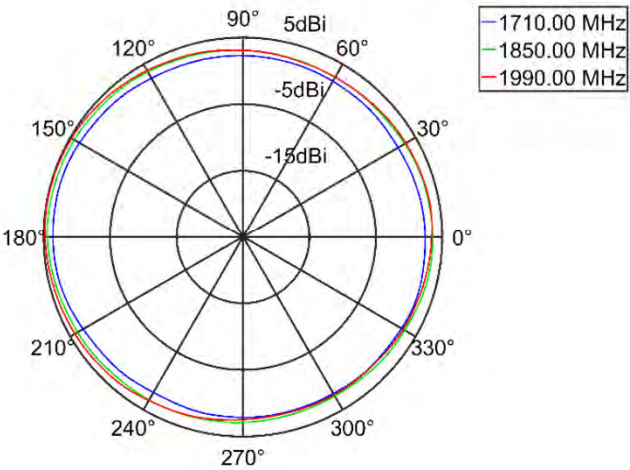

radiation pattern of the antenna
realized partial average gain (E_Total, Theta = [60.00 - 90.00]°)

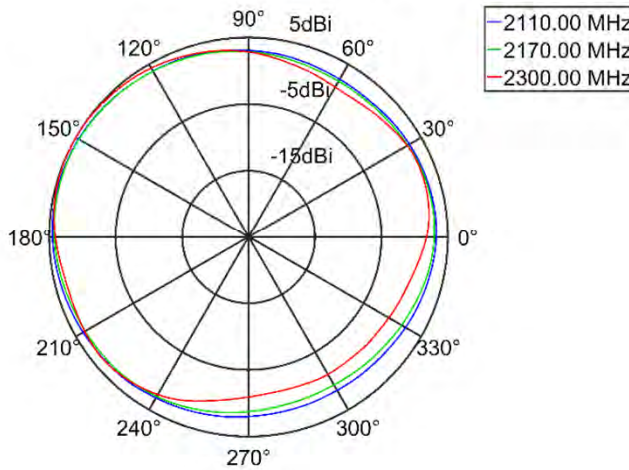

radiation pattern of the antenna
realized partial average gain (E_Total, Theta = [60.00 - 90.00]°)

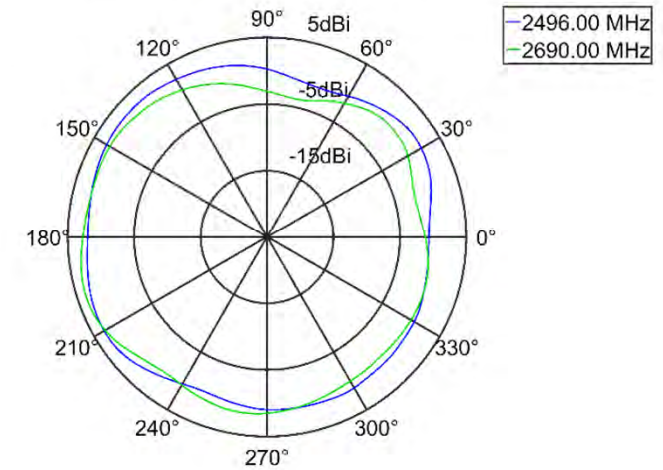

Monopole Antenna: 4M0.035.507

Antenna Gain: Elevation Plot

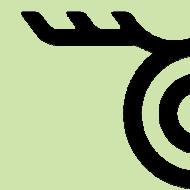

radiation pattern of the antenna
realized gain (E_Total, Freq = 738.00 MHz)

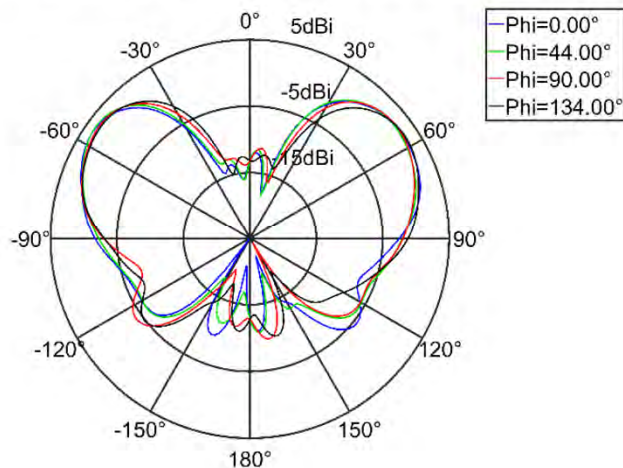

radiation pattern of the antenna
realized gain (E_Total, Freq = 849.00 MHz)

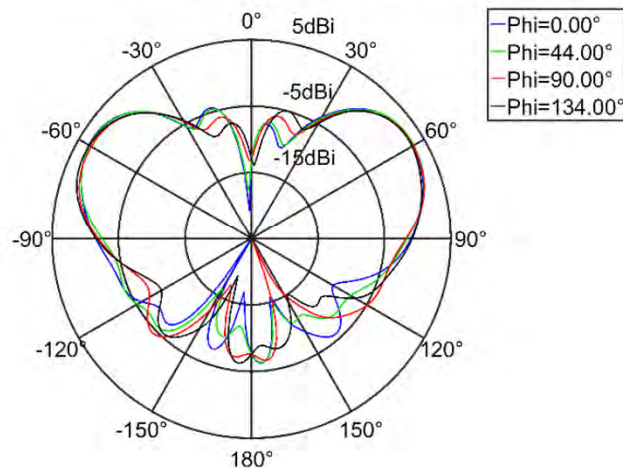

radiation pattern of the antenna
realized gain (E_Total, Freq = 1462.90 MHz)

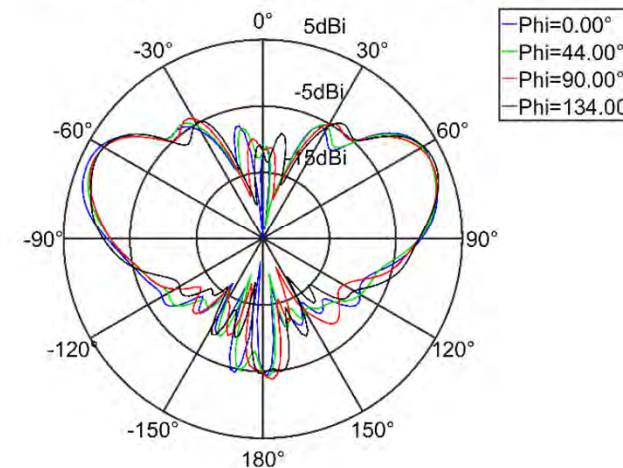

radiation pattern of the antenna
realized gain (E_Total, Freq = 1850.00 MHz)

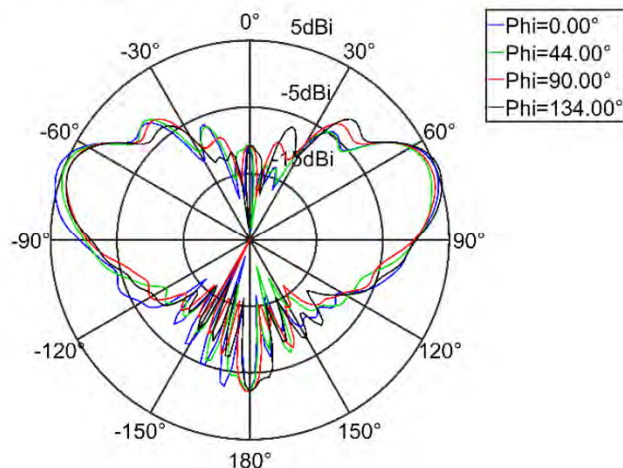

radiation pattern of the antenna
realized gain (E_Total, Freq = 2170.00 MHz)

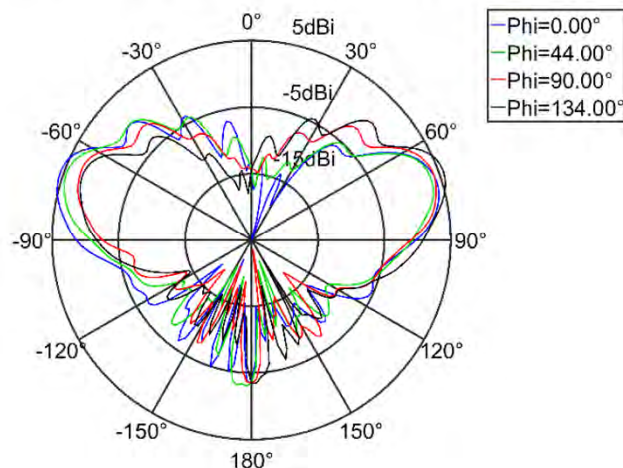

radiation pattern of the antenna
realized gain (E_Total, Freq = 2496.00 MHz)

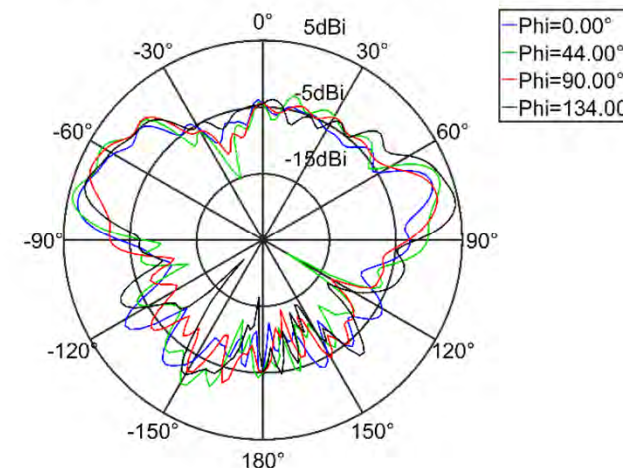

Monopole Antenna: 4M0.035.507

Antenna Parameters



Monopole Antenna with PU
4M0.035.507

Theta = [60-90]°

Theta = [60-90]°

Theta = [0-180]°

frequency band in MHz			partial average gain of freq. band in dBi		max. gain in partial area	absolut maximum gain
begin		end	average	maximum	in freq. band in dBi	in freq. band in dBi
698	-	718	1,12	1,26	3,67	3,82
718	-	758	1,14	1,26	3,67	3,82
758	-	960	1,35	1,64	3,85	3,97
1428	-	1510,9	1,78	2,35	4,29	4,29
1710	-	1990	3,18	3,56	6,45	6,45
1990	-	2170	3,33	3,62	6,51	6,51
2300	-	2690	1,72	2,48	6,60	6,60

Dipole Antenna: 971.035.510.B Measurement Setup



vertical orientation



horizontal orientation

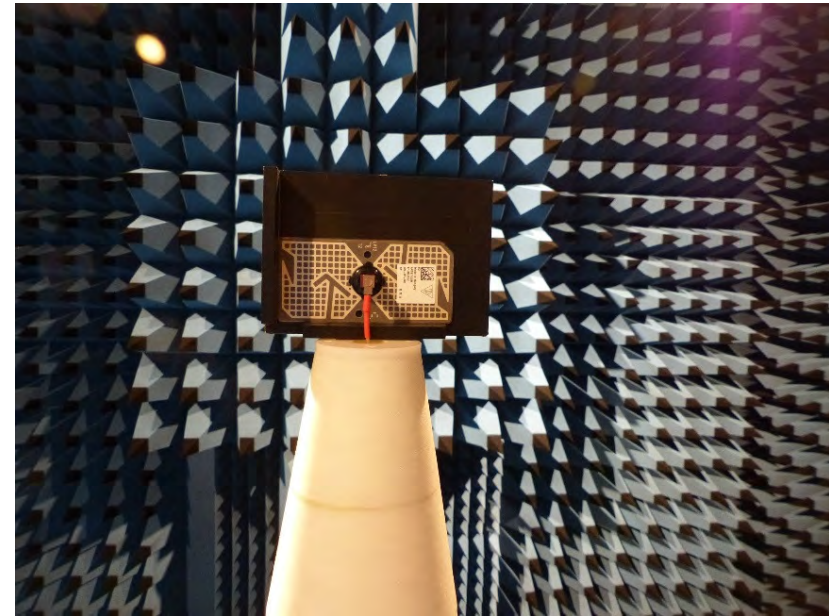

- measurement @ HCC anechoic chamber
- mounted on Rohacell cone
- dipole antenna stucked on plastic bumper dummy

Dipole Antenna: 971.035.510.B -vertical- Partial Average Gain



partial average antenna gain (Theta=[60.00 - 90.00]° ; Phi=[0.00 - 360.00]°)
E_Total, Theta - linear w. spherical area consideration, Phi - linear

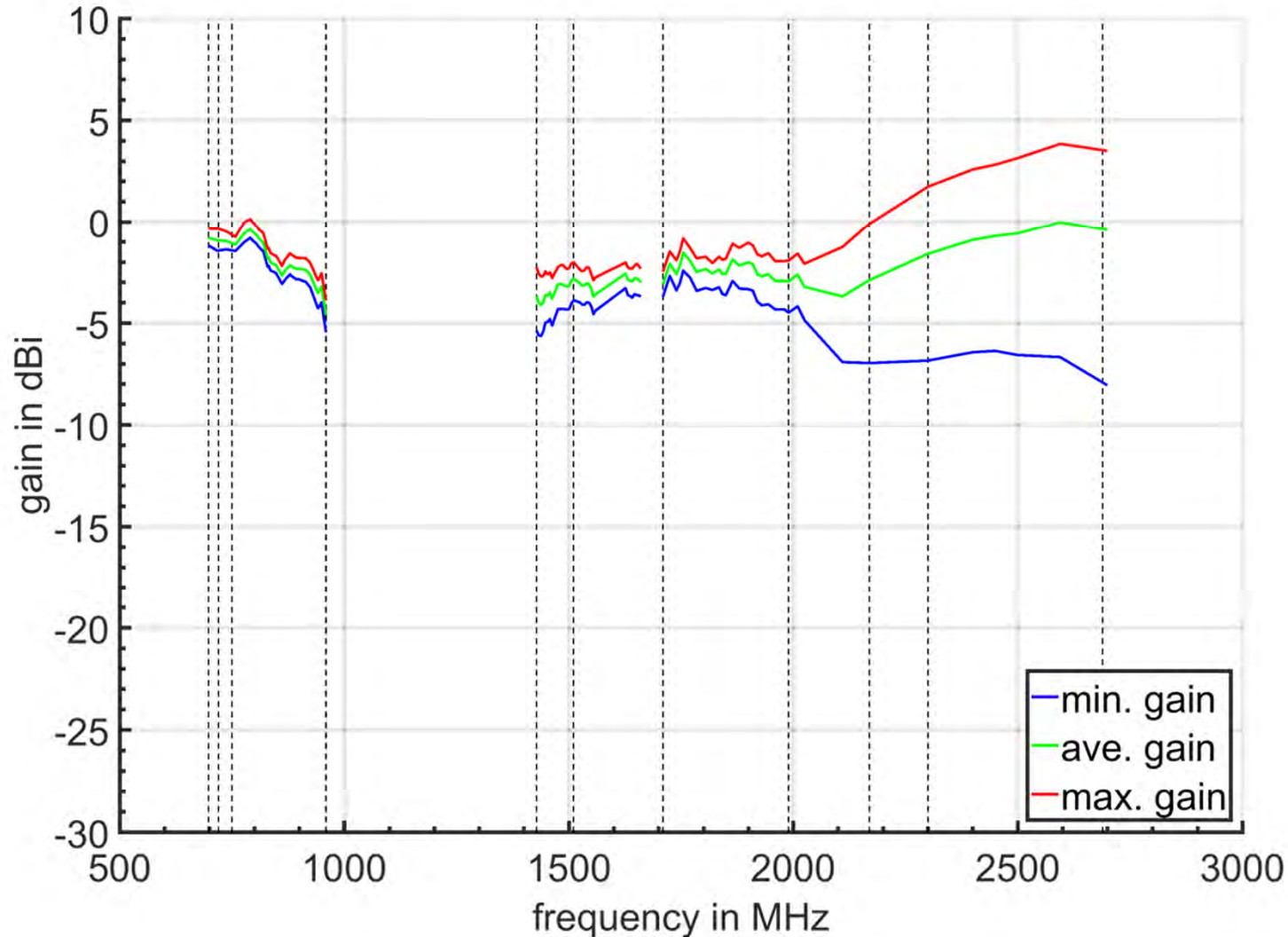

- min./max. → average over theta range
- ave. → average over theta & phi range

Dipole Antenna: 971.035.510.B -vertical- Partial Average Gain 2



partial average antenna gain (Theta=[60.00 - 90.00]° ; Phi=[0.00 - 360.00]°)
E_Total, Theta - linear w. spherical area consideration, Phi - linear

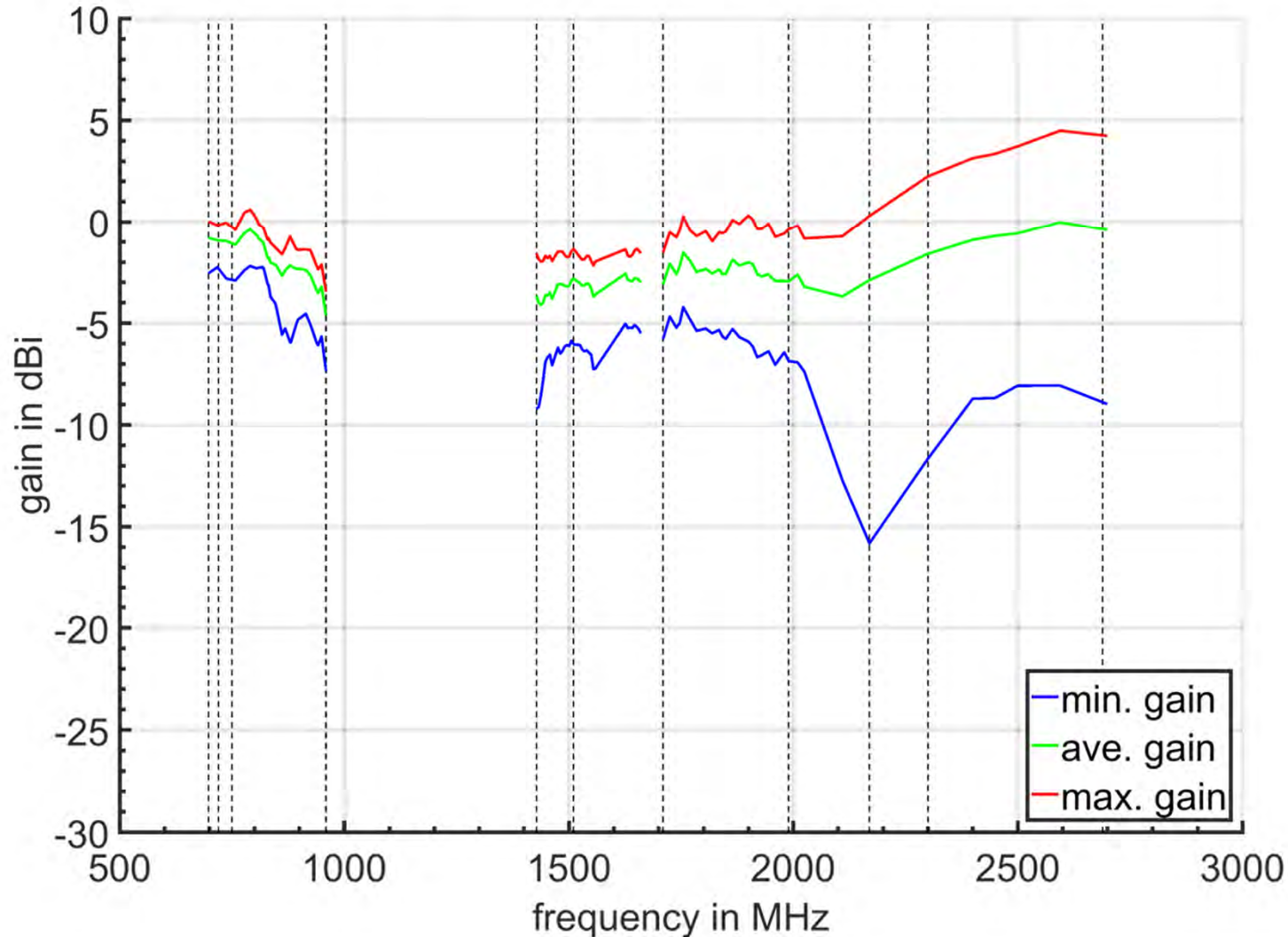

- min./max. → absolute value in theta & phi range
- ave. → average over theta & phi range

Dipole Antenna: 971.035.510.B -vertical- Partial Average Gain: Azimuth Plot



radiation pattern of the antenna
realized partial average gain (E_Total, Theta = [60.00 - 90.00]°)

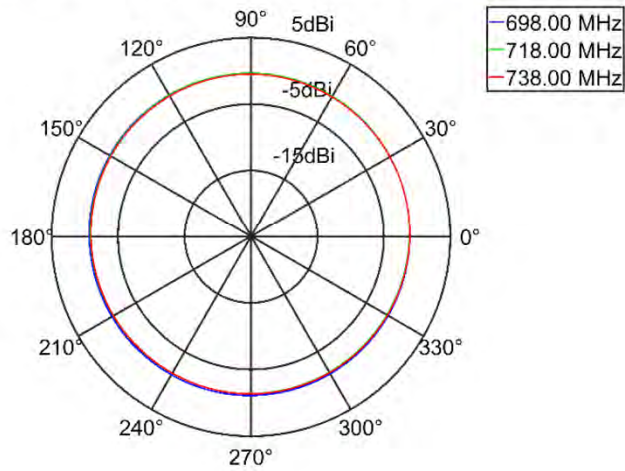

radiation pattern of the antenna
realized partial average gain (E_Total, Theta = [60.00 - 90.00]°)

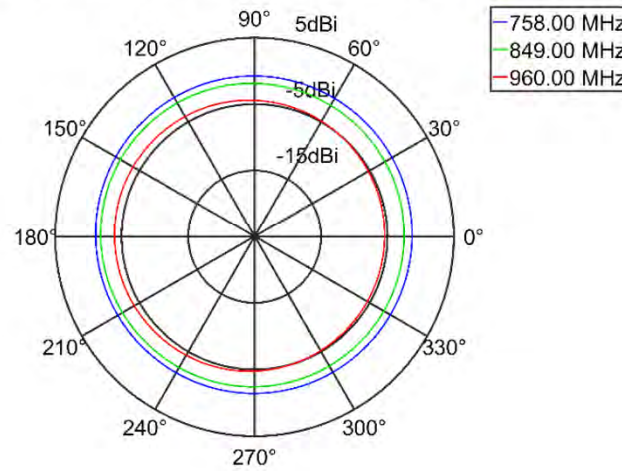

radiation pattern of the antenna
realized partial average gain (E_Total, Theta = [60.00 - 90.00]°)

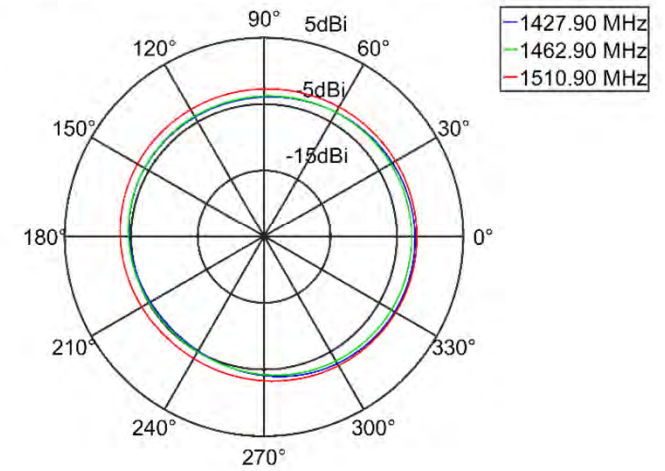

radiation pattern of the antenna
realized partial average gain (E_Total, Theta = [60.00 - 90.00]°)

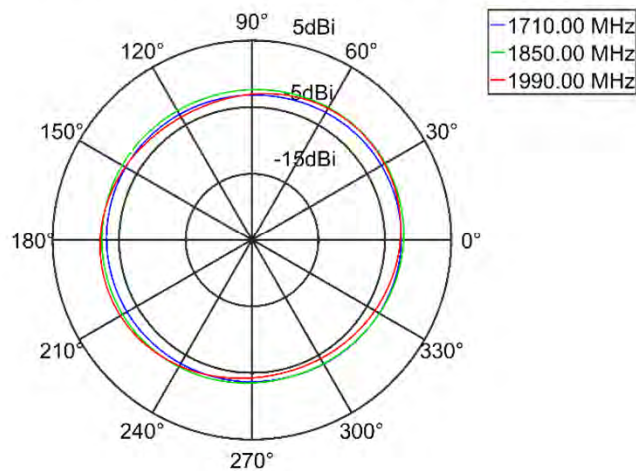

radiation pattern of the antenna
realized partial average gain (E_Total, Theta = [60.00 - 90.00]°)

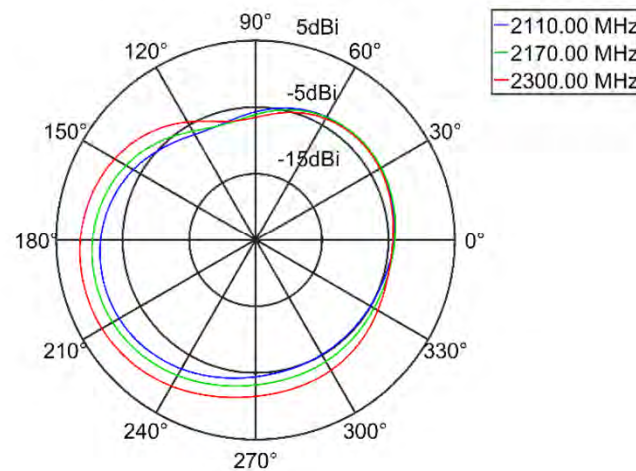

radiation pattern of the antenna
realized partial average gain (E_Total, Theta = [60.00 - 90.00]°)

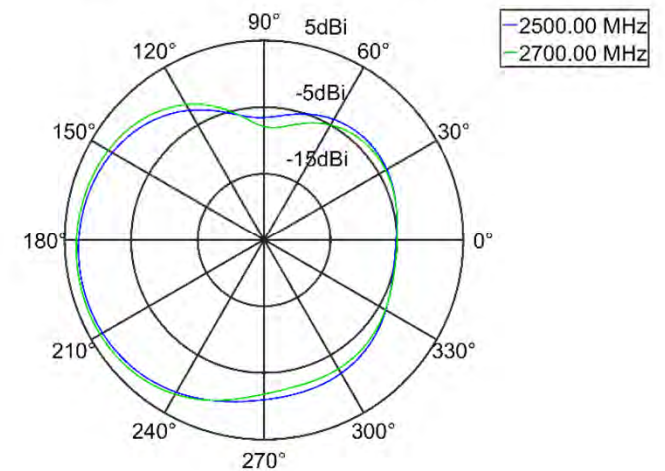

Dipole Antenna: 971.035.510.B -vertical- Antenna Gain: Elevation Plot



radiation pattern of the antenna
realized gain (E_Total, Freq = 738.00 MHz)

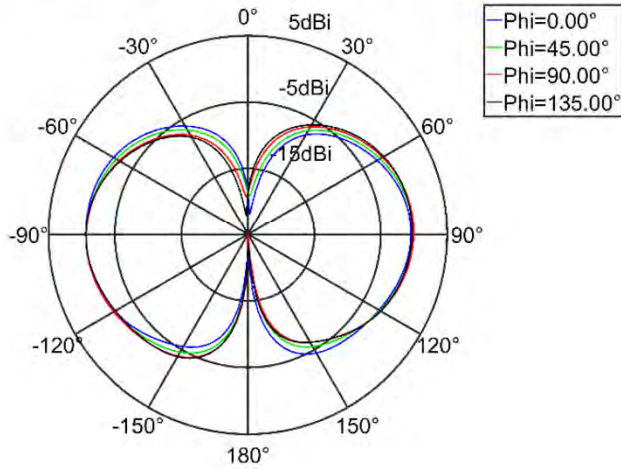

radiation pattern of the antenna
realized gain (E_Total, Freq = 849.00 MHz)

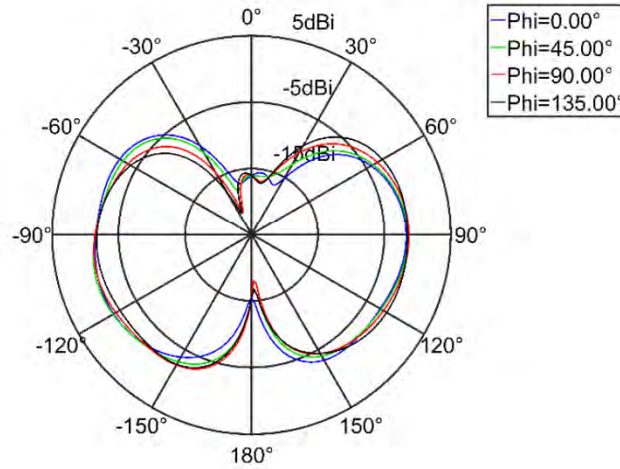

radiation pattern of the antenna
realized gain (E_Total, Freq = 1462.90 MHz)

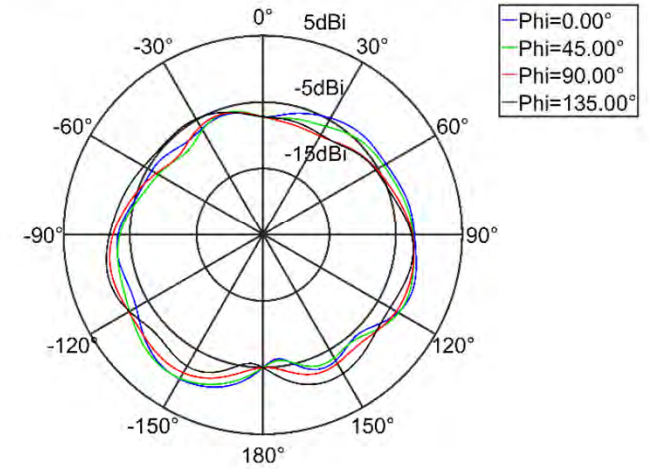

radiation pattern of the antenna
realized gain (E_Total, Freq = 1850.00 MHz)

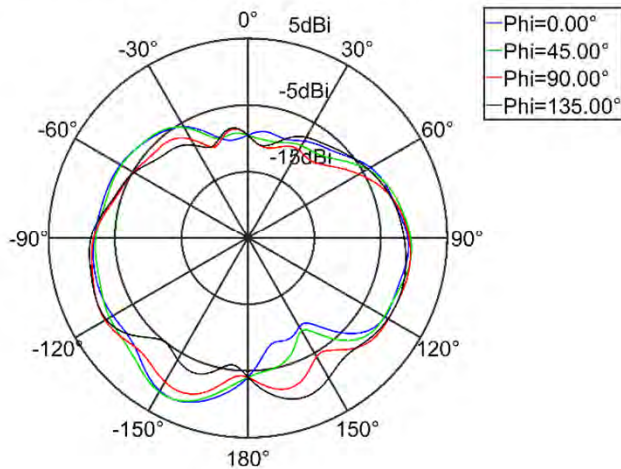

radiation pattern of the antenna
realized gain (E_Total, Freq = 2170.00 MHz)

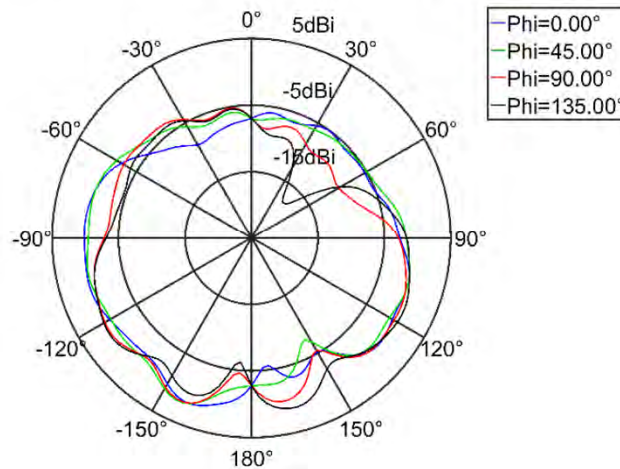

radiation pattern of the antenna
realized gain (E_Total, Freq = 2500.00 MHz)

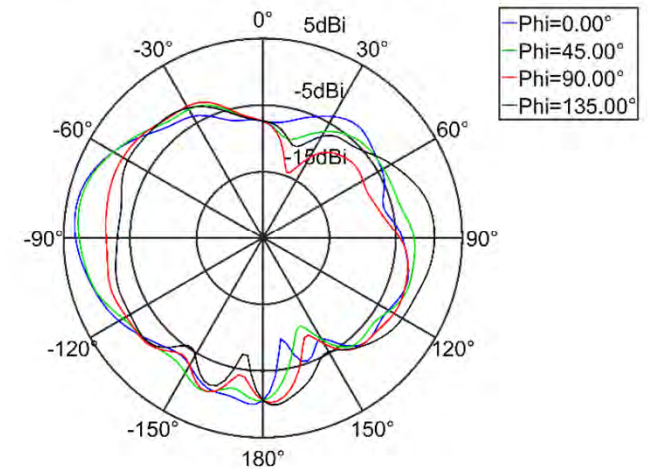

Dipole Antenna: 971.035.510.B -vertical- Antenna Parameters

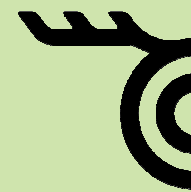

Dipole Antenna with Hotmelt: vertical orientation

972.035.510.B

Theta = [60-90]°

Theta = [60-90]°

Theta = [0-165]°

frequency band in MHz			partial average gain of freq. band in dBi		max. gain in partial area	absolut maximum gain
begin		end	average	maximum	in freq. band in dBi	in freq. band in dBi
699	-	720	-0,85	-0,80	0,04	0,04
720	-	750	-1,00	-0,91	-0,03	-0,03
750	-	960	-1,85	-0,37	0,62	0,62
1427,9	-	1510,9	-3,40	-2,80	-1,35	0,92
1710	-	1990	-2,39	-1,52	0,32	2,63
1990	-	2170	-3,05	-2,60	0,31	2,53
2300	-	2690	-0,67	-0,01	4,51	4,51

Dipole Antenna: 971.035.510.B -horizontal- Partial Average Gain



partial average antenna gain (Theta=[60.00 - 90.00]° ; Phi=[0.00 - 360.00]°)
E_Total, Theta - linear w. spherical area consideration, Phi - linear

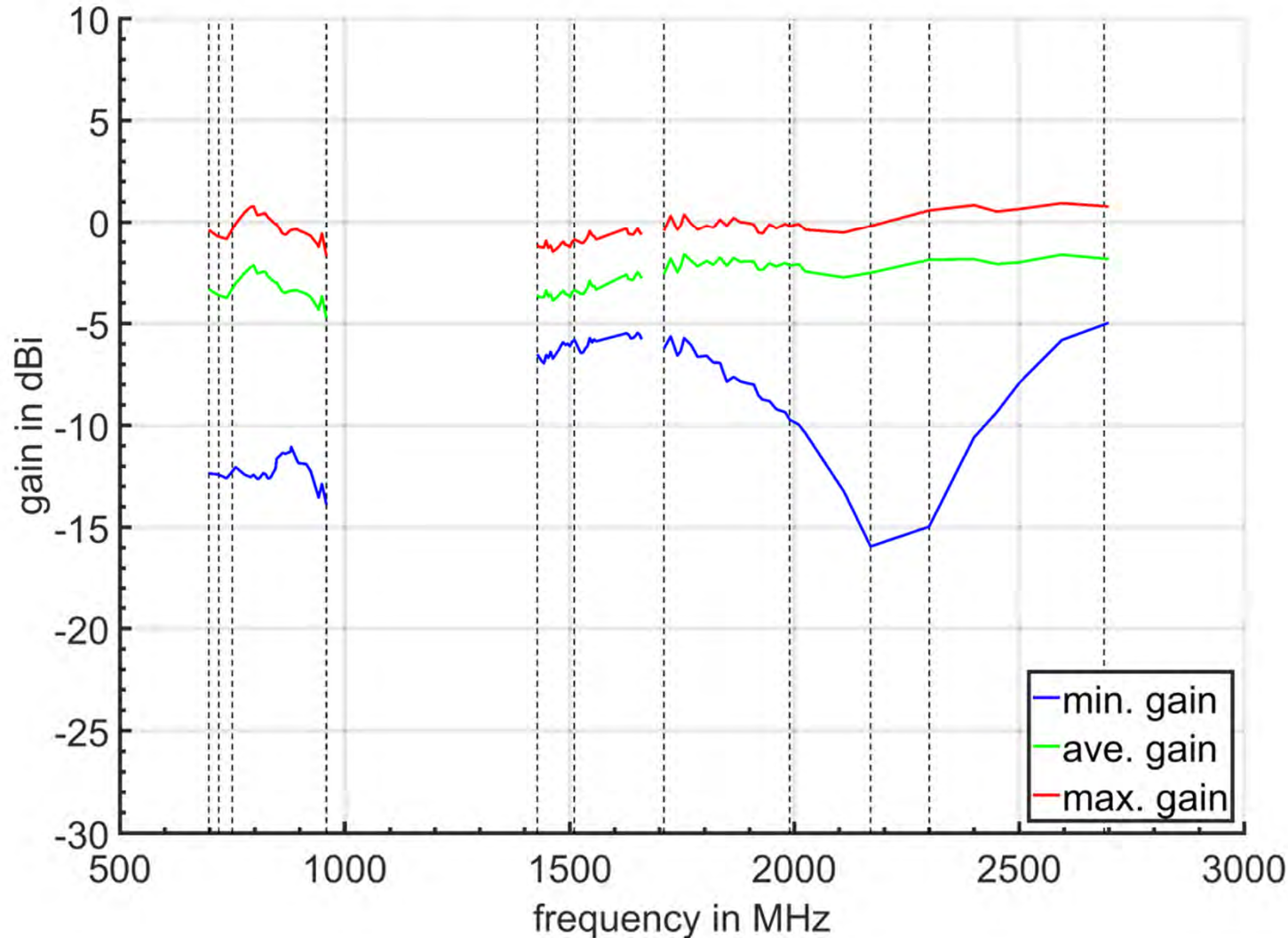

- min./max. → average over theta range
- ave. → average over theta & phi range

Dipole Antenna: 971.035.510.B -horizontal- Partial Average Gain 2



partial average antenna gain (Theta=[60.00 - 90.00]° ; Phi=[0.00 - 360.00]°)
E_Total, Theta - linear w. spherical area consideration, Phi - linear

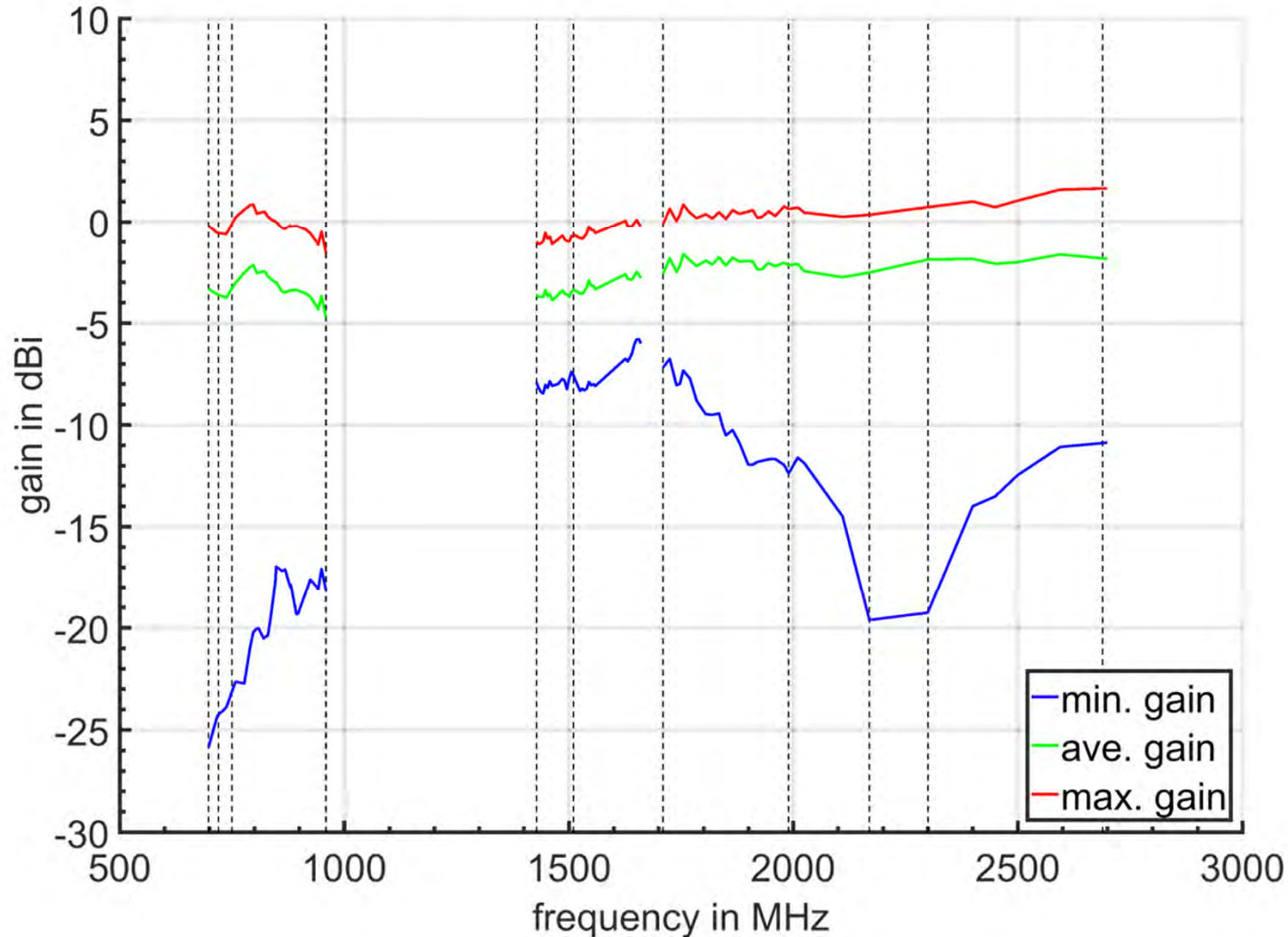

- min./max. → absolute value in theta & phi range
- ave. → average over theta & phi range

Dipole Antenna: 971.035.510.B -horizontal- Partial Average Gain: Azimuth Plot



radiation pattern of the antenna
realized partial average gain (E_Total, Theta = [60.00 - 90.00]°)

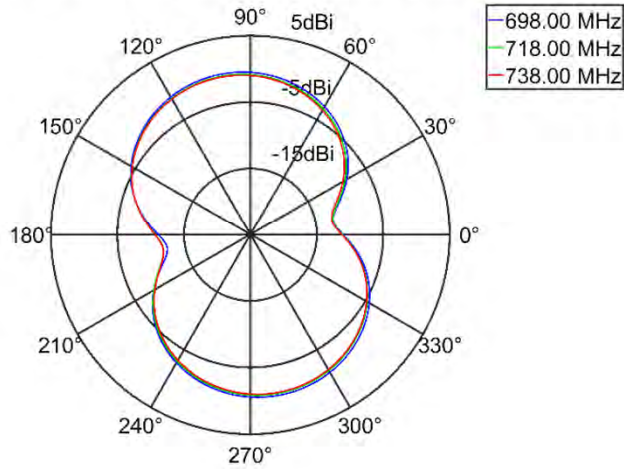

radiation pattern of the antenna
realized partial average gain (E_Total, Theta = [60.00 - 90.00]°)

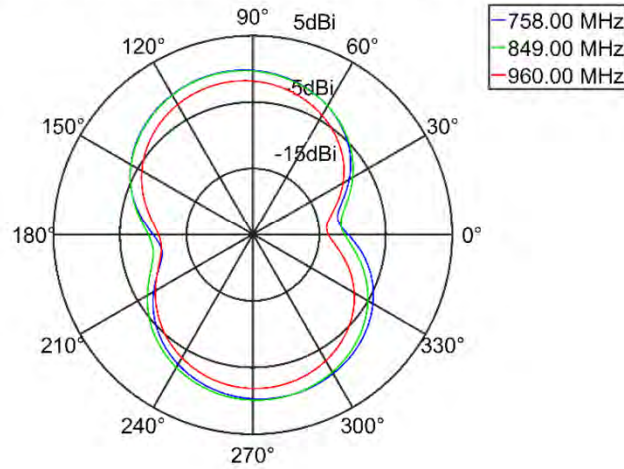

radiation pattern of the antenna
realized partial average gain (E_Total, Theta = [60.00 - 90.00]°)

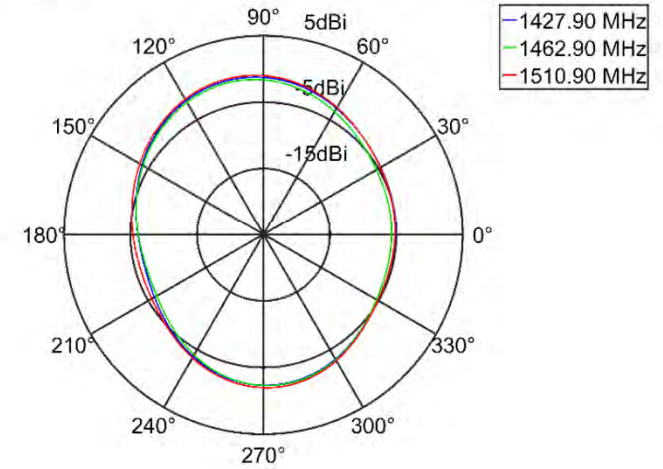

radiation pattern of the antenna
realized partial average gain (E_Total, Theta = [60.00 - 90.00]°)

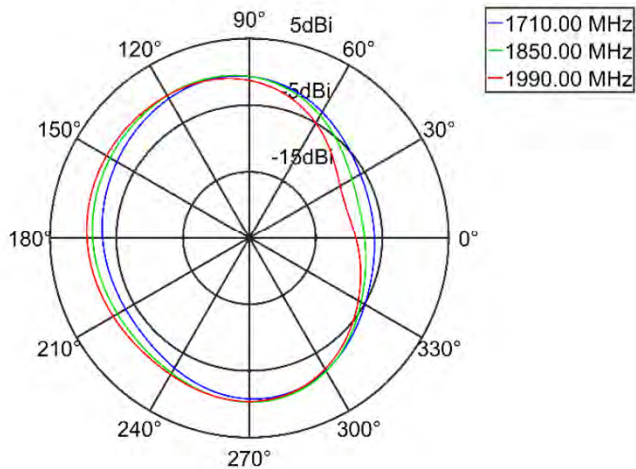

radiation pattern of the antenna
realized partial average gain (E_Total, Theta = [60.00 - 90.00]°)

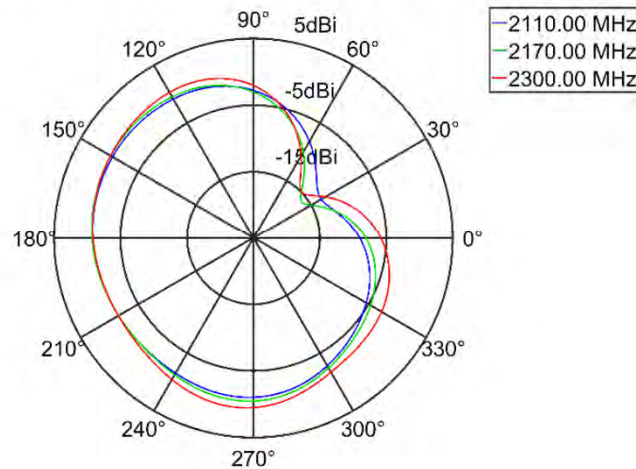

radiation pattern of the antenna
realized partial average gain (E_Total, Theta = [60.00 - 90.00]°)

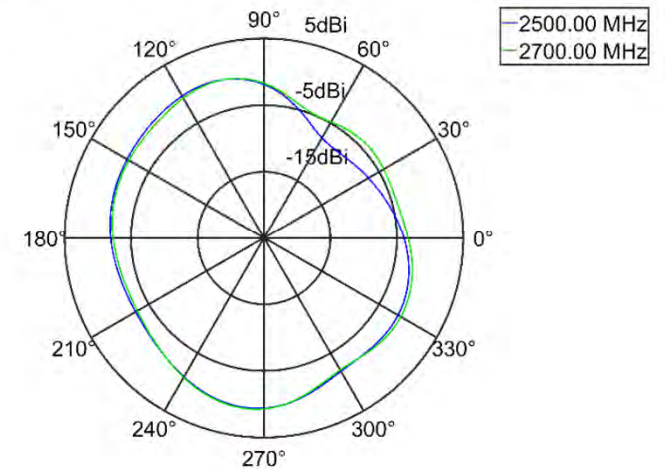

Dipole Antenna: 971.035.510.B -horizontal- Antenna Gain: Elevation Plot



radiation pattern of the antenna
realized gain (E_Total, Freq = 738.00 MHz)

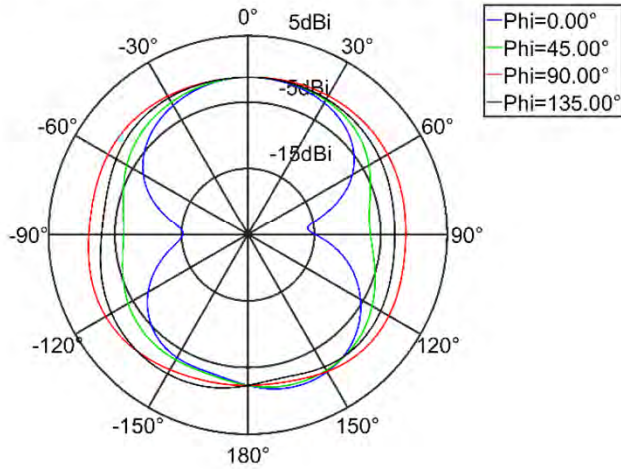

radiation pattern of the antenna
realized gain (E_Total, Freq = 849.00 MHz)

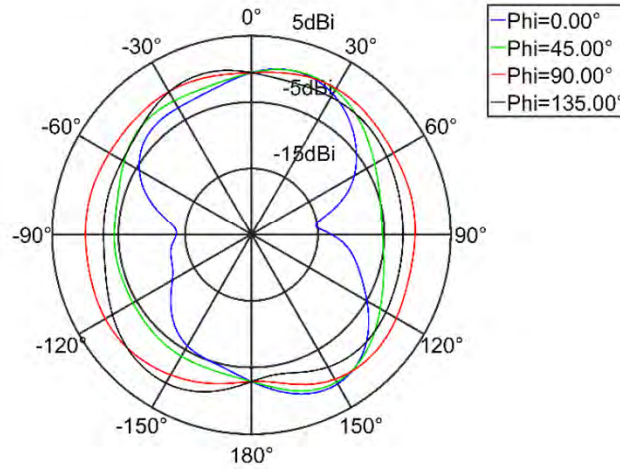

radiation pattern of the antenna
realized gain (E_Total, Freq = 1462.90 MHz)

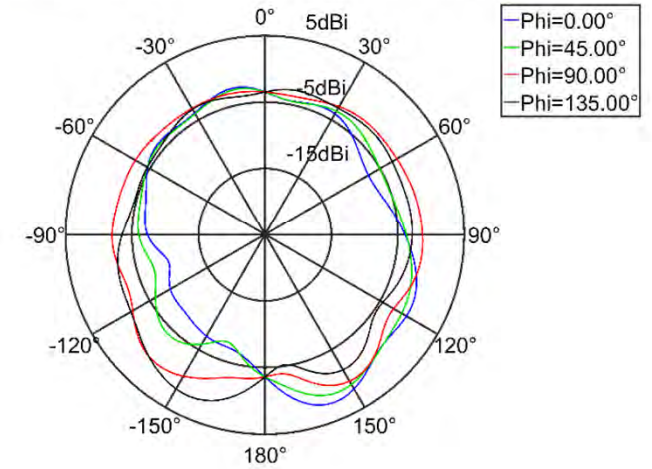

radiation pattern of the antenna
realized gain (E_Total, Freq = 1850.00 MHz)

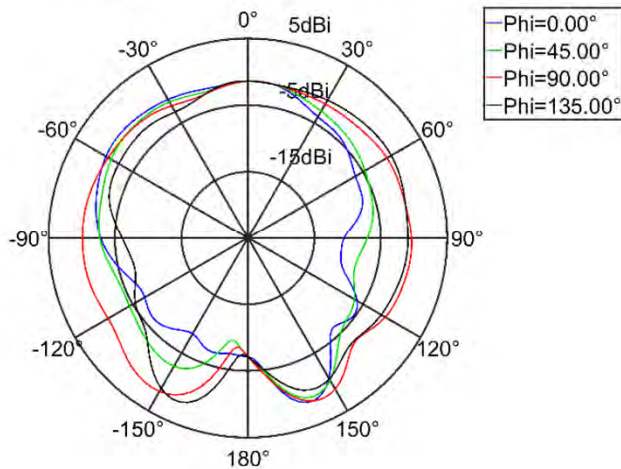

radiation pattern of the antenna
realized gain (E_Total, Freq = 2170.00 MHz)

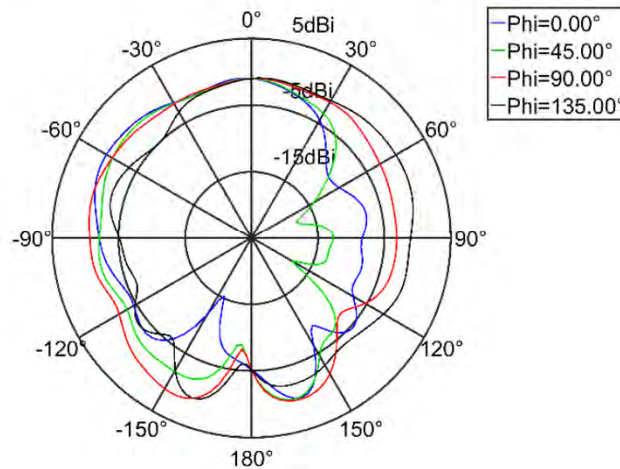

radiation pattern of the antenna
realized gain (E_Total, Freq = 2500.00 MHz)

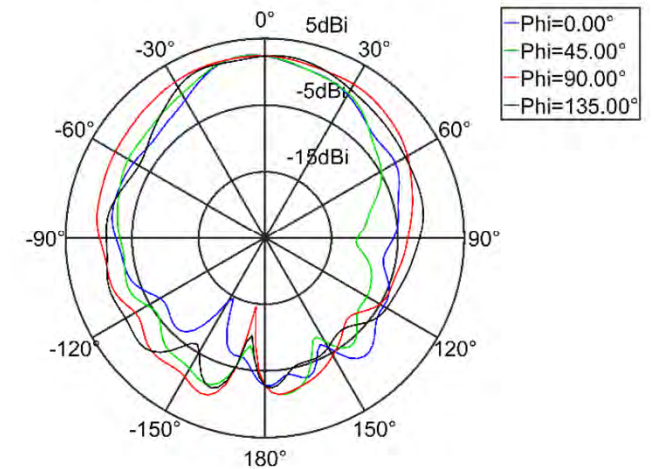

Dipole Antenna: 971.035.510.B -horizontal- Antenna Parameters



Dipole Antenna with Hotmelt: horizontal orientation

972.035.510.B

Theta = [60-90]°

Theta = [60-90]°

Theta = [0-165]°

frequency band in MHz			partial average gain of freq. band in dBi		max. gain in partial area	absolut maximum gain
begin		end	average	maximum	in freq. band in dBi	in freq. band in dBi
699	-	720	-3,44	-3,30	-0,19	0,00
720	-	750	-3,43	-3,01	0,23	0,46
750	-	960	-3,07	-2,14	0,87	1,15
1427,9	-	1510,9	-3,58	-3,35	-0,55	2,99
1710	-	1990	-2,06	-1,59	0,87	2,70
1990	-	2170	-2,38	-2,09	0,73	2,02
2300	-	2690	-1,87	-1,61	1,67	3,39

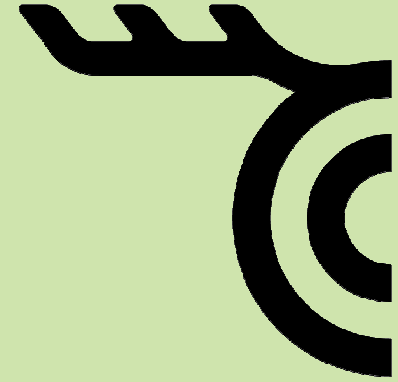

Many thanks for your attention!

Hirschmann Car Communication GmbH

Stuttgarter Straße 45 - 51
72654 Neckartenzlingen

Phone + 49 7127 14-0
Fax + 49 7127 14-1060
E-Mail: info@hirschmann-car.com
www.hirschmann-car.com