

⑥ Engine oil temperature

⑦ Engine speed

Displays ①, ②, ④, ⑤ and ⑥ can be shown/hidden.

The following functions are available on the **Options** submenu:

- Set display content as the standard display (→ page 275)

Calling up displays on the Trip menu

On-board computer:



Trip

You can show/hide different display content on the **Trip** menu.

▶ Swipe upwards or downwards on the left-hand Touch Control.



① Driving time **From reset**

② Driving time **From start**

③ Average fuel consumption **From start**

④ Distance to the destination; estimated arrival time

⑤ Fuel range

⑥ AdBlue® range

⑦ Distance to the traffic incident; estimated travel time gained or lost due to the traffic incident

⑧ Total distance **From start**

⑨ Total distance **From reset**

⑩ Average fuel consumption **From reset**

ⓘ Displays ④, ⑤, ⑥ and ⑦ are displayed in a situation-specific manner.

The following functions are available on the **Options** submenu:

- Set display content as the standard display (→ page 275)
- Reset **From start** and **From reset** values

Calling up navigation instructions on the on-board computer

On-board computer:



Navigation

The following map views are available on the **Navigation** menu:

- Whole map
 - 2D direction of travel
 - 2D north orientation
 - 3D map
- ⓘ The level of detail in the navigation instructions on the left-hand display range may vary.



- ① Distance to the change of direction
- ② Road to which the change of direction leads
- ③ Display of traffic incident
- ④ Currently selected route
- ⑤ Display of vehicle's current position
- ⑥ Change-of-direction symbol
- ⑦ Recommended lane (white)
- ⑧ Lane not recommended (grey)
- ⑨ Current lane

You can change the map scale of the selected map view on the **Navigation** menu.

- ▶ Swipe upwards or downwards on the left-hand Touch Control.

On the **Options** submenu, you can use other functions in the **route** and **Map settings** categories.

You can use the following functions in the **route** category:

- Cancel current route guidance.
- Call up previous destinations and favourites.

You can use the following functions in the **Map settings** category:

- Activate auto zoom.
- Set the map view, satellite view and route overview.

The following functions are available on the **Options** submenu:

- Set display content as the standard display (→ page 275)

Selecting the radio or media source using the on-board computer

On-board computer:

↳ **Entertainment**

The following display content, for example, can be displayed on the **Entertainment** menu:

- Radio

- Media
- Browser
- ENERGIZING COMFORT



Radio on the **Entertainment** menu (example)

- ① Previous radio station or previous track
- ② Frequency range or media source
- ③ Radio station or current track
- ④ Name of track and artist
- ⑤ Next radio station or next track

- ▶ **To select the radio or media on the entertainment menu:** press the left-hand Touch Control.
The **Options** submenu will be displayed.
- ▶ Select the **Radio** or **Media** menu item by swiping upwards or downwards on the left-hand Touch Control and confirm by pressing the left-hand Touch Control.

Changing radio station or track in an active media source

- ▶ **To select a radio station:** swipe upwards or downwards on the left-hand Touch Control.
- ⓘ When you select a saved radio station in the frequency range, a star  will appear next to the radio station name.
- ▶ **To change tracks in an active media source:** swipe left or right on the left-hand Touch Control.
- ⓘ This is how to select the channel for the TV media source.

Changing the frequency band on the Options submenu

- ▶ Select the **Radio** menu item by swiping upwards or downwards on the left-hand Touch Control and confirm by pressing the left-hand Touch Control.
- ▶ Swipe left or right on the left-hand Touch Control and select a frequency band by pressing the left-hand Touch Control.

Selecting a media source on the Options submenu

- ▶ Select the **Media** menu item by swiping upwards or downwards on the left-hand Touch Control and confirm by pressing the left-hand Touch Control.
- ▶ Swipe upwards or downwards on the left-hand Touch Control and select a media source by pressing the left-hand Touch Control.

The following additional function is available on the **Options** submenu:

- Set display content as the standard display(→ page 275)

Configuring displays on the individual menu

On-board computer:

↳ **Individual**

Up to five different types of display content can be displayed on the **Individual** menu.

- ▶ **To expand the display content:** swipe upwards on the left-hand Touch Control.
- ▶ **To reduce the display content:** swipe downwards on the left-hand Touch Control.

The display content is also individually adjustable.

- ▶ **To call up the Options submenu:** press the left-hand Touch Control.
- ▶ **To configure the display content of the individual menu:** confirm the **Change individual** request by pressing the left-hand Touch Control.
The corresponding menu for the configuration of the display content will open in the multimedia system.

The respective display content of the **Individual** menu is configured within the multimedia sys-

tem. As soon as you confirm the configuration in the multimedia system or by pressing the left-hand back button on the multifunction steering wheel, the message **Configuration completed** will appear on the instrument cluster.

Display content selection, left and right:

- Standard display
- Traffic incidents
- Range
- Navigation
- Consumption
- Audio
- Weather
- Trip computer **From start** and **From reset**
- ECO display

Display content selection, centre:

- G-meter
- ECO display
- Navigation
- Rev counter
- Speedometer

- ATTENTION ASSIST display

The following setting options are available on the **Options** submenu depending on the selected display content:

- Set display content as the standard display(→ page 275)
- Reset **From start** values
- Reset **From reset** values
- Reset **Trip meter**
- Set a route
- Change track or media source

i Please note that not all areas for display content shown have to be configured.

Head-up Display

Function of the head-up display

The head-up display projects, for example, the following content into the driver's field of vision:

- Information from the navigation system

- Information and visualisation from the driver assistance systems
- Information from the menus of the on-board computer
- Warning messages or notes (symbol) on warning messages on the instrument display

Display elements

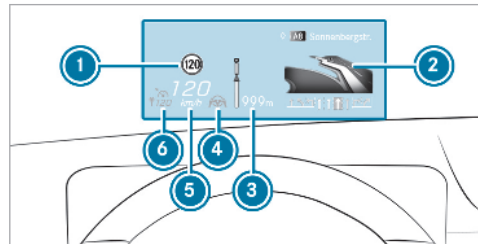

- ① Detected instructions and traffic signs
- ② Navigation instructions
- ③ Navigation instructions (distance to the next route event)
- ④ Steer Assist status

- 5 Current speed
- 6 Set speed in the driver assistance system (e.g. cruise control)

When you receive a call, the message  **Incoming call** will appear on the head-up display.

System limits

The visibility is influenced by the following conditions:

- Seat position
- Image position setting
- Light conditions
- Wet road surfaces
- Objects on the display cover
- Polarisation in sunglasses
- Vehicles with (AR) head-up display: the content shown depends on the driver camera recording.



Adjusting the head-up display on the on-board computer

Selecting display content of the head-up display on the menu bar of the driver display

- ▶ Press the main menu button on the left .
- ▶ **To select the menu bar of the head-up display:** swipe upwards on the left-hand Touch-Control.
- ▶ **To select the display content on the menu bar of the head-up display or to switch between display contents:** swipe to the left or right on the left-hand Touch-Control to activate the desired content.

Switching between display contents on the head-up display

- ▶ **To select the menu bar of the head-up display:** swipe upwards on the left-hand Touch-Control.
- ▶ **To select display content:** swipe to the left or right on the left-hand Touch-Control and select a type of content.

- ▶ Press and hold the  button. The content has been selected on the head-up display.
- ▶ **To switch between types of display content:** swipe to the left or right on the left-hand Touch Control.
- ▶ **To exit the head-up display:** press the  or  button.

Setting the position and brightness

- ▶ On the menu bar of the head-up display, select the **Settings** menu by swiping to the left or right.
 - ▶ Press the left-hand Touch Control. The current position and brightness settings will be displayed graphically on the head-up display as well as on the driver display.
 - ▶ **To adjust the position:** swipe upwards or downwards on the left-hand Touch Control.
 - ▶ **To adjust the brightness:** swipe to the right or left on the left-hand Touch Control.
-  The settings made for position and brightness will be automatically saved and then displayed graphically again.

To switch the head-up display on/off

On-board computer:



- ▶ **To switch on:** swipe upwards on the left-hand Touch Control.
Switch on the HUD will appear.
 - ▶ Press left-hand Touch Control .
 - ▶ **To switch off:** swipe upwards on the left-hand Touch Control.
 - ▶ Select **Switch on the HUD?** by swiping on the left-hand Touch Control .
 - ▶ Press left-hand Touch Control .
- You can also switch the head-up display on/off in the MBUX multimedia system on the assistance menu.

Notes on operating safety

⚠ WARNING Risk of distraction from information systems and communications equipment

If you operate information and communication equipment integrated in the vehicle when driving, you will be distracted from the traffic situation. This could also cause you to lose control of the vehicle.

- ▶ Only operate this equipment when the traffic situation permits.
- ▶ If you cannot be sure of this, stop the vehicle whilst paying attention to road and traffic conditions and operate the equipment with the vehicle stationary.

For your own safety, always observe the following points when operating mobile communications equipment and especially your voice control system:

- Observe the legal requirements for the country in which you are driving.

- If you use the voice control system in an emergency your voice can change and your telephone call, e.g. an emergency call, can thereby be unnecessarily delayed.
- Familiarise yourself with the voice control system functions before starting the journey.

i The voice control system does not replace the Owner's Manual.

The answers from the voice control system do not provide the complete scope of information contained in the Owner's Manual. The voice control system does also not give detailed warning or damage information. You can get the full scope of information about the function and safe operation of the systems and components in the vehicle in the Owner's Manual.



Operation

Overview of operating the multifunction steering wheel

Using MBUX Voice Assistant, various areas of the MBUX multimedia system can be operated

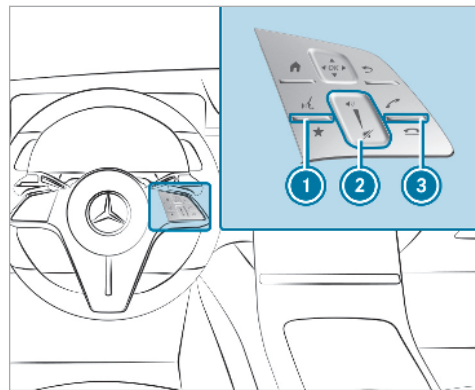
by voice input, e.g. telephone or navigation. The MBUX Voice Assistant is operational approximately thirty seconds after the ignition is switched on.



- ① Pressing up:  starts the dialogue
- ② Pressing : switches the sound off or on (ends the dialogue)

Swiping up/down: increases/decreases the volume

- ③ Pressing down:  rejects/ends a call (ends the dialogue)

Conducting a dialogue



For the dialogue with MBUX Voice Assistant, you can use complete sentences of colloquial language as voice commands, such as, for example, "Please show me the list of the last calls" or "How warm is it outside?".



- ① MBUX Voice Assistant can recognise different voices. The system learns from the habits of the individual user and can thereby make appropriate suggestions.
- ▶ **To activate or continue dialogue by using a keyword:** say "Hey Mercedes" to activate MBUX Voice Assistant. Voice activation must be switched on in the multimedia system (→ page 288). For this, it is not necessary to

press the  button upwards on the multifunction steering wheel.

Voice activation can also be directly combined with a voice command, e.g. "Hey Mercedes, how fast can I drive?".

or

- ▶ Press the  button on the multifunction steering wheel upwards. You can say a voice command after an acoustic signal.
- ▶ **To correct an entry:** say the "Correction" voice command.
- ▶ **To select an entry from the selection list:** say the line number or the contents.
- ▶ **To browse the selection list:** say the "Next" or "Back" voice command.
- ▶ **To interrupt the dialogue:** say the "Pause" voice command. The dialogue can be continued with the "Hey Mercedes" voice command or by pressing the  button on the multifunction steering wheel upwards.

- ▶ **To jump to the preceding dialogue:** say the "Back" voice command.
- ▶ **To jump back to the top dialogue level:** say the "From the beginning again" voice command.
- ▶ **To cancel the dialogue:** say the "Close" voice command or press the  or  button on the multifunction steering wheel.
- ▶ **To interrupt a voice output:** speak in the middle of a voice dialogue when the system is still answering. The voice output is shortened and the conclusion is reached more quickly.
- ① The **Voice barge-in** option must be switched on in the multimedia system for this (→ page 288).

Overview of the operable functions of MBUX Voice Assistant

Using MBUX Voice Assistant you can operate various functions, e.g. navigation, telephone or vehicle functions, depending on the vehicle equipment.

Calling up vehicle information

With the "Hey Mercedes" voice command you can also call up vehicle-specific information via the voice control system. For example, you can ask questions about the vehicle equipment or about specific operating options.

The system is set up for operation with natural speech and independently learns new patterns of formulation. This means, you need not comply with any specified voice commands when operating.

With targeted questions, you can call up information for various application situations. The following examples give an overview of how you can interact with the system in order to call up specific information about your vehicle:

- Information about individual items of your vehicle equipment:
 - Hey Mercedes, which massage programmes do you have?
 - Hey Mercedes, do I have Blind Spot Assist?
- Information about functioning of the systems and components installed in the vehicle:

- Hey Mercedes, what is DISTRONIC?
- Hey Mercedes, what do I need ESP for?
- Information about operating the systems and components installed in the vehicle:
 - Hey Mercedes, how can I turn on the main-beam headlamps?
 - Hey Mercedes, how do I stop the ionisation function?
- Information about warning and indicator lamps on the instrument cluster:
 - Hey Mercedes, what is lit now on my instrument cluster?
 - Hey Mercedes, what is that yellow light flashing?

Full functionality of the voice control system is only available for you with activation of online voice control (→ page 288).

Notes on the language setting

You can change the language of MBUX Voice Assistant via the system language settings. If the

set system language is not supported by MBUX Voice Assistant, English will be selected.

Setting functions of MBUX Voice Assistant using the multimedia system

Requirements:

- **For online voice control:** your vehicle is connected with your Mercedes me user account (→ page 406).
- There is an Internet connection (→ page 414).
- **For online use of contacts:** online voice control is activated.
- **For use of In-Car Office:** see (→ page 389)

Multimedia system:

→  » Settings » System
 » Voice assistant

Switching voice activation of MBUX Voice Assistant on or off

- ▶ Select **Hey Mercedes**.
Depending on the previous status, the function is activated or deactivated.
When the function is active, the "Hey Mercedes" voice command can activate the dialogue.

Switching on voice interruption

- ▶ Select **Voice barge-in**.
If the function is active, a command can be interjected during voice output of the system.

Activating or deactivating online voice control

- ▶ Select **Online recognition**.
Depending on the previous status, the function is activated or deactivated.

 Online voice control is activated at the factory.

- ▶ Select **Online recognition subscrip..**
You will be connected with the Mercedes me Portal.
- ▶ Activate online voice control in the Mercedes me Portal.



Activating contacts for online use

- ▶ Select **Contact upload for online recognition**.
When the function is active, contacts will be found more easily and accurately using voice input. The quality of the enunciation of contact names by the system will also be improved.

Using MBUX Voice Assistant effectively

Functionality of the MBUX Voice Assistant audible support

Using the corresponding voice commands you receive the following information and assistance in the following cases:

- **Current application:** on the multifunction steering wheel, press the  button upwards and say the "Help" voice command. You will receive suggestions and information about operation of MBUX Voice Assistant for the current application.
- **Continued dialogue:** say the "Help" voice command during a voice dialogue. For every step of the dialogue you receive matching information.
- **Specific function:** say the voice command for the desired function, e.g. with "Hello Mercedes, I need help with the radio" or after pressing the  button on the multifunction steering wheel upwards, say the "Help for the telephone" voice command, for example.

- **Digital Owner's Manual:** say the "Show me the Owner's Manual" voice command. The full extent of the Digital Owner's Manual is available when the vehicle is stationary.

Notes on optimum use of MBUX Voice Assistant

Notes on how to improve recognition:

- Say the voice commands coherently and clearly, but do not exaggerate the words.
- Avoid loud noises that cause interference while making a voice command entry, e.g. the entertainment in the rear-passenger compartment.
- **For telephone or address book entries:**
 - Only create sensible address book entries in the system/mobile phone, e.g. enter surname and first name in the correct field.
 - Do not use any abbreviations, unnecessary spaces or special characters.
- **For radio and/or TV programme names:** say the "Read out station list" voice com-

mand and say the desired station name in the way the voice output reads aloud to you.

Notes on online voice control

Online voice control improves recognition and makes additional results available as a result of external information, e.g. information about POIs and about the weather. We therefore recommend that you activate online voice control.

You will need a Mercedes me user account for this. If you do not yet have a user account you have to create one and connect it with your vehicle (→ page 406).

Then call up your Mercedes me user account. The Mercedes me services are shown and can be activated (→ page 406).

In addition, online voice control must be activated (→ page 288).

Overview and operation

Overview of the MBUX multimedia system

⚠ WARNING Risk of distraction from information systems and communications equipment

If you operate information and communication equipment integrated in the vehicle when driving, you will be distracted from the traffic situation. This could also cause you to lose control of the vehicle.

- ▶ Only operate this equipment when the traffic situation permits.
- ▶ If you cannot be sure of this, stop the vehicle whilst paying attention to road and traffic conditions and operate the equipment with the vehicle stationary.

You must observe the legal requirements for the country in which you are currently driving when operating the multimedia system.

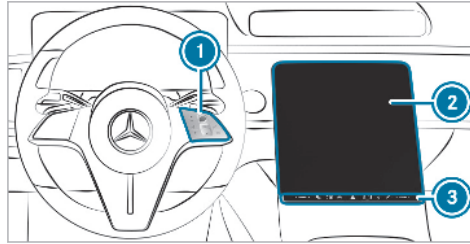

- ① Touch Control and control panel for the MBUX multimedia system
MBUX stands for Mercedes-Benz User Experience.
 - Operating Touch Control (→ page 293)
- ② Central display with touch functionality
 - Home screen overview (→ page 292)
 - Operating the touchscreen (→ page 293)
- ③ Control panel with fingerprint sensor, switches the MBUX multimedia system on/off, switches sound off/on and adjusts the volume

- ① Alternatively, the MBUX Voice Assistant allows voice dialogue. Operation with natural speech starts after the wake-up call "Hey Mercedes" (→ page 287). You can start a voice navigation, for example, with the input of a 3 word address from what3words.
- ① If the vehicle is fitted with the MBUX Interior Assistant, comfort functions and multimedia system functions can be used. The interaction then follows intelligently, reactively or with movements of the hand or head.
- ① If the vehicle is fitted with Eye Control, explanations can be given and functions initiated through "Look & Ask" and "Look & Answer".

Numerous application, online services, services and apps are available for you. These can be called up via the home screen.

You can conveniently call up and add your favourites using the  button on the steering wheel. Quick-access in the home screen and in the applications serve to select functions more quickly.

If you use the learn function of the multimedia system, you will receive suggestions during operation of the most probable navigation destinations, media sources, radio stations and contacts. The configuration of the suggestions takes place in your profile. You can compile your profile from various vehicle settings and settings of the multimedia system. You can create a theme for various driving situations.

The Notifications Centre collects incoming notifications, e.g. about an available software update. Depending on the type of notification it offers various actions. The Message Centre can be called up on the home screen via the Control Center.

With the global search in the vehicle you can search on-board across many categories as well as online in the Internet. You can use the global search on the home screen.

Anti-theft protection

This device is equipped with technical provisions to protect it against theft. More detailed information about anti-theft protection can be obtained at a qualified specialist workshop.

Home screen overview

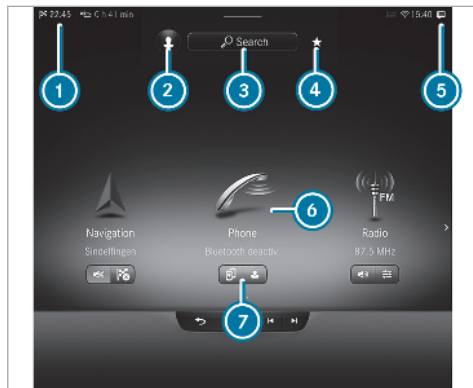



- ① Status line
- ② Calls up user profile settings and changes user
- ③ Uses the global search
- ④ Calls up favourites
- ⑤ Calls up the Notifications Centre

- ⑥ Calls up applications
- ⑦ Quick-access to application

If the bar above ③ is pulled down, the control centre appears.

The following functions are called up in the control centre:

- Multiseat control menu
- Vehicle quick-access
- Notifications Centre
- Favourites
- Themes

Call up the home screen on the touchscreen by pressing  (covered by ⑦ in the image) or on the Touch Control by pressing the  button.

In the image, the applications are arranged as a carousel. Pressing and holding on  arranges the applications in a grid. This presentation is also used by a smartphone, for example.

Touch Control

Operating Touch Control (MBUX multimedia system)

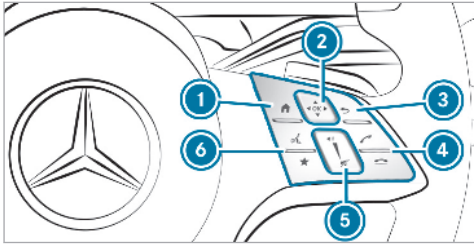

① Shows the home screen

② Touch Control

swipe in the direction of the arrow (navigate)

Press (confirm)

③ Returns to the previous display

④ Makes or accepts a call

Rejects or ends a call

⑤ Increase volume: swipe upwards
Reduce volume: swipe down

Switch off the sound: press

⑥ Starts the MBUX Voice Assistant

Calls up favourites (press briefly) or adds favourites and themes (press and hold)

You can navigate through menus and lists via the touch-sensitive surface of Touch Control ② using a **single-finger swipe**, for example:

- ▶ **To enter a character:** select a character using the keyboard.
- ▶ Press Touch Control ②.
- ▶ **To select a menu option:** scroll in the lists.
- ▶ Press Touch Control ②.
- ▶ **To move the digital map:** swipe in any direction.

Setting the sensitivity for the Touch Control

Multimedia system:

- ▶ ▶ Settings ▶ System
- ▶▶ Text is Missing ▶▶ Touch Control sensitivity
- ▶ Select **Fast**, **Medium** or **Slow**.

Setting acoustic operating feedback for the Touch Control

Multimedia system:

- ▶▶ ▶▶ Settings ▶▶ System
- ▶▶ Text is Missing
- ▶▶ Acoustic operating feedback

The function is supported by the selection in a list.

- ▶ Set **Off**, **Normal** or **Loud**.
If the function is activated you will hear a clicking sound when scrolling in a list. When the beginning or end of the list is reached you will hear another clicking sound.

Touchscreen

Operating the touchscreen

Tapping

- ▶ **To select a menu item or entry:** tap on a symbol or an entry.
- ▶ **To increase the map scale:** tap twice quickly with one finger.

- ▶ **To reduce the map scale:** tap with two fingers.
- ▶ **To enter characters with the keypad:** tap on a button.

Single-finger swipe

- ▶ **To navigate in menus:** swipe up, down, left or right.
- ▶ **To move the digital map:** swipe in any direction.
- ▶ **To use handwriting to enter characters:** write the character with one finger on the touchscreen.

Two-finger swipe

- ▶ **To zoom in and out of the map:** move two fingers together or apart.
- ▶ **To enlarge or reduce the size of a section of a website:** move two fingers together or apart.
- ▶ **To turn the map:** turn anti-clockwise or clockwise using two fingers.

Three-finger swipe

- ▶ **To call up the home screen:** swipe up with three fingers in an application.

Touching, holding and moving

- ▶ **To move the map:** touch the touchscreen and move your finger in any direction.
- ▶ **To set the volume on a scale:** touch the touchscreen and move the finger to the left or right.

Touching and holding

- ▶ **To save the destination in the map:** touch the touchscreen and hold until a message is shown.
- ▶ **To call up a global menu in the applications:** touch the touchscreen and hold until the **Options** menu appears.

Setting haptic operation for the touchscreen

Multimedia system:

- ▶  ▶ **Settings** ▶ **System**
- ▶ **Touchscreen**

- ▶ Switch **Haptic operating feedback** on or off. When the function is activated, a tactile feedback in the form of a vibration can be felt during operation.

- ▶ **To set the intensity of the feedback:** select



- ▶ Select an option.

Setting haptic pressure

- ▶ Switch **Press haptics** on or off. The function generates a button to press based on selection of feeling.

- ▶ **To set the strength of pressure:** select



- ▶ Select an option.

Overview of the fingerprint sensor

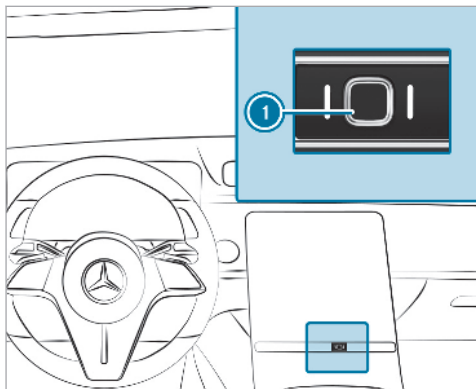

Fingerprint sensor ① allows you to conveniently access protected MBUX multimedia system functions and services. Compared to protection provided by the Mercedes me PIN, the entry of a four-digit number is not required to activate services and functions with personal content.

Depending on the vehicle equipment, further biometric sensors are available in addition to the

fingerprint sensor. Biometric data must be taught in by sensors (→ page 297).

User

Information on user profiles

⚠ WARNING Risk of becoming trapped during adjustment of the driver's seat after calling up a driver profile

Selecting a profile may trigger an adjustment of the driver's seat to the position saved under the profile. You or other vehicle occupants could be injured in the process.

▶ Make sure that when the position of driver's seat is being adjusted using the multimedia system, no people or body parts are in the seat's range of movement.

If there is a risk of someone becoming trapped, stop the adjustment process immediately:

- ▶ a) Tap the warning message on the central display.
- or
- ▶ b) Press a memory position button or a seat adjustment switch on the driver's door.
The adjustment process is stopped.

The driver's seat is equipped with an anti-entrapment feature.

If the driver's door is open, the driver's seat will **not** be set after calling up the driver's profile.

Overview of user profiles

Requirements for use

For the vehicle owner:

- You have a Mercedes me account.
- The vehicle has been linked to the account.

For additional users of the vehicle (without invitation):

- You have a Mercedes me account.

- The vehicle owner has activated the vehicle for the self-connection process.
- You upload your user profile to the vehicle via the QR code.

For additional users of the vehicle (with invitation):

- **You have a Mercedes me account.**
- The vehicle owner has invited you to connect your account on Mercedes me with that of their vehicle.
- You have accepted the invitation.

User profiles save vehicle settings and settings in the multimedia system. If the vehicle is used by several drivers, the driver can select their profile without changing the settings of other drivers.

If the vehicle is equipped with the MBUX high end Rear Seat Entertainment System, the occupants in the rear compartment can log in as Mercedes me users from their seats. The Multi-seat Profile Management allows three profiles to be used simultaneously. A user profile is seat-specific and can only be activated in one display.

You can set up a user profile in the vehicle via the set-up assistant or the profile options. Some settings, e.g. the Mercedes me PIN and a profile photo are made in the Mercedes me App or in the Mercedes me Portal.

User-specific content and applications with personal data are protected. Depending on the vehicle equipment, the Mercedes me PIN and biometric sensors are used for this purpose. The system indicates which of the taught-in authentication steps are necessary in order to achieve the required security level. The PIN provides for the highest level of security.

If the vehicle key is linked with the user profile, the user profile is identified and pre-activated when the vehicle is opened. In doing so light, mirror and seat settings are pre-loaded. Authentication then follows and the user profile is activated.

- ⓘ When a user profile is activated the driver's seat, steering wheel and outside mirrors can be set.
If the user profile is activated when driving then the driver's seat position will not be adjusted.

User-specific content

Depending on the vehicle equipment you can, as a user, save the following settings:

- Driver's seat, steering wheel and mirror settings
 - Climate control
 - Ambient lighting
 - Radio (including station list)
 - Themes, suggestions and favourites
- ⓘ Settings for driver assistance systems cannot be saved in the user profile.

Adding a user

Multimedia system:

➔  ➔  ➔ [Changing user](#)

- ▶ Select [Add user](#).
A QR code is loaded.
- ▶ Scan the displayed QR code with the Mercedes me App.

The vehicle is linked to the user profile. The user profile is synchronised with the multimedia system and downloaded from the Mercedes me Portal.

You receive a message when the user profile is available. This procedure may take some minutes.

- ▶ Select **Ja** (Yes).

The user profile is activated.

- ▶ Follow the directions from the set-up assistant.

or

- ▶ Select the user options.

Selecting user options

Multimedia system:



- ▶ Select **Settings**.

Making settings for suggestions

- ▶ Select **Suggestions settings**.

- ▶ **To configure suggestions:** select **Suggestions**.

- ▶ Switch the options on or off.

If an option is switched on and sufficient data has been gathered, personalised suggestions based on your user behaviour will be offered to you. These are for example vis-

ited navigation destinations, dialled phone numbers and your preferred comfort features and music.

- ▶ **For intelligent multimodality:** select **Multimodality**.

If the option is active, the MBUX Voice Assistant can be activated in certain situations. You can, for example, confirm displayed display message by speaking, receive information about display messages or be prompted to provide voice input.

- ▶ **To switch the learning function off for 24 h:** switch on **Deactiv. intelligent learning for 24h**.

About 15 minutes before the activated option ends, you will receive a message that the learning function will begin again shortly.

- ▶ **To delete cumulated suggestions:** select **Reset suggestion history**.

- ▶ Select **Ja** (Yes).

Protecting user-specific content and applications

if you add a new user, access protection is already activated. Depending on the vehicle

equipment, the Mercedes me PIN, biometric sensors and the vehicle key are available for access protection. Biometric sensors must be taught in. Authentication is carried out using your method of choice.

The following user-specific content and applications are protected, for example:

- **User selection and user profile settings**
- **Suggestions**
The data and the determination of the most probable navigation destinations, media sources, radio stations or contacts are protected.
- **ENERGIZING COACH**
The recorded health data and their evaluation are protected.
- **In-Car Office**
The calendar, the tasks and the e-mails are protected.
- **Parking service**
The payments are protected.
- **Mercedes me connect store**

The purchase of services is protected.

- The system activations of purchased vehicle functions are protected.

▶ Activate [Protect content](#).

Teaching in, editing and deleting biometric data

The biometric data is saved in the sensors in the vehicle. When recognition has been taught in, you can authenticate yourself with the applicable method on the multimedia system.

▶ Select [Biometric data](#).

▶ Select [Fingerprint](#), [Facial recognition](#) or [Voice recognition](#).

▶ **Finger print:** put your finger on the finger print sensor under the touchscreen (→ page 295).

The finger is scanned. If the scanning procedure is successful, a message appears in the central display. You can unlock your user profile and protected applications with your finger print.

▶ **Facial recognition:** look at the driver display for about five seconds.

Your face is scanned. A message in the driver display shows whether facial recognition was successful or not. You can unlock your user profile and protected applications with the facial scan.

▶ **Voice recognition:** say the sentence shown in the central display and repeat it twice.

If the voice recognition was successful, a message appears in the central display. You can unlock your user profile and protected applications with voice recognition.

▶ **To edit biometric data:** select [Edit](#).

▶ Change the biometric data.

▶ **To delete biometric data:** select [Delete](#).

▶ Select [Ja](#) (Yes).

Editing, deleting or resetting user profiles to the factory settings

▶ **To edit:** select [Edit](#).

▶ Change the name.

▶ Select [OK](#).

ⓘ If your photo is not yet stored in the Mercedes me Portal you can select a photo from a list.

▶ **Pre-activation of the user profile:** select [Pre-activate user profile](#).

▶ Depending on the vehicle equipment, select [Vehicle key](#) or [Digital Vehicle Key](#).

The user profile is linked to the selected key. If you open the vehicle with the key, the light, mirror and seat settings for your user profile are pre-activated with the vehicle key which you are currently using to unlock the vehicle.

A key can only be saved for one user profile.

▶ **To delete:** select [Remove](#).

▶ Select [Ja](#) (Yes).

▶ **To reset to factory settings:** select [Reset](#).

▶ Select [Ja](#) (Yes).

Selecting a user

Multimedia system:



ⓘ When you call up your driver profile, the driver's seat and the steering wheel can be set.

You can cancel the setting process with the following actions:

- Tap on the [Tap here to cancel.](#) message in the central display.
- Press one of the seat operating buttons in the driver's door.

▶ Selecting a user.

▶ Press the button to confirm the message.

The user profile is loaded and activated.

- ⓘ If you select [Continue without user selection](#) no specific settings for the user profile are loaded.

Synchronising user profiles

Requirements:

- You have a Mercedes me Account.
- The vehicle is linked with your Mercedes me user account.

Multimedia system:

→  →  → Settings

▶ Synchronisation

▶ Activate [Synchronise user profiles automatically.](#)

When the ignition is switched on or off, the data stored in the vehicle is automatically synchronised with the user-specific content on Mercedes me connect.

or

▶ Select [Synchronise user profiles now.](#)

After selecting this option, the data stored in the vehicle is synchronised with the user-specific content on Mercedes me connect.

- ⓘ During synchronisation the user profile list and the profile functions are blocked.

- ⓘ **Note on data protection:** if you do not wish to share your data with Mercedes me, make sure that the automatic synchronisation is switched off and do not select [Synchronise user profiles now.](#)

Themes

Overview of themes

You can configure the vehicle settings according to your preferences, save as a theme and call up any time via the home screen. There are predefined themes, e.g. Journey, Efficiency and Lounge.

Example of a theme

You can create a theme for a typical driving situation, e.g. for a long motorway journey.

The following settings can be stored in a theme, for example:

- The navigation map
- Current messages in the driver's display
- The preferred audio source
- The preferred drive program

You can make further settings and allocate a name. For the next motorway journey, the theme and the settings you have made are available again.

Content of a theme

Depending on vehicle equipment the following settings can be saved in a theme:

- Setting of driver's display (→ page 273)
- Setting of the Head-up Display (→ page 284)
- Setting of the ambient lighting (→ page 151)
- Active audio source, e.g. radio or USB
- Starting screen for the central display
- Design

The style depends on the set context in the driver's display, for example Performance.

- DYNAMIC SELECT drive program (→ page 184)
- Eco start/stop setting (→ page 182)
- Navigation system settings

Calling up themes

Multimedia system:



- ▶ Select **Themes**.
- ▶ Select a theme.

Creating new themes

Requirements:

- The settings which are to be saved in the theme are active.

For more information on content of themes see (→ page 299).

Multimedia system:



- ▶ Select **Themes**.
- ▶ Select **Create new theme**. The settings which are saved in the theme are shown.
- ▶ Select .
- ▶ Select additional settings, e.g. **Navigation** which are to be saved in the theme.
- ▶ Select .
- ▶ Select an entry screen, e.g. **Media**.
- ▶ Select .
- ▶ Select an image.
- ▶ Enter a name for the theme and confirm with .

- ▶ Select **Save theme**.

- ⓘ The selection of an image is not possible in all countries.

When the maximum number that can be saved is reached:

- ▶ Select from the prompt.
- ▶ Select a theme that should be overwritten.
- ▶ Proceed as described above.

Creating using a button on the steering wheel

- ▶ Press and hold the button on the steering wheel.
- ▶ Select **Create new theme**.
- ▶ Proceed as described above.

Managing themes

Multimedia system:



- ▶ Select **Themes**. The themes are displayed.

Moving themes

- ▶ Press on a theme until a menu is shown.
- ▶ Select **Move** .
- ▶ Move the theme to a new position using drag & drop.

Renaming themes

- ▶ Press on a theme until a menu is shown.
- ▶ Select **Edit theme** .
- ▶ Select **Rename** .
- ▶ Enter the name.
- ▶ Select **Save theme** .

Writing over a theme with new settings

- ▶ Press on a theme until a menu is shown.
- ▶ Select **Overwrite** .
- ▶ Select **Ja** (Yes) .

Deleting themes

Multimedia system:



- ▶ Select **Themes** .

- ▶ Press on a theme until a menu is shown.
- ▶ Select **Delete** .
- ▶ Select **Ja** (Yes) .

Resetting themes

- ▶ Press on a theme until a menu is shown.
- ▶ Select **Reset themes to factory settings?** .
- ▶ Select **Yes** .

Favourites

Overview of favourites

Favourites offer you quick access to frequently used applications. It is possible to create 20 favourites in total.

You can select favourites from categories or you add favourites directly from an application.

Calling up favourites

Multimedia system:



- ▶ Touch the status bar with a finger and swipe down.

- ▶ Select **Favoriten** (Favourites) in the Control Center.

Calling up on the steering wheel

- ▶ Press the  button.



Adding favourites

Multimedia system:



- ▶ Touch the status bar with a finger and swipe down.
- ▶ Select **Favoriten** (Favourites) in the Control Center.

Selecting favourites from categories

- ▶ Select .
- ▶ Select  **Create new favourite**.
- ▶ Select the category.
- ▶ Select a favourite.
The favourite is stored at the next available position.
- ▶ **All positions in the favourites are taken:** confirm the message shown with **OK**.
A list shows all the favourites.

- ▶ Select a favourite which should be overwritten.

Adding a favourite from an application

You can save a contact, for example, or add an ENERGIZING Comfort programme.

- ▶ **To save a contact as a global favourite:** select a contact (→ page 383).
- ▶ Press on a telephone number until a menu is shown.
- ▶ Select [Save as favourite](#).
The contact is added as a favourite.

Renaming favourites

Multimedia system:



- ▶ Touch the status bar with a finger and swipe down.
- ▶ Select [Favoriten](#) (Favourites) in the Control Center.
- ▶ Press on a favourite until a menu is shown.
- ▶ Select [Rename](#).
- ▶ Enter the name.

- ▶ Select [OK](#).

Moving favourites

Multimedia system:



- ▶ Touch the status bar with a finger and swipe down.
- ▶ Select [Favoriten](#) (Favourites) in the Control Center.
- ▶ Press on a favourite until the menu is shown.
- ▶ Select [Move](#).
- ▶ Move the favourite to the new position.
- ▶ Tap on .

Deleting favourites

Multimedia system:



- ▶ Touch the status bar with a finger and swipe down.
- ▶ Select [Favoriten](#) (Favourites) in the Control Center.
- ▶ Press on a favourite until a menu is shown.
- ▶ Select [Delete](#).

- ▶ Select [Ja](#) (Yes).

Resetting favourites

- ▶ Select [Reset all favourites](#) in the menu.
- ▶ Select [Ja](#) (Yes).

Notifications Centre

Overview of the Notifications Centre

The following communications are collected in the Notifications Centre:

- Communications which are generated by the vehicle or from multimedia system.
- Communications which are received through the use of services.

The following notification types are available for you:

- Navigable destinations and routes
- Messages (text messages)
- Calendar entries and reminders, e.g. from In-Car Office

This function is not available in all countries.

- System information, e.g. [Important software update available. Confirm to start the update.](#)
- Other notifications, e.g. from additional online services that can be subscribed to



The Notifications Centre is in the Control Center. Newly received messages will be indicated with a blue circle.

Notifications are normally briefly shown as they are received. If you take no action, these are stored for future access in the Notifications Centre.

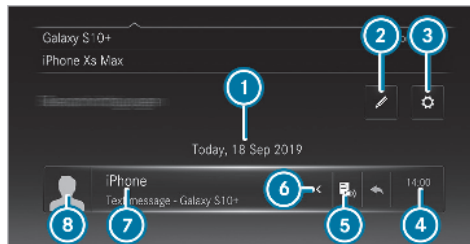
The notifications are sorted chronologically. The most recent notifications are at the top.



Example of a message

- ① Date of message received
- ② To edit message
- ③ To call up the settings
- ④ Time message received
- ⑤ Available action
- ⑥  To open up bar (more actions available)
-  To close bar
- ⑦ Device name or name of the application or service and further information
- ⑧ Symbol or an image for the application

Depending on the type of notification, up to four different actions are available.

Examples of actions include:

- Reading aloud
- Placing a call
- Reply
- Calling up a web page
- Navigation

Some notifications, e.g. a navigation destination, are stored longer. Therefore, it is not necessary to carry out available actions directly upon receipt of the notifications. A route guidance can be started at a later time.

You can pin a message so that this is not deleted automatically after a certain time.

Calling up notifications

Opening the Notifications Centre

- ▶ On the touchscreen, touch the bar above  Search with a finger and pull downwards.

The Control Center opens.

- ▶ Select the Notifications Centre.

Selecting a notification

- ▶ Tap on the message.
- ▶ if several messages are available swipe up or down.

Closing the Notifications Centre

- ▶ Swipe up with two fingers.

Selecting actions for a notification

The following options are available:

- Select the action directly after a notification is received and shown.
- Select the action later after calling up in the Notifications Centre.

- ▶ **An action is available:** select the action.

- ▶ **Several actions available:** select .

- ▶ Select the action.
The notification is still available.

- ▶ Close the actions with .

Editing notifications

- ▶ Call up the Notifications Centre (→ page 303).

Configuring the settings

- ▶ Select .

- ▶  If no settings can be made, a message appears.

- ▶ Select the service.

- ▶ Switch the options on or off.

The following options are available:

- [Allow notifications](#)
- [Display in notification centre](#)
- [Show notifications](#)
- [Acoustic signals](#)
- [External access](#)

The option allows external service access to specific data, e.g. the current vehicle position. With , the detailed, released information can be shown.

If [Allow notifications](#) is switched off, the options cannot be selected with the exception of [External access](#).



Pinning a message

- ▶ Drag a message to the right on the touchscreen.
- ▶ **To display pinned messages only:** select  in the Message Center.

Deleting notifications

- ▶ Drag a message to the left on the touchscreen and place in .

or

- ▶ Select the pen symbol.
- ▶ Select  next to a message or  [Delete all](#).
- ▶ Select [Yes](#).
- ▶ Call up the Message Center with .

Global search

Global search overview

You can use the global search in the home screen and in the notifications. You can input characters using the keyboard or the handwriting recognition. Alternatively, the MBUX Voice Assistant allows voice input.

The global search provides search results for the following categories:

- Navigation
- Entertainment
- Telephone, social media, In-Car Office
In-Car Office is not available in all countries.
- User interface and Digital Owner's Manual
- Internet

The global search enables you to search for towns, roads and tourist attractions with the navigation system, for example.

The global search makes it possible to enter a 3 word address (→ page 339).

When the search field is empty the most probable suggestions are shown. The search results in

the list are shown, sorted according to category. Next to the category is the number of results. You will be shown the best results from each category. Additional results can be found after selecting the respective category.

If you confirm an entry with **OK** (OK), all categories and the number of results will be shown in a summary. Categories include **Navigation** and **Entertainment**, for example. After selecting a category you can select the search results within the category. When you select a search result the detailed view opens. In the detailed view you can choose whether and which actions you want to carry out with the respective search result. For example, you can start route guidance or place a call to somebody. The actions are named correspondingly.

Using the global search

Multimedia system:



- ▶ Select  **Search**.
- ▶ Enter the search term into the search field. The three most likely suggestions are offered during the input.

In the list, the top two search results are shown for each category.

- ⓘ Alternatively, the MBUX Voice Assistant allows voice input via .

- ▶ **To accept a suggestion:** select the suggestion. The three most likely suggestions are offered.
- ▶ Continue the search or accept a suggestion.
- ▶ **To accept the second search result:** select the search result. An action starts or a list is shown.
- ▶ Select a search result or an action in the list.
- ▶ **To show all categories:** select **OK** (OK).
- ▶ **To show search results for a category:** select a category.
- ▶ **To show details:** select a search result.
- ▶ **To start an action:** select an action. After selection of an action, a track is played back or the route to a destination is calculated, for example.

Switching the sound on/off

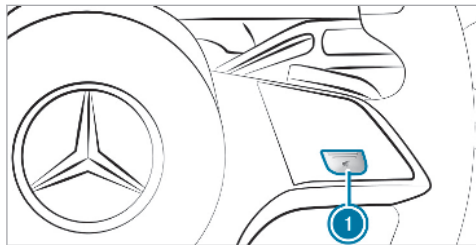

On the steering wheel

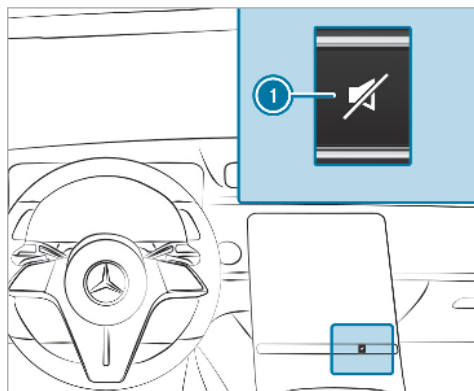

In the control panel above the centre console

- ▶ **To switch off:** press button ①.
The current audio source is switched off.
The  symbol appears in the status line of the central display.
If you are listening to a radio station, for example, and switch off the sound then all media sources will be muted.

Traffic and navigation announcements can still be heard in this case. The MBUX Voice Assistant and telephony are also not affected.

- ▶ **To switch on:** press button ① again.
- or
- ▶ Set the volume.
- or
- ▶ The media source changes.

Adjusting the volume

Setting with the button

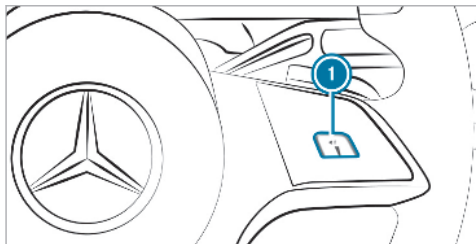

On the steering wheel (MBUX multimedia system)

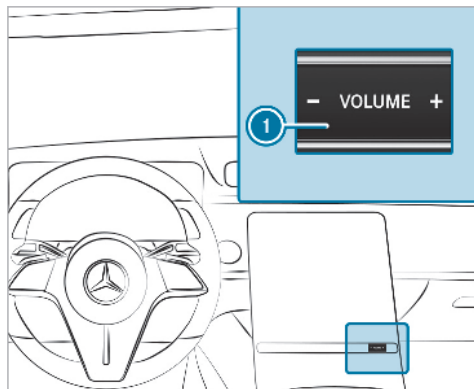

On the MBUX multimedia system

▶ Press **1** **-** or **+**.

or

▶ Swipe across the button.

The volume of the current audio source in the foreground is set.

The volume can be adjusted using the volume control for the following groups:

- Entertainment volume
- Ringtone volume
- Call volume, for example phone call volume
- Voice output volume, for example MBUX Voice Assistant
- Volume of driving recommendations in the navigation

i If you set the volume of the voice output to "0" for example, a minimum volume is automatically set when the MBUX Voice Assistant is next called up. The entertainment volume is automatically adjusted after the multimedia system is restarted.

Setting in the menu

▶ Press the  button on the steering wheel.

or

▶ Select  on the touchscreen. The home screen appears.

▶ Select **Settings**.

- ▶ Select **System**.
- ▶ Select **Audio**.
- ▶ Select a volume setting.

 The volume can be set for all groups except the entertainment volume.

- ▶ Set the volume.

The following settings can also be made in the menu:

- Activating/deactivating the driving recommendations in the navigation during a telephone call.
- Reducing the entertainment volume while a driving recommendation is being issued.

Entering characters

Using the character input function

Requirements:

- **For the handwriting recognition read-aloud function:** the MBUX multimedia system is equipped with the MBUX Voice Assistant.

- The read-aloud function is available for the selected system language.
- The handwriting recognition read-aloud function is activated.

Enter the characters on the Touch Control or on the touchscreen (central display). Character input can be started with a control element and resumed with another.

- ▶ When the keypad is shown, enter the characters by swiping and pressing on the Touch Control or by tapping on the touchscreen.

or

- ▶ If handwriting recognition has been selected, write the characters on the touchscreen.

Examples for character input include the global search, entering a navigation destination or the renaming of a favourite, for example.

The touchpad supports character input with the following functions:

- Handwriting recognition offers character suggestions.

- If the read aloud function is activated for handwriting recognition then the entered characters are read aloud.

Entering characters on the touchscreen Requirements:

- If you wish to have the character input read aloud: the read aloud function of the handwriting recognition is switched on .
- An online connection is required for some functions.

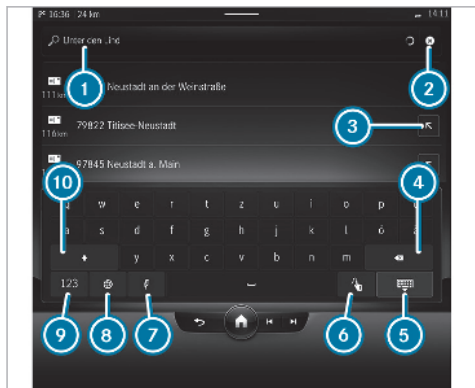

Example: character input with the keypad

- ① Input line with current entry
- ② Deletes an entry
- ③ Puts the search result into the input line and continues entry
- ④ Deletes the last character entered
- ⑤ Accepts an entry
- ⑥ Switches to handwriting recognition

- ⑦ Switches to voice input
- ⑧ Sets the written language
- ⑨ Switches to digits
- ⑩ Switches to upper-case or lower-case letters

▶ Example: call up the navigation and enter a destination address (→ page 302).

▶ Briefly press on a character.

The character is entered in input line ①.

▶ Resume character input.

▶ **To enter an alternative character:** press and hold a character.

Select the character.

▶ **To end character entry:** press briefly on .

- ⑰ The available editing functions depend on the editing task, the language set and the character level.

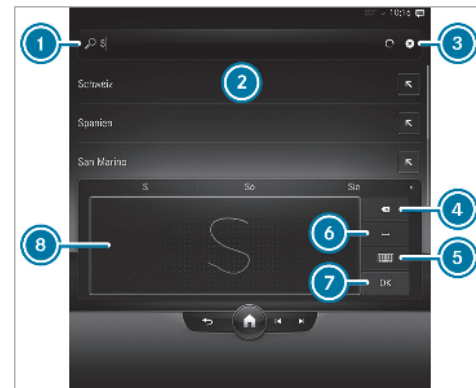





Entering characters with handwriting recognition

- ① Input line
- ② Shows suggestions during input
- ③ Deletes an entry
- ④ Pressing briefly deletes the last character entered
Pressing and holding deletes the entry

- 5 Switches to input using the keyboard
- 6 Enters a space
- 7 Accepts an entry
- 8 Writing area

If available, the  symbol allows you to change to voice input.

- ▶ When the keyboard is displayed, select .
- ▶ Write the character with one finger on the touchscreen. The letters can be written next to each other or above each other. The character is entered in input line ①. Suggestions are shown in ②.
- ▶ Select one of the suggestions.
- ▶ If available, display additional suggestions with  or .
- ▶ **To end character entry:** press briefly on .

Setting the keyboard and handwriting recognition for character entry
Requirements:

- For **Read out handwriting recognition:** the MBUX multimedia system is equipped with the MBUX Voice Assistant.
- The read-aloud function is available for the selected system language.

Multimedia system:

- ▶  ▶ Settings ▶ System
- ▶▶ Keyboards and handwriting
- ▶ Select **Keyboard languages**.
- ▶ Select a keyboard language.

Handwriting recognition functions

- ▶ Activate **Read out handwriting recognition**. The letter that you write on the touchscreen is read aloud.
- ▶ Activate **Handwrit. recognition on keyboard**. You can write characters directly on the keyboard.
- ▶ Select **Writing speed** .
- ▶ Select an option.

Deleting the user dictionary

The user dictionary learns from your inputs and offers suggestions during character input. You can reset the user dictionary.

- ▶ Select **Reset my dictionary**.
- ▶ Select **Ja (Yes)**.

MBUX Interior Assistant

Notes on lasers and laser classification

⚠ WARNING Risk of injury due to laser beams from the camera

This product uses a class 1 laser system. If the housing is opened or damaged, invisible laser beams could damage your retina.

- ▶ Do not open the housing.
- ▶ Always have maintenance work and repairs carried out by a qualified specialist workshop.

This device is a class 1 laser product in accordance with DIN EN 60825-1:2014

Overview of the MBUX Interior Assistant

The MBUX Interior Assistant monitors the driver and front passenger using 3D cameras in the roof lining. In so doing, it interprets their movements and their overall body language in order to assist, appropriate to the situation, with automatically triggered functions in the vehicle interior.

The Assistant supports vehicle and infotainment functions at three interaction levels:

- INTELLIGENT

The Assistant recognises vehicle occupants automatically and carries out functions.

- REACTIVE

The Assistant recognises the natural body language of a vehicle occupant and carries out functions automatically, appropriate to the situation.

- CONTACTLESS

The vehicle occupant actively demands a function through a hand movement or a favourite pose (V pose).

The Assistant offers functions for the following:

- SAFETY

The Assistant supports vehicle occupants with the use of the restraint system.

- COMFORT

The Assistant enhances comfort by automating functions inside the vehicle and supporting natural interaction with the vehicle.

- INFOTAINMENT

Operating options or information are highlighted and/or shown on the central display as a hand approaches. The vehicle occupants can carry out a favourite function with a V pose.

The Assistant recognises driver and front passenger interactions.

System limits, display messages and notes for rectification

The error messages are shown in the central display.

The system may be impaired or may not function in the following situations:

- The camera is covered or dirty, misted up or scratched.

The [The Interior Assistant is temporarily not available see Owner's Manual](#) message appears.

Clean the outside of the camera lens with a dry or damp cotton cloth. Do not use microfibre cloths. Do **not** remove the cover when cleaning.

- A vehicle occupant is very large. Clothing being worn (hat, scarf, colour of clothing) or objects carried on a person, for example a watch with a large face, are affecting the camera view. Or the detection area of the camera is limited.

The [Availability of the Interior Assistant is limited for the driver. See Owner's Manual](#) message appears.

Keep the camera's field of vision clear.

- The camera is too hot or is temporarily switched off.

The Interior Assistant is temporarily not available. You will be informed as soon as the function is available again.

Wait until the camera has cooled down or is available again.

You receive a message when the camera is available again.

- The camera or a cable is faulty.

The The MBUX Interior Assistant not available. Please visit the workshop. message appears.

Consult a Mercedes-Benz service centre.

The three types of interaction between vehicle and vehicle occupants:

Type of interaction	Description	Subject area and examples
INTELLIGENT	<p>The Assistant recognises the presence of vehicle occupants.</p> <p>Depending on the situation, functions are carried out automatically.</p>	<p>Safety</p> <ul style="list-style-type: none"> Information on fastening the child seat
REACTIVE	<p>The natural body language of a vehicle occupant, e.g. a hand or head movement, is recognised and triggers a function implicitly.</p>	<p>Comfort</p> <ul style="list-style-type: none"> Switching the search light on/off <p>Infotainment</p> <ul style="list-style-type: none"> Showing the navigation menu on the map
CONTACTLESS	<p>The vehicle occupant triggers a function by actively demanding this with a hand movement or a hand pose.</p>	<p>Comfort</p> <ul style="list-style-type: none"> Switching a reading light on/off <p>Infotainment</p> <ul style="list-style-type: none"> Calling up favourites with the V pose

Overview of supported interior functions:

Subject area	Functions (examples)	Type of interaction
SAFETY		
Transporting children in the vehicle more safely	<ul style="list-style-type: none"> • Information on fastening the child seat 	Intelligent
COMFORT		
Adaptive interior lighting	<ul style="list-style-type: none"> • Switching a reading light on/off • Switching the search light on/off 	Contactless Reactive
Smart comfort functions	<ul style="list-style-type: none"> • Automatic preselection of the outside mirror • Opening and closing the roller sunblind on the rear window 	Reactive Reactive
INFOTAINMENT		
Calling up favourites with the V pose	<ul style="list-style-type: none"> • Calling up favourites with the V pose 	Contactless
Reactive user interface	<ul style="list-style-type: none"> • Animating content on the home screen for driver or front passenger • Seat adjustments by the driver or front passenger • Showing the navigation menu 	Reactive Reactive Reactive

S02: Emergency call with transmission of number of vehicle occupants (SAFETY/intelligent)

If the emergency call system triggers an emergency call, the MBUX Interior Assistant detects the number of adults and children in the vehicle. This data is transmitted to the emergency call centre.

Measures for rescue, recovery or towing away can then be initiated more precisely.

Further information on the Mercedes-Benz emergency call system (→ page 407, 412).

S04: Anticipatory exit warning (SAFETY/reactive)

Requirements:

- The vehicle is equipped with DRIVE PILOT [code 200].
Further information about DRIVE PILOT .
- The vehicle is equipped with Blind Spot Assist [code 234].
- Blind Spot Assist is activated (→ page 263).

Observe the information on the system limits of Blind Spot and Active Blind Spot Assist with exit warning (→ page 260).

- The vehicle is stationary.
- The ignition is switched on.

The function can warn vehicle occupants about a possible collision with an approaching vehicle or bicycle when they exit the vehicle. The visual exit warning is issued **before** the door is opened and thus earlier than previously.

Depending on the vehicle equipment, the following warnings are issued:

- The active ambient lighting flashes red or
- The ambient lighting flashes red
- The warning light in the outside mirror flashes red.

When a vehicle occupant holds a hand in the vicinity of the door area, the warning light lights up briefly.

- When the door is opened, a warning tone sounds.

Notes on fastening the child seat (SAFETY/intelligent)

The MBUX Interior Assistant detects child restraint systems on the front passenger seat. If a child restraint system is not fastened, e.g. a rearward-facing child seat, a message appears in the central display.

The function assists you in making sure that a child restraint system is secured with the seat belt on the front passenger seat. It helps you to transport children safely in the vehicle.

- ① For further information on securing a child restraint system with the seat belt on the front passenger seat .

S06: Saving the child seat position with the MBUX Interior Assistant (SAFETY/intelligent)

The MBUX Interior Assistant detects child restraint systems on the front passenger seat. If a child restraint system is detected and this is fastened on the front passenger seat, a message appears in the media display. The set seat posi-

tion can be saved via the displayed memory buttons in the media display.

The function allows the front passenger seat to be adjusted before a child restraint system is fitted. It simplifies the use of child seats and helps you to transport babies and small children safely.

C07: Pre-setting the driver's seat position with the MBUX Interior Assistant (COMFORT/intelligent)

When creating a profile, the MBUX Interior Assistant detects the size of the driver and can **pre-set** the seat position if required.

The driver can make additional fine adjustments which are saved in the profile. When the profile is reactivated, the seat position is called up automatically after confirmation. The positions of the head restraints and steering wheel are also adjusted.

Further information for adjusting the driver's seat:

- Adjusting the front seat electrically (→ page 96)
- Setting the automatic seat adjustment on the MBUX multimedia system (→ page 106)

Switching the reading light on/off (COMFORT/contactless)

Requirements:

- The driver's and front passenger's hand movement takes place under the inside rear-view mirror.

A brief movement of the hand up and down, switches the reading light on or off.



Carrying out operation of the reading light for the driver and front passenger

- ▶ Move the hand up and down vertically under the reading light.
The reading light is switched on or off.
- ⓘ Further information on switching the reading lamps on and off (→ page 151).

Switching the search light on/off (COMFORT/reactive)

Requirements:

- The function is available in the vehicle when it is dark.

- The front passenger seat is not occupied.
- The function is available when it is dark.
- The driver's hand movement is carried out in the area of the front passenger seat.

The function enhances the comfort in the vehicle interior.

Naturally stretching out with the hand over the unoccupied front passenger seat, automatically switches a search light on for the driver when it is dark. Pulling the hand back switches the search light off again.

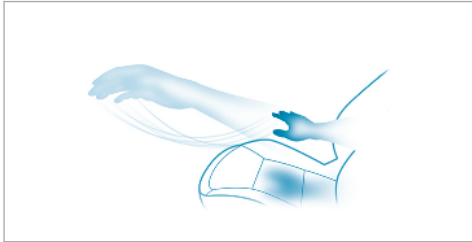

Interaction area for activating the search light

- ⓘ Not occupied means: nobody is on the front passenger seat or there are no large objects on it.

Automatic preselection of the outside mirror (COMFORT/reactive)

Until now, to set the outside mirror the desired mirror had to be selected using a preselection button in the driver's door (→ page 156).

With the MBUX Interior Assistant, the mirror to be set is preselected automatically by the natural movement of the head to the left or right.

The setting of the selected outside mirror is then carried out using the button in the door operating unit.

- ⓘ Preselection of the outside mirror using buttons ② or ④ is still possible (→ page 156).
- ⓘ The driver camera is also used for this application. In the process, the camera evaluates the driver's head position.

Opening/closing the roller sunblind on the rear window (COMFORT/reactive)

Requirements:

- The vehicle is equipped with an electric roller sunblind for the rear window.
- Reverse gear is engaged.

If the driver glances back over their shoulder in the direction of the rear window, the roller sunblind opens automatically.

If the vehicle is parked or before a journey is resumed, the roller sunblind is closed again automatically, if it was closed before reversing.

The function facilitates a good view when reversing, e.g. when parking, and reduces the number of operating steps.

- ⓘ Further information on opening and closing the roller sunblind on the rear window (→ page 92).

C17: Opening and closing the sliding sunroof and roller sunblind (COMFORT/contactless)

Requirements:

- The vehicle is fitted with a panoramic sliding sunroof.

The MBUX Interior Assistant allows contactless operation of the roller sunblind and the sliding roof. The function can be carried out by driver and front passenger.

The occupants in the rear can operate the rear roller sunblind.

Restriction: do not open the sliding sunroof if a roof rack is fitted. The sliding sunroof will then encounter resistance and subsequently remain in a raised position.

- ▶ **To open the roller sunblind and sliding roof:** the palm of your hand faces your head. Move your outstretched hand away from the windscreen towards the rear below the overhead control panel.
The roller sunblind opens.
- ▶ When the roller sunblind is open, repeat the hand movement.
The sliding roof opens.
- ▶ **To close the sliding roof and roller sunblind:** your palm faces away from your head.

Move your outstretched hand in the direction of the windscreen below the overhead control panel.

The sliding sunroof closes.

- ▶ When the sliding roof is closed, repeat the hand movement.

The roller sunblind closes.

- ▶ **To interrupt the opening and closing process:** stop the hand movement and move your hand away from below the overhead control panel.

The opening/closing process will be stopped.

- ⓘ Further information on opening and closing the sliding roof (→ page 86).

Calling up favourites with the V pose (INFORMATION/contactless)

Requirements:

- At least one favourite has been saved in the favourites list.
- The favourite has been connected with the MBUX Interior Assistant.

- The area for detecting the favourites pose (V pose) is in front of the central display. The hand should have a distance of at least 10 cm from the display.
- The V pose is held for a brief time.

The V pose makes it easier to call up favourites.

Each vehicle occupant can link their own favourites with the V pose. Some examples include a navigation destination, a radio station or a massage programme for a seat.

- ⓘ If a favourite has not yet been saved and connected with the MBUX Interior Assistant the multimedia system will assist you.



Carrying out the V pose

- ▶ Position your hand above the centre console in the direction of the central display. The back of the hand is facing upwards. In doing so the index and middle finger are spread to form a V with the other fingers bent inwards. The favourite is called up.

Operating functions by moving a hand towards the touchscreen (INFOTAINMENT/reactive)

Requirements:

- One of the following applications appears in the central display:
 - Seat settings with displays for seats, e.g. [Seat comfort](#) (driver's seat and front passenger seat only)
 - Home screen
 - Map in the navigation with active route
- Recognition occurs as the hand approaches to approximately 10 cm of the touchscreen.



Hand approaching the touchscreen

Seat adjustments by the driver or front passenger

In the seat settings menu, the MBUX Interior Assistant detects proximity to various control elements of the multimedia system. In addition, the MBUX Interior Assistant detects from which seat the action emanates.

- ▶ With the seat setting display active, move the hand towards the touchscreen. The seat of the operator is enlarged in the display.
- ▶ Depending on the function, the vehicle occupant can make settings for the seat function.

Animating content in the home screen

The MBUX Interior Assistant detects in which area the hand is in front of the touchscreen. The display of objects shown is animated to improve orientation.

- ▶ Move your hand towards the touchscreen. The contents in the home screen turn to the driver or front passenger.
- ▶ Continue operation, e.g. select a quick-access application.

- Further information about the home screen (→ page 292).

Showing the navigation menu on the map

If there is an active route, the MBUX Interior Assistant displays the navigation menu.

- ▶ Move your hand towards the touchscreen. The navigation menu is shown.
 - ▶ Continue operation and select a symbol.
 - ▶ As your hand is moved away from the touchscreen, the central display hides the navigation menu.
- Further information on the navigation menu (→ page 335).

Settings for the MBUX Interior Assistant



Multimedia system:

➤  ▶ Settings ▶ System

▶ MBUX interior assistant

- ▶ Select **On** or **Off**.
If the Assistant is activated, full functionality is used.

Switching individual functions on or off

- ▶ Activate  or deactivate  the switch.
- If **Basic functions** is switched on, all safety functions are activated.

Driver camera

Overview of the driver camera

The driver camera is in the driver's display or in the 3D driver display. It detects the head position, the viewing direction and the eyelid closure characteristics of the driver.

System limits

The system may be impaired or may not function in the following situations:

- The camera is covered or dirty, misted up or scratched.
- The camera or a cable is damaged.
- The driver's face and/or eyes are covered.
- The driver is wearing glasses that block infrared.

Assistants, operating and display systems as well as typical applications that are supported by the driver camera:

Assistant or operation and display system	Observe the following information:
DRIVE PILOT	Function of DRIVE PILOT and system limits
Driver display	Overview of driver's display
MBUX augmented reality Head-up Display	Display elements
ATTENTION ASSIST	Function of ATTENTION ASSIST with microsleeep detection
Personalisation	Facial recognition
Multimodality	MBUX Voice Assistant
Eye Control	MBUX Interior Assistant, automatic pre-selection of the outside mirror

Display messages

In the following situations display messages may be shown:

- If the driver camera is not functioning (→ page 602).
The camera or the cable is faulty.
- If the steering wheel position is impairing the view of the driver's face.

- If the driver camera has a limited view (→ page 602).

Notes on care

Please comply with the notes on caring for the interior (→ page 466).

Switching the driver camera on/off

Multimedia system:

- ▶  ▶ Settings ▶ System
- ▶ Driver camera
- ▶ Select On or Off.

When the driver camera is switched off, the following functions are not available or limited:

- DRIVE PILOT

- 3D driver display
- MBUX augmented reality Head-up Display
- The microsleep detection of ATTENTION ASSIST

- **Facial recognition (authentication)**

- **Multimodality**

The MBUX Voice Assistant is activated to confirm a display message by speaking, for example.

System settings

Display

Configuring display settings

Multimedia system:

  **»» Settings** **»» System** **»» Display**

Adjusting the brightness

- ▶ Select **Display brightness**.
- ▶ Set the brightness of the central display, the instrument cluster or the front passenger display.

Setting day/night design

- ▶ Select **Day/night design**.
- ▶ Select **Automatic**, **Day design** or **Night design**.

Switching the display surround lighting on/off

- ▶ Select **Illuminate display indirectly**.
The indirect lighting is switched on or off.

Switching 3D display of the instrument cluster on/off

- ▶ Select **3D Driver Display**.
The 3D display of the instrument cluster is switched on or off.

Switching the Head-up Display on/off

- ▶ Select **Head-up display**.
The Head-up Display is activated or deactivated.

Time and date

Setting the time zone

Multimedia system:

  **»» Settings** **»» System**
»» Time and date

- ▶ Select **Time zone**.
The list of countries is displayed.
 - ⓘ If there are several time zones available in a country, these will be shown after the country is selected.
 - ▶ Select a country and, if required, a time zone.
The time zone set is displayed after **Time zone**.
- or
- ▶ Select the **Automatic time zone** entry from the country list.
The time zone will be set automatically according to the vehicle location.
 - ⓘ The **Automatic time zone** option is available for vehicles with satellite reception.

Setting the time and date format

Multimedia system:

→  ▶▶ Settings ▶▶ System
▶▶ Time and date ▶▶ Set format

- ▶ Select a time and date format.

Setting the time and date manually

Requirements:

- The vehicle does not have satellite reception.

Multimedia system:

→  ▶▶ Settings ▶▶ System
▶▶ Time and date

Setting the time

- ▶ Select **Set time**.
- ▶ Set a time.
- ▶ **Press OK (OK) to confirm.**

Setting the date

- ▶ Select **Set date**.
- ▶ Select a date.
- ▶ **Press OK (OK) to confirm.**

- ① On vehicles with satellite reception, the time and date settings are determined automatically based on the vehicle location and cannot be set manually.

Adjusting the time

- ▶ Select **Adjust time**.
- ▶ Set a value.
- ▶ **Press OK (OK) to confirm.**

- ① The function is only available in vehicles with satellite reception.

Switching voice amplification to the rear on/off (vehicles with long wheelbase)

Requirements:

- Your vehicle is equipped with the Burmester® 3D surround sound system or the Burmester® high-end 4D surround sound system.
- The ignition is switched on.
- Doors, side windows and the panorama sliding sunroof are closed.

- At least one seat belt is fastened on the rear bench seat.

Multimedia system:

→  ▶▶ Settings ▶▶ System ▶▶ Audio
▶▶ Further settings ▶▶ Voice amplification

Voice amplification supports communication between the driver/front passenger with passengers in the rear compartment. When voice amplification to rear is activated, the signals picked up by the microphone are amplified and played back over the speakers in the rear compartment, depending upon vehicle noise levels. An automatic adjustment occurs based on speaker volume and ambient noise in order to improve speech intelligibility and maintain the naturalness of speech.

- ▶ Switch voice amplification on or off.

Setting the intensity of the voice amplification

- ▶ Set the desired intensity on the control. Depending on the intensity set, the voice amplification to the rear is increased or reduced.

Data protection

Switching transmission of the vehicle position on/off

Requirements:

- A Mercedes me account is available.
 - At least one service is activated in the Mercedes me Portal which has access to the transmitted position data.
-  The function is country-dependent. For more information, consult a Mercedes-Benz service centre.

Multimedia system:

  **» Settings » System**

» Data protection

» Transmit vehicle position

 Activate or deactivate the function.

Bluetooth®

Information about Bluetooth®

Bluetooth® technology is a standard for short-range wireless data transfer up to approximately 10 m.

You can use Bluetooth® to connect your mobile phone to the multimedia system and use the following functions, for example:

- Hands-free system with access to the following options:
 - Contacts (→ page 382)
 - Call lists (→ page 386)
 - Text messages (→ page 387)
- Internet connection (→ page 414)

Bluetooth® is a registered trademark of Bluetooth Special Interest Group (SIG) Inc.

 Internet connection via Bluetooth® is not available in all countries.

Activating/deactivating Bluetooth®

Multimedia system:

  **» Settings » System**

» Internet and Bluetooth

 Switch **Bluetooth** on or off.

Near Field Communication (NFC)

Information on Near Field Communication (NFC)

NFC enables short-range wireless data transfer or connection of a mobile phone with the multimedia system.

Further information can be found at: <https://www.mercedes-benz-mobile.com/>

Switching near-field communication on/off

Multimedia system:

  **» Settings » System**

» Internet and Bluetooth

 Switch **NFC** on or off.

Wi-Fi

Information on Wi-Fi connections

You can use Wi-Fi to set up a connection to the Internet or to external network devices.

- ❶ The availability of the function is dependent on the country.

Generally, two types of Wi-Fi connection are available:

- **To use the multimedia system as a Wi-Fi hotspot** (→ page 326)

The multimedia system serves as Wi-Fi hotspot for mobile communication devices, such as smartphone or tablet PC, for example.

The data volume of the vehicle or an already connected tethering device is used for the data connection.

To use the vehicle data volume, the [Allow connected devices to use the Internet](#) option must be activated in the hotspot setting.

- ❶ Data volumes must be purchased via the Mercedes me Portal.

- ❶ The use of the vehicle data tariff by external devices is not available in all countries.

- **To use a mobile communication device as Wi-Fi hotspot (tethering)** (→ page 416)

An external Wi-Fi hotspot is accessed for the Internet connection of the multimedia system. The data tariff of the mobile communication device is used for the data connection.

Options for setting up a connection

The following options are available for setting up a connection:

- QR code
The connection is set up by scanning the QR code shown on the multimedia system.
- NFC
The connection is set up by placing the mobile communication device in the NFC interface of the vehicle.
- WPS PBC
The connection is set up by keypress on the device to be connected.

- WPS PIN
The connection is set up by entering an eight digit PIN.

Switching Wi-Fi on or off

Multimedia system:

→  » [Settings](#) » [System](#)
» [Internet and Bluetooth](#)

- ▶ Select [Wi-Fi](#).

The controller is to the right: Wi-Fi is switched on.

When Wi-Fi is switched on, you can connect the multimedia system with external hotspots or make it available as a hotspot for external devices.

When Wi-Fi is switched off, it is not possible to establish a hotspot connection.

- ❶ The availability of the function is dependent on the country.

Using the multimedia system as a Wi-Fi hotspot

Requirements:

- Wi-Fi is activated on the multimedia system and the device to be connected (→ page 325).
- The device to be connected supports at least one of the types of connection described.

The connection types shown depend on the device to be connected. The function must be supported by the multimedia system and by the device to be connected. The type of connection established must be selected on the multimedia system and on the device to be connected.

- ① Some functions may first need to be activated on the device being connected. More detailed information can be found in the manufacturer's operating instructions.
- ① The use of the vehicle data tariff by external devices is not available in all countries.

Multimedia system:

→  » Settings » System
» Internet and Bluetooth

- ▶ Select **Vehicle hotspot**.
- ▶ Select one of the following connection options.

Connecting using a QR code

Requirement: an app for scanning the QR code is installed on the device being connected.

Alternatively: the device being connected has an integrated QR code scanner (see manufacturer's operating instructions).

- ▶ Scan the QR code shown.
The Wi-Fi connection is established.

Connecting using NFC

- ▶ Select **NFC**.
- ▶ Activate NFC on the device being connected.
- ▶ Position the device being connected in the NFC interface of the vehicle.
The Wi-Fi connection is established.

Connecting using a button

- ▶ Select **Connect via WPS PBC**.

- ▶ Press the push button on the device to be connected (see the manufacturer's operating instructions).

- ▶ Select **Weiter** (Continue).
The Wi-Fi connection is established.

Connecting using WPS PIN entry

- ▶ Select **Connect via WPS PIN**.
- ▶ Enter the PIN that is shown on the external device's display on the multimedia system.
After correct entry of the PIN: The Wi-Fi connection is established.

Managing MBUX authorised devices

Requirements:

- The MBUX Remote Control app is installed on an external device (e.g. tablet or smart-phone).
- Wi-Fi is activated (→ page 325) and the multimedia system is configured as a Wi-Fi Hotspot (→ page 326).

Multimedia system:

-  ➤ Settings ➤ System
- MBUX Remote Control

Connecting and authorising a new device

- Select [Authorise a new device](#).
- Select [Add new device to the list](#).
- Enter the security key in the external device. The [Please start MBUX Remote Control on your device and follow the instructions](#). message appears.
- Select [Continue](#).
- The connection request from the device [Accept](#).
- Enter the PIN shown on the external device. The device is authorised.

Authorising a connected device

- Select [Authorise a new device](#).
- [Authorise device from list](#)
The [Please start MBUX Remote Control on your device and follow the instructions](#). message appears.

- Select [Continue](#).
- The connection request from the device [Accept](#).
- Enter the PIN shown on the external device. The device is authorised.

De-authorising the device

- Select [Deauthorise device](#).
- Select an authorised device from the list. A prompt will appear asking whether you really would like to de-authorise the selected device.
- Select [Yes](#).
The device is de-authorised.

Activating/deactivating the child safety lock for external devices

Multimedia system:

-  ➤ Settings ➤ System
- [Parental control](#)

Switching the child safety lock on/off (rear display)

- Select [Rear left](#) or [Rear right](#).
- Select [Lock](#).
The controller is positioned on the right: the lock is active. The rear display is locked and cannot be operated.
The controller is positioned on the left: the lock is released. The rear display is unlocked and can be operated.

or

- Select [Display off](#).
The controller is positioned to the right: the rear display switches off.
The controller is positioned to the left: the rear display switches on.

Activating/deactivating the child safety lock (MBUX-authorized devices)

- ▶ Select **MBUX authorised devices**.
A list of the devices authorised via MBUX Remote Control appears.
- ▶ Select **Lock**.
The controller is positioned on the right: the lock is active. The authorised device cannot be used to operate the MBUX multimedia system.
The controller is positioned on the left: the lock is released. The authorised device can be used to operate the MBUX multimedia system.

System language

Notes on the system language

This function allows you to determine the language for the menu displays and the navigation announcements. The selected language affects the characters available for entry. The navigation announcements are not available in all languages. If a language is not available, the navigation announcements will be in English.

Setting the language

Multimedia system:

-  ➤ Settings ➤ System
- Language

Setting the system language

- ▶ Select **System language**.
A list of the available system languages is shown.
- ▶ Select a language.
The system language is switched to the selected language.

Setting the distance unit

Multimedia system:

-  ➤ Settings ➤ System

- ⓘ This function is not available in all countries.
- ▶ Select **Units**.
- ▶ Select a unit for the distance.
- ▶ Switch **Additional speedometer** on for an additional display in the instrument cluster's multifunction display.

Software updates

Information on software updates

Software updates keep your vehicle and the related systems up-to-date and prevent security flaws.

The navigation maps are updated via updates from external storage media (e.g. USB stick).

Software updates are available online for vehicle components such as control units, convenience systems, locking and safety systems, driver assistance systems, suspension and drive systems as well as for the MBUX multimedia system. Software updates are available via the communication module or a Wi-Fi connection to an external hotspot.

Install available software updates regularly. Otherwise the security of your MBUX multimedia system and individual vehicle components cannot be ensured.

Information about installation

Software updates are installed automatically after they are downloaded. As soon as a software update is completed, a message appears in

the media display. It may be necessary to restart the MBUX multimedia system.

Some software updates require a safe vehicle status for the installation to be completed. They can only be carried out in a safely parked vehicle with the ignition switched off.

When the last installation step is reached, a message appears in the media display after the ignition is switched off. Follow the step-by-step instructions in the media display to complete the installation.

The vehicle cannot be used while these software updates are being installed. All entries in the vehicle fault memory are overwritten.

Further information about software updates can be found at <https://me.secure.mercedes-benz.com>.

Carrying out software updates

Requirements:

- **For software updates via the communication module:**

There is an Internet connection via the communication module (→ page 414).

Your vehicle is linked to a Mercedes me account (→ page 406).

- **For software updates via Wi-Fi:**

There is a connection to an external Wi-Fi hotspot (→ page 326).

Multimedia system:

 Settings ▶ System
 ▶ Software update

Starting the software update via the communication module

If the [Automatic online update](#) option is active, available software updates are downloaded and installed automatically. Activate the option in order to always keep your vehicle up-to-date and avoid security flaws.

If the option is deactivated, you will be informed of new software updates once. The updates are available for downloading for a limited period of time.

- ▶ Select an update from the list of available updates.

- ▶ Start the update.
The update is downloaded and installed automatically.

For software updates with a safe vehicle status: when the last installation step is reached, a message appears in the media display after the ignition is switched off. Follow the step-by-step instructions in the media display to complete the installation.

Starting a software update via Wi-Fi

Some software updates require an additional connection to a Wi-Fi hotspot. The connection to an external hotspot can be established when the software update is started.

- ▶ Select an update from the list of available updates.
- ▶ Start the update.
- ▶ Establish the connection to a Wi-Fi hotspot.
The update is downloaded and installed automatically.

For software updates with a safe vehicle status: when the last installation step is reached, a message appears in the media

display after the ignition is switched off. Follow the step-by-step instructions in the media display to complete the installation.

Starting a map update from an external storage medium

- ▶ Connect the storage medium with the vehicle via a media interface.
A message about an available map update appears in the media display.
- ▶ Select the message.
- ▶ Select **Update**.
The map update is started.

Error during installation of the software update

In rare cases, an error can occur during the installation. The multimedia system automatically attempts to restore the previous version. If restoration of the previous version is not possible, one of the following display messages appears on the Instrument Display:



Failure of the media display:

If the media display has failed, several systems such as the reversing camera, Parktronic or climate control are no longer available. Drive on carefully and consult a specialist workshop as soon as possible.

Failure of the Instrument Display:

If the Instrument Display has failed, you cannot recognise function restrictions applying to safety relevant systems. The operating safety of the vehicle may be impaired. Have the vehicle checked by a qualified specialist workshop immediately.

Further information about software updates can be found at <https://me.secure.mercedes-benz.com>.

Resetting the multimedia system (reset function)

Requirements:

- Some settings can only be reset when the vehicle is stationary.

Multimedia system:

➔  ➔ **Settings** ➔ **System** ➔ **Reset**

When resetting the system, personal data and settings are deleted, for example:

- Themes
- Connected devices
- Individual user profiles

- ▶ Select **Reset**.
A query appears asking if the system should really be reset.

▶ Select **Ja** (Yes).
The multimedia system is reset to the factory settings. The data used and saved by the driver assistance systems is deleted. The multimedia system is restarted after the system reset.

- ⓘ Due to data protection, as well as the function of individual driving systems and driving safety systems, it is a requirement to carry out a complete system reset before selling the vehicle or transferring it to a third party, or after use as a hire car.

Fit & Healthy

Setting ENERGIZING seat kinetics

Requirements:

- ⓘ These functions are available only for fully electric seats with a memory function.

Multimedia system:

➔  ▶▶ **Comfort** ▶▶ **Seat comfort**

- ▶ Select **Seat kinetics**.

ENERGIZING seat kinetics can support back health by changing the seat position during a journey. The muscles and joints are repeatedly stressed and relieved by means of minor movements of the cushion and backrest.

Starting seat kinetics

- ▶ Select **short distance**, **Medium dist.** or **long distance** for the desired seat.
▶ The program will run for the set duration.

Configuring seat kinetics

- ▶ Select  for the desired seat.
▶ Select **Backrest**, **Backrest and seat surface** or **Seat surface** for the desired seat.

Vehicles with a multicontour seat:

In addition to the seat backrest and seat cushion, the lumbar region can be activated for the function.

- ▶ Switch **Including lumbar** on or off.

ENERGIZING COMFORT

Overview of the ENERGIZING COMFORT programme

- ⓘ Please note that the available programmes and the associated functions depend on your vehicle equipment. Depending on your equipment, fewer functions may be available.

Programme overview

- **Refresh:** Can have a refreshing effect with short, cool puffs of air. The seat is ventilated, the vehicle interior is illuminated with cool colours and the programme is completed with appropriate sound. In addition, the vibration massage in the cushions can loosen the muscles.
- **Warmth:** Can increase the comfort level of the vehicle occupants. Seat, surface and steering wheel heating, in combination with the heated neck cushion in the rear passenger compartment, provide comforting warmth. The programme is completed with unobtrusive sound and warm colours.

- **Vitality:** Can counteract diminishing attentiveness in monotonous driving situations. The activating stimulation of the vehicle occupants is carried out with invigorating sound, activating light and a vitalising massage.
 - **Pleasure:** Can promote a positive mood in the vehicle occupants as well as mental regeneration. This results from the activation of a massage programme, friendly sound and illumination with suitable colours. Combination with the 4D sound system can boost the regenerating effect.
 - **Comfort:** Can help relax the vehicle occupants. Relaxation is achieved using a hot stone massage, friendly light and relaxing sound.
 - **Power Nap:** The programme consists of three phases.
 - Falling asleep phase: relaxing music is played and the vehicle is darkened.
 - Sleeping phase: the active functions are deactivated or restricted as much as possible.
- Waking phase: slightly stimulating music is played, and the air is purified with ionisation and scented.
- **Training:** Can counteract the onset of muscle tension, limbs falling asleep or stress with targeted relaxation or stimulation exercises. The exercises are demonstrated in short videos.

The training consists of audio content and a brief animation. The audio content is conceived so that it can also be played back when you are driving. Animations are only shown when the vehicle is stationary. Always observe the traffic conditions if you are training when driving.
 - **Tips:** The system gives auditory tips for possible exercises or measures for improving the comfort level of the vehicle occupants. By selecting the desired area of the body you can receive targeted tips for the comfort level of this area.

If a programme has been started for one seat, this can also be adopted for other seats at the same time.

Starting the ENERGIZING COMFORT programme

⚠ WARNING Increased risk of accident when using the ENERGIZING COMFORT programmes [Tips](#) and [Training](#)

The ENERGIZING COMFORT programmes [Tips](#) and [Training](#) can distract you when driving.

- ▶ Only carry out exercises when the traffic conditions allow.
- ▶ When listening to the tips, make sure that you are always aware of the traffic conditions around you.

Requirements:

- The ignition is switched on.
- To start [Power Nap](#) for the driver's seat:
- The engine is switched off.
 - The doors are closed.
 - The vehicle is secured against rolling away.

- The charging state of the high-voltage battery is sufficient for the use of the auxiliary climate control.

Multimedia system:



Starting the programme

- ▶ Select a programme.
- ▶ Select **Start** for the desired seat.

i If, during an active programme, a function requirement is no longer met, a corresponding message appears. The active programme is cancelled.

Configuring the programme

- ▶ Select a programme.
- ▶ Select **Settings**.
- ▶ Switch the functions included in the programme on or off.

Setting the running time

- ▶ Select a programme.

- ▶ Select **Settings**.
- ▶ Select the desired duration.

Starting a Power Nap

- ▶ Select **Power Nap**.
- ▶ Select **Start**.

When the vehicle is stationary, the following actions are carried out when Power Nap is started:

- The roller sunblinds are extended.
- The doors are locked.
- The windows and sliding sunroof are closed.
- The seats are moved into the fully reclined position.
- The parking brake is applied if necessary.

i The programme is also available for the rear seats while the vehicle is in motion. The above-mentioned functions may only have limited availability.



Starting the training programme

- ▶ Select **Training**.

- ▶ Select a programme.
- ▶ **To activate fragrancing for training:** select **Air freshener**.

i The animations demonstrating the exercises are faded out when the vehicle is in motion and you only hear the instructions.

Starting tips

- ▶ Select **Tips**.
- ▶ Select  a region of the body.
- ▶ Select  to stop playback of the tip.

ENERGIZING COACH

Function of the ENERGIZING COACH

Requirements:

- The **ENERGIZING COACH** service is activated in the Mercedes me Portal or the Mercedes me app.

With ENERGIZING COACH you can evaluate the driving and driver situation. Depending on the situation, it offers recommendations for the start

of an appropriate ENERGIZING COMFORT programme.

The following programs could be suggested:

- **Vitality**
As an activating programme in monotonous driving situations or for long journey times, for example.
Information on the vitality program see (→ page 331).
- **Pleasure**
As a balancing program in demanding driving situations.
Information on the pleasure program see (→ page 331).
- **Refresh**
As a refreshing programme when temperatures rise.
Information on the Refresh programme; see (→ page 331).
- **Warmth**
As a warming programme when temperatures drop.

Information on the Warmth programme; see (→ page 331).

By connecting a GARMIN fitness tracker, for example the GARMIN vívoactive® 3, additional information can be entered into the evaluation for the recommendation of an ENERGIZING COMFORT programme. The additional information includes the stress level, that is calculated by the fitness tracker. The stress level is based primarily on the pulse rate.

Requirements for the integration of additional information via a GARMIN fitness tracker:

- Your fitness tracker is connected with your GARMIN account.
- Your GARMIN account is connected with your Mercedes me account.

If you wear your GARMIN fitness tracker at night also, the sleep data is included in the evaluation of the ENERGIZING COACH.

Requirement for the integration of the sleep data:

- The GARMIN fitness tracker is synchronised with the GARMIN account before the beginning of the journey.
- ⓘ If ATTENTION ASSIST determines an excessive lack of attention, ENERGIZING COACH makes no further suggestions. Further information about ATTENTION ASSIST (→ page 255).

Calling up the ENERGIZING COACH display
Multimedia system:

 **Comfort**

- ▶ Select **ENERGIZING COACH**.
Your current pulse as well as an evaluation of your pulse for the last 30 minutes driving time are shown.
A corresponding error message is shown if there is no mobile phone connected or no pulse can be sent to the system for an extended period.

- ❗ Only pulse values in the range of 30-150 bpm are shown on the central display. The pulse values have no medical validity but are only informative in nature and are therefore also not required to be accurate.

- ▶ In the event of an error message make sure that the following requirements are fulfilled:
 - The fitness tracker is connected with your GARMIN account.
 - Your GARMIN account is connected with your Mercedes me account on your mobile phone.
 - The mobile phone is connected to the multimedia system (→ page 373).

Navigation and traffic

Switching navigation on

Multimedia system:

→ 🏠 ▶▶ Navigation

- ▶ Alternatively, activate the MBUX Voice Assistant (→ page 286).

- ▶ Switch to navigation.
The map appears.

Showing/hiding the navigation menu

→ 🏠 ▶▶ Navigation

The navigation menu is shown if route guidance is not active.

The navigation menu is hidden if route guidance is active.

- ▶ **To show:** tap on the touchscreen.
- ▶ **To hide:** the navigation menu is hidden automatically.

Navigation overview

Digital map

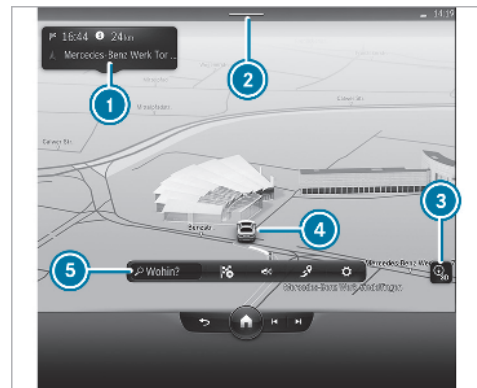

- ① Display of the traffic reports provider
- ② Status line with information
- ③ Shows parking options in the vicinity of the current vehicle position
- ④ Sets the map orientation

- 5 Current vehicle position
- 6 Navigation menu

Navigation menu



- 1 Enters a POI or address and additional destination entries
- 2 Interrupts route guidance (if route guidance is active)
- 3 Repeats a navigation announcement and switch navigation announcements on or off
- 4 Calls up a menu
 - Showing the route overview, entering intermediate destinations, selecting alternative routes

- Entering intermediate destinations
- Displaying traffic incidents and local area reports

- 5 Makes settings for **View**, **Messages** and **Route**
- i The options are not available in all countries.
- i You can enter a destination as a 3 word address from what3words (→ page 339). This option is not available in all countries.

Destination entry

Notes on destination entry

⚠ WARNING Risk of distraction from operating integrated communication equipment while the vehicle is in motion

If you operate communication equipment integrated in the vehicle when driving, you will be distracted from the traffic situation. This could also cause you to lose control of the vehicle.

- ▶ Only operate this equipment when the traffic situation permits.
- ▶ If you cannot be sure of this, stop the vehicle whilst paying attention to road and traffic conditions and operate the equipment with the vehicle stationary.

You must observe the legal requirements for the country in which you are currently driving when operating the multimedia system.

Entering a POI or address Requirements:

Observe the notes on destination entry (→ page 336).

- **For the online search:** Mercedes me connect is available.
- You have set up a user account in the Mercedes me Portal.
- The vehicle has been activated for use of Mercedes me connect and you have accepted the terms and conditions for the service. Further information can be found at: <http://www.mercedes.me>

- The service has been activated.

Multimedia system:

Navigation ►► Where to?

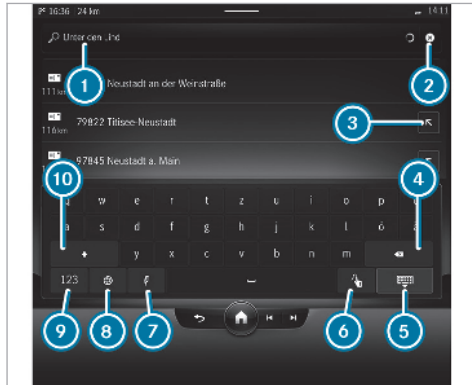

Example: entering a POI or address

- 1 Input line with current entry
- 2 Deletes an entry

- 3 Puts the search result into the input line and continues entry
- 4 Deletes the last character entered
- 5 Accepts an entry
- 6 Switches to handwriting recognition (→ page 308)
- 7 Switches to MBUX Voice Assistant (→ page 287)
- 8 Sets the written language
- 9 Switches to digits
- 10 Switches to upper-case or lower-case letters

▶ Enter a destination. The entries can be made in any order.
The search results are displayed in a list.

- i Further information on character input (→ page 308).
- i Online search results are provided by online map services.
This online function is not available in all countries.

Example of quick address entry:

- If searching for "Königstraße" in "Stuttgart", for example, enter STUT and KÖN.

- If searching for a POI in London, for example, enter THE SHARD.

The following entries can be made, for example in 1:

- Town, street, house number or street, town
- Postcode
- POI name or POI category, e.g. **Filling station**
- Town, POI name
- Phone number or contact name (if available)
- Geo-coordinates (→ page 339)
- 3 word address (→ page 339)

▶ Select a search result.
The route is calculated.

or

- ▶ Confirm the entry with **OK**.
- ▶ Select the destination in the list.
The route is calculated.

Selecting a destination suggestion
Requirements:

- The [Allow destination suggestions](#) option is switched on (→ page 297).
- The multimedia system has gathered sufficient data in order to show destination suggestions.

Multimedia system:

→  » [Navigation](#) »  [Where to?](#)

- ▶ Select a destination suggestion.
The route is calculated.

- ⓘ Managing destination suggestions (→ page 355).

Selecting previous destinations

Requirements:

- Previous destinations (destinations or routes) are saved.

Multimedia system:

→  » [Navigation](#) »  [Where to?](#)

▶  » [Previous destinations](#)

- ▶ Select the destination.
The route is calculated.

- ⓘ You can save a destination as a favourite (→ page 355).

Selecting a POI

Requirements:

- **For use of personal POIs:** a USB device is connected with the multimedia system.
- Personal POIs with the GPS Exchange format (.gpx) have been saved in the "PersonalPOI" folder on the USB device.

Multimedia system:

→  » [Navigation](#) »  [Where to?](#)

- ▶ Select a POI symbol, for example .

or

- ▶ Enter a POI name or a POI category in the entry line.
The search results are displayed, sorted by distance in ascending order. For POIs, online content, e.g. rating and prices, can be shown.
- ▶ Select the POI.
The route is calculated.









Setting a search filter

- ▶ When the search results are displayed, select [Filter](#).
- ▶ Select the search position for example [In the vicinity](#), or the distance from the POI (remaining travelling time).
- ▶ Select [Search results](#).

Selecting from all categories or personal POIs

- ▶ Select .
 - ▶ Select a category.
- or
- ▶ Select [All categories](#) or [Personal POIs](#).
 - ▶ Select the category.
 - ▶ If there are intermediate destinations and [Near destination](#) has been selected, select the destination for which a search is to be made.
 - ▶ Select the POI.
The route is calculated.

Configuring categories for quick-access

- ▶ Select .
 - ▶ Select  or  for a category.
 -  adds the category.
 -  removes the category.
 - or
 - ▶ Select [All categories](#).
 - ▶ Select the category.
 - ▶ Select  or .
-  If all available quick-access positions are full, select the category to be replaced.

Selecting a contact for destination entry Requirements:

- A mobile phone is connected to the multimedia system (→ page 373).
- The contacts from the mobile phone have been downloaded (→ page 383).
- The contact has a navigable address.
- The contact data matches the map data in the digital map.

Multimedia system:

 ▶▶ [Navigation](#) ▶▶  [Where to?](#)
▶▶  ▶▶ [Contacts](#)

- ▶ Select a suggestion or a contact.

or

- ▶ Enter a name or telephone number into the search field.
- ▶ Select the contact.
- ▶ Select the address.

Entering geo-coordinates

Multimedia system:

 ▶▶ [Navigation](#) ▶▶  [Where to?](#)

- ▶ Enter the geocoordinates as latitude and longitude.
- ▶ Confirm the entry with .
- ▶ Calculate the route (→ page 341).

Entering the destination as a 3 word address Requirements:

- An active Internet connection is shown in the status line of the central display with a double arrow symbol.

Multimedia system:

 ▶▶ [Navigation](#) ▶▶  [Where to?](#)

- ▶ Enter the destination as a 3 word address from what3words. Separate each of the words with a full stop (example). The search results are displayed.
 - ▶ Select the destination in the list. The destination address is shown.
-  Searching for a destination using 3 word addresses is not possible in all countries and in all languages.

Alternatively, use the following entry options:

- Entry in the global search (→ page 305)
 - Voice navigation (→ page 287)
- Example: during a telephone call you are given a 3 word address. After activation of the MBUX Voice Assistant, say the "Navigate to what three words" voice command and then say the 3 word address **without** separating full stops.



3 word addresses from what3words are an alternative addressing system for multilingual georeferencing of global locations with a resolution of three metres. Using this grid, locations on the Earth's surface are included which do not have a building address such as a street and house number, for example.

The Brandenburg Gate has this language dependent 3 word address:

- German: tapfer.gebäude.verliehen
- English: that.lands.winning
- French: postaux.bobineur.ombrant

i 3 word addresses are unique, easy to remember and suffice for most routine applications.

You can convert addresses to 3 word addresses and back again:

- At the website <https://what3words.com>
- In the what3words apps

Selecting a destination on the map

Multimedia system:

Navigation

- ▶ Move the map (→ page 361).
- ▶ Press and hold the touchscreen. Available destinations are displayed.
- ▶ Select the destination in the list. The route is calculated.

i You can use further options, for example select **Near POIs** or the destination **Share**.

Selecting a destination from favourites

Requirements:

- Destinations are saved as favourites.

Save a previous destination or a destination suggestion as a favourite (→ page 355).

Multimedia system:

Navigation **Where to?**
Favourites

- ▶ Select a favourite. The route can be calculated.

Editing favourites

- ▶ **To save addresses for home and work:** select **Home** or **Work**.

- ▶ Confirm the prompt with **Yes**.
- ▶ Enter the address (→ page 336).

- ▶ **To save a favourite:** select **Add favourite**.
- ▶ Enter the address (→ page 336).

i If all the favourites are occupied, select the favourite to be overwritten. Follow the instructions provided.

- ▶ **To delete the favourite:** select the pen symbol.
- ▶ Delete the selected favourites or all favourites.

Selecting received destinations

Requirements:

- There is an Internet connection for receiving external destinations.
- A destination has been sent to the vehicle.
- Destinations have been shared from another seat in the vehicle.

Multimedia system:

  **Navigation**  **Where to?**
Received destinations

The vehicle can receive destinations from services or apps or a destination can be shared from another seat. You will be informed when a destination is received.

- ▶ Select a destination.
The route is calculated.
- ⓘ You can save a received destination in the favourites (→ page 355).
- ▶ **To delete received destinations:** select the pen symbol.
- ▶ Delete the selected destination or all destinations.

Route



Calculates a route

After selection of a destination the route is calculated. The map shows the route. Depending on the selected destination, various options are available to you in the displayed menu.

- ▶ **To share a destination:** select **Share**.
The option allows a destination to be sent to a rear seat or the displayed QR code to be scanned.
- ▶ **To call the destination:** if a telephone number is available, select **Call**.
- ▶ **To call up an internet address:** if an internet address is available, select **Website**.

Adding an intermediate destination to the existing route or starting a new route guidance

If a route already exists, an additional destination is set as an intermediate destination or as a new destination.

- ▶ Select  **Add**.
The selected destination address is set as the next intermediate destination. Route guidance begins.
If there are already four intermediate destinations, confirm the prompt with **Yes**.
 - ▶ In the route overview, select an intermediate destination that is to be written over with the new intermediate destination.
- or
- ▶ Select .
The selected destination address is set as a new destination. Route guidance begins.

Selecting parking spaces nearby

- ▶ Select **Parking nearby**.

Starting route guidance

- ▶ Select .

Saving a destination as a favourite

- ▶ Select  **Favourites**.
- ▶ Select an option.

Searching for POIs in the vicinity of the destination shown

- ▶ Select  **Near POIs**.
- ▶ Search using categories, enter a search entry or search for a personal POI (→ page 338).

Selecting a route type

Multimedia system:

  ▶▶ **Navigation** ▶▶  ▶▶ **Route**

The route is calculated as a fast route with a short journey time. The trailer mode can be used if a trailer has been coupled with the vehicle. You can select online routes.

- ▶ **To use online routes:** switch on **Online route**.
- ▶ **To use trailer mode:** select **Trailer**.
A prompt is shown in the multimedia system. Confirm the prompt. The route is optimised for trailer operation with a maximum speed of 80 km/h.

Taking traffic information into account

- ▶ Select **Dynamic route guidance** .
- ▶ Select one of the options.

Explanation of the options:

- **Automatic**
Traffic messages via Live Traffic Information or FM RDS-TMC are taken into account (→ page 355).
Live Traffic Information and FM RDS-TMC are not available in all countries.
- **After asking**
A prompt appears when a new route is detected with a shorter journey time based on traffic reports. You can continue to use the current route or use the dynamic route instead (→ page 342).
- **Off**
No traffic reports are taken into account for the route.

Calculating alternative routes

Multimedia system:

  ▶▶ **Navigation** ▶▶  ▶▶ **Route**

- ▶ Select **Route type**.

- ▶ Activate **Alternative Routen berechnen** (Calculate alternative routes).
Alternative routes are calculated for every route.

Accepting a detour recommendation after a prompt

Requirements:

- **After asking** is switched on (→ page 342) in the **DYNAMIC ROUTE GUIDANCE** menu.
- Route guidance is active.
- There are traffic reports for the current route.

If a new route with a shorter driving time is determined, the current and new routes will be shown.

The notification is shown in another application. Confirm the notification.

- ▶ **To accept the new route:** select **Accept recommended detour**.
- ▶ **To maintain the current route:** select **Keep to current route**.

Selecting route options

Multimedia system:

→  >> Navigation >>  >> Route

Avoiding or using route sections, e.g. motorways or ferries

- ▶ Select **Avoid options**.
 - ▶ Activate or deactivate the avoid option.
Avoid: the option is activated. The route avoids motorways, for example.
Use: the option is deactivated. The route takes motorways into consideration, for example.
- ⓘ The selected route options cannot always be taken into account. Therefore, a route may include a ferry, for instance, even though the **Ferries** avoid option is enabled. A message then appears and you will hear a corresponding message.

Avoiding or using toll roads

The use of toll roads requires a usage fee (toll).

- ▶ Select **Toll roads**.

- ▶ Switch **Avoid all** on or off.
 If the option is activated, the route avoids toll roads.
 If the option is deactivated, the route takes toll roads into account.

or

- ▶ Select an option for **Payment by cash or card** or **Electronic billing**.
Avoid: the route avoids toll roads with the selected method of payment.
Use: the route takes into account roads that require a toll corresponding with the payment type selected.

Avoiding or using roads requiring a special toll sticker

A vignette allows for the use of a route network for a limited time period.

- ▶ Select **Avoid options**.
- ▶ Select **Vignette roads**.
- ▶ Switch **Avoid all** on or off.

or

- ▶ Switch a country off or on in the list.
Avoid: the option is activated. The route avoids roads requiring a special toll sticker in the selected countries.

Use: the option is deactivated. The route takes into account roads in the selected country which require you to pay a time-based fee (vignette).

- ⓘ These route options are not available in every country.

Avoiding areas

- ▶ Select **Avoid options**.
- ▶ Select **Avoid areas** (→ page 363).

Selecting notifications for the route Requirements:

- **For an audible indication when approaching a personal POI:** the USB device contains personal POIs.
- The USB device is connected with the multimedia system.
- The category in which the personal POI belongs is activated.

Multimedia system:



Switching announcements of driving recommendations on/off

- ▶ Select [Driving recommendation](#).
- ▶ Select an option.

The following options are available:

- [Acoustic signal only](#)

In place of the spoken driving instruction you hear a gong. The gong signals an upcoming driving manoeuvre and also sounds during the driving manoeuvre.

- [Reduced](#)

If a driving instruction is available, you hear a brief announcement, e.g. "turn right".

- [Detailed](#)

If a driving instruction is available and there is a complex driving situation, you hear a complete announcement, e.g. "In 200 m turn right and continue to follow the major road".

- ▶ Activate [Announce street names](#).
The name of the street into which the vehicle should turn is announced.
This option is not available in all countries and languages.

Switching traffic announcements on/off

- ▶ Select [Alerts](#).
- ▶ Under [Traffic](#) switch the options on or off.

The following options are available:

- [Traffic incidents](#)

Traffic incidents are announced, e.g. roadworks and road blocks.

This option is not available in all countries and languages.

- [Announce traffic warnings](#)

Traffic warnings are announced, e.g. before the end of traffic jams that pose a risk (if available).

This option is not available in all countries and languages.

Audible indication when approaching a personal POI

- ▶ Select [Alerts](#).
- ▶ Select [Personal POIs](#).
- ▶ Activate a category.
When approaching a personal POI in the selected category an audible indication will be issued.

Displaying a route overview Requirements:

- A destination is entered.

Multimedia system:

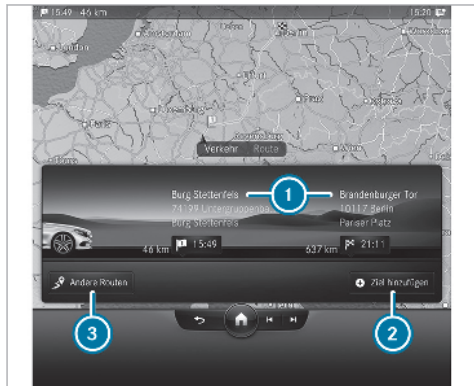

Example: route overview

- ① Destination information
- ② Plans routes(→ page 345)
- ③ Selects an alternative route(→ page 346)

When route guidance is active, the destination and entered intermediate destinations are shown.

The following destination information ① is displayed:

- Name, destination address
- Remaining driving distance
- Symbol for intermediate destination, destination
- Time of arrival
- Phone number (if available)
- Web address (if available)

The route can include up to four intermediate destinations.

If no route has been selected, the three most probable navigation destinations for destination input are suggested.

- ▶ Select a destination suggestion.
The route is calculated.

Planning routes

Multimedia system:



- ▶ Select ⊕ **Add destination** .
- ▶ Enter a destination (→ page 336).
After entering the destination and new calculation of the route, the route overview is shown again. The route contains a new intermediate destination.
- ① If there are already four intermediate destinations, delete an intermediate destination (→ page 345).

Editing a route with intermediate destinations

Requirements:

- The destination and at least one intermediate destination have been entered.

Multimedia system:



- ▶ Press and hold on the chequered flag.
A menu is shown.

- ▶ **To change the order of the destinations:** select [Move](#).
 is highlighted.
- ▶ Move the destination with or .
- ▶ Tap on .
- ▶ **To delete a destination:** select [Delete](#).

Displaying the route list

Multimedia system:

→ → [Navigation](#)



Example: route list

- ① Route section with turning arrow, distance to change of direction and road number
- ② Current vehicle position

The route sections are displayed in the navigation window. The route list is updated during the journey.

- ▶ **To display route sections:** open up the route list with and close it with .
- ▶ Swipe up or down in the navigation window.

Calculating alternative routes

Multimedia system:

→ → [Navigation](#) → → [Route](#)

- ▶ Select [Route type](#).
- ▶ Activate [Alternative Routen berechnen](#) (Calculate alternative routes).
Alternative routes are calculated for every route.

Selects an alternative route

Requirements:

- A route has already been created.
- The [Alternative Routen berechnen](#) (Calculate alternative routes) option is switched on .

Multimedia system:



Example: alternative routes

- ① Original route
- ② Alternative routes

The following route information is displayed:

- Time of arrival
- Driving time
- Distance to the destination
- Driving time saved or lost compared with the original route
- Avoid options based on the set route options

▶ When the alternative routes have been calculated, display the route in the navigation window by swiping to the right or left.

▶ **To avoid or use route options:** select **Filter**.

▶ Switch the route options on or off (→ page 343).

▶ Confirm the settings.

▶ **To start route guidance to the alternative route:** select **Start**.

Activating a commuter route

Requirements:

- You have created a profile (→ page 296).
- The **Allow destination suggestions** option is switched on (→ page 297).

- The **Activate commuter route** option is switched on.
- The multimedia system has gathered sufficient data in order to show destination suggestions.
- Routes have been learned for these destination suggestions.

ⓘ This commuter route is not available in all countries.

Multimedia system:



▶ Select **Route type**.

▶ Activate **Activate commuter route**.
The navigation system automatically detects that the vehicle is on a commuter route. It automatically starts a route guidance without spoken driving instructions.

For the daily commuter route, traffic incidents on the route are also reported when driving without active route guidance.

Switching the automatic filling station search on/off

Multimedia system:

 **Settings** **Vehicle**

- ▶ Select **Energy functions**.
- ▶ Switch **Automatic filling station search** on or off.
When the fuel reserve level is reached, and the option is switched on, a message appears to start searching for filling stations.

Starting an automatic filling station search Requirements:

- The automatic filling station search is activated (→ page 348).



Driving situation

The fuel level in the fuel tank reaches the reserve fuel level.

The following notification is shown in the central display **Reserve fuel Tap here to search for filling stations**.

- ▶ Confirm the notification.
The automatic filling station search begins.
The available filling stations along the route

or in the vicinity of the vehicle's current position are displayed.

- ▶ Select a filling station.
- ▶ Calculate the route with filling station as an  intermediate destination or as a  destination (→ page 341).
- ▶ **If there are already four intermediate destinations:** select **Yes** in the prompt.
The filling station is entered in the route overview. Intermediate destination 4 is deleted. Route guidance begins.



Starting the automatic service station search

Requirements:

- ATTENTION ASSIST and the **Suggest rest area** function are activated (→ page 255).
- There are service stations along the route section ahead.

Driving situation

The following notification is shown in the central display **ATTENTION ASSIST Tap here to search for rest areas**.

- ▶ Confirm the notification.
The service station search starts. The available service stations along the route or in the vicinity of the vehicle's current position are displayed.
- ▶ Select a service station.
- ▶ Calculate the route with service station as an  intermediate destination or as a  destination (→ page 341).
The service station is set as the destination or the next intermediate destination.
- ▶ **If there are already four intermediate destinations:** select **Ja** (Yes) in the prompt.
The service station is entered in the route overview. Intermediate destination 4 is deleted. Route guidance begins.

Showing a stored route on the map Requirements:

- A USB device with stored routes is connected with the multimedia system (→ page 425).
- The route is stored in the "Routes" folder with the GPS Exchange format (.gpx).

Multimedia system:

  **Navigation**  **Where to?**
 **Stored routes**

- ▶ Select a route.
- ▶ Move the map (→ page 361).

Starting a saved route Requirements:

- A USB device with stored routes is connected with the multimedia system (→ page 425).
- The route is stored in the "Routes" folder with the GPS Exchange format (.gpx).

Multimedia system:

  **Navigation**  **Where to?**
 **Stored routes**

- ▶ Select a route.
- ▶ Select **Start route guidance from beginning** or **Start route guid. from curr. location**. Route guidance starts.

Recording a route Requirements:

- A USB device is connected with the multimedia system (→ page 425).

Multimedia system:

  **Navigation**  **Where to?**
 **Stored routes**

- ▶ **To start recording:** select **Start recording**. A red recording symbol is shown. The route is stored on the USB device.
- ▶ **To stop recording:** select **End recording**.

Saving a recorded route Requirements:

- A USB device is connected with the multimedia system (→ page 425).

Multimedia system:



  **Navigation**  **Where to?**
 **Stored routes**

- ▶ Select a route.
- ▶ Select  **Favourites**.
- ▶ Select a storage option. The route is stored in the favourites.

Editing a stored route Requirements:

- A USB device with stored routes is connected with the multimedia system (→ page 425).

Multimedia system:

  **Navigation**  **Where to?**
 **Stored routes**

- ▶ **To rename a route:** press on a route until a menu is shown.
 - ▶ Select **Change name**.
 - ▶ Enter the name.
 - ▶ Select **OK**.
- or
- ▶ When the name has been changed, press the  button.
 - ▶ Select **Yes**.
 - ▶ **To delete a route:** select **Delete**.
 - ▶ Select **Yes**.

Route guidance

Notes on route guidance

⚠ WARNING Risk of distraction from operating integrated communication equipment while the vehicle is in motion

If you operate communication equipment integrated in the vehicle when driving, you will be distracted from the traffic situation. This could also cause you to lose control of the vehicle.

- ▶ Only operate this equipment when the traffic situation permits.
- ▶ If you cannot be sure of this, stop the vehicle whilst paying attention to road and traffic conditions and operate the equipment with the vehicle stationary.

You must observe the legal requirements for the country in which you are currently driving when operating the multimedia system.

Route guidance begins once a route has been calculated. The road and traffic rules and regulations always have priority over multimedia sys-

tem driving instructions. Driving instructions are navigation announcements, route guidance displays and lane recommendations.

If you do not follow the driving instructions or if you leave the calculated route, a new route is calculated automatically.

If, for example, the route is diverted or the direction of a one-way road has been reversed, driving instructions may deviate from the actual traffic situation.

For this reason, you must always observe road and traffic rules and regulations during your journey as well as the prevailing traffic conditions.

The route can differ from the ideal route, for example in the event of roadworks or incomplete digital map data.

Notes on satellite reception

The correct function of the navigation system depends amongst other things on reception of the satellite system used. In certain situations satellite reception can be impaired, malfunction or even not possible, e.g. in tunnels or in multi-storey car parks.

Changing direction overview

Changes of direction are shown in the following displays:

- Detailed image of the junction
The display appears when you drive into a junction.
- 3D image
The display appears when driving on junction-free, multi-lane roads, for example on motorway exits and motorway interchanges.



Example: detailed image of the crossing with upcoming changes of direction

- ① Current distance to the change of direction
- ② Manoeuvre point
- ③ Current vehicle position



Example: 3D image of the upcoming change of direction

- ① Manoeuvre point
- ② Driving manoeuvre
- ③ Current distance to the change of direction
- ④ Current vehicle position

There are three phases when changing direction:

- Preparation phase

If there is enough time between the changes of direction, the multimedia system prepares you for the upcoming change of direction. A navigation announcement is issued, e.g. "Prepare to turn right".

The map appears in full-screen mode.

The status line shows: the direction information or the name of the road which is to be turned into and the distance to the change of direction.

- Announcement phase

The multimedia system announces the upcoming change of direction, e.g. by announcing "Turn right in 100 m".

The display is split into two parts. The map is displayed on the left; on the right, there is a detailed image of the junction or a 3D image of the upcoming change of direction.

- Change-of-direction phase

The multimedia system announces the imminent change of direction, e.g. by announcing "Now turn right".

The display is split into two parts.

3-D image of the upcoming change of direction: The change of direction takes place when the distance to manoeuvre point ① is shown with 0 m and the symbol for vehicle position ④ has reached manoeuvre point ①.

①.

- ① Changes of direction are also shown in the driver's display.

Lane recommendations overview



Example: lane recommendations

- ① Lane not recommended (grey arrow)
- ② Possible lane (white arrow)
- ③ Recommended lane (white arrow, blue background)

This display appears for multi-lane roads.

Lane recommendations can be shown in the navigation window if the digital map contains the relevant data.

Explanation of the displayed lanes:

- Recommended lane
In this lane, you will be able to complete both the next change of direction and the one after that.
- Possible lane
In this lane, you will only be able to complete the next change of direction.
- Non-recommended lane
In this lane, you will not be able to complete the next change of direction without changing lane.

During the change of direction, new lanes may be added. Bus lanes are also shown.

- ① Lane recommendations can also be displayed in the driver's display and in the Head-up Display.

Using motorway information

When driving on the motorway, upcoming motorway facilities and available service facilities are shown in the navigation window. These include car parks, service stations and motorway exits, for example.

The entries are sorted according to increasing distance from the current vehicle position.

- ▶ Select an entry.
 - ▶ If several service facilities are available, select a service facility from the list. The destination address and the map position are shown.
 - ▶ Calculate the route (→ page 341).
- or
- ▶ Search for a POI in the vicinity.
- or
- ▶ Use other functions, e.g. save the destination address of the service facility.

Destination reached





Once the destination is reached, you will see the  chequered flag. Route guidance will now be complete. The navigation menu is shown.

When an intermediate destination has been reached, you will see the intermediate destination flag with the number of your  intermediate destination. Route guidance is continued.

Switching navigation announcements on/off



- ▶ **To switch off:** press button  on the steering wheel or on the MBUX multimedia system during a navigation announcement (→ page 306). The **Spoken driving recommendations have been deactivated.** message appears.

or

- ▶ Show the navigation menu (→ page 335).
- ▶ Select . The symbol changes to .
- ▶ **To activate:** select . The current navigation announcement is played. The symbol changes to .

- ⓘ This function can be added and called up from the favourites within the navigation category.

Switching navigation announcements on or off during a phone call

- ▶ Press the  button on the steering wheel.
- or
- ▶ Tap on  in the central display.
 - ▶ Select **Settings**.
 - ▶ Select **System**.
 - ▶ Select **Audio**.
 - ▶ Select **Navigation and traffic announcements**.
 - ▶ Switch **Driving recomm. during call** on or off. When the option is switched on, the display button is activated.
 - ▶ **To leave the menu:** select .

Adjusting the volume of navigation announcements

Multimedia system:

- ▶  ▶ **Settings** ▶ **System** ▶ **Audio**
- ▶ **Navigation and traffic announcements**
- ▶ Select **Driving recommendation vol..**
- ▶ Set the volume.

▶ **To leave the menu:** select .

Route guidance is active

▶ Set the volume during a navigation announcement on the steering wheel or under the touchscreen (→ page 307).

Switching audio fadeout on or off during navigation announcements

▶ Press the  button on the steering wheel.
or

▶ Tap on  in the central display.

▶ Select [Settings](#).

▶ Select [System](#).

▶ Select [Audio](#).

▶ Switch [Audio fadeout](#) on or off.

▶ **To leave the menu:** select .

Repeating navigation announcements

Requirements:

- A route has already been created.
- Route guidance is active.

Multimedia system:

↳ [Navigation](#)

▶ Select .

▶ Select .

The current navigation announcement is repeated.

ⓘ This function can be added and called up from the favourites within the navigation category.

Cancelling route guidance

Requirements:

- A route has already been created.
- Route guidance is active.

▶ Show the navigation menu (→ page 335).

▶ Select  in the navigation menu (→ page 335).

Overview of off-road status during route guidance

Due to roadworks, for example, there may be differences between the data on the digital map and the actual course of the road. In such cases, the multimedia system will temporarily be

unable to locate the vehicle's current position on the digital map. The vehicle is off-road. Route guidance may be restricted.

When the vehicle is back on a road known to the multimedia system, route guidance continues as normal.

Destination

Saving or sharing the current vehicle position

Multimedia system:

↳  [Navigation](#)

▶ When the map is shown, tap on the  current vehicle position.

▶ Select [Store position](#).

The current vehicle position is saved to the "Last destinations" memory.

or

▶ Select [Share current position](#).

▶ Send the current vehicle position using available apps.

Editing the previous destinations

Multimedia system:

-  ➤ Navigation
- Previous destinations

Saving the last destination as a favourite

- Press and hold on one of the previous destinations. A menu appears.
- **To save as a favourite:** select [Save as favourite](#) .
- **To save as "Home" address:** select [Save as "Home"](#) .
- **To save as "Work" address:** select [Save as "Work"](#) .

Deleting a previous destination

- Select .
- Select the pen symbol.
- Select [Delete](#) or [Delete all](#).
- Select [Yes](#).

Managing destination suggestions

Requirements:

- The [Allow destination suggestions](#) option is switched on (→ page 297).
- For the display of destination suggestions: the multimedia system has gathered sufficient data.

Multimedia system:

-  ➤ Navigation ➤  Where to?

- Press and hold on a destination suggestion. A menu appears.
- **To stop displaying a destination suggestion:** select one of the display options.
- **To save a destination suggestion as a favourite:** select one of the options for saving.
-  Deleting a destination suggestion from the favourites (→ page 340).

Route guidance with current traffic reports

Traffic information overview

Current traffic reports are received with the Live Traffic Information subscription service. If the

subscription has expired, then FM RDS-TMC is available in selected countries.

-  Live Traffic Information is not available in all countries.

The service must be registered in the Mercedes me Portal (→ page 356). This secures the free-of-charge period of three years.

Information from the service provider can be shown (→ page 356).

The service updates the traffic situation via the Internet connection at short, regular intervals.

Information on the vehicle's position is regularly sent to Daimler AG. The data is immediately rendered anonymous by Daimler AG and forwarded to the traffic data provider. Using this data, traffic reports relevant to the vehicle's position are sent to the vehicle. The vehicle acts as a sensor for the flow of traffic and helps to improve the quality of the traffic reports.

If you do not want to transmit the vehicle position, you have the following options:

- You deactivate the service in the Mercedes me Portal.

- You have the service deactivated at a Mercedes-Benz service centre.
-  Hazard warnings can be received using the Car-to-X service (→ page 358).

Showing information from the service provider for Live Traffic Information Requirements:

- The vehicle is equipped with Live Traffic Information.







Multimedia system:

-   [Mercedes me & Apps](#)
- [Live Traffic Information](#)

- Select [Provider information](#).
The logo of the service provider is shown.
When the subscription for Live Traffic Information has expired then in selected countries FM RDS-TMC is available.







Registering Live Traffic Information Requirements:

- The vehicle is equipped with Live Traffic Information.

- You have a user account on the Mercedes me website.
-  Create a user account at Mercedes me at: <http://www.mercedes.me>. A valid email address is required for this.
 -  Register the vehicle using the vehicle identification number (VIN).
 -  Connect the vehicle with your Mercedes me user account in the Mercedes me Portal. A code is sent to the multimedia system.
 -  Enter the code into the multimedia system.
 -  Accept the general and specific terms of use.
-  Alternatively, you can have the connection completed at a Mercedes-Benz service center.

Extending a Live Traffic Information subscription Requirements:

- The vehicle is equipped with Live Traffic Information.
- You have a user account on the Mercedes me website.

-  Call up the Mercedes me website.
-  Call up the Mercedes me user account.
-  Switch to the Mercedes me connect online store via the linked vehicle.
-  Select Live Traffic Information.
-  Select the renewal period.
-  Add the product to the shopping basket.
-  Accept the general and specific terms of use. Live Traffic Information remains activated for the selected extension period. Activation begins on the date of extension.

Displaying traffic information on the map Requirements:

- The [Traffic](#) display is switched on (→ page 358).
- [Traffic incidents](#), [Free-flowing traffic](#) and [Delay](#) are switched on (→ page 358).

Multimedia system:

-   [Select Navigation](#).

The map shows the following traffic information:

- Traffic incidents

These are roadworks, road blocks and hazard warnings, for example.

When route guidance is active, the symbols for traffic incidents will be shown in colour on the route. Off the route they are grey.

- Warning message symbols

 symbols and traffic safety information, e.g. people on the carriageway

If the vehicle approaches a danger area, a warning message is displayed on the map. In addition, an announcement can alert you to a hazard warning.

- Traffic flow information:

- traffic jam (red line)
- slow-moving traffic (orange line)
- heavy traffic (yellow line)
- free-flowing traffic (green line)

- Display for traffic delays on the route lasting at least one minute

Displaying traffic incidents

Requirements:

- The **Traffic incidents** display is switched on (→ page 358).

Multimedia system:

- ▶  ▶ Navigation
- ▶  ▶ Map symbols

If there are traffic incidents on the route, these are shown on the route overview.

If available, the following information is displayed:

- Road number/road name, road section and direction
- Traffic incident symbol ( roadworks)
Coloured on the route
- Distance from the current vehicle position
- Cause
- Delay
- Detailed information (if available)



- ▶ Tap on a symbol. Swipe to the right or left to see the complete route.
The detail information is displayed.

Showing traffic incidents in the vicinity of the map

- ▶ Tap on a traffic incident symbol.
The detail information is displayed.

Switching the traffic information display on

Multimedia system:



- ▶ Activate [Map symbols](#).
The display button is activated.
- ▶ Select [Advanced](#).
- ▶ Select [View](#).
- ▶ Select [Map symbols](#).
- ▶ Switch on [Area with traffic restrictions](#), [Traffic incidents](#), [Free-flowing traffic](#) and [Delay](#).
Current traffic restrictions and traffic incidents, for example roadworks, local area reports (e.g. fog) and warning messages, are shown.

The traffic delay is displayed for the current route. Traffic delays lasting one minute or longer are taken into consideration.

Car-to-X-Communication

Car-to-X-Communication overview

The following requirements apply for the Car-to-X-Communication service:

- The vehicle is equipped with a multimedia system featuring navigation and a communication module with an activated, integrated SIM card.
- There is a subscription for the Live Traffic Information service.
- The Car-to-X-Communication service is activated in the Mercedes me portal.

 Car-to-X-Communication is available in selected countries.

The communication module automatically establishes an Internet connection once the ignition is switched on. If there are any hazard warnings, they will be provided shortly thereafter. Depending on the mobile phone connection, the provision takes place from within a second up to about a minute.

Benefits of Car-to-X-Communication:

- Dangers are automatically detected by the vehicle or can be reported by the driver. These are then sent to vehicles with Car-to-X-Communication in the immediate vicinity.
- If available, current details relating to hazard spots near the vehicle's current position are received.

This gives you sufficient time to adapt your driving style to the traffic conditions.

The use of Car-to-X-Communication requires the regular transmission of vehicle data to Mercedes-Benz AG. The data is then immediately pseudonymised by Mercedes-Benz AG. The vehicle data is deleted after an appropriate amount of time has elapsed (several weeks) and is not stored permanently.

 Data which serves as identification is replaced during the pseudonymisation process. In this way, your identity is protected against access by unauthorised third parties.

Displaying hazard warnings

Multimedia system:



If hazard warnings are available these can be shown as symbols on the map. The display depends on the settings for the [Traffic incidents](#) option.

▶ Set the option via  (→ page 358).

If the option is activated, all of the symbols are shown.

If the option is deactivated, the symbols are only shown when there is a hazard warning.

The following hazards are shown on the map, for example:

- Accidents and breakdowns
- Fog and ice
- People on a motorway carriageway
- Vehicle driving on a road in the wrong direction
- Hazards reported manually
- Hazard warning lights
- Mobile roadworks

If the vehicle is approaching a hazard spot at a minimum speed, a voice message is issued.

 For weather hazards there is no voice output.

Sending hazard warnings

Automatically detected hazard warnings are sent by the vehicle.

- ▶ **To report a hazard manually:** when the map is shown, tap on the current vehicle position . The [Position](#) menu is shown.
- ▶ Select [Report traffic incident](#). A prompt is shown.
- ▶ Select [Yes](#). The [Thank you for supporting accident prevention!](#) message appears.
- ▶ **To report hazards with the MBUX Voice Assistant:** say the "Hey Mercedes, hazard on the road" voice command.
- ▶ Confirm the hazard warning. The [Thank you for supporting accident prevention!](#) message appears.

The following hazards can be reported:

- Broken-down vehicles
- Accidents
- Hazards
- People
- Animals
- Objects
- Potholes
- Aquaplaning
- Slippery roads

Route guidance with augmented reality

Overview of route guidance with augmented reality

 **WARNING** Risk of accident and injury as a result of distraction, incorrect depiction or wrong interpretation of the display

The camera image of the augmented reality display is not suitable as a guide for driving.

- ▶ Always keep an eye on the actual traffic situation.
- ▶ Avoid extended observation of the camera image.

During route guidance with augmented reality a camera image with the real traffic scene is shown in the central display before a turning manoeuvre.



- ① Street name
- ② House number
- ③ Change of direction arrow

Route guidance with augmented reality may not be available in some situations, e.g. in the event of poor satellite reception or roads which have not been digitised.

Route guidance with augmented reality is not available in all countries.

The camera image can contain the following additional information:

- Change of direction arrow
- Street names
- House numbers

Activating route guidance with augmented reality

⚠ WARNING Risk of accident and injury due to inaccurate positioning of the additional information

The additional information from the augmented reality display cannot replace observation of the actual driving situation.

- ▶ Keep the actual driving situation continuously in view during all driving manoeuvres.

Requirements:

- Route guidance is active.

Multimedia system:

→ Navigation

- ▶ Tap on . The indicator lamp lights up blue. The camera's video image is shown in the central display before a turning manoeuvre. The video image includes additional information.
- ▶ **To return to the navigation map:** tap on again. The indicator lamp is not lit.

Showing property information for route guidance with augmented reality

Requirements:

- Augmented reality is activated (→ page 360).

Multimedia system:



- ▶ Select **View**.
- ▶ Select **Augmented Reality**.
- ▶ Activate **Street names** and **House numbers**.
During route guidance, the activated options are shown as additional information in the camera image.

Map and compass

Setting the map scale

Multimedia system:



Zooming in

- ▶ When the map is shown, tap twice quickly with one finger on the central display.

or

- ▶ Move two fingers apart on the central display.

Zooming out

- ▶ Tap with two fingers on the central display.

or

- ▶ Move two fingers together on the central display.

 You can set the unit of measurement of the map scale (→ page 328).

Moving the map

Multimedia system:



- ▶ When the map is shown, touch the media display and move a finger in any direction. The map moves in the opposite direction.

The following functions are available:

- Select a destination on the map (→ page 340).
- Select a POI (→ page 338).
- Show traffic incidents on the map (→ page 357).

- ▶ **To reset the map to the current vehicle position:** select  **Centre**.

Selecting the map orientation

Multimedia system:



- ▶ Select **View**.
- ▶ Select **Map orientation**.
- ▶ Select an option.
The ● dot indicates the current setting.

The following options are available:

- **2D heading up** option: the 2D map view is aligned to the direction of travel.
- **2D north up** option: the 2D map view is displayed so that north is always at the top.
- **3D** option: the 3D map view is aligned to the direction of travel.

or

- ▶ **To use quick-access:** repeatedly tap or press on the  compass symbol on the map.
The view changes in the sequence **3D**, **2D heading up** to **2D north up**.

If the map is moved, it can switch between **3D** and **2D north up**.

Selecting POI symbols for the map display

Multimedia system:



POIs include restaurants and hotels, for example. These can be displayed as symbols on the map. Not all POIs are available in all countries.

Personal POIs are destinations which you have saved on a USB device, for example.

The display of POI symbols on the map can be activated or deactivated as a favourite.

- ▶ Select **View**.
- ▶ Select **Map symbols**.
- ▶ Select **POI symbols**
- ▶ Switch **Display POIs** on or off.
The POI symbols for the selected categories are shown on the map.

Switching display of categories for quick-access on/off

- ▶ Switch a category on or off in the menu.

Selecting categories

- ▶ Select in the **All categories** menu.
- ▶ Switch **Show all** on or off.
When the option is switched on, the POI symbols for all categories are shown on the map.

or

- ▶ Select the categories.
- ▶ Activate or deactivate the categories.
The POI symbols for the selected categories are shown on the map.

Selecting personal POI categories

- ▶ Select in the **Personal POIs** menu.
- ▶ Select a category.
- ▶ Switch **Display on the map** on or off.
When the display is switched on and the vehicle approaches a personal POI in this category, a visual and audible notification can be issued.
- ▶ **Indication when approaching:** switch **Acoustic notification** and **Visual warning** on or off.

Resetting the POI symbol display

- ▶ Select **Reset POIs** in the menu.
The settings are reset to the standard settings.

Selecting the display of text information in the map

Multimedia system:



- ▶ Select **View**.
- ▶ Select **Text information**.
- ▶ Switch an option on or off.
The current road is displayed in the navigation window. The scale and the elevation appear on the map.

Displaying the next intersecting street

Requirements:

- Route guidance is not active.

Multimedia system:



- ▶ Select **View**.
- ▶ Select **Text information**.

- ▶ Activate **Next junction**.
If the option is switched on and the journey continues without route guidance, the name of the next intersecting street will be displayed in the navigation window.

Displaying the map version

Multimedia system:



- ▶ Select **View**.
- ▶ Select **Map data version**.
The detail information is displayed.
- ① The online map update service from Mercedes me connect can be used to update the map data (→ page 364).
A message is shown in the central display when a new map version is available.
- ① Information about new versions of the digital map can be obtained from a Mercedes-Benz service centre.

Overview of avoiding an area for the route

You can define areas along a route that you would like to avoid.

Motorways or multi-lane expressways, which are routed through an area to be avoided are taken into account for the route.

Avoiding a new area for the route

Multimedia system:



- ▶ Select **Avoid new area**.
- ▶ **To start in the map:** select **Using map**.
A red rectangle appears. This designates the area that should be avoided.
- ▶ Move the map (→ page 361).
- ▶ Set the map scale (→ page 361).
- ▶ Select **OK**.
The area is entered into the list.
- ▶ **To start via destination search:** select **Via address entry**.
- ▶ Enter the address (→ page 336).
- ▶ Select the destination in the list or accept with **OK**.
The map appears. The area is saved.

Changing an area to be avoided

Multimedia system:



- ▶ Select an area in the list.
- ▶ Select **Edit**.
- ▶ **To move an area on the map:** swipe in any direction on the central display.
- ▶ **To change the size of the area:** tap on the central display.
- ▶ Select **OK**.
The area is entered into the list.
- ▶ **To take account of an area for the route:** select an area from the list.
- ▶ Activate **Avoid area**.
If route guidance is active, a new route is calculated.
If there is no route yet, the setting is carried over to the next route guidance.

The route can include an area that is to be avoided in the following cases:

- the destination is located in an area that is to be avoided.
- the route includes motorways or multi-lane expressways which pass through an area to be avoided.
- there is no sensible alternative route.

Deleting an area

Multimedia system:

  **Navigation**  **Route**
 **Avoid options**  **Avoid areas**

- ▶ **To delete an area:** select an area in the list.
- ▶ Select **Delete**.
- ▶ Confirm the prompt with **Yes**.
- ▶ **To delete all areas:** if at least two areas to avoid are set, select **Delete all**.
- ▶ Confirm the prompt with **Yes**.

Map data update overview

The digital maps generated by the map software become outdated in the same way as conventional road maps. Optimal route guidance can

only be provided by the navigation system in conjunction with up-to-date map data.

The following options are available for the update:

- Online map update
 - Update at a Mercedes-Benz service centre
- Additional costs can be incurred in this process.

Online map update

Requirements:

- Mercedes me connect is available.
- You have a user account for the Mercedes me Portal.
- The service is available.
- The service has been activated.

 The online map update service is not available in all countries.

The following options are available:

- Automatic map update for Europe
- The update is carried out based on the vehicle position. If a route goes through several

countries, for example, all available map updates for the route are downloaded.

A restart of the navigation system is required to use the downloaded map data. You will receive a message for this, which you can confirm.

- Manual map update for several or all regions
- The map data will first be downloaded onto a storage medium and then updated on the multimedia system.

You can find more information here:

- At any Mercedes-Benz service centre
- Under: <https://www.mercedes.me>

Further information on updates can be found at: https://moba.i.daimler.com/markets/ece-row/baix/cars/connectme/en_GB/#emotions/Startseite.html.

Overview of map data

Your vehicle is supplied with map data at the factory. Depending on the country, map data for your region is either pre-installed or the map data is supplied on a data storage medium.

If the map data on your vehicle has been installed at the factory and you wish to reinstall it, you do not need to enter the activation code.

For map data that you have purchased in the form of a data storage medium, you must enter the accompanying activation code.

- ❗ If you save the map data on a data storage medium with the online map update service, no entry is required. The activation code is stored on the data storage medium during the downloading process.

Observe the following when entering the activation code:

- The activation code can be used for one vehicle
- The activation code is not transferable
- The activation code has six digits

In the event of the following problems, please contact a Mercedes-Benz service centre:

- The multimedia system does not accept the activation code
- You have lost the activation code

Displaying the compass

Multimedia system:

→  → Navigation

▶ When the map is shown, press on the  current vehicle position until the **Position** menu is shown.

▶ Select **Compass**.

The compass display shows the following information:

- the current direction of travel with bearing (360° format) and compass direction
- longitude and latitude coordinates in degrees, minutes and seconds
- number of satellites from which a signal can be received

The information is not available in every country.

Displaying Qibla

Multimedia system:

→  → Navigation

▶ When the map is shown, press on the  current vehicle position until the **Position** menu is shown.

▶ Select **Qibla**.

The arrow on the compass shows the direction to Mecca in relation to the current direction of travel.

The number of satellites received is shown.

- ❗ This function is not available in all countries.

Setting the map scale automatically

Multimedia system:

→  → Navigation → 

▶ Select **View**.

▶ Select **Map orientation**.

▶ Activate **Auto zoom**.

The display button is activated. The map scale is set automatically depending on your driving speed and the type of road.

- ⓘ The automatically selected map scale can be changed manually. After a few seconds, this is automatically reset.

Displaying the satellite map

Multimedia system:



- ▶ Select **View**.
- ▶ Select **Map symbols**.
- ▶ Switch **Satellite map** on or off.
If the display button is activated, satellite maps are displayed in map scales from 2 km.
If the display button is deactivated, satellite maps are not displayed in map scales from 2 km to 20 km.

- ⓘ The satellite maps for these map scales are not available in all countries.

Displaying the range

Requirements:

- The multimedia system supports the function.

Multimedia system:



- ▶ Select **View**.
- ▶ Select **Map symbols**.
- ▶ Activate **Range**.

The range is shown on the map with the following displays:

- For petrol and diesel vehicles: green display

When the lower reserve capacity is reached then the range display on the map is switched off.

- ⓘ The range display on the map is not available in all countries.

Displaying weather information and other online map contents

Requirements:

- Mercedes me connect is available.
- You have a user account for the Mercedes me Portal.
- The service is available.
- The service has been activated.

Multimedia system:



- ▶ Select **View**.
- ▶ Select **Map symbols**.
- ▶ Switch on an online service, e.g. **Weather**.
Current weather information is displayed on the navigation map, e.g. temperature or cloud cover. The service information is not shown in all map scales, e.g. weather symbols.

Further information about available services and about displaying information in the map scales can be found at: <https://www.mercedes.me>

- ⓘ Weather information is not available in all countries.

Parking service

Selecting parking options

! **NOTE** Before selecting the parking option

The data is based on information provided by the respective service provider.

Mercedes Benz accepts no liability for the accuracy of the information provided relating to the multi-storey car park/parking area.

▶ Always observe the local Information and conditions.

Requirements:

- The navigation services option is available, subscribed to and activated in the Mercedes me Portal.
- The parking service is within the scope of the navigation service.
- [Parking](#) is activated (→ page 367).

Multimedia system:

→  → [Navigation](#)

▶ Tap on  in the map.

▶ Select a parking option.

The map shows the parking options in the vicinity.

The following information is displayed (if available):

- Destination address, distance from current vehicle position and arrival time
- Information on the multi-storey car park/car park

For example, opening times, parking charges, current occupancy, maximum parking time, **maximum access height**.

The maximum access height shown by the parking service does not replace the need for observation of the actual circumstances.

- Available payment options (Mercedes pay, coins, bank notes, cards)
- Details on parking tariffs

- Number of available parking spaces
 - Payment method (e.g. at the parking machine)
 - Services/facilities at the parking option
 - Telephone number
- ▶ Calculate the route (→ page 341).

The following functions can also be selected (if available):

- Search for POIs in the vicinity.
- Save the destination.
- Place a call at the destination.
- Share the destination using NFC or QR code.
- Call up the web address.
- Show the destination on the map.

Displaying parking options on the map

Requirements:

- The navigation services option is available, subscribed to and activated in the Mercedes me Portal.
- The parking service is within the scope of the navigation service.

Multimedia system:



▶ Activate **Parking**.

The parking options within the vicinity of the current vehicle position are shown.

Paying parking charges Requirements:

- The navigation services option is available and activated in the Mercedes me Portal. The parking service is within the scope of the navigation service.
- You have registered with your payment details for the payment of parking in the Mercedes me Portal with Mercedes Pay and the respective contract partner.
- **Parking** is activated (→ page 367).

Multimedia system:



This option is not available in all countries.

- ▶ Select a parking option on the map.

- ▶ If a car park that can be paid for has been selected, scroll down in the parking details. Select **Pay**.

or

- ▶ Once the vehicle has reached a parking position with payment function and the ignition is switched off, a message appears. Using this message you can pay from the vehicle and start the payment process.

- ▶ **To start the payment process:** confirm the message.

- ▶ Please note the maximum parking period displayed and any existing additional limitations. If required, a message will inform you about the necessity of displaying information confirming the online payment for the parking space.

- ▶ Select **Start the payment process**.

- ▶ If required, enter the personalised PIN.

- ▶ Press **OK** to confirm. The successful start of your parking transaction is shown.

- ▶ Complete the booking with **OK**.

- ▶ **To cancel the booking:** select **Cancel** when you receive the confirmation message. Minimum charges may be incurred.

- ▶ **To end the booking:** stop the active transaction via the Mercedes Me app. You receive a summary of the procedure and the costs.

If an active parking procedure for your vehicle is detected when you continue driving, a message appears asking if you wish to end this parking procedure.

- ▶ Acknowledge the message. When the parking procedure is stopped successfully, another message appears with the details about your completed parking procedure.

Dashcam

Notes on the dashcam

NOTE Before using the dashcam

Before using any or all functions of the Dashcam, please read this Disclaimer carefully. If you do not accept, agree to or understand this Disclaimer, please do not use the Dashcam. By using the Dashcam, you are deemed to have accepted and agreed to the contents of this Disclaimer.

As manufacturer of the vehicle, we provide you with the device and associated software system of the Dashcam to provide you with the functionalities that we consider you may wish to have while using the Dashcam. We are unable to predict or verify whether any image(s) or geographic information captured or recorded during your use of the Dashcam is legitimate. As such, we are unable to take responsibility for any adverse consequences that may arise from the actual image(s) or geographic information captured or recorded during use of the Dashcam.

Warning: please comply with all applicable laws and regulations when you use the Dashcam. For example, please do not capture or record image(s) or geographic information which may be considered as state secret sensitive information (e.g. military areas). In case of any violations of the relevant laws and regulations, the actual user will be liable for the corresponding responsibilities and we will not take responsibility for any misuse of the Dashcam.

- ▶ Observe the country-specific regulations.

Selecting a USB device for a video recording with the dashcam

Requirements:

- At least one USB device is connected with the multimedia system (→ page 425).

Multimedia system:

- ➔  ➔ Mercedes me & Apps
- ➔➔ Dashcam

- ▶ Select the USB symbol.

- ▶ Select the USB device.

Starting/stopping video recording with the dashcam

Requirements:

- A USB device is connected with the multimedia system (→ page 425).
- The ignition is switched on.

Multimedia system:

- ➔  ➔ Mercedes me & Apps
- ➔➔ Dashcam

- ▶ If several USB devices are connected with the multimedia system, select the USB device (→ page 369).

If no USB device is selected, a selection is made automatically when recording starts.

- ▶ **To select a recording mode:** select [Loop recording](#) or [Individual recording](#). [Loop recording](#) records several short video files. When the memory is full, the oldest video file is deleted and the recording continues automatically.

Individual recording stops recording when the memory limit is reached. An individual recording is automatically protected against being overwritten.

- ▶ **To start:** select **Start recording**.
The length of the recording is shown. The **Please do not remove the storage medium** message appears. The video file is stored on the USB device.
- ▶ **To end:** select **End recording**.

A report may appear in the following cases:

- **Individual recording:** the memory is full or there are only a few minutes recording time available. The video recording stops or will be stopped imminently.
Change the USB device or delete a video file.
- The camera is not functional, the **Camera unavailable** message appears.
Have the camera checked in a Mercedes-Benz service centre.
- If the country border indication has been switched on (→ page 370).

Deleting a dashcam video recording

Requirements:



- A USB device with video recordings is connected with the multimedia system (→ page 425).

Multimedia system:



- ▶  ▶ **Mercedes me & Apps**
- ▶ **Dashcam**

- ▶ Select .
- The **Recordings** menu appears.

Deleting individual video files

- ▶  Select .
- ▶ Select **Delete**.
- ▶ Select **Yes**.

Switching write protection on or off

- ▶  Select .
- ▶ Select **Write protection**.

Deleting all video files

- ▶ In the status line  select **Recordings**.
- ▶ Select **Delete all entries**.

Configuring dashcam settings

Requirements:

- A USB device is connected with the multimedia system (→ page 425).

Multimedia system:

- ▶  ▶ **Mercedes me & Apps**
- ▶ **Dashcam**

- ▶ Select .
- ▶ **To show messages after passing a national border:** switch on **National border alert**.
A message is shown if video is being recorded and the vehicle passes a border.

- ⓘ This function is not available in all countries.
- ▶ **To start automatic video recording:** select **Automatic video recording**.

- ▶ Activate **Automatic video recording**.
When the vehicle is started, video recording starts automatically.

ⓘ This function is not available in all countries.

Telephone

Telephony

Notes on telephony

⚠ WARNING Risk of distraction from operating integrated communication equipment while the vehicle is in motion

If you operate communication equipment integrated in the vehicle when driving, you will be distracted from the traffic situation. This could also cause you to lose control of the vehicle.

- ▶ Only operate this equipment when the traffic situation permits.
- ▶ If you cannot be sure of this, stop the vehicle whilst paying attention to road

and traffic conditions and operate the equipment with the vehicle stationary.

⚠ WARNING Risk of an accident from operating mobile communication equipment while the vehicle is in motion

Mobile communications devices distract the driver from the traffic situation. This could also cause the driver to lose control of the vehicle.

- ▶ As the driver, only operate mobile communications devices when the vehicle is stationary.
- ▶ As a vehicle occupant, only use mobile communications devices in the areas intended for this purpose, e.g. in the rear passenger compartment.

You must observe the legal requirements for the country in which you are currently driving when operating mobile communication equipment in the vehicle.

⚠ WARNING Risk of injury due to objects being stowed incorrectly

If objects in the vehicle interior are stowed incorrectly, they can slide or be thrown around and hit vehicle occupants. In addition, cup holders, open stowage spaces and mobile phone receptacles cannot always retain all objects they contain.

There is a risk of injury, particularly in the event of sudden braking or a sudden change in direction.

- ▶ Always stow objects so that they cannot be thrown around in such situations.
- ▶ Always make sure that objects do not protrude from stowage spaces, luggage nets or stowage nets.
- ▶ Close the lockable stowage spaces before starting a journey.
- ▶ Always stow and secure heavy, hard, pointed, sharp-edged, fragile or bulky objects in the boot/load compartment.

Observe the additional information on stowing mobile communications devices correctly:

- Loading the vehicle (→ page 119)

Further information can be obtained from a Mercedes-Benz service centre or at: <https://www.mercedes-benz-mobile.com/>

Telephone menu overview

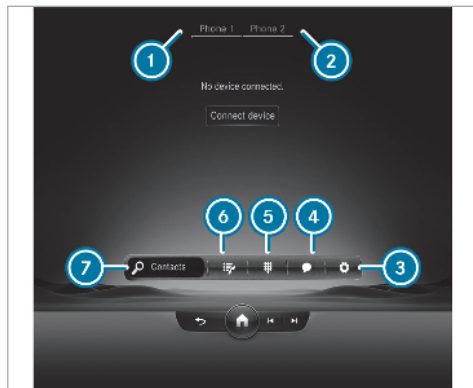

- 1 Bluetooth® device name of the currently connected mobile phone/of the mobile phone
- 2 Bluetooth® device name of the currently connected mobile phone/of the mobile phone (two phone mode)
- 3 Options

- 4 Messages
- 5 Numerical pad
- 6 Jumps to the telephone contents: e.g. call lists, contact lists, favourites
- 7 Contact search

Bluetooth® profile overview

Bluetooth® profile of the mobile phone	Function
PBAP (Phone Book Access Profile)	Contacts are automatically displayed in the multimedia system
MAP (Message Access Profile)	Message functions can be used

Bluetooth® profile of the mobile phone	Function
HFP (Hands Free Profile)	Wireless telephony is available
SAP (SIM Access Profile)	The auto-telephone has access to the SIM card data and dials into the mobile phone network via the exterior aerial

Telephony operating modes overview

Depending on your equipment, the following telephony operating modes are available:

- A mobile phone is connected to the multimedia system via Bluetooth® (→ page 373).
- Two mobile phones are connected with the multimedia system via Bluetooth® (two phone mode) (→ page 374).
 - You can use all the functions of the multimedia system with both mobile phones.
- Car telephony is set up (→ page 377).

i Irrespective of this, Bluetooth® audio functionality can be used with any mobile phone (→ page 426).

Information on telephony

The following situations can lead to the call being disconnected while the vehicle is in motion:

- there is insufficient network coverage in the area
- you move from one transmission/reception station to another and no communication channels are free
- the SIM card used is not compatible with the network available
- a mobile phone with "Twincard" is logged into the network with the second SIM card at the same time

The multimedia system supports calls in HD Voice® for improved speech quality. A requirement for this is that the mobile phone and the mobile phone network provider of the person you are calling support HD Voice®.

Depending on the quality of the connection, the voice quality may fluctuate.

Connecting a mobile phone Requirements:

- Bluetooth® is activated on the mobile phone (see the manufacturer's operating instructions).
- Bluetooth® is activated on the multimedia system (→ page 324).



Multimedia system:

 **Phone**

Searching for a mobile phone

 Select  **Connect device.**

Authorising a mobile phone

-  Select a mobile phone.
-  A code is displayed in the multimedia system and on the mobile phone.
-  **If the codes match:** confirm the code on the mobile phone.

- ❶ For older mobile phone models, enter a one to sixteen-digit number code on the mobile phone and on the multimedia system for authorisation.
- ❷ Up to 15 mobile phones can be authorised on the multimedia system. Authorised mobile phones are reconnected automatically.
- ❸ The connected mobile phone can also be used as Bluetooth® audio equipment (→ page 426).

Connecting a second mobile phone (two phone mode)

Requirements:

- At least one mobile phone is already connected to the multimedia system via Bluetooth®.

Multimedia system:



 ▶▶ Device manager ▶▶ My devices

- ▶ Select **Connect new device**.
- ▶ Select the mobile phone.

- ▶ In some cases, if the query appears, confirm the selection of the mobile phone pair with the **Device name 1 + Device name 2** option. The selected mobile phone is connected to the multimedia system.

Interchanging mobile phones (two phone mode)

Multimedia system:



Both mobile phones are shown individually in separate tabs.

- ▶ Select the tab with the desired mobile phone. Selecting the tab of a specific mobile phone displays the associated telephone contents. Selecting the other tab switches the view to the other telephone. The submenus in the telephone menu (e.g. contacts, call lists, messages) relate to the currently selected mobile phone with the exception of the telephone settings. In the telephone settings, settings can be made for both mobile phones.

Changing the function of a mobile phone

Multimedia system:



 ▶▶ Device manager ▶▶ My devices

Activating a function

- ▶ Select a grey symbol in the line of a mobile phone. The corresponding function is activated.

Deactivating a function

- ▶ **One function is active:** select the coloured symbol in the line of a mobile phone. The mobile phone is disconnected from the multimedia system.
- ▶ **Several functions are active:** de-select an active function in the line of one of the mobile phones. The corresponding function is deactivated.

Replacing mobile phones

Multimedia system:



▶▶ Device manager

- ▶ **No authorised mobile phone available:** select [Connect new device](#).

- ▶ Select a mobile phone.

- ▶ **Newly authorised mobile phone:** confirm the number code on the mobile phone.

Using in single telephone mode

- ▶ Select [Device name](#).

A newly authorised mobile phone is connected in single telephone mode.

If the mobile phone has already been authorised and connected in single telephone mode, it is connected again in single telephone mode.

If a mobile phone is already authorised and has been connected in two phone mode with another mobile phone, a query may come, whether the mobile phone should in future be operated in single telephone mode or con-

nected with another mobile phone in two phone mode.

- ▶ If required, confirm the query about operating mode (single telephone or two phone mode) by confirming the [Device name](#) option.

Using in two phone mode

- ▶ Select [Device name 1 + Device name 2](#). A newly authorised mobile phone is connected with the selected mobile phone in two phone mode.

If the mobile phone has already been authorised and connected in single telephone mode, it will be connected in future with the selected mobile phone in two phone mode.

If the mobile phone was previously connected with another mobile phone, this connection is cancelled.

Disconnecting/deleting a mobile phone

Multimedia system:



▶▶ Device manager ▶▶ My devices

- ▶ Select in the line of the mobile phone.

- ▶ **To disconnect:** select [Disconnect](#).

If applicable, the mobile phone will be automatically reconnected when the vehicle is next started.

- ▶ **To delete:** select [Delete device](#).

The mobile phone is deleted from the system.

Information on Near Field Communication (NFC)

NFC enables short-range wireless data transfer or (re)connection of a mobile phone with the multimedia system.

Further information can be obtained at: <https://www.mercedes-benz-mobile.com/>

Using a mobile phone with Near Field Communication (NFC)

Requirements:

- NFC is activated on the mobile phone (see the manufacturer's operating instructions)
- The mobile phone's screen is switched on and unlocked (see the manufacturer's operating instructions)

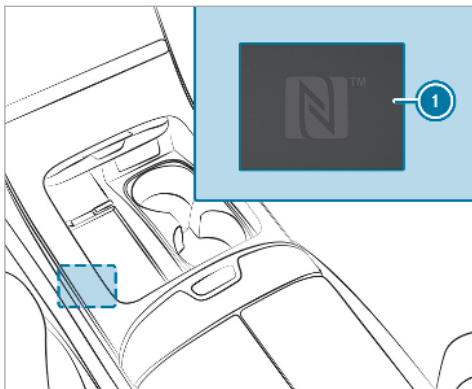

- ▶ **To connect a mobile phone:** place the NFC area of the mobile phone (see manufacturer's

operating instructions) on NFC touchpoint ①.

- ▶ Follow the additional prompts on the central display to connect the mobile phone. Connect the mobile phone in single telephone mode (→ page 373). Connect the mobile phone in two phone mode (→ page 374).
- ▶ **To replace a mobile phone:** hold the NFC area of the mobile phone (see manufacturer's operating instructions) on mat ① or place the mobile phone on it.
- ▶ Follow the additional prompts on the central display to replace the mobile phone in one or two phone mode (→ page 374).
- ▶ If required, confirm the prompts on your mobile phone (see the manufacturer's operating instructions).
- ① If your mobile phone supports wireless charging, it can be charged automatically on the mat (→ page 140).

Further information can be found at: <https://www.mercedes-benz-mobile.com/>

Setting the reception and transmission volume

Requirements:

- A mobile phone is connected (→ page 373).

Multimedia system:

- ▶ ▶ Phone ▶
- ▶ <device name>

This function ensures optimal language quality.

- ① Please note that the respective mobile phone must be selected for adjustment of the reception and transmission volume.
- ▶ Select **Volume**.
- ▶ Set the reception and transmission volume using **Reception volume** and **Transmission volume**.

Further information on the recommended reception and transmission volume: <https://www.mercedes-benz-mobile.com/>

Setting the ringtone

Multimedia system:



▶▶ <device name>

- ▶ Select **Ringtones**.
- ▶ Set the ringtone.

i If the mobile phone supports the transfer of the ringtone, you will hear the ringtone of the mobile phone instead of that of the vehicle.

Starting/stopping mobile phone voice recognition



Requirements:

- At least one mobile phone is connected to the multimedia system (→ page 373).
- The tab with the mobile phone for which voice recognition should be started is selected (→ page 374).

Starting mobile phone voice recognition

- ▶ Press and hold the  button on the multi-function steering wheel for more than one second.
Voice recognition is started for the currently selected mobile phone.

Stopping mobile phone voice recognition

- ▶ Press the  or  button on the multi-function steering wheel.
- i** If a mobile phone is connected via Smartphone Integration, the voice recognition of this mobile phone is always started or stopped.

Car telephony

Overview of car telephony operating modes

Car telephony offers you the following operating modes:

- Using a mobile phone with Bluetooth® profile SAP (**S**IM **A**ccess **P**rofile) (→ page 378)
- Using SIM card (→ page 379)

- Using SIM card in combination with a specific mobile phone

This operating mode is mainly intended for those using multiple SIM cards. As soon as the mobile phone associated with the SIM card is connected with the multimedia system in the vehicle, the SIM card is automatically activated for car telephony. The association of the SIM card with the set mobile phone prevents automatic activation of car telephony via the SIM card if the vehicle is borrowed by other persons, for example (→ page 379).

Symbols of car telephony

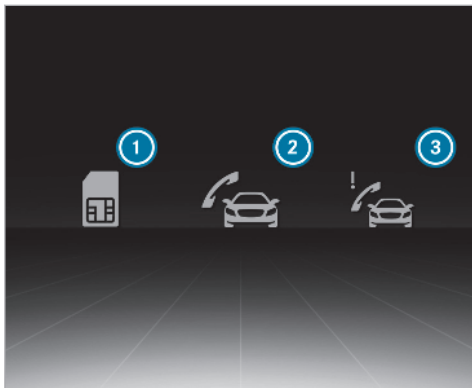

- ① Mobile phone is only used in combination with SIM Card
- ② Car phone connected
- ③ Car telephony malfunctioning (check the status of the SIM card PIN (→ page 379))

Setting up car telephony with a mobile phone via Bluetooth® SAP

Requirements:

- Bluetooth® is activated on the mobile phone (see the manufacturer's operating instructions).
- Bluetooth® is activated on the multimedia system (→ page 324).
- The mobile phone supports the Bluetooth® profile SAP (**S**IM **A**ccess **P**rofile).

Multimedia system:

→ Home ▶ Phone

- ▶ Select **Connect device**.
 - ▶ Select a mobile phone with the SAP Bluetooth® profile.
 - ▶ Connect the mobile phone with the multimedia system via Secure Simple Pairing or the passkey (→ page 373).
 - ▶ Enter the SIM card PIN and confirm.
- ⓘ If the mobile phone is connected as a car phone, calls cannot be made on the mobile

phone, since its SIM card is being used by the vehicle.

- ⓘ Connect the mobile phone to the vehicle hotspot for data reception .

Changing between Bluetooth® telephony and car telephony via the SAP Bluetooth® profile

▶ **To change to Bluetooth® telephony:** select the symbol in the line of the mobile phone in the device manager.

▶ Select **Use as Bluetooth phone**.

The mobile phone is no longer connected via the Bluetooth® SAP profile but via the Bluetooth® HFP profile (**H**ands **F**ree **P**rofile).

▶ **To change to car telephony via the Bluetooth®SAP profile :** select the symbol in the line of the mobile phone in the device manager.

▶ Select **Use as car phone**.

The mobile phone is connected using the SAP Bluetooth® profile.

- ⓘ This option is only shown if the mobile phone supports the Bluetooth® SAP profile.

Setting up car telephony via SIM card

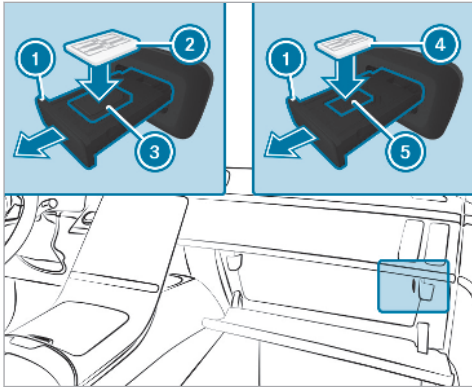

- ▶ Open SIM card holder loading drawer ① in the glove compartment .
- ▶ **To use the mini SIM card:** place mini SIM card ② in corresponding card slot ③. The active side of the SIM card holder has the contacts facing upwards.

or

- ▶ **To use the nano SIM card:** place nano SIM card ④ in corresponding card holder ⑤. The active side of the SIM card holder has the contacts facing upwards.
- ▶ If required, confirm that mobile phones already connected should be disconnected.
- ▶ If required enter and confirm the SIM card PIN.
- ▶ **To always use a SIM card:** answer the **SIM card connected Do you want to use this SIM card with only one specific device?** query with **No**. Incoming and outgoing calls are available in the vehicle's multimedia system using the SIM card.

- ① Every time the vehicle is started, the SIM card is automatically connected and logged into the radio cell.
- ① In addition to the SIM card another mobile phone can be connected in two phone mode (→ page 374).
- ▶ **To use the SIM card only in combination with a specific mobile phone:** answer the **SIM card connected Do you want to use this**

SIM card with only one specific device? query with **Yes**.

- ▶ Select a mobile phone that has been authorised or connect a new mobile phone. Incoming and outgoing calls are available in the vehicle's multimedia system using the SIM card.
- ① The SIM card only logs into the radio cell when the associated mobile phone is connected. The associated mobile phone can be changed in the settings for the SIM card (→ page 380).

Checking the status of the SIM card PIN
Multimedia system:

→ [Home] ▶▶ Phone ▶▶ [Settings]
▶▶ Device manager ▶▶ My devices

The symbol for car telephony appears with an exclamation mark if re-entering the PIN is required.

- ▶ Select the name of the mobile phone or the SIM card.
- ▶ Enter the SIM card PIN and confirm.

Calling up the car telephony settings

Multimedia system:



- ▶ Select the desired settings.

The following settings are available:

- [SIM card](#) (→ page 380)
- [Withhold phone number](#) (→ page 380)
- [Call waiting](#) (→ page 380)
- [Select network provider](#) (→ page 381)
- [Call forwarding](#) (→ page 381)
- [Data usage, voice](#) (→ page 381)

Setting the SIM card

Multimedia system:



▶ SIM card

The following options are available:

Saving the PIN

- ▶ Activate the display button.
The SIM card PIN is saved.

Entering the PIN again

- ▶ Enter the PIN.

Combining the SIM card with a specific mobile phone

- ▶ Activate the [Activation only with device](#) option.
Use of the SIM card with a specific mobile phone is activated. The name of the associated mobile phone is shown.

Always using a SIM card

- ▶ Deactivate the [Activation only with device](#) option.
Use of the SIM card with a specific mobile phone is deactivated.

Changing the combined mobile phone

- ▶ If the [Activation only with device](#) option is activated, first deactivate this and then activate again.
- ▶ Answer the [SIM card connected Do you want to use this SIM card with only one specific device?](#) question with **Yes**.

- ▶ Select a mobile phone that has been authorised or connect a new mobile phone.

Setting telephone number transmission

Multimedia system:



▶ Withhold phone number

The following options are available:

- ▶ [Withhold own number](#)
- ▶ [Show own number](#)
- ▶ [Network standard](#)

Setting the call waiting function

Multimedia system:



▶ Call waiting

- ▶ **To switch on call waiting:** activate the option.
- ▶ **To switch off call waiting:** deactivate the option.

Selecting a network provider

Multimedia system:

-  ➤ Phone ➤ Car phone ➤ 
- Select network provider

Automatically

- ▶ Activate the [Auto. select network provider](#) option.

Manually

- ▶ Deactivate the [Auto. select network provider](#) option.
- ▶ Select [Call up network status](#). Available network providers are shown.
- ▶ Select a network provider.

Setting call forwarding

Multimedia system:

-  ➤ Phone ➤ Car phone ➤ 
- Call forwarding

- ▶ Select [New call forwarding rule](#).
- ▶ Select an arrangement.
- ▶ Enter a telephone number.

Setting the data use language

Multimedia system:

-  ➤ Phone ➤ Car phone ➤ 
- Data usage, voice

You have the following options when selecting the transmission standard:

- ▶ Automatic
- ▶ Automatic (without LTE)
- ▶ 3G
- ▶ 2G
- ▶ 4G
- ▶ VoLTE Activate or deactivate

Calls

Telephone operation:

Multimedia system:

-  ➤ Phone

Making a call by entering the numbers

- ▶ Select .
- ▶ Enter a number.

- ▶ Select .
- The call is made.

Accepting a call

- ▶ Select  [Accept](#).

Rejecting a call

- ▶ Select  [Reject](#).

Answering a call with a message

- ▶ [Answer with message](#)

Noting an incoming call in In-Car Office



- ▶ If In-Car Office is available: select [Reminder](#) (→ page 390).



Ending a call

- ▶ Select .

Activating functions during a call

The following functions are available during a call:

-  [End call](#)
-  [Microphone off](#)

-  **Numerical keypad** (show to send DTMF tones)
-  **Add call**
- **Hands-free mode** (The call can be transferred to the front or rear compartment, for example)
- **Private mode** (The call can be transferred to the telephone or headphones, for example)

▶ Select a function.

-  Please observe that the functions and symbols can vary depending on the vehicle equipment.

Conducting calls with several participants Requirements:

- There is an active call (→ page 381).
- Another call is being made.

Switching between calls

- ▶ Select the contact.
The selected call is active. The other call is on hold.

Activating a call on hold

- ▶ Select the contact of the call on hold.

Conducting a conference call

- ▶ Select  **Create conf. call**.
The new participant is included in the conference call.

Ending an active call

- ▶ Select  **End call**.

-  On some mobile phones, the call on hold is activated as soon as the active call is ended.

Accepting/rejecting a waiting call Requirements:

- There is an active call (→ page 381).

If you receive a call while already in a call, a message is displayed.

Depending on the mobile phone and mobile network operator you will hear a call-waiting sound.

Alternatively, in two phone mode you will hear an acoustic signal when the call goes through to the other (not yet active) mobile phone.

- ▶ Select  **Accept**.
The incoming call is active.

If only one mobile phone is connected with the multimedia system, the previous call will be put on hold.

If during a call you accept a call with the other mobile phone when in two phone mode then the existing call is ended.

- ▶ **Answer with message**

or

- ▶ Select  **Reject**.

-  This function and behaviour depends on your mobile phone network provider and the mobile phone (see the manufacturer's operating instructions).

Contacts

Information about the contacts menu

The contacts menu contains all contacts from existing data sources, e.g. mobile phone or data storage medium.

Depending on the data source, it is possible to save/load the following number of contacts:

- Permanently saved contacts: 3,000 entries
- Contacts loaded from the mobile phone: 5,000 entries per mobile phone

From the contacts menu, you can perform the following actions:



- Make a call, for example call a contact (→ page 384)
- Navigation (→ page 339)
- Compose messages (→ page 387)
- Additional options (→ page 384)

If a mobile phone is connected to the multimedia system (→ page 373) and automatic calling up (→ page 383) is activated, the mobile phone's contacts are displayed in the address book.

The multimedia system can show suggestions based on frequently used contacts as well as incoming and outgoing calls. These are shown at the top of the contact list.

Downloading mobile phone contacts

Multimedia system:

- ▶  ▶ Phone ▶ <device name>
- ▶  ▶ Select **Contacts**.

Automatically

- ▶ If the **Synchronise automatically** function is not active: activate the function.

Manually

- ▶ If the **Synchronise automatically** function is active: deactivate the function.
- ▶ Select **Text is Missing**.

You can see from the status of controller to the right of the **Synchronise automatically** display text whether the function is active.

Calling up contacts

Multimedia system:

- ▶  ▶ Phone ▶  **Contacts**

The following options can be used to search for contacts:

- searching by initials

- searching by name
- searching by phone number



- ▶ Enter characters into the search field.
- ▶ Select the contact.

A contact can contain the following details:

- phone numbers
- navigation addresses
- Internet address
- e-mail addresses
- voice tag (if set)
- relation (if set)



Editing the format of a contact's name

Multimedia system:

- ▶  ▶ Phone ▶ 
- ▶ Select **General**.
- ▶ Select **Name format**.
- ▶ Select an option.

Overview of importing contacts



Contacts from various sources



Source	Requirements:
 USB device	The USB device is connected with the USB port.
 Bluetooth® connection	Bluetooth® is activated in the multimedia system and on the respective device (see the manufacturer's operating instructions).

 If the sending of vCards via Bluetooth® is supported, vCards can be received on mobile phones or netbooks, for example.

Importing contacts into the contacts menu

Multimedia system:







   
 

-  Select a mobile phone <device name>, from which the contacts should be imported.
-  Select an option.

Saving a mobile phone contact

Multimedia system:



-  Select   in the line of the mobile phone contact.
-  Select .
-  Select **Save**.
-  Select **Yes**.
The contact saved in the multimedia system is identified by the MBUX symbol.

Calling a contact

Multimedia system:





-  Select  **Search contacts**.

-  Enter characters into the search field.
-  Select the contact.
-  Select the telephone number.
The number is dialled.

Selecting further options in the contacts menu

Multimedia system:

-  Select  in the line of the contact.
-  Select .
-  Select an option.

Selecting options for suggestions in the contacts menu

Requirements:

- A profile has been created (→ page 296).
- The **Allow contact suggestions** setting is switched on .

Multimedia system:

-  Select **Contacts**.

- ▶ Select  in the line of a suggested contact.

The following options are available:

- [Save as favourite](#)
The suggestions are saved as global favourites and do not appear in the favourites of the telephone application.
 - [Do not suggest now](#)
- ▶ Select an option.

Deleting contacts

Requirements:

- The contacts are saved in the vehicle.
- To delete an individual contact, this has been imported manually into the vehicle.

Multimedia system:





Deleting all contacts

- ▶ Select .
- ▶ Select [General](#).
- ▶ Select [Contacts](#).

- ▶ Select [Delete contacts](#).
- ▶ Select an option.

Deleting a contact

- ▶ Select [Contacts](#).
- ▶ Select  in the line of the contact.
- ▶ Select .
- ▶ Select [Delete contact](#).
- ▶ Select [Yes](#).

Saving a contact as a favourite

Requirements:

- Your mobile phone does not support automatic downloading of contacts which are saved on the mobile phone as favourites.
-  If your mobile phone supports automatic downloading of favourites, no new favourites can be saved manually.

Multimedia system:



- ▶ Select a contact.
- ▶ Select  in the line of the contact.

- ▶ Select the telephone number.
The contact is stored as a favourite in the telephone menu overview.



Deleting favourites in the telephone menu overview

Multimedia system:



- ▶ Select a favourite in the telephone menu overview (→ page 385).
- ▶ Press and hold the favourite.
- ▶ Select [Delete](#).
- ▶ Select [Yes](#).

Deleting all favourites

- ▶ Tap on  in the central display.
- ▶ Select [Phone](#).
- ▶ Select .
- ▶ Select the connected telephone <device name>.
- ▶ Select [Contacts](#).
- ▶ Select [Delete all favourites](#).
The prompt [Delete all favourites?](#) appears.

- ▶ Select **Ja** (Yes).

Call list

Overview of the call list

Depending on whether your mobile phone supports the PBAP Bluetooth® profile or not, this can have different effects on the presentation and functions of the call list.

If the PBAP Bluetooth® profile is supported, the effects are as follows:

- The call lists from the mobile phone are displayed in the multimedia system.
- When connecting the mobile phone, you may have to confirm the connection for the PBAP Bluetooth® profile.

If the PBAP Bluetooth® profile is not supported, the effects are as follows:

- The multimedia system generates a call list independently as soon as calls are made in the vehicle.
- The call list is not synchronised with the call lists in the mobile phone.

The multimedia system can show suggestions based on frequently used contacts as well as incoming and outgoing calls. These are shown at the top of the call list.

Making a call from the call list

Multimedia system:

→  ▶ Phone

▶ Select  **Call list**.

▶ Select an entry.
The call is made.

Calling up additional options in the call list

Multimedia system:

→  ▶ Phone ▶  **Call list**

▶ For contacts that are in the address book: select options.

The contact details are called up.

▶ For contacts where only one number is shown (not in the address book): select

.

Selecting options for suggestions in the call list

Requirements:

- A profile has been created (→ page 296).
- The **Allow contact suggestions** setting is switched on.

Multimedia system:

→  ▶ Phone

▶ Select  **Call list**.

▶ Select  in the line of a suggested entry.

▶ Select an option.

Deleting the call list

Multimedia system:

→  ▶ Phone ▶ **<device name>**

▶ 

▶ Select **Contacts**.

▶ Select **Delete call list**.

▶ Select **Yes**.

- ⓘ This function is only available if your mobile does not support the PBAP Bluetooth® profile.

Text messages

Overview of message functions

In the messages menu you can receive and send text messages.



If the connected mobile phone supports the Bluetooth® MAP profile, the message function can be used on the multimedia system.



You can obtain further information about settings and supported functions of Bluetooth®-capable mobile phones at a Mercedes-Benz service centre or at: <https://www.mercedes-benz-mobile.com/>

Some mobile phones require further settings after being connected to the multimedia system to activate the messaging functionality (see manufacturer's operating instructions).

Setting message displays



Multimedia system:

 **Phone** **>>** **<device name>**
>> 



-  Select **Message display**.
-  Select **On** or **Off**.

Reading messages

Multimedia system:

 **Phone** **>>** **<device name>**
>> 

Using the read-aloud function



-  Select a contact.
-  Select  to read aloud.
The message is read aloud.

Dictating and sending a new message

Requirements:



- There is an Internet connection.

Multimedia system:



 **Phone** **>>** **<device name>**
>> 

-  Select a new message using .



Adding a recipient

-  Select .
-  Select a contact.

Dictating text



-  Select .
The dictating function is started.
-  Say the message.
After the voice message has been processed, it is shown as text.

Sending a message



-  Select **Send**.
-  When the vehicle is stationary you can use the keyboard to write a message. No Internet connection is required to use the keyboard.

Replying to a message in the messaging history

Multimedia system:

 **Phone** **>>** **<device name>**
>> 

A message list is shown.

-  Select  next to a contact.
The messaging history with this contact is shown.



- ▶ Select . The dictating function is started.
- ▶ Say the message. After the voice message has been processed, it is shown as text.
- ▶ Select [Send](#).

Using message templates



Multimedia system:

- ▶  ▶ [Phone](#) ▶ [<device name>](#)
- ▶ 

Using a template as a new message

- ▶ Select  to write a new message.
- ▶ Add a recipient using .
- ▶ Select a  template.

Answering a message with a template

- ▶ Select a message sequence with a contact.
- ▶ Select  templates.
- ▶ Select a  template.

Forwarding a message

Multimedia system:

- ▶  ▶ [Phone](#) ▶ [<device name>](#)
- ▶ 

A message list is shown.



- ▶ Select  next to a contact. The messaging history with this contact is shown.
- ▶ Press and hold on a message.
- ▶ **To forward a message:** select [Forward](#).

Calling a message sender

Multimedia system:

- ▶  ▶ [Phone](#) ▶ [<device name>](#)
- ▶ 

A message list is shown.



- ▶ Select  next to a contact. The messaging history with this contact is shown.
- ▶ Select .
- ▶ Select [Call](#).

Using telephone numbers, URLs or emails from a text message

Requirements:

- An Internet connection is available to call up a URL.

Multimedia system:

- ▶  ▶ [Phone](#) ▶ [<device name>](#)
- ▶ 

A message list is shown.

- ▶ Select  next to a contact. The messaging history with this contact is shown.
- ▶ Select a telephone number or a URL in the message. If a URL is selected the web browser opens. If a telephone number is selected the following options are available:
 - [Call](#)
 - [New message](#)

or

▶ **If In-Car Office and the email function are available:** select an email address. When the email address is selected, In-Car Office opens.

❗ The availability of In-Car Office is country-dependent.

▶ Select an option.

Deleting a message

Multimedia system:

▶  ▶▶ Phone ▶▶ <device name>

▶▶ 

▶ Select a contact.

▶ Press and hold on a message.

▶ **To delete the message:** select **Delete**.

In-Car Office

In-Car Office functions

Using In-Car Office, you can connect your online services with the multimedia system.

The following functions are available:

- Calendar

Showing appointments and triggering actions, e.g. reading aloud, placing a call, navigating

- E-mail
Reading e-mails, reading aloud and answering
- Tasks and calls
Managing tasks and prebooked calls

Video conference

Participation in a video conference is carried out by selecting a calendar entry in In-Car Office. The calendar entry must contain an invitation with a link to a video conference from a supported provider.

❗ Please note that certain functions are only available when the vehicle is stationary.

Calling up In-Car Office Requirements:

- A mobile phone is connected as the main phone to the multimedia system.

- You have a user account in the Mercedes me Portal: <https://me.secure.mercedes-benz.com>
- The In-Car Office service is activated in the Mercedes me Portal.
- You have a user account with an online service, e.g. with Office 365, and have connected this with In-Car Office via the Mercedes me Portal.

In this way, appointments, e-mails and tasks can be synchronised and facilitated.

Multimedia system:

▶  ▶▶ Mercedes me & Apps

▶ Select **In-Car Office**.

An overview shows the appointments for the current day.

Appointments can be all-day or have a duration, e.g. a two-hour appointment with information for the start and finish.

Selecting calendar functions in In-Car Office.

Multimedia system:



 Mercedes me & Apps
 In-Car Office

▶ Select an appointment.

▶ Select a function.

The following functions are available:

 Read aloud

 Call

 Navigate

 Delete

 Functions are available if corresponding appointment information is saved.

Examples of this are:

- If a telephone number has been saved for the appointment, [Call](#) is available.
- If a navigable address has been saved in the Online Account for the appointment, [Navigate](#) is available.

Selecting functions of Tasks & Calls in "In Car Office"

Multimedia system:



 Mercedes me & Apps
 In-Car Office

▶ Select a function for an entry.

The following functions are available:

• Reading aloud 

• Placing a call 

This task function requires a telephone number.

• Marking as completed

In the current editing, the tick can be removed and the entry marked as open.

• Deleting 

• Displaying details 

Marking an entry as completed in Tasks & Calls

Multimedia system:



 Mercedes me & Apps
 In-Car Office

▶ Select [Tasks & calls](#).

An overview appears.

▶ Select .

Noting an incoming call

When you receive an incoming call a prompt appears asking whether the call should be accepted, rejected or noted with a reminder of the call.

▶ Select [Reminder](#).

The call is declined and added to the In-Car Office [Tasks & calls](#) automatically.

Managing e-mails

Multimedia system:

-  ➤ Mercedes me & Apps
- In-Car Office ➤ E-mail

Showing/reading e-mail

- ▶ Select an e-mail.
The e-mail is opened.

Additional functions are available:

- Creating e-mail.(→ page 391)
- Answering e-mail (→ page 391)
- Forwarding e-mail(→ page 392)

Writing new e-mail

Multimedia system:

-  ➤ Mercedes me & Apps
- In-Car Office ➤ E-mail

Using the keyboard

- ▶ Select  Create e-mail.
- ▶ Add recipients using .

- ① **Contacts can be used from the linked online service such as Office 365.**

- ▶ Enter the subject and text of the e-mail in the corresponding fields with the keypad.
- ▶ Select **Send**.

Using the dictation function

- ① The dictation function is not available everywhere nor without limitation. For initial activation of the function it may be necessary to select the terms of use in the Mercedes me Portal.
- ▶ Select .
The dictating function is started.
- ▶ Dictate the subject and text of the e-mail.
After the voice entry has been processed, it is shown as text.
- ▶ Select **Send**.

Using voice control

- ▶ Use the "Write an e-mail" MBUX Voice Assistant voice command.
You are guided by the dialogue.
- ① Further information on operating the MBUX Voice Assistant (→ page 287).

Answering e-mail

Multimedia system:

-  ➤ Mercedes me & Apps
- In-Car Office ➤ E-mail

Using the keyboard

- ▶ Select an e-mail.
- ▶ Select **Reply**.
- ▶ Enter the e-mail text in the corresponding field.
- ▶ Select **Send**.

Using the dictation function

- ① The dictation function is not available everywhere nor without limitation. For initial activation of the function it may be necessary to select the terms of use in the Mercedes me Portal.
- ▶ Select an e-mail.
- ▶ Select **Reply**.
- ▶ Select .
The dictating function is started.

- ▶ Dictate the text of the e-mail.
After the voice entry has been processed, it is shown as text.
- ▶ Select [Send](#).

Using voice control

- ▶ Use the "Answer e-mail" MBUX Voice Assistant voice command.
You are guided by the dialogue.
- ⓘ Further information on operating the MBUX Voice Assistant (→ page 287).

Forwarding e-mail

Multimedia system:

- ➔  ➔ [Mercedes me & Apps](#)
- ➔ [In-Car Office](#) ➔ [E-mail](#)

Using the keyboard

- ▶ Select an e-mail.
- ▶ Select [Forward](#).
- ▶ **To forward with attachment:** select [Forward with attachment](#).

- ⓘ **Contacts can be used from the linked online service such as Office 365.**

- ▶ **To forward without attachment:** select [Forward without attachment](#).
- ▶ Enter the e-mail text in the corresponding field using the keypad.
- ▶ Select [Send](#).

Using voice control

- ▶ Use the "Forward e-mail" MBUX Voice Assistant voice command.
Dictate the text of the e-mail.
- ⓘ Further information on operating the MBUX Voice Assistant (→ page 287).

Video conference overview

The function makes it possible to participate in a video conference when in the vehicle. For this, the camera, the media display, microphone and additional equipment are used.

Participation in a video conference is carried out by selecting a calendar entry in In-Car Office. The calendar entry must contain an invitation with a link to a video conference from a supported provider.

During the video conference, the videos of the participants as well as your own video content can be shown on the media display.

In addition, participant content can be shared for the display, e.g. for presentations.

ⓘ No content can be shared from the vehicle. The following are requirements for a video conference:

- Equipment with MBUX high-end Rear Seat Entertainment System
- In-Car Office with calendar and e-mail function as well as support of the Multisat-Profile-Management
- Access to the video conference and the linking of authorisations with the Mercedes me Account
- Internet connection

The Internet connection requires data volumes that are booked via the mobile phone. Alternatively, it can be made available with the "Internet in the car" additional data package.

- An invitation to a video conference with a linked calendar entry

The video conference offers you the following functions:

- Participating in a video conference by selection of a linked calendar entry
- Audio playback via headphones
- Adjusting the volume
- Switching sound off and on (output and input)
- Switching off your own video content
- Ending a video conference

The following information can be displayed during a video conference:

- Information about the active speaker
- Name of the participant in the video stream (if video is supported)
- Preview of the camera image before and during participation
- Display of video content from other participants

- Audio status of participants (sound off/ sound on)
- Duration of the meeting
- Audio using headphones (Bluetooth® or corded)
- Accepting a call and pausing the current video conference

An incoming call can be accepted with a connected mobile phone. The video conference remains connected, the name of the participant continues to be shown. Audio and video playback are deactivated. When the call is finished, participation in the video conference is continued.

- Switching off transmitted video content and changing to audio playback

Mercedes-Benz link

Overview of Mercedes-Benz Link

⚠ WARNING Risk of distraction from information systems and communications equipment

If you operate information and communication equipment integrated in the vehicle when driving, you will be distracted from the traffic situation. This could also cause you to lose control of the vehicle.

- ▶ Only operate this equipment when the traffic situation permits.
- ▶ If you cannot be sure of this, stop the vehicle whilst paying attention to road and traffic conditions and operate the equipment with the vehicle stationary.

You must observe the legal requirements for the country in which you are currently driving when operating the multimedia system.

With Mercedes-Benz Link you can use mobile phone functions via the multimedia system. It is operated using the touchscreen or the voice-



operated control system. You can activate the voice-operated control system by pressing and holding the  button on the multifunction steering wheel.

When using Mercedes-Benz Link via the voice-operated control system, the multimedia system can still be operated using the MBUX Voice Assistant (→ page 286).

The Mercedes-Benz Link control box supplementary equipment is required for this. This is available at a Mercedes-Benz service centre.

Only one mobile phone at a time can be connected via Mercedes-Benz Link to the multimedia system.

If a mobile phone is connected with Mercedes-Benz Link, only one additional mobile phone can be connected using Bluetooth® with the multimedia system when in two phone mode.

-  The Mercedes-Benz Link control box uses the Android operating system.
-  The service provider is responsible for the apps as well as the services and content connected to it.



Notes on Mercedes-Benz Link

Only one route guidance can be active at a time. If route guidance is active on the multimedia system, it is closed when route guidance is started on the mobile phone.

Connecting Mercedes-Benz Link with the multimedia system

Requirements:

- The vehicle is fitted with the Mercedes-Benz Link control box.
- The Mercedes-Benz Link app is installed on the mobile phone.
- The mobile phone is switched on.

-  The first activation of Mercedes-Benz Link on the multimedia system must be carried out when the vehicle is stationary for safety reasons.
-  Connect Mercedes-Benz Link with the USB port on the multimedia system using a suitable cable (→ page 425). The  Mercedes symbol appears in the status line.

-  Select the  Mercedes symbol. Mercedes-Benz Link starts.

When the application is connected for the first time, a message relating to terms of use appears.

-  Select **Accept & start** if the application should be started.



or

-  **If two telephones are connected with the multimedia system:** start Mercedes-Benz Link using the device manager (→ page 374).

Quitting Mercedes-Benz Link

-  Select .

or

-  Press the  button on the Touch Control (MBUX multimedia system).

-  If Mercedes-Benz Link was not displayed in the foreground before disconnecting, the application starts in the background when reconnected. You can call up Mercedes-Benz Link using the main menu.

You can find more information in the Mercedes-Benz Link control box operating instructions.

Calling up Mercedes-Benz Link sound settings

Multimedia system:

 **▶▶ Settings ▶▶ System ▶▶ Audio**

- ▶ Select the sound settings.

Ending Mercedes-Benz Link

- ▶ Disconnect the connecting cable between Mercedes-Benz Link and the multimedia system.

or

- ▶ Select the  Mercedes symbol next to the device name for Mercedes-Benz Link in the device manager.

- ⓘ Mercedes-Benz recommends disconnecting the connecting cable only when the vehicle is stationary.

Apple CarPlay®

Overview of Apple CarPlay®

⚠ WARNING Risk of distraction from information systems and communications equipment

If you operate information and communication equipment integrated in the vehicle when driving, you will be distracted from the traffic situation. This could also cause you to lose control of the vehicle.

- ▶ Only operate this equipment when the traffic situation permits.
- ▶ If you cannot be sure of this, stop the vehicle whilst paying attention to road and traffic conditions and operate the equipment with the vehicle stationary.

You must observe the legal requirements for the country in which you are currently driving when operating the multimedia system.

iPhone® functions can be used via the multimedia system using Apple CarPlay®. They are operated using the touchscreen, Touch Control or the

Siri® voice-operated control system. You can activate the voice-operated control system by pressing and holding the  button on the multifunction steering wheel.

- ⓘ By briefly pressing the button on the multifunction steering wheel you can continue to operate the multimedia system using the MBUX Voice Assistant (→ page 286).

Only one iPhone® at a time can be connected via Apple CarPlay® with the multimedia system.

Also for use of Apple CarPlay® with two phone mode, only one additional mobile phone can be connected using Bluetooth® with the multimedia system.

The full range of functions for Apple CarPlay® is only available with an Internet connection.

The availability of Apple CarPlay® may vary according to the country.

The service provider is responsible for this application and the services and content connected to it.

Apple CarPlay® is a registered trademark of Apple Inc.

Information on Apple CarPlay®

The CarPlay® symbol in the status line switches within Apple CarPlay® to the last active display.

If route guidance is active on the multimedia system, it is closed when route guidance is started on the mobile phone.

Connecting an iPhone® via Apple CarPlay® (cable)

Requirements:

The current version of your device's operating system is being used (see the manufacturer's operating instructions).

- ▶ Connect the iPhone® to a USB port on the multimedia system using a suitable cable (→ page 425).
When the application is connected for the first time, a message about data protection regulations appears.
- ▶ If the application should be started, select **Accept & start**.

or

- ▶ Connect the desired iPhone® with the multimedia system via the device manager (→ page 374).

- ▶ Start Apple CarPlay® using the relevant symbol next to the device name.

- ⓘ If applicable, a message about data protection regulations appears.

Exiting Apple CarPlay®

- ▶ Select .

or

- ▶ Press the  button on the multifunction steering wheel (MBUX multimedia system).

- ⓘ If Apple CarPlay® was not displayed in the foreground before disconnecting, the application starts in the background when reconnected. You can call up Apple CarPlay® using the CarPlay® symbol in the status line.

Connecting an iPhone® via Apple CarPlay® (wireless)

Requirements:

- The current version of your device's operating system is being used (see the manufacturer's operating instructions).
- Bluetooth® is activated on the device (see the manufacturer's operating instructions).
- The device is "visible" for other devices.

Multimedia system:

- ➔  ➔ **Phone** ➔ **Settings**
➔ **Device manager** ➔ **Connect new device**

- ▶ Connect the mobile phone using Bluetooth® (→ page 373).
When the application is connected for the first time, a message about data protection regulations appears.
- ▶ If the application should be started, select **Accept & Start Apple Car Play**.
- ▶ If required confirm the use of Apple CarPlay® on your iPhone®.

- ⓘ The first activation of Apple CarPlay® on the multimedia system must be carried out when the vehicle is stationary for safety reasons.

- ❗ It is possible at any time to switch between connection via Bluetooth® or Apple CarPlay® (wireless) in the device list.
- ❗ If you have already connected a mobile phone via Bluetooth®, you can connect another iPhone® via Bluetooth® to use Apple CarPlay® via the device manager.

Exiting Apple CarPlay®

- ▶ Select .

or

- ▶ Press the  button on the Touch Control (MBUX multimedia system).

- ❗ If Apple CarPlay® was not displayed in the foreground before disconnecting, the application starts in the background when reconnected. You can call up Apple CarPlay® using the CarPlay® symbol in the status bar.

Calling up Apple CarPlay® sound settings

Multimedia system:

- ▶  ▶ Settings ▶ System ▶ Audio

- ▶ Select the sound settings.

Ending Apple CarPlay®

- ▶ Select the CarPlay® symbol in the device manager (telephone, media) that is next to the device name of the iPhone®.
- ❗ Select the CarPlay® symbol in the device manager in the telephone or media applications if CarPlay® should be restarted.
- ❗ If CarPlay® was not displayed in the foreground before disconnecting, the application starts in the background the next time it is started automatically. You can call up CarPlay® using the relevant symbol in the status line.

Android Auto

Android Auto overview

⚠ WARNING Risk of distraction from information systems and communications equipment

If you operate information and communication equipment integrated in the vehicle

when driving, you will be distracted from the traffic situation. This could also cause you to lose control of the vehicle.

- ▶ Only operate this equipment when the traffic situation permits.
- ▶ If you cannot be sure of this, stop the vehicle whilst paying attention to road and traffic conditions and operate the equipment with the vehicle stationary.

You must observe the legal requirements for the country in which you are currently driving when operating the multimedia system.

Mobile phone functions can be used with Android Auto using the Android operating system on the multimedia system. It is operated using the touchscreen or the voice-operated control system. You can activate the voice-operated control system by pressing and holding the  button on the multifunction steering wheel.

- ❗ By briefly pressing the button on the multifunction steering wheel you can continue to operate the multimedia system using the MBUX Voice Assistant (→ page 286).

Only one mobile phone at a time can be connected via Android Auto with the multimedia system.

Also for use of Android Auto with two phone mode, only one additional mobile phone can be connected using Bluetooth® with the multimedia system.

The full range of functions for Android Auto is only possible with an Internet connection.

The availability of Android Auto and Android Auto apps may vary according to the country.

The service provider is responsible for this application and the services and content connected to it.

Information on Android Auto

The Android Auto symbol in the status line switches within Android Auto to the last active display.

If route guidance is active on the multimedia system, it is closed when route guidance is started on the mobile phone.

Connecting a mobile phone via Android Auto Requirements:

- The mobile phone supports Android Auto from Android 5.0.
- The current version of the Android Auto app is installed on the mobile phone.
- In order to use the telephone functions, the mobile phone must be connected to the multimedia system via Bluetooth® (→ page 373).

If there was no prior Internet connection, this is established with the use of the mobile phone with Android Auto.

- ▶ Connect the mobile phone to a USB port on the multimedia system using a suitable cable (→ page 425).

When the application is connected for the first time, a message about data protection regulations appears.

- ▶ If the application should be started, select **Accept & start**.

or

- ▶ Connect the desired mobile phone with the multimedia system via the device manager (→ page 374).

- ▶ Start Android Auto using the relevant symbol next to the device name.

- ⓘ The first activation of Android Auto on the multimedia system must be carried out when the vehicle is stationary for safety reasons.

Exiting Android Auto

- ▶ Select .

or

- ▶ Press the  button on the Touch Control (MBUX multimedia system).

- ⓘ If Android Auto was not displayed in the foreground before disconnecting, the application starts in the background when reconnected. You can call up Android Auto using the Android Auto symbol in the status bar.

Connecting a mobile phone via Android Auto (wireless)

Requirements:

- The current version of your device's operating system is being used (see the manufacturer's operating instructions).

- The device supports the Android Auto wireless function.
- Bluetooth® is activated on the device (see the manufacturer's operating instructions).
- The device is "visible" for other devices.

Multimedia system:

  **▶▶ Phone ▶▶ Settings**

▶▶ Device manager ▶▶ Connect new device

▶ Connect the mobile phone using Bluetooth® (→ page 373).

i Depending on the device configuration, the query whether Android Auto should be started appears in the media display after connecting the mobile phone via Bluetooth®. In this case, the query must be answered with **Yes**.

▶ Select **Start Android Auto** .

When the application is connected for the first time, a message about data protection regulations appears.

▶ Select **Accept & start**.

i The first activation of Android Auto on the multimedia system must be carried out when the vehicle is stationary for safety reasons.

i It is possible at any time to switch between connection via Bluetooth® or Android Auto (wireless) in the device list.

i If you have already connected a mobile phone via Bluetooth®, you can connect another mobile phone via Bluetooth® to use Android Auto via the device manager.

Exiting Android Auto

▶ Select .

or

▶ Press the  button on the Touch Control (MBUX multimedia system).

i If Android Auto was not displayed in the foreground before disconnecting, the application starts in the background when reconnected. You can call up Android Auto using the Android Auto symbol in the status bar.

Calling up the Android Auto sound settings

Multimedia system:

  **▶▶ Settings ▶▶ System ▶▶ Audio**

▶ Select the sound settings.

Ending Android Auto

▶ Select the Android Auto symbol in the device manager (telephone, media) that is next to the device name of the mobile phone.

i Select the Android Auto symbol in the device manager if Android Auto should be restarted.

i If Android Auto was not displayed in the foreground before disconnecting, the application starts in the background the next time it is started automatically. You can call up Android Auto using the Android Auto symbol in the status line.

Transferred vehicle data with Android Auto and Apple CarPlay®

Overview of transferred vehicle data

When using Smartphone Integration, certain vehicle data is transferred to the mobile phone. This enables you to get the best out of selected

mobile phone services. Vehicle data is not directly accessible.

The following system information is transmitted:

- Software release of the multimedia system
- System ID (anonymised)

The transfer of this data is used to optimise communication between the vehicle and the mobile phone.

To do this, and to assign several vehicles to the mobile phone, a vehicle identifier is randomly generated.

This has no connection to the vehicle identification number (VIN) and is deleted when the multimedia system is reset (→ page 330).

The following driving status data is transmitted:

- Transmission position engaged
- Distinction between parked, standstill, rolling and driving
- Day/night mode of the instrument cluster

The transfer of this data is used to alter how content is displayed to correspond to the driving situation.

The following position data is transmitted:

- Coordinates
- Speed
- Compass direction
- Acceleration direction

This data is used by the mobile phone to improve the accuracy of the navigation (e.g. for continuation in a tunnel).

Mercedes me calls

Making a call via the overhead control panel

- i** Mercedes me calls are not possible in every country. Find out at a Mercedes-Benz service centre if these functions are available in your country.

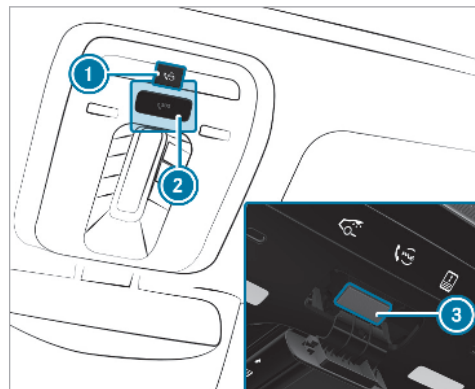

- ① me button for service, concierge (if available) or information calls
- ② SOS button cover
- ③ SOS button (emergency call system)

▶ **To make a Mercedes me call:** press me button ①.

▶ **To make an emergency call:** press SOS button cover ② briefly to open.

- ▶ Press and hold SOS button  for at least one second.

If a Mercedes me call is active, an emergency call can still be triggered. This has priority over all other active calls.

Information about the Mercedes me call using the me button

A call to the Mercedes-Benz Customer Centre has been initiated via the me button in the overhead control panel or the multimedia system (→ page 400).

Using the voice dialogue system you access the desired service:

- Concierge Service (if the service is available and activated)
- Accident and Breakdown Management
- Mercedes-Benz Customer Centre for general information about the vehicle

You can find information on the following topics:

- Activation of Mercedes me connect
- Operating the vehicle
- Nearest Mercedes-Benz service centre

- Other products and services from Mercedes-Benz

Data is transferred during the connection to the Mercedes-Benz Customer Centre (→ page 403).

Calling the Mercedes-Benz Customer Centre using the multimedia system

Requirements:



- Access to a GSM network is available.
- The contract partner's GSM network coverage is available in the respective region.
- The ignition must be switched on so that vehicle data can be transferred automatically.

Multimedia system:



- ▶ Call [Mercedes me connect](#). After confirmation, the multimedia system sends the required vehicle data. The data transfer is shown in the central display.

Then, you can select a service and be connected to a specialist at the Mercedes-Benz Customer Centre.

-  In some countries, or if the Concierge Service is active, you will be connected directly with the Mercedes-Benz Customer Centre.
-  The Concierge Service is not available in all countries. More information about Mercedes me connect services can be obtained in the Mercedes me Portal: <https://me.secure.mercedes-benz.com>

Calling the Mercedes-Benz Customer Centre after automatic accident or breakdown detection

Requirements:

- The vehicle has detected an accident or breakdown situation.
 - The vehicle is stationary.
 - The hazard warning lights are switched on.
-  This function is not available in all countries. The vehicle can detect accident or breakdown situations under certain circumstances.

In the event an accident or breakdown is detected, the emergency guide shows safety notes in the multimedia system display.

After quitting the emergency guide display on the multimedia system, a prompt appears asking whether you wish to get support from the Mercedes-Benz Customer Centre.

▶ Select **Call**.

- After your agreement, or if the Mercedes me connect service "Accident and Breakdown Management" is active, the vehicle data is transferred automatically (→ page 405).
- The Mercedes-Benz Customer Centre takes your call and organises the breakdown and accident assistance.

You may be charged for these services.

- ⓘ Depending on the severity of the accident, an automatic emergency call can be initiated. This has priority over all other active calls.
- ⓘ In addition, if the Mercedes me connect service "Telediagnosics" is active, a similar prompt can appear after a delay in the event of a breakdown. If you are already in contact with the Mercedes-Benz Customer Centre or

have already received support, this prompt can be ignored or declined.

- ⓘ If you answer the prompt for support from the Mercedes-Benz Customer Centre with **Call later**, the message will be hidden and appear again later. The prompt triggered by the Mercedes me connect service "Telediagnosics", can either be confirmed or declined. After being declined, this will not be shown again.

Arranging a service appointment via a Mercedes me call

If you have activated the maintenance management service, relevant vehicle data is transferred automatically to the Mercedes-Benz Customer Centre. You will then receive individual recommendations regarding the maintenance of your vehicle.

Regardless of whether you have consented to the maintenance management service, the multimedia system reminds you after a certain amount of time that a service is due. A prompt appears asking if you would like to make an appointment.

▶ **To arrange a service appointment:** select **Call**.

After your agreement, the vehicle data is transferred and the customer centre takes your preferred appointment date. The information is then sent to your desired service outlet.

This will contact you to confirm the appointment and if necessary consult about the details.

- ⓘ If you select **Call later** after the service message appears, the message is hidden and reappears at a later time.

Giving consent to data transfer during a Mercedes me call

Requirements:

- There is an active Mercedes me call via the multimedia system or the me button in the overhead control panel .
- ⓘ The prompt to confirm data transfer does not appear in all countries.

If the accident and breakdown service and Mercedes me connect Concierge Service (if

available) are not activated on Mercedes me, the [Do you want to transmit vehicle data and the vehicle's position to the Mercedes-Benz Customer Centre in order to improve the processing of your request?](#) message appears.

- ▶ Select **Yes**.
Relevant identification data is transmitted automatically.

More information on Mercedes me: <http://www.mercedes.me>

Transferred data during a Mercedes me call

If you initiate a service call using Mercedes me, data is transferred to enable targeted advice and an efficient service.

The following requirements must be fulfilled for the transfer of the data:

- The ignition is switched on.
- The required data transfer technology is supported by the mobile service operator.
- The quality of the mobile connection is sufficient.

Multi-stage transfer depends on the following factors:

- Reason for the initiation of the call
 - The available mobile phone transmission technology.
 - The activated Mercedes me connect services.
 - The service selected in the voice control system.
- ⓘ A prompt for consent to the data transmission only occurs if the corresponding Mercedes me connect service is not activated.

Data transfer if Mercedes me connect services are not activated

If no Mercedes me connect services are activated and the data protection prompt has been confirmed the following data is transmitted:

- Vehicle identification number
- Time of the call
- Reason for the initiation of the call
- Confirmation of the data protection prompt

- Country indicator of the vehicle
- Set multimedia systems
- Telephone number of the communication platform installed in the vehicle

If a call is made for a service appointment via the service reminder, the following data is also transmitted:

- Current mileage and maintenance data

If a call is made after automatic accident or breakdown detection using the multimedia system, the following data is also transmitted:

- Current mileage and maintenance data
- Current vehicle location

If Accident and Breakdown Management is called via the voice control system and no service has been activated, but the data protection query has been confirmed, the following data can also be called up from the vehicle by the Mercedes-Benz Customer Centre:

- Current vehicle location

If the data protection prompt has been rejected, the following data is transmitted to enable targeted advice and an efficient service:

- Reason for the initiation of the call
- Rejection of the data protection prompt
- Country indicator of the vehicle
- Set language for the multimedia system
- Telephone number of the communication platform installed in the vehicle

Data transfer if Mercedes me connect services are activated

Only if the respective service is activated will additional incident-specific data be transmitted in the second stage to enable an optimal service.

An overview of the data transmitted can be found in the respective terms of use for Mercedes me connect services. These can be obtained in the Mercedes me Portal: <https://me.secure.mercedes-benz.com>

Data processing

The data transmitted within the scope of the call is deleted from the processing system after the

call is finished, in so far as this data is not being used for other activated Mercedes me connect services.

The incident-specific data is processed and stored in the Mercedes-Benz Customer Centre and, if required to process the incident, forwarded to the service partner authorised by the Mercedes-Benz Customer Centre. Please take note of the data protection information on the Mercedes me Internet page at <https://www.mercedes.me> or in the recorded message immediately after calling the Mercedes-Benz Customer Centre.

- ❗ The recorded message is not available in every country.

Mercedes me connect

Information on Mercedes me connect

- ❗ Mercedes me connect or individual Mercedes me connect services are not available in every country. Find out at a Mercedes-Benz service centre if these functions are available in your country.

Mercedes me connect consists of multiple services.

Depending on whether the services are activated and on the vehicle equipment, you can use the following services via the multimedia system and the overhead control panel, for example:

- Accident and Breakdown Management (me button or situation-dependent display in the multimedia system)
- Concierge Service (me button)
- Mercedes-Benz emergency call system (automatic emergency call and SOS button)

Mercedes me connect Accident and Breakdown Management, the Mercedes me connect Concierge Service (if service is available and activated) and the Mercedes-Benz emergency call centre are available for you around the clock.

The me button and the SOS button can be found on the vehicle's overhead control panel (→ page 400).

You can also call the Mercedes-Benz Customer Centre using the multimedia system (→ page 401).

Please note that Mercedes me connect is a Mercedes-Benz service. In emergencies, initially call the standard national emergency service telephone numbers. In emergencies, you can also use the Mercedes-Benz emergency call system (→ page 409).

Observe the conditions of use for Mercedes me connect and other services. These can be obtained in the Mercedes me Portal: <https://me.secure.mercedes-benz.com>

Further information about Mercedes me connect, the provided service scope and operation: https://moba.i.daimler.com/markets/ece-row/baix/cars/connectme/en_GB/#emotions/Startseite.html

Information on Mercedes me connect Accident and Breakdown Management

The Accident and Breakdown Management can include the following functions:

- Supplement to the Mercedes-Benz emergency call system (→ page 409)
If necessary, the contact person at the Mercedes-Benz emergency call centre forwards the call to Mercedes me connect

breakdown and accident management. Forwarding the call is however not possible in all countries.

- Breakdown assistance by a technician on location and/or the towing away of the vehicle to the nearest Mercedes-Benz service centre

You may be charged for these services.

- Addition to the emergency guide after automatic accident or breakdown detection (→ page 401)

In the event of a breakdown or accident, further data about the status of the vehicle is sent which enables optimal support by the Mercedes-Benz Customer Centre and the authorised service partner or breakdown assistance.

- Addition to the Mercedes me connect service Telediagnosics

With the Telediagnosics function, specific wear and failure reports are recorded by the service provider, in so far as these can be clearly interpreted and are available through

the monitoring of components that are subject to diagnostics.

Should vehicle conditions indicate a breakdown or an impending breakdown, after stopping the vehicle you could receive a request via the multimedia system to contact the Mercedes-Benz Customer Centre in order to receive assistance.

- ⓘ These services are subject to technical restrictions such as the mobile phone coverage, mobile network quality and the ability of the processing systems to interpret the transferred data. In some circumstances, this can result in delays or the failure of the information to appear in the multimedia system.

More information about Mercedes me connect services can be obtained in the Mercedes me Portal: <https://me.secure.mercedes-benz.com>

Data transferred during Mercedes me connect call services

The data transferred during a Mercedes me connect call depends on the reason the call was initiated, which service is selected in the voice

control system and which Mercedes me connect services are activated.

Which data is transferred for the services can be taken from the currently valid terms of use. These can be obtained in the Mercedes me portal: <https://me.secure.mercedes-benz.com>

Mercedes me and apps

Information about Mercedes me

When you log in with a user account to the Mercedes me Portal, then services and offers from Mercedes-Benz will be available to you.

Availability is country-dependent.

For more information consult a Mercedes-Benz service centre or visit the Mercedes me Portal: <http://me.secure.mercedes-benz.com>

- ❗ Make sure you always keep the Mercedes me apps updated.

Calling up the Mercedes me user account

Multimedia system:

➔  ➔ Mercedes me & Apps

Your vehicle is linked to the user account

- ▶ Select [Mercedes me](#).
Information about the connected user account appears.

Your vehicle is not yet connected with a user account

- ❗ If you do not yet have a Mercedes me user account, you can set up a user account via the Mercedes me Portal or using the Mercedes me app with your mobile phone.
- ▶ Select [Mercedes me](#).
- ▶ Follow the instructions on the central display to link the user account with the vehicle.
- ❗ If the Mercedes me app is available on a mobile phone, the vehicle connection can be accomplished using the QR code shown.

Calling up the Mercedes me services

Requirements:

- The vehicle is connected with the user account.

Multimedia system:

➔  ➔ Mercedes me & Apps

- ▶ Select [My services](#).
You can see the Mercedes me services in alphabetical order that you have already purchased and also those still available to purchase.
To activate or deactivate the services, log in to your user account in the Mercedes me Portal or in the Mercedes me app using your mobile phone.

Deleting a connection between a user account and the vehicle

Requirements:

- The (vehicle) profile of the user account that was first connected with the vehicle is selected.
- The profile is synchronised (→ page 299).
- A PIN has been set.

Multimedia system:

➔  ➔ Mercedes me & Apps
➔ Mercedes me

- ▶ Select **My Mercedes me Account**.
- ▶ Select **Delete vehicle connection**.
- ▶ Enter the PIN of the connected user account.
- ⓘ Only the user, whose user account was first connected with the vehicle can delete the connection between all user accounts and the vehicle.

Mercedes-Benz emergency call system

Information on available emergency call systems

Two types of emergency call system are available to you in the vehicle:

- Mercedes-Benz emergency call system

- 112 emergency call system (EU eCall)

The Mercedes-Benz emergency call system is not available in all countries. You can find more information on the regional availability of eCall at: <https://www.mercedes-benz-mobile.com/extra/ecall/>

The following applies for both emergency call systems:

- The transfer of specific data is required for the intended function of both emergency call systems. This will be explained in the "Data transfer" section (→ page 410).
- Both emergency call systems are included as standard equipment in your vehicle and are activated at the factory.
- The use of both emergency call systems is exempt from charges.

- Both emergency call systems only function in areas in which the wireless service providers offer mobile phone coverage.

For both systems, insufficient network coverage from the wireless service providers can result in an emergency call not being transmitted.

Differences between the Mercedes-Benz emergency call system and the 112 emergency call system (EU eCall)

Mercedes-Benz emergency call system	112 emergency call system (EU eCall)
<ul style="list-style-type: none"> The Mercedes-Benz emergency call system is permanently logged in to the mobile phone network. Automatic and manual Mercedes-Benz emergency calls are transmitted to a Mercedes-Benz emergency call centre. <p>In the event that the emergency call centre of the Mercedes-Benz emergency call system cannot be reached (e.g. due to a lack of network coverage), the 112 emergency call is carried out automatically.</p>	<ul style="list-style-type: none"> If you decide on the 112 emergency call system (EU eCall) only, then the system only logs in to the mobile phone network after the triggering of a manual or automatic emergency call. The 112 emergency call system (EU eCall) transmits automatic and manual emergency calls directly to public coordination centres.

i The 112 emergency call system (EU eCall) in your vehicle meets the delegated regulation EU 2017/79. Proper and full functionality of the 112 emergency call system (EU eCall) depends on circumstances beyond the influence of Daimler AG. This includes mobile network coverage and the technical infrastructure of the public reception centres in the respective countries.

i Please observe that in the event of a repair genuine Mercedes-Benz batteries must be used which have been certified pursuant to the delegated regulation EU 2017/79

(Appendix I). Other manufacturers are also permitted provided their batteries are certified according to the delegated regulation EU 2017/79.

There is the option of deactivating the Mercedes-Benz emergency call system and using only the 112 emergency call system (EU eCall). Contact address for carrying out deactivation of the Mercedes-Benz emergency call system are the local dealers.

Mercedes-Benz recommends the activation of the Mercedes-Benz emergency call system for the following reasons:

- In emergency situations when abroad, you can also get support in a language you speak.
- Several transmission technologies are used to accelerate the transfer of the accident data and improve reliability of the transmission.
- The Mercedes-Benz emergency call system is permanently logged in to the mobile phone

network, which ensures faster placement of the emergency call and faster transfer of the accident data.

Measures for rescue, recovery or towing away can then be initiated quickly.

- With a Mercedes-Benz emergency call, the accident data is only transferred to the public coordination centre with the approval of the customer.

In the event of an automatically triggered emergency call in which there is no voice contact, the accident data is transmitted immediately to the public emergency call centre.

- Should the Mercedes-Benz emergency call centre not be available, the 112 emergency call is carried out automatically.

Overview of emergency call systems

Both the Mercedes-Benz emergency call system as well as the 112 emergency call system (EU eCall) can help to reduce the time between an accident and the arrival of emergency services at the site of the accident. They help locate an

accident site in places that are difficult to access.

Both emergency call systems can initiate an emergency call automatically (→ page 409) or manually.

Only make emergency calls if you or others are in need of rescue. Do not make an emergency call in the event of a breakdown or a similar situation.

Messages on the display

The following messages appear in the display of both emergency call systems:

- **SOS NOT READY**: the ignition is not on or eCall is not available. This does not necessarily indicate complete failure of the emergency call system. Emergency calls will still be transmitted.

The display only refers to the vehicle and does not take account of the availability of mobile phone networks and the Mercedes-Benz emergency call centre.

The functional readiness of the emergency call system on the vehicle can be seen when

the **SOS NOT READY** display disappears once the ignition is switched on.

- : The icon appears in the display during an active emergency call.
- ⓘ If there is an emergency call system malfunction (e.g. a fault in the loudspeaker, microphone, airbag, SOS button) a relevant message appears in the driver display of the instrument cluster.

Triggering an automatic emergency call Requirements:

- The ignition is switched on.
- The starter battery is sufficiently charged.

Both the Mercedes-Benz emergency call system as well as the 112 emergency call system (EU eCall) automatically initiate an emergency call in the following situations:

- After activation of the restraint systems such as airbags or seat belt tensioners after an accident.
- After an automatically initiated emergency stop by Active Emergency Stop Assist.

The emergency call has been made:

- A voice connection is established with the emergency call centre.
- A message with accident data is transmitted to the emergency call centre.

The SOS button in the overhead control panel flashes until the emergency call is finished.

If no connection can be made to the public emergency services, a corresponding message appears in the display.

▶ Dial the **112** emergency number or an appropriate local emergency call number on your mobile phone.

If an emergency call has been initiated:

- Remain in the vehicle if the road and traffic conditions permit you to do so until a voice connection is established with the emergency call centre.
- On the basis of the call, the emergency call centre decides whether it is necessary to call

rescue teams and/or the police to the accident site.

- If no vehicle occupant answers, an ambulance is sent to the vehicle immediately.

Triggering a manual emergency call

▶ **To use the SOS button in the overhead control panel:** press the SOS button at least one second long .

or

▶ **To use the voice control:** use the voice commands of the MBUX Voice Assistant .

The emergency call has been made:

- A voice connection is established with an emergency call centre.
- Remain in the vehicle if the road and traffic conditions permit you to do so until a voice connection is established with the emergency call centre.
- On the basis of the call, the emergency call centre decides whether it is necessary to call

rescue teams and the police to the accident site.

- A message with accident data is transmitted to the emergency call centre.

If no connection can be made to the public emergency services, a corresponding message appears in the central display.

▶ Dial the **112** emergency number or an appropriate local emergency call number on your mobile phone.

Emergency call system data transmission

For both the Mercedes-Benz emergency call system as well as the 112 emergency call system (EU eCall) data is transferred to the Mercedes-Benz emergency call centre or the public emergency services call centre.

Depending on the emergency call system (→ page 407) activated different data is transmitted to the appropriate emergency call centre.

Transmitted data according to activated emergency call system:

Mercedes-Benz emergency call	112 emergency call
<ul style="list-style-type: none"> • Position data of the vehicle • Position data on the route (a few 100 m before the incident) • Direction of travel • Vehicle identification number • Drive type of the vehicle (e.g. petrol, diesel, CNG, LPG, electric or hydrogen) • Number of people determined to be in the vehicle • Whether the emergency call was initiated manually or automatically • Time of the accident • Language setting on the multimedia system • Whether Mercedes me connect is available or not <p>This is a requirement for the option of forwarding the call to the Mercedes-Benz Customer Centre if necessary.</p>	<ul style="list-style-type: none"> • Position data of the vehicle • Position data on the route (a few 100 m before the incident) • Direction of travel • Vehicle identification number • Drive type of the vehicle (e.g. petrol, diesel, CNG, LPG, electric or hydrogen) • Number of people determined to be in the vehicle • Whether the emergency call was initiated manually or automatically • Time of the accident

i If only the 112 emergency call system (EU eCall) is activated in the vehicle, the accident data is transmitted directly to the public emergency call centre.

For accident clarification purposes, the following measures can be taken up to an hour after the emergency call has been initiated:

- The current vehicle position can be determined.
- A voice connection to the vehicle occupants can be established.
- Emergency call data can be called up.

 For Russia: various functions, e.g. receiving traffic information, cannot be performed for up to two hours after sending an emergency call.

Function of the emergency call system self-diagnosis (Russia)

Your car verifies the operability of the emergency call system each time the ignition is ON. In case of system failure, you will be informed with text message on the instrument cluster and with red indicator **SOS NOT READY** on the display.



Please, make sure, that during 30 seconds after switching ignition ON the red indicator **SOS NOT READY** in the upper right corner of display

is switched OFF, this means the emergency call system passed diagnostics successfully.

Starting/ending ERA-GLONASS test mode (Russia)

Requirements:

- The starter battery is sufficiently charged.
- The ignition is switched on.
- The vehicle has been stationary for at least one minute.

 **To start the test mode:** press and hold the  button on the multifunction steering wheel for at least five seconds.

The test mode is started and automatically ends after the language test has been performed.

 **To end the test mode manually:** switch off the ignition.
The test mode is ended.

Information on data processing

Processing of personal data via the Mercedes-Benz emergency call system

All processing of personal data via the Mercedes-Benz emergency call system corresponds with the specifications in the EU Regulation 2016/679 "on the protection of individuals with regard to the processing of personal data (GDPR)".

The data is solely used by the Mercedes-Benz emergency call system for rescue and recovery in the event of an accident.

The owner of a vehicle, that is equipped with a Mercedes-Benz emergency call system in addition to the 112 emergency call system (EU eCall), has the right to use the 112 emergency call system instead of the Mercedes-Benz emergency call system.

Contact address for carrying out deactivation of the Mercedes-Benz emergency call system are the local dealers.

Processing of personal data via the 112 emergency call system (EU eCall)

All processing of personal data via the 112 emergency call system (EU eCall) corresponds with the specifications in the EU Regulation 2016/679 "on the protection of individuals with regard to the processing of personal data (GDPR)" and is based particularly on the necessity of upholding the vital interests of the affected person in accordance with Article 6, Clause 1, Letter d of the GDPR.

The processing of this type of data is strictly limited to the purpose of operating the emergency calls to the standard European emergency call number 112.

Data recipient

The recipients of data that is processed using the 112 emergency call system (EU eCall) are the relevant emergency call inquiry terminals that are specified to first receive and handle emergency calls to the standard European emergency call number 112 by the respective country authorities in whose territory you are located.

Arrangements for data processing

Both emergency call systems are designed so that the following requirements are fulfilled:

- The data contained in the system memory is not accessible outside the system prior to the initiation of an emergency call.
- Both emergency call systems cannot be traced and there is no continuous tracking in normal operation.
- The data in the system's internal memory is automatically and continuously deleted.
- The location data of the vehicle is continuously overwritten in the system's internal memory, so that no more than the last three current locations required for the normal function of the system are available.
- The record of the activity data of both emergency call systems is only kept for as long as is required to fulfil the purpose of handling the emergency call, and under no circumstances for more than 13 hours after the time that an emergency call is initiated.

Rights of persons affected by the data processing

The person affected by the data processing (the vehicle owner) has the right to access the data and if applicable can demand the correction, deletion or barring of data that affects him or her and that the processing of which does not correspond with the GDPR regulations. Each correction, deletion or barring carried out according to this regulation must be shared with the third party to which the data has been transmitted, provided this does not prove to be infeasible and does not incur disproportionate expenditure.

The person affected by the data processing has the right to complain to the appropriate data protection authority should they be of the opinion that their rights have been infringed by the processing of their personal data.

Responsible contact point for the processing of access rights: Konzernbeauftragter für den Datenschutz, Daimler AG, HPC G353, D-70546 Stuttgart, Germany

Online and Internet functions

Internet connection

Information on connecting to the Internet

- ⚠ WARNING** Risk of distraction from information systems and communications equipment

If you operate information and communication equipment integrated in the vehicle when driving, you will be distracted from the traffic situation. This could also cause you to lose control of the vehicle.

- ▶ Only operate this equipment when the traffic situation permits.
- ▶ If you cannot be sure of this, stop the vehicle whilst paying attention to road and traffic conditions and operate the equipment with the vehicle stationary.

You must observe the legal requirements for the country in which you are currently driving when operating the multimedia system.

- ⚠ WARNING** Risk of an accident from operating mobile communication equipment while the vehicle is in motion

Mobile communications devices distract the driver from the traffic situation. This could also cause the driver to lose control of the vehicle.

- ▶ As the driver, only operate mobile communications devices when the vehicle is stationary.
- ▶ As a vehicle occupant, only use mobile communications devices in the areas intended for this purpose, e.g. in the rear passenger compartment.

You must observe the legal requirements for the country in which you are currently driving when operating mobile communication equipment in the vehicle.

Depending on the vehicle's equipment and availability in the country, you can establish an Internet connection in the following ways:

- **Vehicles with a communication module:**

- Using the communication module including data roaming
- Using Bluetooth® or Wi-Fi with a data-enabled mobile phone

- **Vehicles without a communication module:**

- Using Bluetooth® with a data-enabled mobile phone
- Using Wi-Fi with a data-enabled mobile phone

- **Vehicles with "car telephony" equipment:** using the data-enabled car phone or the data-enabled SIM card (→ page 417)

The Internet functions can only be used to a limited degree whilst driving.

Setting up an Internet connection using the communication module

Requirements:

- The vehicle is equipped with a permanently installed communication module.
- A Mercedes me account is available.

Multimedia system:

→  » Settings » System
» Internet and Bluetooth » Internet

- ▶ Select **Establishing Internet connection... Mercedes me connect** in the Internet device manager.

For most Mercedes me connect services, data volume is available when purchasing the services.

To use some functions, e.g. web browser, Internet Radio or Wi-Fi hotspot, additional data volume is required.

If the data volume limit is reached, the availability of Mercedes me connect services is limited. The data volume can be purchased **directly from a mobile phone network provider** via the Mercedes me Portal.

- ① Visit a Mercedes-Benz service centre to find out whether it is possible to purchase data volume in your country **directly from a mobile phone network provider**.
- ① Alternatively, and if available, you can utilise the tethering function of a mobile phone via

Wi-Fi or Bluetooth® to use the web browser, Internet radio or Wi-Fi hotspot.

Automatic Internet connection via communication module

Requirements:

- Wi-Fi - or Bluetooth® tethering or car telephony are available in the vehicle.

Multimedia system:

→  » Settings » System
» Internet and Bluetooth » Internet

- ▶ Select **Establishing Internet connection... Mercedes me connect**.
- ▶ Select settings  in the line of **Establishing Internet connection... Mercedes me connect**.
- ▶ **To always connect automatically:** activate the **Connect automatically** option. The communication module is always used for the Internet connection. The data volume that has been purchased directly from a mobile phone network provider via the Mercedes me Portal is used.

- ① If other Wi-Fi - or Bluetooth® devices are listed for selection in the Internet device manager, these can be selected manually for Internet use regardless of the activated setting **Connect automatically**. Please note that despite the activated setting **Connect automatically**, a previously connected Wi-Fi - or Bluetooth® device can be connected automatically as this has been prioritised by the system.

- ▶ **To connect manually:** deactivate the **Connect automatically** option. The communication module is shown in the Internet device manager as an available option for Internet use but it is not connected automatically. Other devices, if available, will be listed higher for selection as hotspot in the Internet device manager. The deactivated option allows the use of purchased data volume to be limited.

- ❗ If you wish to select the communication module for a single Internet sitting, you can tap on the hotspot [Establishing Internet connection... Mercedes me connect](#) in the Internet device manager without activating the [Connect automatically](#) setting.
- ❗ If the Internet connection in the vehicle is only supported using the communication module, the [Connect automatically](#) option is not available.

Setting up an Internet connection via Wi-Fi Requirements:

- the Wi-Fi function is activated on the multimedia system (→ page 325).
- the Wi-Fi function is activated on the mobile phone (see the manufacturer's operating instructions).
- Internet access via Wi-Fi is activated (see the manufacturer's operating instructions).

The Internet connection via Wi-Fi is restricted or does not function if:

- the mobile phone is switched off

- mobile data use is deactivated on the mobile phone
- the Wi-Fi function is deactivated on the multimedia system
- the Wi-Fi function is deactivated on the mobile phone
- Internet access via Wi-Fi is deactivated on the mobile phone

Multimedia system:









- ▶ **The mobile phone is listed in the Internet device manager:** select the mobile phone with the  Wi-Fi symbol.
- ▶ **The mobile phone is not listed in the Internet device manager:** select [Search hotspots](#).
- ▶ Select the network.
- ▶ Log in to the Wi-Fi network (→ page 325).



Setting up an Internet connection via Bluetooth®

Requirements:

- The mobile phone supports the Bluetooth® profile PAN (**P**ersonal **A**rea **N**etwork).
- The mobile phone is connected to the multimedia system via Bluetooth® (→ page 373).

Multimedia system:





- ▶ **The mobile phone is listed in the Internet device manager:** select the mobile phone with the Bluetooth® symbol .
- ▶ **The mobile phone is not listed in the Internet device manager:** select [Search hotspots](#).
- ▶ Connect the mobile phone using Bluetooth®.
- ❗ If a new mobile phone is connected using Bluetooth®, this is also used for the telephone application.

The Internet connection via Bluetooth® is restricted or does not function in the following cases:

- the mobile phone is switched off
- the mobile phone network coverage is insufficient
- mobile data use is deactivated on the mobile phone
- the Bluetooth® function on the multimedia system is switched off and the mobile phone is to be connected via Bluetooth®
- the Bluetooth® function is switched off on the mobile phone and the mobile phone is to be connected via Bluetooth®
- neither the mobile phone network nor the mobile phone allow simultaneous use of a telephone and an Internet connection
- the mobile phone has not been enabled for Internet access via Bluetooth®







Setting up an Internet connection using car telephony

Requirements:

- **For use with a mobile phone:**

- The mobile phone supports the Bluetooth® SAP profile (**SIM Access Profile**) (see manufacturer's operating instructions).
- The mobile phone is switched on.
- The mobile phone is only connected as an SAP telephone and not in the Hands-Free Profile.
- **Using a SIM card:**
 - A SIM card is inserted in the card slot in the telephone module .
 - The SIM card PIN is entered in the multimedia system.

Multimedia system:

  **Settings**  **System**
 **Internet and Bluetooth**  **Internet**
 **Known hotspots:**







-  Select the car telephone from the list of the Internet device manager.



Changing the configuration of the car telephone for the Internet connection

Requirements:

- **For use with a mobile phone:**
 - The mobile phone supports the Bluetooth® SAP profile (**SIM Access Profile**) (see manufacturer's operating instructions).
 - The mobile phone is switched on.
 - The mobile phone is only connected as an SAP telephone and not in the Hands-Free Profile.
- **For use with a SIM card:**
 - A SIM card is inserted in the card slot in the telephone module .
 - The SIM card PIN is entered in the multimedia system.

Multimedia system:

  **Settings**  **System**
 **Internet and Bluetooth**  **Internet**
 **Known hotspots:**

-  Select Options  for the car telephone.
-  Select **Change configuration**.

▶ **To select the predefined access data of the mobile phone network provider:** select [Change provider settings](#).

▶ Check the access data in the overview. If the mobile phone network provider is recognised correctly, the correct settings are already entered. If the settings cannot be filled automatically, a list appears for manual selection of a mobile phone network provider.

▶ **To manually set the access data of the mobile phone network provider:** select the desired mobile phone network provider from the list.

❗ If no mobile phone network providers are recognised, empty fields appear for setting options which you should fill manually.

▶ Confirm the saving of the changes.

❗ To avoid possible additional costs, set the access data in the configuration settings, e.g. the [Roaming permitted](#) option, according to your data tariff. You can contact your mobile phone network provider to obtain the precise access data.

❗ Only for connections using the Bluetooth® SAP profile: if you use a mobile phone to provide the mobile hotspot for the vehicle, this telephone will no longer have any telephony and Internet functions and it cannot receive any more mobile phone data. To continue to use Internet functions on the mobile phone, you can connect it with the vehicle hotspot. In this way, the mobile phone accesses its own mobile phone data again, albeit using Wi-Fi. For this reason, to avoid possible additional costs, switch off the automatic download of software updates via Wi-Fi on your mobile phone.

Cancelling Internet access permission for a mobile phone

Multimedia system:

➔  ➔ [Settings](#) ➔ [System](#)
 ➔ [Internet and Bluetooth](#) ➔ [Set up](#)
 ➔ [Internet](#)

▶ Select options  next to the name of the mobile phone.

▶ Select [Delete configuration](#).

▶ Select [Ja](#) (Yes).

Establishing an Internet connection

Multimedia system:

➔  ➔ [Mercedes me & Apps](#)

▶ For example, select  [Browser](#).



❗ The multimedia system usually establishes the Internet connection automatically. If the multimedia system is not connected to the Internet, the Internet connection is established when an Internet application is used.

❗ The availability of web browsers is country-dependent.

Connection status

Connection status overview

Depending on the connection status, the following symbols can appear on the central display in the status line:

- : a Wi-Fi device is selected as hotspot.
- : a Bluetooth® device is selected as hotspot.

- 4G + double arrow symbol: the communication module is selected as hotspot.
- Reception field strength symbol: reception field strength of the communication module or the device selected as hotspot

Displaying the connection status

Multimedia system:

 Settings >> System

- ▶ Select **Internet and Bluetooth**.
The status information appears in the upper graphic area of the central display.
- When connected via Wi-Fi, a Bluetooth® device or a car telephone, the device name and the approximate data volume transmitted is displayed. The exact values can be requested from your mobile phone network provider.
- In the case of a connection via the communication module the following status information can be shown:
 - Type of network
 - Status (online, offline, data volumes available or used, limited service)

Web browser

Calling up a web page

⚠ WARNING Risk of distraction from information systems and communications equipment

If you operate information and communication equipment integrated in the vehicle when driving, you will be distracted from the traffic situation. This could also cause you to lose control of the vehicle.

- ▶ Only operate this equipment when the traffic situation permits.
- ▶ If you cannot be sure of this, stop the vehicle whilst paying attention to road and traffic conditions and operate the equipment with the vehicle stationary.

You must observe the legal requirements for the country in which you are currently driving when operating the multimedia system.

Multimedia system:

 Mercedes me & Apps >> 

Calling up a new web page

- ▶ Select **URL**.
- ▶ Entering a web address
- ▶ Select **ok**.
- ⓘ The function is country-dependent.
- ⓘ Websites cannot be shown while the vehicle is in motion.

Calling up a website from the browser history

- ▶ To call up the previous or next page from the history: select **←** or **→**.

Web browser overview

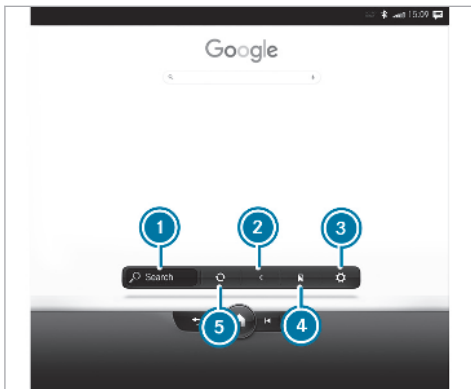

- ① Search
- ② Previous website
- ③ Options
- ④ Bookmarks
- ⑤ To refresh/stop

Calling up web browser options

Multimedia system:

- Home ➤ Mercedes me & Apps
- Browser ➤ ⚙️

The following functions are available:

- Bookmarks
- Options with the settings:
 - Browser settings
 - Delete browser data

- ▶ Select an option.
- ▶ Change the settings.

Calling up the web browser settings

Multimedia system:

- Home ➤ Mercedes me & Apps
- Browser ➤ ⚙️ ➤ Browser settings

- ▶ **To switch one of the displayed functions on:** activate the display button.
- ▶ **To switch one of the displayed functions off:** deactivate the display button.

Deleting Internet history

Multimedia system:

- Home ➤ Mercedes me & Apps
- Browser ➤ ⚙️ ➤ Browser data

- ▶ Select one of the options shown.

Managing bookmarks

Multimedia system:

- Home ➤ Mercedes me & Apps
- Browser

- ▶ Select .

Selecting a bookmark

- ▶ Select an entry.

Creating a bookmark

- ▶ Select **Add current page to bookmarks**.
The bookmark is created.

Editing a bookmark

- ▶ Select the pen symbol in top, right-hand corner.
- ▶ Select the pen symbol behind a bookmark again.



- ▶ Enter the name.
- ▶ Select **OK** on the input keyboard.

Deleting a bookmark

- ▶ Select the recycle bin symbol behind a bookmark.
- ▶ Select **Yes**.

Closing the browser

Multimedia system:

- ▶  **Mercedes me & Apps**
- ▶  **Browser**
- ▶ Select .

TuneIn radio

Calling up Internet Radio

Requirements:

- There is an account on <https://www.mercedes.me>.
- The Internet Radio service is activated.
- The data volume is available.

Depending on the country, data volume may need to be purchased.

- A fast Internet connection for data transmission free of interference.

- ⓘ The functions and services are country-dependent. For more information, consult a Mercedes-Benz service centre.

Multimedia system:

- ▶  **Radio**

- ▶ Select **TuneIn Radio**.
The Internet Radio menu appears. The last station set starts playing.

- ⓘ The connection quality depends on the local mobile phone reception.

Internet Radio overview

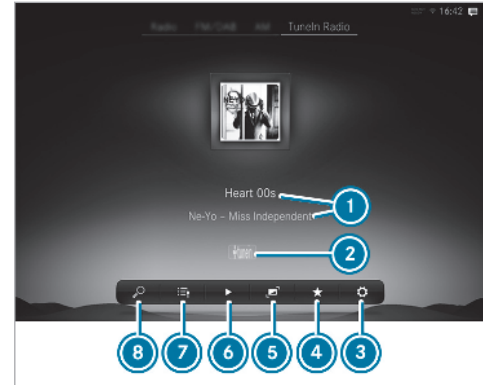

- ① Additional information on the current station
- ② Internet Radio provider
- ③ Options
- ④ Favourites
- ⑤ Full screen
- ⑥ Controls playback

- 7 Channel list
- 8 Search

Selecting and connecting Internet Radio stations

Multimedia system:

 **Radio** **Tuneln Radio**

- ▶ Select .
 - ▶ Select a category.
 - ▶ Select a station.
- The connection is established automatically.

or

- ▶ Select the search field.
- ▶ Enter a station name.

- ⓘ A relatively large volume of data can be transmitted when using Internet Radio.

Saving/deleting an Internet Radio station as a favourite

Multimedia system:

 **Radio** **Tuneln Radio**

Saving favourites

- ▶ Select a station.

- ▶ Press .

Deleting favourites

- ▶ Select a station.
- ▶ Press .

Setting Internet Radio options

Multimedia system:

 **Radio** **Tuneln Radio** 
Tuneln

The following options are available:

- **Select stream:** select the stream quality
 - **Login to Tuneln account:** log in to your Tuneln user account
 - **Log out of account:** log out of your Tuneln user account
- ▶ Select an option.

Showing the station list for the last category selected

Multimedia system:

 **Radio** **Tuneln Radio**

- ▶ Press the cover of the current station. Depending on how the station was selected, a station list is shown.

Media

Information about media mode

Information about supported formats and data storage media

⚠ WARNING Risk of accident as a result of distraction

There is a risk of being distracted.

- ▶ To avoid dangers, observe the warning notes in the "Important safety notes" section.

See .

The multimedia system supports the following formats and data media:

Permissible file systems	FAT32, exFAT, NTFS
Permissible data carriers	USB devices, iPod®/iPhone®, MTP devices, Bluetooth® audio equipment
Supported audio formats	MP3, WMA, AAC, WAV, FLAC, ALAC
Supported video formats	MPEG, AVI, DivX, MKV, MP4, M4V, WMV

i Observe the following notes:

- The multimedia system supports a total of up to 50,000 files.
- Data storage media up to 2 TB are supported (32-bit address space).
- Due to the large variety of available music and video files regarding encoders, sampling rates and data transfer rates, playback cannot be guaranteed.

- Due to the wide range of USB devices available on the market, playback cannot be guaranteed for all USB devices.
- Videos up to FullHD (1920x1080) are supported.
- Copy-protected music and video files or DRM (Digital Rights Management) encrypted files cannot be played back.
- MP3 players must support Media Transfer Protocol (MTP).

Information on copyright protection and trademarks

Audio files which you create yourself (e.g. copies of data storage media you make yourself) are generally subject to copyright protection. In many countries, reproductions are not permitted without the prior consent of the copyright holder, even for private use. Make sure that you know about the applicable copyright regulations and that you comply with these.



Manufactured under licence from Dolby Laboratories. Dolby, Dolby Audio and the double-D symbol are trademarks of Dolby Laboratories.



For DTS Patents, see <http://patents.dts.com>. Manufactured under licence from DTS Licensing Limited. DTS, the Symbol, & DTS and the Symbol together are registered trademarks, and DTS TrueVolume is a trademark of DTS, Inc.®. DTS, Inc. All Rights Reserved.



Gracenote, the Gracenote logo and logotype, "Powered by Gracenote", MusicID and Playlist Plus are either registered trademarks or trademarks of Gracenote, Inc. in the United States and/or other countries.



TIDAL and TIDAL logo are registered trademark of Aspiro AB in the European Union and other countries.

Overview of the media menu

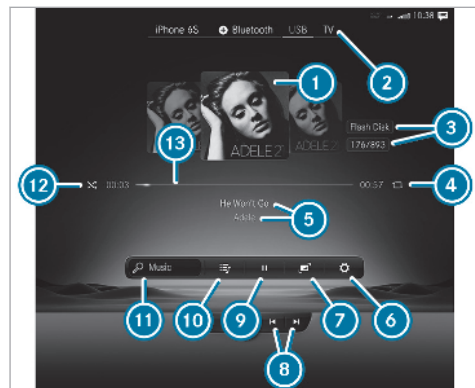

- ① Album cover
- ② Active media source
- ③ Active data storage device and current track number/track in playback list
- ④ Repeat
- ⑤ Track and artist
- ⑥ Settings

- ⑦ Full screen
- ⑧ Previous or next track and fast rewind or fast forward
- ⑨ Controls playback
- ⑩ Categories
- ⑪ Music search
- ⑫ Random playback
- ⑬ Timeline

Connecting the data storage medium to the multimedia system

Connecting USB devices

! **NOTE** Damage caused by high temperatures

High temperatures can damage USB devices.

- ▶ Remove the USB device after use and take it out of the vehicle.

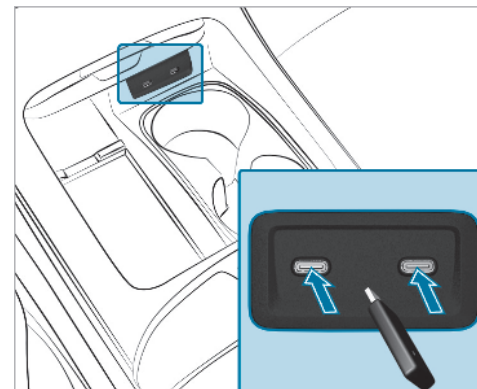

Vehicles with cup holders (example)

The multimedia connection unit is found in the centre console storage compartment and has two type C USB ports. Depending on the vehicle equipment, there are two more USB ports in the storage compartment under the armrest. The charging capacity of the USB ports is at least 5 V (3 A) and, depending on the vehicle equipment, a maximum of 20 V (5 A).

▶ Connect the USB device to the USB port.

ⓘ When connecting several Apple® devices simultaneously, pay attention to the order in which the devices are connected. The multimedia system only connects with the device that is connected first. Additional Apple® devices that are connected at the same time are only supplied with power.

Searching for and authorising a Bluetooth® audio device

Requirements:

- Bluetooth® is activated on the multimedia system and audio equipment.
- The audio equipment supports the Bluetooth® audio profiles A2DP and AVRCP.
- The audio equipment is "visible" for other devices.

Multimedia system:

➔  ▶▶ Media ▶▶ Bluetooth

Authorising a new Bluetooth® audio device

- ▶ Select **Connect new device**.
Detected equipment is displayed in the device list.
- ▶ Select an audio device.
Authorisation starts. A code is displayed on the multimedia system and on the mobile phone.
- ▶ If the codes are identical, confirm on the audio equipment.
- ▶ Select **Only as Bluetooth audio device**.
The Bluetooth® audio equipment is connected with the multimedia system.

Connecting previously authorised Bluetooth® audio equipment

- ▶ Select a Bluetooth® audio device from the list.
The connection is being established.

Starting media playback

Requirements:

- A data storage medium is connected to the multimedia system.

Multimedia system:



➔  ▶▶ Media

- ▶ Select **USB** or **Bluetooth** as the media source.

Controlling media playback

Multimedia system:





➔  ▶▶ Media

- ▶ **To pause playback:** select .
- ▶ **To continue playback:** select .
- ▶ **To repeat a track:** select .

For the repeat function there are the following settings:

- **Select once:** the active playlist is repeated.

- **Select twice:** the current track is repeated.
- **Select three times:** the repeat function is deactivated.

- ▶ **To play back tracks in random order:** select .
- ▶ **To wind a track forwards or backwards:** tap on the desired point on the timeline.
- ▶ **To select the next track:** select .
- ▶ **To select the previous track:** select .
- ▶ **To scroll through tracks quickly:** press and hold  or .
- ▶ **To show the current track list:** select the track image shown.

Additional options for setting media playback

Multimedia system:



Calling up additional options

- ▶ Select .
- The additional options are shown.
- ▶ Select an option.

Music online

Calling up music online

Requirements:

- There is an account for the music streaming service.
- A subscription for the music streaming service has been obtained.
- The data volume is available.
Depending on the country, data volume may need to be purchased.
- A fast Internet connection for data transmission free of interference.

- ⓘ The functions and services are country-dependent. For more information, consult a Mercedes-Benz service centre.

Multimedia system:



- ▶ Select **Online music**.
With **Online music** you can listen to music via a streaming service.

Music playback can be controlled with the Touch Control or by using the media application.

Searching for music in online music

Multimedia system:



Searching for categories in online music

The media content of the streaming provider can be scanned through in the category search. The available categories and the symbol for the category search depend on the streaming provider.

- ▶ Select .
- The list of available categories appears.
- ▶ Select a category.

Keyword search in online music

You can look for content using the keyword search with free text input.

- ▶ Select . A keyboard for character entry appears.
- ▶ Enter the term searched for.
- ⓘ The more characters entered when using the keyword search, the more concrete the search results are.
- ▶ Select the desired entry from the result list. If the selected result is an album, song or a playback list then playback is started. If the selected result is a new category then this is opened in the search.

Configuring online music settings

Multimedia system:

 ▶▶ Media ▶▶ Online music

- ▶ During media playback, press  in the Media menu.
- ▶ Select a setting.

Media search

Notes about the search function in categories

Under  you can search through all available media files. There are several categories available for selection. The categories shown depend on the connected device and data format.

- ⓘ The categories are available as soon as the entire media content has been read in and analysed.

Starting a search in categories

Multimedia system:

 ▶▶ Media ▶▶ 

- ▶ Select a category.
- ▶ Select  and enter a search term.

Using the keyword search

Multimedia system:

 ▶▶ Media

You can look for content using the keyword search with free text input.

- ▶ Select . A keyboard for character entry appears.
- ▶ Enter the term searched for.
- ⓘ The search begins with the first character entered. The more characters entered the more concrete the search results become.
- ▶ Select the desired entry from the result list. If the selected result is an album, song or a playback list then playback is started. If the selected result is a new category then this is opened in the search.

Searching for a track according to mood

Multimedia system:

 ▶▶ Media ▶▶ 

By searching in categories, you can find music tracks suitable for a mood.

- ▶ Select **Mood**. A grid with the various moods appears.
- ▶ Pull the controller to the desired position. The system searches for tracks that are suitable for the mood entered.

Radio

Switching on the radio

Multimedia system:



- ▶ Start the application on the multimedia system home screen. The radio display appears. You will hear the last station played on the last frequency band selected.

Radio overview



- 1 Active frequency band
- 2 Station name or set frequency
- 3 Options
- 4 Full screen/DAB slideshow
- 5 Switching traffic announcements on/off
- 6 Station list
- 7 Search

Setting the frequency band

Multimedia system:



- ▶ Select a frequency band or a favourite.

Selecting a radio station

Multimedia system:



- ▶ Swipe to the left or right on the control element or select a radio station.

Calling up the radio station list

Multimedia system:



- ▶ Select . The station list appears.
- ▶ Swipe the station list up or down.
- ▶ Select a station.

Searching for radio stations using station names or frequency entry

Multimedia system:



- ▶ Select .
- ▶ Enter a station name or frequency.
- ▶ Select a station.

Storing radio stations

Multimedia system:





- ▶ Select a radio station.
- ▶ Select .

Editing favourites

Multimedia system:



Moving stations

- ▶ Press .
The list of favourites appears.
- ▶ Press  next to the station name.
- ▶ Select **Move**.
- ▶ Move the station to the new position.

Calling up a slide show (FM/DAB radio mode)

Multimedia system:



The slide show displays additional information provided by the station as an image. This can include logos, album covers, music tracks, programmes, news or service information, for example.

- ▶ Press the station picture on the central display.
The image is enlarged.

Activating/deactivating the frequency fix function

Multimedia system:



▶ General

- ▶ Switch **Frequency fix** on or off.
If the function is activated, the set frequency is kept even if the reception is poor.

Activating/deactivating traffic announcements

Multimedia system:



- ▶ Select **TA**.
The traffic information service is switched on
- ⓘ When the traffic information service is switched on, **TA** is blue.

Setting the traffic information service volume increase

Multimedia system:



- ▶ Select Navigation and traffic announcements.
- ▶ Set a value for Traffic announc. vol. increase.

Displaying radio text

Multimedia system:



- ▶ General
- ▶ Switch Radio text information on or off.

TV

Switching to TV mode

Multimedia system:



- ▶ Select TV.
The TV picture appears. If available, the channel and programme information is displayed.
If the vehicle is travelling faster than 5 km/h the television picture is hidden from the driver. If available, the channel and programme information is continuously displayed.
- ▶ **To show a TV programme on a full screen:** tap on the preview picture.

TV mode overview

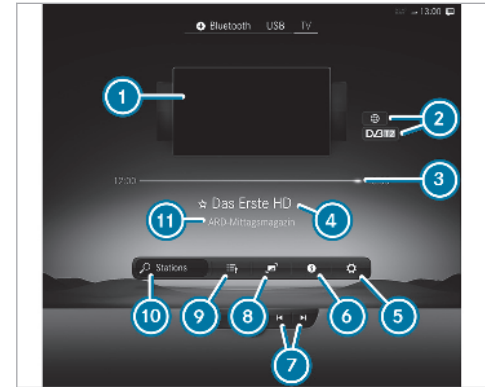

- ① Preview image
- ② Features of the TV channel and the current programme
- ③ Start and finish times of the current programme, graphic showing the remaining broadcast time
- ④ Channel name

- ⑤ Options
- ⑥ Shows the electronic programme preview (EPG)
- ⑦ Selects the previous or next TV channel from the channel list
- ⑧ Full screen
- ⑨ Channel list
- ⑩ Searches for a TV channel
- ⑪ Programme information

Overview of symbols

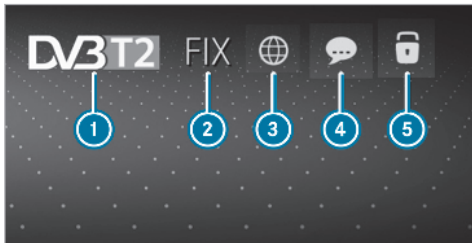

- ① TV standard
- ② Channel fix active

- ③ Audio languages available
- ④ Subtitles available
- ⑤ TV channel is encrypted
Open lock: TV channel can be decrypted with the currently connected CI+ module

Showing or hiding full screen



- ▶ **To show:** press the preview picture.
- ▶ **To hide:** press  in the central display. The TV menu appears.

Selecting TV channels

Selecting TV channels from the menu

Multimedia system:



→  ▶▶ Media ▶▶ TV

- ▶ Press  or  on the central display. The TV tuner sets the previous/next channel from the channel list.

Selecting TV channels from the channel list

Multimedia system:

→  ▶▶ Media ▶▶ TV

- ▶ Select in the  menu.
- ▶ Select a TV channel. The TV tuner selects the channel from the channel list.
- ▶ Press the preview picture.
- ▶ **To search for a TV channel:** select the search bar next to  (→ page 431).
- ▶ Enter the first characters.
- ▶ Select the TV channel from the channel list.
- ① Further information on the search bar (→ page 434).

Selecting a TV channel from the favourites

Requirements:

- The TV channel is stored.



Multimedia system:

→  ▶▶ Media ▶▶ TV

- ▶ Select  in the menu (→ page 431).
- ▶ Select **Presets**.

- ▶ Select the TV channel.

Selecting TV channels in the background Requirements:

- The navigation system is active, for example
 - TV mode is switched on in the background and the sound from the selected TV channel can be heard
- ▶ Press  or  on the central display. The TV tuner sets the previous/next channel from the channel list.

Displaying current programme information for the selected channel (EPG)

Multimedia system:



EPG displays the following information (if available):

- Broadcast times
 - Names of the current and upcoming programmes
- ▶ Select a programme name with . The programme information is displayed.

- ▶ **To scroll:** swipe up or down.
- ▶ **To leave the programme information display:** select .

Function of the channel fix setting

Channel fix is switched on

The channel is not changed. This is useful if, for example, you drive the vehicle through reception regions that overlap. It prevents frequent switching back and forth between channels.

The **FIX** indicator is displayed after the name of the TV channel.

Channel fix is switched off

Depending on reception quality, the TV tuner automatically switches to an alternative channel with the same programme content but better reception. Using this function, the best possible television picture can be found, regardless of the reception quality.

Activating/deactivating channel fix

Multimedia system:



▶▶ General

- ▶ Select **General settings**.

- ▶ Switch **Station fix** on or off.

When the option is switched on, the display button is activated.

Switching the country-specific character set for the TV channel on/off

Multimedia system:



▶▶ General

- ▶ Select **General settings**.

- ▶ Switch **Country-specific character set** on or off.

When the option is switched on, a country-specific character set is used for the display.

When the option is switched off, the character set transmitted by the currently set TV channel is used for the display.

The respective TV channel is responsible for the transmission of the channel-dependent character set.

Channel list overview

The TV tuner shows the current programme on the digital TV channels or radio stations with adequate reception in its own channel list.

The order of the channel lists is alphabetical or country-specific.

The TV tuner requires a short amount of time to update the information.

The channel lists show the following information:

- receivable channel names
- programme title

The information is shown under the following conditions:

- it is broadcast by the digital channel
- the reception conditions are adequate

Favourites

Overview of TV programmes (favourites)

You can create up to 100 digital TV channels in the presets.

For quick-access you can save TV channels as favourites.

Storing TV channels



Multimedia system:

Adding a TV channel to favourites

- ▶ Select a TV channel.
- ▶ Select .

Moving a TV station within favourites

- ▶  Press . The list of favourites appears.
- ▶ Press  next to the station name.
- ▶ Select **Move**.
- ▶ Move the station to the new position.

Removing a TV channel from favourites

- ▶ Select a TV channel.
- ▶ Select .

TV programme

Setting the TV audio language

Multimedia system:

  **Media**  
 ▶▶ **General**

- ▶ Select **Audio/subtitles**.
- ▶ Select one of the available audio languages  under the **Audio language** category.
- ▶ Select one of the available options for the selected audio language.
The selected audio language, e.g. French, will be kept until the multimedia system is switched off.
When you switch on the multimedia system again, the system language is loaded as the audio language. If this is not available, the audio language that appears at the beginning of the list is loaded.

Setting the TV subtitles

Multimedia system:



» General

- ▶ Select [Audio/subtitles](#).
- ▶ Select the available languages  under the [Subtitles](#) category.
- ▶ Select one of the available options for the selected language.
The selected language, e.g. French, will be kept until the multimedia system is switched off.

When you switch on the multimedia system again, the system language is loaded as the language. If this is not available, the language that appears at the beginning of the list is loaded.

- ▶ **To show no subtitles:** switch [Activate](#) off.

Teletext

Teletext overview

Teletext pages are located between page 100 and page 899.

A dynamic teletext page consists of several sub-pages.

Information on MHEG-5 digital teletext:

- Digital teletext is only available in some countries, e.g. the UK and New Zealand
- Interactive multimedia applications such as weather forecasts, news reports and sport results are available
- It may take some time before all the pages load

Showing teletext

Multimedia system:



» General » Teletext

- ▶ **To switch to page selection:** switch between number entry and selection using the arrow button with  and [123](#).
- ▶ **To call up a side:** enter the numbers in quick succession.

or

- ▶ Select the arrow buttons.
- ▶ **To return to the TV programme:** select [TV](#).

MHEG-5 digital teletext

Apart from the functions described above, additional options can be used.

- ▶ **To call up data content using colours:** select a colour.
- ▶ **To move back a level:** select a list symbol.

Picture settings

Selecting picture settings for the TV

Multimedia system:



» General » Video settings

- ▶ **To set the picture format:** activate one of the [Automatic](#), [4:3](#), [8:3](#), [16:9](#), [21:9](#) or [Zoom](#) display buttons.

The brightness is automatically set.

HD programmes

Receiving encrypted HD programmes

! **NOTE** Damage to the CI+ module and Smart Card

The CI+ module is designed for use in the home. The CI+ module can overheat and be damaged by continuous exposure to high outside temperatures.

- ▶ Make sure that the CI+ module is not subject to high temperatures for extended periods of time.
- If the CI+ module is damaged, no encrypted channels can be received.

A CI+ module (Common Interface Module), which is not included in the scope of delivery, is used to decrypt HD programmes according to the CI+ standard.

In some countries, an additional smart card is required, which is inserted into the CI+ module (see the manufacturer's operating manual).

The CI+ module is connected in the CI+ box in the glove compartment.

▶ **To insert the smart card in the CI+ module:** if required (country-dependent), insert the smart card into the CI+ module slot. Encrypted HD programmes can be received according to the CI+ standard.

- ⓘ The CI+ box is designed for operation at temperatures between 0 °C and 65 °C. At operating temperatures that are higher or too low a message appears in the multimedia system and the CI+ module is switched off automatically. If the CI+ module is switched off, no encrypted channels can be received.
- ⓘ If a CI+ module is connected, **Card status reminder** is switched on (→ page 436) and the ignition is switched off, the **Alert: CI+ card is still in the vehicle.** message appears in the central display.

Calling up the CI+ module menu

Multimedia system:

➔  ➔ Media ➔ TV

Switching the reminder of a connected CI+ module on or off

- ▶ Select .
- ▶ Select **General settings**.
- ▶ Switch the **Card status reminder** option on or off.
- ⓘ You need the subscription menu to extend the subscription, for example. Further information can be found in the manufacturer's operating instructions.

Calling up the CI+ menu

- ▶ Select **CI+ module**.
- ▶ Select **Open menu**.
The subscription number can be shown in the menu, for example. The content of the menu depends on the manufacturer of the CI+ module.
- ▶ **To show the version number:** select **Version info..**

- ▶ **To reset the TV tuner:** select [Reset TV](#).
- ▶ **To restart the CI+ module:** if playback is experiencing interference you can try and resolve the problem using [Restart CI+](#).

Sound

Tone settings

Information about the sound system

The sound system has a total output of 125 W and is equipped with nine speakers. It is available for all functions in the radio and media modes.

Calling up the sound menu

Multimedia system:



- ▶ Select one of the functions shown to make settings.

Adjusting treble, mid-range and bass settings

Multimedia system:



- ▶ Set [Treble](#), [Mid](#) or [Bass](#).

Activating/deactivating loudness adjustment

Multimedia system:



The loudness adjustment compensates for differing degrees of loudness when changing between audio sources and within an audio source.

The degree of adjustment can be selected from several levels. The adjustment function can also be deactivated.

- ▶ Switch on [Loudness](#) and select an available level or switch off [Loudness](#).

Adjusting the balance/fader

Multimedia system:



Adjusting the balance

- ▶ Move the volume distribution between the right and left sides of the vehicle in the grid shown.
The volume is distributed between the speakers on the left and right sides in the vehicle.

Adjusting the fader

- ▶ Move the volume distribution between the front and rear of the vehicle in the grid shown.
The volume is distributed between the speakers in the front and rear of the vehicle.

Burmester® 3D-surround sound system

Information about the Burmester® 3D-surround sound system

The Burmester® surround sound system has a total output of 710 W and is equipped with 15

speakers. It is available for all functions in the radio and media modes.

Calling up the sound menu in the Burmester® 3D-surround sound system

Multimedia system:

 **Media** **Burmester**

- Select one of the functions shown to make settings.

Adjusting the treble, mid and bass settings on the Burmester® 3D-surround sound system

Multimedia system:

 **Media** **Burmester**
Equaliser

- Set **Treble**, **Mid** or **Bass**.

Activating/deactivating loudness adjustment in the Burmester® 3D-surround sound system

Multimedia system:

 **Media** **Burmester**

The loudness adjustment compensates for differing degrees of loudness when changing

between audio sources and within an audio source.

The degree of adjustment can be selected from several levels. The adjustment function can also be deactivated.

- Switch on **Loudness** and select an available level or switch off **Loudness**.

Adjusting the balance/fader in the Burmester® 3D-surround sound system

Multimedia system:

 **Media** **Burmester**
Balance and Fader

Adjusting the balance

- Move the volume distribution between the right and left sides of the vehicle in the grid shown.
The volume is distributed between the speakers on the left and right sides in the vehicle.

Adjusting the fader

- Move the volume distribution between the front and rear of the vehicle in the grid shown.
The volume is distributed between the speakers in the front and rear of the vehicle.

Selecting a sound profile in the Burmester® 3D-surround sound system

Multimedia system:

 **Media** **Burmester**

- Select a sound profile.

Adjusting the sound focus in the Burmester® 3D-surround sound system

Multimedia system:

 **Media** **Burmester**

- Select a position for the sound focus or **All seats**.

Burmester® high-end 4D surround sound system

Information on the Burmester® high-end 4D surround sound system

The Burmester® high-end 4D surround sound system has a total output of 1750 watts and is equipped with 31 speakers. It is available for all functions in the radio and media modes.

Calling up the sound menu in the Burmester® high-end 4D surround sound system

Multimedia system:

Press the **Home** button, then **Media**, **Settings**, and **Burmester**.

Adjusting sound settings

- ▶ Select one of the functions shown to make settings.

Adjusting the intensity of bass vibrations

- ▶ In the **4D sound** menu, slide the control to set the intensity of bass vibrations

Adjusting the treble, mid-range and bass settings on the Burmester® high-end 4D surround sound system

Multimedia system:

Press the **Home** button, then **Media**, **Settings**, **Burmester**, and **Equaliser**.

- ▶ Set **Treble**, **Mid** or **Bass**.

Activating/deactivating loudness adjustment in the Burmester® high-end 4D surround sound system

Multimedia system:

Press the **Home** button, then **Media**, **Settings**, and **Burmester**.

The loudness adjustment compensates for differing degrees of loudness when changing between audio sources and within an audio source.

The degree of adjustment can be selected from several levels. The adjustment function can also be deactivated.

- ▶ Switch on **Loudness** and select an available level or switch off **Loudness**.

Adjusting the balance/fader in the Burmester® high-end 4D surround sound system

Multimedia system:

Press the **Home** button, then **Media**, **Settings**, **Burmester**, and **Balance and Fader**.

Adjusting the balance

- ▶ Move the volume distribution between the right and left sides of the vehicle in the grid shown.
The volume is distributed between the speakers on the left and right sides in the vehicle.

Adjusting the fader

- ▶ Move the volume distribution between the front and rear of the vehicle in the grid shown.
The volume is distributed between the speakers in the front and rear of the vehicle.

Adjusting the seat-based sound optimisation in the Burmester® high-end 4D surround sound system

Multimedia system:

→  ▶▶ Media ▶▶  ▶▶ Burmester
▶▶ VIP seat

▶ Select a seat for sound optimisation.

or

▶ Select [All seats](#).

Selecting the sound profile in the Burmester® high-end 4D surround sound system

Multimedia system:

→  ▶▶ Media ▶▶ Burmester
▶▶ Sound profiles

▶ Select a sound profile.

MBUX high-end Rear Seat Entertainment System

Operating safety

⚠ WARNING Risk of injury from unsecured items in the vehicle

If objects such as headphones/headsets or external audio/video sources are not secured in the vehicle interior, they can be flung around and hit vehicle occupants.

▶ Always stow these items or similar objects carefully so that they cannot be flung around, for example in a lockable vehicle stowage compartment.

Observe the notes on loading the vehicle.

- i** Ventilation must not be impeded by covering the ventilation openings with items (such as newspaper, table-cloths, clothes, curtains, etc).
- i** No naked flame sources (such as lighted candles), shall be placed on apparatus.

Rear Seat Entertainment System overview

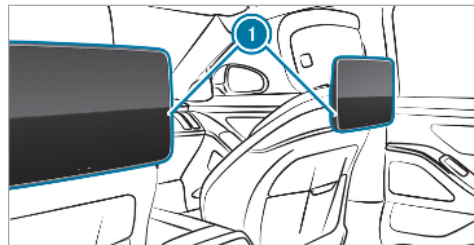

The high-end Rear Seat Entertainment System includes:

- Two rear displays **1** behind the head restraints of the front seats
- A connection jack each for corded headphones
- Two USB ports for charging USB devices (→ page 135), Bluetooth® headphones, for example.
- Two ports for HDMI mini

Vehicle equipped with passenger bench seat:
in the electronics compartment in the rear-
compartment centre console

Vehicle equipped with electrically adjusted
outer rear seats: in the stowage compart-
ment in the rear armrest

You can operate the high-end Rear Seat Entertain-
ment System using the rear display or the
MBUX Voice Assistant.

Depending on the equipment you can operate
the high-end Rear Seat Entertainment System:

- on the rear displays
- with the MBUX rear tablet
- with the MBUX Remote app
- via the MBUX Voice Assistant

Rear displays

Overview of the rear displays

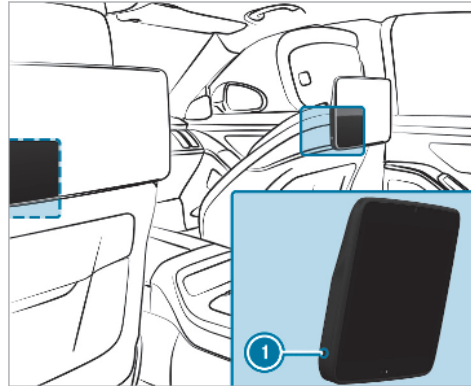

- ① Port for corded headphones with stereo jack, 3.5 mm stereo (3-pin) or for headset with microphone (4-pin)

The rear compartment displays are located
behind the head restraints of the front seats.

The rear displays are fitted with touchscreens.
Further information on operating touchscreens
(→ page 293).

When the rear door is opened, the welcome
screen appears.

Nearly all MBUX multimedia system functions
are also supported on the Rear Seat Entertain-
ment System. Settings for the driver or driving
assistance systems as well as some system set-
tings are however not possible. External user
interfaces, e.g. Apple CarPlay® and Android Auto
cannot be used on the rear displays. Contents of
the Digital Owner's Manual can only be called up
on the MBUX multimedia system.

Switching a rear display on/off

- ▶ Touch the touch sensor on the rear display.
The rear display is switched on or off.

Home screen overview (rear display)

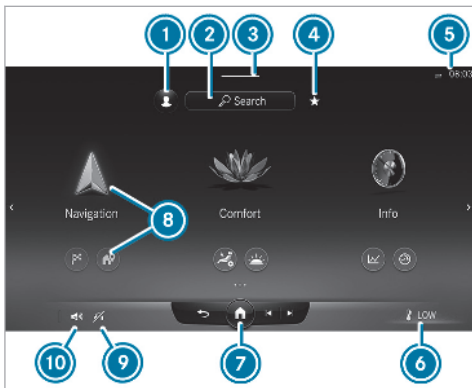

Example

- 1 Calls up user profile settings and changes user
- 2 Uses the global search
- 3 Calls up the multiseat control menu (pull down)
- 4 Calls up favourites

- 5 Displays the status line, e.g. connection status, time
- 6 Sets climate control, e.g. on the right
- 7 Calls up the home screen
- 8 Opens application, including Quick-access
- 9 Audio playback display
- 10 Adjusts the volume

Headphones

Headphones overview (Rear Seat Entertainment System)

⚠ WARNING Risk of injury due to high volume from headphones

High volumes may damage your hearing.

▶ Make sure that the volume is set at a pleasant level.

The following external headphones can be connected to each rear display:

- Bluetooth® headphones

- Coded headphones via a 3-pin stereo jack, 3.5 mm
 - A headset with microphone via a 4-pin stereo jack
- i** The headphones are not in the scope of delivery for the Rear Seat Entertainment System. You can obtain headphones from Mercedes-Benz Customer Solutions or in a specialist shop (see the manufacturer's operating instructions).
- i** The function of wireless headphones can be impaired by other radio-based electronic devices, such as mobile phones, for example.

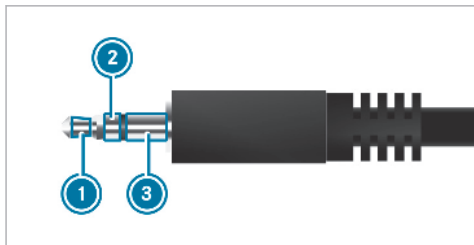

Example: connection of corded headphones with a 3-pin stereo jack, 3.5 mm

- ① Audio L (audio signal for left channel)
- ② Audio R (audio signal for right channel)
- ③ Earth

Handset

Overview of the handset

The handset is only available in the rear compartment of vehicles with the Business telephony equipment.

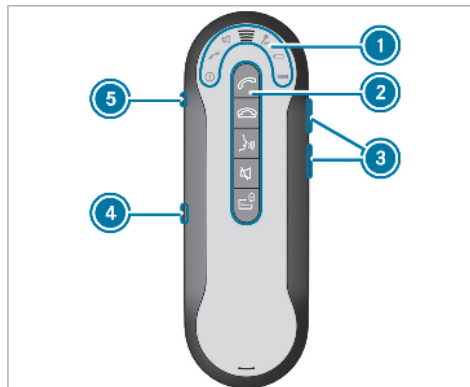

- ① LED displays
- ② Keypad
- ③ Volume settings
- ④ Micro USB port
- ⑤ Headphone jack

Function of the LED displays (handset)

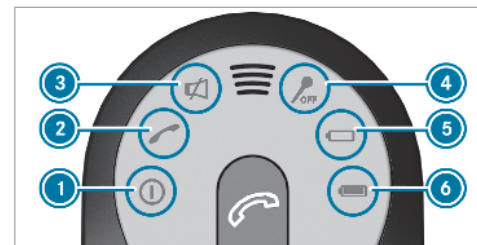

The LED displays on the handset have the following meanings:

Display	Meaning
①	The handset is operational.
②	<p>The display flashes:</p> <ul style="list-style-type: none"> Connecting call Incoming call Active call on the multimedia system <p>The call can also be transferred to the handset.</p> <p>The display lights up continuously:</p> <ul style="list-style-type: none"> Active call on the handset.
③ is lit up	<p>The handset is muted.</p> <p>No acoustic signal sounds for incoming calls.</p>
④ is lit up	The handset microphone is switched off.

Display	Meaning
⑤	"Battery discharged" display
⑥	"Battery charge status" display

Handset functions

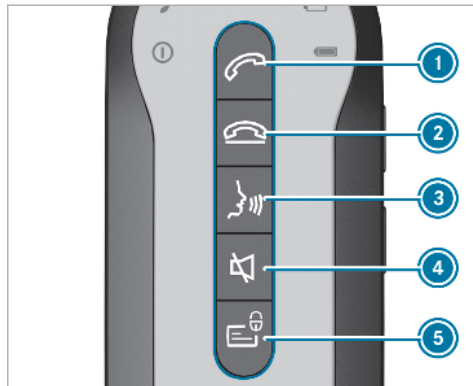



The buttons on the handset have the following functions:

Button	Function
①	<ul style="list-style-type: none"> Answers an incoming call Transfers an existing call to the handset Press briefly twice: redials number Press briefly: switches the handset between a call on hold and an active call Press and hold: switches to a conference call with the call on hold and an active call
②	<ul style="list-style-type: none"> Rejects an incoming call Ends an existing call

Button	Function
③	<ul style="list-style-type: none"> Activates voice recognition of the connected mobile phone (with Hands-Free Profile) During an active call on the handset: activates hands-free mode
④	<ul style="list-style-type: none"> Mutes the handset when there is no active call Switches off the microphone when a call is active
⑤	<p>No private information is displayed in the multimedia system:</p> <ul style="list-style-type: none"> Incoming calls and messages are made anonymous Contacts and messages in the connected mobile phone/SIM card are not shown

Switching the handset on/off

▶ **To switch on:** press and hold the  button until the LED displays light up (→ page 443).

▶ **To switch off:** press and hold the  button until the LED displays go out (→ page 443).

ⓘ The handset is switched on and off automatically when it is in the bracket.

Charging the handset

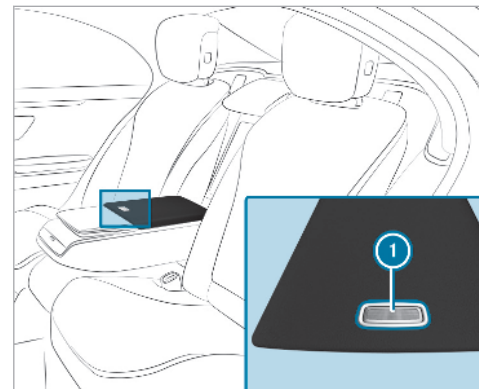

Vehicles with electrically adjustable outer seats

- ▶ Fold down the rear armrest.
- ▶ Press release catch ① and swing the cover of the armrest upwards.
- ▶ Place the handset in the drawer.

- ▶ Press drawer back until it engages. The handset is charged.
- ⓘ The handset can also be charged using the micro USB port.
- ⓘ You cannot replace the rechargeable battery yourself. Please consult a Mercedes-Benz Service Centre to do this.

Rear seats

Adjusting the rear seats on the Rear Seat Entertainment System

Rear Seat Entertainment System:

➔  ▶▶ Comfort ▶▶ Seat comfort

Positioning seats

- ▶ Select **Seat positioning**.
- ▶ Position the seat and, for example, adjust the inclination of the seat backrest and the height of the head restraints.
- ▶ **To save settings:** select M.
- ▶ Select one of the preset position buttons 1 or 2.

Adjusting the air cushions.

- ▶ In the corresponding menu, adjust the air cushions for **Lumbar** or **Side bolsters**.

Setting the seat heating

- ▶ Select **Seat climate control**.
- ▶ Press **Seat heating** repeatedly until the desired heating level is set. Depending on the heating level, up to three indicator lamps will light up. If all indicator lamps are off, the seat heating is switched off.

Setting the seat heating balance

- ▶ Select **Seat climate control**.
- ▶ Select **Seat heating balance**.
- ▶ Adjust the heat distribution for the desired seat.

Activating/deactivating the panel heating

For this function, the seat heating must be switched on.

- ▶ Select **Seat climate control**.
- ▶ Select **Panel heating**.

- ▶ Switch the function for the desired seat on or off. When panel heating is switched on, the armrests, the centre panels on the doors and the centre console are heated.

Adjusting the neck warmer

For this function, the seat heating must be switched on.

- ▶ Select **Seat climate control**.
- ▶ Switch **Neck warmers** on or off.
- ▶ Adjust the neck warmer for the desired seat.

Selecting the massage programme for the rear seats

Rear Seat Entertainment System:

➔  ▶▶ Comfort ▶▶ Massage

- ▶ Select a massage programme.
- ⓘ To the overview of massage programmes (→ page 107).
- ▶ **To start a massage:** select  for the required rear seat.

- ▶ To set the massage intensity: switch **High intensity** on or off.
- ▶ Select  to start the massage.

Resetting rear seat settings

Rear Seat Entertainment System:

 ▶▶ **Comfort** ▶▶ **Seat comfort**

- ▶ Select **Reset**.
- ▶ Select  for the desired seat.
The settings for the selected seat are reset.

Setting climate control for the rear passenger compartment (Rear Seat Entertainment System)





Sets the airflow

- ▶ Select the temperature display at the lower edge of the rear display.
- ▶ Set the airflow.

Sets the temperature

- ▶ Select the temperature display at the lower edge of the rear display.
- ▶ Set the temperature.

Setting the air distribution

- ▶ Select the temperature display at the lower edge of the rear display.
- ▶ Select  or  for the left or right seat.
 -  The air is routed through the centre and side air vents.
 -  The air is routed through the footwell and side air vents.

Controlling the rear climate control automatically

- ▶ Select **AUTO**.
Rear climate control is controlled automatically.

Deactivating rear climate control

- ▶ Select **REAR OFF**.
Rear climate control is deactivated.

If available other climate control functions are available:

- Air quality
- Stationary heater
- Pre-entry climate control

Starting ENERGIZING comfort in the rear compartment

Requirements:

- The ignition is switched on.

Rear Seat Entertainment System:

 ▶▶ **Comfort**
▶▶ **ENERGIZING COMFORT**

Starting the programme

- ▶ Select a programme.
- ▶ **Select Start for the desired rear seat.**

 If, during an active programme, a function requirement is no longer met, a corresponding message appears. The active programme is cancelled.

-  Additional information on the programmes (→ page 331).

Configuring a programme

- ▶ Select a programme.
- ▶ Select **Settings**.
- ▶ Switch the functions included in the programme on or off.

Setting the running time



- ▶ Select a programme.
- ▶ Select **Settings**.
- ▶ Select the desired duration.

Starting the training programme

- ▶ Select **Training**.
- ▶ Select  a programme. The programme starts.
- ▶ **To activate fragrancing for training:** select **Air freshener**.

Starting tips

- ▶ Select **Tips**.

- ▶ Select  a region of the body.
- ▶ Select  to stop playback of the tip.

Adjusting the ambient lighting in the rear compartment

Rear Seat Entertainment System:

 ▶▶ **Comfort** ▶▶ **Ambient lighting**

Setting the colour

- ▶ Select **Colour**.
- ▶ Set the desired colour or colour combination.
-  There are 64 colours and different colour combinations available.

Adjusting the brightness

- ▶ Select **Brightness**.
- ▶ Adjust the brightness.

Activating the brightness for zones

- ▶ Select **Brightness**.
- ▶ Activate **Brightness zones**. The **Emphasis**, **Ambient** and **Impression** zones can be set separately.

-  The **Silhouette** zone can also be set in vehicles with active ambient lighting.

Activating effects

- ▶ Select **Effects**.
- ▶ Activate the desired effect.
-  Further information on effects (→ page 151)

Configuring the adaptive rear compartment light

Rear Seat Entertainment System:

 ▶▶ **Comfort**
▶▶ **Adaptive rear lighting**

Displaying information on lighting modes

- ▶ Select **Info**.

Selecting lighting mode

You can activate one option for the left and right rear seats respectively or for the whole rear passenger compartment.

- ▶ Select **Light modes**.
- ▶ Activate a light mode, e.g. **Reading light**.

Configuring light mode

The following options are available:

- **Work light:** the grab handle lighting and rear interior lamp on the respective side of the vehicle will go on.
 - **Reading light:** the grab handle lighting will go on. The size and position of the light cone can be adjusted individually.
 - **Two zone light:** the grab handle lighting is shared between two zones. Spot and background lighting can be adjusted.
 - **Interior light:** the grab handle lighting and rear interior lamps on both sides of the vehicle will go on.
 - **Lounge light:** the grab handle lighting on both sides of the vehicle will go on.
- ▶ Select the pen symbol.
 - ▶ **For all lighting modes:** set the colour temperature and the brightness.
 - ▶ **For the reading light:** also set the size of the light cone and move the light cone.

- ▶ **For two-zone lighting:** also select the **Light cone** or **Background** options.
- ▶ **For the Light cone option,** also set the size of the light cone and move the light cone.
- ▶ **For interior lighting and lounge light:** also activate the **Biodynamic light** option. The biodynamic light controls the colour temperature. The colour temperature will be adjusted automatically over the course of the day.

Saving a lighting mode as a favourite

- ▶ Select **Store on rear favourites button**.
For the **Interior light** and **Lounge light** light modes, the prompt also appears asking whether the left or right rear seat should be selected.

Resetting lighting mode settings

- ▶ Select **Reset**.
- ⓘ Brightness and colour temperature of the grab handle lighting and rear lighting can be adjusted individually via the MBUX rear tablet and the app.

If the vehicle is fitted with the MBUX Interior Assistant, adaptive rear interior lighting can be controlled with gestures. With a gesture towards an empty neighbouring seat, for example, the grab handle lighting on the corresponding side of the vehicle will go on.

Selecting system settings in the rear compartment

Rear Seat Entertainment System:

➔  ➔ Settings ➔ System

Adjusting the brightness

- ▶ Select **Display brightness**.
- ▶ Adjust the brightness.

Connecting a device in the device manager

- ▶ Select **Device manager**.
- ▶ Select a device that is to be connected. Headphones and headsets are connected with the rear display. Mobile phones and other devices are connected with the multimedia system.

Setting the sensitivity for the rear display

- ▶ Select [Touch Sensitivity](#).
- ▶ Select an option.

Showing system information

- ▶ Select [System information](#).

Navigation

Switching on navigation in the rear compartment

Rear Seat Entertainment System:



The map appears and shows the current vehicle position.

- ▶ Select an option in the navigation menu (→ page 335).

In principle, you can use the multimedia system functions on the Rear Seat Entertainment System also.

The following options are available on the rear display, for example:

- Enter the destination as a POI or address, for example (→ page 336).
- The destination can be adopted by the multimedia system or shared with another seat.
- Set the map scale (→ page 361).
- Calculate the route (→ page 341).

Route settings and route options, e.g. toll roads, can be selected for the route.

You can add and manage intermediate destinations for the route planning (→ page 345).

Alternative routes are available.

- Route and destination information is shown during route guidance.
- The Live Traffic Information service shows traffic incidents, traffic flow information and warning message symbols.

This option is not available in all countries.

Overview of telephone functions in the rear compartment

If the vehicle is equipped with the telephony feature in the rear compartment the functions of the multimedia system are, in principle, available on the Rear Seat Entertainment System.

The following functions are available on the rear display:

- Telephone operation (→ page 381)
- Conducting calls with several participants (→ page 382)
- Calling up [Contacts](#) (→ page 383)
 - Contact search using initials, names or telephone numbers
 - Displaying contact details
 - Using the keypad
- Calling up the [Call list](#) and making a call (→ page 386)
- [Text message](#)
 - Reading messages and using the read-aloud function (→ page 387)
 - Calling a message sender (→ page 388)

- Deleting a message (→ page 389)

Services and web browsers

Web browser overview (Rear Seat Entertainment System)

Depending on the country and the vehicle equipment, a web browser can be called up on the rear display.

The Internet connection can be established using the communication module, Bluetooth® or Wi-Fi.

For further information on setting up an Internet connection:

- Via communication module (→ page 414)
- Via Wi-Fi (→ page 416)
- Via Bluetooth® (→ page 416)

Calling up the web browser (Rear Seat Entertainment System)

Requirements:



- The vehicle is equipped with a permanently installed communication module .

- Alternatively, the Internet connection can be set up and established using Wi-Fi (→ page 416).

Rear Seat Entertainment System:

  Mercedes me & Apps
 Browser

 Call up a page.

 **To stop the web browser:** select .

The following functions are available:

- Calling up the web browser settings (→ page 420)
- Deleting browser data (→ page 420)
- Managing bookmarks

Media

Information about media mode in the rear compartment

The Rear Seat Entertainment System has two HDMI mini connections which can be used by both rear displays. Additional information on the connections (→ page 440).

There are two USB ports for charging USB devices (→ page 135), Bluetooth® headphones, for example.

Data storage media for playing back content on the Rear Seat Entertainment System are connected via the USB ports for the multimedia system in the stowage compartment in the centre console (→ page 425).

Data storage media supported by the Rear Seat Entertainment System:

- USB devices
- iPhone® or iPod®
Apple CarPlay® is not supported.
- MTP devices
Android Auto is not supported.
- Bluetooth® audio equipment
Authorisation of a Bluetooth® audio device is carried out on the multimedia system (→ page 426) or on the Rear Seat Entertainment System.

The Rear Seat Entertainment System can access the files on the multimedia system.

Further information about media mode (→ page 422).



The terms HDMI and HDMI High-Definition Multimedia Interface, and the HDMI Logo are trademarks or registered trademarks of HDMI Licensing LLC in the United States and other countries.

Switching on media mode in the rear passenger compartment

Requirements:

- A data storage medium is connected to the multimedia system.

- A Bluetooth® audio device is connected with the multimedia system.

Rear Seat Entertainment System:

→ **Media**

▶ Select **USB** or **Bluetooth**.

A possible audio source is **Online music**. To availability and pre-requirements (→ page 427).

The following functions are available:

- Controlling media playback (→ page 452)
- Using the music search (→ page 428)
- Using online search (→ page 427)
- Searching for media files using categories (→ page 428)
- Calling up options (→ page 427)
- Calling up the settings

Controlling media playback in the Rear Seat Entertainment System

Rear Seat Entertainment System:

→ **Media**

- ▶ **To pause or continue playback:** select or .
 - ▶ **To select the next or previous track:** select or .
 - ▶ **To scroll through tracks quickly:** press and hold or .
 - ▶ **To wind a track forwards or backwards:** tap on the desired point on the timeline.
 - ▶ **To play back tracks in random order:** select .
 - ▶ **To repeat a track:** select .
- For the repeat function there are the following options:
- Tap once: the active playlist is repeated.
 - Tap twice: the current track is repeated.
 - Tap three times: the repeat function is deactivated.
- ▶ **To display a full screen:** select the cover.

Radio

Switching to radio in the rear passenger compartment

Rear Seat Entertainment System:



- ▶ Swipe left or right on the rear display.
or

- ▶ Select a station with or .

- ⓘ If the channel is changed on the multimedia system it changes also on the rear display.

- ▶ **To set a frequency band:** select a frequency band.

The following functions are available:

- Searching for radio stations (→ page 430)
- Selecting from the station list (→ page 429)
- Storing radio stations (→ page 430)
- Calling up a slide show (→ page 430)
- Switching options on or off using :

[Frequency fix](#)

[Traffic announcements](#)

Radio text information

TV mode

Switching to TV mode in the rear passenger compartment

Rear Seat Entertainment System:



- ▶ Select a channel with or .

- ⓘ If the channel is changed on the multimedia system it changes also on the rear display.

- ▶ **To show full screen:** tap on the preview picture.

- ▶ **To show the TV menu:** select .

The following functions are available:

- Searching for a TV channel (→ page 432)
- ⓘ Showing current programme information for the selected TV channel (EPG) (→ page 433)
- Storing and managing TV channels (→ page 434)

- Setting options:
Setting [Audio language](#)
Setting [Subtitles](#)
Switching [Station fix](#) on or off
Displaying [Teletext](#)
Selecting [Video settings](#).

Sound

Overview of sound settings in the rear compartment

The sound settings depend on which sound system is available.

Depending on the equipment installed, one of the following systems is supported:

- Sound system (→ page 437)
- Burmester® surround sound system (→ page 438)
- Burmester® high-end 3D surround sound system (→ page 439)

Selecting sound settings in the rear compartment

Rear Seat Entertainment System:

 Settings >> System

▶ Select **Sound**.

▶ Select the sound settings.

Switching Cabin Audio on/off and setting volumes

Cabin Audio facilitates audio playback in the vehicle interior.

▶ Select .

▶ Select **Media**.

▶ Select **USB** or **My USB**.

▶ Switch the display button with the speaker symbol on or off.

▶ **To set the volumes:** move the control knob to the left or right on one of the scales and hold it until the desired volume is set.

Using the MBUX Voice Assistant

Requirements:

- The Voice Assistant wake-up call "Hey Mercedes" is switched on in the MBUX multimedia system settings (→ page 288).
- Online functionality offers the full range of functions.

Using the MBUX Voice Assistant you can operate the MBUX Rear Seat Entertainment System using voice input. You can use vernacular sentences for this. The Voice Assistant recognises different voices, learns and can thereby offer suitable suggestions.

▶ **To activate the Voice Assistant:** say the wake-up call "Hey Mercedes".

▶ Say a voice command, e.g. set station.

 You can activate and deactivate the Voice Assistant from different seats.

Further information on the Voice Assistant:

- Conducting a dialogue (→ page 287)
- Information on online functionality (→ page 290)

- Activating online functionality on the multimedia system
- Using audible help functions

ASSYST PLUS service interval display

Function of the ASSYST PLUS service interval display

The ASSYST PLUS service interval display on the driver display provides information on the remaining time or distance before the next service due date.

You can hide this service display using the back button on the left-hand side of the steering wheel.

Depending on how the vehicle is used, the ASSYST PLUS service interval display may shorten the service interval, e.g. in the following cases:

- mainly short-distance driving
- when the engine is often left idling for long periods
- in the event of frequent cold start phases
- **vehicles with a diesel particulate filter:** in the event of frequently interrupted regeneration of the diesel particulate filter

Mercedes-Benz recommends avoiding such operating conditions.

You can obtain information concerning the servicing of your vehicle from a qualified specialist workshop, e.g. a Mercedes-Benz Service Centre.

Displaying the service due date

On-board computer:

↩ Service ▶▶ ASSYST PLUS

The next service due date is displayed.

▶ **To exit the display:** press the back button on the left-hand side of the steering wheel.

Bear in mind the following related topic:

- Operating the on-board computer (→ page 275).

Information on regular maintenance work

! **NOTE** Premature wear through failure to observe service due dates

Service work which is not carried out at the right time or incompletely can lead to increased wear and damage to the vehicle.

- ▶ Always observe the prescribed service intervals.
- ▶ Always have the prescribed service work carried out at a qualified specialist workshop.

Special service requirements

The prescribed service interval is based on normal operation of the vehicle. Maintenance work will need to be performed more often if the vehicle is operated under arduous conditions or increased loads.

The ASSYST PLUS service interval display is only an aid. The driver of the vehicle bears responsibility as regards to whether maintenance work needs to be performed more often than speci-

fied based on the actual operating conditions and/or loads.

Examples of arduous operating conditions:

- regular city driving with frequent intermediate stops
- mainly short-distance driving
- frequent operation in mountainous terrain or on poor road surfaces
- when the engine is often left idling for long periods
- operation in particularly dusty conditions and/or if air-recirculation mode is frequently used

In these or similar operating conditions, have the interior air filter, engine air cleaner, engine oil and oil filter etc. changed more frequently. The tyres must be checked more frequently if the vehicle is operated under increased loads. Further information can be obtained at a qualified specialist workshop.

Battery disconnection periods

The ASSYST PLUS service interval display can calculate the service due date only when the battery is connected.

- ▶ Display the service due date on the driver display and note it down before disconnecting the battery (→ page 455).

Engine compartment

Active bonnet (pedestrian protection)

Operation of the active bonnet (pedestrian protection)

In certain accident situations, the risk of injury to pedestrians can be reduced by the actuation of the active bonnet. The rear area of the engine bonnet is raised by approximately 80 mm.

For the drive to the workshop, reset the actuated active bonnet yourself (→ page 456).

After the active bonnet has been actuated, pedestrian protection may be limited.

A qualified specialist workshop must re-instate the full functionality of the active bonnet.

Resetting the active bonnet

⚠ WARNING Risk of burns from hot component parts in the engine compartment

Certain components in the engine compartment can be very hot, e.g. the engine, the radiator and parts of the exhaust system.

- ▶ Allow the engine to cool down and only touch component parts described in the following.

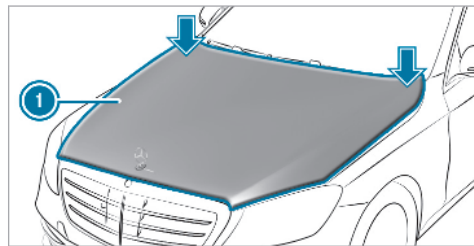

- ▶ With your hand flat, push down active bonnet  in the area around the hinges on both sides (arrows).
The engine bonnet must engage in position.
- ▶ If the active bonnet can be raised slightly at the rear in the area of the hinges, repeat the step until it engages correctly.

Opening/closing the bonnet

 **WARNING** Risk of accident due to driving with the bonnet unlocked

The bonnet may open and block your view.

- ▶ Never release the bonnet when driving.
- ▶ Before every trip, ensure that the engine bonnet is locked.

 **WARNING** Risk of accident and injury when opening and closing the bonnet

The bonnet may suddenly drop into the end position.

There is a risk of injury for anyone in the bonnet's range of movement.

- ▶ Open or close the bonnet only when there is nobody in the bonnet's range of movement.

 **WARNING** Danger of burns when opening the bonnet

If you open the engine bonnet when the engine has overheated or during a fire in the engine compartment, you could come into contact with hot gases or other escaping operating fluids.

- ▶ Before opening the bonnet, allow the engine to cool down.
- ▶ In the event of a fire in the engine compartment, keep the engine bonnet closed and call the fire service.

 **WARNING** Risk of injury due to moving parts

Components in the engine compartment may continue running or start up suddenly, even if the ignition is switched off.

Make sure of the following before performing tasks in the engine compartment:

- ▶ Switch the ignition off.
- ▶ Never reach into the danger zone surrounding moving components, e.g. the rotation area of the fan.
- ▶ Remove jewellery and watches.
- ▶ Keep items of clothing and hair away from moving parts.

 **WARNING** Risk of injury from touching components under voltage

The ignition system and the fuel injection system work under high voltage. You could receive an electric shock.

- ▶ Never touch components of the ignition system or the fuel injection system when the ignition is switched on.

⚠ WARNING Risk of burns from hot component parts in the engine compartment

Certain components in the engine compartment can be very hot, e.g. the engine, the radiator and parts of the exhaust system.

- ▶ Allow the engine to cool down and only touch component parts described in the following.

⚠ WARNING Risk of injury from using the windscreen wipers while the engine bonnet is open

When the engine bonnet is open, and the windscreen wipers are set in motion, you can be trapped by the wiper linkage.

- ▶ Always switch off the windscreen wipers and ignition before opening the engine bonnet.

Opens the bonnet

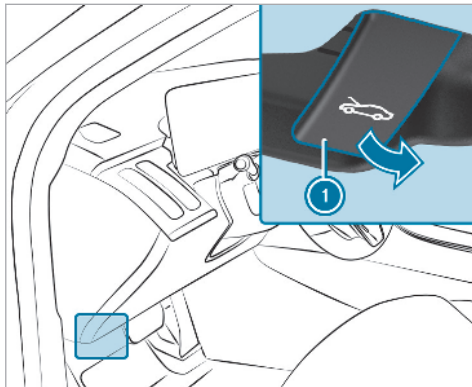

- ▶ Pull on handle ① twice.
The bonnet is released and opens slightly.

Closing the bonnet

! **NOTE** Damage to the bonnet

If the bonnet is closed manually, there is a risk of dents.

- ▶ Do not close the bonnet manually.

- ▶ Lower the bonnet to a height of around 20 cm and then allow it to fall, applying a little force as you let it go.
- ▶ If the bonnet can still be lifted slightly, open the bonnet again and close it with a little more force until it engages correctly.

Engine oil

Checking the engine oil level using the on-board computer

Requirements:

- The engine has been warmed up.
- The vehicle is parked on a level surface.
- The engine is running at idle speed.

The engine oil level is determined during driving. Determining the engine oil level can take up to 30 minutes with a normal driving style and even longer with an active driving style.

On-board computer:

↪ Service ▶ Engine oil level

One of the following messages will appear on the driver's display:

- **Messung läuft...**: measurement of the oil level is not yet possible.
- ▶ Repeat the request after a maximum of 30 minutes' driving.
- **OK** and the bar display for indicating the oil level on the driver's display is green and is between "min" and "max": the oil level is correct.
- **Motoröl nachfüllen** and the bar display for indicating the oil level on the driver's display is orange and is below "min":
- ▶ Add 1 l of engine oil.
- **Motorölstand reduzieren** and the bar display for indicating the oil level on the driver's display is orange and is above "max":

- ▶ Drain off any excess engine oil that has been added. To do so, consult a qualified specialist workshop.
 - **For engine oil level switch on ignition:**
- ▶ Switch on the ignition to check the engine oil level.
 - **Engine oil level System inoperative:** the sensor is defective or not connected.
- ▶ Consult a qualified specialist workshop.
 - **Engine oil level currently inoperative:**
- ▶ Close the bonnet.

Topping up engine oil

⚠ WARNING Risk of burns from hot component parts in the engine compartment

Certain components in the engine compartment can be very hot, e.g. the engine, the radiator and parts of the exhaust system.

- ▶ Allow the engine to cool down and only touch component parts described in the following.

⚠ WARNING Risk of fire and injury from engine oil

If engine oil comes into contact with hot component parts in the engine compartment, it may ignite.

- ▶ Make sure that no engine oil is spilled next to the filler opening.
- ▶ Allow the engine to cool off and thoroughly clean the engine oil from component parts before starting the vehicle.

! NOTE Engine damage caused by an incorrect oil filter, incorrect oil or additives

- ▶ Do not use engine oils or oil filters which do not correspond to the specifications explicitly prescribed for the service intervals.
- ▶ Do not alter the engine oil or oil filter in order to achieve longer change intervals than prescribed.
- ▶ Do not use additives.

- ▶ Follow the instructions in the service interval display regarding the oil change.

! **NOTE** Damage caused by topping up too much engine oil

Too much engine oil can damage the engine or the catalytic converter.

- ▶ Have excess engine oil removed at a qualified specialist workshop.

i Depending on the engine, the cap may be installed in the engine compartment in different locations.

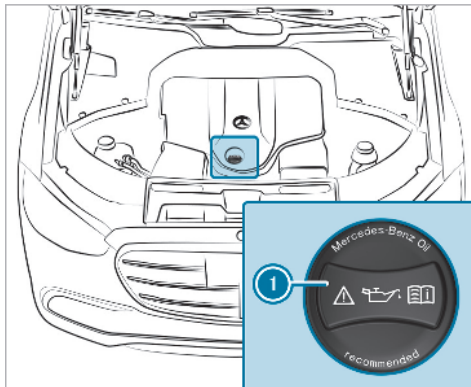

- ▶ Turn cap **1** anti-clockwise and remove it.
- ▶ Top up the engine oil.
- ▶ Replace cap **1** and turn it clockwise until it engages.
- ▶ Check the oil level again (→ page 458).

Checking the coolant level

! **WARNING** Risk of burns from hot component parts in the engine compartment

Certain components in the engine compartment can be very hot, e.g. the engine, the radiator and parts of the exhaust system.

- ▶ Allow the engine to cool down and only touch component parts described in the following.

! **WARNING** Risk of scalding from hot coolant

If you open the cap, you could be scalded.

- ▶ Let the motor cool down before opening the cap.
- ▶ When opening the cap, wear protective gloves and safety glasses.
- ▶ Open the cap slowly to release pressure.

- ▶ Only have coolant checked or refilled at a qualified specialist workshop.

Topping up the windscreen washer system

- ⚠ WARNING** Risk of burns from hot component parts in the engine compartment

Certain components in the engine compartment can be very hot, e.g. the engine, the radiator and parts of the exhaust system.

- ▶ Allow the engine to cool down and only touch component parts described in the following.

- ⚠ WARNING** Danger of burns when opening the bonnet

If you open the engine bonnet when the engine has overheated or during a fire in the engine compartment, you could come into contact with hot gases or other escaping operating fluids.

- ▶ Before opening the bonnet, allow the engine to cool down.
- ▶ In the event of a fire in the engine compartment, keep the engine bonnet closed and call the fire service.

- ⚠ WARNING** - Risk of fire and injury due to windscreen washer concentrate

Windscreen washer concentrate is highly flammable. It could ignite if it comes into contact with hot engine component parts or the exhaust system.

- ▶ Make sure that no windscreen washer concentrate spills out next to the filler opening.

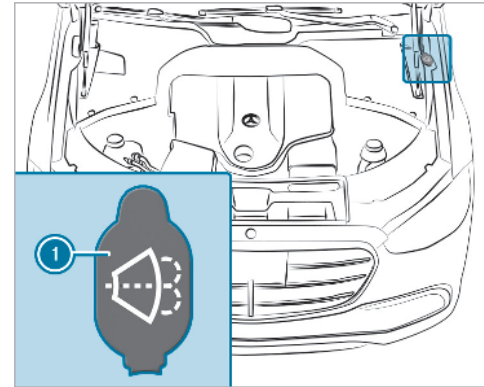

- ▶ Remove cap ① by the tab, place on the edge of the filler opening and engage in place.
- ▶ Top up the washer fluid.

Keeping the air-water duct free

- ▶ Keep the area between the bonnet and the windscreen free of deposits, e.g. ice, snow and leaves.

Cleaning and care

Information on washing the vehicle in a car wash

⚠ WARNING Risk of an accident due to reduced braking power after washing the vehicle

Braking efficiency is reduced after washing the vehicle.

- ▶ After the vehicle has been washed, brake carefully while paying attention to the traffic conditions until braking power has been fully restored.

! NOTE Damage from automatic braking

If one of the following functions is switched on, the vehicle brakes automatically in certain situations:

- Active Brake Assist
- Active Distance Assist DISTRONIC
- HOLD function

- Active Parking Assist

To avoid damage to the vehicle, deactivate these systems in the following or similar situations:

- ▶ During towing
- ▶ In a car wash

! NOTE Damage due to unsuitable car wash

- ▶ Before driving into a car wash make sure that the car wash is suitable for the vehicle dimensions.
- ▶ Ensure there is sufficient ground clearance between the underbody and the guide rails of the car wash.
- ▶ Ensure that the clearance width of the car wash, in particular the width of the guide rails, is sufficient.

To avoid damage to your vehicle when using a car wash, ensure the following beforehand:

- Active Distance Assist DISTRONIC and the HOLD function are deactivated.
 - the 360° Camera or the reversing camera is switched off.
 - the side windows and sliding sunroof are completely closed.
 - the blower for the ventilation/heating is switched off.
 - the windscreen wiper switch is in position **0**.
 - the key is at a distance of at least 3 m away from the vehicle, otherwise the boot lid could open unintentionally.
 - in car washes with a conveyor system: neutral **N** is engaged.
- i** In car washes with a conveyor system: if you would like to leave the vehicle while it is being washed, make sure the key is located in the vehicle. The park position **P** is otherwise automatically engaged.

- ⓘ If, after the car wash, you remove the wax from the windscreen and wiper rubbers, this will prevent smearing and reduce wiper noise.

Information on using a high-pressure cleaner

⚠ WARNING Risk of an accident when using high-pressure cleaners with round-spray nozzles

The water jet can cause externally invisible damage.

Components damaged in this way may unexpectedly fail.

- ▶ Do not use a high-pressure cleaner with round-spray nozzles.
- ▶ Have damaged tyres or chassis parts replaced immediately.

To avoid damage to your vehicle, observe the following when using a high-pressure cleaner:

- keep the key at least 3 m away from the vehicle. Otherwise the boot lid could open unintentionally.
- maintain a distance of at least 30 cm to the vehicle.
- **vehicles with decorative foil:** parts of your vehicle are covered with a decorative foil. Maintain a distance of at least 70 cm between the foil-covered parts of the vehicle and the nozzle of the high-pressure cleaner. Move the high-pressure cleaner nozzle around whilst cleaning. The water temperature of the high-pressure cleaner must not exceed 60°C.
- observe the information on the correct distance in the equipment manufacturer's operating instructions.
- do not point the nozzle of the high-pressure cleaner directly at sensitive parts such as tyres, gaps, electrical components, batteries, light sources and ventilation slots.

Washing the vehicle by hand

Observe the legal requirements, e.g. in a number of countries, washing by hand is only permitted in specially designated wash bays.

- ▶ Use a mild cleaning agent, e.g. car shampoo.
- ▶ Wash the vehicle with lukewarm water using a soft car sponge. When doing so, do not expose the vehicle to direct sunlight.
- ▶ Carefully hose the vehicle off with water and dry using a chamois. Take care not to point the water jet directly towards the air inlet grille below the bonnet.

Notes on paintwork/matt finish paintwork care

Observe the notes on cleaning and care to avoid damaging the paintwork and interfering with the driver assistance systems.

Paint

- Insect remains: soak with insect remover and rinse off the treated areas afterwards.

- Bird droppings: soak with water and rinse off afterwards.
- Tree resin, oils, fuels and greases: remove by rubbing gently with a cloth soaked in petroleum ether or lighter fluid.
- Coolant and brake fluid: remove with a damp cloth and clean water.
- Tar stains: use tar remover.
- Wax: use silicone remover.
- Do not attach stickers, films or similar materials. Only have film attached to the bumper at a qualified specialist workshop.
- Remove dirt immediately, where possible.

Matt finish

- Only use care products approved for Mercedes-Benz.
- Do not attach stickers, films or similar materials. Only have film attached to the bumper at a qualified specialist workshop.
- Do not polish the vehicle and light-alloy wheels.

- Only use car washes that correspond to the latest engineering standards.
- Do not use car wash programmes with a final hot wax treatment.
- Do not use paint cleaners, buffing or polishing products, gloss preservers, e.g. wax.

In the event of paintwork damage:

- Always have paintwork repairs carried out at a qualified specialist workshop.
- Make sure the radar sensors function (→ page 204).

Notes on cleaning decorative foils

Observe the notes on matt finish care in the chapter "Notes on paintwork/matt finish paintwork care" (→ page 463). They also apply to matt decorative foils.

Observe the notes on cleaning decorative foils to avoid vehicle damage.

Cleaning

- For cleaning, use plenty of water and a mild cleaning agent without additives or abrasive

substances, e.g. a car shampoo approved for Mercedes-Benz.

- Remove dirt immediately, where possible, whilst avoiding rubbing too hard. There is otherwise a risk of damaging the decorative foil irreparably.
- If there is dirt on the finish or if the decorative foil is dull: use the Paint Cleaner recommended and approved for Mercedes-Benz.
- Insect remains: soak with insect remover and rinse off the treated areas afterwards.
- Bird droppings: soak with water and rinse off afterwards.
- To prevent water stains, dry a foil-wrapped vehicle with a soft, absorbent cloth after every car wash.

Avoiding damage to the decorative foil

- The service life and colouring of decorative foils are impaired by:
 - sunlight
 - temperature, e.g. hot air blower
 - weather conditions

- stone chippings and dirt
- chemical cleaning agents
- oily products
- Do not use polish on matt decorative foil. Polishing will have the effect of shining the foil-wrapped surface.
- Do not treat matt or structured decorative foils with wax. Permanent stains may occur.

Scratches, corrosive deposits, areas affected by corrosion and damage caused by incorrect care cannot always be completely repaired. In such cases, visit a qualified specialist workshop.

You can obtain more information on care and cleaning products from the manufacturer.

In the case of foil-wrapped surfaces, optical differences may occur between the surfaces that were not protected by a decorative foil after removing a decorative foil.

- ① Have work or repairs to decorative foils carried out at a qualified specialist workshop, e.g. in a Mercedes-Benz Service Centre.

Notes on care of car parts

⚠ WARNING Risk of entrapment if the windscreen wipers are switched on while the windscreen is being cleaned

If the windscreen wipers are set in motion while you are cleaning the windscreen or wiper blades, you can be trapped by the wiper arm.

- ▶ Always switch off the windscreen wipers and the ignition before cleaning the windscreen or wiper blades.

⚠ WARNING Risk of burns from the tailpipe and tailpipe trims

The exhaust tailpipe and tailpipe trims can become very hot. If you come into contact with these parts of the vehicle, you could burn yourself.

- ▶ Always be particularly careful around the tailpipe and the tailpipe trims and supervise children especially closely in this area.

- ▶ Allow vehicle parts to cool down before touching them.

Observe the notes on cleaning and care of the following vehicle parts to avoid damage.

Wheels/rims

- Use water and acid-free wheel cleaners.
- Do not use acidic wheel cleaners to remove brake dust. This could damage wheel bolts and brake components.
- To avoid corrosion of the brake discs and brake pads, drive the vehicle for a few minutes after cleaning before parking it. The brake discs and brake pads warm up and dry out.

Windows

- Clean windows inside and outside with a damp cloth and with a cleaning agent recommended for Mercedes-Benz.
- Do not use dry cloths or abrasive or solvent-based cleaning agents to clean the inside of windows.

Wiper blades

- Fold out the wiper blades and clean them using a damp cloth.
- Do not clean the wiper blades too often.

Exterior lighting

- Clean the lenses with a wet sponge and mild cleaning agent, e.g. car shampoo.
- Only use cleaning agents or cleaning cloths that are suitable for plastic lenses.

Sensors

- Clean the sensors in the front and rear bumper and in the radiator grille with a soft cloth and car shampoo.
- When using a high-pressure cleaner, maintain a minimum distance of 30 cm.

Reversing camera and 360° Camera

- Switch on the power supply or the ignition to open the front camera cover.
- Use clean water and a soft cloth to clean the camera lens.
- Do not use a high-pressure cleaner.

Tailpipes

- Clean with a cleaning agent recommended for Mercedes-Benz, especially in the winter and after washing the vehicle.
- Do not use acidic cleaning agents.

Trailer hitch

- Remove traces of rust on the ball, e.g. with a wire brush.
- Remove dirt with a lint-free cloth.
- After cleaning, oil or grease the ball head lightly.
- Observe the notes on care in the trailer hitch manufacturer's operating instructions.
- Do not clean the ball neck with a high-pressure cleaner or solvent.

Notes on care of the interior

⚠ WARNING Risk of injury from plastic parts breaking off after the use of solvent-based care products

Care and cleaning products containing solvents can cause surfaces in the cockpit to become porous. When the airbags are deployed, plastic parts may break away.

▶ Do not use any care or cleaning products containing solvents to clean the cockpit.

⚠ WARNING Risk of injury or death from bleached seat belts

Bleaching or dyeing seat belts can severely weaken them.

This can, for example, cause seat belts to tear or fail in an accident.

▶ Never bleach or dye seat belts.

Observe the notes on cleaning and care to avoid vehicle damage.

Seat belts

- Clean with lukewarm and soapy water.
- Do not use chemical cleaning agents.
- Do not dry seat belts by heating them to over 80 °C or exposing them to direct sunlight.

Display

- Switch off the display and let it cool down.
- Clean the surface carefully with a microfibre cloth and a suitable display care product (TFT/LCD).
- Do not use any other agents.

Plastic trim

- Clean with a damp microfibre cloth.
- For heavy soiling: use a care product recommended for Mercedes-Benz.
- Do not attach stickers, films or similar materials.
- Do not allow cosmetics, insect repellent or sun cream to come in contact with the plastic trim.

Real wood/trim elements

- Clean with a microfibre cloth.

- Black piano-lacquer look: clean with a damp cloth and soapy water.
- For heavy soiling: use a care product recommended for Mercedes-Benz.
- Do not use solvent-based cleaning agents, polishes or waxes.

Roof lining

- Clean with a brush or dry shampoo.

Carpet

- Use a carpet and textile cleaning agent recommended for Mercedes-Benz.

Genuine leather seat covers

- Clean with a damp cloth and then wipe with a dry cloth.
- Leather care: use a leather care agent that has been recommended for Mercedes-Benz.
- Do not allow the leather to become too damp.
- Do not use a microfibre cloth.

DINAMICA seat covers

- Clean with a damp cloth.

- Do not use a microfibre cloth.

Cloth seat covers

- Clean with a damp microfibre cloth and 1% soap solution and allow to dry.

EASY-PACK boot box

- Clean with a damp cloth.
- Do not use any alcohol-based thinners, petrol or abrasive cleaning agents.

Emergency

Removing the safety vest

The safety vests are located in storage spaces in the front door.

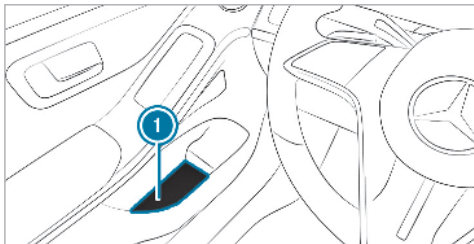

▶ Take the safety vest bag out of storage space ①.

▶ Open the safety vest bag and pull out the safety vest.

ⓘ Safety vests can also be stored in the rear door storage spaces.

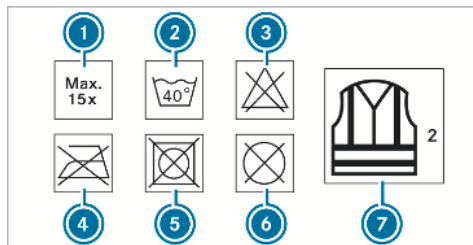

- ① Maximum number of washes
- ② Maximum wash temperature
- ③ Do not bleach
- ④ Do not iron
- ⑤ Do not tumble dry
- ⑥ Do not dry clean
- ⑦ This is a class 2 vest

The requirements defined by the legal standard are only fulfilled in the following cases:

- if the safety vest is the correct size
- the safety vest is fully closed whilst being worn

Replace the safety vest in the following cases:

- the reflective strips are damaged or dirt on the reflective strips can no longer be removed
- the maximum number of washes is exceeded
- the fluorescence has faded

Warning triangle

Removing the warning triangle

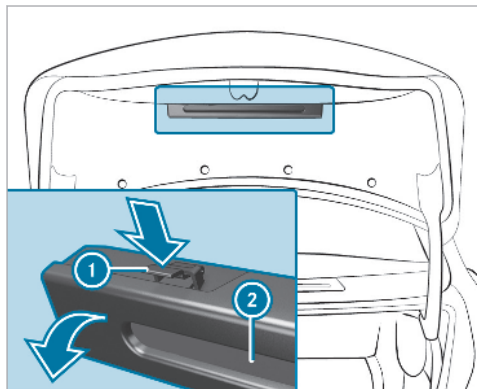

- ▶ Push both sides of warning triangle holder ① in the direction of the arrow and open it.
- ▶ Remove warning triangle ②.

Setting up the warning triangle

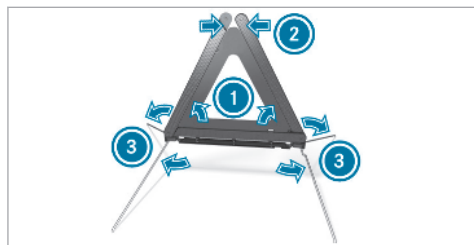

- ▶ Fold side reflectors ① upwards to form a triangle and attach at the top using upper press-stud ②.
- ▶ Fold legs ③ down and out to the side.

First-aid kit (soft sided)

First-aid kit (soft sided) ① is located on the right-hand side of the boot and is secured with Velcro strip ②.

