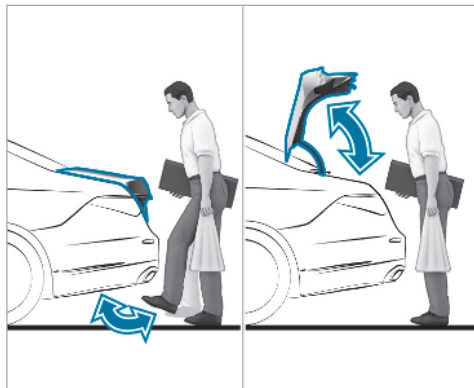

HANDS-FREE ACCESS function

With HANDS-FREE ACCESS you can open, close or interrupt boot lid movement by performing a kicking movement under the rear bumper.

The kicking movement triggers the opening or closing process alternately.

Observe the notes when opening (→ page 76) and closing (→ page 77) the boot lid.

i A warning tone sounds while the boot lid is opening or closing.

⚠ WARNING Risk of burns caused by a hot exhaust system

The vehicle exhaust system can become very hot. If you use HANDS-FREE ACCESS, you could burn yourself by touching the exhaust system.

▶ Always ensure that you only make a kicking movement within the detection range of the sensors.

! **NOTE** Damage to the vehicle caused by unintentionally opening the boot lid:

- when using an automatic car wash
- when using a high pressure cleaner

▶ Deactivate KEYLESS-GO or make sure that the key located is at least 3 m away from the vehicle in such situations.

When making the kicking movement, make sure that your feet are firmly on the ground, otherwise you could lose your balance, e.g. on ice.

Observe the following notes:

- The key is behind the vehicle.
- Stand at least 30 cm away from the vehicle while performing the kicking movement.
- Do not come into contact with the bumper while making the kicking movement.
- Do not carry out the kicking movement too slowly.
- The kicking movement must be towards the vehicle and back again.

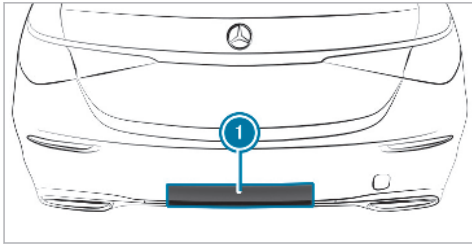

① Detection range of the sensors

If several consecutive kicking movements are not successful, wait ten seconds.

System limits

The system may be impaired or may not function in the following cases:

- The area around the sensor is dirty, e.g. due to road salt or snow.
- The kicking movement is made using a prosthetic leg.

The boot lid could be opened or closed unintentionally, in the following situations:

- If a person's arms or legs are moving in the sensor detection range, e.g. when polishing the vehicle or picking up objects.
- If objects are moved or placed behind the vehicle, e.g. tensioning straps or luggage.
- If clamping straps, tarpaulins or other coverings are pulled over the bumper.
- If a protective mat with a length reaching over the boot sill down into the detection range of the sensors is used.
- If the protective mat is not secured correctly.
- When working on the trailer coupling, trailers or rear bicycle racks.

Deactivate KEYLESS-GO (→ page 68) or do not carry the key about your person in such situations.

Switching separate boot locking on and off

Multimedia system:

- ➔ ➔ Settings ➔ Vehicle
- ➔ Locking function

Switching separate boot locking on

- ▶ Select **Block boot**.
- ▶ Create a PIN.
- ▶ Press **OK** to confirm the PIN.
- ▶ Enter the PIN again and confirm it.
The boot will remain locked if you unlock the vehicle centrally.
- ⓘ If an accident has been detected, the boot will unlock even if separate locking is switched on.
- ⓘ You can open the boot with the emergency key even while boot locking is active. Separate boot locking will remain active.

Switching separate boot locking off

- ▶ Select **Block boot**.

- ▶ Enter the PIN.
If the PIN is correct, separate boot locking will be switched off and the PIN deleted.

Resetting the PIN

If you have forgotten the PIN, you can switch off separate boot locking with the emergency key.

- ▶ Select **Block boot**.
- ▶ Confirm **Forgotten PIN?**.
- ▶ Unlock the boot within 30 seconds with the emergency key.
Separate boot locking will be switched off and the PIN deleted.

Unlocking the boot lid using the emergency key

- ▶ Take the emergency key element out of the key (→ page 69).
- ▶ Insert the emergency key into the boot lock as far as it will go.

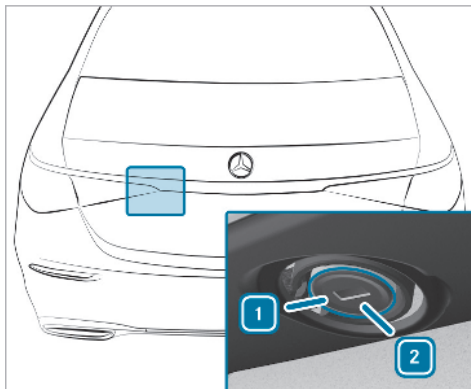

- ▶ Turn the emergency key anti-clockwise from position **1** to position **2**.
 - ▶ Turn the emergency key back to position **1** and remove it.
- i** If you use the emergency key to unlock and open the boot lid, the anti-theft alarm system will be triggered.

Activating/deactivating the boot lid opening limiter

Multimedia system:

- ▶ ▶ Settings ▶ Vehicle
- ▶ Other functions

- ▶ Activate or deactivate **Opening height limiter**.

This function allows you to avoid bumping the boot lid on a low garage ceiling, for example.

Side windows

Opens and closes the side windows

⚠ WARNING Risk of becoming trapped when opening a side window

When you open a side window, parts of the body could be drawn in or become trapped between the side window and window frame.

- ▶ When opening, make sure that nobody is touching the side window.

- ▶ If someone is trapped, release the button immediately or pull it in order to close the side window again.

⚠ WARNING Risk of becoming trapped when closing a side window

When closing a side window, body parts could be trapped in the closing area in the process.

- ▶ When closing, make sure that no body parts are in the closing area.
- ▶ If someone is trapped, release the button immediately or press the button in order to reopen the side window.

⚠ WARNING Risk of becoming trapped when children operate the side windows

Children could become trapped if they operate the side windows, particularly when unattended.

- ▶ Activate the child safety lock for the rear side windows.

- ▶ When leaving the vehicle, always take the key with you and lock the vehicle.
- ▶ Never leave children unattended in the vehicle.

Requirements:

- The power supply or the ignition is switched on.

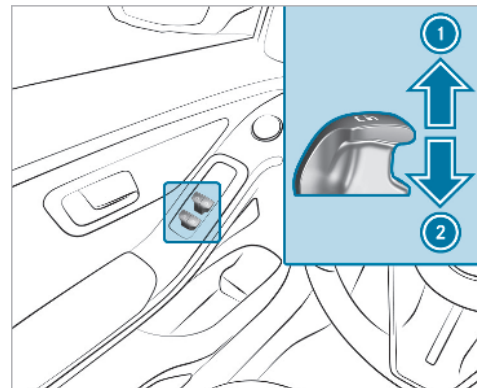

- ① Closing
- ② Opening

The buttons on the driver's door take precedence.

- ▶ **To start automatic operation:** press the  button beyond the point of resistance or pull and release it.

▶ **To interrupt automatic operation:** press or pull the  button again.

When the vehicle is switched off, the side windows can continue being operated.

This function is available for around four minutes or until a front door is opened.

❗ **Vehicles with electric roller sunblinds on rear doors on the left and right:** the buttons for the rear side windows also open and close the roller sunblinds (→ page 91).

Automatic reversing function of the side windows

If an object impedes a side window during the closing process, the side window will open again automatically. The automatic reversing function is only an aid and is not a substitute for your attentiveness.

▶ During the closing process, make sure that no body parts are in the closing area.

⚠ WARNING Risk of becoming trapped despite there being reversing protection on the side window

The reversing function does not react:

- to soft, light and thin objects, e.g. fingers.
- during resetting.

The reversing function cannot prevent someone from becoming trapped in these situations.

- ▶ During the closing process, make sure that no body parts are in the closing area.
- ▶ If someone becomes trapped, press the  button to open the side window again.

Automatic function of the side windows

In the following cases, the side windows will be closed automatically when the vehicle is switched off:

- if it starts to rain (detected by the rain sensor on the windscreen)
- in extreme temperatures
- after a certain time (depending on the on-board electrical system voltage)
- if there is a malfunction in the power supply

The side windows will be closed as far as the ventilation position.

Vehicles with a panorama sliding sunroof: the side windows will be closed completely if the sliding sunroof is open.

If the side windows are obstructed during automatic closing, the side window concerned will open again slightly. The automatic function for the sliding sunroof and the side windows will then be deactivated.

Convenience opening (ventilating the vehicle before starting a journey)

⚠ WARNING Risk of entrapment when opening a side window

When opening a side window, parts of the body could be drawn in or become trapped between the side window and window frame.

- ▶ When opening, make sure that nobody is touching the side window.
- ▶ Release the button immediately if somebody becomes trapped.

- ▶ Press and hold the  button on the key. The following functions are performed:
 - The vehicle is unlocked.
 - The side windows are opened.
 - The panoramic sliding sunroof is opened.
 - The seat ventilation of the driver's seat is switched on.

- ① If the roller sunblinds of the panoramic sliding sunroof are closed, the roller sunblinds are opened first.
- ① If the roller sunblinds of the rear doors are closed, the roller sunblinds are opened first.

▶ **To interrupt convenience opening:** release the  button.



▶ **To continue convenience opening:** press and hold the  button again.

Convenience closing (closing the vehicle from outside)

⚠ WARNING Risk of entrapment caused by inadvertent convenience closing

When the convenience closing feature is operating, parts of the body could become trapped in the closing area of the side window and the sliding sunroof.

- ▶ Observe the complete closing procedure when using convenience closing.
- ▶ When closing, make sure that no body parts are in the closing area.

- ▶ Press and hold the  button on the key. The following functions are performed:
 - The vehicle is locked.
 - The side windows are closed.
 - The panoramic sliding sunroof is closed.
- ▶ **To interrupt convenience closing:** release the  button.
- ▶ **To close the roller sunblinds:** press and hold the  button again.
- ① Convenience closing can also be operated with KEYLESS-GO (→ page 73).

Problems with the side windows

⚠ WARNING Risk of becoming trapped or fatally injured if reversing protection is not activated

If you close a side window again immediately after it has been blocked, the side window will close with increased or maximum force. The reversing function is then not active and body parts may become trapped.

- ▶ Make sure that no parts of the body are in the closing area.
- ▶ To stop the closing process, release the button or press the button again to reopen the side window.

A side window cannot be closed and you cannot see the cause.

- ▶ Check to see whether any objects are in the window guide.
- ▶ Adjust the side windows.

Adjusting the side windows

If a side window is obstructed during closing and reopens again immediately:

- ▶ Immediately after this, pull the corresponding button again until the side window has closed and hold the button for at least one more second (re-adjustment). The side window will be closed without the automatic reversing function.

If the side window is obstructed again and reopens again immediately:

- ▶ Immediately after this, pull the corresponding button again until the side window has closed and hold the button for at least one more second (follow-up adjustment). The side window will be closed without the automatic reversing function.

The side windows cannot be opened or closed using the convenience opening feature.

- The key battery is weak or discharged.
- ▶ Check the battery using the indicator lamp and replace if necessary (→ page 69).

Sliding sunroof

Opening and closing the sliding sunroof

- ⓘ The term "sliding sunroof" refers to the panorama sliding sunroof.

⚠ WARNING Risk of becoming trapped when the sliding sunroof is being opened and closed

Body parts may become trapped in the range of movement.

- ▶ During the opening and closing process, make sure that no body parts are in the range of movement.
- ▶ If someone is trapped, release the control panel immediately.

or

- ▶ Touch the control panel during automatic operation. The opening/closing process will be stopped.

⚠ WARNING Risk of entrapment if the sliding sunroof is operated by children

Children operating the sliding sunroof could get caught in the moving parts, particularly if unattended.

- ▶ Never leave children unattended in the vehicle.
- ▶ When leaving the vehicle, always take the key with you and lock the vehicle.

⚠ WARNING Risk of becoming trapped when the roller sunblind is being opened and closed

Body parts may become trapped between the roller sunblind and frame or sliding roof.

- ▶ During the opening or closing process, make sure that no body parts are in the roller sunblind's range of movement.
- ▶ If someone is trapped, release the control panel immediately.

or

- ▶ Touch the control panel during automatic operation. The opening/closing process will be stopped.

! NOTE Malfunction due to snow and ice

Snow and ice may cause the sliding sunroof to malfunction.

- ▶ Open the sliding sunroof only if it is free of snow and ice.

! NOTE Damage caused by protruding objects

Objects that protrude from the sliding sunroof may damage the sealing strips.

- ▶ Do not allow anything to protrude from the sliding sunroof.

! NOTE Important points to remember when a roof luggage rack is fitted

When a roof luggage rack is fitted, raising or opening the sliding sunroof may be limited.

- ▶ Check whether the sliding sunroof can be raised or opened when a roof luggage rack is fitted.

- ▶ If in doubt, do not raise or open the sliding sunroof.

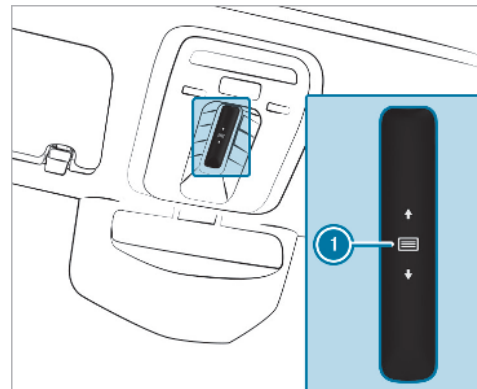

The sliding sunroof and the front roller sunblind are operated using control panel ①.

The panorama sliding sunroof can be operated only when the roller sunblind is open.

Restriction: do not open the sliding sunroof if a roof luggage rack is fitted. The sliding sunroof

will then encounter resistance and subsequently remain in a raised position.

- ▶ **To open:** swipe backwards across control panel ① and hold.
- ▶ **To close:** swipe forwards across control panel ① and hold.
- ▶ **To raise or lower:** press control panel ① briefly.
- ▶ **To start automatic operation:** swipe forwards or backwards across control panel ①.
- ▶ **To cancel automatic operation:** press control panel ① again. The opening/closing process will be stopped.

Operating the rear roller sunblind from the front

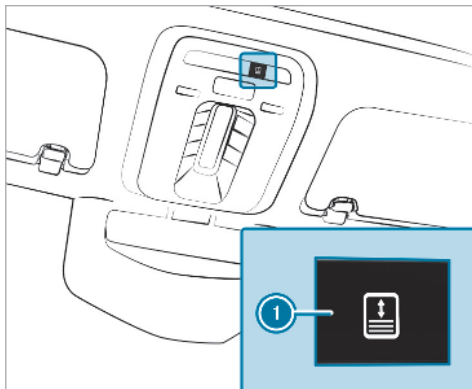

- ▶ **To open or close:** press button ①.
- ▶ **To stop:** press button ① again.

You must first open or close the rear roller sunblind fully before you can move it in the other direction.

Operating the rear roller sunblind from the rear

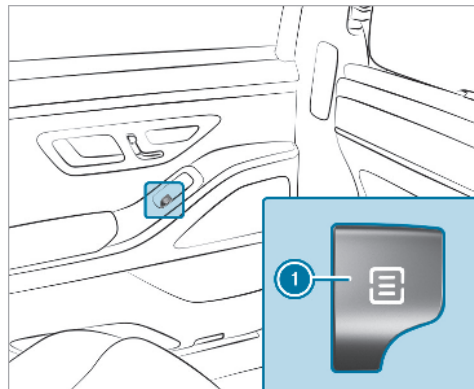

- ▶ **To open/close manually:** push or pull button ① to the point of resistance and hold it until the roller sunblind has reached the desired position.
- ▶ **To open/close fully:** push or pull button ① beyond the point of resistance and release it.

Automatic reversing function of the sliding sunroof

If an object is obstructing the sliding sunroof during the closing process, the sliding sunroof will open again automatically. The automatic reversing function is only an aid and is not a substitute for your attentiveness.

- ▶ During the closing process, make sure that no body parts are in the closing area.

⚠ WARNING Risk of becoming trapped despite reversing function

The reversing function will not react:

- to soft, light and thin objects, e.g. fingers.
- towards the end of the closing procedure.
- during resetting.
- when you close the sliding sunroof again manually immediately after automatic reversing.

- ▶ During the closing process, make sure that no body parts are in the closing area.

- ▶ If someone is trapped, release the control panel immediately.

or

- ▶ Touch the control panel during automatic closing.
The closing process will be stopped.

Automatic reversing function of the roller sunblind

If an object is obstructing the roller sunblind during the closing process, the roller sunblind will open again automatically. The automatic reversing function is only an aid and is not a substitute for your attentiveness.

- ▶ When closing the roller sunblind, make sure that no body parts are in the range of movement.

⚠ WARNING Risk of becoming trapped despite reversing function

In particular, the reversing function does not react to soft, light and thin objects, e.g. fingers.

- ▶ When closing the roller sunblind, make sure that no body parts are in the range of movement.

- ▶ If someone is trapped, release the control panel immediately.

or

- ▶ Touch the control panel during automatic closing.
The closing process will be stopped.

Automatic functions of the sliding sunroof

- ① The term "sliding sunroof" also refers to the panorama sliding sunroof.

By touching or pressing the control panel, (→ page 86) you can cancel the automatic functions "Rain closing function when driving" and "Automatic lowering".

The sliding sunroof will be closed automatically when the vehicle has been switched off in the following situations:

- if it starts to rain (detected by the rain sensor on the windscreen)

- in the event of extreme outside temperatures
- after a certain time (depending on the on-board electrical system voltage)
- if there is a malfunction in the power supply

The sliding sunroof will then rise at the rear in order to continue ventilating the vehicle interior.

If the sliding sunroof is obstructed during an automatic closing procedure, the roof will be opened again slightly. The automatic function for the sliding sunroof and the side windows will then be deactivated.

Rain closing function when driving

Vehicles with a panorama sliding sunroof: if it starts to rain, the raised sliding sunroof will automatically be lowered while the vehicle is in motion.

Automatic lowering function

Vehicles with a panorama sliding sunroof: if the sliding sunroof is raised at the rear, it will automatically be lowered slightly at higher speeds. At low speeds, it will be raised again automatically.

⚠ WARNING Risk of becoming trapped by automatic lowering of the sliding sunroof

At higher speeds, the raised sliding sunroof will automatically be lowered slightly at the rear.

- ▶ Make sure that nobody reaches into the sliding sunroof's range of movement while the vehicle is in motion.
- ▶ If someone becomes trapped, touch the control panel.

Problems with the sliding sunroof

⚠ WARNING Risk of becoming trapped or fatal injuries when closing the sliding sunroof again

If you close the sliding sunroof again immediately after it has been blocked or reset, the sliding sunroof will close with increased or maximum force.

The reversing function will not be active then.

▶ Make sure that no parts of the body are in the closing area.

▶ If someone is trapped, release the control panel immediately.

or

▶ Touch the control panel during automatic closing.

The closing process will be stopped.

The sliding sunroof cannot be closed and you cannot see the cause.

i The term "sliding sunroof" refers to the panorama sliding sunroof.

If the sliding sunroof is obstructed during closing and reopens again slightly:

▶ Immediately after automatic reversing, press and hold the control panel (→ page 86) until the sliding sunroof is closed. The sliding sunroof will be closed with increased force.

If the sliding sunroof is obstructed again and reopens again slightly:

- ▶ Repeat the previous step.
The sliding sunroof will be closed with even greater force.

The sliding sunroof or the front roller sunblind does not operate smoothly.

- ▶ Reset the sliding sunroof and the roller sunblind.

Resetting the sliding sunroof and the roller sunblind

- ▶ Press and hold the control panel (→ page 86) repeatedly until the sliding sunroof is completely closed.
- ▶ Press and hold the control panel for another second.
- ▶ Press and hold the control panel until the front roller sunblind is completely closed.
- ▶ Press and hold the control panel for another second.
- ▶ Use automatic operation to fully open and then close the sliding sunroof.

The rear roller sunblind does not operate smoothly.

- ▶ Reset the rear roller sunblind.

Resetting the rear roller sunblind

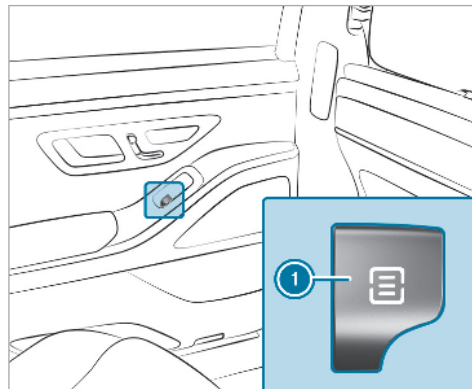

- ▶ Pull and hold button ① repeatedly until the rear roller sunblind is fully closed.
- ▶ Pull button ① for another second.

- ▶ Use automatic operation to fully open and then close the rear roller sunblind.

Roller sunblinds

Extending or retracting the roller sunblinds on the rear side windows

The roller sunblinds for the rear side windows can be operated with the buttons for the side windows.

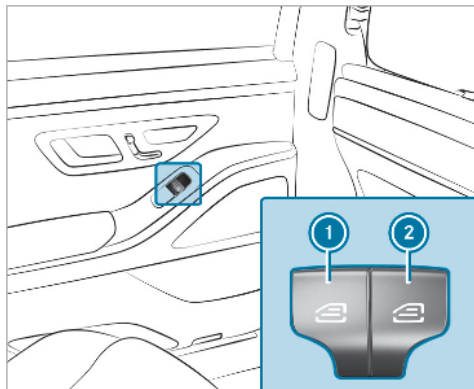

- ① Rear left side window / roller sunblind
- ② Rear right side window / roller sunblind

- ▶ **To close fully:** pull the corresponding button when the side window is closed or is in the process of closing.
- ▶ **To open fully:** press the corresponding button.

Extending or retracting the rear-window roller sunblind

⚠ WARNING Risk of becoming trapped when extending or retracting the roller sunblind

Body parts may become trapped in the roller sunblind's range of movement.

- ▶ Ensure there are no body parts in the range of movement.
- ▶ If someone becomes trapped, briefly press the button again. The opening or closing process will briefly be stopped. The roller sunblind will then return to its starting position.

Extending or retracting from the driver's seat

! NOTE Damage caused by objects

Objects could cause malfunctions of the roller sunblind.

- ▶ Make sure that the roller sunblind can move freely.

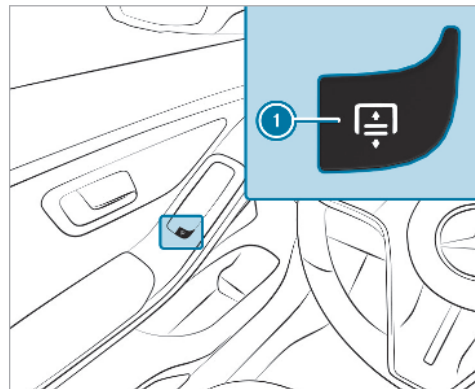

- ▶ Press button ①.
- ① Depending on the model, button ① is located in the door control panel on the driver's side.

Extending or retracting from the rear compartment

! NOTE Damage caused by objects

Objects could cause malfunctions of the roller sunblind.

- ▶ Make sure that the roller sunblind can move freely.

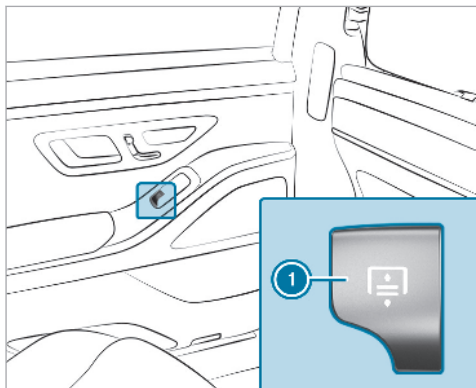

▶ **To extend:** pull switch ①.

▶ **To retract:** press switch ①.

When the child safety lock for the rear side windows is activated, switch ① cannot be operated.

Anti-theft protection

Function of the immobiliser

The immobiliser prevents your vehicle from being started without the correct key.

The immobiliser is automatically activated when the ignition is switched off and deactivated when the ignition is switched on.

ATA (Anti-Theft Alarm system)

Function of the ATA system

If the ATA system is primed, a visual and audible alarm is triggered in the following situations:

- when a door is opened
- when the boot lid is opened
- when the bonnet is opened

- when interior protection is triggered (→ page 95)
- when tow-away protection is triggered (→ page 94)

The ATA system is primed automatically after approximately ten seconds in the following situations:

- after locking the vehicle with the key
- after locking the vehicle using KEYLESS-GO

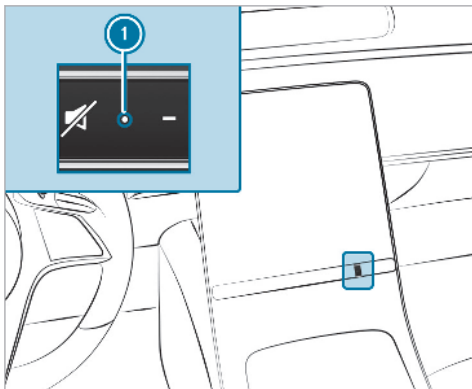

Indicator lamp ① flashes when the ATA system is primed.

The ATA system is deactivated automatically in the following situations:

- after unlocking the vehicle with the key
- after unlocking the vehicle using KEYLESS-GO

- after pressing the start/stop button with the key in the stowage compartment (→ page 175)

ⓘ When the Mercedes-Benz emergency call system is active and the alarm stays on for more than 30 seconds, a message is automatically sent to the Customer Assistance Centre (→ page 409).

Deactivating the ATA

▶ Press the ,  or  button on the key.

or

▶ Press the start/stop button with the key in the stowage compartment (→ page 175)

Deactivating the alarm using KEYLESS-GO

▶ Grasp the outside door handle with the key outside the vehicle.

Function of tow-away protection

An audible and visual alarm is triggered if an alteration to your vehicle's angle of inclination is detected while tow-away protection is primed.



Tow-away protection is automatically primed after approximately 60 seconds:

- after locking the vehicle with the key
- after locking the vehicle using KEYLESS-GO

Tow-away protection is only primed when the following components are closed:

- the doors
- the boot lid

Tow-away protection is automatically deactivated:

- after pressing the  or  button on the key
- after pressing the start/stop button with the key in the stowage compartment (→ page 175)
- after unlocking the vehicle using KEYLESS-GO
- when using HANDS-FREE ACCESS

Information on collision detection on a parked vehicle (→ page 202).

Priming/deactivating tow-away protection

Multimedia system:

  **»» Settings** **»» Vehicle**
»» Protection functions

▶ Prime or deactivate **Tow-away protection**.

Tow-away protection is primed again in the following cases:

- The vehicle is unlocked again.
- A door is opened.
- The vehicle is locked again.

Function of interior protection

When interior protection is primed, a visual and audible alarm is triggered if movement is detected in the vehicle interior.



Interior protection is primed automatically after approximately ten seconds:

- after locking the vehicle with the key
- after locking the vehicle using KEYLESS-GO

Interior protection is only primed when the following components are closed:

- the doors
- the boot lid

Interior protection is automatically deactivated:

- after pressing the  or  button on the key
- after pressing the start/stop button with the key in the stowage compartment (→ page 175)
- after unlocking the vehicle using KEYLESS-GO
- when using HANDS-FREE ACCESS

The following situations can lead to a false alarm:

- moving objects such as mascots in the vehicle interior
- when the side window is open
- when the panoramic sliding sunroof is open

Priming/deactivating interior protection

Multimedia system:

  **»» Settings** **»» Vehicle**
»» Protection functions

▶ Prime or deactivate **Interior motion sensor**.

Interior protection is primed again in the following cases:

- The vehicle is unlocked again.
- A door is opened.
- The vehicle is locked again.

Notes on the correct driver's seat position

⚠ WARNING Risk of accident due to adjusting vehicle settings while the vehicle is in motion

You could lose control of the vehicle in the following situations in particular:

- If you adjust the driver's seat, the head restraints, the steering wheel or the mirror while the vehicle is in motion.
 - If you fasten your seat belt while the vehicle is in motion.
- ▶ Before starting the engine: adjust the driver's seat, the head restraints, the steering wheel and the mirror and fasten your seat belt.



Ensure the following when adjusting the steering wheel ①, seat belt ② and driver's seat ③:

- You are sitting as far away from the driver's airbag as possible, taking the following points into consideration
- You are sitting in an upright position
- Your thighs are slightly supported by the seat cushion
- Your legs are not fully extended and you can depress the pedals properly
- The back of your head is supported at eye level by the centre of the head restraint

- You can hold the steering wheel with your arms slightly bent
- You can move your legs freely
- You can see all the displays on the instrument cluster clearly
- You have a good overview of the traffic conditions
- Your seat belt sits snugly against your body and passes across the centre of your shoulder and across your hips in the pelvic area

Seats

Adjusting the front seat electrically

⚠ WARNING Risk of becoming trapped if the seats are adjusted by children

Children could become trapped if they adjust the seats, particularly when unattended.

▶ When leaving the vehicle, always take the key with you and lock the vehicle. This also applies to the digital vehicle

key if the "Digital Vehicle Key" function is activated via Mercedes me connect.

- ▶ Never leave children unattended in the vehicle.

The seats can be adjusted when the ignition is switched off.

⚠ WARNING Risk of becoming trapped when adjusting the seats

When you adjust a seat, you or other vehicle occupants could become trapped, e.g. on the seat guide rail.

- ▶ When adjusting a seat, make sure that no one has any body parts in the sweep of the seat.

Observe the safety notes on "Airbags" and "Children in the vehicle".

⚠ WARNING Risk of injury through adjusting vehicle settings while the vehicle is in motion

You could lose control of the vehicle in the following situations in particular:

- if you adjust the driver's seat, the head restraints, the steering wheel or the mirror while the vehicle is in motion.
- if you fasten your seat belt while the vehicle is in motion.

- ▶ Before starting the engine: adjust the driver's seat, the head restraints, the steering wheel or the mirror and fasten your seat belt.

⚠ WARNING Risk of becoming trapped if the seat height is adjusted carelessly

If you adjust the seat height carelessly, you or other vehicle occupants could be trapped and thereby injured.

Children in particular could accidentally press the electrical seat adjustment buttons and become trapped.

- ▶ While moving the seats, make sure that hands or other body parts do not get under the lever assembly of the seat adjustment system.

⚠ WARNING Risk of injury due to head restraints which are not fitted or are adjusted incorrectly

If head restraints are not fitted or are adjusted incorrectly, they cannot provide protection as intended.

There is an increased risk of injury in the head and neck area, e.g. in the event of an accident or when braking.

- ▶ Always drive with the head restraints fitted.
- ▶ Before driving off, make sure for every vehicle occupant that the centre of the head restraint supports the back of the head at about eye level.

Adjust the head restraint fore-and-aft position so that it is as close as possible to the back of your head.

⚠ WARNING Risk of injury or death due to incorrect seat position

The seat belt does not offer the intended level of protection if you have not moved the backrest to an almost vertical position.

In particular, when you are braking or in the event of an accident, you could slide underneath the seat belt and sustain abdomen or neck injuries, for example.

- ▶ Adjust the seat properly before beginning your journey.
- ▶ Always ensure that the backrest is in an almost vertical position and that the shoulder section of your seat belt is routed across the centre of your shoulder.

! NOTE Damage to the seats when moving the seats back

The seats may be damaged by objects when moving the seats back.

- ▶ When moving the seats back, make sure that there are no objects in the footwell, under or behind the seats.

The switches for adjusting the seats do not move. You will therefore receive no direct feedback on the switch while pressing the switch. Feedback is provided only by the movement of the seat.

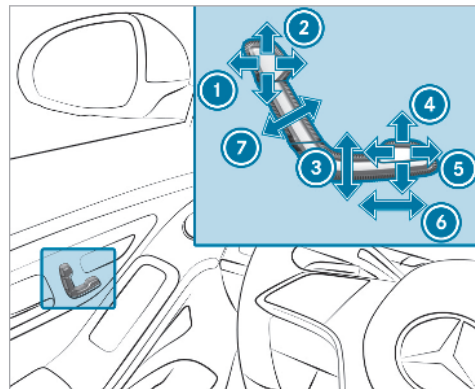

- ① Head restraint height/fore-and-aft position (vehicles with an EASY ADJUST luxury head restraint)
- ② Head restraint height
- ③ Seat height
- ④ Seat cushion inclination
- ⑤ Seat cushion length

- ⑥ Seat fore-and-aft position
- ⑦ Seat backrest inclination
- ▶ Save the settings with the memory function (→ page 114).
- ⓘ The head restraint height will be adjusted automatically when you adjust the seat height or the seat fore-and-aft position.
- ⓘ **Vehicles with EASY ADJUST luxury head restraints:** the fore-and-aft position of the head restraint is pre-adjusted automatically when you adjust the backrest angle.

Adjusting the front passenger seat electrically from the driver's seat

Requirements:

- For selecting the front passenger seat: the power supply is switched on

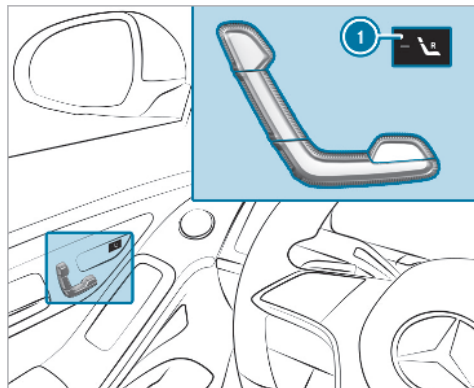

You can call up the following functions for the front passenger seat:

- Seat adjustment
- Seat heating
- Seat ventilation
- Memory function

- ▶ **To select the front passenger seat:** press button ①.
When the indicator lamp lights up, the front passenger seat is selected.
- ▶ Adjust the front passenger seat using the buttons on the driver's side door control panel.

Adjusting the front passenger seat electrically from the rear

Requirements:

- For selecting the front passenger seat: the power supply is switched on

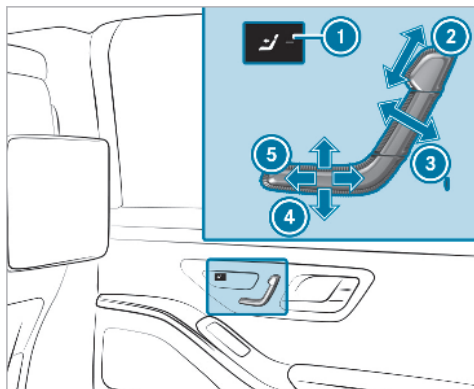

Vehicles with electrically adjustable outer seats

- ① Selects the front passenger seat
- ② Head restraint height
- ③ Seat backrest inclination
- ④ Seat height
- ⑤ Seat fore-and-aft position

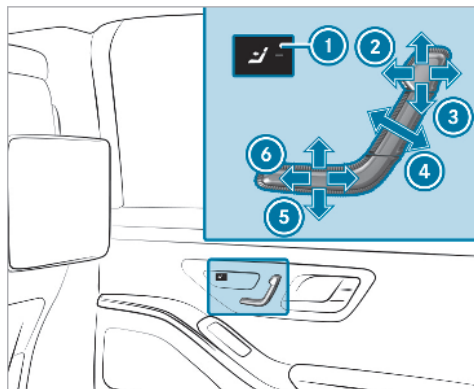

Vehicles with an EASY ADJUST luxury head restraint

- ① Selects the front passenger seat
- ② Head restraint fore-and-aft position
- ③ Head restraint height
- ④ Seat backrest inclination
- ⑤ Seat height
- ⑥ Seat fore-and-aft position

▶ Adjust the rear seat (→ page 100).

- ▶ **To select the front passenger seat:** press button ①.
When the indicator lamp lights up, the front passenger seat is selected.
- ▶ Adjust the front passenger seat using the buttons on the door control panel in the rear passenger compartment.
- ⓘ You can use the rear-compartment child safety lock to disable this function (→ page 65).

Adjusting the rear seats electrically

⚠ WARNING Risk of injury or death due to incorrect seat position

The seat belt does not offer the intended level of protection if you have not moved the backrest to an almost vertical position.

In particular, when you are braking or in the event of an accident, you could slide underneath the seat belt and sustain abdomen or neck injuries, for example.

- ▶ Adjust the seat properly before beginning your journey.
- ▶ Always ensure that the backrest is in an almost vertical position and that the shoulder section of your seat belt is routed across the centre of your shoulder.

The switches for adjusting the seats do not move. You will therefore receive no direct feedback on the switch while pressing the switch. Feedback is provided only by the movement of the seat.

You can electrically adjust only the outer seats in the rear compartment.

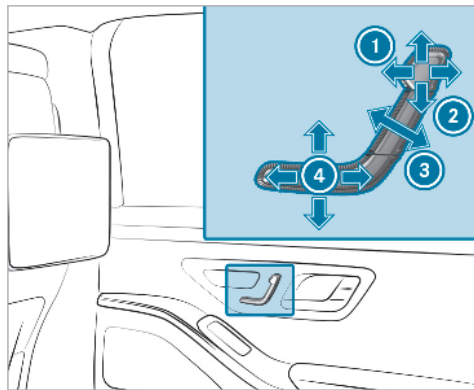

- ① Height/fore-and-aft position of the head restraint (vehicles with active multicontour seat)
- ② Head restraint height
- ③ Seat backrest inclination
- ④ Combined seat cushion inclination and length

- ▶ Save the settings with the memory function (→ page 116).

Setting the fully reclined position

Requirements:

- the power supply is switched on.

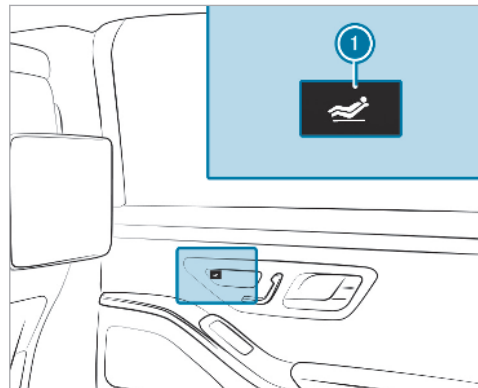

▶ **To set the fully reclined position:** press button ①.

- The rear seat will move into the fully reclined position.
- The front passenger seat will move into the position for chauffeur mode.
- The footrest will move out from under the front passenger seat.
- If available, the leg rest will rise

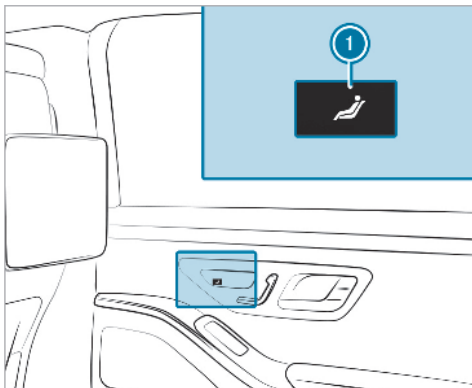

▶ **To restore the standard seat settings:** press button ①.

or

▶ call up the settings with the memory function (→ page 116).

- ① You can use the rear-compartment child safety lock to disable this function (→ page 65).
- ① The leg rest will fold down if overloaded. If this is the case, fold up the leg rest and engage it.

Head restraints

Adjusting the front seat luxury head restraints mechanically

⚠ WARNING Risk of accident due to adjusting vehicle settings while the vehicle is in motion

You could lose control of the vehicle in the following situations in particular:

- If you adjust the driver's seat, the head restraints, the steering wheel or the mirror while the vehicle is in motion.
- If you fasten your seat belt while the vehicle is in motion.

▶ Before starting the engine: adjust the driver's seat, the head restraints, the steering wheel and the mirror and fasten your seat belt.

⚠ WARNING Risk of injury due to incorrectly adjusted head restraints

If head restraints have not been adjusted correctly, there is an increased risk of injury in the head and neck area, e.g. in the event of an accident or sudden braking.

- ▶ Before driving off, make sure for every vehicle occupant that the centre of the head restraint supports the back of the head at about eye level.

Adjust the head restraint fore-and-aft position so that it is as close as possible to the back of your head.

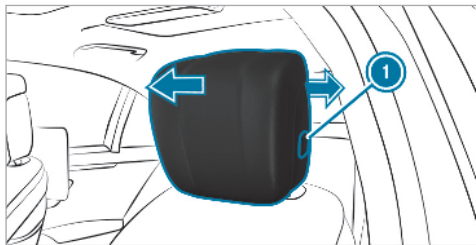

- ▶ **To move forwards:** pull the head restraint forwards.

- ▶ **To move backwards:** press release knob ① and push the head restraint backwards.

Attaching and removing the additional cushion of the front-seat luxury head restraint

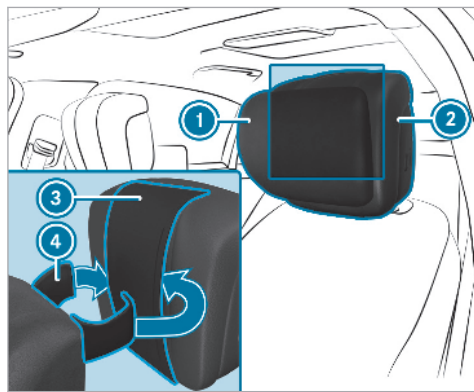

- ▶ Position head restraint ② as far forwards as possible.

- ▶ **To attach the additional cushion:** open Velcro strip ④ on the rear of additional cushion ①.

- ▶ Guide Velcro strip ④ between head restraint ② and strip ③.

- ▶ Close Velcro strip ④.

- ▶ **Change the position of the additional cushion:** move additional cushion ① up or down.

- ▶ **To remove additional cushion:** open Velcro strip ④ of additional cushion ①.

- ▶ Remove additional cushion ①.

Adjusting the rear seat outer head restraints mechanically

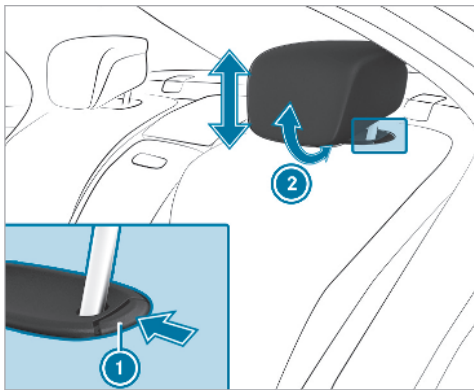

- ▶ **To raise:** pull the head restraint upwards and let it engage.
- ▶ **To lower:** press release knob ① in the direction of the arrow.
- ▶ Push the head restraint down and let it engage.

- ▶ **To adjust the angle of the head restraint:** pull or push the head restraint in the direction of the arrow ②.

Adjusting the outer luxury head restraints of the rear seats mechanically

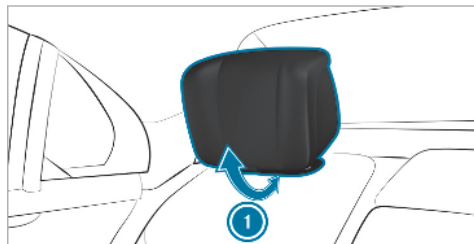

- ▶ **To adjust the angle of the head restraint:** pull or push the head restraint in the direction of arrow ①.

Attaching and removing the additional cushion of the head restraint in the rear compartment (individual seats)

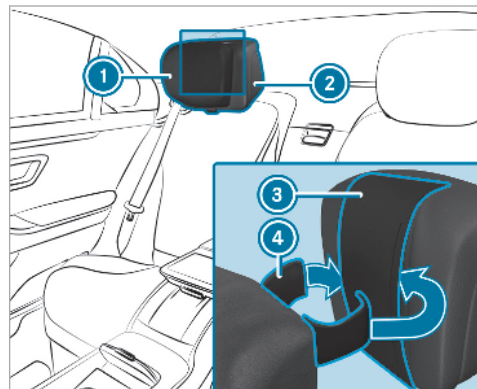

- ▶ Position head restraint ② as far forwards as possible.
- ▶ **To attach the additional cushion:** open Velcro strip ④ on the rear of additional cushion ①.

- ▶ Guide Velcro strip ④ between head restraint ② and strip ③.
- ▶ Close Velcro strip ④.
- ▶ **Change the position of the additional cushion:** move additional cushion ① up or down.
- ▶ **To remove additional cushion:** open Velcro strip ④ of additional cushion ①.
- ▶ Remove additional cushion ①.

Attaching heated additional cushion

In vehicles with electrically adjustable head restraints, you can heat the additional cushion.

- ▶ Attach the additional cushion to the head restraint as described.
- ▶ Move the head restraint to the very top.

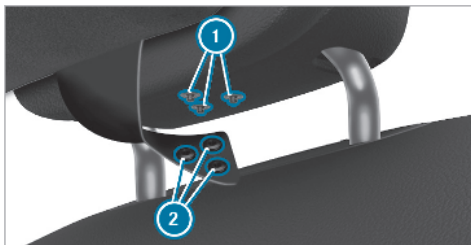

- ▶ Push press-studs ② on the additional strip into counterpieces ① on the head restraint.
- ▶ Move the head restraint to the desired height.
- ▶ **To switch neck heating from the additional cushion on/off:** make sure that press-studs ② on the additional strip are correctly pushed into counterpieces ① on the head restraint.
- ▶ Activate or deactivate the seat heating (→ page 108).

Folding the centre head restraint into position and folding it back mechanically

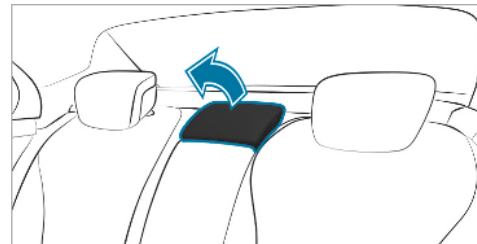

- ▶ **To fold into position:** pull the head restraint upwards until it engages.

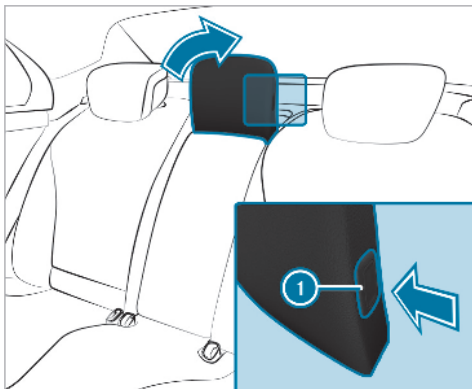

- ▶ **To fold back:** press button ①.
- ▶ Fold down the head restraint completely.

The centre head restraint has a usage and non-usage position. The usage position is the upright position in which the head restraint is locked; the non-usage position is the position in which the head restraint is folded downwards. When the centre seat is used, the head restraint must be in the upright, locked usage position.

Configuring the seat settings

Multimedia system:

→ → Home → Comfort → Seat comfort

Adjusting the air cushions.

- ▶ In the corresponding menu, adjust the air cushions for **Lumbar**, **Shoulders** or **Side bolsters**.

Setting the seat heating balance

- ▶ Select **Sitzklimatisierung** (Seat climate control).
- ▶ Select **Seat heating balance**.
- ▶ Adjust the heat distribution for the desired seat.

Adjusting the neck warmer

- ▶ Select **Neck warmers**.
- ▶ Adjust the neck warmer for the desired seat.

Setting automatic seat adjustment

⚠ WARNING Risk of becoming trapped during adjustment of the driver's seat after calling up a driver profile

Selecting a profile may trigger an adjustment of the driver's seat to the position saved under the profile. You or other vehicle occupants could be injured in the process.

- ▶ Make sure that when the position of driver's seat is being adjusted using the multimedia system, no people or body parts are in the seat's range of movement.

If there is a risk of someone becoming trapped, stop the adjustment process immediately:

- ▶ a) Tap the warning message on the central display.

or

- ▶ b) Press a memory position button or a seat adjustment switch on the driver's door.
The adjustment process is stopped.

Requirements:

- Adapting the driver's seat and steering wheel position to body size: automatic seat adjustment has been switched on.

Multimedia system:

- ▶  ▶▶ Comfort ▶▶ Seat comfort
- ▶▶ Automatic seat adjustment

Adjusting driver's seat and steering wheel position to body size

The vehicle calculates a suitable driver's seat and steering wheel position on the basis of the driver's body size and sets this directly.

- ▶ **To set the unit of measurement:** select [cm](#) or [ft/in.](#)
- ▶ Set the size using the scale.

- ▶ Select [Start positioning](#).
The driver's seat and steering wheel position is adjusted to the body size that has been set.

- ⓘ If the driver's seat and steering wheel position calculated by the vehicle is not practical or comfortable, it can be manually changed at any time via the control buttons. The exterior mirrors are not set via this function. Instead, they have to be set manually via the operating switches.

- ⓘ You can also make these settings via the Mercedes me portal for your user profile. By synchronising the profiles in the vehicle and the Mercedes me connect profiles, you can carry over these settings for your vehicle. Further information about synchronising user profiles (→ page 299).

Setting automatic adjustment of the lateral support (active multicontour seat)

Multimedia system:

- ▶  ▶▶ Comfort ▶▶ Seat comfort
- ▶ Select [Dynamic multicontour seat](#).

With this function, the lateral support of the active multicontour seat is automatically adjusted to the driving and cornering dynamics of the vehicle.

- ▶ Select the desired setting.

Overview of massage programs

- [Hot Relaxing back](#): Based on hot stone massage, the program combines heat and massage. Starts by massaging the back. In addition, warm pressure points become noticeable, starting in the pelvic area.
- [Hot Relaxing shoulder](#): Combination of heat and massage. Starts by massaging the shoulders. In addition, warm pressure points become noticeable, starting in the pelvic area.

- **Activating Massage** Activating massage with upward-moving massage waves.
- **Classic Massage:** Relaxing back massage.
- **Wave Massage:** Regenerating massage via massage waves across the back and in the seat cushion.
- **Mobilizing Massage** Mobilising massage with upward-moving massage waves. Can promote slower, deeper respiration. This can improve the oxygen supply to cells and the brain.
- **Workout, backrest** and **Workout, cushion:** These programs require your cooperation. Alternating between tensing and releasing helps to improve blood flow to your muscles. Press against a pressure point as soon as you feel it to activate back, abdominal and leg muscles.
- **Depth waves:** Wave-like movements in the cushion can promote blood flow and metabolic processes in the lower back and legs.
- **Deep workout:** Combines the **Workout, backrest** with the **Workout, cushion**. The vibrating massage in the cushion intensifies the effect-

tiveness of the tensing and releasing of muscles when you tense against the pressure point. This supports metabolic processes and blood flow in the seat area and legs.

- **Calf massage** (rear): Calf massage using vibration. Can support metabolic processes and the reverse flow of blood.
- **Wave Massage** (rear): Combines the vibration of the calf massage with the Classic Massage from the backrest in the rear passenger compartment.

Selecting the massage programme for the front seats

Multimedia system:

  **Comfort**  **Massage**

- ▶ Select a massage programme (→ page 107).
- ▶ Start the program for the desired seat .
- ▶ **To set the massage intensity: switch High intensity** on or off .

 For the rear seats, the massage programmes can be selected on the following devices (if available):

- On the rear displays (→ page 446)
- On the MBUX rear tablet

The selection is made in the same way as on the rear displays for the rear seats on the second row of seats.

Resetting seat settings

Multimedia system:

  **Comfort**  **Seat comfort**

- ▶ Select **Reset**.
- ▶ Select  for the desired seat.

Switching the seat heating on/off

 **WARNING** Risk of burns due to repeatedly switching on the seat heater

Repeatedly switching on the seat heater can cause the seat cushion and seat backrest padding to become very hot.

The health of persons with limited temperature sensitivity or a limited ability to react to high temperatures may be affected or they may even suffer burn-like injuries.

- ▶ Do not repeatedly switch on the seat heater.

To protect against overheating, the seat heating may be temporarily deactivated after it is switched on repeatedly.

! **NOTE** Damage to the seats caused by objects or documents when the seat heater is switched on

When the seat heater is switched on, overheating may occur due to objects or documents placed on the seats e.g. seat cushions or child seats. This could cause damage to the seat surface.

- ▶ Make sure that no objects or documents are on the seats when the seat heater is switched on.

Requirements:

- The power supply is switched on.

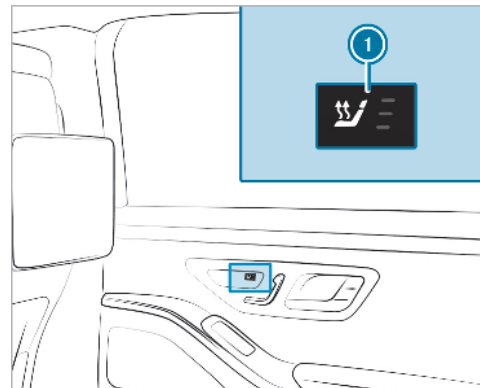
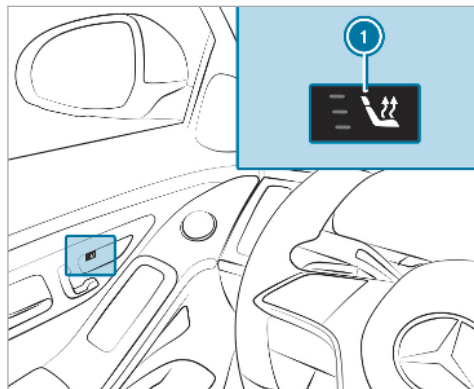

- ▶ Press button ① repeatedly until the desired heating level is set. Depending on the heating level, up to three indicator lamps will light up. If all indicator lamps are off, the seat heating is switched off.

- i** The seat heating will automatically switch down from the three heating levels after 8, 10 and 20 minutes until the seat heating switches off.
- i** If you switch the power supply off and on again within 20 minutes, the previous setting of the seat heating for the driver's seat will remain active.
- i** You can set the distribution of the heated sections among the seat cushions and seat backrests on the front and rear seats using the multimedia system (→ page 110).
- i** Vehicles with the Warmth Comfort Package: you can adjust the heating of the centre console and door armrests using the multimedia system (→ page 110).

Setting the panel heating

Multimedia system:

→  ▶▶ Comfort ▶▶ Seat comfort
▶▶ Heating settings ▶▶ Panel heating

When the seat heating is switched on, the armrests, the centre panels of the doors and the centre console can be heated.

- ▶ Switch the function for the desired seats on or off.

Switching the seat ventilation on/off

Requirements:

- The power supply is switched on.

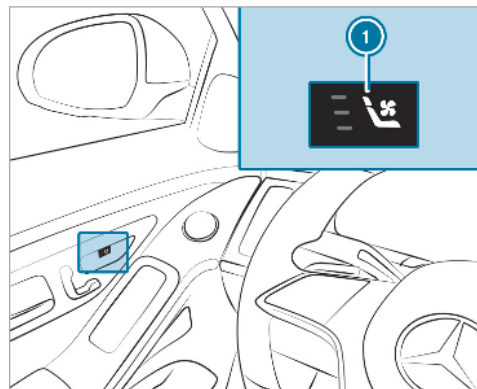

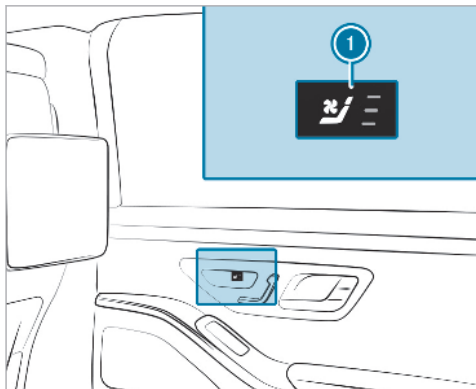

- ▶ Press button ① repeatedly until the desired blower setting has been reached. Depending on the blower setting, up to three indicator lamps will light up. If all indicator lamps are off, the seat ventilation is switched off.

① If you switch the power supply off and on again within 20 minutes, the previous seat

ventilation setting for the driver's seat will remain active.

Steering wheel

Adjusting the steering wheel electrically

- ⚠ **WARNING** Risk of injury through adjusting vehicle settings while the vehicle is in motion

You could lose control of the vehicle in the following situations in particular:

- if you adjust the driver's seat, the head restraints, the steering wheel or the mirror while the vehicle is in motion.
 - if you fasten your seat belt while the vehicle is in motion.
- ▶ Before starting the engine: adjust the driver's seat, the head restraints, the steering wheel or the mirror and fasten your seat belt.

- ⚠ **WARNING** Risk of entrapment for children when adjusting the steering wheel

Children could injure themselves if they adjust the steering wheel.

- ▶ Never leave children unattended in the vehicle.
- ▶ When leaving the vehicle, always take the key with you and lock the vehicle. This also applies to the digital vehicle key if the "Digital Vehicle Key" function is activated via Mercedes me connect.

The steering wheel can be adjusted when the power supply is disconnected.

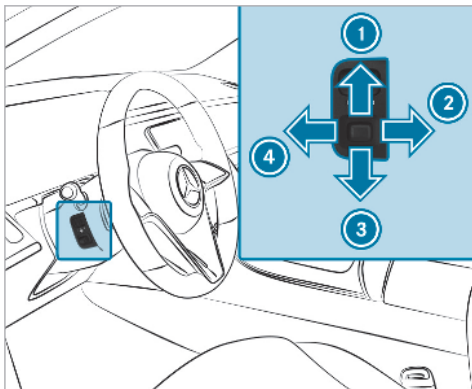

- ① To move up
- ② To move back
- ③ To move down
- ④ To move forward

▶ Save the settings with the memory function (→ page 114).

Switching the steering wheel heater on/off

Requirements:

- The power supply or the ignition is switched on.

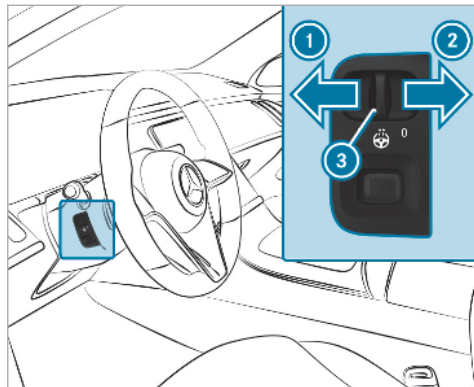

- ▶ **To switch on:** push switch ③ into position ①.
- ▶ **To switch off:** push switch ③ into position ②.

When you switch the ignition off, the steering wheel heater will switch off.

Activating/deactivating the steering wheel heater via the multimedia system

Multimedia system:

→ [Home] ▶▶ Comfort ▶▶ Seat comfort
▶▶ Heating settings

▶ Activate or deactivate Steering wheel heating.

Easy entry and exit feature

Using the easy entry and exit feature

⚠ WARNING Risk of accident when pulling away during the adjustment process for the easy exit feature

You could lose control of the vehicle.

▶ Always wait until the adjustment process is complete before pulling away.

⚠ WARNING Risk of becoming trapped while adjusting the easy entry and exit feature

You and other vehicle occupants – particularly children – could become trapped.

▶ Ensure that no-one has a body part in the range of movement of the steering wheel or driver's seat.

If there is a risk of becoming trapped by the steering wheel:

▶ Move the steering wheel adjustment lever.
The adjustment process will be stopped.

If there is a risk of becoming trapped by the driver's seat:

▶ Press the seat adjustment switch.
The adjustment process will be stopped.

▶ Never leave children unattended in the vehicle.

▶ When leaving the vehicle, always take the key with you and lock the vehicle. This also applies to the Digital Vehicle Key if the "Digital Vehicle Key" function is activated via Mercedes me connect.

Vehicles with memory function: you can stop the adjustment process by pressing one of the memory function position switches.

⚠ WARNING Risk of becoming trapped during activation of the easy entry and exit feature by children

If children activate the easy entry and exit feature, they can become trapped, particularly when unattended.

▶ Never leave children unattended in the vehicle.

▶ When leaving the vehicle, always take the key with you and lock the vehicle.

This also applies to the Digital Vehicle Key if the "Digital Vehicle Key" function is activated via Mercedes me connect.

If the easy entry and exit feature is active, the steering wheel will move upwards and the driver's seat will move back in the following situations:

- You switch the ignition off with the driver's door open.
- You open the driver's door with the ignition switched off.

i The steering wheel will then move upwards only if it is not already as high as it will go. The driver's seat will then move backwards only if it is not already in the rearmost position.

The steering wheel and the driver's seat will move back to the last drive position in the following cases:

- You switch the power supply or the ignition on when the driver's door is closed.
- You close the driver's door with the ignition switched on.

The last drive position will be saved when:

- You switch the ignition off.

- **Vehicles with memory function:** you call up the seat settings via the memory function.
- **Vehicles with memory function:** you save the seat settings via the memory function.

Vehicles with memory function: press one of the memory function position buttons to stop the adjustment process.

Setting the easy entry and exit feature

Multimedia system:

→  ▶ Settings ▶ Vehicle

▶▶ Easy entry and exit feature

▶ Select **Steer. wheel and seat**, **Steering wheel only** or **Off**.

- ① If you use an individual user profile and have set your body size, this information is carried over for the easy entry and exit feature. This causes the driver's seat and steering wheel to automatically move into the correct position (→ page 296).

Operating the memory function

⚠ WARNING Risk of an accident if the memory function is used while driving

If you use the memory function on the driver's side while driving, you could lose control of the vehicle as a result of the adjustments being made.

- ▶ Only use the memory function on the driver's side when the vehicle is stationary.

⚠ WARNING Risk of entrapment when setting the seat with the memory function

When the memory function adjusts the seat or steering wheel, you and other vehicle occupants – particularly children – could become trapped.

- ▶ During the setting procedure of the memory function, ensure that no body parts are in the sweep of the seat or the steering wheel.

- ▶ If somebody becomes trapped, immediately release the memory function position button.
The adjustment process is stopped.

⚠ WARNING Risk of entrapment if the memory function is activated by children

Children could become trapped if they activate the memory function, particularly when unattended.

- ▶ Never leave children unattended in the vehicle.
- ▶ When leaving the vehicle, always take the key with you and lock the vehicle.

This also applies to the Digital Vehicle Key if the "Digital Vehicle Key" function is activated via Mercedes me connect.

You can use the memory function when the ignition is switched off.

Storing

Seat adjustments for up to three people can be stored and called up using the memory function.

You can save the following settings for the front seat:

- Seat, backrest, head restraint position and contour of the seat backrest in the lumbar region
- Active multicontour seat
 - Side bolsters of the seat backrest
 - Shoulder of the seat backrest
 - Contour of the seat backrest
 - Dynamic function level
- Seat heating: distribution of the heated sections of the seat cushion and seat backrest
- Driver's side: steering wheel position and position of the outside mirrors on the driver's and front passenger sides
- Head-up display

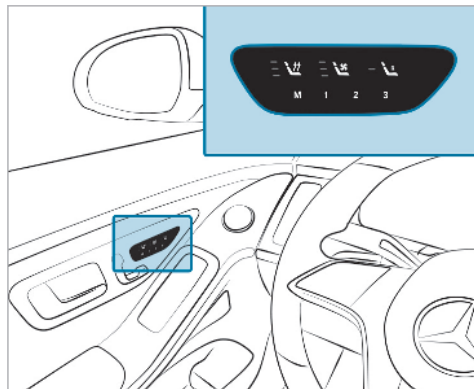

- ▶ Set the seat, the steering wheel, the head-up display and the outside mirror to the desired position.
- ▶ Briefly press memory button M and then press preset position button 1, 2 or 3 within three seconds.
An acoustic signal sounds. The settings are stored.

▶ **To call up:** press and briefly hold preset position button 1, 2 or 3.

After releasing the button, the front seat, outside mirror, head-up display and steering column are moved into the stored position automatically.

ⓘ If you release the preset position button, the seat, steering wheel and mirror setting functions stop immediately.

Vehicles with the Active Multicontour Seat Package: setting the active multicontour seat or the 4-way lumbar support is still carried out.

Vehicles without the Active Multicontour Seat Package: adjustment of the 4-way lumbar support is still carried out.

Memory function in the rear compartment

Operating the rear seat via the memory function in the rear passenger compartment

Storing

Rear seat settings for up to three people can be stored and called up using the memory function in the rear compartment.

The following settings can be stored for the rear seats:

- Position of the seat, backrest and head restraint
- Active multicontour seats: the seat side bolsters of the seat backrest as well as the contour of the seat backrest in the lumbar region
- Seat heating: distribution of the heated sections of the seat cushion and seat backrest

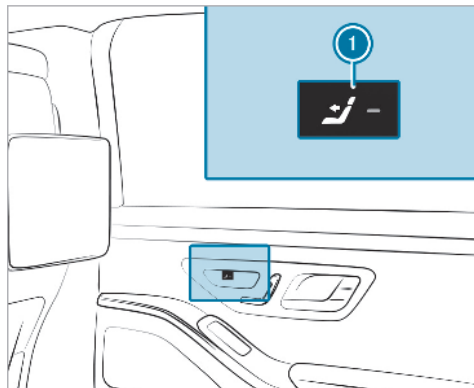

- ▶ Press button ①.
The rear seat is selected if the indicator lamp in the button does not light up.
- ▶ Adjust the rear seat using the buttons in the door control panel (→ page 100).

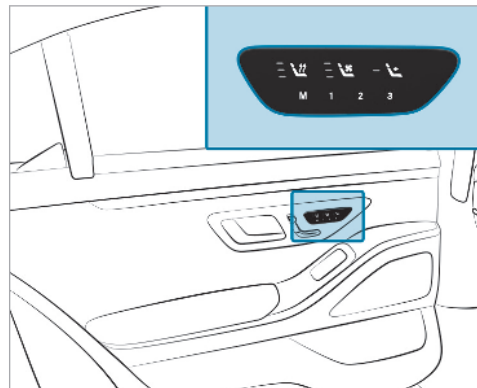

Example: vehicles without a reclining rear seat

- ▶ Briefly press memory button M and then press preset position button 1, 2 or 3 within three seconds.
The settings for the rear seat are stored in the selected memory position.

Calling up

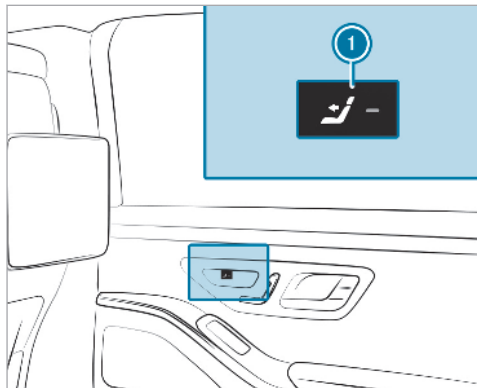

- ▶ Press button ①.
The rear seat is selected if the indicator lamp in the button does not light up.

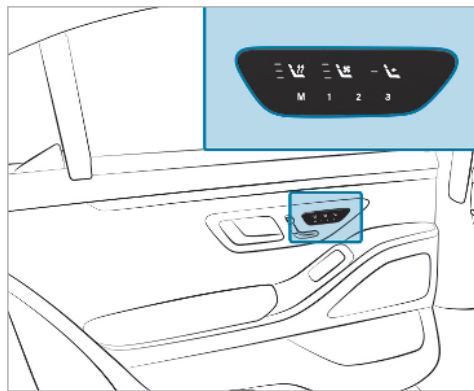

Example: vehicles without a reclining rear seat

- ▶ Press and briefly hold preset position button 1, 2 or 3.
- ① Seat adjustment is interrupted as soon as you release the preset position button. The adjustment of the active multicontour seat is still carried out.

Operating the front passenger seat and rear seats via the memory function in the rear compartment

Requirements:

- For selecting the front passenger seat: the power supply is switched on

Storing

Front passenger seat adjustments and rear seat adjustments for up to three people can be stored and called up using the memory function in the rear compartment.

The following settings can be stored for the front passenger seat:

- Position of the seat, backrest and head restraint

The following settings can be stored for the rear seats:

- Position of the seat, backrest and head restraint
- Active multicontour seats: the seat side bolsters of the seat backrest as well as the con-

tour of the seat backrest in the lumbar and shoulder regions

- Seat heating: distribution of the heated sections of the seat cushion and seat backrest

The following settings are also stored to a memory position, if the indicator lamp in the  button lights up:

- Position of the footrest of the front passenger seat, if available
- Position of the screen, if available

Using the preset position buttons, you always store the current setting of each seat.

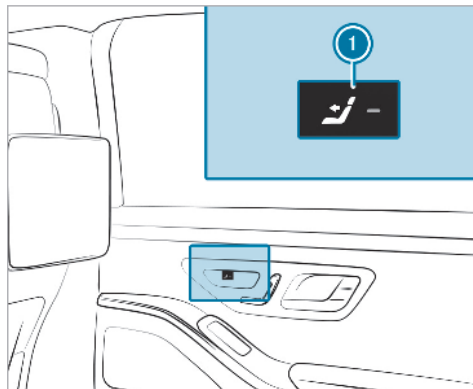

- ▶ Press button **1**.
The rear seat is selected if the indicator lamp in the button does not light up.
- ▶ Adjust the rear seat using the buttons in the door control panel (→ page 100).
- ▶ Press button **1**.
When the indicator lamp lights up, the front passenger seat is selected.

- ▶ Adjust the front passenger seat using the buttons on the door control panel in the rear passenger compartment (→ page 96).
- ▶ Ensure that the indicator lamp in button **1** lights up.

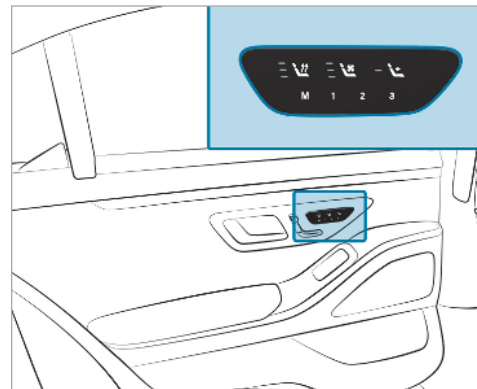

Example: vehicles without a reclining rear seat

- ▶ Briefly press memory button M and then press preset position button 1, 2 or 3 within three seconds.
The settings for the front passenger seat and the rear seat are stored in the selected preset position.

Calling up

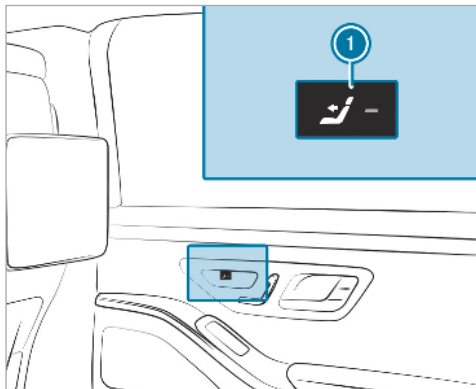

- ▶ Press button ①.
When the indicator lamp lights up, the front passenger seat is selected.

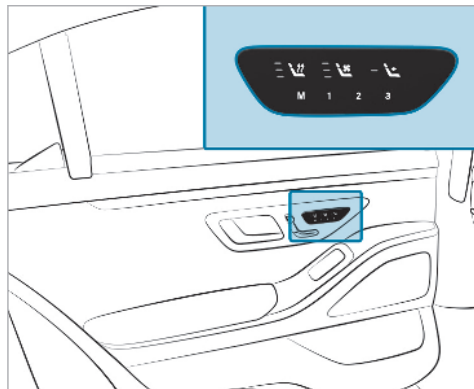

Example: vehicles without a reclining rear seat

- ▶ Press and briefly hold preset position button 1, 2 or 3.
- ① The preset positions in the area for the chauffeur mode can only be set when the

conditions for the chauffeur mode are fulfilled .

- ① Seat adjustment is interrupted as soon as you release the preset position button. The adjustment of the active multicontour seat is still carried out.
- ① You can use the rear-compartment child safety lock to disable this function (→ page 65).

Storage areas

Notes on loading the vehicle

A DANGER Risk of exhaust gas poisoning

Combustion engines emit poisonous exhaust gases such as carbon monoxide. Exhaust gases can enter the vehicle interior if the boot lid is open when the engine is running, especially if the vehicle is in motion.

- ▶ Always switch off the engine before opening the boot lid.
- ▶ Never drive with the boot lid open.

Objects in the deployment area of an airbag may prevent the airbag from functioning correctly.

Observe the notes on protection provided by the airbag (→ page 43).

⚠ WARNING Risk of injury from unsecured items in the vehicle

If objects, luggage or loads are not secured or not secured sufficiently, they could slip, tip over or be thrown around and thereby hit vehicle occupants.

There is a risk of injury, particularly in the event of sudden braking or a sudden change in direction.

- ▶ Always stow objects in such a way that they cannot be thrown around.
- ▶ Before the journey, secure objects, luggage or loads against slipping or tipping over.

⚠ WARNING Risk of injury due to objects being stowed incorrectly

If you inadequately stow objects in the vehicle interior, they could slip or be tossed around and thereby strike vehicle occupants. In addition, cup holders, open stowage spaces and mobile phone brackets cannot always restrain the objects they contain in the event of an accident.

There is a risk of injury, particularly in the event of sudden braking or a sudden change in direction.

- ▶ Always stow objects in such a way that they cannot be tossed about in these or similar situations.
- ▶ Always make sure that objects do not project from stowage spaces, luggage nets or stowage nets.
- ▶ Close the lockable stowage spaces before starting a journey.
- ▶ Always stow and secure objects that are heavy, hard, pointed, sharp-edged, fragile or too large in the boot.

Observe the notes on the cup holders.

⚠ WARNING Risk of burns from the tailpipe and tailpipe trims

The exhaust tailpipe and tailpipe trims can become very hot. If you come into contact with these parts of the vehicle, you could burn yourself.

- ▶ Always be particularly careful around the tailpipe and the tailpipe trims and supervise children especially closely in this area.
- ▶ Allow vehicle parts to cool down before touching them.

The driving characteristics of your vehicle are dependent on the distribution of the load within the vehicle. You should bear the following in mind when loading the vehicle:

- never exceed the permissible gross mass or the permissible axle loads for the vehicle (including occupants).

Information can be found on the vehicle identification plate (→ page 562).

- the load must not protrude above the upper edge of the seat backrests.
- always place the load behind unoccupied seats if possible.
- secure the load using the luggage net hooks. Distribute the load on the luggage net hooks evenly.

Stowage spaces in the vehicle interior

Overview of the front stowage compartments

⚠ WARNING Risk of injury due to objects being stowed incorrectly

If you inadequately stow objects in the vehicle interior, they could slip or be tossed around and thereby strike vehicle occupants. In addition, cup holders, open stowage spaces and mobile phone brackets cannot always restrain the objects they contain in the event of an accident.

There is a risk of injury, particularly in the event of sudden braking or a sudden change in direction.

- ▶ Always stow objects in such a way that they cannot be tossed about in these or similar situations.
- ▶ Always make sure that objects do not project from stowage spaces, luggage nets or stowage nets.
- ▶ Close the lockable stowage spaces before starting a journey.
- ▶ Always stow and secure objects that are heavy, hard, pointed, sharp-edged, fragile or too large in the boot.

Observe the notes on loading the vehicle.

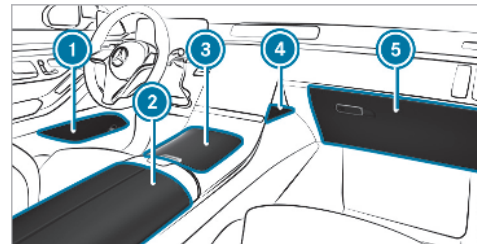

- ① Stowage space in the doors
- ② Stowage/telephone compartment beneath the armrest with a charging module for wireless charging of mobile phones, multimedia and USB ports as well as stowage space, e.g. for an MP3 player
- ③ Stowage compartment in the front centre console with cup holders, USB ports and charging module for wireless charging of mobile phones
- ④ Stowage compartment in front of the central display of the multimedia system
- ⑤ Glove compartment

- ① The rubber mat in the stowage compartment in front centre console ③ can be removed for cleaning with clear, lukewarm water. Please comply with the notes on caring for the interior (→ page 466).

Opening the stowage compartment in the rear armrest

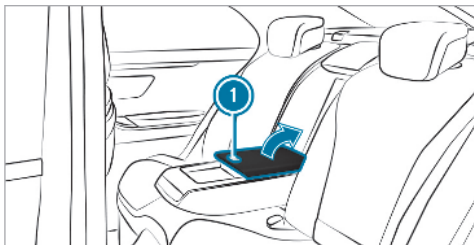

Vehicles with a rear bench seat

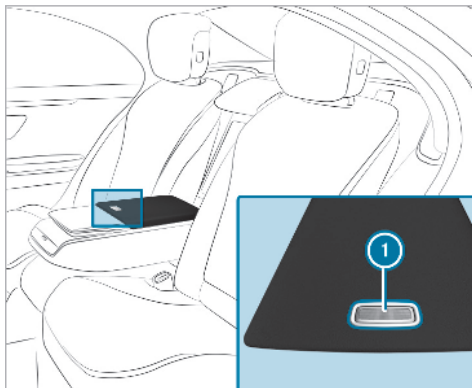

Vehicles with electrically adjustable outer seats

- ▶ Fold down the rear armrest.
- ▶ **To open:** press release catch ① and swing the cover of the armrest upwards.

Opening the electronics compartment in the rear-compartment centre console

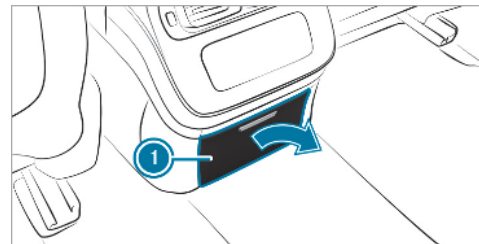

- ▶ Lightly press cover ①. The electronics compartment in the rear-compartment centre console is open.

Opening the stowage box in the backrest in the rear compartment

! **NOTE** Damage to the rear armrest due to body weight

When folded out, the rear armrest can be damaged by body weight.

- ▶ Do not sit or support yourself on the rear seat armrest.

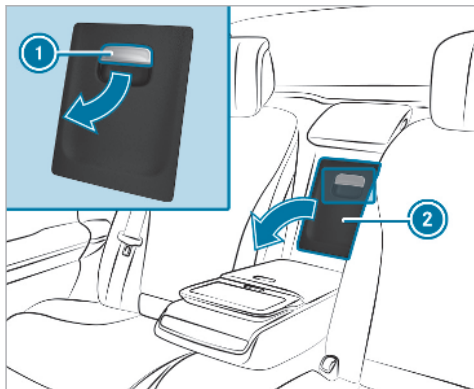

Vehicles with electrically adjustable outer seats

- ▶ Pull handle ① and fold down cover ②.

Removing the handset from the rear stowage compartment

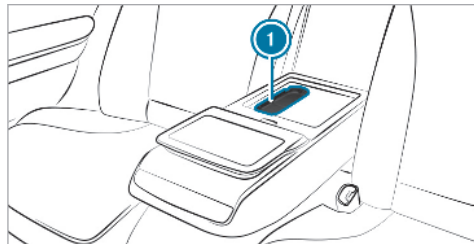

Vehicles with electrically adjustable outer seats

- ▶ Fold down the rear armrest.
- ▶ Open the stowage compartment in the rear armrest (→ page 122).
- ▶ Tap on handset ①. Handset ① will rise.
- ▶ Remove handset ①.

Overview of the luggage net hooks

Observe the following notes:

- secure the load using the luggage net hooks.
- Do not use elastic straps or nets to secure a load. These are intended only as anti-slip protection for light loads.
- Do not route lashing materials across sharp edges or corners.
- pad sharp edges for protection.

Depending on the equipment installed, the boot contains up to four luggage net hooks.

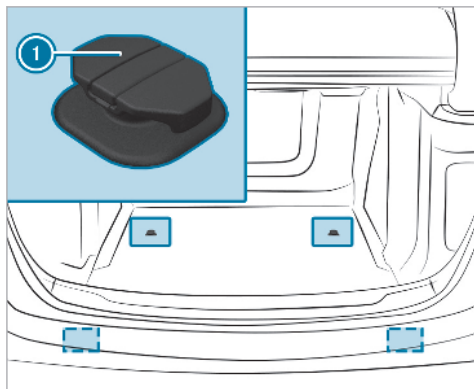

① Luggage net hooks

Opening the through-loading feature in the rear compartment

! **NOTE** Damage to the soft top caused by loading

The soft top can be damaged if the through-loading feature is loaded in the rear and the boot separator has not been lowered.

▶ Before loading the through-loading feature in the rear, lower the boot separator.

Requirements:

- The loading flap is unlocked (→ page 125).

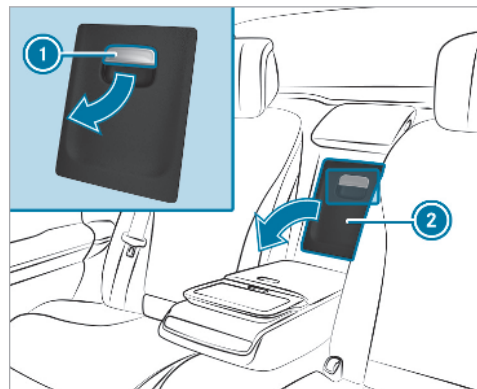

Vehicles with electrically adjustable outer seats

- ▶ **Vehicles with electrically adjustable outer seats:** fold down the rear armrests.
- ▶ Pull handle ① and fold down cover ②. The stowage box in the rear-compartment backrest is open.

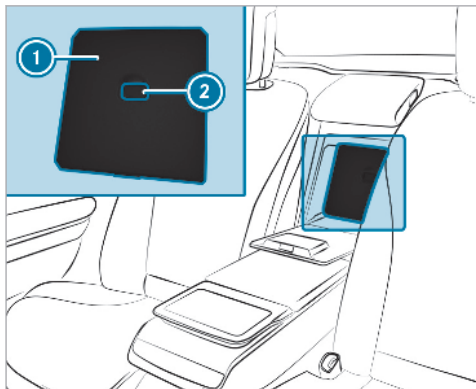

Vehicles with electrically adjustable outer seats

- ▶ Slide release catch ② in the handle recess of loading flap ① upwards. Loading flap ① is unlocked.
- ▶ Push loading flap ① with release catch ② up as far back as possible until the flap locks in the highest position. The through-loading feature in the rear compartment is open.

If the through-loading feature is to be used as a stowage compartment again:

- ▶ Fold down loading flap ① and lock it in the boot (→ page 125).

Locking the through-loading feature in the boot

Requirements:

- The refrigerator box is removed.

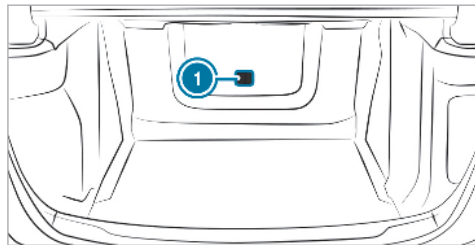

- ▶ Slide the release catch on loading flap ① in the boot to the right. The loading flap is locked.

Using the bag hooks

⚠ WARNING Risk of injury when using bag hooks with heavy objects

The bag hooks cannot restrain heavy objects or items of luggage.

Objects or items of luggage may be flung around and hit vehicle occupants.

- ▶ Only hang light objects on the bag hooks.
- ▶ Never hang hard, sharp-edged or fragile objects on the bag hooks.

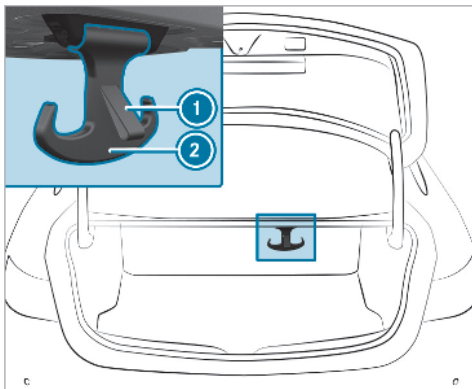

▶ Pull the bag hook ② down by the tab ①.

① Observe the notes on loading the vehicle (→ page 119).

EASY-PACK boot box

Adjusting the height of the EASY-PACK boot box to any position

⚠ WARNING Risk of becoming trapped and injured when raising the floor

Your hands may become trapped on the frame of the EASY-PACK boot box and objects may be thrown upwards.

- ▶ Ensure that your hands are not in the range of movement of the floor.
- ▶ If someone becomes trapped, carefully push the centre of the floor downward.
- ▶ Remove all objects from the floor before raising it.

⚠ WARNING Risk of becoming trapped when pressing the EASY-PACK boot box in

Your hands may become trapped when you are pressing the boot box into the retracted position. Children, in particular, may injure themselves when doing so.

▶ Ensure that your hands are not in the range of movement of the EASY-PACK boot box.

▶ When leaving the vehicle, always take the key with you and lock the vehicle. This also applies to the Digital Vehicle Key if the "Digital Vehicle Key" function is activated via Mercedes me connect.

▶ Never leave children unattended in the vehicle.

! NOTE Damage to the extended EASY-PACK boot box

The EASY-PACK boot box may be damaged when it is extended.

▶ Do not place any objects on or press down on the EASY-PACK boot box frame.

▶ Do not close the boot lid when the EASY-PACK boot box is extended.

! **NOTE** Damage to the EASY-PACK boot box by objects

Objects that are sharp-edged, pointed, fragile, rounded or heavy and objects that roll can damage the EASY-PACK boot box and be thrown out.

- ▶ Do not transport objects that are sharp-edged, pointed, rounded or fragile and objects that roll in the EASY-PACK boot box.
- ▶ Always stow and secure such objects outside of the box in the boot.
- ▶ Always observe the maximum permitted load of the EASY-PACK boot box.
- ▶ Do not use the EASY-PACK boot box when the rear seats are folded forwards.

The maximum permitted load of the EASY-PACK boot box is 10 kg. To prevent the box from being overloaded, the box floor will lower onto the boot floor when the load reaches approximately 5 kg.

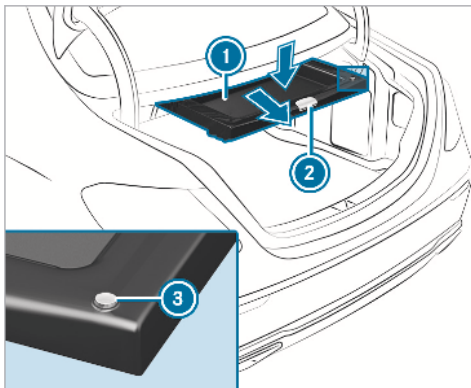

- ▶ **To remove:** pull handle ② on the box.
- ▶ **To increase the load capacity:** press the centre of floor ① downwards to the desired position and box size.
- ▶ **To reduce the load capacity:** press button ③.
- ▶ **To stow:** press the box in completely using handle ② until it locks in place.

- ① Observe the notes on cleaning the EASY-PACK boot box (→ page 466).

Installing or removing the EASY-PACK boot box

Fitting

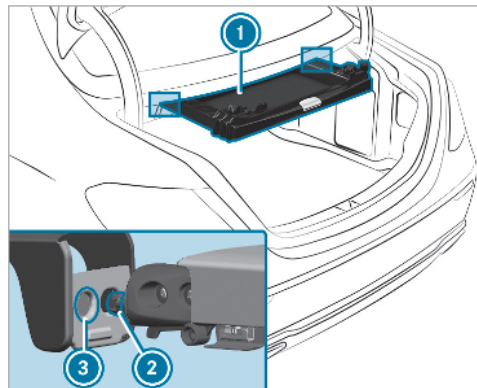

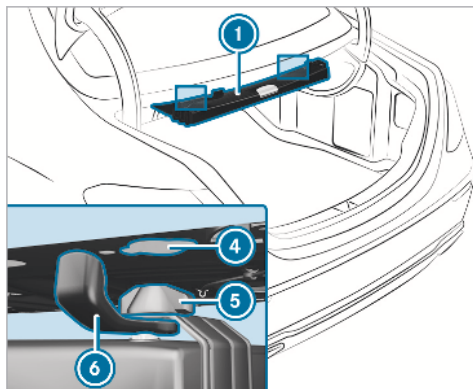

- ▶ Turn rotating catches ⑥ outward.
- ▶ Insert retainers ② of box ① into outer holes ③.
- ▶ Raise box ① and press hooks ⑤ into the anchorages of the rear shelf ④.
- ▶ Turn rotating catches ⑥ inward.

Removing

- ▶ Turn rotating catches ⑥ outward.
- ▶ Lower box ① and pull it out of anchorages in the rear shelf ④.
- ▶ Pull box ① back out of openings ③.

Opening the stowage space under the boot floor

The stowage space under the boot floor can be opened in all vehicles except hybrid vehicles.

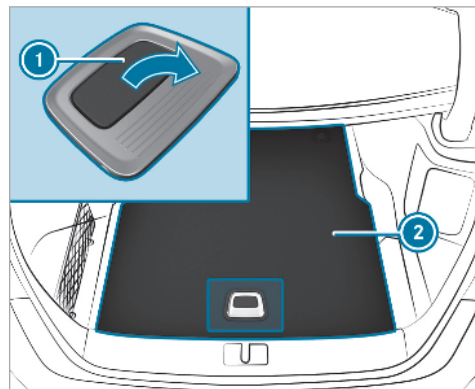

- ▶ Pull boot floor ② upwards using handle ① until it rests against the boot separator.

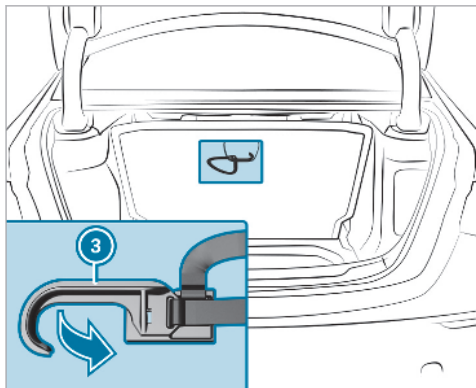

- ▶ Fold out hook ③ on the underside of the boot floor.

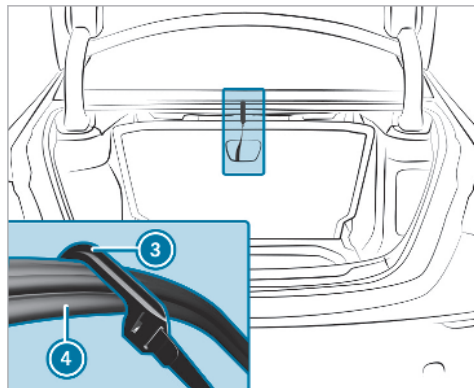

- ▶ Clip hook ③ onto drip rail ④.

Attaching a roof luggage rack

⚠ WARNING Risk of accident due to exceeding the maximum roof load

The vehicle centre of gravity and the usual driving characteristics as well as the steering and braking characteristics alter.

If you exceed the maximum roof load, the driving characteristics, as well as steering and braking, will be greatly impaired.

- ▶ Never exceed the maximum roof load and adjust your driving style.

You will find information on the maximum roof load in the "Technical data" section.

! NOTE Vehicle damage from non-approved roof luggage racks

The vehicle could be damaged by roof luggage racks that have not been tested and approved for Mercedes-Benz.

- ▶ Use only roof luggage racks tested and approved for Mercedes-Benz.

- ▶ Depending on the vehicle equipment, ensure that the sliding sunroof can be fully raised when the roof luggage rack is fitted.
- ▶ Depending on the vehicle equipment, ensure that the boot lid can be fully opened when the roof luggage rack is fitted.
- ▶ Position the load on the roof luggage rack in such a way that the vehicle will not sustain damage even when it is in motion.

! **NOTE** Damage to the panorama sliding sunroof due to non-approved roof luggage racks

The panorama sliding sunroof may be damaged by the roof luggage rack if you attempt to open it when using a roof luggage rack not tested and approved for Mercedes-Benz.

- ▶ When a roof luggage rack is fitted, open the panorama sliding sunroof only if this

has been tested and approved for Mercedes-Benz.

The panorama sliding sunroof may be raised to allow ventilation of the vehicle interior.

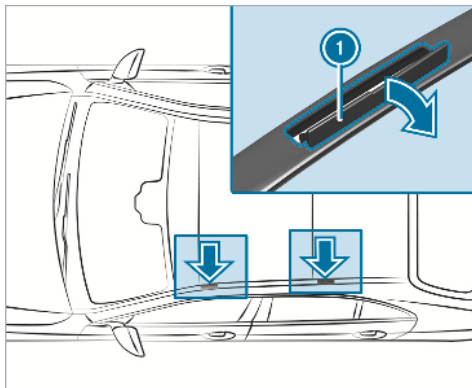

! **NOTE** Damage to the covers

The covers may be damaged and scratched when being opened.

- ▶ Do not use metallic or hard objects.

- ▶ Carefully fold covers ① upwards in the direction of the arrow.
- ▶ Secure the roof luggage rack to the fastening points beneath covers ①.
- ▶ Comply with the installation instructions of the roof luggage rack manufacturer.
- ▶ Secure the load on the roof luggage rack.

Cup holders

Opening the cup holder in the rear armrest

! **NOTE** Damage to the cup holder

When the rear armrest is folded back the cup holder could become damaged.

- ▶ Only fold the rear armrest back when the cup holder is closed.

① The cup holder in the rear armrest is available only in vehicles with a rear bench seat or electrically adjustable outer seats.

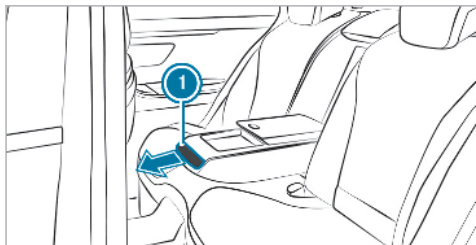

- ▶ **To open:** press cup holder ① twice. The cup holder opens in the direction of the arrow.
- ▶ Place a container in or remove a container from cup holder ①.
- ① Observe the notes on loading the vehicle (→ page 119).

Ashtray and cigarette lighter

Using the ashtray in the front centre console

! **NOTE** Damage to the stowage compartment under the ashtray due to intense heat

The stowage compartment under the ashtray is not heat resistant and could be damaged if you rest a lit cigarette on it.

- ▶ Make sure that the ashtray is fully engaged.

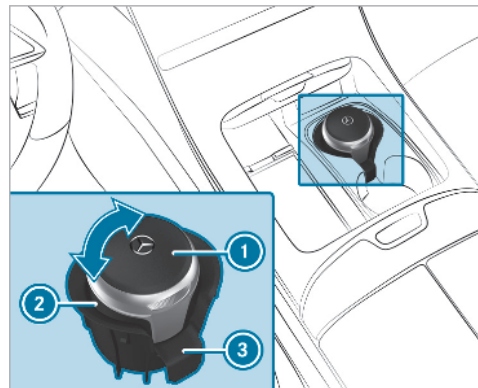

- ▶ **To insert:** close ashtray ② and place it in holder ③ and then insert holder ③ into the front cup holder in the front stowage compartment.
- ▶ Check that it is seated firmly.
- ▶ Comply with the notes on loading the vehicle (→ page 119).

- ▶ **To remove:** pull ashtray ② up and out of holder ③.
- ▶ **To open:** fold lid ① upwards.
- ▶ **To close:** press lid ① downwards.

Removing the holder from the cup holder

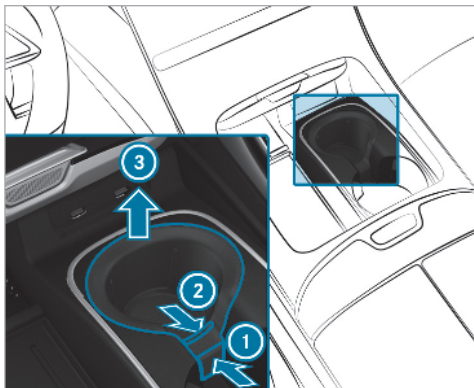

- ▶ **To remove the holder:** position your thumbs on the outside of holder ① and place the other fingers on the inside of holder ②.
- ▶ Firmly pull holder ③ upwards in the direction of the arrow out of the cup holder.
- ⓘ Mercedes-Benz recommends removing the holder from the cup holder only for cleaning. Store the holder and ashtray in a suitable place. Comply with the loading guidelines (→ page 119).

Using the rear ashtray

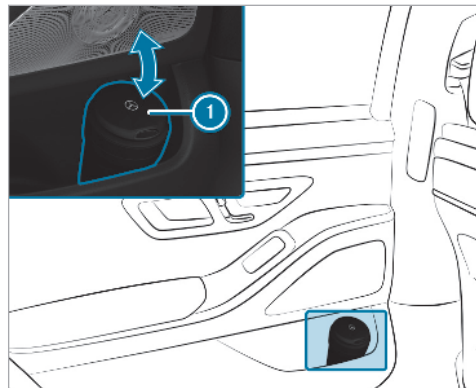

Ashtray in the rear door (example)

- ▶ **To use the ashtray:** place the ashtray in one of the cup holders in the rear compartment or in the holder in the rear door.
- ▶ Check that it is seated firmly.

▶ Comply with the notes on loading the vehicle (→ page 119).

▶ **To open the ashtray:** fold cover ① upwards.

If you are not using the ashtray, close it and place it in the holder in the rear door or in the cup holder in the rear compartment.

Using the cigarette lighter in the rear compartment

⚠ WARNING - Risk of fire and injury from the hot cigarette lighter

You can burn yourself if you touch the hot heating element or the socket of the cigarette lighter.

In addition, flammable materials may ignite if:

- you drop the hot cigarette lighter
- a child holds the hot cigarette lighter to objects, for example

- ▶ Always hold the cigarette lighter by the knob.
- ▶ Always make sure that the cigarette lighter is out of reach of children.
- ▶ Never leave children unattended in the vehicle.

Requirements:

- The ignition is switched on.

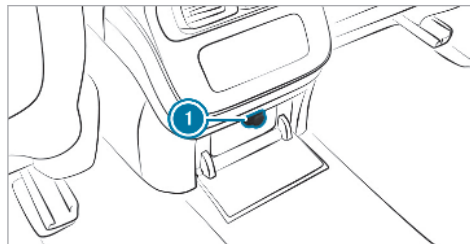

Vehicles with a rear bench seat or electrically adjustable outer seats

▶ **Vehicles with rear bench seat or electrically adjustable outer seats:** open the elec-

tronics compartment in the rear centre console.

▶ Press in cigarette lighter ①. The cigarette lighter will pop out automatically when the heating element is red-hot.

Sockets

Using the 12 V socket in the rear passenger compartment

Requirements:

- Only connect devices up to a maximum of 180 watts (15 A).

Depending on the vehicle equipment, the vehicle has the following 12 V sockets:

- In the front passenger footwell
- On vehicles with a rear bench seat or electrically adjustable outer seats: in the electronics compartment of the rear centre console
- In the boot

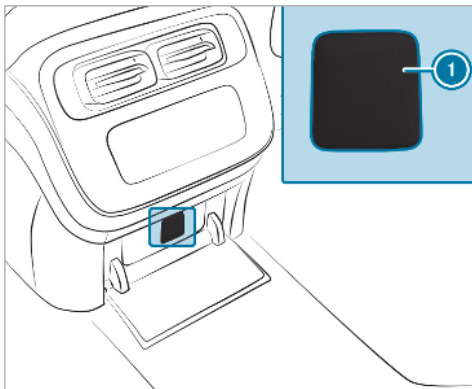

Vehicles with a rear bench seat or electrically adjustable outer seats

- ▶ **Vehicles with a rear bench seat or electrically adjustable outer seats:** open the electronics compartment in the rear centre console.
- ▶ Fold up socket cap ①.
- ▶ Insert the plug of the device.

If you have connected a device to the 12 V socket, leave the cover of the stowage compartment open.

Using the 230 V socket in the rear passenger compartment

⚠ DANGER Risk of fatal injury due to damaged connecting cables or sockets

You could receive an electric shock if the connecting cable or the 230 V power socket is pulled out of the trim or is damaged or wet.

- ▶ Use only connecting cables that are dry and free of damage.
- ▶ When the ignition is switched off, make sure that the 230 V power socket is dry.
- ▶ Immediately have the 230 V power socket checked or replaced at a qualified specialised workshop if it is damaged or has been pulled out of the trim.

- ▶ Never plug the connecting cable into a 230 V power socket that is damaged or has been pulled out of the trim.

⚠ DANGER Risk of fatal injury due to incorrect handling of the socket

You could receive an electric shock in particular:

- if you reach into the socket.
- if you insert unsuitable devices or objects into the socket.

- ▶ Do not reach into the socket.
- ▶ Only connect suitable devices to the socket.

Requirements:

- Only connect devices with a suitable plug which conforms to the standards specific to the country you are in.
 - Do not use multiple socket outlets.
- ① Only devices up to a maximum of 150 watts can be connected.

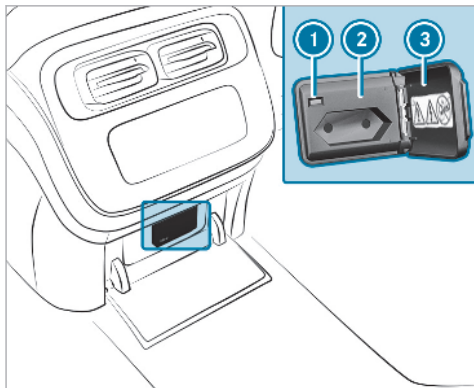

Vehicles with a rear bench seat or electrically adjustable outer seats

- ▶ **Vehicles with a rear bench seat or electrically adjustable outer seats:** open the electronics compartment in the rear centre console.
- ▶ Open flap ③.

- ▶ Insert the plug of the device into 230 V socket ②. When the on-board electrical system voltage is sufficient, indicator lamp ① lights up.

USB port in the rear

Depending on the vehicle equipment, the vehicle has the following USB ports in the rear passenger compartment:

- On vehicles with a rear bench seat or electrically adjustable rear outer seats: in the electronics compartment of the rear centre console (→ page 122).
- On vehicles with a rear bench seat or electrically adjustable rear outer seats: in the stowage compartment in the rear seat armrest (→ page 122).

USB port in the rear armrest

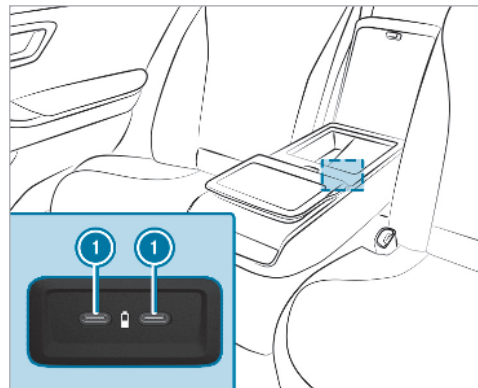

Example: vehicles with electrically adjustable rear outer seats

You can charge a USB device, such as a mobile phone, at USB ports ① using a suitable charging cable. Depending on the vehicle equipment, the devices can be charged with up to 20 V (5 A), when the ignition is switched on.

Coolbox

Using the refrigerator box

⚠ WARNING Risk of fire due to a covered ventilation grille on the coolbox

If you cover the ventilation grille for the coolbox, it may overheat.

▶ Always make sure that the ventilation grille is not covered.

The ventilation grille for the refrigerator box is in the boot.

The refrigerator box can bear a maximum load of 3.5 kg up to 4 kg.

In the upper compartment of the refrigerator box, plastic bottles, for example, can be stowed with a maximum of 0.5 litres and cans with up to 0.33 l

If you do not need to use the refrigerator box for an extended period you should switch it off, defrost it and clean it. After doing so, leave the lid open for a time.

The refrigerator box will reduce its cooling capacity or switch off in the following cases:

- too many electrical consumers are turned on
- the starter battery is not sufficiently charged

If this is the case, the indicator lamps will flash on the button for switching the refrigerator box on and off. The cooling function will automatically switch back on as soon as there is sufficient voltage.

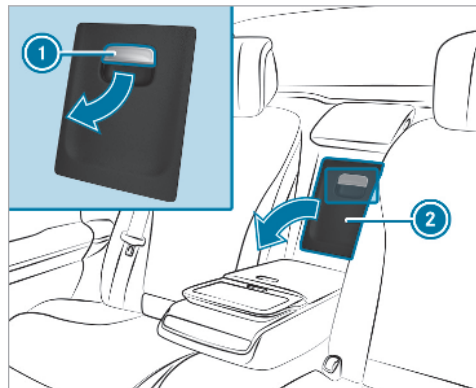

Vehicles with electrically adjustable outer seats

- ▶ Vehicles with electrically adjustable outer seats: fold down the rear armrests.
- ▶ Pull handle on stowage box ① and fold down the cover of stowage box ②.

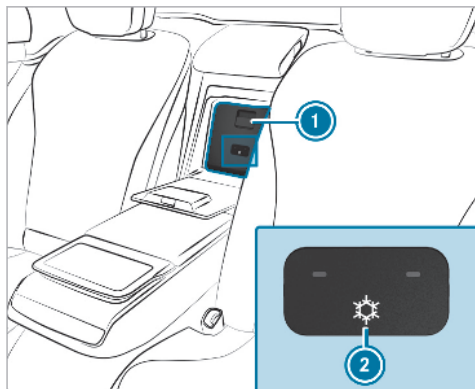

Vehicles with electrically adjustable outer seats

- ▶ **To open:** pull the handle on refrigerator box ① and fold down the cover of the refrigerator box.
- ▶ **To switch on:** press button ② repeatedly until an indicator lamp (low cooling) flashes or two indicator lamps (high cooling) flash.

- ▶ **To switch off:** press button ② repeatedly until both indicator lamps go out.

Removing or fitting the refrigerator box

Installing

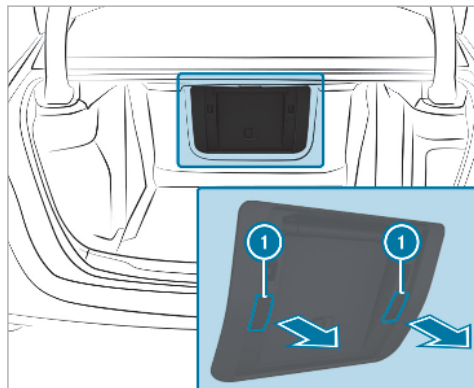

- ▶ Remove cover cap ①.

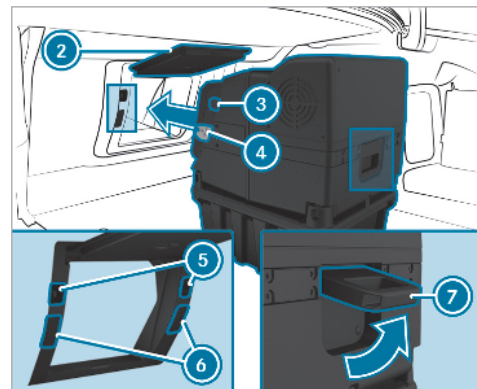

- ▶ Open loading flap ② in the rear compartment until the loading flap locks in the highest position (→ page 124).
- ▶ Pull upwards and hold handle ⑦. The ISOFIX connection to refrigerator box ④ is unlocked.

- ▶ Slide the refrigerator box with handle ⑦ up into the open through-loading feature. ISOFIX connection ④ and the electrical contacts of refrigerator box ③ are inserted into sockets ⑤ and ⑥ of the through-loading feature.
- ▶ Once the refrigerator box has been connected in the vehicle, push down handle ⑦. The refrigerator box is locked.

Removing

- ▶ Pull up and hold handle ⑦.
- ▶ Pull the refrigerator box with handle ⑦ up out of sockets ⑤ and ⑥ of the through-loading compartment. ISOFIX connection ④ and the electrical contacts of refrigerator box ③ are separated from sockets ⑤ and ⑥ of the through-loading feature.

Opening and closing the stowage compartment of the refrigerator box in the boot

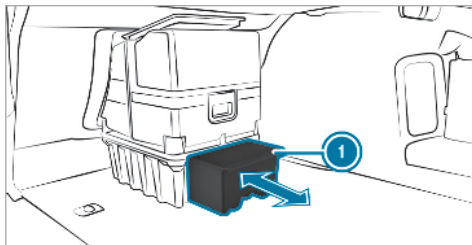

- ▶ **To open:** pull the stowage compartment in the refrigerator box ① out by the handle backwards in the direction of the arrow. The stowage compartment ① is open.
- ▶ **To close:** slide the stowage compartment in the refrigerator box ① forwards in the direction of the arrow. The stowage compartment ① is closed.

Wireless charging of the mobile phone and connection with the exterior aerial

Notes on wirelessly charging the mobile phone

⚠ WARNING Risk of injury due to objects being stowed incorrectly

If objects in the vehicle interior are stowed incorrectly, they can slide or be thrown around and hit vehicle occupants. In addition, cup holders, open stowage spaces and mobile phone receptacles cannot always retain all objects they contain.

There is a risk of injury, particularly in the event of sudden braking or a sudden change in direction.

- ▶ Always stow objects so that they cannot be thrown around in such situations.
- ▶ Always make sure that objects do not protrude from stowage spaces, luggage nets or stowage nets.

- ▶ Close the lockable stowage spaces before starting a journey.
- ▶ Always stow and secure heavy, hard, pointed, sharp-edged, fragile or bulky objects in the boot/load compartment.

Observe the notes on loading the vehicle.

⚠ WARNING Risk of fire from placing objects in the mobile phone stowage compartment

Placing other objects in the mobile phone stowage compartment could constitute a fire hazard.

- ▶ Apart from a mobile phone, do not place any other objects in the mobile phone stowage compartment, especially those made of metal.

! NOTE Damage to objects caused by placing them in the mobile phone stowage compartment

If objects are placed in the mobile phone stowage compartment, they may be damaged by electromagnetic fields.

- ▶ Do not place credit cards, data storage devices, ski passes or other objects sensitive to electromagnetic fields in the mobile phone stowage compartment.

! NOTE Damage to the mobile phone stowage compartment caused by liquids

If liquids enter the mobile phone stowage compartment, the compartment may be damaged.

- ▶ Ensure that no liquids enter the mobile phone stowage compartment.

Always observe the notes for persons with electronic medical aids (→ page 31).

- Depending on the vehicle equipment, the mobile phone is connected to the vehicle's exterior aerial via the charging module.
- The charging function and wireless connection of the mobile phone to the vehicle's exterior aerial are only available if the ignition is switched on.
- Small mobile phones may not be able to be charged in every position of the mobile phone stowage compartment.
- Large mobile phones which do not rest flat in the mobile phone stowage compartment may not be able to be charged or connected with the vehicle's exterior aerial.
- The mobile phone may heat up during the charging process. This may also depend on the applications (apps) currently open in the background.
- To ensure more efficient charging and connection with the vehicle's exterior aerial, remove the protective cover from the mobile phone. Protective covers which are necessary for wireless charging are excluded.

- When charging, the mat should be used if possible.

Wirelessly charging a mobile phone in the front

Requirements:

- The mobile phone is suitable for wireless charging. You can find a list of compatible mobile phones at:

<https://www.mercedes-benz-mobile.com>

Depending on the vehicle's equipment, the vehicle has the following options for wirelessly charging the mobile phone in the cockpit:

- In the front stowage compartment
- In the stowage compartment of the cockpit armrest

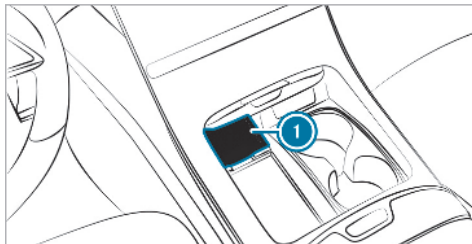

Example: wirelessly charging the mobile phone in the front stowage compartment

- ▶ Place the mobile phone as close to the centre of mat ① as possible with the display facing upwards.

Wirelessly charging a mobile phone in the front stowage compartment: when a message is shown in the multimedia system, the mobile phone is being charged. In addition, malfunctions during the mobile phone's charging process are shown in the multimedia system display.

Wirelessly charging the mobile phone in the centre console below the armrest: the mobile phone is charging when the indicator lamp is lit

up. In addition, malfunctions during the mobile phone's charging process are shown by the indicator lamp flashing three times.

- ① The mat can be removed for cleaning, e.g. using clean, lukewarm water.

Wireless charging of a mobile phone in the rear passenger compartment

Requirements:

- The mobile phone is suitable for wireless charging. You can find a list of compatible mobile phones at:

<https://www.mercedes-benz-mobile.com>

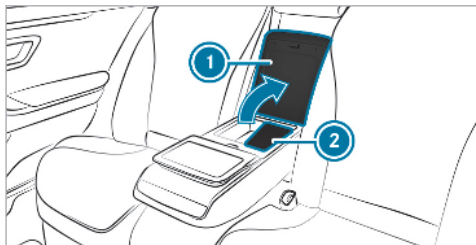

Vehicles with electrically adjustable outer seats

- ▶ Fold down the rear armrest.
- ▶ Open the stowage compartment in rear armrest ① (→ page 122).
- ▶ Place the mobile phone as close to the centre of mat ② as possible with the display facing upwards.
When the indicator lamp at the front of the mobile phone system lights up, the mobile phone is being charged. In addition, malfunctions during the mobile phone's charging process are shown by the indicator lamp flashing three times.

① Observe the notes on loading the vehicle (→ page 119).

Fitting and removing the floor mats

⚠ WARNING Risk of accident due to objects in the driver's footwell

Objects in the driver's footwell may impede pedal travel or block a depressed pedal.

This jeopardises the operating and road safety of the vehicle.

- ▶ Stow all objects in the vehicle securely so that they cannot get into the driver's footwell.
- ▶ Always fit the floor mats securely and as prescribed in order to ensure that there is always sufficient room for the pedals.
- ▶ Do not use loose floor mats and do not place floor mats on top of one another.

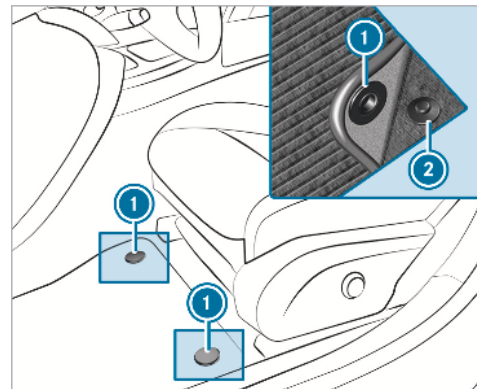

- ▶ **To fit:** slide the corresponding seat backwards and lay the floor mat in the footwell such that it fits.
- ▶ Press the studs ① onto the holders ②.
- ▶ Adjust the corresponding seat.
- ▶ **To remove:** slide the corresponding seat backwards and pull the floor mat off the holders ②.

- ▶ Adjust the corresponding seat.

Exterior lighting

Notes on adjusting the lights when driving abroad

The headlamps are automatically adjusted when the vehicle enters countries where traffic drives on the other side of the road. If necessary, the headlamps can also be adjusted manually (→ page 150).

In the following cases, check the setting of the headlamps and change it manually if necessary:

- If the **Dipped-beam setting (left/right-side traffic) Manual adjustment only** display message is displayed.
- If the **Check dipped-beam setting (left/right-side traffic)** display message is displayed.

Once the headlamps have been converted:

- Oncoming traffic will not be dazzled.
- The edge of the road will not be illuminated as far or as high.
- The "motorway mode" and "enhanced fog light" functions will not be available.

Information about lighting systems and your responsibility



The various lighting systems of the vehicle are only aids. The driver of the vehicle is responsible for correct vehicle illumination in accordance with the prevailing light and visibility conditions, legal requirements and traffic situation.

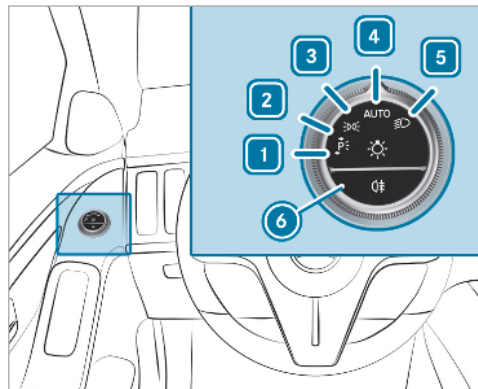

Light switch

Operating the light switch



- 1 Left-hand parking lights
- 2 Right-hand parking lights
- 3 Standing lights and licence plate lighting
- 4 **AUTO** Automatic driving lights (preferred light switch position)



- 5  Low beam / high beam
- 6  Switches the rear fog light on/off

When low beam is activated, the indicator lamp for the standing lights  will be deactivated and replaced by the low-beam indicator lamp .

- ▶ Always park your vehicle safely using sufficient lighting, in accordance with the relevant legal stipulations.

! **NOTE** Battery discharging by operating the standing lights

Operating the standing lights over a period of hours puts a strain on the battery.

- ▶ Where possible, switch on the right  or left  parking light.

In the event of severe battery discharging, the standing lights or parking lights will be switched off automatically to facilitate the next engine start.

The exterior lighting (except standing and parking lights) will switch off automatically when the driver's door is opened.

- Observe the notes on surround lighting (→ page 150).

Automatic driving lights function

The standing lights, low beam and daytime running lights are switched on automatically depending on the ignition status and the light conditions.



! **WARNING** Risk of accident when the dipped beam is switched off in poor visibility

When the light switch is set to **AUTO**, the dipped beam may not be switched on automatically if there is fog, snow or other causes of poor visibility such as spray.

- ▶ In such cases, turn the light switch to .

The automatic driving lights are only an aid. You are responsible for vehicle lighting.

Switching the rear fog lights on or off Requirements:

- The light switch is in the  or **AUTO** position.
- ▶ Press the  button.

Please observe the country-specific laws on the use of rear fog lamps.

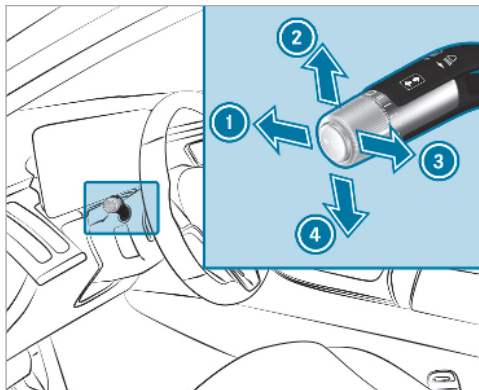

Operating the combination switch for the lights



- ① High beam
- ② Turn signal light, right
- ③ Headlamp flashing
- ④ Turn signal light, left

▶ Use the combination switch to activate the desired function.

High beam

- ▶ **To switch on:** turn the light switch to the  or **AUTO** position.
- ▶ Push the combination switch in the direction of arrow ①. When the high beam is activated, the indicator lamp for low beam  will be deactivated and replaced by the indicator lamp for high beam .
- ▶ **To switch off:** push the combination switch in the direction of arrow ① or pull it in the direction of arrow ③.

Headlamp flashing

- ▶ Pull the combination switch in the direction of arrow ③.

Turn signal light

- ▶ **To indicate briefly:** push the combination switch briefly to the point of resistance in the direction of arrow ② or ④. The corresponding turn signal light will flash three times.

▶ **To indicate permanently:** push the combination switch beyond the point of resistance in the direction of arrow ② or ④.

Vehicles with Active Lane Change Assist:

- Indicator operation activated by the driver can extend for the duration of the lane change.
- If the driver indicated directly beforehand but a lane change was not immediately possible, the turn signal indicator may activate automatically.

Activating/deactivating the hazard warning lights

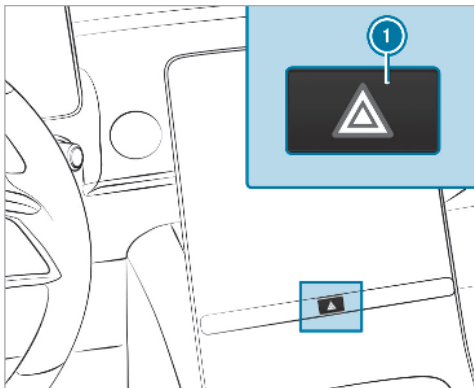

▶ Press button ①.

The hazard warning lights will switch on automatically if:

- the airbag has been deployed
- the vehicle brakes sharply from a speed of more than 70 km/h to a standstill.

When you pull away again, the hazard warning lights will switch off automatically at approximately 10 km/h. You can also switch off the hazard warning light system using the warning lamp button.

Adaptive functions MULTIBEAM LED and DIGITAL LIGHT

Intelligent Light System function

The headlamps adapt to the driving and weather situation and provide extended functions for improved illumination of the road.

The system comprises the following functions:

- Active headlamps (→ page 146)
- Cornering light (→ page 147)
- Motorway mode (→ page 147)
- Enhanced fog light function (→ page 147)
- Adverse weather light (→ page 148)
- City lighting (→ page 148)

The system is active only when it is dark.

Active headlamps function

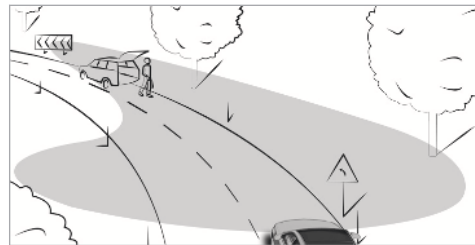

Functions of the active headlamps:

- The headlamps follow the steering movements.
- Relevant areas are better illuminated during a journey.

The functions are active when the low beam is switched on.

Depending on the vehicle's equipment, the course of the lane in which you are driving will also be evaluated and the active headlamps function will adjust the light in advance.

Cornering light function

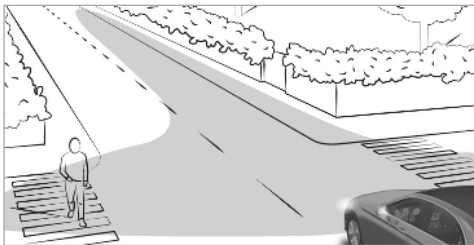

The cornering light improves the illumination of the carriageway over a wide angle in the turning direction, enabling better visibility on tight bends, for example. It can be activated only when the low beam is switched on.

The function is active in the following cases:

- At speeds below 40 km/h when the turn signal light is switched on or the steering wheel is turned
- At speeds between 40 km/h and 70 km/h and when the steering wheel is turned

Roundabout and junction function: the cornering light will be activated on both sides based on an evaluation of the vehicle's current navigation position. It will remain active until after the vehicle has left the roundabout or the junction.

Motorway mode function

Motorway mode increases the range and brightness of the cone of light, enabling better visibility.

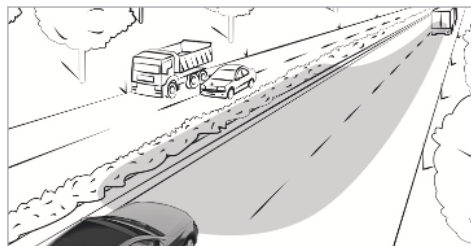

The function is active if a motorway journey is detected by means of:

- the vehicle's speed
- the multifunction camera

- or the navigation system

The function is not active in the following cases:

- At speeds below 80 km/h

Enhanced fog light function

The enhanced fog light function reduces self-dazzling and improves the illumination of the edge of the carriageway.

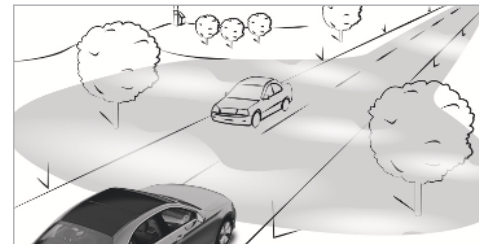

The function is automatically activated under the following conditions:

- At speeds below 70 km/h and when the rear fog light is switched on.

The function is automatically deactivated under the following conditions:

- At speeds above 100 km/h after activation.
- When the rear fog light is switched off.

 You can activate the enhanced fog light function up to a speed of 100 km/h by switching on the rear fog light.

Function of the adverse weather light

The adverse weather light reduces reflections in rainy conditions by dimming individual LEDs in the headlamps. This reduces glare for the driver and other road users.

The city lighting function

City lighting improves the illumination of road-sides in urban areas using a broad distribution of light.

The function is active in the following cases:

- At low speeds
- In illuminated parts of urban areas

Switching the Intelligent Light System on/off

Requirements:

- The ignition is switched on.

Multimedia system:

 **DIGITAL LIGHT**

Activating/deactivating dynamic low beam

 Activate or deactivate **dynamic low beam**.

 In vehicles with MULTIBEAM LED headlamps, the Intelligent Light System can be switched on and off in the MULTIBEAM LED menu.

Switching enhanced assistance functions on/off

 Switch **warnings**, **notes** and **Spotlight** on or off.

 The warnings and notes functions are available only in vehicles with DIGITAL LIGHT.

Adaptive Highbeam Assist Plus

Adaptive Highbeam Assist Plus function

 **WARNING** Risk of accident despite Adaptive Highbeam Assist Plus

Adaptive Highbeam Assist Plus does not react to:

- road users without lights, e.g. pedestrians
- road users with poor lighting, e.g. cyclists
- road users whose lighting is obstructed, e.g. by a barrier

On very rare occasions, Adaptive Highbeam Assist Plus may fail to recognise other road users with their own lighting, or may recognise them too late.

In these, or in similar situations, the automatic high beam will not be deactivated or will be activated despite the presence of other road users.

- ▶ Always observe the road and traffic conditions carefully and switch off the high beam in good time.

Adaptive Highbeam Assist Plus cannot take into account road, weather or traffic conditions.

Detection may be restricted in the following cases:

- In poor visibility, e.g. fog, heavy rain or snow
- If there is dirt on the sensors or the sensors are obscured

Adaptive Highbeam Assist Plus is only an aid. You are responsible for adjusting the vehicle's lighting to the prevailing light, visibility and traffic conditions.

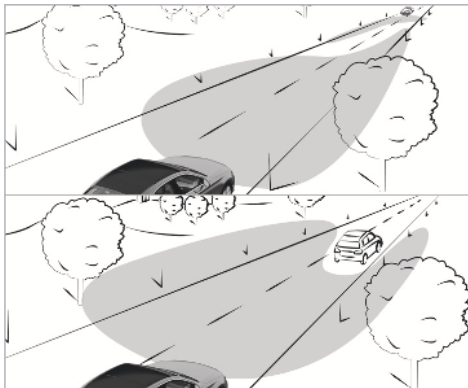

Adaptive Highbeam Assist Plus automatically switches between the following types of light:

- Low beam
- Partial high beam
- High beam
- ULTRA RANGE Highbeam (only vehicles with DIGITAL LIGHT)

ULTRA RANGE Highbeam increases the brightness of the cone of light to the legally permitted maximum.

Partial high beam uses the high beam to shine past other road users rather than dazzling them. The vehicle in front will be illuminated by the low beam.

At speeds below 25 km/h or when there is sufficient street lighting:

- The partial high beam and the high beam will be switched off automatically.

At speeds greater than 30 km/h:

- If no other road users are detected, the high beam will be switched on automatically.
- If other road users are detected, the partial high beam will be switched on automatically.

At speeds above 40 km/h:

- If no other road users are detected on a straight road, ULTRA RANGE Highbeam will be switched on automatically.
- If other road users are detected, the partial high beam will be switched on automatically.

- If highly reflective signs are detected, ULTRA RANGE Highbeam will be switched off automatically.

At speeds greater than approximately 50 km/h:

- The headlamp range of the low beam is regulated automatically based on the distance to other road users.

The system's optical sensor is located behind the windscreen near the overhead control panel.

Switching Adaptive Highbeam Assist Plus on/off

- ▶ **To switch on:** turn the light switch to the **AUTO** position.
- ▶ Switch on the high beam using the combination switch.
When the high beam is switched on automatically in the dark, the  indicator lamp will light up on the driver's display.
- ▶ **To switch off:** switch off the high beam using the combination switch.

Setting low beam

Multimedia system:

   Settings  Lights  DIGITAL LIGHT  Low beam

- ▶ Select **right-hand traffic**, **left-hand traffic** or **automatic**.
-  In vehicles with MULTIBEAM LED headlamps, low beam can be set in the MULTIBEAM LED menu.

Setting the exterior lighting switch-off delay time

Requirements:

- The light switch is in the **AUTO** position.



Multimedia system:

   Settings  Lights  Farewell  Exterior lighting delayed switch off

- ▶ Set the switch-off delay time.
When the vehicle engine is switched off, the exterior lighting will be activated for the set time.

Switching the surround lighting on/off

Multimedia system:

   Settings  Lights  Greeting  Activate or deactivate Surround lighting.

When the function is activated, the exterior lighting lights up for 40 seconds after the vehicle is unlocked. When you start the vehicle, the surround lighting is deactivated and the automatic driving lights are activated.

Activating/deactivating activation upon approach



- ▶ Switch **Activation when approaching** on or off.

When the function is activated, the exterior lighting lights up as soon as the key is near the vehicle.

Interior lighting

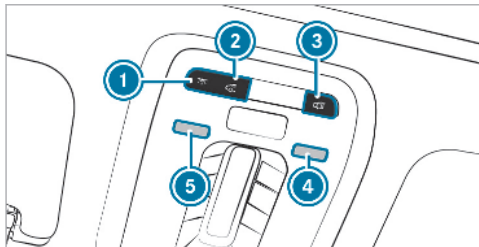
Adjusting the interior lighting





- ①  Switches the front interior lighting on/off
- ②  Switches the rear interior lighting on/off
- ③  Switches the automatic interior lighting control on/off

▶ **To switch reading lamps on/off:** hold your hand under the respective reading lamp ④ or ⑤.

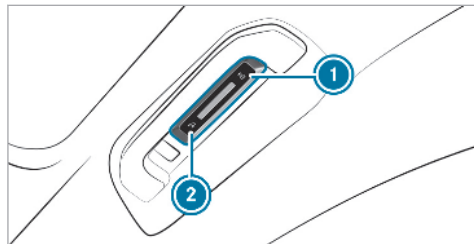
Control panel inside the grab handle (rear)



- ①  Reading lamp on the respective side of the vehicle
- ②  Rear interior lighting

▶ **To switch reading lamps on:** press button ①.
The reading lamp, the interior lighting in the grab handle and the dome lamp on the respective side of the vehicle will light up.

- ▶ **To switch reading lamps off:** press button ① once or twice.
After pressing it once, the interior lighting in the grab handle and the dome lamp on the respective side of the vehicle will go out.
After pressing it twice, the reading lamp on the respective side of the vehicle will go out.
- ▶ **To switch the rear interior lighting on or off:** press button ②.
The reading lamps, the interior lighting in the grab handle and the dome lamps on both sides of the vehicle will light up or go out.

Adjusting the ambient lighting

Multimedia system:

 ▶▶ Comfort ▶▶ Ambient lighting

Setting the colour

- ▶ Select **Colour**.
- ▶ Set the desired colour or colour combination.

Adjusting the brightness

- ▶ Select **Brightness**.

Adjust the brightness.

Activating the brightness for zones

- ▶ Select **Brightness**.
- ▶ Select **Brightness zones**.
The **Emphasis**, **Ambient** and **Impression** zones can be set separately.
- ⓘ The **Silhouette** zone can also be set in vehicles with active ambient lighting.

Activating effects

- ▶ Select **Effects**.
- ▶ Activate the desired effect.

Depending on the vehicle equipment, different effects are available:

- **Multi-colour animat.:** The chosen colour combination will change at predefined intervals.
- **Warning when exiting:** If an object is detected in the blind spot while you are getting out of the vehicle, a warning will appear in the ambient lighting.
- **Climate:** If changes are made to the temperature setting in the vehicle, the colour of the ambient lighting will change briefly.

- **Operating feedback:** Depending on the previous status, all operating feedback is activated or deactivated.
- **Warning assistance:** Depending on the previous status, all warning assistance is activated or deactivated.
- ⓘ The desired operating feedback and warning assistance can be activated or deactivated via the  symbol.

Switching the interior lighting switch-off delay time on/off

Multimedia system:

 ▶▶ **Settings** ▶▶ **Lights** ▶▶ **Farewell**

- ▶ Activate or deactivate **Interior lighting delayed switch off**.
When this function is active, the interior lighting lights up for a short time after the vehicle is locked.

Windscreen wipers and windscreen washer system

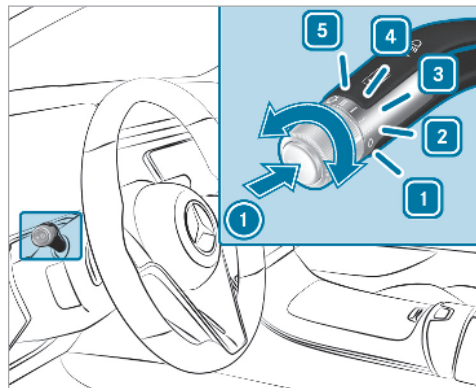

Switching the windscreen wipers on/off





- 1** **0** Windscreen wipers off
- 2** **...** Automatic wiping, normal
- 3** **....** Automatic wiping, frequent



4  Continuous wiping, slow

5  Continuous wiping, fast

▶ Turn the combination switch to the correct position  - .



▶ **Single wipe/washing:** push the button on the combination switch in the direction of arrow .

-  Single wipe
-  Wipes with washer fluid

Vehicles with MAGIC VISION CONTROL: in position  or , the windscreen washing process is automatically triggered if dirt is detected on the windscreen unless the [Top up washer fluid](#) message is being displayed.

Cleaning the windscreen intensively

For heavy soiling, you can clean the windscreen intensively from an outside temperature of 5°C.

▶ In a stationary vehicle, turn the combination switch to position ,  or .

▶ Press the button on the combination switch in the direction of arrow  and hold it for approximately two seconds. The wiper arms will move into the replacement position and washer fluid will be distributed on the windscreen.

After approximately 30 seconds, the wiper arms will move back again and wipe the windscreen several times. Intensive cleaning has now finished.

Replacing the windscreen wiper blades

⚠ WARNING Risk of becoming trapped if the windscreen wipers are switched on while wiper blades are being replaced

If the windscreen wipers begin to move while you are changing the wiper blades, you can be trapped by the wiper arm.

▶ Always switch off the windscreen wipers and ignition before changing the wiper blades.

Moving the wiper arms into the replacement position

- ▶ Switch the ignition on and switch off again immediately.
- ▶ Within around 15 seconds, press and hold the  button on the combination switch for approximately three seconds (→ page 152). The wiper arms will move into the replacement position.

Removing the wiper blades

- ▶ Fold the wiper arms away from the windscreen.

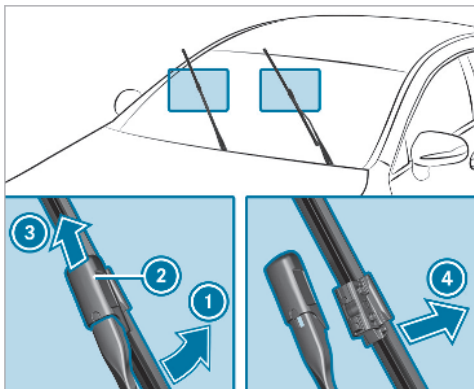

- ▶ Hold the wiper arm with one hand. With the other hand, turn the wiper blade in the direction of arrow ① away from the wiper arm as far as it will go.
- ▶ Slide catch ② in the direction of arrow ③ until it engages in the removal position.
- ▶ Remove the wiper blade from the wiper arm in the direction of arrow ④.

Fitting the wiper blades

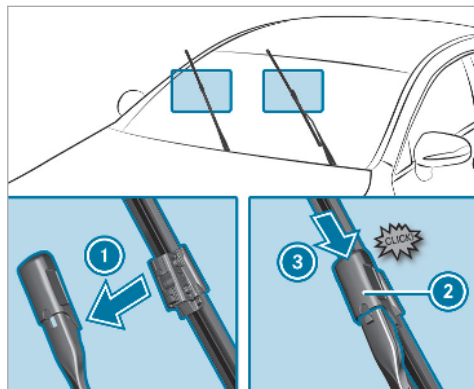

- ▶ Insert the new wiper blade into the wiper arm in the direction of arrow ①.
- ▶ Slide catch ② in the direction of arrow ③ until it engages in the locking position.
- ▶ Make sure that the wiper blade is seated correctly.

- ▶ Fold the wiper arms back onto the wind-screen.
- ▶ Switch on the ignition.
- ▶ Press the  button on the combination switch. The wiper arms will move into the original position.
- ▶ Switch the ignition off.