



S-Class

Owner's Manual

Mercedes-Benz



Front passenger airbag warning

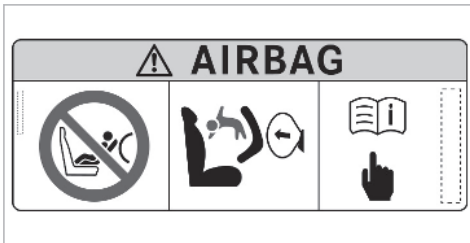

⚠ WARNING Risk of injury or fatal injuries if the front passenger airbag is enabled

If the front passenger airbag is enabled, a child on the front passenger seat may be struck by the front passenger airbag during an accident.

NEVER use a rearward facing child restraint system on a seat protected by an ENABLED FRONT AIRBAG in front of it, this can result in DEATH or SERIOUS INJURY to the child.

Observe the chapter "Children in the vehicle".

Thank you for purchasing a Mercedes-Benz

Before you first drive off, read this Owner's Manual carefully and familiarise yourself with your vehicle. For your own safety and a longer operating lifespan of the vehicle, follow the instructions and warning notices in this Owner's Manual. Disregarding them may lead to damage to the vehicle or injury to people.

The standard equipment and product description of your vehicle may vary and depends on the following factors:

- model
- order
- national version
- availability

The illustrations in this Owner's Manual show a left-hand drive vehicle. On right-hand-drive vehicles, the layout of car parts and control elements differs accordingly.

Mercedes-Benz is constantly developing its vehicles further.

Mercedes-Benz therefore reserves the right to introduce changes in the following areas:

- design
- equipment
- technical features

The equipment in your vehicle may therefore differ from that shown in the descriptions and illustrations.

The following documents are integral parts of the vehicle:

- printed Owner's Manual
- service booklet
- equipment-dependent Supplements

Keep these documents in the vehicle at all times. If you sell the vehicle, always pass all of the documents on to the new owner.

Symbols	5	Qualified specialist workshop	30	Boot	76
At a glance	6	Vehicle registration	30	Side windows	82
Cockpit	6	Correct use of the vehicle	31	Sliding sunroof	86
Indicator and warning lamps	8	Information on the REACH regulation	31	Roller sunblinds	91
Overhead control panel	10	Notes for persons with electronic medi- cal aids	31	Anti-theft protection	93
Door control panel and seat adjustment	12	Implied warranty	31		
Control settings in the rear passenger compartment	14	QR code for rescue card	32	Seats and stowing	96
Emergencies and breakdowns	16	Data storage	32	Notes on the correct driver's seat posi- tion	96
		Copyright	34	Seats	96
				Steering wheel	111
Digital Owner's Manual	18	Occupant safety	35	Easy entry and exit feature	112
Calling up the Digital Owner's Manual	18	Restraint system	35	Operating the memory function	114
		Seat belts	37	Memory function in the rear compart- ment	116
General notes	20	Airbags	42	Stowage areas	119
Protection of the environment	20	PRE-SAFE® system	49	Cup holders	130
Take-back of end-of-life vehicles	20	Automatic measures after an accident	51	Ashtray and cigarette lighter	131
Mercedes-Benz GenuineParts	21	Safely transporting children in the vehi- cle	51	Sockets	133
Owner's Manual	22	Notes on pets in the vehicle	65	Coolbox	136
Touch-sensitive controls	22			Wireless charging of the mobile phone and connection with the exterior aerial	138
Operating safety	22	Opening and closing	67	Fitting and removing the floor mats	141
Declaration of Conformity	24	Key	67		
Diagnostics connection	29	Doors	71		

Light and sight	143	Vehicle towing instructions	272	System settings	322
Exterior lighting	143			Fit & Healthy	331
Interior lighting	151	Instrument Display and on-board computer	273	Navigation and traffic	335
Windscreen wipers and windscreen washer system	152	Overview of the driver display	273	Telephone	371
Mirrors	156	Overview of the buttons on the steering wheel	274	Online and Internet functions	414
Area permeable to radio waves on the windscreen	159	Operating the on-board computer	275	Media	422
Infrared-reflective windscreen function	159	Selecting display content, centre on the instrument cluster	276	Radio	429
		Status displays on the driver display	277	TV	431
		Menus and submenus	278	Sound	437
		Head-up Display	283	MBUX high-end Rear Seat Entertainment System	440
Climate control	160				
Overview of climate control systems	160	MBUX Voice Assistant	286	Maintenance and care	455
Operating the climate control system	161	Notes on operating safety	286	ASSYST PLUS service interval display	455
		Operation	286	Engine compartment	456
		Using MBUX Voice Assistant effectively	289	Cleaning and care	462
Driving and parking	173				
Driving	173	MBUX multimedia system	291	Breakdown assistance	468
DYNAMIC SELECT switch	184	Overview and operation	291	Emergency	468
Automatic transmission	186	MBUX Interior Assistant	310	Flat tyre	470
Function of the 4MATIC	190	Driver camera	320	Battery (vehicle)	476
Refuelling	190			Tow-starting or towing away	482
Parking	196			Electrical fuses	486
Driving and driving safety systems	203				
Trailer hitch	265				
Bicycle rack function	270				

Wheels and tyres	491
Notes on noise or unusual handling characteristics	491
Notes on regularly inspecting wheels and tyres	491
Notes on snow chains	491
Activating or deactivating snow chain mode	492
Tyre pressure	492
Wheel change	495
Emergency spare wheel	505

Technical data	506
Notes on technical data	506
On-board electronics	506
Radio equipment approvals for the vehicle components	508
Vehicle identification plate, VIN and engine number overview	562
Operating fluids	564
Vehicle data	572
Trailer hitch	573

Display messages and warning/indicator lamps	574
Display messages	574
Warning and indicator lamps	634

Index	651
--------------------	------------

In this Owner's Manual, you will find the following symbols:

⚠ DANGER Danger due to not observing the warning notices

Warning notices draw your attention to hazards that may endanger your health or life, or the health or life of others.

▶ Observe the warning notices.

🌿 ENVIRONMENTAL NOTE Environmental damage due to failure to observe environmental notes

Environmental notes include information on environmentally responsible behaviour or environmentally responsible disposal.

▶ Observe environmental notes.

! NOTE Damage to property due to failure to observe notes on material damage

Notes on material damage inform you of risks which may lead to your vehicle being damaged.

▶ Observe notes on material damage.

i These symbols indicate useful instructions or further information that could be helpful to you.

▶ Instruction

(→ page) Further information on a topic

Display Information on the multifunction display/media display

↗▶ Highest menu level, which is to be selected in the multimedia system

▶▶ Relevant submenus, which are to be selected in the multimedia system



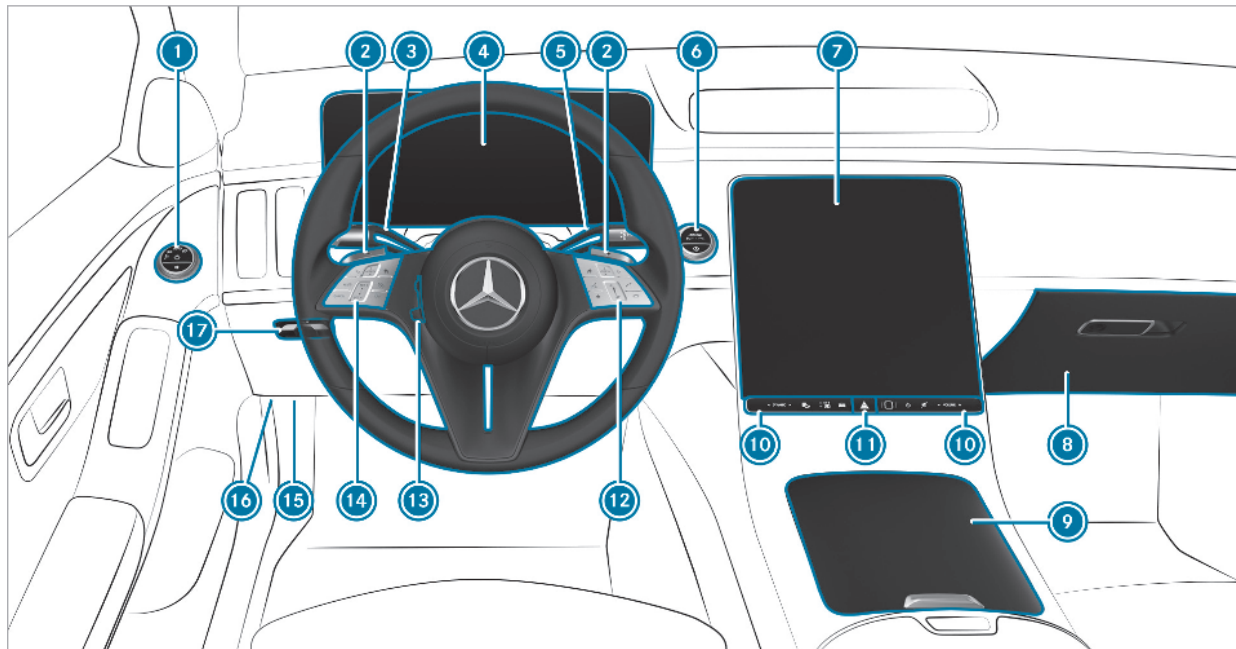



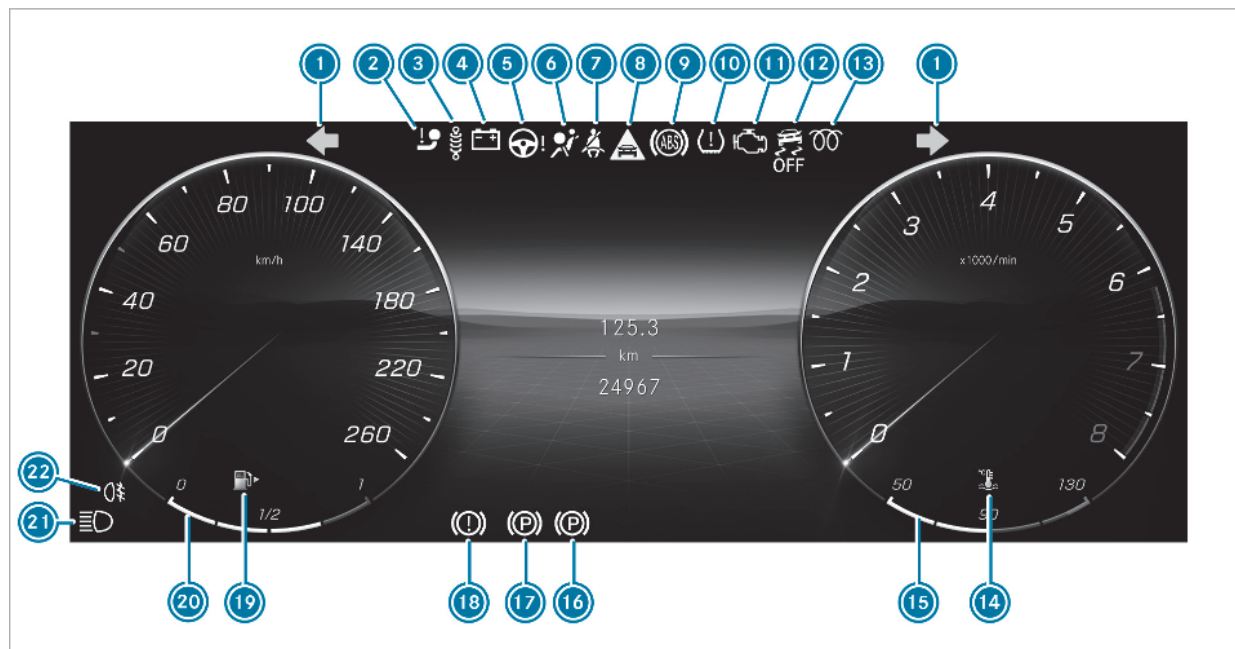





















* Indicates a cause











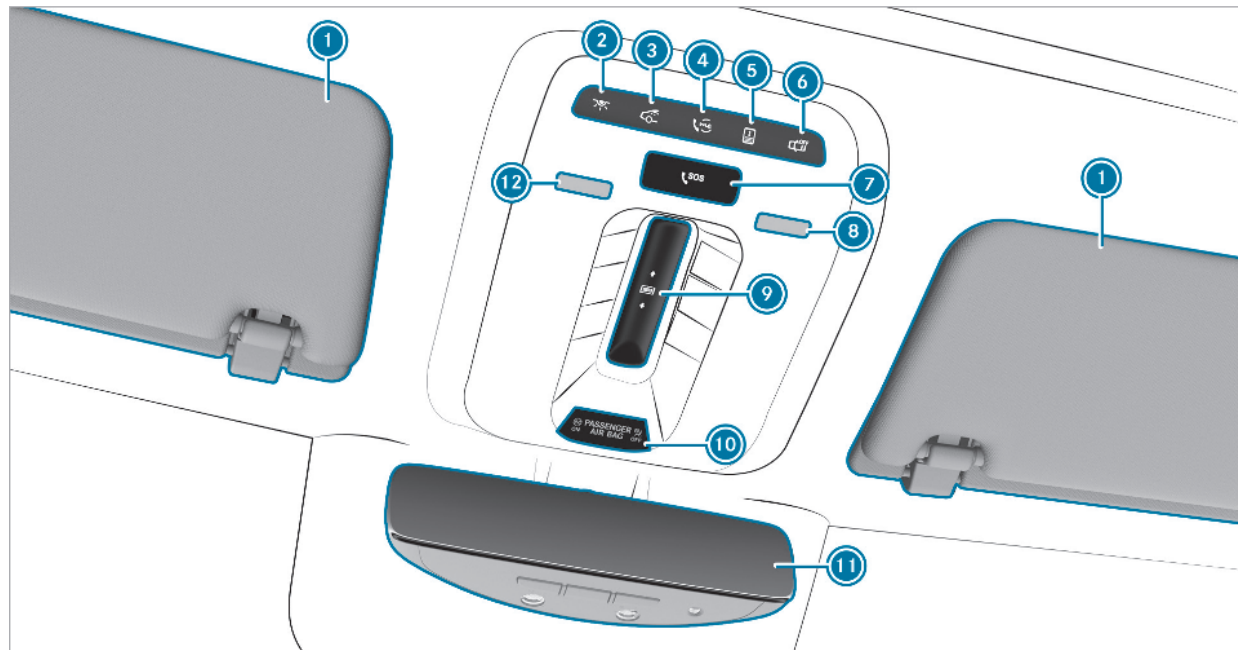

Left-hand drive vehicles



Instrument display

1		Turn signal lights	→	145	12		ESP® OFF	→	646
2		Trailer hitch is not operational or is swivelling	→	637			ESP®	→	646
3		Suspension malfunction (red)	→	645	13		Diesel engine: preglow		
		Suspension malfunction (yellow)	→	645	14		Coolant too hot/cold	→	640
4		Electrical fault	→	640	15		Coolant temperature display	→	273
5		Electric power steering malfunction (red)	→	637	16		Electric parking brake (yellow)	→	643
		Electric power steering malfunction (yellow)	→	637	17		Electric parking brake applied (red)	→	643
		Rear axle steering malfunction (red)	→	637	18		Brakes (red)	→	643
		Rear axle steering malfunction (yellow)	→	637			Brakes (yellow)	→	643
6		Restraint system	→	636	19		Fuel reserve with fuel filler cap location indicator	→	640
7		Seat belt not fastened	→	636	20		Fuel level indicator		
8		Distance warning	→	645	21		High beam	→	145
9		ABS malfunction	→	646			Low beam	→	143
10		Tyre pressure monitor	→	649			Standing lights	→	143
11		Engine diagnostics	→	640	22		Rear fog light	→	144



①	Sun visors		
②	 Switches the front interior lighting on/off	→	151
③	 Switches the rear interior lighting on/off	→	151
④	 me button	→	400
⑤	Opens/closes the rear roller sunblind of the panorama sliding sunroof	→	86
⑥	 Switches automatic interior lighting control on/off	→	151
⑦	 SOS button	→	400
⑧	 Switches the right-hand reading lamp on/off	→	151
⑨	 Opens/closes the panorama sliding sunroof	→	86
	 Opens/closes the front roller sunblind of the panorama sliding sunroof	→	86
⑩	PASSENGER AIRBAG indicator lamps	→	47
⑪	Inside rear-view mirror	→	157
⑫	 Switches the left-hand reading lamp on/off	→	151

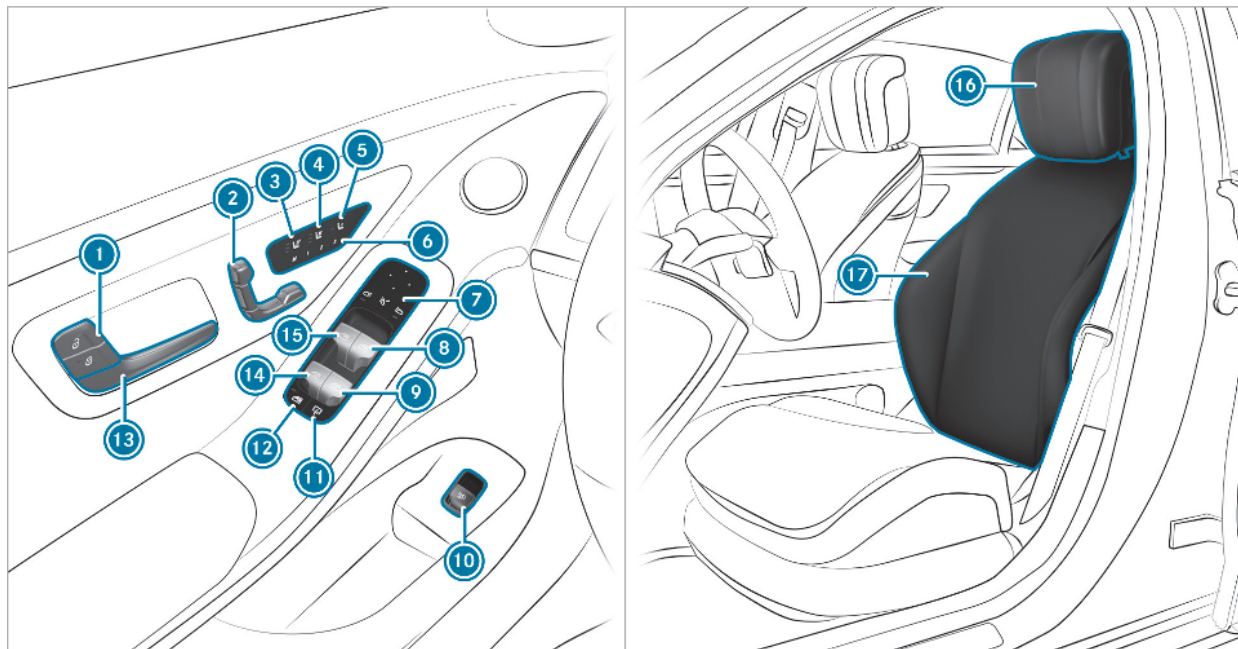

①	Locks/unlocks the vehicle	→	72	⑩	Opens/closes the boot lid	→	76
②	Adjusts the seats electrically	→	96	⑪	Rear-window roller sunblind	→	92
③	Switches the seat heating on/off	→	108	⑫	Child safety lock for the rear side windows	→	65
④	Switches the seat ventilation on/off	→	110	⑬	Opens the door	→	71
⑤	Adjusts the front passenger seat from the driver's seat	→	99	⑭	Opens/closes the rear left side window	→	82
⑥	Operates the memory function	→	114	⑮	Opens/closes the left side window	→	82
⑦	Operates the outside mirrors	→	156	⑯	Adjusts the head restraints	→	102
⑧	Opens/closes the right side window	→	82	⑰	Seat adjustment using the multimedia system	→	106
⑨	Opens/closes the rear right side window	→	82				

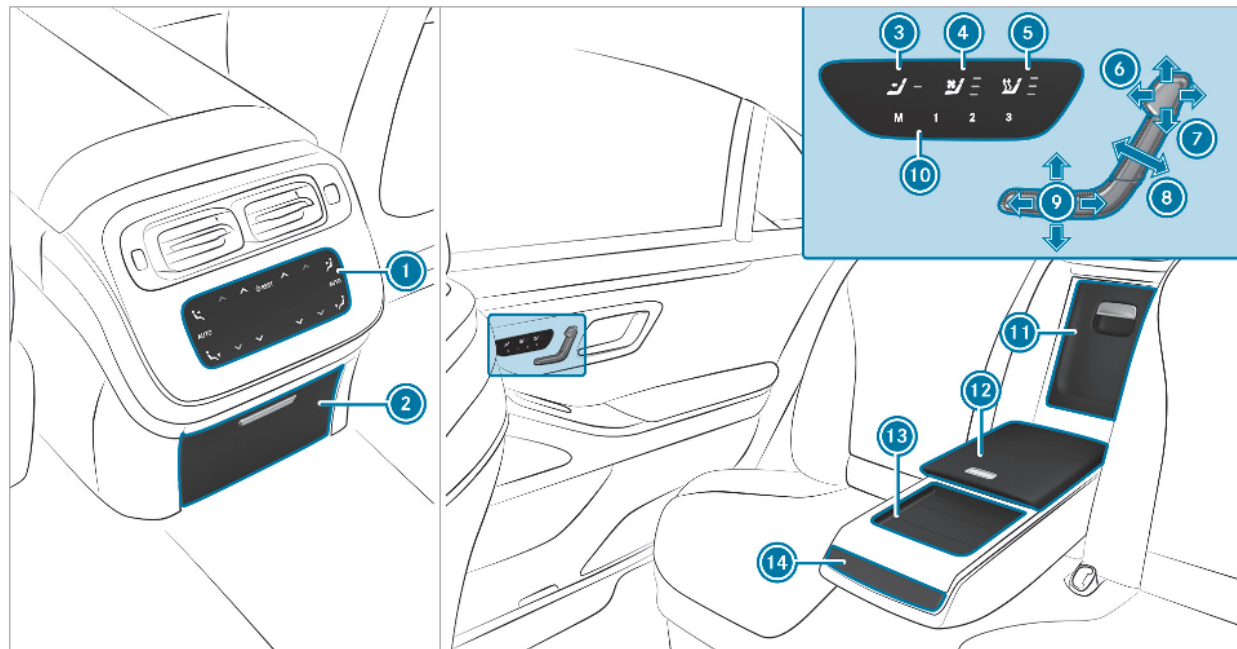

①	Climate control rear operating unit	→	161	⑧	Adjusts the seat backrest inclination	→	100
②	Electronics compartment in the centre console	→	122	⑨	Sets the combined seat cushion inclination and length	→	100
	230 V socket	→	134	⑩	Memory function in the rear compartment	→	116
③	Selects the front passenger seat	→	99	⑪	Stowage box in the seat backrest	→	122
④	Switches the rear seat ventilation on/off	→	110		Refrigerator box	→	136
⑤	Switches the rear seat heating on/off	→	108	⑫	Stowage compartment in the rear armrest	→	122
⑥	Sets the head restraint fore-and-aft position	→	100	⑬	Stowage compartment in the rear armrest	→	122
⑦	Adjusts the head restraint height	→	100	⑭	Cup holder	→	130

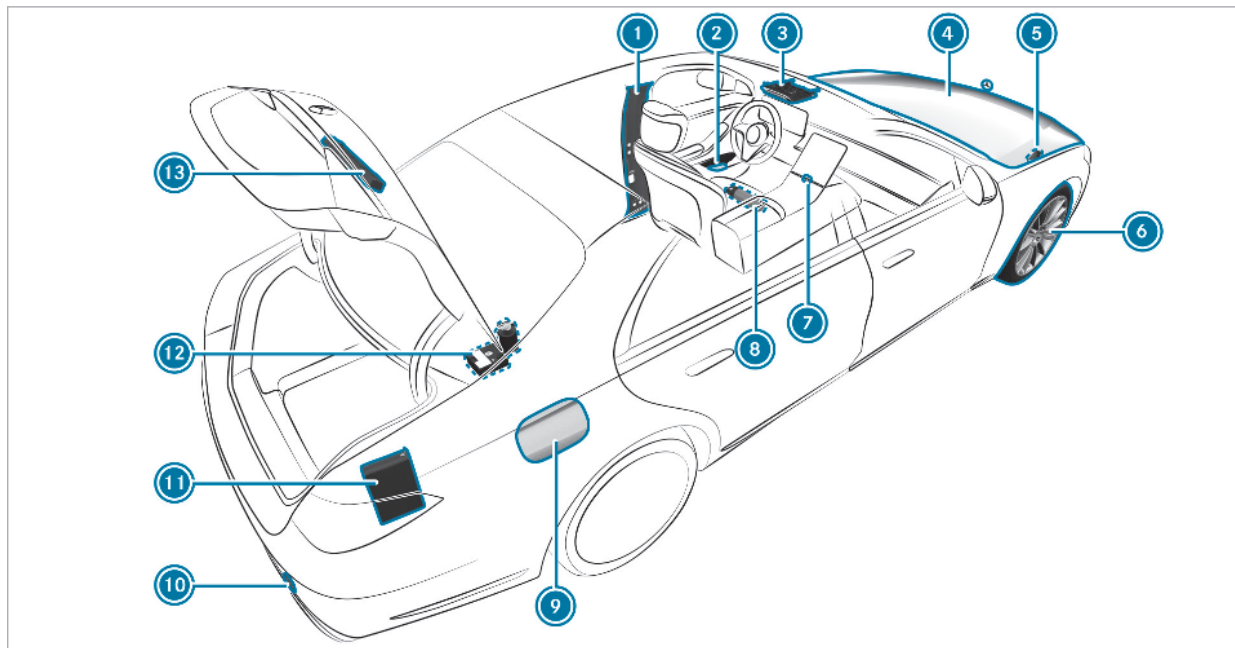

① QR code for accessing the rescue card	→	32	⑧ Fire extinguisher	→	470
② Safety vests	→	468	⑨ Fuel filler flap with instruction labels for tyre pressure, fuel type and QR code for accessing the rescue card	→	190
③ me button and SOS button	→	400	⑩ To tow-start and tow away	→	483
④ To check and top up operating fluids	→	564	⑪ First-aid kit (soft sided)	→	469
Starting assistance	→	480	⑫ TIREFIT kit	→	472
⑤ To tow-start and tow away	→	483	⑬ Warning triangle	→	469
⑥ Flat tyre	→	470			
⑦ Hazard warning light system	→	146			

Calling up the Digital Owner's Manual

Multimedia system:



The Digital Owner's Manual describes the functions and operation of the vehicle and the multimedia system.

▶ Select one of the following menu items in the Digital Owner's Manual:

- **Quick start:** find the first steps towards setting up your vehicle.
- **Tips:** find information that prepares you for certain everyday situations with your vehicle.
- **Animations:** watch animations of the vehicle functions.
- **Messages:** receive additional information about the messages in the driver's display.
- **Language:** select the language for the Digital Owner's Manual.

You can search for keywords using the search field **Search**, in order to find quick answers to questions about the operation of the vehicle.

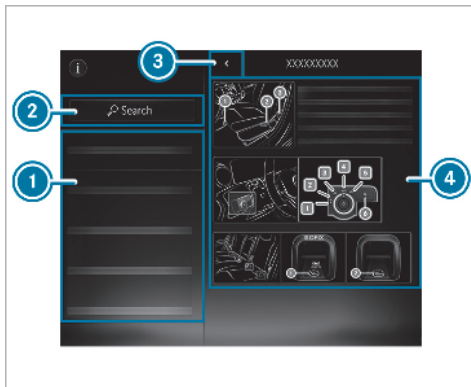

- 1 Menu
- 2 Search
- 3 Back
- 4 Contents section

Some sections in the Digital Owner's Manual, e.g. warning notes, can be expanded and collapsed.

Additional methods of calling up the Digital Owner's Manual:

Direct access: open the required content in the Digital Owner's Manual by pressing and holding an entry on the tab bar in the multimedia system:

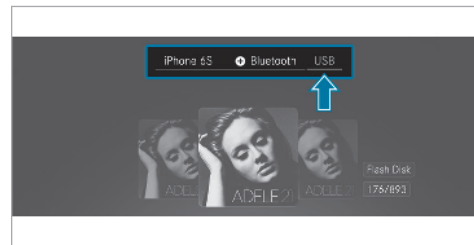

Driver's display: call up brief information as display messages in the instrument cluster

MBUX Voice Assistant: call up via the voice control system

Global search: call up search results for contents of the Digital Owner's Manual in the home screen

For safety reasons, the Digital Owner's Manual is deactivated while driving.

Protection of the environment



ENVIRONMENTAL NOTE Environmental damage due to operating conditions and personal driving style

The pollutant emission of the vehicle is directly related to the way you operate the vehicle.

Operate your vehicle in an environmentally responsible manner to help protect the environment. Please observe the following recommendations on operating conditions and personal driving style.

Operating conditions:

- ▶ Make sure that the tyre pressure is correct.
- ▶ Do not carry any unnecessary weight (e.g. roof luggage racks once you no longer need them).
- ▶ Adhere to the service intervals. A regularly serviced vehicle will contribute to environmental protection.

- ▶ Always have maintenance work carried out at a qualified specialist workshop.

Personal driving style:

- ▶ Do not depress the accelerator pedal when starting the engine.
- ▶ Do not warm up the engine while the vehicle is stationary.
- ▶ Drive carefully and maintain a suitable distance from the vehicle in front.
- ▶ Avoid frequent, sudden acceleration and braking.
- ▶ Change gear in good time and use each gear only up to $\frac{2}{3}$ of its maximum engine speed.
- ▶ Switch off the engine in stationary traffic, e.g. by using the ECO start/stop function.
- ▶ Drive fuel-efficiently. Observe the ECO display for a fuel-efficient driving style.

Take-back of end-of-life vehicles

EU countries only:

Mercedes-Benz will take back your end-of-life vehicle for environment-friendly disposal in accordance with the European Union (EU) End-of-Life Vehicles Directive.

A network of vehicle take-back points and dismantlers has been established for you to return your vehicle. You can leave it at any of these points free of charge. This makes an important contribution to closing the recycling circle and conserving resources.

For further information about the recycling and disposal of end-of-life vehicles, and the take-back conditions, please visit the national Mercedes-Benz website for your country.

Mercedes-Benz GenuineParts

 **ENVIRONMENTAL NOTE** Environmental damage caused by not using recycled reconditioned components

Mercedes-Benz AG offers recycled reconditioned components and parts with the same quality as new parts. The same entitlement from the implied warranty is valid as for new parts.

▶ Recycled reconditioned components and parts from Mercedes-Benz AG.

 **NOTE** Impairment of the operating efficiency of the restraint systems from installing accessory parts or from repairs or welding

Airbags and seat belt tensioners, as well as control units and sensors for the restraint systems, may be installed in the following areas of your vehicle:

- doors

- door pillars
- door sills
- seats
- cockpit
- instrument cluster
- centre console
- lateral roof frame

- ▶ Do not install accessory parts such as audio systems in these areas.
- ▶ Do not carry out repairs or welding.
- ▶ Have accessories retrofitted at a qualified specialist workshop.

You could jeopardise the operating safety of your vehicle if you use parts, tyres and wheels as well as accessories relevant to safety which have not been approved by Mercedes-Benz. Safety-relevant systems, e.g. the brake system, may malfunction. Only use Mercedes-Benz GenuineParts or parts of equal quality. Only use tyres, wheels and accessory parts that have been specifically approved for your vehicle model.

Mercedes-Benz tests original parts and conversion parts and accessory parts that have been specifically approved for your vehicle model for their reliability, safety and suitability. Despite ongoing market research, Mercedes-Benz is unable to assess other parts. Mercedes-Benz therefore accepts no responsibility for the use of such parts in Mercedes-Benz vehicles, even if they have been officially approved or independently approved by a testing centre.

Certain parts are only officially approved for installation or modification if they comply with legal requirements. All Mercedes-Benz GenuineParts meet the approval requirements. The use of non-approved parts may invalidate the vehicle's general operating permit.

This is the case in the following situations:

- the vehicle type is different from that for which the vehicle's general operating permit was granted.
- other road users could be endangered.
- the exhaust gas or noise level gets worse.

Always specify the vehicle identification number (VIN) (→ page 562) when ordering Mercedes-Benz GenuineParts.

Owner's Manual

This Owner's Manual describes all models and all standard and optional equipment available for your vehicle at the time of this Owner's Manual going to press. Country-specific differences are possible. Note that your vehicle may not be fitted with all features described. This is also the case for systems and functions relevant to safety. Therefore, the equipment on your vehicle may differ from that in the descriptions and illustrations.

The original purchase agreement for your vehicle contains a list of all of the systems in your vehicle.

Should you have any questions concerning equipment and operation, please consult a Mercedes-Benz Service Centre.

The Owner's Manual and Service Booklet are important documents and should be kept in the vehicle.

Touch-sensitive controls

In addition to conventional switches and buttons, your vehicle is equipped with touch-sensitive controls.

These are located in the following areas of your vehicle:

- Roof and door control panel
- Climate control
- Steering wheel
- MBUX multimedia system

The controls have touch-sensitive surfaces. The surfaces are controlled by pressing or swiping to adjust settings or trigger functions, for example.

In the area of the touchscreen, you also receive haptic feedback in the form of a pulse, vibration or the surface structure changing on the touch-sensitive surface, for example.

You receive haptic feedback in the following situations, for example:

- When pressing a button on the user interface
- When scrolling in a list or table

- When reaching a new area on the user interface, e.g. a pop-up window

When handling touch-sensitive surfaces, observe the following points to avoid problems operating:

- Do not affix stickers or similar objects on the surfaces.
- Keep the surfaces protected from moisture and wet conditions.
- Keep the surfaces free of dust and dirt.

Operating safety

⚠ WARNING Risk of injury due to malfunctions or system failure

In order to avoid malfunctions or system failures:

- ▶ Always have the specified service/maintenance work as well as any necessary repairs carried out at a qualified specialist workshop.

⚠ WARNING Risk of accident or injury due to improper modifications to electronic components

Modifications to electronic components, their software or wiring can impair their functionality and/or the functionality of other networked components or safety-relevant systems.

This can endanger the vehicle's operating safety.

- ▶ You must not tamper with wiring, electronic components, or their software.
- ▶ Always have work on electrical and electronic devices carried out at a qualified specialist workshop.

If you modify the on-board electronics, the general operating permit is rendered invalid.

Observe the "On-board electronics" section in "Technical data".

⚠ WARNING Risk of fire due to flammable materials on hot parts of the exhaust system

Flammable materials can ignite on hot parts of the exhaust system.

- ▶ When driving on unpaved roads or off-road, regularly check the vehicle underside.
- ▶ Remove trapped plants or other flammable material, in particular.
- ▶ If there is damage, consult a qualified specialist workshop immediately.

! NOTE Damage to the vehicle

In the following situations, in particular, there is a risk of damage to the vehicle:

- the vehicle becomes grounded, e.g. on a high kerb or an unpaved road
- the vehicle is driven too fast over an obstacle, e.g. a kerb, speed bump or pot-hole

- a heavy object strikes the underbody or chassis components

In situations such as this, the body, the underbody, chassis components, wheels or tyres could be damaged without the damage being visible. Components damaged in this way can unexpectedly fail or, in the case of an accident, may not absorb the loads that arise as intended.

If the underbody panelling is damaged, flammable materials such as leaves, grass or twigs can collect between the underbody and the underbody panelling. These materials may ignite if they come into contact with hot parts on the exhaust system.

- ▶ Have the vehicle checked and repaired immediately at a qualified specialist workshop.

or

- ▶ If driving safety is impaired while continuing your journey, pull over and stop the vehicle immediately in accordance

with the traffic conditions, and contact a qualified specialist workshop.

Vehicles with a 48 V on-board electrical system (EQ Boost technology)

⚠ DANGER Risk of fatal injury by touching damaged high-voltage components

Vehicles with a 48 V on-board electrical system contain individual high-voltage components. These high-voltage components are under high voltage.

If you modify component parts of these high-voltage components or touch damaged component parts, you may be electrocuted.

High voltage components may be damaged in an accident, although the damage may not be visible.

- ▶ Never perform modifications to component parts of high-voltage components.
- ▶ Never touch damaged component parts of high-voltage components.

▶ Never touch component parts of high-voltage components after an accident.

Vehicles with a 48 V on-board electrical system contain high voltage components. These components are marked with a high voltage label:



All work on high voltage components must be carried out at a qualified specialist workshop.

Declaration of Conformity

Electromagnetic compatibility

The electromagnetic compatibility of the vehicle components has been checked and certified

according to the currently valid version of Regulation UN R10.

Wireless vehicle components

For EU and EFTA countries only:

The following information applies to all wireless components of the vehicle and of the information systems and communication devices integrated into the vehicle:

The wireless components of this vehicle comply with the basic requirements and all other relevant conditions of Directive 2014/53/EU. You can obtain further information from a Mercedes-Benz Service Centre.

Below are the addresses of the manufacturers of wireless components. The addresses cannot be displayed on the equipment due to its size or type.

Brazil only:

Note on the two-way radio systems in the vehicle:

These systems are not protected from harmful interference and must not cause interference in duly approved systems.

Nigeria only:

Connection and use of the wireless communication equipment in this vehicle are permitted by the Nigerian Communications Commission.

Thailand only:

The telecommunication equipment in this vehicle meets the requirements of the National Broadcasting and Telecommunications Commission (NBTC).

Ukraine only:

The manufacturer hereby declares that the wireless vehicle components meet the technical regulations for two-way radios. You can obtain further information from a Mercedes-Benz Service Centre.

Tyre pressure monitoring sensors

Schrader Electronics Ltd, 11 Technology Park, Belfast Road, Antrim BT41 1QS, Northern Ireland

Remote locking system

Marquardt GmbH, Schloßstrasse 16, 78604 Rie-theim, Germany

Huf Hülsbeck & Fürst GmbH & Co. KG, Steeger Strasse 17, 42551 Velbert, Germany

Hella KGaA Hueck & Co., Rixbecker Strasse 75, 59552 Lippstadt, Germany

Remote locking system control unit

Marquardt GmbH, Schloßstrasse 16, 78604 Rie-theim, Germany

Leopold Kostal GmbH & Co. KG, Hauert 11, 44227 Dortmund, Germany

Continental Automotive GmbH, Siemensstrasse 12, 93055 Regensburg, Germany

Antenna modules

Hirschmann Car Communication GmbH, Stuttgarter Strasse 45-51, 72654 Neckartenzlingen, Germany

Kathrein Automotive GmbH & Co. KG, Römer-ring 1, 31137 Hildesheim, Germany

Door handles with near-field communication function

Huf Hülsbeck & Fürst GmbH & Co. KG, Steeger Strasse 17, 42551 Velbert, Germany

Garage door openers

GenteX Corporation, 600 North Centennial Street, Zeeland MI 49464, USA

Sensor for interior monitoring

META Systems, Via Galimberti 9, 42124 Reggio Emilia, Italy

Radar sensors

Autoliv Electronics ASP Inc., 26545 American Drive, Southfield, MI 48034, USA

ADC Automotive Distance Control Systems GmbH, Peter-Dornier-Strasse 10, 88131 Lindau, Germany

Robert Bosch GmbH, Daimlerstrasse 6, 71229 Leonberg, Germany

Mobile communication and telematics

Harman Becker Automotive Systems GmbH, Postfach 2260, 76303 Karlsbad, Germany

Panasonic Automotive & Industrial Systems Europe GmbH, Robert-Bosch-Strasse 27-29, 63225 Langen, Germany

Mitsubishi Electric Corporation, 2-3-33 Miwa, Sanda-City, 669-1513 Hyogo, Japan

Wireless headphones

Harman Becker Automotive Systems GmbH, Postfach 2260, 76303 Karlsbad, Germany

Remote control

Ruwido Austria GmbH, Köstendorfer Strasse 8, 5202 Neumarkt, Austria

Valeo, 43 rue Bayen, 75017 Paris, France

Heater booster function remote control

Digades GmbH, Äußere Weberstrasse 20, 02763 Zittau, Germany

Wireless applications in the vehicle

Besides the typical frequencies for mobile communications, Mercedes-Benz vehicles use the following wireless applications.

Wireless applications in the vehicle

Technology	Frequency range	Transmission output/magnetic field strength
Remote locking system	20 kHz (9–90 kHz)	≤ 72 dBμA/m at 10 m
Wireless power transfer	105 kHz (90–119 kHz)	≤ 42 dBμA/m at 10 m
Remote locking system Wireless power transfer	125 kHz (119–135 kHz)	≤ 42 dBμA/m at 10 m
Near-field communication	13.553–13.567 MHz	≤ 42 dBμA/m at 10 m
Remote locking system, garage door opener, tyre pressure monitor	433 MHz (433.05–434.79 MHz)	≤ 10 mW e.r.p.

Technology	Frequency range	Transmission output/magnetic field strength
Heater booster function remote control, garage door opener	868 MHz (868.0–868.6 MHz)	≤ 25 mW e.r.p.
Heater booster function remote control, garage door opener	869 MHz (868.7–869.2 MHz)	≤ 25 mW e.r.p.
Bluetooth®, Kleer, RLAN, remote controls, wireless headphones	2.4 GHz ISM band (2400–2483.5 MHz)	≤ 100 mW e.i.r.p.
Sensor for interior monitoring, RLAN	5.8 GHz UNII-3 (5725–5875 MHz)	≤ 25 mW e.i.r.p.
Remote locking system	7.25 GHz UWB (6.0–8.5 GHz)	≤ -41.3 dBm/MHz e.i.r.p mean ≤ 0 dBm/MHz e.i.r.p. peak
24 GHz ISM radar	24.05–24.25 GHz*	≤ 100 mW e.i.r.p.
24 GHz UWB radar	24.25–26.65 GHz*	≤ -41.3 dBm/MHz e.i.r.p mean ≤ 0 dBm/50 MHz e.i.r.p. peak
76 GHz radar	76–77 GHz	≤ 55 dBm peak e.i.r.p.

Technology	Frequency range	Transmission output/magnetic field strength
	* Model series launched on the market before April 2016.	
Carsharing module	NFC: 13.553–13.567 MHz Bluetooth: 2402–2480 MHz	NFC: $\leq 42 \text{ dB}\mu\text{A/m}$ at 10 m Bluetooth: $\leq +4 \text{ dBm}$ (power category 2)

Jack

Copy and translation of the original declaration of conformity:

EC declaration of conformity

1.

The signatory, as a representative

Manufacturer:

BRANO a.s.

74741 Hradec nad Moravicí, Opavská 1000,

Czech Republic

ID No.: 64-387-5933

VAT Reg. No.: CZ64-387-5933

declares, as our sole responsibility, that the product:

2. a)

Designation:

Jack

Type, number:

A) A 164 580 02 18, A 166 580 01 18

B) A 240 580 00 18

C) A 639 580 02 18

Year of manufacture: 2015

Fulfils all relevant conditions

Directive No. 2006/42/EC

b)

Description and purpose of use:

The jack is only intended for raising the specified vehicle in accordance with the operating instructions affixed to the jack.

3.

Reference data of the harmonised standards or specifications

A) ISO 4063, EN ISO 14341-A, DBL 7382.20,
MBN 10435, AS 2693

B) ISO 4063, ISO 14341-A, DBL 7392.10, MBN
10435

C) DBL 7392.10, DBL 8230.10

The technical documentation of the product is
stored at the manufacturer's plant. Representa-
tive for the compilation of the technical docu-
mentation: Director of the Technical Department
Brano a.s.

4.

Hradec nad Moravicí

City

5.

05.05.2015

Date

Signed by

Director of Quality

TIREFIT kit

Copy and translation of the original declaration
of conformity:

EC declaration of conformity

In accordance with EC Directive 2006/42/EC

We hereby declare that the product

Product designation: Daimler electric air pump

Model designation: 0851ve, DT/UW 200046

MB part no.: A 000 583 8200

complies with the following relevant regulations:

2004/108/EC

Applied harmonised standards, in particular:

DIN EN 55014-1

DIN EN 55014-2:2009-06

Manufacturer: Dunlop Tech GmbH

Address: Birkenhainerstrasse 77, 63450 Hanau

Authorised representative: IMS dept.

Date: June 2015

Signature: IMS-AM, IMS-AE-L

Diagnostics connection

The diagnostics connection is only intended for
the connection of diagnostic devices at a quali-
fied specialist workshop.

⚠ WARNING Risk of accident due to con-
necting devices to the diagnostics con-
nection

If you connect devices to the diagnostics
connection of the vehicle, the function of
vehicle systems and operating safety may be
impaired.

▶ Only connect the vehicle diagnostics
connection to devices which have been
tested with regard to their suitability
and are considered safe.

⚠ WARNING Risk of accident due to
objects in the driver's footwell

Objects in the driver's footwell may impede
pedal travel or block a depressed pedal.
This jeopardises the operating and road
safety of the vehicle.

- ▶ Stow all objects in the vehicle securely so that they cannot get into the driver's footwell.
- ▶ Always fit the floor mats securely and as prescribed in order to ensure that there is always sufficient room for the pedals.
- ▶ Do not use loose floor mats and do not place floor mats on top of one another.

! **NOTE** Battery discharging from using devices connected to the diagnostics connection

Using devices at the diagnostics connection drains the battery.

- ▶ Check the charge level of the battery.
- ▶ If the charge level is low, charge the battery, e.g. by driving a considerable distance.

Connecting equipment to the diagnostics connection can lead to emissions monitoring information being reset, for example. This may lead

to the vehicle failing to meet the requirements of the next emissions inspection during the main inspection.

Qualified specialist workshop

A qualified specialist workshop has the necessary special skills, tools and qualifications to correctly carry out any necessary work on your vehicle. This particularly applies to safety-relevant works.

Always have the following work carried out on your vehicle at a qualified specialist workshop:

- safety-relevant works
- service and maintenance work
- repair work
- modifications as well as installations and conversions
- work on electronic components

Mercedes-Benz recommends a Mercedes-Benz service centre.

Vehicle registration

Mercedes-Benz may ask its service centres to carry out technical inspections on certain vehicles. The quality or safety of the vehicle is improved as a result of the inspection.

Mercedes-Benz can only inform you about vehicle checks if Mercedes-Benz has your registration data.

It is possible that your vehicle has not yet been registered in your name in the following cases:

- if your vehicle was not purchased at an authorised specialist dealer.
- if your vehicle has not yet been examined at a Mercedes-Benz service centre.

It is advisable to register your vehicle with a Mercedes-Benz service centre.

Inform Mercedes-Benz as soon as possible about any change in address or vehicle ownership. You can do this at a Mercedes-Benz service centre, for example.

Correct use of the vehicle

If you remove any warning stickers, you or others could fail to recognise certain dangers. Leave warning stickers in position.

Observe the following information in particular when driving your vehicle:

- the safety notes in this manual
- technical data for the vehicle
- traffic rules and regulations
- laws and safety standards pertaining to motor vehicles

Information on the REACH regulation

EU and EFTA countries only:

The REACH regulation (Regulation (EC) No. 1907/2006, Article 33) stipulates a duty to supply information about substances of very high concern (SVHCs).

Mercedes-Benz AG acts to the best of its knowledge to prevent these SVHCs from being used and to enable customers to safely handle these substances. There are SVHCs known to

Mercedes-Benz AG, according to supplier information and internal product information, found in individual components of this vehicle in quantities of over 0.1 percent by weight.

Further information can be obtained at the following addresses:

- <https://reach.daimler.com/de/home/>
- <https://reach.daimler.com/en/home/>

Notes for persons with electronic medical aids

Mercedes-Benz AG cannot, despite carefully developing vehicle systems, completely rule out the interaction of vehicle systems with electronic medical aids such as cardiac pacemakers.

For this reason, the following can occur in isolated cases, depending on the aids used:

- aids malfunctioning
- adverse health effects

Observe the notes and warnings of the manufacturer of the aids; if in doubt, contact the device manufacturer and your doctor. Mercedes-

Benz AG recommends using only few electrical vehicle systems if there is continuing uncertainty concerning the possibility of aids malfunctioning.

Have repairs and maintenance work in the area of vehicle components carrying live voltage and transmission aerials carried out by a qualified specialist workshop.

Implied warranty

! **NOTE** Damage to the vehicle arising from violation of these operating instructions.

Damage to the vehicle can arise from violation of these operating instructions.

This damage is not covered either by the Mercedes-Benz implied warranty or by the New- or Used-Vehicle Warranty.

▶ Follow the instructions in these operating instructions on proper operation of your vehicle as well as on possible vehicle damage.

QR code for rescue card

The QR code is secured in the fuel filler flap and on the opposite side on the B-pillar. In the event of an accident, rescue services can use the QR code to quickly find the appropriate rescue card for your vehicle. The current rescue card contains the most important information about your vehicle in a compact form, e.g. the routing of the electric lines.

Further information can be obtained at <https://www.mercedes-benz.de/qr-code>.

Data storage

Electronic control units

Electronic control units are fitted in your vehicle. Some of these are necessary for the safe operation of your vehicle, while some assist you when driving (driver assistance systems). In addition, your vehicle provides comfort and entertainment functions, which are also made possible by electronic control units.

Electronic control units contain data memories which can temporarily or permanently store

technical information about the vehicle's operating state, component loads, maintenance requirements and technical events or faults.

In general, this information documents the state of a component part, a module, a system or the surroundings such as:

- operating status of system components (e.g. fill levels, battery status, tyre pressure)
- status messages concerning the vehicle or its individual components (e.g. number of wheel revolutions/speed, longitudinal acceleration, lateral acceleration, display of fastened seat belts)
- malfunctions or faults in important system components (e.g. lights, brakes)
- information on events leading to vehicle damage
- system reactions in special driving situations (e.g. airbag deployment, intervention of stability control systems)
- ambient conditions (e.g. temperature, rain sensor)

In addition to providing the actual control unit function, this data assists the manufacturer in detecting and rectifying faults and optimising vehicle functions. The majority of this data is temporary and is only processed in the vehicle itself. Only a small portion of the data is stored in the event or fault memory.

When your vehicle is serviced, technical data from the vehicle can be read out by service network employees (e.g. workshops, manufacturers) or third parties (e.g. breakdown services). Services include, for example, repair services, maintenance processes, warranty claims and quality assurance measures. The read out is performed via the legally prescribed port for the diagnostics connection in the vehicle. The respective service network locations or third parties collect, process and use the data. They document technical statuses of the vehicle, assist in finding faults and improving quality and are transmitted to the manufacturer, if necessary. Furthermore, the manufacturer is subject to product liability. For this, the manufacturer requires technical data from vehicles.

Fault memories in the vehicle can be reset by a service outlet as part of repair or maintenance work.

Depending on the selected equipment, you can import data into vehicle convenience and infotainment functions yourself.

This includes, for example:

- multimedia data such as music, films or photos for playback in an integrated multimedia system
- address book data for use in connection with an integrated hands-free system or an integrated navigation system
- entered navigation destinations
- data about the use of internet services

This data can be saved locally in the vehicle or it is located on a device which you have connected to the vehicle (e.g. a smartphone, USB flash drive or MP3 player). If this data is stored in the vehicle, you can delete it at any time. This data is sent to third parties only at your request, particularly when you use online services in accordance with the settings that you have selected.

You can store or change convenience settings/individualisations in the vehicle at any time.

Depending on the equipment, this includes, for example:

- settings for the seat and steering wheel positions
- suspension and climate control settings
- customisations such as interior lighting

If your vehicle is accordingly equipped, you can connect your smartphone or another mobile end device to the vehicle. You can control this by means of the control elements integrated in the vehicle. Images and audio from the smartphone can be output via the multimedia system. Certain information is simultaneously transferred to your smartphone.

Depending on the type of integration, this can include:

- general vehicle data
- position data

This allows you to use selected apps on your smartphone, such as navigation or music play-

back. There is no further interaction between the smartphone and the vehicle; in particular, vehicle data is not directly accessible. Which type of further data processing occurs is determined by the provider of the specific app used. Which settings you can make, if any, depends on the specific app and the operating system of your smartphone.

Online services

Wireless network connection

If your vehicle has a wireless network connection, it enables data to be exchanged between your vehicle and additional systems. The wireless network connection is enabled via the vehicle's transmission and reception unit or via connected mobile end devices (e.g. smartphones). Online functions can be used via the wireless network connection. This includes online services and applications/apps provided by the manufacturer or other providers.

Manufacturer's services

Regarding online services of the manufacturer, the individual functions are described by the

manufacturer in a suitable place (e.g. Owner's Manual, website of the manufacturer) along with the relevant data protection information. Personal data may be used for the provision of online services. Data is exchanged via a secure connection, e.g. the manufacturer's designated IT systems. Personal data is collected, processed and used via the provision of services exclusively on the basis of legal permissions or with prior consent.

The services and functions (sometimes subject to a fee) can usually be activated or deactivated. In some cases, this also applies to the entire vehicle's data connection. This excludes, in particular, legally prescribed functions and services.

Third party services

If it is possible to use online services from other providers, these services are the responsibility of the provider in question and subject to that provider's data protection conditions and terms of use. The manufacturer has no influence on the content exchanged.

For this reason, please ask the service provider for information about the type, extent and pur-

pose of the collection and use of personal data when services are provided by third parties.

Copyright

Information on licences for free and open-source software used in your vehicle can be found on the data carrier in your vehicle document wallet and with updates on the following website:

<https://www.mercedes-benz.com/opensource>

Restraint system

Protection provided by the restraint system

The restraint system includes the following components:

- Seat belt system
- Airbags
- Child restraint system
- Child seat securing systems

The restraint system can help prevent the vehicle occupants from coming into contact with parts of the vehicle interior in the event of an accident. In the event of an accident, the restraint system can also reduce the forces to which the vehicle occupants are subjected.

A seat belt can only provide the best level of protection if it is worn correctly. Depending on the detected accident situation, seat belt tensioners and/or airbags supplement the protection offered by a correctly worn seat belt. Seat belt tensioners and/or airbags are not deployed in every accident.

In order for the restraint system to provide the intended level of protection, each vehicle occupant must observe the following information:

- Fasten seat belts correctly.
- Sit in an almost upright seat position with their back against the seat backrest.
- Sit with their feet resting on the floor, if possible.
- Always secure persons under 1.50 m tall in an additional restraint system suitable for Mercedes-Benz vehicles.

However, no system available today can completely eliminate injuries and fatalities in every accident situation. In particular, the seat belt and airbag generally do not protect against objects penetrating the vehicle from the outside. It is also not possible to completely rule out the risk of injury caused by the airbag deploying.

Reduced restraint system protection

⚠ WARNING Risk of injury or death due to modifications to the restraint system

Vehicle occupants may no longer be protected as intended if alterations are made to the restraint system.

- ▶ Never alter the parts of the restraint system.
- ▶ Never tamper with the wiring or any electronic component parts or their software.

If it is necessary to modify the vehicle to accommodate a person with disabilities, contact a qualified specialist workshop.

Mercedes-Benz recommends that you use driving aids which have been approved for your vehicle by Mercedes-Benz.



Restraint system functionality

When the ignition is switched on, a self-test is performed, during which the  restraint sys-

tem warning lamp lights up. It goes out no later than a few seconds after the vehicle is started. The components of the restraint system are then functional.

Malfunctioning restraint system

A malfunction has occurred in the restraint system if:

- the  restraint system warning lamp does not light up when the ignition is switched on
- the  restraint system warning lamp lights up continuously or repeatedly during a journey

⚠ WARNING Risk of injury due to malfunctions in the restraint system

Components in the restraint system may be activated unintentionally or not deploy as intended in an accident.

- ▶ Have the restraint system checked and repaired immediately at a qualified specialist workshop.

Function of the restraint system in an accident

How the restraint system works is determined by the severity of the impact detected and the type of accident anticipated:

- Frontal impact
- Rear impact
- Side impact
- Rollover

The activation thresholds for the components of the restraint system are determined based on the evaluation of the sensor values measured at various points in the vehicle. This process is preemptive in nature. The triggering/deployment of the components of the restraint system must take place in good time at the start of the collision.

Factors which can only be seen and measured after a collision has occurred do not play a decisive role in the deployment of an airbag. Nor do they provide an indication of airbag deployment.

The vehicle may be deformed significantly without an airbag being deployed. This is the case if

only parts which are relatively easily deformed are affected and the rate of vehicle deceleration is not high. Conversely, an airbag may be deployed even though the vehicle suffers only minor deformation. If very rigid vehicle parts such as longitudinal members are hit, for example, this may result in sufficiently high levels of vehicle deceleration.

Depending on the detected deployment situation, the components of the restraint system can be activated or deployed independently of each other:

- Seat belt tensioner: frontal impact, rear impact, side impact, rollover
- Driver's airbag, front passenger airbag: frontal impact
- Knee airbag: frontal impact
- Side airbag: side impact
- Centre airbag: side impact, rollover
- Window airbag: side impact, rollover, frontal impact
- Belt airbag: frontal impact
- PRE-SAFE® Impulse Side: side impact

The front passenger airbag can only be deployed in an accident if the PASSENGER AIR BAG OFF indicator lamp is off. If the front passenger seat is occupied, make sure, both before and during the journey, that the status of the front passenger airbag is correct (→ page 47).

⚠ WARNING Risk of burns from hot airbag components

The airbag parts are hot after an airbag has been deployed.

- ▶ Do not touch the airbag parts.
- ▶ Have a deployed airbag replaced at a qualified specialist workshop as soon as possible.

Mercedes-Benz recommends that you have the vehicle towed to a qualified specialist workshop after an accident. Take this into account, particularly if a seat belt tensioner is triggered or an airbag deployed.

If the seat belt tensioners are triggered or an airbag is deployed, you will hear a bang, and a small amount of powder may also be released:

- The bang will not generally affect your hearing.
- In general, the powder released is not hazardous to health but may cause short-term breathing difficulties to persons suffering from asthma or other pulmonary conditions.

Provided it is safe to do so, leave the vehicle immediately or open the window in order to prevent breathing difficulties.

Seat belts

Protection provided by the seat belt

Always fasten your seat belt correctly before starting a journey. A seat belt can only provide the best level of protection if it is worn correctly.

⚠ WARNING Risk of injury or death due to incorrectly fastened seat belt

If the seat belt is not worn correctly, it cannot perform its intended protective function. In addition, an incorrectly fastened seat belt can also cause injuries, for example, in the event of an accident or when braking or changing direction suddenly.

- ▶ Always ensure that all vehicle occupants have their seat belts fastened correctly and are sitting properly.

Always observe the instructions about the correct driver's seat position and adjusting the seat (→ page 96).

In order for the correctly worn seat belt to provide the intended level of protection, each vehicle occupant must observe the following information:

- The seat belt must not be twisted and must fit tightly and snugly across the body.

- The seat belt must be routed across the centre of the shoulder and as low down across the hips as possible.
- The shoulder section of the seat belt should not touch your neck nor be routed under your arm or behind your back.
- Avoid wearing bulky clothing, e.g. a winter coat.
- Push the lap belt down as far as possible across your hips and pull tight with the shoulder section of the belt. Never route the lap belt across your abdomen.

Pregnant women must also take particular care with this.

- Never route the seat belt across sharp, pointed, abrasive or fragile objects.
- Only one person should use each seat belt at any one time. Never allow babies and children to travel sitting on the lap of another vehicle occupant.
- Never secure objects with a seat belt if the seat belt is also being used by one of the vehicle's occupants. Always observe the instructions for loading the vehicle when

securing objects, luggage or loads (→ page 119).

Also ensure that no objects, e.g. a cushion, are ever placed between a person and the seat.

If children are travelling in the vehicle, be sure to observe the instructions and safety notes on "Children in the vehicle" (→ page 52).

Limitations of the protection provided by the seat belt

⚠ WARNING Risk of injury or death due to an incorrect seat position

The seat belt does not offer the intended level of protection if you have not moved the seat backrest to an almost vertical position. You could slip beneath the seat belt and injure yourself.

- ▶ Adjust the seat properly before commencing your journey.
- ▶ Always ensure that the seat backrest is in an almost vertical position and that

the shoulder belt is routed across the centre of your shoulder.

⚠ WARNING Risk of injury or death when additional restraint systems are not used for persons with a smaller stature

Persons under 1.50 m tall cannot wear the seat belt correctly without a suitable additional restraint system.

- ▶ Always secure persons under 1.50 m tall in a suitable restraint system.

⚠ WARNING Risk of injury or death due to blocked seat belt buckle or seat belt anchorage

Objects next to the front seat that block the seat belt buckle or the moving seat belt anchorage on the front seat impair the function of the seat belt tensioners.

- ▶ Before starting the journey, make sure that there are no objects around the seat belt buckle or between the front seat and door.

⚠ WARNING Risk of injury or death due to damaged or modified seat belts

Seat belts cannot provide protection in the following situations:

- the seat belt is damaged, has been modified, is extremely dirty, bleached or dyed
- the seat belt buckle is damaged or extremely dirty
- modifications have been made to the seat belt tensioner, seat belt anchorage or seat belt retractor

Seat belts may sustain non-visible damage in an accident, e.g. due to glass splinters.

Modified or damaged seat belts could tear or fail in the event of an accident, for example.

Modified belt tensioners may be deployed unintentionally or not function as intended.

- ▶ Never modify the seat belts, seat belt tensioners, seat belt anchorages or seat belt retractors.

- ▶ Make sure that the seat belts are not damaged, are not worn and are clean.
- ▶ Always have the seat belts checked immediately after an accident at a qualified specialist workshop.

Mercedes-Benz recommends that you use seat belts which have been approved for your vehicle by Mercedes-Benz.

⚠ WARNING Risk of injury or death from deployed pyrotechnic seat belt tensioners

Pyrotechnic seat belt tensioners that have been deployed are no longer operational and are unable to perform their intended protective function.

- ▶ Therefore, have deployed pyrotechnic seat belt tensioners immediately replaced at a qualified specialist workshop.

Mercedes-Benz recommends that you have the vehicle towed to a qualified specialist workshop after an accident.

! NOTE Damage caused by trapping the seat belt

If an unused seat belt is not fully retracted, it may become trapped in the door or in the seat mechanism.

- ▶ Always ensure that an unused seat belt is fully retracted.

Information on the belt airbag in the rear seat belt

The BELTBAG identification indicates that a rear seat belt is equipped with a belt airbag.

When activated, the belt airbag increases the protected area of the vehicle occupant's ribcage.

⚠ WARNING Risk of injury or death due to use of a non-approved child restraint system

In an accident, the belt airbag may damage a non-approved child restraint system or a child restraint system which has not been approved for use in conjunction with the belt airbag.

As a result, the child restraint system may not be able to provide the intended level of protection.

For safety reasons, Mercedes-Benz recommends that you only use a child restraint system which has been tested and approved by Mercedes-Benz in combination with a belt airbag.

Information on child restraint systems (→ page 55).

Extending/retracting the seat belt extender in the rear

The seat belt extender for the rear seat helps you fasten your seat belt.

- ▶ Close the door.
The seat belt extender extends.

The seat belt extender retracts again in the following cases:

- the seat belt tongue is engaged in the seat belt buckle
- the seat belt tongue is not engaged in the seat belt buckle within a certain time
- the respective door is opened
- a certain speed is exceeded after pulling away

The seat belt extender must always be retracted while the vehicle is in motion.

- ⓘ You can deactivate the seat belt extender. Activate the child safety lock for the rear side windows (→ page 65).

When fitting a child restraint system to the rear seat, observe the vehicle-specific information (→ page 57).

Fastening and adjusting seat belts

If the seat belt is pulled quickly or sharply, the seat belt retractor locks. The seat belt strap cannot be pulled out any further.

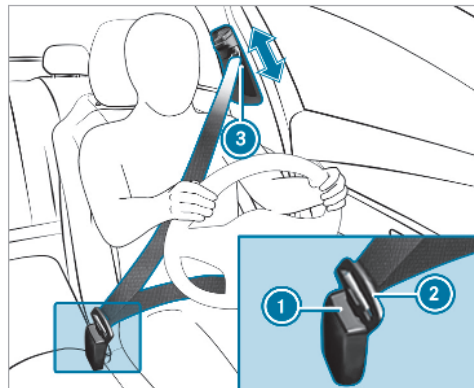

- ▶ Always engage seat belt tongue ② of the seat belt into seat belt buckle ① of the corresponding seat.
- ▶ Press and hold the seat belt outlet release and slide seat belt outlet ③ into the desired position.
- ▶ Let go of the seat belt outlet release and ensure that seat belt outlet ③ locks into position.

! **NOTE** Deployment of the seat belt tensioner and side impact airbag when the front passenger seat is unoccupied

If the seat belt tongue is engaged in the seat belt buckle of the unoccupied front passenger seat, the seat belt tensioner and the side impact airbag may also deploy in the event of an accident along with other systems.

- ▶ Only one person should use each seat belt at any one time.

Seat belt adjustment function

Vehicles with PRE-SAFE®: if the front seat belt is not pulled tightly across your body, the seat belt adjustment may automatically apply a certain tightening force. Do not hold the seat belt tightly while it is adjusting.

You can activate and deactivate the seat belt adjustment function using the multimedia system (→ page 41).

Releasing a seat belt

- ▶ Press the release button in the seat belt buckle and guide the seat belt back with the seat belt tongue.

Activating/deactivating seat belt adjustment via the multimedia system

Multimedia system:

- ▶  ▶ Settings ▶ Vehicle
- ▶ ▶ Occupant protection
- ▶ Activate or deactivate **Belt adjustment**.

Seat belt warning function for the driver and front passenger

The  seat belt warning lamp in the instrument display is a reminder that all vehicle occupants must wear their seat belts correctly.

In addition, a warning tone may sound.

As soon as the driver and front passenger fasten their seat belts, the seat belt warning goes out.

Function of the rear seat belt status display

The rear seat belt status display is only available for certain countries.



When the ignition is switched on, the rear seat belt status display informs you for a certain amount of time which rear seat belt is not fastened.

The status of the rear seat belt can be recognised by the colour of the seat symbol in the instrument cluster:

- Grey: rear seat belt not fastened.
- Green: the seat belt tongue of the rear seat belt is engaged in the seat belt buckle of the corresponding seat.

Every vehicle occupant must always fasten their seat belt correctly before starting a journey.

- Red: a vehicle occupant in the rear has pressed the release button on the seat belt buckle and unfastened the rear seat belt.

If a vehicle occupant unfastens a seat belt in the rear, the rear seat belt status display appears again.

In addition, a warning tone may sound.

Airbags

Overview of airbags

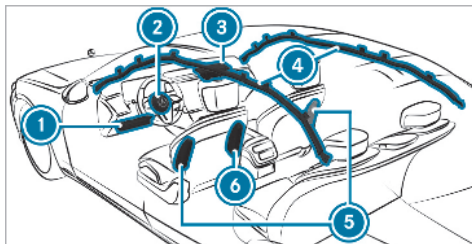

Driver's/front passenger seat

- ① Knee airbag
- ② Driver's airbag
- ③ Front passenger airbag
- ④ Window airbag
- ⑤ Side airbag
- ⑥ Centre airbag¹

¹)Only for certain countries.

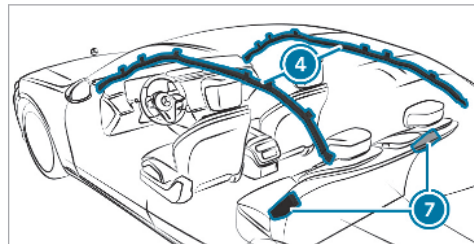

Rear seats

- ④ Window airbag
- ⑦ Side airbag

The installation location of an airbag is identified by the AIRBAG symbol.

When enabled, an airbag can provide additional protection for the respective vehicle occupant.

Potential protection from each airbag:

- Kneebag: thigh, knee and lower leg
- Driver's airbag, front passenger airbag: head and ribcage
- Sidebag: ribcage, also pelvis for front seat occupants

- Centre airbag: head and ribcage
- Windowbag: head

Information on child restraint systems on the front passenger seat

⚠ WARNING Risk of injury or fatal injuries if the front passenger airbag is enabled

If the front passenger front airbag is enabled, a child on the front passenger seat may be struck by the front passenger airbag during an accident.

NEVER use a rearward-facing child restraint system on a seat with an ENABLED FRONT AIRBAG, DEATH or SERIOUS INJURY to the CHILD can occur.

When fitting a child restraint system to the front passenger seat, observe the vehicle-specific information . Also, always observe the notes on rearward-facing or forward-facing child restraint systems on the front passenger seat.

Information on automatic front passenger airbag shutoff

The front passenger airbag can only be deployed in an accident if the PASSENGER AIR BAG OFF indicator lamp is off. If the front passenger seat is occupied, make sure, both before and during the journey, that the status of the front passenger airbag is correct (→ page 47).

! NOTE Important points to remember if the front passenger seat is unoccupied

In an accident, the components of the restraint system may deploy unnecessarily on the front passenger side if:

- There are heavy objects on the front passenger seat.
- The seat belt tongue is engaged in the seat belt buckle of the front passenger seat and the front passenger seat is unoccupied.

- ▶ Stow objects in a suitable place.
- ▶ Only one person should use each seat belt at any one time.

Depending on the detected accident situation, the window airbag on the front passenger side may deploy. The airbag is deployed regardless of whether the front passenger seat is occupied.

Protection provided by the airbags

Depending on the accident situation, an airbag may supplement the protection provided by a correctly fastened seat belt.

⚠ WARNING Risk of injury or death due to an incorrect seat position

If you deviate from the correct seat position, the airbag cannot perform its intended protective function.

Each vehicle occupant must make sure of the following:

- Fasten seat belts correctly. Pregnant women must take particular care to ensure that the lap belt never lies across the abdomen.

- Adopt the correct seat position and keep as far away as possible from the airbags.
 - Observe the following information.
- ▶ Always make sure that there are no objects between the airbag and vehicle occupant.

To avoid the risks resulting from the deployment of an airbag, each vehicle occupant must observe the following information in particular:

- Before starting your journey, adjust your seat correctly; the driver's seat and front passenger seat should be moved as far back as possible.

When doing so, always observe the information on the correct driver's seat position (→ page 96).

- Only hold the steering wheel by the steering wheel rim. This allows the airbag to be fully deployed.
- Always lean against the seat backrest when the vehicle is in motion. Do not lean forwards or against the door or side window. You may

otherwise be in the deployment area of the airbags.

- Always keep your feet on the floor. Do not put your feet on the cockpit, for example. Your feet may otherwise be in the deployment area of the airbag.
- If children are travelling in the vehicle, observe the additional notes (→ page 52).
- Always stow and secure objects correctly.

Objects in the vehicle interior may prevent an airbag from functioning correctly. Each vehicle occupant must always make sure of the following in particular:

- There are no people, animals or objects between the vehicle occupants and an airbag.
- There are no objects between the seat, door and door pillar (B-pillar).
- There are no hard objects, e.g. coat hangers, hanging on the grab handles or coat hooks.
- There are no accessory parts, such as mobile navigation devices, mobile phones or cup holders, attached to the vehicle within the

deployment area of an airbag, e.g. on the cockpit, on the door, on the side window or on the side wall trim.

In addition, no connecting cables, tensioning straps or retaining straps must be routed or attached to the vehicle within the deployment area of an airbag. Always comply with the accessory manufacturer's installation instructions and, in particular, the notes on suitable places for installation.

- There are no heavy, sharp-edged or fragile objects in the pockets of your clothing. Store such objects in a suitable place.

Limited protection provided by airbags

⚠ WARNING Risk of injury due to modifications to the cover of an airbag

If you modify the cover of an airbag or affix objects such as stickers to it, the airbag may no longer function correctly.

- ▶ Never modify the cover of an airbag and do not affix objects to it.

The installation location of an airbag is identified by the AIRBAG symbol (→ page 42).

⚠ WARNING Risk of injury or death due to the use of unsuitable seat covers

Due to unsuitable seat covers, the airbags cannot protect vehicle occupants as intended.

In addition, the operation of the automatic front passenger airbag shutoff could be restricted.

- ▶ You should only use seat covers that have been approved for the corresponding seats by Mercedes-Benz.

⚠ WARNING Risk of injury due to malfunctioning sensors in the door

The function of the airbags can be impaired due to modifications or incorrect work performed on the doors or door trim, or if the doors are damaged.

- ▶ Never modify the doors or parts of the doors.

- ▶ Always have work on the doors or door trim carried out at a qualified specialist workshop.

⚠ WARNING Risk of injury due to deployed airbag

A deployed airbag no longer offers any protection.

- ▶ Have the vehicle towed to a qualified specialist workshop in order to have the deployed airbag replaced.

Have deployed airbags replaced immediately.

Status of the front passenger front airbag

Function of the automatic front passenger airbag shutoff

The automatic front passenger airbag shutoff is able to detect whether the front passenger seat is occupied by a person or a child restraint system. The front passenger airbag is enabled or disabled accordingly.

When fitting a child restraint system to the front passenger seat, always make sure of the following:

- Ensure that the child restraint system is positioned correctly (→ page 57).
- Always observe the child restraint system manufacturer's installation instructions.
- Never place objects, such as cushions, under or behind the child restraint system.
- Fully retract the seat cushion length adjustment.
- The entire base of the child restraint system must always rest on the sitting surface of the front passenger seat.
- The backrest of the forward-facing child restraint system must, as far as possible, be resting on the seat backrest of the front passenger seat.
- The child restraint system must not touch the roof or be put under strain by the head restraints. Adjust the seat backrest inclination and the head restraint setting accordingly.

⚠ WARNING Risk of injury or death due to objects between the seat surface and the child restraint system

Objects between the sitting surface and the child restraint system could affect the function of the automatic front passenger airbag shutoff.

- ▶ Do not place any objects between the sitting surface and the child restraint system.
- ▶ The entire base of the child restraint system must always rest on the sitting surface of the front passenger seat.
- ▶ The backrest of the forward-facing child restraint system must, as far as possible, be resting on the seat backrest of the front passenger seat.
- ▶ Always comply with the child restraint system manufacturer's installation instructions.

A person on the front passenger seat must observe the following information:

- Fasten seat belts correctly (→ page 37).
- Sit in an almost upright seat position with their back against the seat backrest.
- Sit with their feet resting on the floor, if possible.

The front passenger airbag may otherwise be disabled by mistake, for example in the following situations:

- The front passenger transfers their weight by supporting themselves on a vehicle armrest.
- The front passenger sits in such a way that their weight is raised from the sitting surface.

⚠ WARNING Risk of injury or death due to a disabled front passenger airbag

The front passenger airbag is disabled when the PASSENGER AIR BAG OFF indicator lamp is lit.

A person in the front passenger seat could then, for example, come into contact with the vehicle interior, especially if the person is sitting too close to the cockpit.

If the front passenger seat is occupied, always ensure that:

- the classification of the person in the front passenger seat is correct and the front passenger airbag is enabled or disabled in accordance with the person in the front passenger seat.
 - the front passenger seat has been moved as far back as possible.
 - the person is seated correctly.
- ▶ Both before and during the journey, ensure that the status of the front passenger airbag is correct.

If the front passenger seat is occupied, the classification of the person or child restraint system on the front passenger seat takes place after the front passenger airbag shutoff self-test. The PASSENGER AIR BAG indicator lamps display the status of the front passenger airbag.

Always observe the notes on the function of the PASSENGER AIR BAG indicator lamps (→ page 47).

Function of the PASSENGER AIR BAG indicator lamps



Vehicles without automatic front passenger airbag shutoff have a special sticker affixed to the side of the cockpit on the front passenger side .

Self-test of automatic front passenger airbag shutoff

When the ignition is switched on, a self-test is performed during which the two PASSENGER AIR BAG ON and OFF indicator lamps light up simultaneously.

The status of the front passenger airbag is displayed via the PASSENGER AIR BAG indicator lamps after the self-test:

- **ON is lit:** the front passenger airbag may deploy during an accident.
The indicator lamp goes out after approximately 60 seconds.
- **ON and OFF are not lit:** the front passenger airbag may deploy during an accident.
- **OFF is lit:** the front passenger airbag is disabled. It will then not be deployed in the event of an accident.

If the PASSENGER AIR BAG ON indicator lamp is off, only the PASSENGER AIR BAG OFF indicator lamp shows the status of the front passenger airbag. The PASSENGER AIR BAG OFF indicator lamp may be lit continuously or be off.

If the PASSENGER AIR BAG OFF indicator lamp and the  restraint system warning lamp light up simultaneously, the front passenger seat may not be used. Also in this case, do not fit a child restraint system to the front passenger seat. Have automatic front passenger airbag shutoff checked and repaired immediately at a qualified specialist workshop.

Status display

If the front passenger seat is occupied, ensure, both before and during the journey, that the status of the front passenger airbag is correct for the current situation.

After fitting a rearward-facing child restraint system to the front passenger seat:

PASSENGER AIR BAG OFF must be lit continuously.

⚠ WARNING Risk of injury or death from using a rearward-facing child restraint system when the front passenger airbag is enabled

If you secure a child in a rearward-facing child restraint system on the front passenger seat and the PASSENGER AIR BAG OFF indicator lamp is off, the front passenger airbag can deploy in the event of an accident.

The child could be struck by the airbag.

Always ensure that the front passenger airbag is disabled. The PASSENGER AIR BAG OFF indicator lamp must be lit.

NEVER use a rearward-facing child restraint system on a seat with an ENABLED FRONT AIRBAG, DEATH or SERIOUS INJURY to the CHILD can occur.

When fitting a child restraint system to the front passenger seat, observe the vehicle-specific information .

Depending on the child restraint system and the stature of the child, the PASSENGER AIR BAG OFF indicator lamp may be off. In this case, do

not fit the rearward-facing child restraint system to the front passenger seat.

Instead, fit the rearward-facing child restraint system to a suitable rear seat.

After fitting a forward-facing child restraint system to the front passenger seat: depending on the child restraint system and the stature of the child, PASSENGER AIR BAG OFF may be lit continuously or be off. Always observe the following information.

⚠ WARNING Risk of injury or death due to incorrect positioning of the forward-facing child restraint system

If you secure a child in a forward-facing child restraint system on the front passenger seat and you position the front passenger seat too close to the cockpit, in the event of an accident, the child could:

- Come into contact with the vehicle interior if the PASSENGER AIR BAG OFF indicator lamp is lit, for example.
- Be struck by the airbag if the PASSENGER AIR BAG OFF indicator lamp is off.

- ▶ Always move the front passenger seat as far back as possible and fully retract the seat cushion length adjustment. Always make sure that the shoulder belt strap is correctly routed from the seat belt outlet on the vehicle to the shoulder belt guide on the child restraint system. The shoulder belt strap must be routed forwards and downwards from the seat belt outlet. If necessary, adjust the seat belt outlet and the front passenger seat accordingly.
- ▶ Always observe the child restraint system manufacturer's installation instructions.

When fitting a child restraint system to the front passenger seat, observe the vehicle-specific information .

If a person is sitting on the front passenger seat: PASSENGER AIR BAG OFF may be lit continuously or be off, depending on the person's stature.

A person on the front passenger seat must always observe the following information:

- If the front passenger seat is occupied by an adult or a person with a stature corresponding to that of an adult, the PASSENGER AIR BAG OFF indicator lamp must be off. This indicates that the front passenger airbag is enabled.

If the PASSENGER AIR BAG OFF indicator lamp is lit continuously, an adult or person with a build corresponding to that of an adult should not use the front passenger seat.

Instead, they should use a rear seat.

- If the front passenger seat is occupied by a person of smaller stature (e.g. a teenager or small adult), the PASSENGER AIR BAG OFF indicator lamp either lights up continuously or remains off, depending on the classification.
- If the PASSENGER AIR BAG OFF indicator lamp is off: move the front passenger seat as far back as possible, or the person of smaller stature should use a rear seat.

- If the PASSENGER AIR BAG OFF indicator lamp is lit continuously: the person of smaller stature should not use the front passenger seat.

⚠ WARNING Risk of injury or death when the PASSENGER AIR BAG OFF indicator lamp is lit

If the PASSENGER AIR BAG OFF indicator lamp remains lit after the self-test, the co-driver airbag is disabled.

If the co-driver seat is occupied, always ensure that:

- The classification of the person in the co-driver seat is correct, and the co-driver airbag is enabled or disabled as is appropriate for the person in the co-driver seat.
- The person is seated properly with a correctly fastened seat belt.

Be sure to also observe the following further related subjects:

- Child restraint system on the front passenger seat .

- Suitable positioning of the child restraint system (→ page 57).

PRE-SAFE® system

PRE-SAFE® (anticipatory occupant protection)

PRE-SAFE® is able to detect certain critical driving situations and implement pre-emptive measures to protect the vehicle occupants.

PRE-SAFE® can implement the following measures independently of each other:

- Tightening the seat belts on the driver's seat and front passenger seat.
- Closing the side windows.
- **Vehicles with sliding sunroof:** close the sliding sunroof.
- **Vehicles with memory function:** move the front passenger seat to a more favourable seat position.
- **Vehicles with memory function in the rear compartment:** move the outer rear seats to a more favourable seat position.

- **Vehicles with multicontour seat:** increase the air pressure in the seat side bolsters of the seat backrest.
- PRE-SAFE® Sound: provided that the multimedia system is switched on, generates a brief noise signal to stimulate the innate protective mechanism of a person's hearing.

! **NOTE** Damage caused by objects in the footwell or behind the seat

The automatic adjustment of the seat position may result in damage to the seat and/or the object.

▶ Stow objects in a suitable place.

Reversing the PRE-SAFE® system measures

If an accident did not occur, the pre-emptive measures that were taken are reversed.

You will need to perform certain settings yourself.

- ▶ If the seat belt pre-tensioning is not reduced, move the seat backrest back slightly. The locking mechanism releases.

Function of PRE-SAFE® PLUS (anticipatory occupant protection plus)

PRE-SAFE® PLUS can detect certain impacts, particularly an imminent rear impact, and take pre-emptive measures to protect the vehicle occupants. These measures cannot necessarily prevent an imminent impact.

PRE-SAFE® PLUS can implement the following measures independently of each other:

- Tightening the seat belts on the driver's seat and front passenger seat.
- Activating the rear hazard warning lights at a higher flashing frequency.
- Increasing brake pressure when the vehicle is stationary. This brake application is cancelled automatically when the vehicle pulls away.

If an accident did not occur, the pre-emptive measures that were taken are reversed.

System limits

The system will not initiate any action in the following situations:

- when reversing
or
- when the vehicle is towing a trailer and there is a risk of a rear impact

The system will not initiate any braking application in the following situations:

- whilst driving
or
- when entering or exiting a parking space while using Active Parking Assist

Function of PRE-SAFE® Impulse Side

If an imminent side impact is detected, PRE-SAFE® Impulse Side can pre-emptively move the front seat vehicle occupant's upper body towards the centre of the vehicle. It does this by

rapidly inflating an air cushion in the outer seat side bolster of the seat backrest on the side on which the impact is anticipated. This increases the distance between the door and the vehicle occupant.

Vehicles with E-ACTIVE BODY CONTROL: the body can also be slightly raised.

If PRE-SAFE® Impulse Side has been deployed or is faulty, the [PRE-SAFE impulse side inoperative](#) See [Owner's Manual](#) (→ page 575) display message appears.

Automatic measures after an accident

Depending on the type and severity of the accident, and depending on the vehicle's equipment, the following measures can be implemented, for example:

- automatic braking (post-collision brake)
- activating the hazard warning lights
- triggering an automatic emergency call (→ page 409)
- switching off the engine

To restart the vehicle, switch the ignition off and switch it back on (→ page 174). Depending on the type and severity of the accident, it is possible that the vehicle can no longer be started.

- switching off the fuel supply
- unlocking the vehicle doors
- lowering the side windows
- displaying the emergency guide in the media display
- switching on the interior lighting

Function of the post-collision brake

Depending on the accident situation, the post-collision brake can minimise the severity of a further collision or even avoid it.

If an accident is detected, the post-collision brake can implement automatic braking. When the vehicle has come to a standstill, the electric parking brake is automatically applied.

The driver can cancel automatic braking by taking the following actions:

- braking more strongly than automatic braking

- fully depressing the accelerator pedal with force

Safely transporting children in the vehicle

Always observe when children are travelling in the vehicle

- ⓘ Also strictly observe the safety notes for the specific situation. In this way you can recognise potential risks and avoid dangers if children are travelling in the vehicle (→ page 52).

Be diligent

Bear in mind that negligence when securing the child in the child restraint system may have serious consequences. Always be diligent in securing a child carefully before every journey.

To improve protection for children younger than twelve years old or under 1.50 m in height, Mercedes-Benz recommends you observe the following information:

- Always secure the child in a child restraint system suitable for this Mercedes-Benz vehicle.

- The child restraint system must be appropriate to the age, weight and size of the child.
- The vehicle seat must be suitable for fitting a child restraint system (→ page 57).

Accident statistics show that children secured on the rear seats are generally safer than children secured on the front seats. For this reason, Mercedes-Benz strongly advises that you fit a child restraint system to a rear seat.

Generic term "child restraint system"

The generic term child restraint system is used in this Owner's Manual. A child restraint system is, for example:

- a baby car seat
- a rearward-facing child seat
- a forward-facing child seat
- a child booster seat with a backrest and seat belt guide

Mercedes-Benz recommends using a child booster seat with a backrest.

The child restraint system must be appropriate to the age, weight and size of the child.

Observing laws and legal requirements

Always observe the legal requirements when using a child restraint system in the vehicle.

Make sure that the child restraint system is approved in accordance with the valid test specifications and guidelines. Further information can be obtained at a qualified specialist workshop. Mercedes-Benz recommends that you use a Mercedes-Benz Service Centre for this purpose.

Only use approved child restraint systems

Only child restraint systems that meet the following UNECE standards are permitted for use in the vehicle:

- UN-R44
- UN-R129 (i-Size child restraint systems)

Information on child restraint system approval categories and details on the approval label on the child restraint system (→ page 57).

Detecting risks, avoiding danger

Securing systems for child restraint systems in the vehicle

Only use the following securing systems for child restraint systems:

- the ISOFIX or i-Size mounting brackets
- the vehicle's seat belt system
- the Top Tether anchorages

Fitting an ISOFIX or an i-Size child restraint system is preferred.

Simply attaching to the securing rings on the vehicle can reduce the risk of fitting the child restraint system incorrectly.

When securing a child with the integrated seat belt of the ISOFIX or i-Size child restraint system, always comply with the permissible gross weight for the child and child restraint system (→ page 60).

Advantage of a rearward-facing child restraint system

It is preferable to transport a baby or a small child in a suitable rearward-facing child restraint

system. In this case, the child sits in the opposite direction to the direction of travel and faces backwards.

Babies and small children have comparatively weak neck muscles in relation to the size and weight of their head. The risk of injury to the cervical spine during an accident can be reduced in a rearward-facing child restraint system.

Always secure a child restraint system correctly

⚠ WARNING Risk of injury or death due to incorrect installation of the child restraint system

The child can then not be protected or restrained as intended.

- ▶ Be sure to comply with the manufacturer's installation instructions for the child restraint system and its correct use.
- ▶ Make sure that the entire base of the child restraint system always rests on the sitting surface of the seat.

- ▶ Never place objects (e.g. cushions) under or behind the child restraint system.
- ▶ Use child restraint systems only with the original cover designed for them.
- ▶ Always replace damaged covers with genuine covers.

⚠ WARNING Risk of injury or death due to unsecured child restraint systems in the vehicle

If the child restraint system is fitted incorrectly or not secured, it may come loose.

The child restraint system can be thrown about and strike vehicle occupants.

- ▶ Always install child restraint systems correctly, even when not in use.
 - ▶ Always comply with the child restraint system manufacturer's installation instructions.
- Always observe the child restraint system manufacturer's installation and operating

instructions as well as the vehicle-specific information:

- Fit the ISOFIX or i-Size child restraint system to the rear seat (→ page 60).
- Secure the child restraint system with the seat belt on the rear seat .
- Secure the child restraint system with the seat belt on the front passenger seat . Observe the specific instructions for the rearward-facing and forward-facing child restraint systems .

If the front passenger seat is occupied, ensure, both before and during the journey, that the status of the front passenger airbag is correct for the current situation (→ page 47).

- Observe the warning labels in the vehicle interior and on the child restraint system.
- Also secure Top Tether if present.

Notes for vehicles with the MBUX Interior Assistant

If the child restraint system is not fastened by the seat belt, a corresponding message appears in the multimedia display (→ page 315).

Do not alter the child restraint system

⚠ WARNING Risk of injury due to modifications to the child restraint system

The child restraint system can no longer function properly. This poses an increased risk of injury.

- ▶ Never modify a child restraint system.
- ▶ Only affix accessories which have been specially approved for this child restraint system by the child restraint system's manufacturer.

Mercedes-Benz recommends Mercedes-Benz care products for cleaning child restraint systems recommended by Mercedes-Benz.

Only use child restraint systems which are in proper working condition

⚠ WARNING Risk of injury or death caused by the use of damaged child restraint systems

Child restraint systems or their securing systems which have been subjected to stress in an accident may no longer be able to perform their intended protective function.

The child cannot then be restrained.

- ▶ Always replace child restraint systems immediately that have been damaged or involved in an accident.
- ▶ Have the securing systems for the child restraint systems checked at a qualified specialist workshop before installing a child restraint system again.

Avoid direct sunlight

⚠ WARNING Risk of burns when the child seat is exposed to direct sunlight

If the child restraint system is exposed to direct sunlight or heat, parts may become extremely hot.

Children could suffer burns from these parts, particularly the metallic parts of the child-restraint system.

- ▶ Always make sure that the child restraint system is not exposed to direct sunlight.
- ▶ Protect the child restraint system, for example, with a blanket.
- ▶ If the child restraint system has been exposed to direct sunlight, allow it to cool before securing a child in it.
- ▶ Never leave children unattended in the vehicle.

Observe when stopping or parking

⚠ WARNING Risk of accident and injury due to children left unattended in the vehicle

If children are left unsupervised in the vehicle, they could, in particular:

- open doors, thereby endangering other persons or road users.
- get out and be struck by oncoming traffic.
- operate vehicle equipment and become trapped, for example.

In addition, the children could also set the vehicle in motion, for example by:

- releasing the parking brake.
- change the transmission position.
- start the vehicle.

▶ Never leave children unattended in the vehicle.

- ▶ When leaving the vehicle, always take the key with you and lock the vehicle.
- ▶ Keep the key out of reach of children.

This also applies to the Digital Vehicle Key if the "Digital Vehicle Key" function is activated via Mercedes me connect.

⚠ WARNING Risk of fatal injury due to exposure to extreme heat or cold in the vehicle

If people – particularly children – are exposed to extreme temperatures over an extended period of time, there is a risk of serious or even fatal injury!

- ▶ Never leave anyone – particularly children – unattended in the vehicle.
- ▶ Never leave animals in the vehicle unattended.

Overview of recommended child restraint systems

ⓘ Further information on the correct child restraint system can be obtained at a qualified specialist workshop. Mercedes-Benz recommends that you use a Mercedes-Benz Service Centre for this purpose.

Vehicles with belt airbags:

When securing a child in a child restraint system on an outer rear seat, it is essential to observe the following instructions:

- Only use a child restraint system approved by Mercedes-Benz.
 - Weight category 0, 0+ or 1: the child restraint system must be installed on the ISOFIX or i-Size child seat securing system.
 - Weight category II/III: only use the approved KIDFIX XP child seats.
- Secure a rearward-facing child restraint system with the ISOFIX or the i-Size child seat securing system.

- Secure a forward-facing child restraint system with the ISOFIX or the i-Size child seat securing system and, if present, the Top Tether anchorage.
- Observe the notes in "Belt airbag in rear seat belt" (→ page 39).

Securing with ISOFIX

Category 0+ (up to 13 kg and approx. 15 months)

Type ¹	BABY SAFE plus
Size category	E
Approval	E1 04 301 146
Order number ²	B6 6 86 8224
1 Manufacturer: Britax Römer.	2 With colour code 9H95.

Category I (9 to 18 kg)

Type ¹	DUO plus
Size category	B1
Approval	E1 04 301 133

Type ¹	DUO plus
Order number ²	A 000 970 43 02
1 Manufacturer: Britax Römer.	2 With colour code 9H95.

Securing with the vehicle seat belt

Category 0 (up to 10 kg and approx. 6 months) and category 0+ (up to 13 kg and approx. 15 months)

Type ¹	BABY SAFE plus II
Approval	E1 04 301 146
Order number ²	A 000 970 38 02
1 Manufacturer: Britax Römer.	2 With colour code 9H95.

Category I (9 to 18 kg and from approximately 9 months to 4 years)

Type ¹	DUO plus
Approval	E1 04 301 133
Order number ²	A 000 970 43 02
1 Manufacturer: Britax Römer.	2 With colour code 9H95.

Category II/III (15 to 36 kg and from approximately 4 to 12 years)

Type ¹	KIDFIX XP
Approval	E1 04 301 304
Order number ²	A 000 970 49 02

Type ¹	AMG KIDFIX XP
Approval	E1 04 301 304
Order number ²	A 000 970 33 02
1 Manufacturer: Britax Römer.	2 With colour code 9H95.

Overview of suitable seats in the vehicle for fitting a child restraint system

Left/right rear seat

Preferred securing system:

 ISOFIX child seat securing system
(→ page 59)

or

 i-Size child seat securing system
(→ page 60)

 Also secure Top Tether if present
(→ page 62)

Alternative securing system:

 Vehicle seat belt

Front passenger seat

Securing system:

 Vehicle seat belt

Be sure to observe:

- If the front passenger seat is occupied, ensure, both before and during the journey, that the status of the front passenger airbag

is correct for the current situation
(→ page 47).

- Observe the notes on automatic front passenger airbag shutoff (→ page 45)

Centre rear seat

Securing system:

 Vehicle seat belt

Approval categories for child restraint systems

Only use approved child restraint systems

Only child restraint systems that meet the following UNECE standards are permitted for use in the vehicle:

- UN-R44
- UN-R129 (i-Size child restraint systems)

Identification on the child restraint system

Information about the approval category, weight category and approval number, for example, is on the approval label on the child restraint system.

There may be further information such as the ISOFIX size categories, depending on the approval category of the child restraint system.

Approval categories in accordance with UN-R44

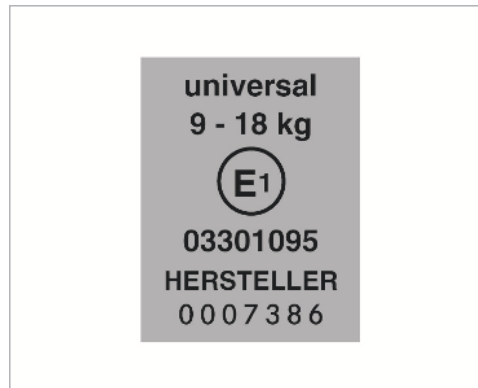

Example of an approval label

- **Universal:** child restraint systems in the "Universal" category are approved for instal-

lation in vehicles. They can be used, in accordance with overviews of the suitability of seats for securing child restraint systems, on seats labelled U, UF or IUF.

The identification IUF refers to ISOFIX child restraint systems in the "Universal" category. These child restraint systems must also be secured using Top Tether or support points.

- **Semi-Universal:** child restraint systems in the "Semi-Universal" category may only be used if the vehicle and vehicle seat are listed in the child restraint system manufacturer's vehicle model list.
- **Vehicle-specific:** child restraint systems in the "vehicle-specific" category may only be used if the vehicle and vehicle seat are listed in the child restraint system manufacturer's vehicle model list.

Approval categories in accordance with UN-R129

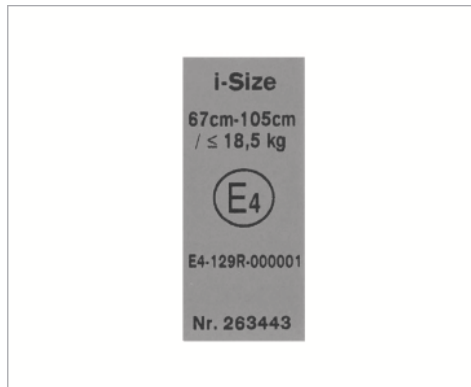

Example of an approval label

- **i-Size:** child restraint systems in the "i-Size" category are approved for installation in vehicles with i-Size mounting brackets. They can be used, in accordance with overviews of the

suitability of seats for securing child restraint systems, on seats labelled i-U.

The identification i-U refers to i-Size child restraint systems in the "Universal" category. These child restraint systems must also be secured using Top Tether or support points.

Observe the suitability of vehicle seats

Depending on the approval category, there are forward-facing and rearward-facing child restraint systems. Their use can be restricted for certain vehicle seats:

- Suitability of seats for securing ISOFIX child restraint systems (→ page 59).
- Suitability of seats for securing i-Size child restraint systems (→ page 60).
- Suitability of seats for securing belt-secured child restraint systems

ISOFIX and i-Size child seat securing systems

Overview of suitability of the seats for attaching ISOFIX child restraint systems

ISOFIX is a standardised securing system for specially designed restraint systems.

 The symbol indicates seats suitable for attaching an ISOFIX child restraint system in accordance with UN R44 (→ page 57).

Attach only child restraint systems that are approved in accordance with UN R44 as per the following ISOFIX tables.

Carry cot

Size class – Equipment	Left/right rear seat
F – ISO/L1	X
G – ISO/L2	X

X Not suitable for an ISOFIX child restraint system in this weight group and/or size class.

Weight group 0 (up to 10 kg and up to approx. 6 months)

Size class – Equipment	Left/right rear seat
E – ISO/R1	IL

IL Suitable for ISOFIX child restraint systems according to the table in "Overview of the recommended child restraint systems", or if the vehicle and the seat are listed on the child restraint system manufacturer's vehicle model list.

Weight group 0+ (up to 13 kg and up to approx. 15 months)

Size class – Equipment	Left/right rear seat
E – ISO/R1	IL
D – ISO/R2, ISO/R2X	IL

Size class – Equipment	Left/right rear seat
C – ISO/R3	IL (1)

IL Suitable for ISOFIX child restraint systems according to the table in "Overview of the recommended child restraint systems", or if the vehicle and the seat are listed on the child restraint system manufacturer's vehicle model list.

(1) When using a child restraint system of size class (ISO/R3), move the front seat into the highest position. Make sure that the seat backrest of the front seat does not rest against the child restraint system.

Weight group 1 (9–18 kg and approx. 9 months to 4 years)

Size class – Equipment	Left/right rear seat
D – ISO/R2, ISO/R2X	IL
C – ISO/R3	IL (1)
B – ISO/F2	IUF

Size class – Equipment	Left/right rear seat
B1 – ISO/F2X	IUF
A – ISO/F3	IUF

IL Suitable for ISOFIX child restraint systems according to the table in "Overview of the recommended child restraint systems", or if the vehicle and the seat are listed on the child restraint system manufacturer's vehicle model list.

IUF Suitable for forward-facing ISOFIX child restraint systems of the "Universal" category in this weight group.

(1) When using a child restraint system of size class (ISO/R3), move the front seat into the highest position. Make sure that the seat backrest of the front seat does not rest against the child restraint system.

Overview of suitability of the seats for attaching i-Size child restraint systems

i-Size is a standardised securing system for specially designed restraint systems.



The symbol indicates seats suitable for attaching an i-Size child restraint system

in accordance with UN R129 (→ page 57).

Child restraint systems that are permitted in accordance with UN R44 as per the ISOFIX tables (→ page 59) or UN R129 as per the following i-Size tables may be attached.

i-Size child restraint systems (ISO/R2, ISO/F2X, ISO/B2, ISO/B3)

Front passenger seat	Left/right rear seat
X	i-U
X Not suitable for an i-Size child restraint system in the "Universal" category.	i-U Suitable for forward-facing and rearward-facing i-Size child restraint systems in the "Universal" category.

Fitting the ISOFIX or i-Size child restraint system on the rear seat

▲ WARNING Risk of injury or death if the permissible gross mass of the child and child restraint system is exceeded.

Too much load may be placed on the ISOFIX or i-Size child restraint systems and the child may not be restrained correctly in the event of an accident, for example.

- ▶ If the child and the child restraint system together weigh more than 33 kg, use only an ISOFIX or i-Size child restraint system that secures the child using the vehicle seat belt.
- ▶ Also secure the child restraint system with the Top Tether belt, if available.

Always comply with the information about the mass of the child restraint system:

- in the manufacturer's installation and operating instructions for the child restraint system used

- on a label on the child restraint system, if present

Regularly check that the permissible gross mass of the child and child restraint system is still complied with.

When fitting a child restraint system, observe the following:

- ✓ Always observe the correct use of the seats and consider their suitability for attaching a child restraint system.

ISOFIX child seat securing system
(→ page 59)

or

i-Size child seat securing system
(→ page 60)

- ✓ Always comply with the manufacturer's installation and operating instructions for the child restraint system used.
- ✓ Make sure that the child's feet do not touch the front seat. If necessary, move the front seat slightly forwards.

 When fitting an ISOFIX child restraint system, also observe the following:

- ✓ **When using a Group 0/0+ baby car seat and a Group 1 rearward-facing child restraint system on a rear seat:** adjust the front seat so that the seat does not touch the child restraint system.

- ✓ **When using a Group 1 forward-facing child restraint system:** remove the head restraint from the respective seat, if possible. In addition, the backrest of the child restraint system must, as far as possible, lie flat against the backrest of the vehicle seat. After the child restraint system has been removed, replace the head restraints immediately and adjust them correctly.

- ✓ For certain child restraint systems in weight group 2 or 3, there may be restrictions on the maximum size setting, e.g. due to possible contact with the roof.

- ✓ The child restraint system must not be put under strain between the roof and the seat cushion and/or be fitted facing the wrong

direction. Where possible, adjust the seat cushion inclination accordingly.

- ✓ The child restraint system must not be put under strain by the head restraint. Adjust the head restraints accordingly.

 When fitting an i-Size child restraint system, also observe the following:

- ✓ **When using a rearward-facing child restraint system:** adjust the front seat so that it does not touch the child restraint system.

- ✓ **When using a forward-facing child restraint system:** remove the head restraint from the respective seat, if possible. In addition, the backrest of the child restraint system must, as far as possible, lie flat against the backrest of the vehicle seat. After the child restraint system has been removed, replace the head restraints immediately and adjust them correctly.

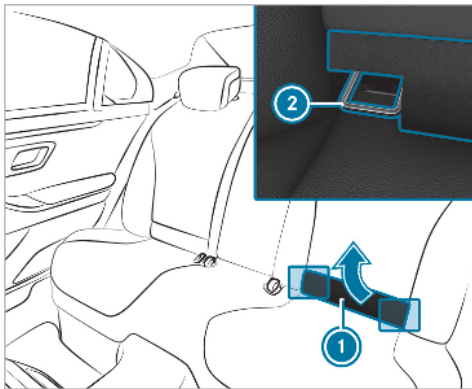

Before every journey, make sure that the ISOFIX child restraint system or the i-Size child restraint system is engaged correctly in both ISOFIX or i-Size mounting brackets.

! **NOTE** Be careful not to damage the seat belt for the centre seat when fitting the child restraint system

▶ Make sure that the seat belt is not trapped.

- ▶ Fold upholstered lining ① upwards.
- ▶ Turn the support on the rear side of upholstered lining ① by 90°. Upholstered lining ① will remain folded upwards.
- ▶ Attach the ISOFIX or i-Size child restraint system to both mounting brackets ② in the vehicle.

Securing a Top Tether

! **WARNING** Risk of injury or death from adjusting the seat after fitting a child restraint system

Vehicles with electrically adjustable rear seats:

The following may occur:

- The Top Tether belt may either sit too loose or too tight
 - The child restraint system may be loosened, positioned incorrectly or damaged and then not offer the intended protection.
- ▶ Never adjust the seat after the child restraint system has been installed.



If the child restraint system is equipped with a Top Tether belt:

The risk of injury can be reduced by a Top Tether. The Top Tether belt enables an additional connection between the child restraint system attached with ISOFIX or i-Size and the vehicle.

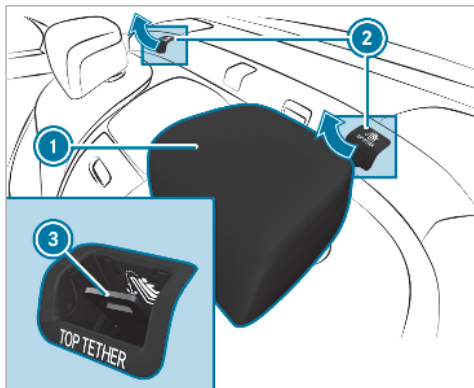

- ▶ If necessary, slide head restraint ① upwards (→ page 104).
- ▶ If cover ② of Top Tether anchorage ③ was not removed, fold up cover ②.
- ▶ Fit the ISOFIX or i-Size child restraint system with Top Tether. Comply with the child restraint system manufacturer's installation instructions when doing so.

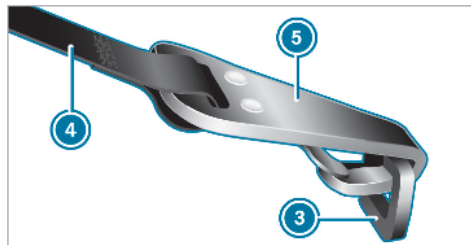

- ▶ Guide Top Tether belt ④ under head restraint ① between the two head restraint bars.
- ▶ Hook Top Tether hook ⑤ of Top Tether belt ④ into Top Tether anchorage ③ without twisting.
- ▶ Tension Top Tether belt ④. Comply with the child restraint system manufacturer's installation instructions when doing so.
- ▶ If necessary, fold down cover ② of Top Tether anchorage ③.
- ▶ If necessary, slide head restraint ① downwards (→ page 104). Make sure that you do

not interfere with the correct routing of Top Tether belt ④.

Child safety locks

Activating/deactivating the child safety lock for the rear doors

⚠ WARNING Risk of accident and injury due to children left unattended in the vehicle

If children are left unattended in the vehicle, they could:

- Open doors, thereby endangering other persons or road users.
- Get out and be struck by oncoming traffic.
- Operate vehicle equipment and become trapped, for example.

In addition, the children could also set the vehicle in motion, for example by:

- Releasing the parking brake.

- Changing the transmission position.
- Starting the vehicle.

- ▶ Never leave children unattended in the vehicle.
- ▶ When leaving the vehicle, always take the key with you and lock the vehicle.
- ▶ Keep the vehicle key out of reach of children.

This also applies to the Digital Vehicle Key if the "Digital Vehicle Key" function is activated via Mercedes me connect.

⚠ WARNING Risk of fatal injury due to exposure to extreme heat or cold in the vehicle

If people –particularly children – are exposed to extreme temperatures over an extended period of time, there is a risk of serious or even fatal injury!

- ▶ Never leave anyone – particularly children – unattended in the vehicle.

- ▶ Never leave animals in the vehicle unattended.

⚠ WARNING Risk of accident and injury due to children left unattended in the vehicle

If children are travelling in the vehicle, they could, in particular:

- open doors, thereby endangering other persons or road users
- get out and be struck by oncoming traffic
- operate vehicle equipment and become trapped, for example

- ▶ Always activate the child safety locks installed if children are travelling in the vehicle.
- ▶ Never leave children unattended in the vehicle.
- ▶ When leaving the vehicle, always take the key with you and lock the vehicle. This also applies to the Digital Vehicle

Key if the "Digital Vehicle Key" function is activated via Mercedes me connect.

There are child safety locks for the rear doors and the rear side windows.

Vehicles for the United Kingdom: observe the important safety notes in the "Notes on the additional door lock" section.

The child safety lock on the rear doors secures each door separately. The doors can no longer be opened from the inside.

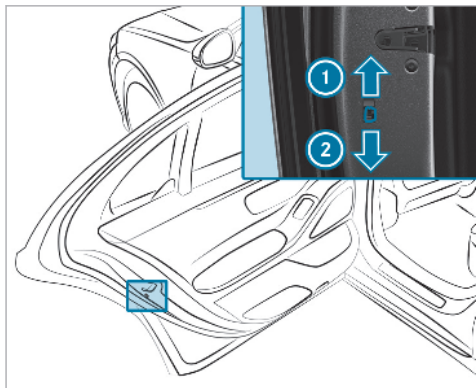

- ▶ Press the lever in direction ① (activate) or ② (deactivate).
- ▶ Make sure that the child safety locks are working properly.

Activating/deactivating the child safety lock for the rear side windows

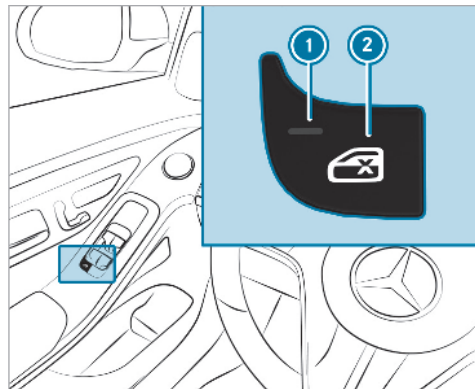

- ▶ **To activate/deactivate:** press button ②. Opening/closing the side window in the rear is possible:
 - With indicator lamp ① lit: via the switch on the driver's door.

- With indicator lamp ① off: via the switch on the corresponding rear door or driver's door.

When the child safety lock is activated, the controls in the rear compartment are disabled for:

- the rear side windows
- the adjustment of the front passenger seat from the rear compartment
- the roller sunblinds:
 - of the rear side windows
 - of the rear window
 - in the roof

Notes on pets in the vehicle

⚠ WARNING Risk of accident and injury due to animals left unsecured or unattended in the vehicle

If you leave animals in the vehicle unattended or unsecured, they could possibly press down buttons or switches.

Thereby an animal may:

- activate vehicle equipment and become trapped, for example
- switch systems on or off and endanger other road users

Unsecured animals may be thrown around in the vehicle in the event of an accident or sudden steering and braking manoeuvres and injure vehicle occupants in the process.

- ▶ Never leave animals in the vehicle unattended.
- ▶ Always correctly secure animals while driving, e.g. using a suitable animal carrier.

Key

Overview of key functions

⚠ WARNING Risk of accident and injury due to children left unattended in the vehicle

If children are left unsupervised in the vehicle, they could, in particular:

- open doors, thereby endangering other persons or road users.
- get out and be struck by oncoming traffic.
- operate vehicle equipment and become trapped, for example.

In addition, the children could also set the vehicle in motion, for example by:

- releasing the parking brake.
- change the transmission position.
- start the vehicle.

▶ Never leave children unattended in the vehicle.

- ▶ When leaving the vehicle, always take the key with you and lock the vehicle.
- ▶ Keep the key out of reach of children.



This also applies to the Digital Vehicle Key if the "Digital Vehicle Key" function is activated via Mercedes me connect.

! NOTE Damage to the key caused by magnetic fields

- ▶ Keep the key away from strong magnetic fields.



- ① Indicator lamp
- ② Locks
- ③ Unlocks (with embossed surface)
- ④ Opens/closes the boot lid

i If check lamp ① does not light up after pressing the  or  button, the battery is weak or possibly discharged. Replace the battery as soon as possible.

Replacing the key battery (→ page 69).

The key locks and unlocks the following components:

- Doors
- Fuel filler flap

- Boot lid

If the vehicle is not opened within approximately 40 seconds after unlocking, it locks again. Anti-theft protection is primed again.

Do not keep the key together with electronic devices or metal objects. This can affect the key's functionality.

Activating/deactivating the acoustic locking verification signal

Multimedia system:

→  ► Settings ► Vehicle
► Locking function

► Activate or deactivate **Acoustic lock**.

Please note:



The selected setting for the acoustic locking verification signal must comply with the relevant national road and traffic regulations. In some countries, including Germany, using the acoustic locking verification signal is forbidden by traffic laws (in accordance with §16 Para. 1 and §30 Para. 1 of the German national road traffic regulations). The driver

of the vehicle must comply with these regulations. In countries where the use of this function is forbidden, this function is not activated in the vehicle and must not be activated.

Changing the unlocking settings

Possible unlocking functions of the key:

- Central unlocking
- Unlocking the driver's door and fuel filler flap

► **To switch between settings:** press the  and  buttons simultaneously for approximately six seconds until the indicator lamp flashes twice.

Options if the unlocking function for the driver's door and fuel filler flap has been selected:

- **To unlock the vehicle centrally:** press the  button twice.
- **Vehicles with KEYLESS-GO:** if you touch the inner surface of the door handle on the driver's door, only the driver's door and fuel filler flap are unlocked.

Deactivating the key functions

If you do not use the vehicle or a key for an extended period of time, you can reduce the energy consumption of the respective key. To do so, deactivate the key functions.

► **To deactivate:** press the  button on the key twice in quick succession. The key indicator lamp flashes twice briefly and lights up once.

► **To activate:** press any button on the key.

 When the vehicle is started with the key in the stowage compartment of the centre console, the key functions are automatically activated (→ page 175).

Removing/inserting the emergency key

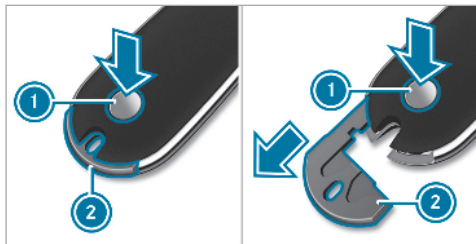

- ▶ **To remove:** press release knob ①. Emergency key ② is pushed out slightly.
- ▶ Fully remove emergency key ②.

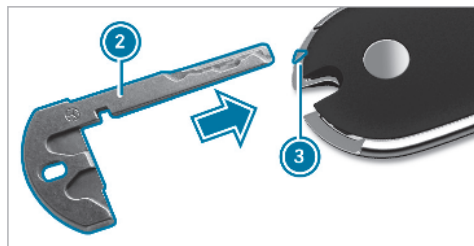

- ▶ **To insert:** insert emergency key ② at marking ③ until it engages.
- ① You can use emergency key ② to attach the key to a key ring.

Replacing the key battery

⚠ DANGER Serious damage to health caused by swallowing batteries

Batteries contain toxic and corrosive substances. Swallowing batteries may cause serious damage to health.

There is a risk of fatal injury.

- ▶ Keep batteries out of the reach of children.
- ▶ If batteries are swallowed, seek medical attention immediately.

🔥 ENVIRONMENTAL NOTE Environmental damage due to improper disposal of batteries



Batteries contain pollutants. It is illegal to dispose of them with the household rubbish.



Dispose of batteries in an environmentally responsible manner. Take discharged batteries to a qualified specialist workshop or to a collection point for used batteries.

Requirements:

- You require a CR 2032 3 V cell battery.

Mercedes-Benz recommends that you have the battery replaced at a qualified specialist workshop.

- Remove the emergency key (→ page 69).



- Press emergency key (2) into the opening in the key in the direction of the arrow until cover (1) opens. When doing so, do not hold cover (1) closed.

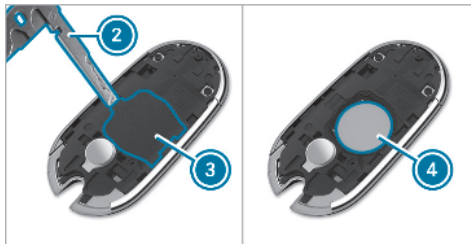

- Insert the emergency key into the opening of the cover and lift up covering (3) and remove it.
- Repeatedly tap the key against your palm until battery (4) falls out of the key.
- Insert the new battery with the positive pole facing upwards. Use a lint-free cloth to do so.
- Make sure that the surface of the battery is free of lint, grease and other impurities.
- Insert the front tabs of covering (3) into the housing and then press on both sides to close it.

- Make sure that covering (3) is completely closed.
- Insert the front tabs of cover (1) into the housing and then press until it is completely closed.
- Insert emergency key (2) into the key until it engages.

Problems with the key

You can no longer lock or unlock the vehicle

Possible causes:

- The key battery is weak or discharged.
- The key is faulty.
- Check the battery using the indicator lamp and replace if necessary (→ page 69).
- Use the emergency key to lock or unlock (→ page 69).
- Have the key checked at a qualified specialist workshop.

There is interference from a powerful radio signal source

The key function is impaired by, for example:

- high voltage power lines
- mobile phones
- electronic devices (Notebooks, Tablets)
- shielding due to metal objects or induction loops for electrical gate systems or automatic barriers

▶ Make sure that there is a sufficient distance between the key and the potential source of interference.

You have lost a key

- ▶ Have the key deactivated at a qualified specialist workshop.
- ▶ If necessary, have the mechanical lock replaced as well.

Doors

Notes on the additional door lock

The additional door lock is only available for vehicles for the United Kingdom.

⚠ WARNING Risk of injury to persons inside the vehicle when the additional door lock is activated

If the additional door lock is activated, the doors can no longer be opened from the inside.

- ▶ **Never leave persons, in particular children, unattended in the vehicle.**
- ▶ If there are persons in the vehicle, do not activate the additional door lock.

The additional door lock is automatically activated in the following situations:

- The vehicle is locked using the key.
- The vehicle is locked using KEYLESS-GO.

If the vehicle has been locked via Mercedes me connect, the additional door lock is not activated.

If the additional door lock is activated, the doors cannot be opened from the inside.

i After locking you can issue a signal with the horn.

You can prevent the additional door lock from being activated by deactivating interior protection before locking the vehicle (→ page 95).

Unlocking/opening the doors from the inside

▶ **United Kingdom only:** observe the notes on the additional door lock (→ page 71).

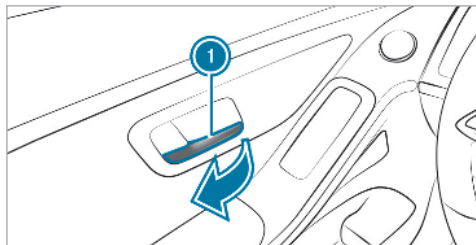

- ▶ Pull door handle ①.

Centrally locking and unlocking the vehicle from the inside

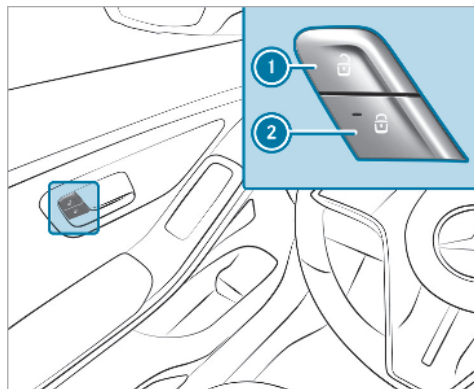

- ▶ **To unlock:** press button ①.
- ▶ **To lock:** press button ②.
The indicator lamp lights up.

This does not lock or unlock the fuel filler flap.

The vehicle is not unlocked:

- If you have locked the vehicle using the key.
- If you have locked the vehicle using KEY-LESS-GO.

Locking/unlocking the vehicle with a Digital Vehicle Key

Requirements:

- one of the following versions of the Digital Vehicle Key is available:
 - suitable mobile phone
 - Digital Vehicle Key sticker
 - the vehicle is equipped with the "Digital Vehicle Key" function.
 - the "Digital Vehicle Key" function is activated via Mercedes me connect: <https://www.mercedes.me>.
 - the mobile phone is sufficiently charged.
- ⓘ Mercedes-Benz recommends that you carry the emergency key in case of function restrictions.

- ❗ If the mobile phone is in a protective case, this can impair the functionality.

If the vehicle has been parked for longer than two weeks, the NFC aerial in the door handle is deactivated.

- ▶ Pull the door handle.
The NFC aerial is activated.

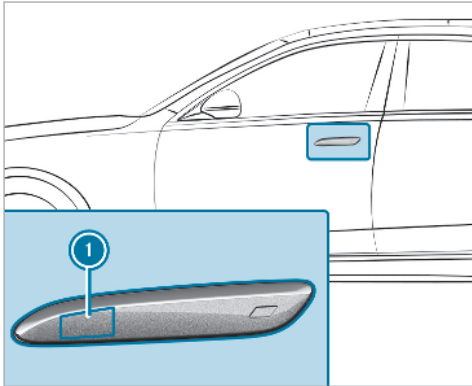

- ▶ Touch the door handle on the driver's door in the area where NFC aerial ❶ is located with the part of the Digital Vehicle Key where the NFC aerial is located.
The vehicle is locked or unlocked alternately.

If you lose the Digital Vehicle Key, deactivate the "Digital Vehicle Key" service in Mercedes me connect via <https://www.mercedes.me>.

Locking/unlocking the vehicle with KEY-LESS-GO

Requirements:

- the key is outside the vehicle
- the distance between the key and the vehicle does not exceed 1 m
- the driver's door and the door at which the door handle is used are closed

In the following cases, the door handles are extended:

- when the vehicle is unlocked
- when the vehicle key is detected
- when a door is opened

In the following cases, the door handles are retracted:

- when the vehicle is locked
- when pulling away
- after waiting for a time

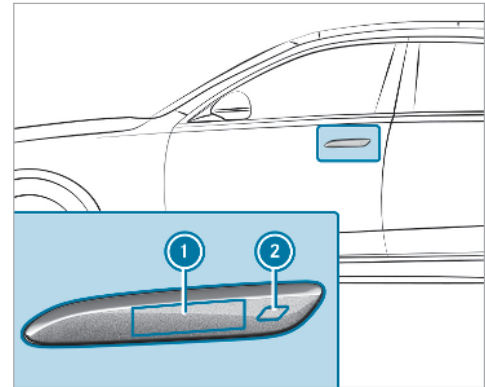

- ▶ **To unlock the vehicle:** touch the inner surface of the door handle.

- ❗ If the door handle is not extended, touch sensor surface ① to unlock.
- ▶ **Convenience closing:** touch recessed sensor surface ② for an extended period.
- ❗ Further information on convenience closing (→ page 85).

If you open the boot lid from outside, the boot lid is automatically unlocked.

Problems with KEYLESS-GO

You can no longer lock or unlock the vehicle using KEYLESS-GO.

Possible causes:

- The key functions have been deactivated (→ page 68).
 - The key battery is weak or discharged.
 - The key is faulty.
- ▶ Activate the key functions (→ page 68).
 - ▶ Check the battery using the indicator lamp and replace if necessary (→ page 69).

- ▶ Use the emergency key to unlock or lock the vehicle (→ page 69).
- ▶ Have the vehicle and key checked at a qualified specialist workshop.

There is interference from a powerful radio signal source.

The KEYLESS-GO function is impaired by, for example:

- high voltage power lines
 - mobile phones
 - electronic devices (Notebooks, Tablets)
 - shielding due to metal objects or induction loops for electrical gate systems or automatic barriers
- ▶ Make sure that there is a sufficient distance between the key and the potential source of interference.

Activating/deactivating the automatic locking feature

The vehicle is locked automatically when the ignition is switched on and the wheels are turning faster than walking pace.

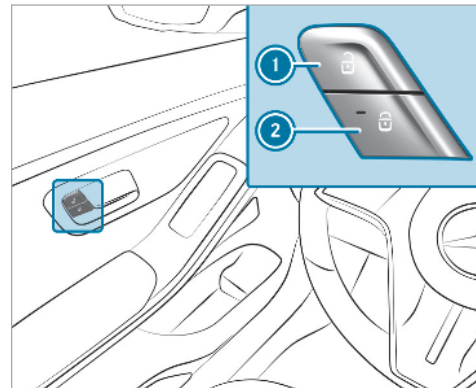

- ▶ **To activate:** press and hold button ② for approximately five seconds until an acoustic signal sounds.

- ▶ **To deactivate:** press and hold button ❶ for approximately five seconds until an acoustic signal sounds.

When the vehicle is locked automatically, the indicator lamp in button ❷ lights up.

In the following situations, there is a danger of being locked out when the function is activated:

- While the vehicle is being tow started/ pushed.
- If the vehicle is being tested on a roller dynamometer.

Power closing function

If you push the door into the lock to the first detent position, the power closing function will automatically pull the door into the lock.

Locking/unlocking the vehicle with the emergency key

Unlocking a left-hand vehicle door with the emergency key element
Vehicles without KEYLESS-GO

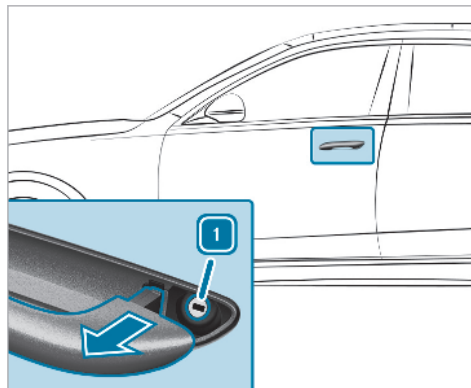

- ▶ Pull and hold the door handle.
- ▶ **To unlock:** turn the emergency key anti-clockwise to position ❶.
- ▶ Release the door handle.

Vehicles with KEYLESS-GO

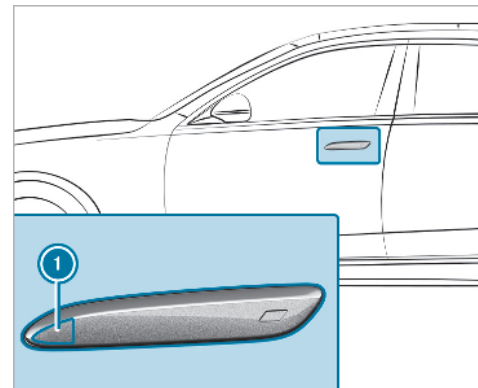

- ▶ **If the door handle is retracted:** press the front area of door handle ❶. The door handle folds slightly outward.
- ▶ Pull and hold the door handle.

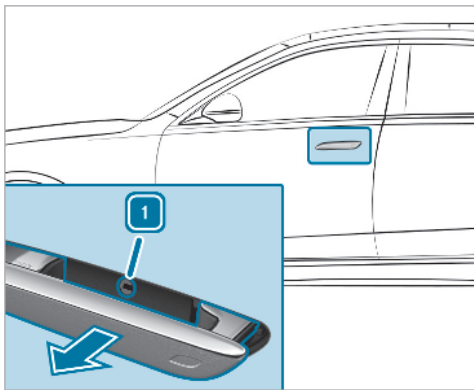

- ▶ **If the door handle is extended:** slightly pull and hold the door handle.
- ▶ **To unlock:** turn the emergency key anti-clockwise to position 1.

Locking the doors with the emergency key

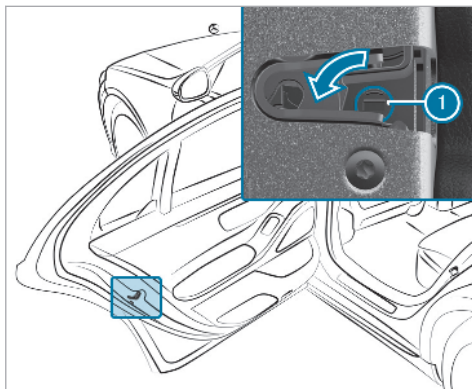

- ▶ Insert a suitable object, e.g. the emergency key, into opening 1 on the door lock.
- ▶ **To lock the left-hand side of the vehicle:** turn the emergency key clockwise as far as it will go.

- ▶ **To lock the right-hand side of the vehicle:** turn the emergency key anti-clockwise as far as it will go.

If the locked door is then closed, it can no longer be opened from outside.

Boot

Opening the boot lid

⚠ DANGER Risk of exhaust gas poisoning

Combustion engines emit poisonous exhaust gases such as carbon monoxide. Exhaust gases can enter the vehicle interior if the boot lid is open when the engine is running, especially if the vehicle is in motion.

- ▶ Always switch off the engine before opening the boot lid.
- ▶ Never drive with the boot lid open.

! **NOTE** Damage to the boot lid by obstacles above the vehicle

The boot lid swings upwards when it is opened.

► Therefore, make sure that there is sufficient clearance above the boot lid.

You have the following options for opening the boot lid:

- Pull the boot lid handle.
- **Vehicles with HANDS-FREE ACCESS:** make a kicking movement with your foot below the bumper (→ page 80).

Vehicles with boot lid convenience closing

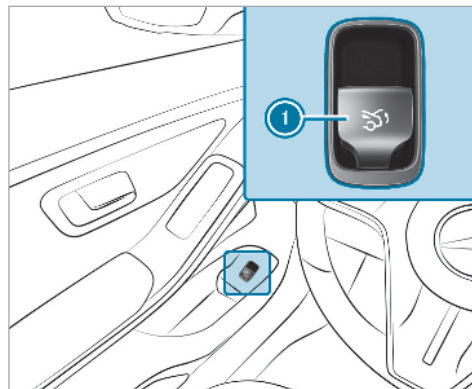

- Pull boot lid remote operating switch ①.
- Press and hold the  button on the key.
- For a boot lid stopped in an intermediate position, pull it upwards and release it as soon as it starts to open. With the boot lid opening limiter activated, manually pull the stopped boot lid upwards.

If an object obstructs the boot lid during the automatic opening process, object recognition will stop the boot lid. The object recognition function is only an aid and is not a substitute for your attentiveness.

Closing the boot lid

! **WARNING** Risk of injury from unsecured items in the vehicle

If objects, luggage or loads are not secured or not secured sufficiently, they could slip, tip over or be thrown around and thereby hit vehicle occupants.

There is a risk of injury, particularly in the event of sudden braking or a sudden change in direction.

- Always stow objects in such a way that they cannot be thrown around.
- Before the journey, secure objects, luggage or loads against slipping or tipping over.

Observe the notes on loading the vehicle.

You have the following options for closing the boot lid:

- ▶ Pull the boot lid downwards using the handle recess and push it closed.
- ⓘ If you lightly push the boot lid closed, the power closing function will automatically pull the boot lid into the lock.

Vehicles with boot lid convenience closing

⚠ WARNING Risk of becoming trapped during automatic closing of the boot lid

Parts of the body could become trapped. There may be people in the closing area.

- ▶ Make sure that nobody is in the vicinity of the closing area.
- ▶ Use one of the following options to stop the closing process:
 - Press the  button on the key.
 - Press or pull the remote operating switch on the driver's door.
 - Press the closing or locking button on the boot lid.

- Pull the boot lid handle.

- ▶ **Vehicles with HANDS-FREE ACCESS:** it is also possible to stop the closing process by making a kicking movement below the rear bumper.

You have the following options for closing the boot lid:

- ▶ Pull the boot lid downwards slightly. Release it as soon as it begins to close.
- ▶ For a boot lid stopped in an intermediate position, push it downwards. The boot lid will continue to close.

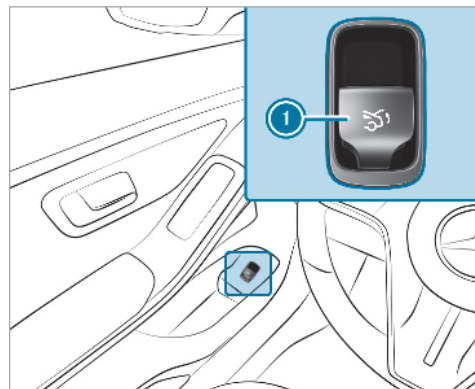

- ▶ Press the remote operating switch for the boot lid ①.

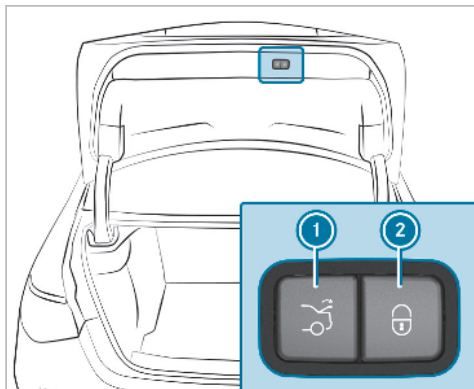

- ▶ Press the closing button ① on the boot lid.

Vehicles with KEYLESS-GO

- ▶ Press the locking button ② on the boot lid. If a key is detected outside the vehicle, the boot lid will close and the vehicle will be locked.

- ▶ With the boot lid completely opened, press and hold the  button on the key (with the key in the vicinity of the vehicle).

Vehicles with HANDS-FREE ACCESS

- ▶ With the boot lid completely opened, make a kicking movement with your foot below the bumper (→ page 80).

Boot lid automatic reversing function

If an object obstructs the boot lid during the automatic closing process, the boot lid will open again automatically. The automatic reversing function is only an aid and is not a substitute for your attentiveness.

- ▶ During the closing process, make sure that no body parts are in the closing area.

⚠ WARNING Risk of becoming trapped despite reversing function

The reversing function will not react:

- to soft, light and thin objects, e.g. fingers
- **towards the end of the closing procedure**

In these situations in particular, the reversing function cannot prevent someone being trapped.

- ▶ **Ensure that no body parts are in the closing area.**
- ▶ If someone is trapped, use one of the following options:
 - Press the  button on the key.
 - Press the remote operating switch on the driver's door.
 - Press the closing or locking button on the boot lid.
 - Pull the boot lid handle.