



Inter**Lab**<sup>®</sup>

FCC Measurement/Technical Report on

Bluetooth transceiver

3G-Sound 9474

**Report Reference:** MDE\_HARMAN\_0904\_FCCa

**Test Laboratory:**

7 layers AG  
Borsigstrasse 11  
40880 Ratingen  
Germany  
email: [info@7Layers.de](mailto:info@7Layers.de)



**Note:**

The following test results relate only to the devices specified in this document. This report shall not be reproduced in parts without the written approval of the testing laboratory.

7 layers AG  
Borsigstrasse 11  
40880 Ratingen, Germany  
Phone: +49 (0) 2102 749 0  
Fax: +49 (0) 2102 749 350  
[www.7Layers.com](http://www.7Layers.com)

Aufsichtsratsvorsitzender •  
Chairman of the Supervisory Board:  
Markus Becker  
Vorstand • Board:  
Dr. Hermann Buitkamp  
Wilfried Klassmann

Registergericht • registered in:  
Düsseldorf, HRB 44096  
USt-IdNr • VAT No.:  
DE 203159652  
TAX No. 147/5869/0385

InterLab<sup>®</sup> is a registered trademark of 7 layers AG



## Table of Contents

<b>0</b>	<b>Summary</b>	<b>3</b>
0.1	Technical Report Summary	3
0.2	Measurement Summary	4
<b>1</b>	<b>Administrative Data</b>	<b>7</b>
1.1	Testing Laboratory	7
1.2	Project Data	7
1.3	Applicant Data	7
1.4	Manufacturer Data	7
<b>2</b>	<b>Test object Data</b>	<b>8</b>
2.1	General EUT Description	8
2.2	EUT Main components	9
2.3	Ancillary Equipment	9
2.4	EUT Setups	9
2.5	Operating Modes	10
2.6	Product labelling	10
<b>3</b>	<b>Test Results</b>	<b>11</b>
3.1	Occupied bandwidth	11
3.2	Peak power output	14
3.3	Spurious RF conducted emissions	17
3.4	Spurious radiated emissions	20
3.5	Band edge compliance	26
3.6	Dwell time	30
3.7	Channel separation	32
3.8	Number of hopping frequencies	34
<b>4</b>	<b>Test Equipment</b>	<b>35</b>
<b>5</b>	<b>Photo Report</b>	<b>41</b>
<b>6</b>	<b>Setup Drawings</b>	<b>44</b>
<b>7</b>	<b>Annex measurement plots</b>	<b>45</b>
7.1	Occupied bandwidth	45
7.2	Peak power output	54
7.3	Band edge compliance conducted and Spurious RF conducted emissions	63
7.4	Band edge compliance radiated	81
7.5	Radiated emissions (f < 30 MHz)	84
7.6	Dwell time	86
7.7	Channel separation	87
7.8	Number of hopping frequencies	88



## **0 Summary**

### **0.1 Technical Report Summary**

#### **Type of Authorization**

Certification for an Intentional Radiator (Frequency Hopping Spread Spectrum).

#### **Applicable FCC Rules**

Prepared in accordance with the requirements of FCC Rules and Regulations as listed in 47 CFR Ch.1 Parts 2 (10-1-08 Edition) and 15 (10-1-08 Edition). The following subparts are applicable to the results in this test report.

Part 2, Subpart J - Equipment Authorization Procedures, Certification

Part 15, Subpart C – Intentional Radiators

§ 15.201 Equipment authorization requirement

§ 15.207 Conducted limits

§ 15.209 Radiated emission limits; general requirements

§ 15.247 Operation within the bands 902-928 MHz, 2400-2483.5 MHz and 5725-5850 MHz

#### **Note:**

The tests were selected and performed with reference to the FCC Public Notice DA 00-705, released March 30, 2000.

Instead of applying ANSI C63.4-1992 which is referenced in the FCC Public Note, the newer ANSI C63.4-2003 is applied.

#### **Summary Test Results:**

**The EUT complied with all performed tests as listed in chapter 0.2 Measurement Summary.**



## 0.2 Measurement Summary

---

### FCC Part 15, Subpart C § 15.207

Conducted emissions (AC power line)			
The measurement was performed according to ANSI C63.4			
<b>OP-Mode</b>	<b>Setup</b>	<b>Port</b>	<b>Final Result</b>
		AC Port (power line)	2003 N/A

---

### FCC Part 15, Subpart C § 15.247 (a) (1)

Occupied bandwidth			
The measurement was performed according to FCC § 15.31			
<b>OP-Mode</b>	<b>Setup</b>	<b>Port</b>	<b>Final Result</b>
op-mode 1	Setup_b01	Temp ant.connector	10-1-08 passed
op-mode 2	Setup_b01	Temp ant.connector	passed
op-mode 3	Setup_b01	Temp ant.connector	passed
op-mode 6	Setup_b01	Temp ant.connector	passed
op-mode 7	Setup_b01	Temp ant.connector	passed
op-mode 8	Setup_b01	Temp ant.connector	passed
op-mode 10	Setup_b01	Temp ant.connector	passed
op-mode 11	Setup_b01	Temp ant.connector	passed
op-mode 12	Setup_b01	Temp ant.connector	passed

---

### FCC Part 15, Subpart C § 15.247 (b) (1)

Peak power output			
The measurement was performed according to FCC § 15.31			
<b>OP-Mode</b>	<b>Setup</b>	<b>Port</b>	<b>Final Result</b>
op-mode 1	Setup_b01	Temp ant.connector	10-1-08 passed
op-mode 2	Setup_b01	Temp ant.connector	passed
op-mode 3	Setup_b01	Temp ant.connector	passed
op-mode 6	Setup_b01	Temp ant.connector	passed
op-mode 7	Setup_b01	Temp ant.connector	passed
op-mode 8	Setup_b01	Temp ant.connector	passed
op-mode 10	Setup_b01	Temp ant.connector	passed
op-mode 11	Setup_b01	Temp ant.connector	passed
op-mode 12	Setup_b01	Temp ant.connector	passed

---

### FCC Part 15, Subpart C § 15.247 (d)

Spurious RF conducted emissions			
The measurement was performed according to FCC § 15.31			
<b>OP-Mode</b>	<b>Setup</b>	<b>Port</b>	<b>Final Result</b>
op-mode 1	Setup_b01	Temp ant.connector	10-1-08 passed
op-mode 2	Setup_b01	Temp ant.connector	passed
op-mode 3	Setup_b01	Temp ant.connector	passed
op-mode 6	Setup_b01	Temp ant.connector	passed
op-mode 7	Setup_b01	Temp ant.connector	passed
op-mode 8	Setup_b01	Temp ant.connector	passed
op-mode 10	Setup_b01	Temp ant.connector	passed
op-mode 11	Setup_b01	Temp ant.connector	passed
op-mode 12	Setup_b01	Temp ant.connector	passed



**FCC Part 15, Subpart C**

**§ 15.247 (d), § 15.35 (b), § 15.209**

Spurious radiated emissions

The measurement was performed according to ANSI C63.4

2003

<b>OP-Mode</b>	<b>Setup</b>	<b>Port</b>	<b>Final Result</b>
op-mode 1	Setup_a01	Enclosure	passed
op-mode 2	Setup_a01	Enclosure	passed
op-mode 3	Setup_a01	Enclosure	passed
op-mode 6	Setup_a01	Enclosure	passed
op-mode 7	Setup_a01	Enclosure	passed
op-mode 8	Setup_a01	Enclosure	passed
op-mode 10	Setup_a01	Enclosure	passed
op-mode 11	Setup_a01	Enclosure	passed
op-mode 12	Setup_a01	Enclosure	passed

**FCC Part 15, Subpart C**

**§ 15.247 (d)**

Band edge compliance

The measurement was performed according to FCC § 15.31  
(10-1-08) / ANSI C63.4 (2003)

10-1-08 / 2003

<b>OP-Mode</b>	<b>Setup</b>	<b>Port</b>	<b>Final Result</b>
op-mode 1	Setup_b01	Temp ant.connector	passed
op-mode 3	Setup_b01	Temp ant.connector	passed
op-mode 3	Setup_a01	Enclosure	passed
op-mode 6	Setup_b01	Temp ant.connector	passed
op-mode 8	Setup_b01	Temp ant.connector	passed
op-mode 8	Setup_a01	Enclosure	passed
op-mode 10	Setup_b01	Temp ant.connector	passed
op-mode 12	Setup_b01	Temp ant.connector	passed
op-mode 12	Setup_a01	Enclosure	passed

<b>FCC Part 15, Subpart C</b>		<b>§ 15.247 (a) (1) (iii)</b>	
Dwell time			
The measurement was performed according to FCC § 15.31		10-1-08	
<b>OP-Mode</b>	<b>Setup</b>	<b>Port</b>	<b>Final Result</b>
op-mode 2	Setup_b01	Temp ant.connector	passed
<b>FCC Part 15, Subpart C</b>		<b>§ 15.247 (a) (1)</b>	
Channel separation			
The measurement was performed according to FCC § 15.31		10-1-08	
<b>OP-Mode</b>	<b>Setup</b>	<b>Port</b>	<b>Final Result</b>
op-mode 4	Setup_b01	Temp ant.connector	passed
<b>FCC Part 15, Subpart C</b>		<b>§ 15.247 (a) (iii)</b>	
Number of hopping frequencies			
The measurement was performed according to FCC § 15.31		10-1-08	
<b>OP-Mode</b>	<b>Setup</b>	<b>Port</b>	<b>Final Result</b>
op-mode 4	Setup_b01	Temp ant.connector	passed

N/A not applicable (the EUT is powered by DC)



7 layers AG, Borsigstr. 11  
40880 Ratingen, Germany  
Phone +49 (0)2102 749 0

Responsible for  
Accreditation Scope:

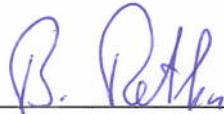

Responsible  
for Test Report:





## 1 Administrative Data

### 1.1 Testing Laboratory

Company Name: 7 Layers AG  
Address Borsigstr. 11  
40880 Ratingen  
Germany

This facility has been fully described in a report submitted to the FCC and accepted under the registration number 96716.

The test facility is also accredited by the following accreditation organisation:  
- Deutscher Akkreditierungs Rat DAR-Registration no. DAT-P-192/99-01

Responsible for Accreditation Scope: Dipl.-Ing. Bernhard Retka  
Dipl.-Ing. Robert Machulec  
Dipl.-Ing. Thomas Hoell  
Dipl.-Ing. Andreas Petz

Report Template Version: 2009-07-27

### 1.2 Project Data

Responsible for testing and report: Dipl.-Ing. Robert Machulec  
Date of Test(s): 2009-09-01 to 2009-11-03  
Date of Report: 2009-11-03

### 1.3 Applicant Data

Company Name: HARMAN/BECKER Automotive Systems GmbH  
Address: Söflinger Strasse 100  
89077 Ulm  
Germany  
Contact Person: Mr. Stefan Blaschek

### 1.4 Manufacturer Data

Company Name: please see applicant data  
Address:  
Contact Person:



## 2 Test object Data

### 2.1 General EUT Description

<b>Equipment under Test</b>	Bluetooth transceiver
<b>Type Designation:</b>	3G-Sound 9474
<b>Kind of Device:</b> <b>(optional)</b>	Bluetooth transceiver build in a head unit of car radio system
<b>Voltage Type:</b>	DC (CAR battery)
<b>Voltage level:</b>	12 V
<b>Modulation Type:</b>	GFSK, 8DPSK, $\pi/4$ DQPSK

#### General product description:

Bluetooth is a short-range radio link intended to be a cable replacement between portable and/or fixed electronic devices.

Bluetooth operates in the unlicensed ISM Band at 2.4 GHz. In the US a band of 83.5 MHz width is available. In this band, the Bluetooth technology defines 79 RF channels spaced 1 MHz (2402 - 2480 MHz). The actual RF channel is chosen from a pseudo-random hopping sequence through the 79 channels. A channel is occupied for a defined amount of time slots, with a nominal slot length of 625  $\mu$ s. The maximum time slot length on one channel is defined by the packet type and is 0.625 ms for DH1 packets, 1.875 ms for DH3 and 3.125 ms for DH5. The nominal hop rate is 1600 hops/s for DH1, 1600/3 for DH3 and 1600/5 for DH5. All frequencies are equally used. The maximum nominal average time of occupancy is 0.4 s within a period of 79\*0.4 seconds.

The basic data rate of 1 Mbps uses GFSK modulation and the enhanced data rate uses PSK modulation. For the enhanced data rate of 3 Mbps 8DPSK modulation and of 2 Mbps  $\pi/4$  DQPSK modulation is used.

#### The EUT provides the following ports:

##### Ports

Temp antenna connector  
Enclosure  
DC Port (power line)

The main components of the EUT are listed and described in Chapter 2.2.





## 2.2 EUT Main components

### Type, S/N, Short Descriptions etc. used in this Test Report

Short Description	Equipment under Test	Type Designation	Serial No.	HW Status	SW Status	Date of Receipt
EUT A (Code: 43070a01)	Bluetooth transceiver	3G-Sound 9474	9474H1097 515379	HW EC 106	Bios controlled	2009-09-01
Remark: EUT A is equipped with an integral antenna (gain = 0 dBi).						
EUT B (Code: 43070b01)	Bluetooth transceiver	3G-Sound 9474	9474H.0975 15381	HW EC 106	Bios controlled	2009-09-01
Remark: EUT B is equipped with a temporary antenna connector.						

**NOTE: The short description is used to simplify the identification of the EUT in this test report.**

## 2.3 Ancillary Equipment

For the purposes of this test report, ancillary equipment is defined as equipment which is used in conjunction with the EUT to provide operational and control features to the EUT. It is necessary to configure the system in a typical fashion, as a customer would normally use it. But nevertheless Ancillary Equipment can influence the test results.

Short Description	Equipment under Test	Type Designation	Serial no.	HW Status	SW Status	FCC ID
-------------------	----------------------	------------------	------------	-----------	-----------	--------

## 2.4 EUT Setups

This chapter describes the combination of EUTs and ancillary equipment used for testing.

Setup No.	Combination of EUTs	Description
Setup_a01	EUT A	setup for radiated measurements
Setup_b01	EUT B	setup for conducted measurements



## 2.5 Operating Modes

This chapter describes the operating modes of the EUTs used for testing.

<b>Op. Mode</b>	<b>Description of Operating Modes</b>	<b>Remarks</b>
op-mode 1	The EUT transmits on 2402 MHz	Loopback mode, basic data rate 1 Mbps
op-mode 2	The EUT transmits on 2441 MHz	Loopback mode, basic data rate 1 Mbps
op-mode 3	The EUT transmits on 2480 MHz	Loopback mode, basic data rate 1 Mbps
op-mode 4	The EUT is in Hopping mode	The EUT is hopping on 79 channels, basic data rate 1 Mbps
op-mode 6	The EUT transmits on 2402 MHz	Loopback mode, enhanced data rate 3 Mbps
op-mode 7	The EUT transmits on 2441 MHz	Loopback mode, enhanced data rate 3 Mbps
op-mode 8	The EUT transmits on 2480 MHz	Loopback mode, enhanced data rate 3 Mbps
op-mode 10	The EUT transmits on 2402 MHz	Loopback mode, enhanced data rate, 2 Mbps
op-mode 11	The EUT transmits on 2441 MHz	Loopback mode, enhanced data rate, 2 Mbps
op-mode 12	The EUT transmits on 2480 MHz	Loopback mode, enhanced data rate, 2 Mbps

## 2.6 Product labelling

### 2.6.1 FCC ID label

Please refer to the documentation of the applicant.

### 2.6.2 Location of the label on the EUT

Please refer to the documentation of the applicant.



## 3 Test Results

### 3.1 Occupied bandwidth

**Standard** FCC Part 15, 10-1-08  
Subpart C

**The test was performed according to:** FCC §15.31, 10-1-08

#### 3.1.1 Test Description

The Equipment Under Test (EUT) was setup to perform the occupied bandwidth measurements.

The reference level is the level of the highest amplitude signal observed from the transmitter at either the fundamental frequency or first-order modulation products in all typical modes of operation, including the unmodulated carrier, even if atypical.

The results recorded were measured with the modulation which produces the worst-case (widest) occupied bandwidth. The resolution bandwidth for measuring the reference level and the occupied bandwidth was 30 kHz.

The EUT was connected to the spectrum analyzer via a short coax cable.

#### 3.1.2 Test Requirements / Limits

FCC Part 15, Subpart C, §15.247 (a) (1)

Frequency hopping systems shall have hopping channel carrier frequencies separated by a minimum of 25 kHz or the 20 dB bandwidth of the hopping channel, whichever is greater. Alternatively, frequency hopping systems operating in the 2400–2483.5 MHz band may have hopping channel carrier frequencies that are separated by 25 kHz or two-thirds of the 20 dB bandwidth of the hopping channel, whichever is greater, provided the systems operate with an output power no greater than 125 mW. The system shall hop to channel frequencies that are selected at the system hopping rate from a pseudo randomly ordered list of hopping frequencies. Each frequency must be used equally on the average by each transmitter. The system receivers shall have input bandwidths that match the hopping channel bandwidths of their corresponding transmitters and shall shift frequencies in synchronization with the transmitted signals.

#### **Implication by the test laboratory:**

Since the Bluetooth technology defines a fixed channel separation of 1 MHz this design parameter defines the maximum allowed occupied bandwidth depending on the EUT's output power:

1. Under the provision that the systems operates with an output power no greater than 125 mW (21.0 dBm):  
Implicit Limit: Max. 20 dB BW =  $1.0 \text{ MHz} / 2/3 = 1.5 \text{ MHz}$
2. If the systems output power exceeds 125 mW (21.0 dBm):  
Implicit Limit: Max. 20 dB BW = 1.0 MHz

Used conversion factor: Output power (dBm) =  $10 \log (\text{Output power (W)} / 1\text{mW})$

The measured output power of the system is below 125 mW (21.0 dBm).

For the results, please refer to the related chapter of this report.

Therefore the limit is determined as 1.5 MHz.



### 3.1.3 Test Protocol

Temperature: 25 °C  
Air Pressure: 998 hPa  
Humidity: 39 %

Op. Mode	Setup	Port
op-mode 1	Setup_b01	Temp ant.connector

20 dB bandwidth MHz	Remarks
0.896	-

Remark: Please see annex for the measurement plot.

Op. Mode	Setup	Port
op-mode 2	Setup_b01	Temp ant.connector

20 dB bandwidth MHz	Remarks
0.896	-

Remark: Please see annex for the measurement plot.

Op. Mode	Setup	Port
op-mode 3	Setup_b01	Temp ant.connector

20 dB bandwidth MHz	Remarks
0.896	-

Remark: Please see annex for the measurement plot.

Op. Mode	Setup	Port
op-mode 6	Setup_b01	Temp ant.connector

20 dB bandwidth MHz	Remarks
1.264	-

Remark: Please see annex for the measurement plot.

Op. Mode	Setup	Port
op-mode 7	Setup_b01	Temp ant.connector

20 dB bandwidth MHz	Remarks
1.270	-

Remark: Please see annex for the measurement plot.



Op. Mode	Setup	Port
op-mode 8	Setup_b01	Temp ant.connector

20 dB bandwidth MHz	Remarks
1.270	-

Remark: Please see annex for the measurement plot.

Op. Mode	Setup	Port
op-mode 10	Setup_b01	Temp ant.connector

20 dB bandwidth MHz	Remarks
1.100	-

Remark: Please see annex for the measurement plot.

Op. Mode	Setup	Port
op-mode 11	Setup_b01	Temp ant.connector

20 dB bandwidth MHz	Remarks
1.112	-

Remark: Please see annex for the measurement plot.

Op. Mode	Setup	Port
op-mode 12	Setup_b01	Temp ant.connector

20 dB bandwidth MHz	Remarks
1.112	-

Remark: Please see annex for the measurement plot.

### 3.1.4 Test result: Occupied bandwidth

FCC Part 15, Subpart C	Op. Mode	Result
	op-mode 1	passed
	op-mode 2	passed
	op-mode 3	passed
	op-mode 6	passed
	op-mode 7	passed
	op-mode 8	passed
	op-mode 10	passed
	op-mode 11	passed
	op-mode 12	passed



## 3.2 Peak power output

**Standard** FCC Part 15, 10-1-08  
Subpart C

**The test was performed according to:** FCC §15.31, 10-1-08

### 3.2.1 Test Description

The Equipment Under Test (EUT) was set up to perform the output power measurements. The resolution bandwidth for measuring the output power was set to 3 MHz. The reference level of the spectrum analyzer was set higher than the output power of the EUT. The EUT was connected to the spectrum analyzer via a short coax cable with a known loss.

### 3.2.2 Test Requirements / Limits

FCC Part 15, Subpart C, §15.247 (b) (1)

(b) The maximum peak conducted output power of the intentional radiator shall not exceed the following:

(1) For frequency hopping systems operating in the 2400-2483.5 MHz band employing at least 75 hopping channels, and all frequency hopping systems in the 5725-5850 MHz band: 1 watt.

Used conversion factor:  $\text{Limit (dBm)} = 10 \log (\text{Limit (W)}/1\text{mW})$   
==> Maximum Output Power: 30 dBm



### 3.2.3 Test Protocol

Temperature: 25 °C  
Air Pressure: 998 hPa  
Humidity: 39 %

Op. Mode	Setup	Port
op-mode 1	Setup_b01	Temp.ant.connector

Output power dBm	Remarks
-0.32	The EIRP including antenna gain (0 dBi) is -0.32 dBm

Remark: Please see annex for the measurement plot.

Op. Mode	Setup	Port
op-mode 2	Setup_b01	Temp.ant.connector

Output power dBm	Remarks
-0.45	The EIRP including antenna gain (0 dBi) is -0.45 dBm

Remark: Please see annex for the measurement plot.

Op. Mode	Setup	Port
op-mode 3	Setup_b01	Temp.ant.connector

Output power dBm	Remarks
-0.30	The EIRP including antenna gain (0 dBi) is -0.30 dBm

Remark: Please see annex for the measurement plot.

Op. Mode	Setup	Port
op-mode 6	Setup_b01	Temp.ant.connector

Output power dBm	Remarks
1.71	The EIRP including antenna gain (0 dBi) is 1.71 dBm

Remark: Please see annex for the measurement plot.

Op. Mode	Setup	Port
op-mode 7	Setup_b01	Temp.ant.connector

Output power dBm	Remarks
1.50	The EIRP including antenna gain (0 dBi) is 1.50 dBm

Remark: Please see annex for the measurement plot.

Op. Mode	Setup	Port
op-mode 8	Setup_b01	Temp.ant.connector

Output power dBm	Remarks
1.26	The EIRP including antenna gain (0dBi) is 1.26 dBm

Remark: Please see annex for the measurement plot.



Op. Mode	Setup	Port
op-mode 10	Setup_b01	Temp.ant.connector

Output power dBm	Remarks
1.32	The EIRP including antenna gain (0 dBi) is x1.32 dBm

Remark: Please see annex for the measurement plot.

Op. Mode	Setup	Port
op-mode 11	Setup_b01	Temp.ant.connector

Output power dBm	Remarks
1.06	The EIRP including antenna gain (0 dBi) is 1.06 dBm

Remark: Please see annex for the measurement plot.

Op. Mode	Setup	Port
op-mode 12	Setup_b01	Temp.ant.connector

Output power dBm	Remarks
0.93	The EIRP including antenna gain (0 dBi) is 0.93 dBm

Remark: Please see annex for the measurement plot.

### 3.2.4 Test result: Peak power output

FCC Part 15, Subpart C	Op. Mode	Result
	op-mode 1	passed
	op-mode 2	passed
	op-mode 3	passed
	op-mode 6	passed
	op-mode 7	passed
	op-mode 8	passed
	op-mode 10	passed
	op-mode 11	passed
	op-mode 12	passed





### 3.3 Spurious RF conducted emissions

**Standard** FCC Part 15, 10-1-08  
Subpart C

**The test was performed according to:** FCC §15.31, 10-1-08

#### 3.3.1 Test Description

The Equipment Under Test (EUT) was set up to perform the spurious emissions measurements.

The EUT was connected to spectrum analyzer via a short coax cable with a known loss.

Analyzer settings:

- Detector: Peak-Maxhold
- Frequency range: 30 – 25000 MHz
- Resolution Bandwidth (RBW): 100 kHz
- Video Bandwidth (VBW): 300 kHz
- Sweep Time: 330 s

The reference value for the measurement of the spurious RF conducted emissions is determined during the test “band edge compliance” (cf. chapter 3.5). This value is used to calculate the 20 dBc limit.

#### 3.3.2 Test Requirements / Limits

FCC Part 15, Subpart C, §15.247 (c)

In any 100 kHz bandwidth outside the frequency band in which the spread spectrum intentional radiator is operating, the radio frequency power that is produced by the intentional radiator shall be at least 20 dB below that in the 100 kHz bandwidth within the band that contains the highest level of the desired power.

### 3.3.3 Test Protocol

Temperature: 25 °C  
 Air Pressure: 998 hPa  
 Humidity: 39 %

Op. Mode	Setup	Port
op-mode 1	Setup_b01	Temp ant.connector

Frequency MHz	Corrected measurement value dBm	Reference value dBm	Limit dBm	Delta to limit dB
4784	-39.91	-1.04	-21.04	18.87

Remark: No (further) spurious emissions in the range 20 dB below the limit found.  
 Please see annex for the measurement plot.

Op. Mode	Setup	Port
op-mode 2	Setup_b01	Temp ant.connector

Frequency MHz	Corrected measurement value dBm	Reference value dBm	Limit dBm	Delta to limit dB
-	-	-0.86	-20.86	-

Remark: No (further) spurious emissions in the range 20 dB below the limit found.  
 Please see annex for the measurement plot.

Op. Mode	Setup	Port
op-mode 3	Setup_b01	Temp ant.connector

Frequency MHz	Corrected measurement value dBm	Reference value dBm	Limit dBm	Delta to limit dB
-	-	-0.76	-20.76	-

Remark: No (further) spurious emissions in the range 20 dB below the limit found.  
 Please see annex for the measurement plot.

Op. Mode	Setup	Port
op-mode 6	Setup_b01	Temp ant.connector

Frequency MHz	Corrected measurement value dBm	Reference value dBm	Limit dBm	Delta to limit dB
-	-	0.93	-19.07	-

Remark: No (further) spurious emissions in the range 20 dB below the limit found.  
 Please see annex for the measurement plot.

Op. Mode	Setup	Port
op-mode 7	Setup_b01	Temp ant.connector

Frequency MHz	Corrected measurement value dBm	Reference value dBm	Limit dBm	Delta to limit dB
-	-	0.65	-19.35	-

Remark: No (further) spurious emissions in the range 20 dB below the limit found.  
 Please see annex for the measurement plot.



Op. Mode	Setup	Port
op-mode 8	Setup_b01	Temp ant.connector

Frequency MHz	Corrected measurement value dBm	Reference value dBm	Limit dBm	Delta to limit dB
-	-	0.49	-19.51	-

Remark: No (further) spurious emissions in the range 20 dB below the limit found.  
Please see annex for the measurement plot.

Op. Mode	Setup	Port
op-mode 10	Setup_b01	Temp ant.connector

Frequency MHz	Corrected measurement value dBm	Reference value dBm	Limit dBm	Delta to limit dB
-	-	0.90	-19.11	-

Remark: No (further) spurious emissions in the range 20 dB below the limit found.  
Please see annex for the measurement plot.

Op. Mode	Setup	Port
op-mode 11	Setup_b01	Temp ant.connector

Frequency MHz	Corrected measurement value dBm	Reference value dBm	Limit dBm	Delta to limit dB
-	-	0.67	-19.33	-

Remark: No (further) spurious emissions in the range 20 dB below the limit found.  
Please see annex for the measurement plot.

Op. Mode	Setup	Port
op-mode 12	Setup_b01	Temp ant.connector

Frequency MHz	Corrected measurement value dBm	Reference value dBm	Limit dBm	Delta to limit dB
-	-	0.44	-19.56	-

Remark: No (further) spurious emissions in the range 20 dB below the limit found.  
Please see annex for the measurement plot.

### 3.3.4 Test result: Spurious RF conducted emissions

FCC Part 15, Subpart C	Op. Mode	Result
	op-mode 1	passed
	op-mode 2	passed
	op-mode 3	passed
	op-mode 6	passed
	op-mode 7	passed
	op-mode 8	passed
	op-mode 10	passed
	op-mode 11	passed
	op-mode 12	passed



### 3.4 Spurious radiated emissions

**Standard** FCC Part 15, 10-1-08  
Subpart C

**The test was performed according to:** ANSI C 63.4, 2003

#### 3.4.1 Test Description

The test set-up was made in accordance to the general provisions of ANSI C 63.4-2003. The Equipment Under Test (EUT) was set up on a non-conductive table 1.0 x 2.0 m in the semi-anechoic chamber. The test was performed at the distance of 3 m between the EUT and the receiving antenna.

The radiated emissions measurements were made in a typical installation configuration. The measurement procedure is implemented into the EMI test software ES-K1 from R&S.

##### 1. Measurement up to 30 MHz

The test set-up was made in accordance to the general provisions of ANSI C 63.4-2003. The Equipment Under Test (EUT) was set up on a non-conductive table in the anechoic chamber.

The radiated emissions measurements were made in a typical installation configuration. The measurement procedure is implemented into the EMI test software ES-K1 from R&S. The Loop antenna HFH2-Z2 is used.

##### **Step 1:** pre-measurement

- Anechoic chamber
- Antenna distance: 10 m
- Detector: Peak-Maxhold
- Frequency range: 0.009 - 0.15 and 0.15 – 30 MHz
- Frequency steps: 0.1 kHz and 5 kHz
- IF-Bandwidth: 0.2 kHz and 10 kHz
- Measuring time / Frequency step: 100 ms

Intention of this step is, to determine the radiated EMI-profile of the EUT. Afterwards the relevant emissions for the final measurement are identified.

##### **Step 2:** final measurement

For the relevant emissions determined in step 1, an additional measurement with the following settings will be performed. Intention of this step is to find the maximum emission level.

- Open area test side
- Antenna distance: according to the Standard
- Detector: Quasi-Peak
- Frequency range: 0.009 – 30 MHz
- Frequency steps: measurement at frequencies detected in step 1
- IF-Bandwidth: 200 Hz - 10 kHz
- Measuring time / Frequency step: 100 ms

##### 2. Measurement above 30 MHz and up to 1 GHz

##### **Step 1:** Preliminary scan

Preliminary test to identify the highest amplitudes relative to the limit.

Settings for step 1:

- Detector: Peak-Maxhold
- Frequency range: 30 – 1000 MHz
- Frequency steps: 60 kHz
- IF-Bandwidth: 120 kHz

- Measuring time / Frequency step: 100  $\mu$ s (BT Timing 1.25 ms)
- Turntable angle range:  $-180$  to  $180^\circ$
- Turntable step size:  $90^\circ$
- Height variation range: 1 – 3 m
- Height variation step size: 2 m
- Polarisation: Horizontal + Vertical

Intention of this step is, to determine the radiated EMI-profile of the EUT. Afterwards the relevant emissions for the final measurement are identified.

**Step 2:** second measurement

For the relevant emissions determined in step 1, an additional measurement with the following settings will be performed. Intention of this step is, to find out the approximate turntable angle and antenna height for each frequency.

- Detector: Peak – Maxhold
- Measured frequencies: in step 1 determined frequencies
- IF – Bandwidth: 120 kHz
- Measuring time: 100 ms
- Turntable angle range:  $-180$  to  $180^\circ$
- Turntable step size:  $45^\circ$
- Height variation range: 1 – 4 m
- Height variation step size: 0.5 m
- Polarisation: horizontal + vertical

After this step the EMI test system has determined the following values for each frequency (of step 1):

- Frequency
- Azimuth value (of turntable)
- Antenna height

The last two values have now the following accuracy:

- Azimuth value (of turntable):  $45^\circ$
- Antenna height: 0.5 m

**Step 3:** final measurement

In this step the accuracy of the turntable azimuth and antenna height will be improved.

This is necessary to find out the maximum value of every frequency.

For each frequency, which was determined the turntable azimuth and antenna height will be adjusted. The turntable azimuth will be slowly varied by  $\pm 22.5^\circ$  around this value.

During this action the value of emission is continuously measured. The turntable azimuth at the highest emission will be recorded and adjusted. In this position the antenna height is also slowly varied by  $\pm 25$  cm around the antenna height determined. During this action the value of emission is also continuously measured. The antenna height of the highest emission will also be recorded and adjusted.

- Detector: Peak – Maxhold
- Measured frequencies: in step 1 determined frequencies
- IF – Bandwidth: 120 kHz
- Measuring time: 100 ms
- Turntable angle range:  $-22.5^\circ$  to  $+ 22.5^\circ$  around the determined value
- Height variation range:  $-0.25$  m to  $+ 0.25$  m around the determined value

**Step 4:** final measurement with QP detector

With the settings determined in step 3, the final measurement will be performed:

EMI receiver settings for step 4:

- Detector: Quasi-Peak ( $< 1$  GHz)
- Measured frequencies: in step 1 determined frequencies
- IF – Bandwidth: 120 kHz
- Measuring time: 1 s



**3. Measurement above 1 GHz**

The following modifications apply to the measurement procedure for the frequency range above 1 GHz:

The measurement distance was reduced to 1 m. The results were extrapolated by the extrapolation factor of 20 dB/decade (inverse linear-distance for field strength measurements, inverse linear-distance squared for the power reference level measurements). Due to the fact that in this frequency range a double ridged wave guided horn antenna (up to 18 GHz) and a horn antenna (18-25 GHz) are used, the steps 2-4 are omitted. Step 1 was performed with one height of the receiving antenna only.

EMI receiver settings:

- Detector: Peak, Average
- RBW = VBW = 100 kHz

After the measurement a plot will be generated which contains a diagram with the results of the preliminary scan and a chart with the frequencies and values of the results of the final measurement.

For the enhanced data rate packets the test is performed as worst-case-check in order to verify that emissions have a comparable level as found at basic data rate. Typically, the measurement for these packets is performed in the frequency range 1 to 8 GHz but it depends on the emissions found during the test for the basic data rate. Please refer to the results for the used frequency range.

**3.4.2 Test Requirements / Limits**

FCC Part 15, Subpart C, §15.247 (d)

... In addition, radiated emissions which fall in the restricted bands, as defined in Section 15.205(a), must also comply with the radiated emission limits specified in Section 15.209(a) (see Section 15.205(c)).

FCC Part 15, Subpart C, §15.209, Radiated Emission Limits

Frequency in MHz	Limit (µV/m)	Measurement distance (m)	Limit(dBµV/m @10m)
0.009 – 0.49	2400/F(kHz)	300	Limit (dBµV/m)+30dB
0.49 – 1.705	24000/F(kHz)	30	Limit (dBµV/m)+10dB
1.705 - 30	30	30	Limit (dBµV/m)+10dB

Frequency in MHz	Limit (µV/m)	Measurement distance (m)	Limit (dBµV/m)
30 - 88	100	3	40.0
88 - 216	150	3	43.5
216 - 960	200	3	46.0
above 960	500	3	54.0

§15.35(b)

..., there is also a limit on the radio frequency emissions, as measured using instrumentation with a peak detector function, corresponding to 20 dB above the maximum permitted average limit....

Used conversion factor: Limit (dBµV/m) = 20 log (Limit (µV/m)/1µV/m)



### 3.4.3 Test Protocol

Temperature: 26 °C  
 Air Pressure: 1016 hPa  
 Humidity: 38 %

#### 3.4.3.1 Measurement up to 30 MHz

Op. Mode	Setup	Port
op-mode 1	Setup_a01	Enclosure

Polarisation	Frequency MHz	Corrected value dBµV/m			Limit dBµV/m	Limit dBµV/m	Limit dBµV/m	Delta to limit dB	Delta to limit dB
		QP	Peak	AV	QP	Peak	AV	QP/Peak	AV
0°	-	-	-	-	-	-	-	-	-
90°	-	-	-	-	-	-	-	-	-

Remark: No (further) spurious emissions in the range 20 dB below the limit found therefore step 2 was not performed. The found peak at 91.2 kHz is emission from loop antenna power supply.

#### 3.4.3.2 Measurement above 30 MHz

Op. Mode	Setup	Port
op-mode 1	Setup_a01	Enclosure

Polarisation	Frequency MHz	Corrected value dBµV/m			Limit dBµV/m	Limit dBµV/m	Limit dBµV/m	Delta to limit dB	Delta to limit dB
		QP	Peak	AV	QP	Peak	AV	QP/Peak	AV
Vertical + horizontal	3354	-	51.51	50.15	-	74	54	22.49	3.85
Vertical + horizontal	4804	-	65.75	53.72	-	-	-	8.25	0.28

Remark: No (further) spurious emissions in the range 20 dB below the limit found.

Op. Mode	Setup	Port
op-mode 2	Setup_a01	Enclosure

Polarisation	Frequency MHz	Corrected value dBµV/m			Limit dBµV/m	Limit dBµV/m	Limit dBµV/m	Delta to limit dB	Delta to limit dB
		QP	Peak	AV	QP	Peak	AV	QP/Peak	AV
Vertical + horizontal	3352	-	49.70	48.26	-	74	54	24.30	5.74
Vertical + horizontal	4882	-	60.29	49.36	-	74	54	13.71	4.64

Remark: No (further) spurious emissions in the range 20 dB below the limit found.



**Op. Mode**      **Setup**                      **Port**  
 op-mode 3      Setup\_a01                      Enclosure

Polarisation	Frequency MHz	Corrected value dBµV/m			Limit dBµV/m	Limit dBµV/m	Limit dBµV/m	Delta to limit dB	Delta to limit dB
		QP	Peak	AV	QP	Peak	AV	QP/Peak	AV
Vertical + horizontal	2483.5	-	56.84	44.11	-	74	54	17.16	9.89
Vertical + horizontal	3352	-	50.22	49.16	-	74	54	23.78	4.84
Vertical + horizontal	4960	-	59.43	48.38	-	74	54	14.57	5.62

Remark: No (further) spurious emissions in the range 20 dB below the limit found.

**Op. Mode**      **Setup**                      **Port**  
 op-mode 6      Setup\_a01                      Enclosure

Polarisation	Frequency MHz	Corrected value dBµV/m			Limit dBµV/m	Limit dBµV/m	Limit dBµV/m	Delta to limit dB	Delta to limit dB
		QP	Peak	AV	QP	Peak	AV	QP/Peak	AV
Vertical + horizontal	3352	-	49.27	47.88	-	74	54	24.73	6.12
Vertical + horizontal	4804	-	60.59	43.44	-	74	54	13.41	10.56

Remark: No (further) spurious emissions in the range 20 dB below the limit found.

The measurement was performed from 1 GHz up to 8 GHz because no significant spurious emissions were found outside this frequency range in op-mode 1, 2 and 3.

**Op. Mode**      **Setup**                      **Port**  
 op-mode 7      Setup\_a01                      Enclosure

Polarisation	Frequency MHz	Corrected value dBµV/m			Limit dBµV/m	Limit dBµV/m	Limit dBµV/m	Delta to limit dB	Delta to limit dB
		QP	Peak	AV	QP	Peak	AV	QP/Peak	AV
Vertical + horizontal	3352	-	48.84	47.32	-	74	54	25.16	6.68
Vertical + horizontal	4882	-	53.82	35.20	-	74	54	20.18	18.80

Remark: No (further) spurious emissions in the range 20 dB below the limit found.

The measurement was performed from 1 GHz up to 8 GHz because no significant spurious emissions were found outside this frequency range in op-mode 1, 2 and 3.

**Op. Mode**      **Setup**                      **Port**  
 op-mode 8      Setup\_a01                      Enclosure

Polarisation	Frequency MHz	Corrected value dBµV/m			Limit dBµV/m	Limit dBµV/m	Limit dBµV/m	Delta to limit dB	Delta to limit dB
		QP	Peak	AV	QP	Peak	AV	QP/Peak	AV
Vertical + horizontal	2483.5	-	60.04	44.17	-	74	54	13.96	9.83
Vertical + horizontal	3352	-	49.70	48.49	-	74	54	24.30	5.51
Vertical + horizontal	4882	-	53.86	37.39	-	74	54	20.14	16.61

Remark: No (further) spurious emissions in the range 20 dB below the limit found.

The measurement was performed from 1 GHz up to 8 GHz because no significant spurious emissions were found outside this frequency range in op-mode 1, 2 and 3.





**Op. Mode**      **Setup**                      **Port**  
 op-mode 10      Setup\_a01                      Enclosure

Polarisation	Frequency MHz	Corrected value dBµV/m			Limit dBµV/m	Limit dBµV/m	Limit dBµV/m	Delta to limit dB	Delta to limit dB
		QP	Peak	AV	QP	Peak	AV	QP/Peak	AV
Vertical + horizontal	3352	-	50.09	48.88	-	74	54	23.91	5.12
Vertical + horizontal	4804	-	60.70	44.11	-	74	54	13.30	9.89

Remark: No (further) spurious emissions in the range 20 dB below the limit found.  
 The measurement was performed from 1 GHz up to 8 GHz because no significant spurious emissions were found outside this frequency range in op-mode 1, 2 and 3.

**Op. Mode**      **Setup**                      **Port**  
 op-mode 11      Setup\_a01                      Enclosure

Polarisation	Frequency MHz	Corrected value dBµV/m			Limit dBµV/m	Limit dBµV/m	Limit dBµV/m	Delta to limit dB	Delta to limit dB
		QP	Peak	AV	QP	Peak	AV	QP/Peak	AV
Vertical + horizontal	3352	-	50.22	49.03	-	74	54	23.78	4.97
Vertical + horizontal	4882	-	53.44	33.75	-	74	54	20.56	20.25

Remark: No (further) spurious emissions in the range 20 dB below the limit found.  
 The measurement was performed from 1 GHz up to 8 GHz because no significant spurious emissions were found outside this frequency range in op-mode 1, 2 and 3.

**Op. Mode**      **Setup**                      **Port**  
 op-mode 12      Setup\_a01                      Enclosure

Polarisation	Frequency MHz	Corrected value dBµV/m			Limit dBµV/m	Limit dBµV/m	Limit dBµV/m	Delta to limit dB	Delta to limit dB
		QP	Peak	AV	QP	Peak	AV	QP/Peak	AV
Vertical + horizontal	2483.5	-	59.56	41.16	-	74	54	14.44	12.84
Vertical + horizontal	3352	-	49.95	48.83	-	74	54	24.05	5.17
Vertical + horizontal	4882	-	50.96	34.41	-	74	54	23.04	19.59

Remark: No (further) spurious emissions in the range 20 dB below the limit found.  
 The measurement was performed from 1 GHz up to 8 GHz because no significant spurious emissions were found outside this frequency range in op-mode 1, 2 and 3.

### 3.4.4 Test result: Spurious radiated emissions

FCC Part 15, Subpart C	Op. Mode	Result
	op-mode 1	passed
	op-mode 2	passed
	op-mode 3	passed
	op-mode 6	passed
	op-mode 7	passed
	op-mode 8	passed
	op-mode 10	passed
	op-mode 11	passed
	op-mode 12	passed



### 3.5 Band edge compliance

**Standard** FCC Part 15, 10-1-08  
Subpart C

**The test was performed according to:** ANSI C 63.4, 2003  
FCC §15.31, 10-1-08

#### 3.5.1 Test Description

The procedure to show compliance with the band edge requirement is divided into two measurements: 1. Show compliance of the lower band edge by a conducted measurement and 2. show compliance of the higher band edge by a radiated and conducted measurement.

For the first measurement the EUT is set to transmit on the lowest channel (2402 MHz). The lower band edge is 2400 MHz.

Analyzer settings:

- Detector: Peak
- RBW= 100 kHz
- VBW= 300 kHz

For the second measurement the EUT is set to transmit on the highest channel (2480 MHz). The higher band edge is 2483.5 MHz.

Analyzer settings for conducted measurement:

- Detector: Peak
- RBW= 100 kHz
- VBW= 300 kHz

Analyzer settings for radiated measurement:

- Detector: Peak, Average
- RBW = VBW = 100 kHz

#### 3.5.2 Test Requirements / Limits

FCC Part 15.247 (d)

"In any 100 kHz bandwidth outside the frequency band in which the spread spectrum or digitally modulated intentional radiator is operating, the radio frequency power that is produced by the intentional radiator shall be at least 20 dB below that in the 100 kHz bandwidth within the band that contains the highest level of the desired power, based on either an RF conducted or a radiated measurement, provided the transmitter demonstrates compliance with the peak conducted power limits.

...

Attenuation below the general limits specified in Section 15.209(a) is not required. In addition, radiated emissions which fall in the restricted bands, as defined in Section 15.205(a), must also comply with the radiated emission limits specified in Section 15.209(a) (see Section 15.205(c))."

For the measurement of the **lower band edge** the RF power at the band edge shall be "at least 20 dB below that in the 100 kHz bandwidth within the band that contains the highest level of the desired power..."

For the measurement of the **higher band edge** the limit is "specified in Section 15.209(a)".



### 3.5.3 Test Protocol

#### 3.5.3.1 Lower band edge

##### Conducted measurement

Temperature: 25 °C  
Air Pressure: 998 hPa  
Humidity: 39 %

Op. Mode	Setup	Port
op-mode 1	Setup_b01	Temp ant.connector

Frequency MHz	Measured value dBm	Reference value dBm	Limit dBm	Delta to limit dB
2400.00	-44.95	-1.04	-21.04	23.91

Remark: Please see annex for the measurement plot.

Op. Mode	Setup	Port
op-mode 6	Setup_b01	Temp ant.connector

Frequency MHz	Measured value dBm	Reference value dBm	Limit dBm	Delta to limit dB
2400.00	-42.58	0.93	-19.07	23.51

Remark: Please see annex for the measurement plot.

Op. Mode	Setup	Port
op-mode 10	Setup_b01	Temp ant.connector

Frequency MHz	Measured value dBm	Reference value dBm	Limit dBm	Delta to limit dB
2400.00	-43.99	0.90	-19.11	24.88

Remark: Please see annex for the measurement plot.

### 3.5.3.2 Higher band edge

#### Conducted measurement

Temperature: 25 °C  
 Air Pressure: 998 hPa  
 Humidity: 39 %

Op. Mode	Setup	Port
op-mode 3	Setup_b01	Temp ant.connector

Frequency MHz	Measured value dBm	Reference value dBm	Limit dBm	Delta to limit dB
2483.50	-43.37	-0.76	-20.76	22.61

Remark: Please see annex for the measurement plot.

Op. Mode	Setup	Port
op-mode 8	Setup_b01	Temp ant.connector

Frequency MHz	Measured value dBm	Reference value dBm	Limit dBm	Delta to limit dB
2483.50	-42.85	0.49	-19.51	23.34

Remark: Please see annex for the measurement plot.

Op. Mode	Setup	Port
op-mode 12	Setup_b01	Temp ant.connector

Frequency MHz	Measured value dBm	Reference value dBm	Limit dBm	Delta to limit dB
2483.50	-42.16	0.44	-19.56	22.60

Remark: Please see annex for the measurement plot.



**Radiated measurement**

Temperature: 26 °C  
 Air Pressure: 1016 hPa  
 Humidity: 38 %

Op. Mode	Setup	Port
op-mode 3	Setup_a01	Enclosure

Frequency MHz	Polarisation	Corrected value dBµV/m		Limit Peak dBµV/m	Limit AV dBµV/m	Delta to Peak limit/dB	Delta to AV limit dB
		Peak	AV				
2483.50	Vertical + horizontal	56.84	42.30	74.00	54.00	17.16	11.70

Remark: Please see annex for the measurement plot.

Op. Mode	Setup	Port
op-mode 8	Setup_a01	Enclosure

Frequency MHz	Polarisation	Corrected value dBµV/m		Limit Peak dBµV/m	Limit AV dBµV/m	Delta to Peak limit/dB	Delta to AV limit dB
		Peak	AV				
2483.50	Vertical + horizontal	60.04	44.17	74.00	54.00	13.96	9.83

Remark: Please see annex for the measurement plot.

Op. Mode	Setup	Port
op-mode 12	Setup_a01	Enclosure

Frequency MHz	Polarisation	Corrected value dBµV/m		Limit Peak dBµV/m	Limit AV dBµV/m	Delta to Peak limit/dB	Delta to AV limit dB
		Peak	AV				
2483.50	Vertical + horizontal	59.56	41.16	74.00	54.00	14.44	12.84

Remark: Please see annex for the measurement plot.

**3.5.4 Test result: Band edge compliance**

FCC Part 15, Subpart C	Op. Mode	Result
	op-mode 1	passed
	op-mode 3	passed
	op-mode 6	passed
	op-mode 8	passed
	op-mode 10	passed
	op-mode 12	passed



### 3.6 Dwell time

**Standard** FCC Part 15, 10-1-08  
Subpart C

**The test was performed according to:** FCC §15.31, 10-1-08

#### 3.6.1 Test Description

The Equipment Under Test (EUT) was set up to perform the dwell time measurements. The EUT was connected to the spectrum analyzer via a short coax cable. The dwell time is calculated by:

Dwell time = time slot length \* hop rate / number of hopping channels \* 31.6 s

with:

- hop rate =  $1600 * 1/s$  for DH1 packets =  $1600 \text{ s}^{-1}$
- hop rate =  $1600/3 * 1/s$  for DH3 packets =  $533.33 \text{ s}^{-1}$
- hop rate =  $1600/5 * 1/s$  for DH5 packets =  $320 \text{ s}^{-1}$
- number of hopping channels = 79
- $31.6 \text{ s} = 0.4 \text{ seconds multiplied by the number of hopping channels} = 0.4 \text{ s} * 79$

The following shortcuts are used for the different packet types:

- Basic data rate, 1 Mbps: DH1, DH3, DH5
- Enhanced data rate, 3 Mbps: 3-DH1, 3-DH3, 3-DH5
- Enhanced data rate, 2 Mbps: 2-DH1, 2-DH3, 2-DH5

The worst case value is reported.

#### 3.6.2 Test Requirements / Limits

FCC Part 15, Subpart C, §15.247 (a) (1) (iii)

Frequency hopping systems in the 2400-2483.5 MHz band shall use at least 15 channels. The average time of occupancy on any channel shall not be greater than 0.4 seconds within a period of 0.4 seconds multiplied by the number of hopping channels employed. Since the Bluetooth technology uses 79 channels this period is calculated to be 31.6 seconds.



### 3.6.3 Test Protocol

Temperature: 25 °C  
Air Pressure: 998 hPa  
Humidity: 39 %

Op. Mode	Setup	Port
op-mode 2	Setup_b01	Temp ant.connector

Packet type	Time slot length ms	Dwell time	Dwell time ms
DH5	2.926	time slot length * 1600/5/79*31.6	375

Remark: Please see annex for the measurement plots.

### 3.6.4 Test result: Dwell time

FCC Part 15, Subpart C	Op. Mode	Result
	op-mode 2	passed



### 3.7 Channel separation

**Standard** FCC Part 15, 10-1-08  
Subpart C

**The test was performed according to:** FCC §15.31, 10-1-08

#### 3.7.1 Test Description

The Equipment Under Test (EUT) was set up to perform the channel separation measurements. The channel separation is independent from the modulation pattern. The EUT was connected to spectrum analyzer via a short coax cable.

Analyzer settings:

- Detector: Peak-Maxhold
- Span: 3 MHz
- Centre Frequency: 2442 MHz
- Resolution Bandwidth (RBW): 30 kHz
- Video Bandwidth (VBW): 100 kHz
- Sweep Time: Coupled

#### 3.7.2 Test Requirements / Limits

FCC Part 15, Subpart C, §15.247 (a) (1)

Frequency hopping systems shall have hopping channel carrier frequencies separated by a minimum of 25 kHz or the 20 dB bandwidth of the hopping channel, whichever is greater. Alternatively, frequency hopping systems operating in the 2400–2483.5 MHz band may have hopping channel carrier frequencies that are separated by 25 kHz or two-thirds of the 20 dB bandwidth of the hopping channel, whichever is greater, provided the systems operate with an output power no greater than 125 mW. The system shall hop to channel frequencies that are selected at the system hopping rate from a pseudo randomly ordered list of hopping frequencies. Each frequency must be used equally on the average by each transmitter. The system receivers shall have input bandwidths that match the hopping channel bandwidths of their corresponding transmitters and shall shift frequencies in synchronization with the transmitted signals.





### 3.7.3 Test Protocol

Temperature: 25 °C  
Air Pressure: 998 hPa  
Humidity: 39 %

Op. Mode	Setup	Port
op-mode 4	Setup_b01	Temp ant.connector

Channel separation MHz	Remarks
1.000	-

Remark: Please see annex for the measurement plot.

### 3.7.4 Test result: Channel separation

FCC Part 15, Subpart C	Op. Mode	Result
	op-mode 4	passed



### 3.8 Number of hopping frequencies

**Standard** FCC Part 15, 10-1-08  
Subpart C

**The test was performed according to:** FCC §15.31, 10-1-08

#### 3.8.1 Test Description

The Equipment Under Test (EUT) was set up to perform the number of hopping frequencies measurement. The number of hopping frequencies is independent from the modulation pattern.

The EUT was connected to spectrum analyzer via a short coax cable.

Analyzer settings:

- Detector: Peak-Maxhold
- Centre frequency: 2442 MHz
- Frequency span: 84 MHz
- Resolution Bandwidth (RBW): 100 kHz
- Video Bandwidth (VBW): 300 kHz
- Sweep Time: Coupled

#### 3.8.2 Test Requirements / Limits

FCC Part 15, Subpart C, §15.247 (a) (iii)

Frequency hopping systems in the 2400-2483.5 MHz band shall use at least 15 channels.

#### 3.8.3 Test Protocol

Temperature: 25 °C  
Air Pressure: 998 hPa  
Humidity: 39 %

Op. Mode	Setup	Port
op-mode 4	Setup_b01	Temp ant.connector

Number of hopping channels	Remarks
79	-

Remark: Please see annex for the measurement plot.

#### 3.8.4 Test result: Number of hopping frequencies

FCC Part 15, Subpart C	Op. Mode	Result
	op-mode 4	passed



## 4 Test Equipment

### Test Equipment Anechoic Chamber

<b>Lab ID:</b>	<b>Lab 2</b>		
<b>Manufacturer:</b>	Frankonia		
<b>Description:</b>	Anechoic Chamber for radiated testing		
<b>Type:</b>	10.58x6.38x6		
	<i>Calibration Details</i>	<i>Last Execution</i>	<i>Next Exec.</i>
	IC renewal	2009/01/21	2011/01/20
	FCC renewal	2009/01/07	2011/01/06

### Single Devices for Anechoic Chamber

<i>Single Device Name</i>	<i>Type</i>	<i>Serial Number</i>	<i>Manufacturer</i>
Air compressor	none	-	Atlas Copco
Anechoic Chamber	10.58 x 6.38 x 6	none	Frankonia
	<i>Calibration Details</i>		<i>Last Execution</i> <i>Next Exec.</i>
	FCC listing 96716 3m Part15/18		2009/01/07 2011/01/06
	ANSI C64.3 NSA		2009/01/21 2011/01/20
Controller Innco 2000	CO 2000	CO2000/328/12470 406/L	Innco innovative constructions GmbH
EMC camera	CE-CAM/1	-	CE-SYS
EMC camera Nr.2	CCD-400E	0005033	Mitsubishi
Filter ISDN	B84312-C110-E1		Siemens&Matsushita
Filter Universal 1A	BB4312-C30-H3	-	Siemens&Matsushita



## Test Equipment Auxiliary Equipment for Radiated emissions

**Lab ID:** Lab 2  
**Description:** Equipment for emission measurements  
**Serial Number:** see single devices

### Single Devices for Auxiliary Equipment for Radiated emissions

Single Device Name	Type	Serial Number	Manufacturer		
Antenna mast	AS 620 P		HD GmbH		
Biconical dipole	VUBA 9117	9117108	Schwarzbeck	<i>Last Execution</i>	<i>Next Exec.</i>
	Standard Calibration			2008/10/27	2013/10/26
Broadband Amplifier 18MHz-26GHz	JS4-18002600-32-5P	849785	Miteq		
	Calibration Details			<i>Last Execution</i>	<i>Next Exec.</i>
Broadband Amplifier 1GHz-4GHz	AFS4-01000400-1Q-10P-4	-	Miteq		
	Calibration Details			<i>Last Execution</i>	<i>Next Exec.</i>
Broadband Amplifier 30MHz-18GHz	JS4-00101800-35-5P	896037	Miteq		
	Calibration Details			<i>Last Execution</i>	<i>Next Exec.</i>
Cable "ESI to EMI Antenna"	EcoFlex10	W18.01-2+W38.01-2	Kabel Kusch		
	Calibration Details			<i>Last Execution</i>	<i>Next Exec.</i>
Cable "ESI to Horn Antenna"	UFB311A+UFB293C	W18.02-2+W38.02-2	Rosenberger Micro-Coax		
	Calibration Details			<i>Last Execution</i>	<i>Next Exec.</i>
Double-ridged horn	HF 906	357357/001	Rohde & Schwarz GmbH & Co. KG		
	Calibration Details			<i>Last Execution</i>	<i>Next Exec.</i>
Double-ridged horn	HF 906	357357/002	Rohde & Schwarz GmbH & Co. KG		
	Calibration Details			<i>Last Execution</i>	<i>Next Exec.</i>
Dreheinheit	DE 325		HD GmbH		
	Standard Calibration			2009/04/16	2012/04/15
High Pass Filter	4HC1600/12750-1.5-KK	9942011	Trilithic		
	Calibration Details			<i>Last Execution</i>	<i>Next Exec.</i>
High Pass Filter	5HC2700/12750-1.5-KK	9942012	Trilithic		
	Calibration Details			<i>Last Execution</i>	<i>Next Exec.</i>
High Pass Filter	5HC3500/12750-1.2-KK	200035008	Trilithic		
	Calibration Details			<i>Last Execution</i>	<i>Next Exec.</i>
Log.-per. Antenna	HL 562 Ultralog	830547/003	Rohde & Schwarz GmbH & Co. KG		
	Calibration Details			<i>Last Execution</i>	<i>Next Exec.</i>
	Standard Calibration			2009/05/27	2012/05/26



**Single Devices for Auxiliary Equipment for Radiated emissions (continued)**

Single Device Name	Type	Serial Number	Manufacturer
Loop Antenna	HFH2-Z2	829324/006	Rohde & Schwarz GmbH & Co. KG
	<i>Calibration Details</i>		<i>Last Execution</i> <i>Next Exec.</i>
	DKD calibration		2008/10/07    2011/10/06
Pyramidal Horn Antenna 26,5 GHz	3160-09	00083069	EMCO Elektronik GmbH
Pyramidal Horn Antenna 40 GHz	3160-10	00086675	EMCO Elektronik GmbH

**Test Equipment Digital Signalling Devices**

**Lab ID:** Lab 2  
**Description:** Signalling equipment for various wireless technologies.

**Single Devices for Digital Signalling Devices**

Single Device Name	Type	Serial Number	Manufacturer	
Bluetooth Signalling Unit CBT	1153.9000.35	100302	Rohde & Schwarz GmbH & Co. KG	
	<i>Calibration Details</i>		<i>Last Execution</i> <i>Next Exec.</i>	
	Standard Calibration		2009/04/28    2011/04/27	
Digital Radio Communication Tester	CMD 55	831050/020	Rohde & Schwarz GmbH & Co. KG	
	<i>Calibration Details</i>		<i>Last Execution</i> <i>Next Exec.</i>	
	standard calibration		2008/10/07    2010/10/06	
Digital Radio Test Set	6103E	2359	Racal Instruments, Ltd.	
Universal Radio Communication Tester	CMU 200	837983/052	Rohde & Schwarz GmbH & Co. KG	
	<i>Calibration Details</i>		<i>Last Execution</i> <i>Next Exec.</i>	
	Standard calibration		2008/12/01    2011/11/30	
	<i>HW/SW Status</i>		<i>Date of Start</i> <i>Date of End</i>	
	HW options: B11, B21V14, B21-2, B41, B52V14, B52-2, B53-2, B54V14, B56V14, B68 3v04, B95, PCMCIA, U65V02 SW options: K21 4v11, K22 4v11, K23 4v11, K24 4v11, K27 4v10, K28 4v10, K42 4v11, K43 4v11, K53 4v10, K65 4v10, K66 4v10, K68 4v10, Firmware: µP1 8v40 01.12.05 ---		2007/01/02	
	SW: K62, K69		2008/11/03	
Vector Signal Generator	SMU200A	100912	Rohde & Schwarz GmbH & Co. KG	
	<i>Calibration Details</i>		<i>Last Execution</i> <i>Next Exec.</i>	
	standard calibration		2008/10/28    2011/10/27	



**Test Equipment Emission measurement devices**

**Lab ID:** Lab 2  
**Description:** Equipment for emission measurements  
**Serial Number:** see single devices

**Single Devices for Emission measurement devices**

<i>Single Device Name</i>	<i>Type</i>	<i>Serial Number</i>	<i>Manufacturer</i>	
Personal Computer	Dell		Dell	
Signal Generator	SMR 20	846834/008	Rohde & Schwarz GmbH & Co. KG	
	<i>Calibration Details</i>		<i>Last Execution</i>	<i>Next Exec.</i>
	Standard Calibration		2007/12/05	2010/12/04
Spectrum Analyzer	ESIB 26	830482/004	Rohde & Schwarz GmbH & Co. KG	
	<i>Calibration Details</i>		<i>Last Execution</i>	<i>Next Exec.</i>
	Standard Calibration		2007/12/06	2009/12/05



**Test Equipment InterLab Bluetooth RF Test Solution - Setup C**

**Lab ID:** Lab 1  
**Manufacturer:** 7 layers, Inc.  
**Description:** Bluetooth BDR and EDR RF Conformance Test System  
**Type:** InterLab BT RF

<i>HW/SW Status</i>	<i>Date of Start</i>	<i>Date of End</i>
Bluetooth RF Test Solution ( version 2.3.4 package 1)	2009/03/25	2009/06/03
Bluetooth RF Test Solution ( version 2.3.4 package 2)	2009/06/03	

**Single Devices for InterLab Bluetooth RF Test Solution - Setup C**

<i>Single Device Name</i>	<i>Type</i>	<i>Serial Number</i>	<i>Manufacturer</i>
ADU 200 Relay Box 7	Relay Box	A04380	Ontrak Control Systems Inc.
Bluetooth Signalling Unit CBT CBT		100589	Rohde & Schwarz GmbH & Co. KG
	<i>Calibration Details</i>		<i>Last Execution</i> <i>Next Exec.</i>
	Standard Calibration		2009/08/06 2010/08/05
Power Meter NRVD	857.8008.02	832025/059	
	<i>Calibration Details</i>		<i>Last Execution</i> <i>Next Exec.</i>
	Standard Calibration		2009/06/23 2010/06/22
Power Sensor NRV Z1 A	828.3018.03	832279/013	
	<i>Calibration Details</i>		<i>Last Execution</i> <i>Next Exec.</i>
	Standard Calibration		2009/06/23 2010/06/22
Power Supply	NGSM 32/10	2725	
	<i>Calibration Details</i>		<i>Last Execution</i> <i>Next Exec.</i>
	Standard Calibration		2009/04/28 2010/04/27
Rubidium Frequency Normal MFS	828.3018.03	002	Datum GmbH
	<i>Calibration Details</i>		<i>Last Execution</i> <i>Next Exec.</i>
	Standard Calibration		2009/06/23 2010/06/22
Signal Analyser FSIQ26	1119.6001.26	832695/007	Rohde & Schwarz GmbH & Co.KG
	<i>Calibration Details</i>		<i>Last Execution</i> <i>Next Exec.</i>
	Standard Calibration		2009/06/24 2011/06/23
Signal Generator SMP 03	1035.5005.03	833680/003	
	<i>Calibration Details</i>		<i>Last Execution</i> <i>Next Exec.</i>
	Standard Calibration		2009/06/23 2012/06/22
ThermoHygro DataloggerOpus10 THI (8152.00) 04 (Environ)		7481	Lufft Mess- und Regeltechnik GmbH
	<i>Calibration Details</i>		<i>Last Execution</i> <i>Next Exec.</i>
	Standard calibration		2009/01/23 2010/01/22
TOCT Switching Unit	Switching Unit	030106	7 layers, Inc.
Vector Signal Generator SMIQ03B B	1125.5555.03	832870/017	
	<i>Calibration Details</i>		<i>Last Execution</i> <i>Next Exec.</i>
	Standard		2007/05/24 2010/05/23



### Test Equipment Multimeter 12

**Lab ID:** Lab 1  
**Description:** Ex-Tech 520  
**Serial Number:** 05157876

#### Single Devices for Multimeter 12

Single Device Name	Type	Serial Number	Manufacturer
Digital Multimeter 12 (Multimeter)	EX520	05157876	Extech Instruments Corp.

### Test Equipment Power Supply 04

**Lab ID:** Lab 1  
**Manufacturer:** Rohde & Schwarz GmbH & Co.KG  
**Description:** NGSM 32/10  
**Type:** Power Supply  
**Serial Number:** 3725

Calibration Details	Last Execution	Next Exec.
Standard calibration	2009/04/28	2010/04/27

### Test Equipment Shielded Room 07

**Lab ID:** Lab 1  
**Description:** Shielded Room 4m x 6m

### Test Equipment T/H Logger 04

**Lab ID:** Lab 1  
**Description:** Luft Opus10  
**Serial Number:** 7481

#### Single Devices for T/H Logger 04

Single Device Name	Type	Serial Number	Manufacturer
ThermoHygro DataloggerOpus10 THI (8152.00) 04 (Environ)		7481	Luft Mess- und Regeltechnik GmbH

Calibration Details	Last Execution	Next Exec.
Standard calibration	2009/01/23	2010/01/22

### Test Equipment Temperature Chamber 01

**Lab ID:** Lab 1  
**Manufacturer:** see single devices  
**Description:** Temperature Chamber KWP 120/70  
**Type:** Weiss  
**Serial Number:** see single devices

#### Single Devices for Temperature Chamber 01

Single Device Name	Type	Serial Number	Manufacturer
Temperature Chamber Weiss 01	KWP 120/70	59226012190010	Weiss Umwelttechnik GmbH

Calibration Details	Last Execution	Next Exec.
Specific calibration	2009/03/12	2010/03/11



## 5 Photo Report



**Photo 1:** Test setup for radiated measurements (Enclosure, below 30 MHz)

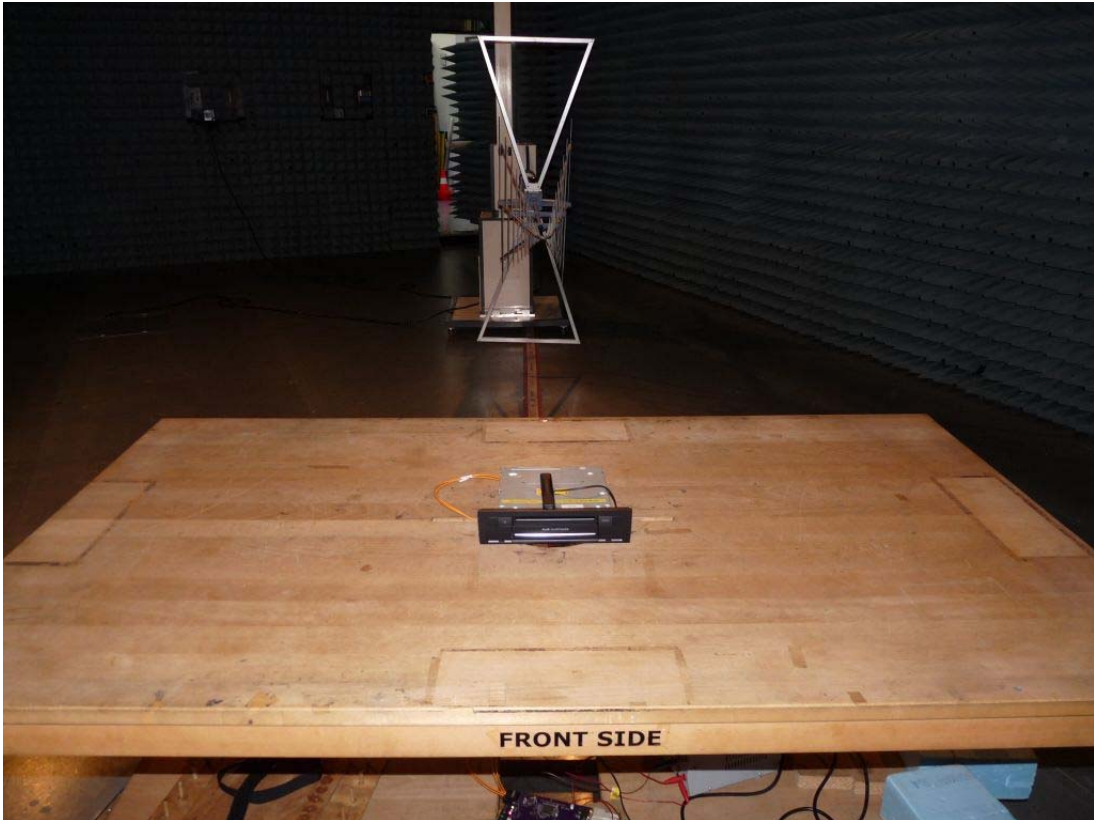

**Photo 2:** Test setup for radiated measurements (Enclosure, 30 MHz to 1 GHz)



**Photo 3:** Test setup for radiated measurements (Enclosure, above 1 GHz)



**Photo 4:** EUT (front side)



**Photo 5:** EUT (rear side)



## 6 Setup Drawings

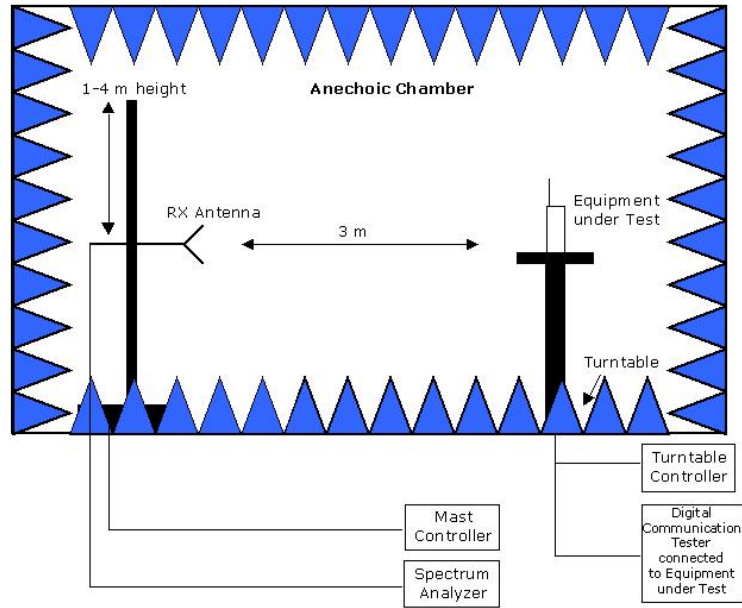

Remark: Depending on the frequency range suitable antenna types, attenuators or preamplifiers are used.

**Drawing 1:** Setup in the Anechoic chamber:  
 Measurements below 1 GHz: Semi-anechoic, conducting ground plane.  
 Measurements above 1 GHz: Fully-anechoic, absorbers on all surfaces



## 7 Annex measurement plots

### 7.1 Occupied bandwidth

#### 7.1.1 Occupied bandwidth operating mode 1

##### Op. Mode

op-mode 1

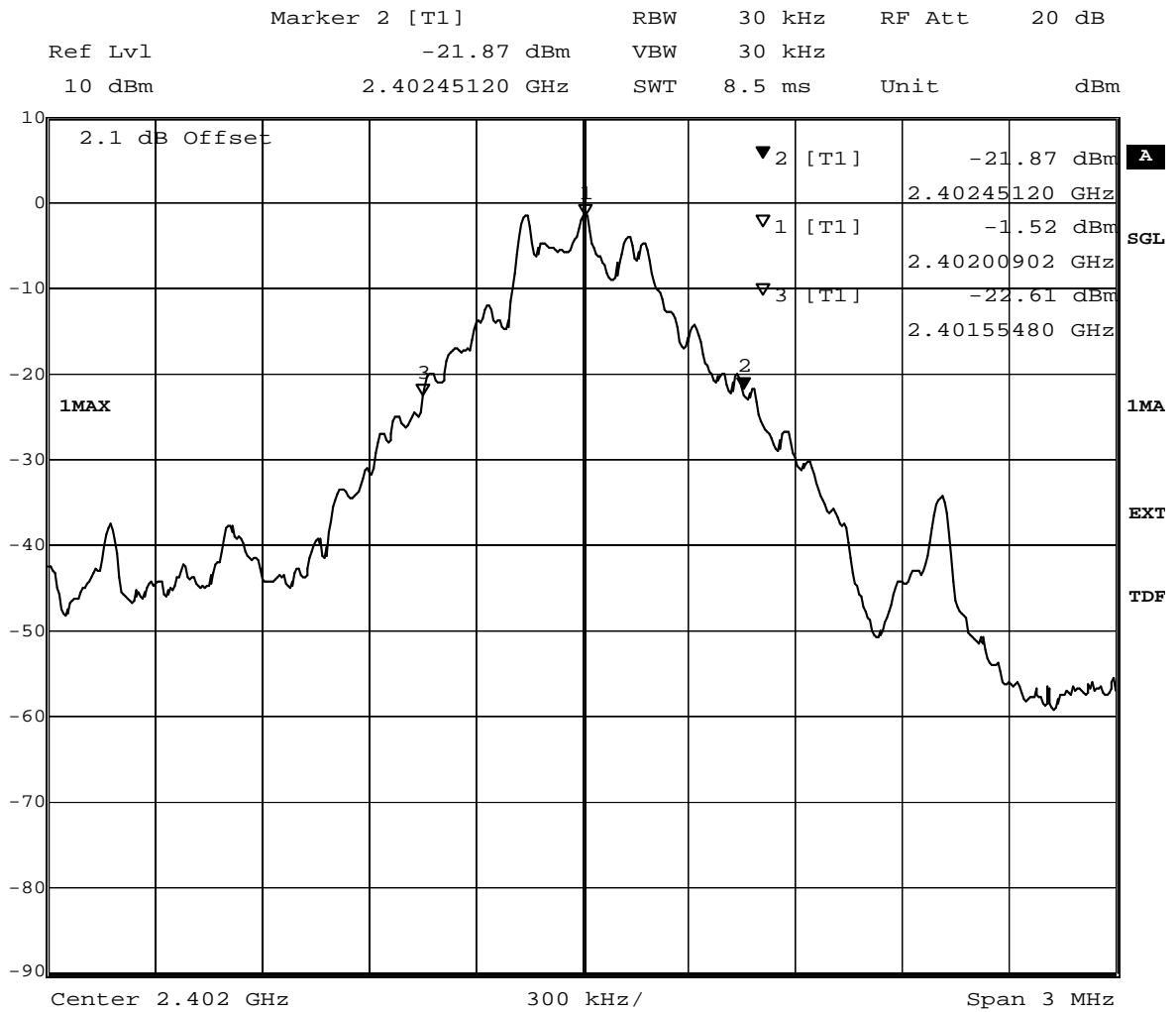

Title: 20dB Bandwidth  
 Comment A: CH B: 2402 MHz; 20dB bandwidth (kHz):896.4  
 Date: 3.NOV.2009 09:58:59



## 7.1.2 Occupied bandwidth operating mode 2

### Op. Mode

op-mode 2

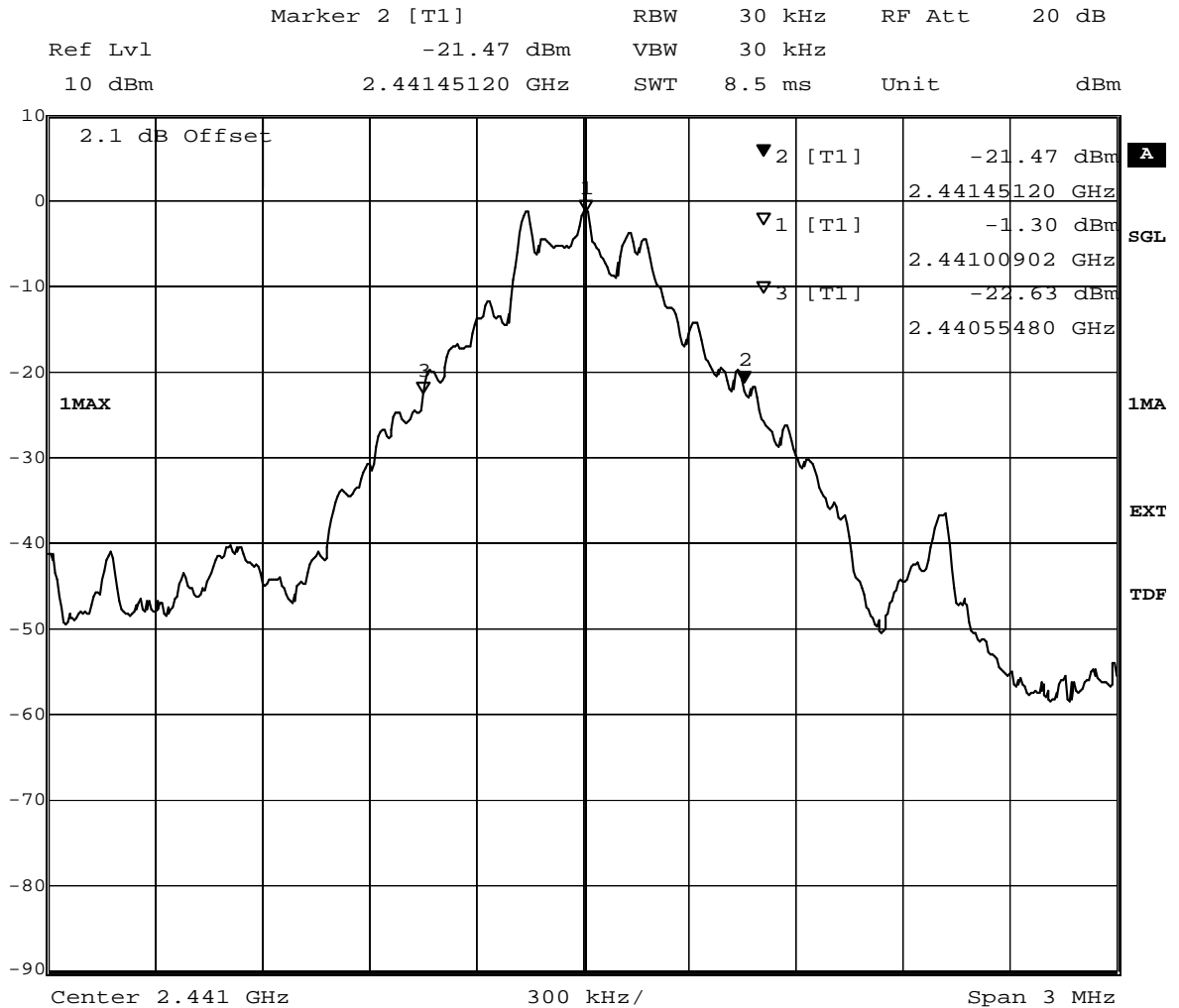

Title: 20dB Bandwidth  
 Comment A: CH M: 2441 MHz; 20dB bandwidth (kHz):896.4  
 Date: 3.NOV.2009 10:14:00



### 7.1.3 Occupied bandwidth operating mode 3

#### Op. Mode

op-mode 3

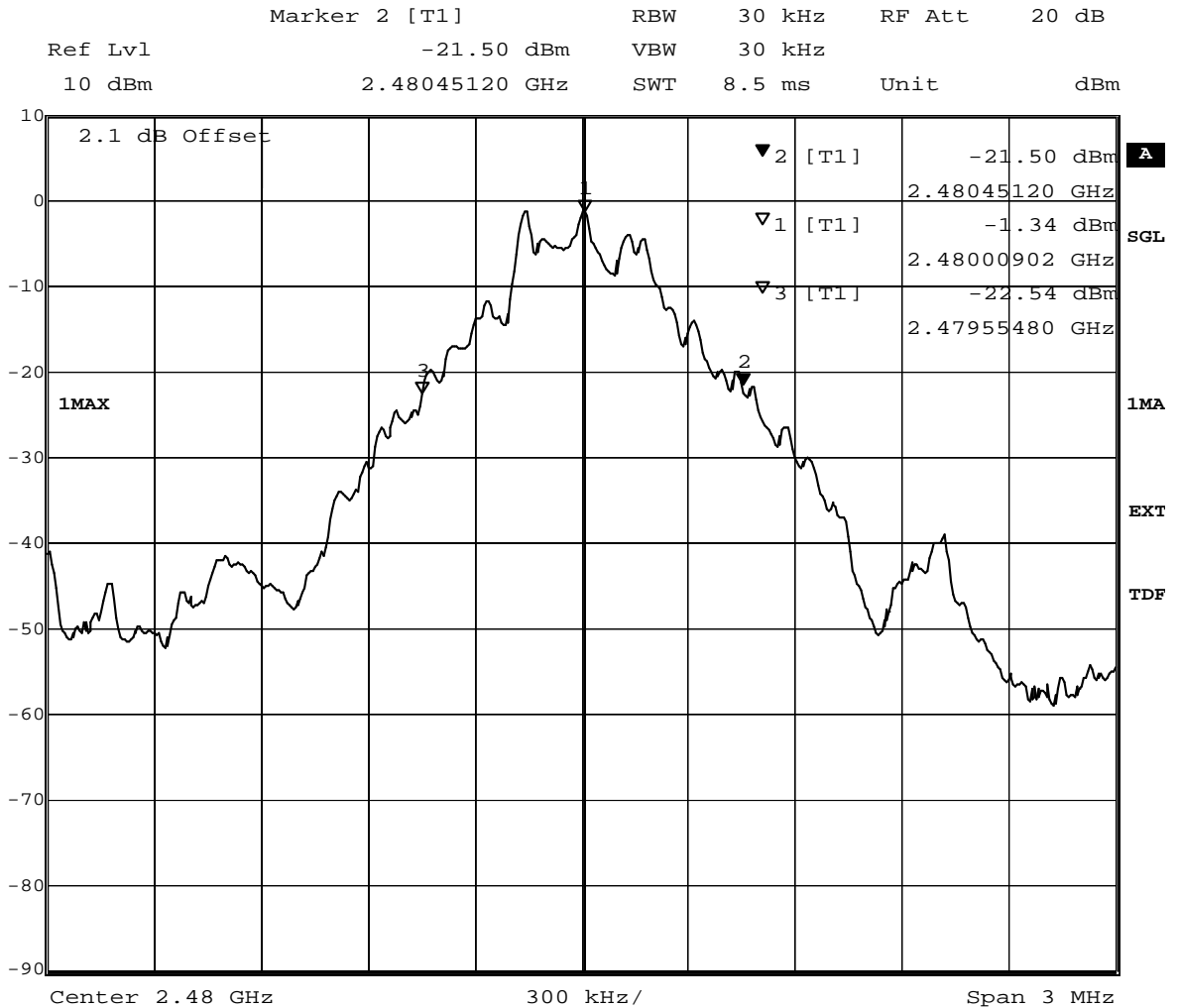

Title: 20dB Bandwidth  
 Comment A: CH T: 2480 MHz; 20dB bandwidth (kHz):896.4  
 Date: 3.NOV.2009 10:18:04



### 7.1.4 Occupied bandwidth operating mode 6

#### Op. Mode

op-mode 6

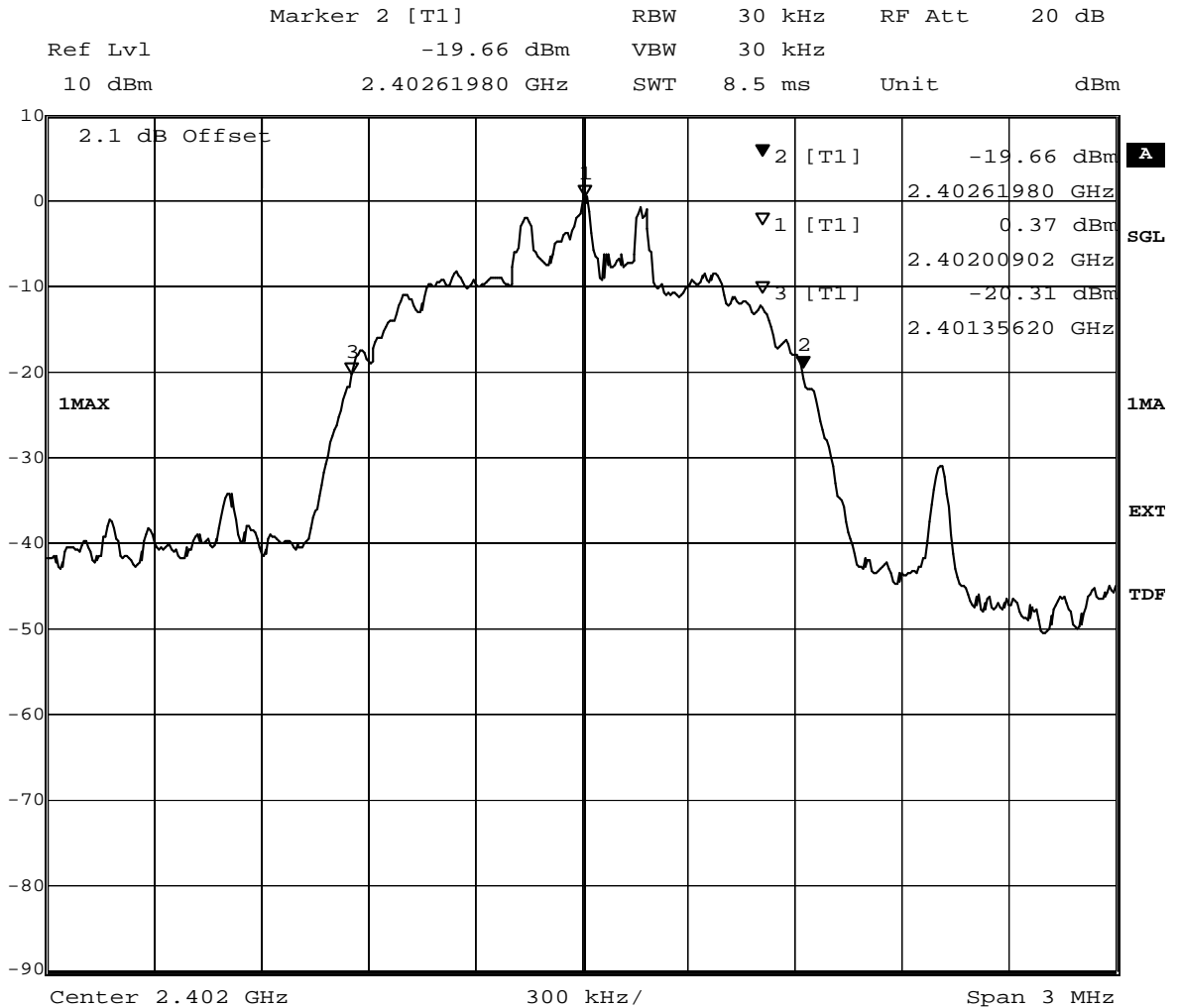

Title: 20dB Bandwidth  
 Comment A: CH B: 2402 MHz; 20dB bandwidth (kHz):1263.6  
 Date: 2.NOV.2009 15:09:28





### 7.1.5 Occupied bandwidth operating mode 7

#### Op. Mode

op-mode 7

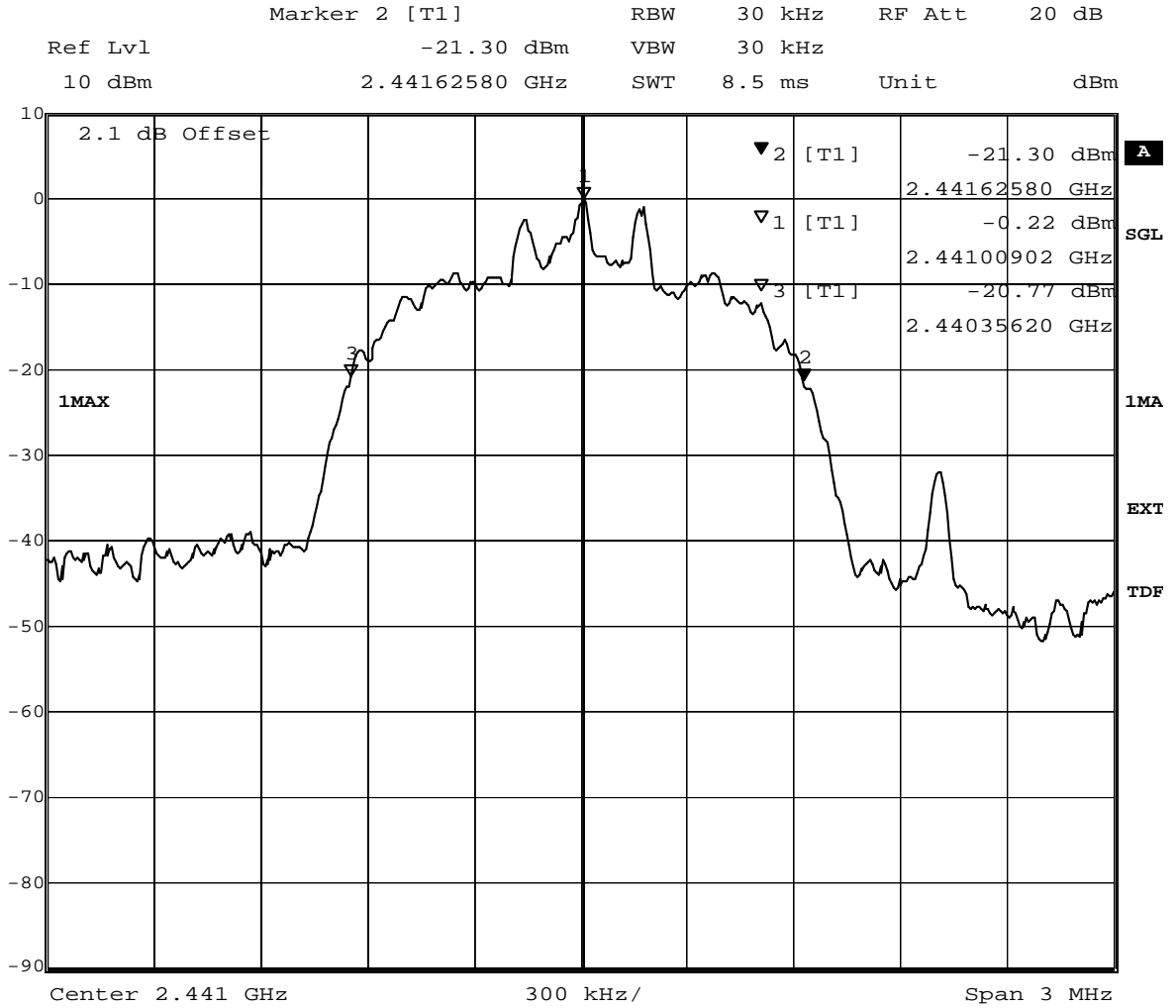

Title: 20dB Bandwidth  
 Comment A: CH M: 2441 MHz; 20dB bandwidth (kHz):1269.6  
 Date: 2.NOV.2009 15:05:20



### 7.1.6 Occupied bandwidth operating mode 8

#### Op. Mode

op-mode 8

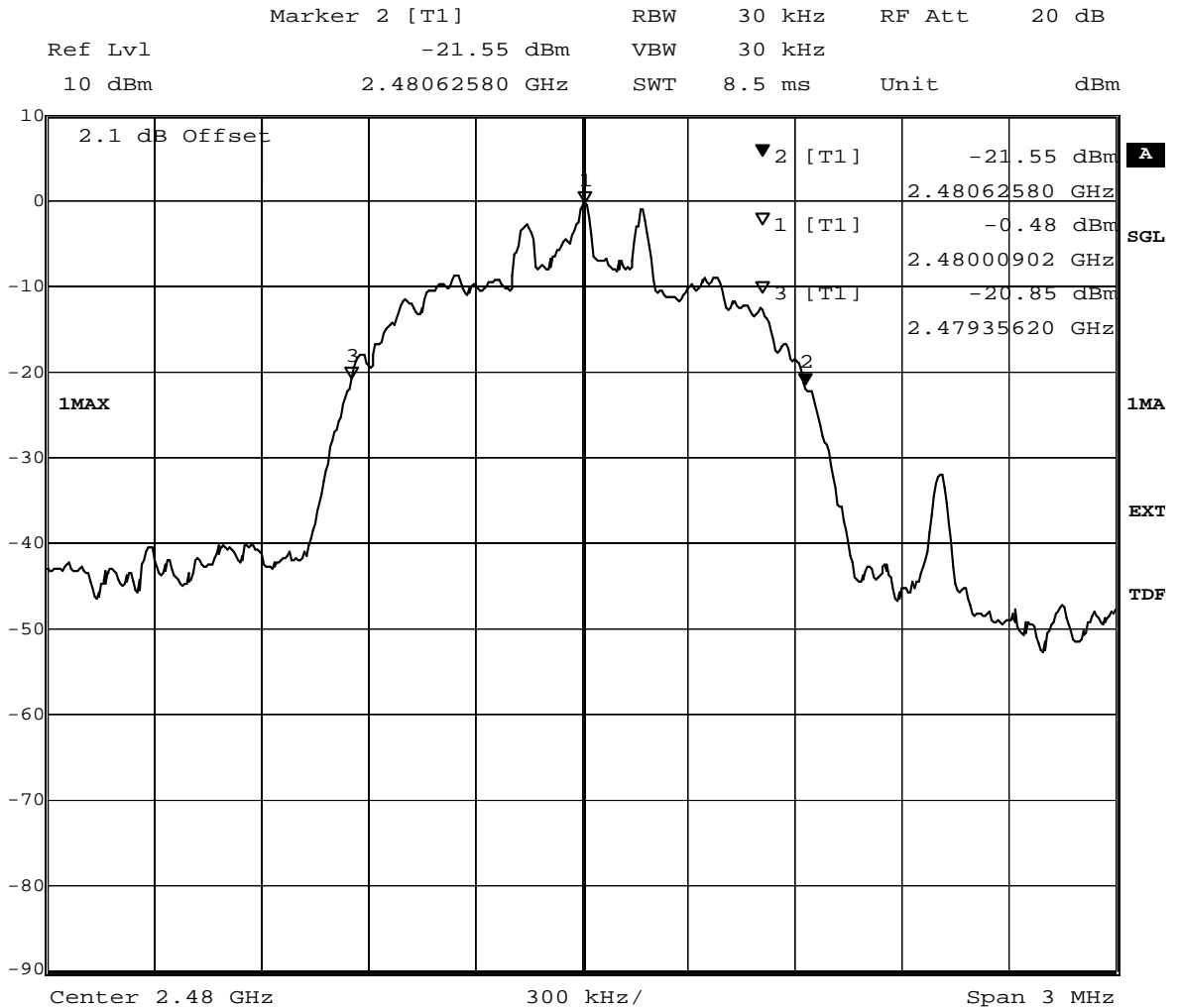

Title: 20dB Bandwidth  
 Comment A: CH T: 2480 MHz; 20dB bandwidth (kHz):1269.6  
 Date: 2.NOV.2009 15:01:22



### 7.1.7 Occupied bandwidth operating mode 10

#### Op. Mode

op-mode 10

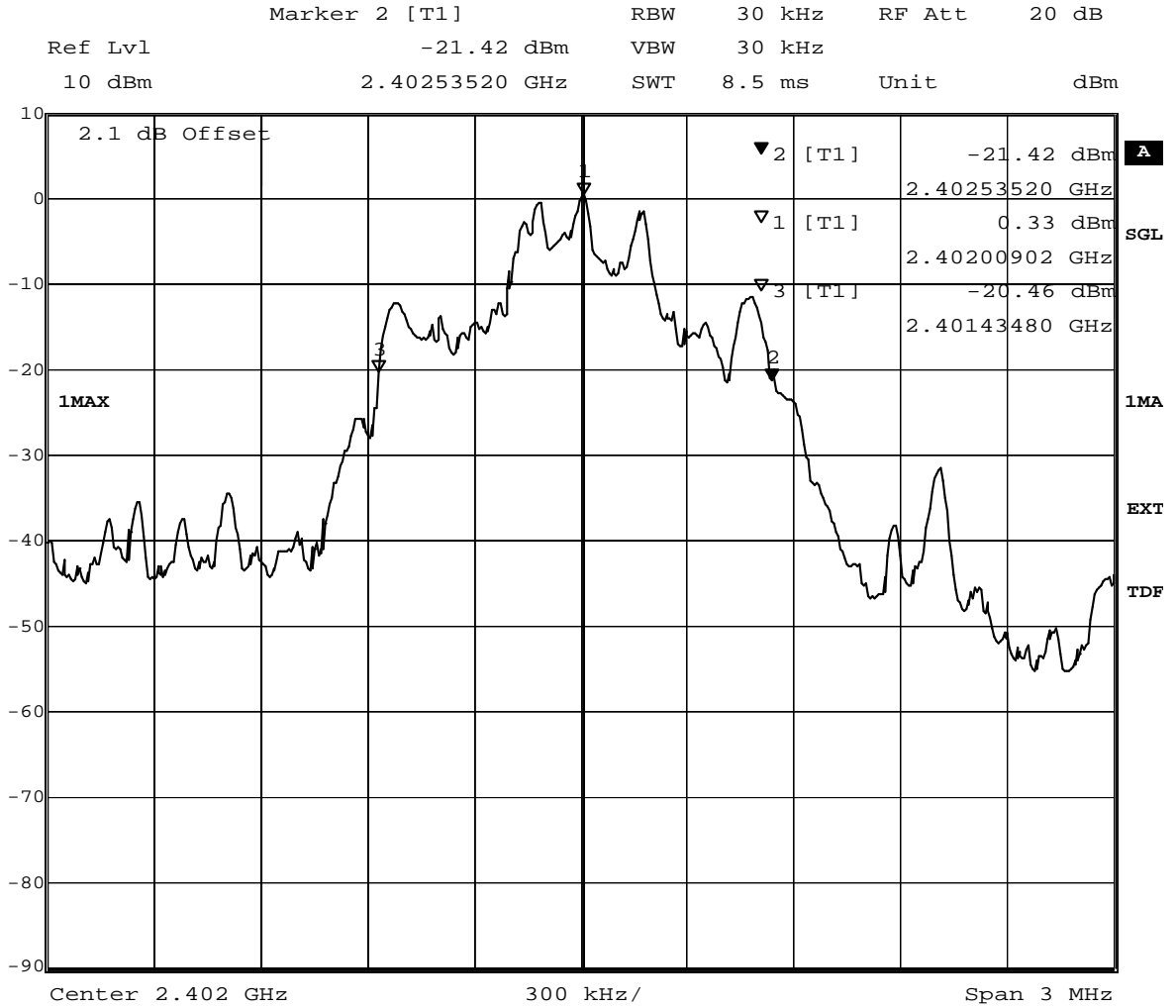

Title: 20dB Bandwidth  
 Comment A: CH B: 2402 MHz; 20dB bandwidth (kHz):1100.4  
 Date: 2.NOV.2009 13:06:24



### 7.1.8 Occupied bandwidth operating mode 11

#### Op. Mode

op-mode 11

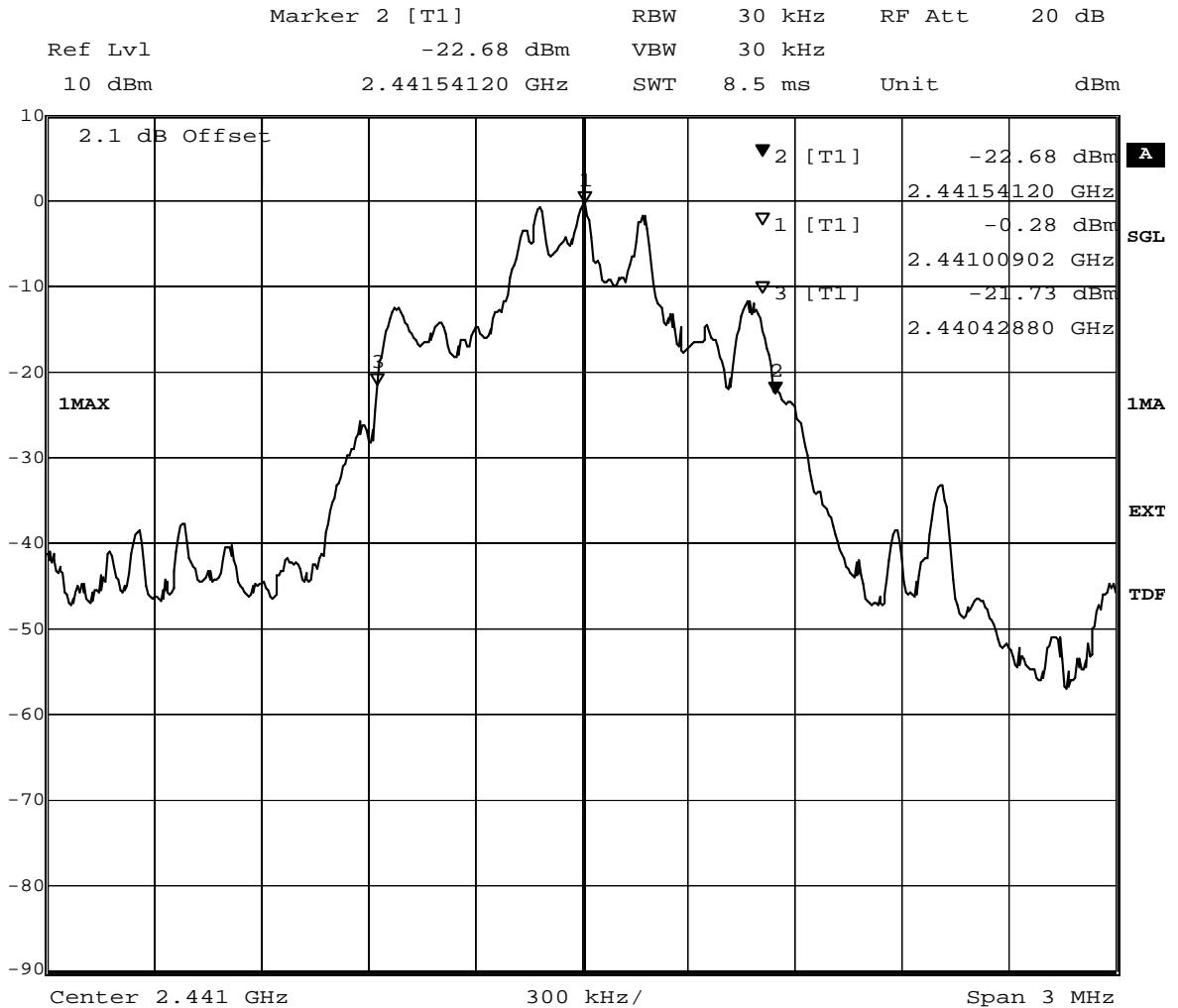

Title: 20dB Bandwidth  
 Comment A: CH M: 2441 MHz; 20dB bandwidth (kHz):1112.4  
 Date: 2.NOV.2009 13:01:35



### 7.1.9 Occupied bandwidth operating mode 12

#### Op. Mode

op-mode 12

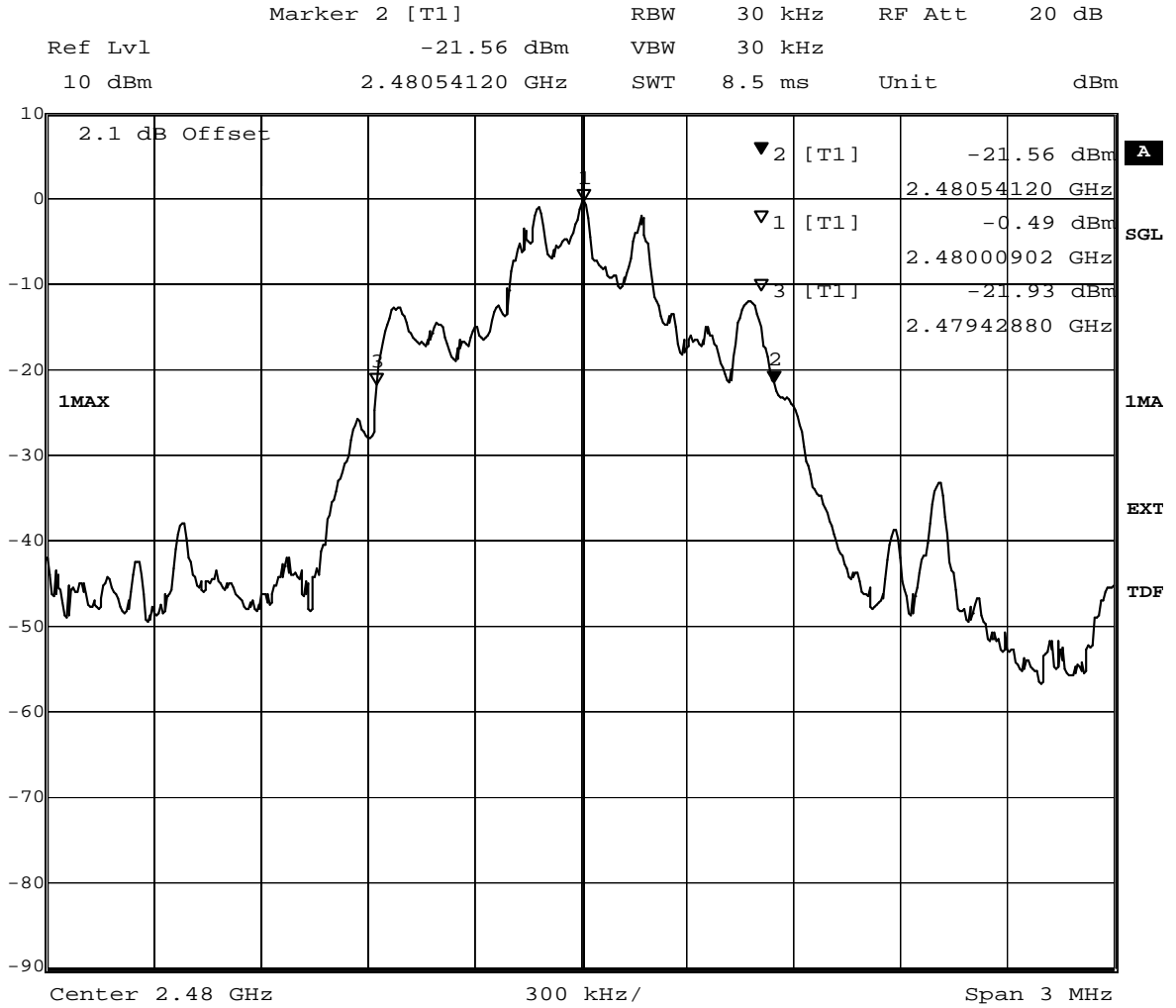

Title: 20dB Bandwidth  
 Comment A: CH T: 2480 MHz; 20dB bandwidth (kHz):1112.4  
 Date: 2.NOV.2009 12:57:25



## 7.2 Peak power output

### 7.2.1 Peak power output operating mode 1

#### Op. Mode

op-mode 1

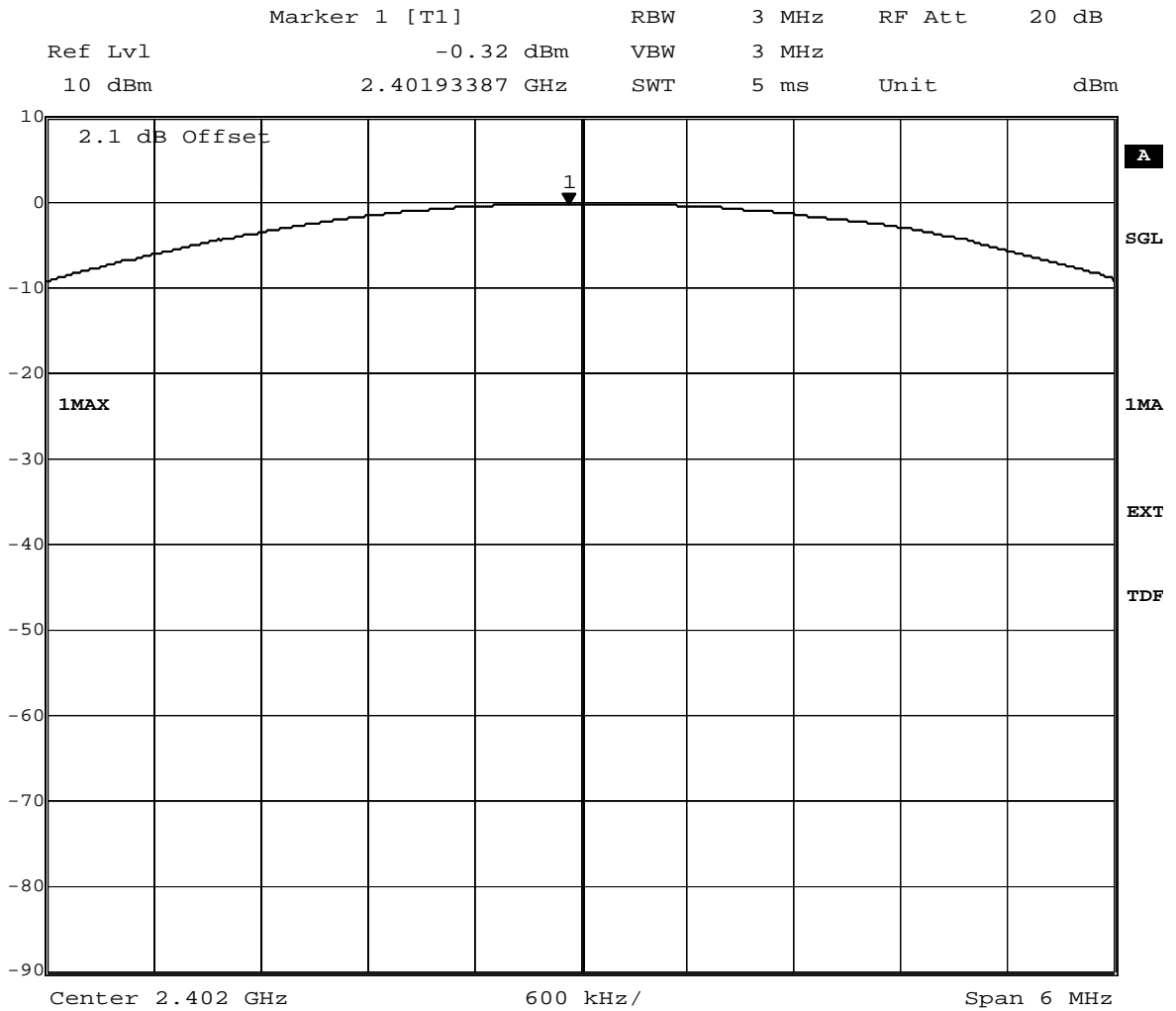

Title: Peak outputpower Power  
 Comment A: CH B: 2402 MHz  
 Date: 2.NOV.2009 11:00:31



## 7.2.2 Peak power output operating mode 2

### Op. Mode

op-mode 2

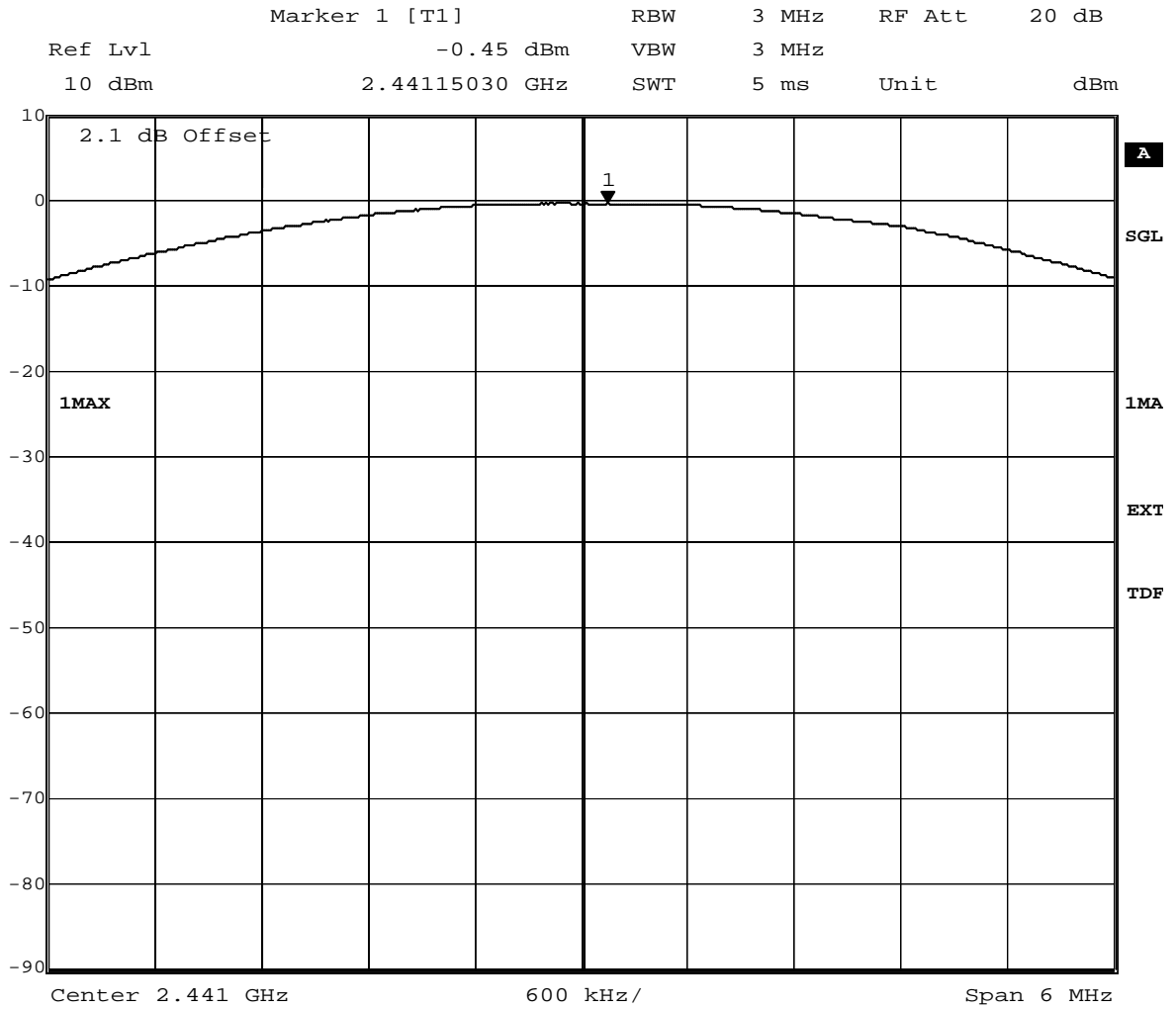

Title: Peak outputpower Power  
Comment A: CH M: 2441 MHz  
Date: 2.NOV.2009 10:56:09



### 7.2.3 Peak power output operating mode 3

#### Op. Mode

op-mode 3

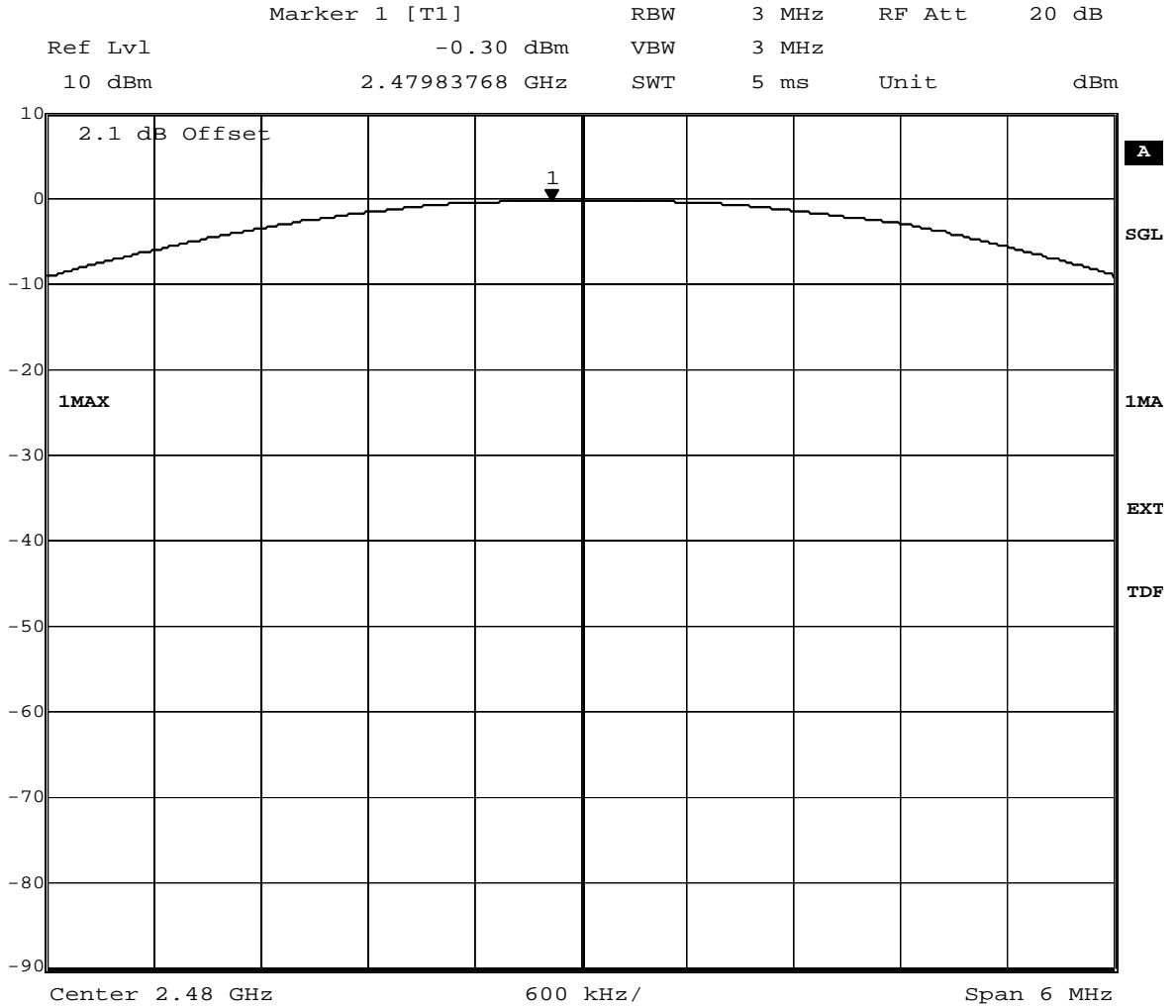

Title: Peak outputpower Power  
Comment A: CH T: 2480 MHz  
Date: 2.NOV.2009 10:45:11





### 7.2.4 Peak power output operating mode 6

#### Op. Mode

op-mode 6

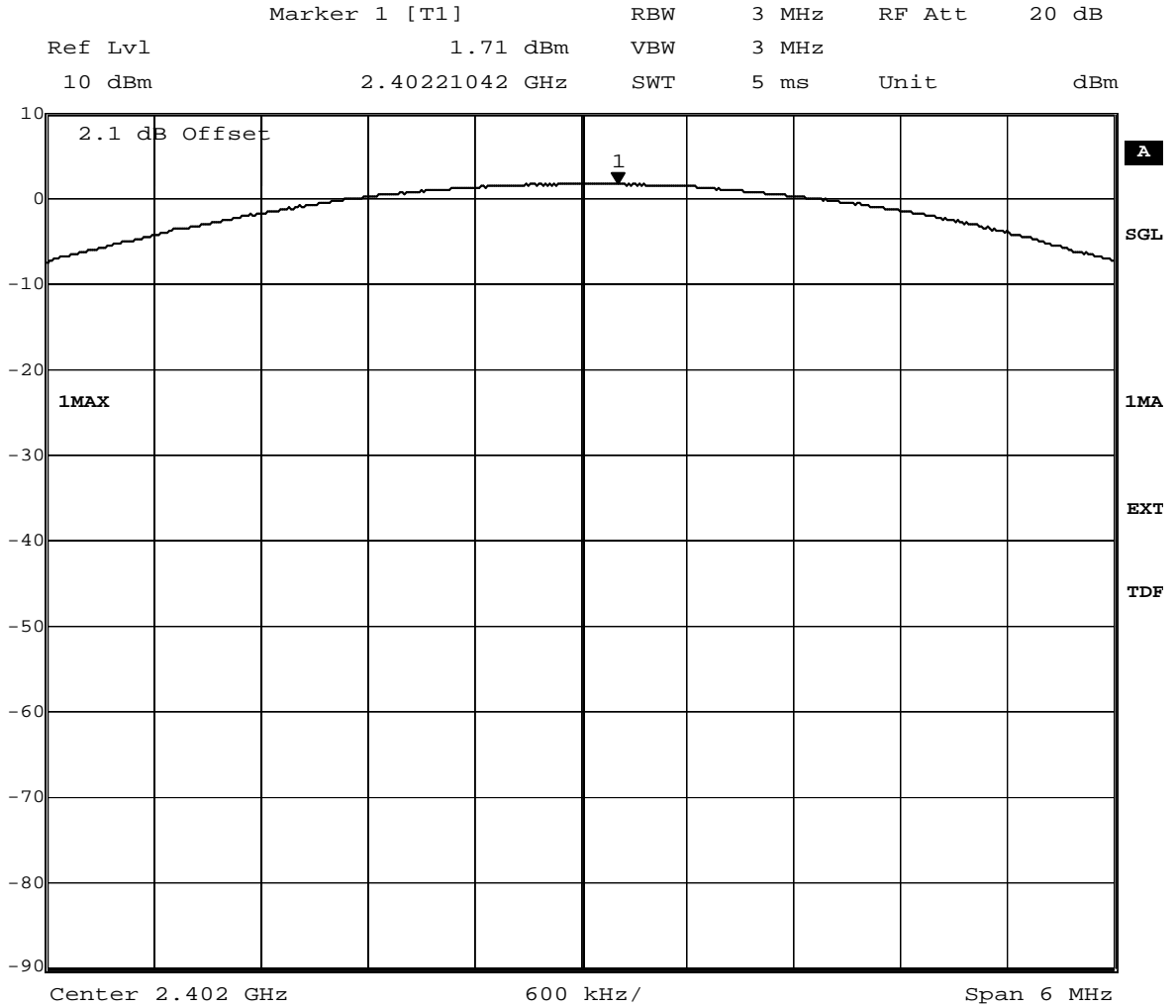

Title: Peak outputpower Power  
Comment A: CH B: 2402 MHz  
Date: 2.NOV.2009 15:09:54



### 7.2.5 Peak power output operating mode 7

#### Op. Mode

op-mode 7

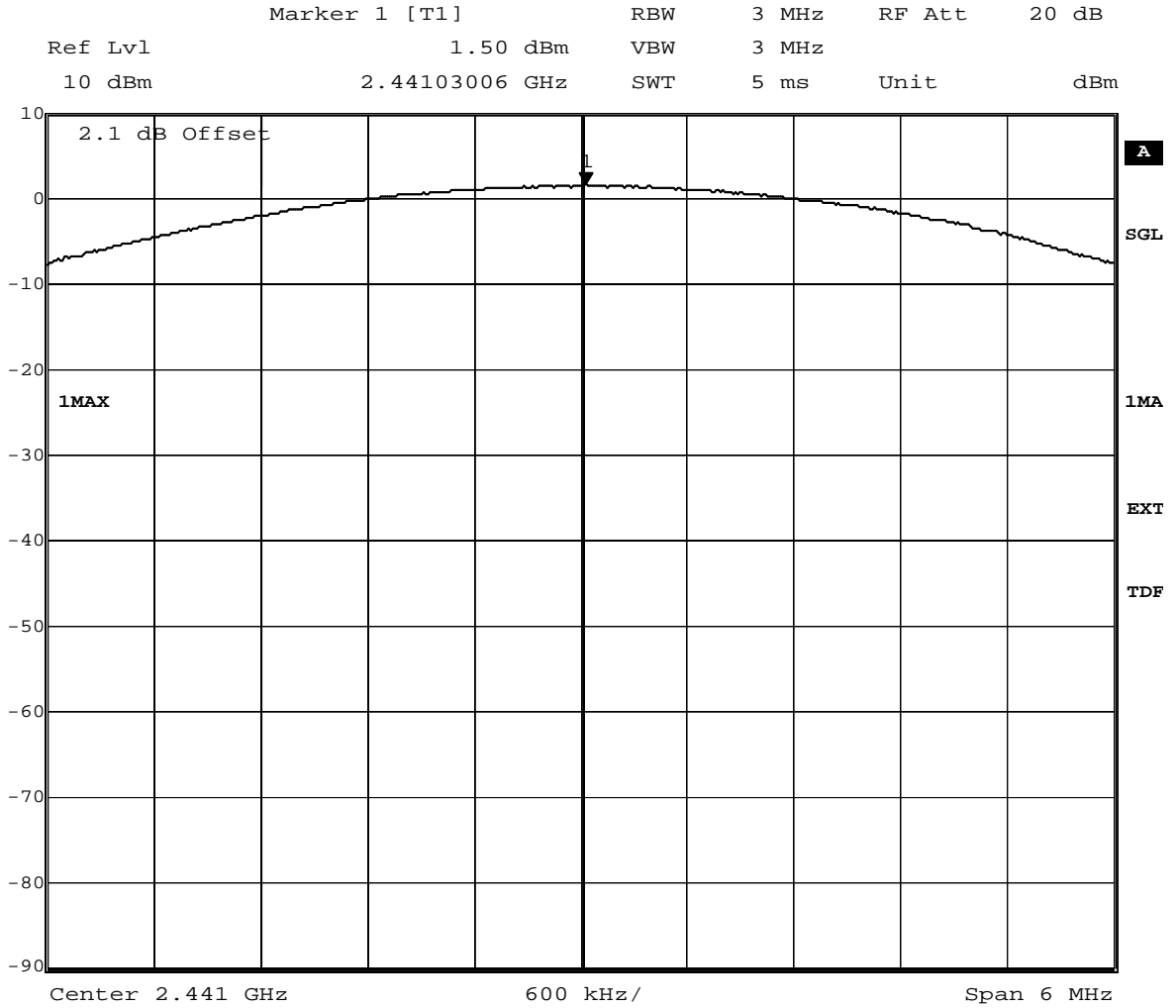

Title: Peak outputpower Power  
Comment A: CH M: 2441 MHz  
Date: 2.NOV.2009 15:05:46



### 7.2.6 Peak power output operating mode 8

#### Op. Mode

op-mode 8

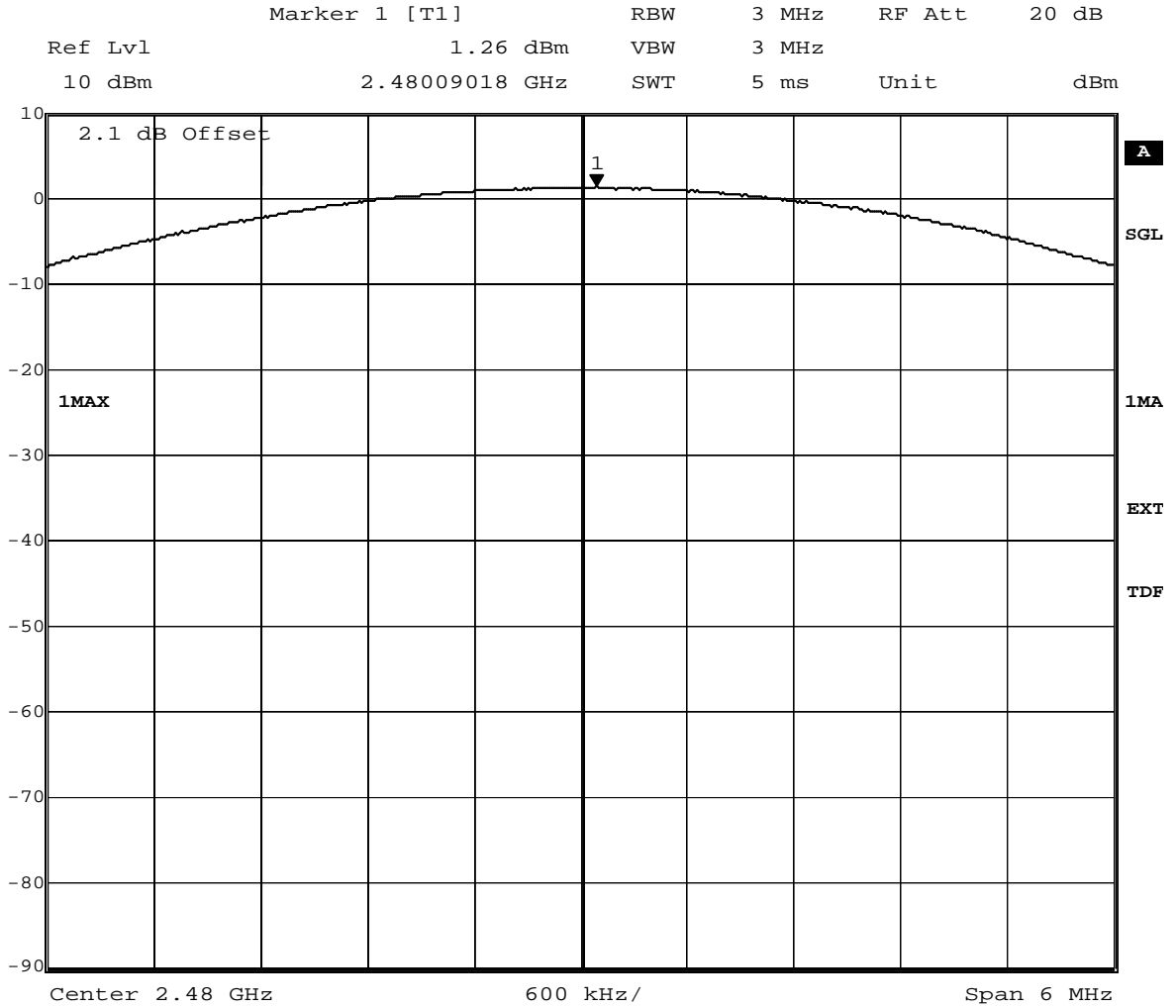

Title: Peak outputpower Power  
Comment A: CH T: 2480 MHz  
Date: 2.NOV.2009 15:01:48



### 7.2.7 Peak power output operating mode 10

#### Op. Mode

op-mode 10

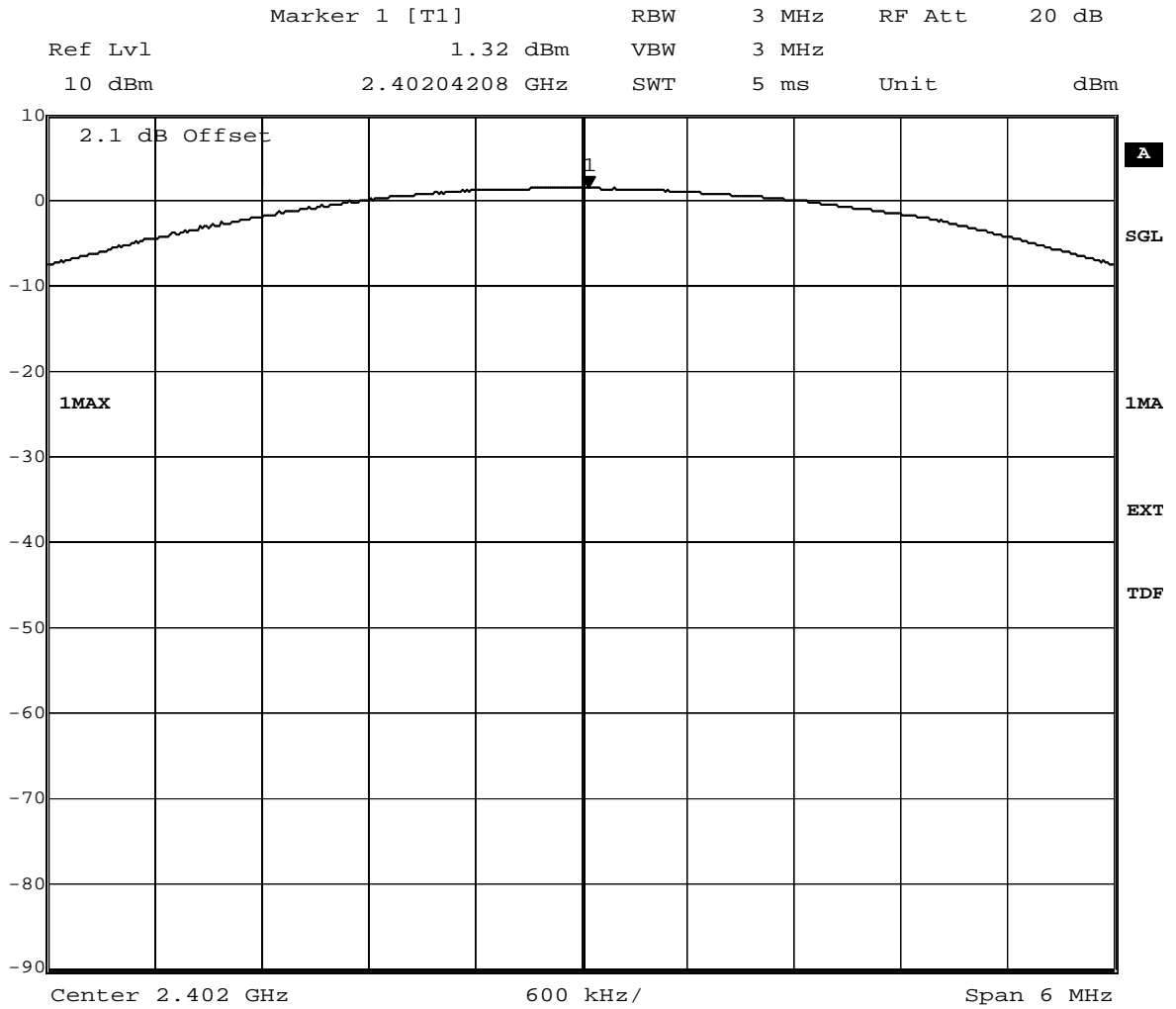

Title: Peak outputpower Power  
Comment A: CH B: 2402 MHz  
Date: 2.NOV.2009 13:06:50



### 7.2.8 Peak power output operating mode 11

#### Op. Mode

op-mode 11

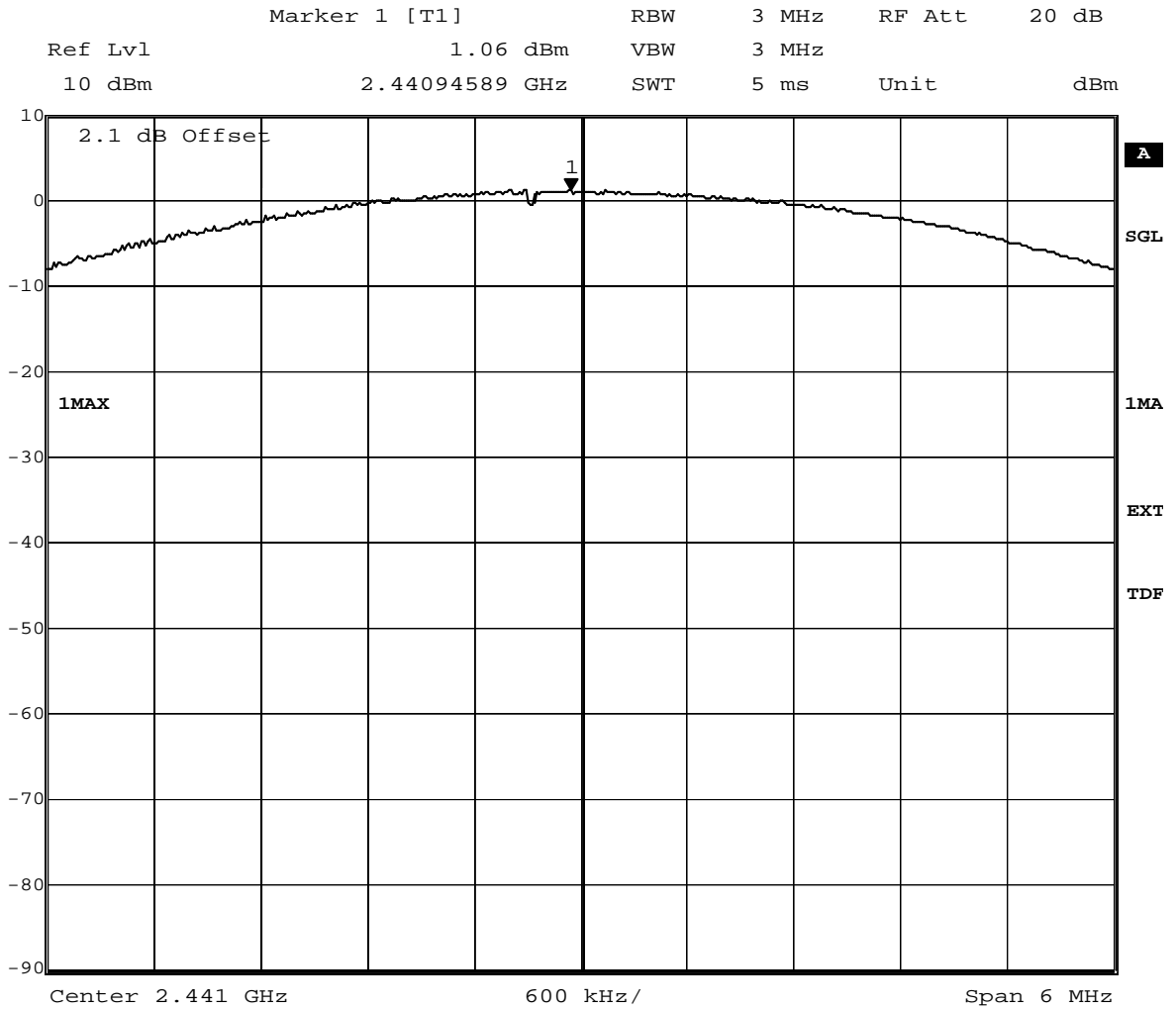

Title: Peak outputpower Power  
Comment A: CH M: 2441 MHz  
Date: 2.NOV.2009 13:02:01



## 7.2.9 Peak power output operating mode 12

### Op. Mode

op-mode 12

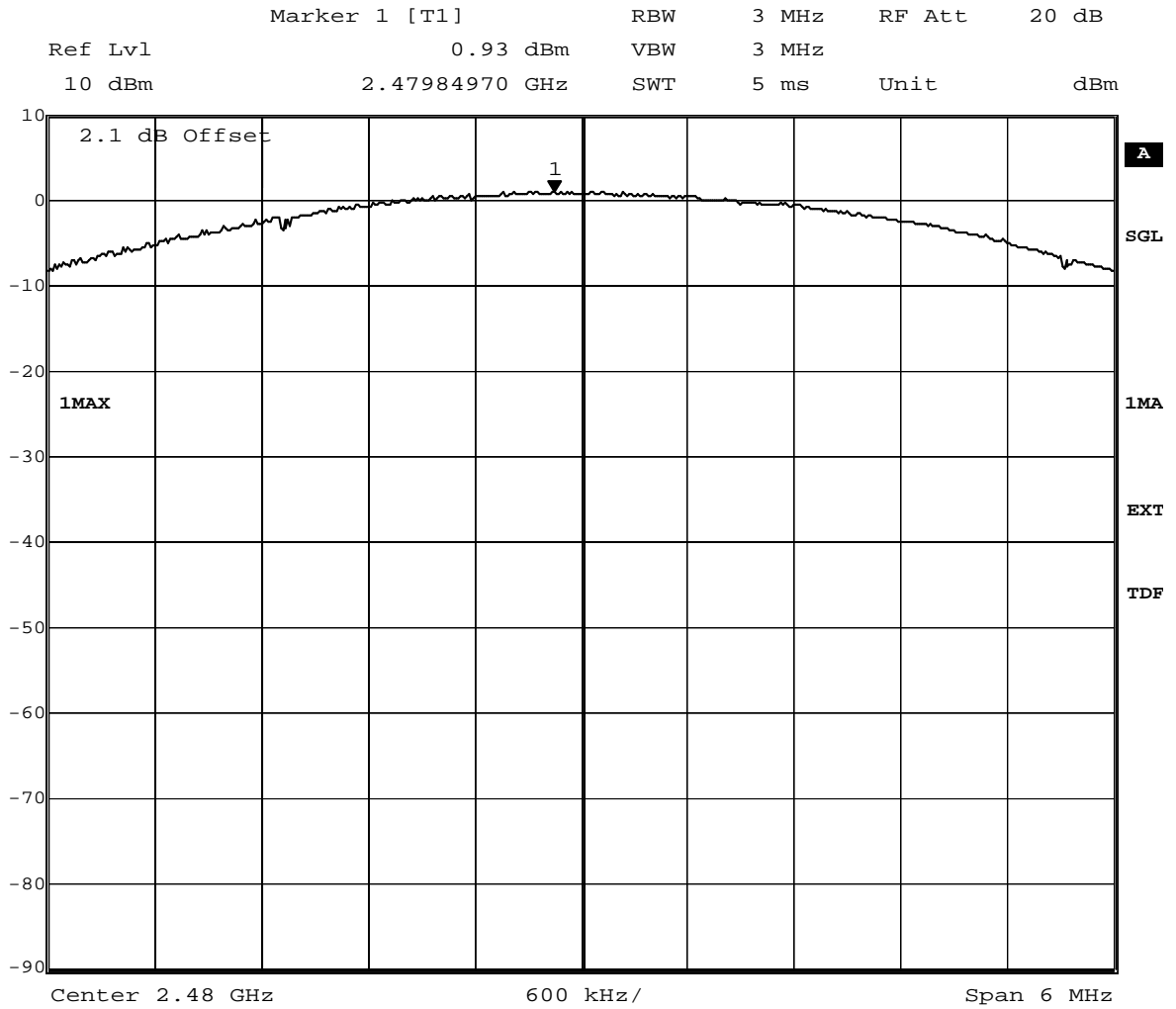

Title: Peak outputpower Power  
 Comment A: CH T: 2480 MHz  
 Date: 2.NOV.2009 12:57:51



### 7.3 Band edge compliance conducted and Spurious RF conducted emissions

#### 7.3.1 Band edge compliance conducted operating mode 1

##### Op. Mode

op-mode 1

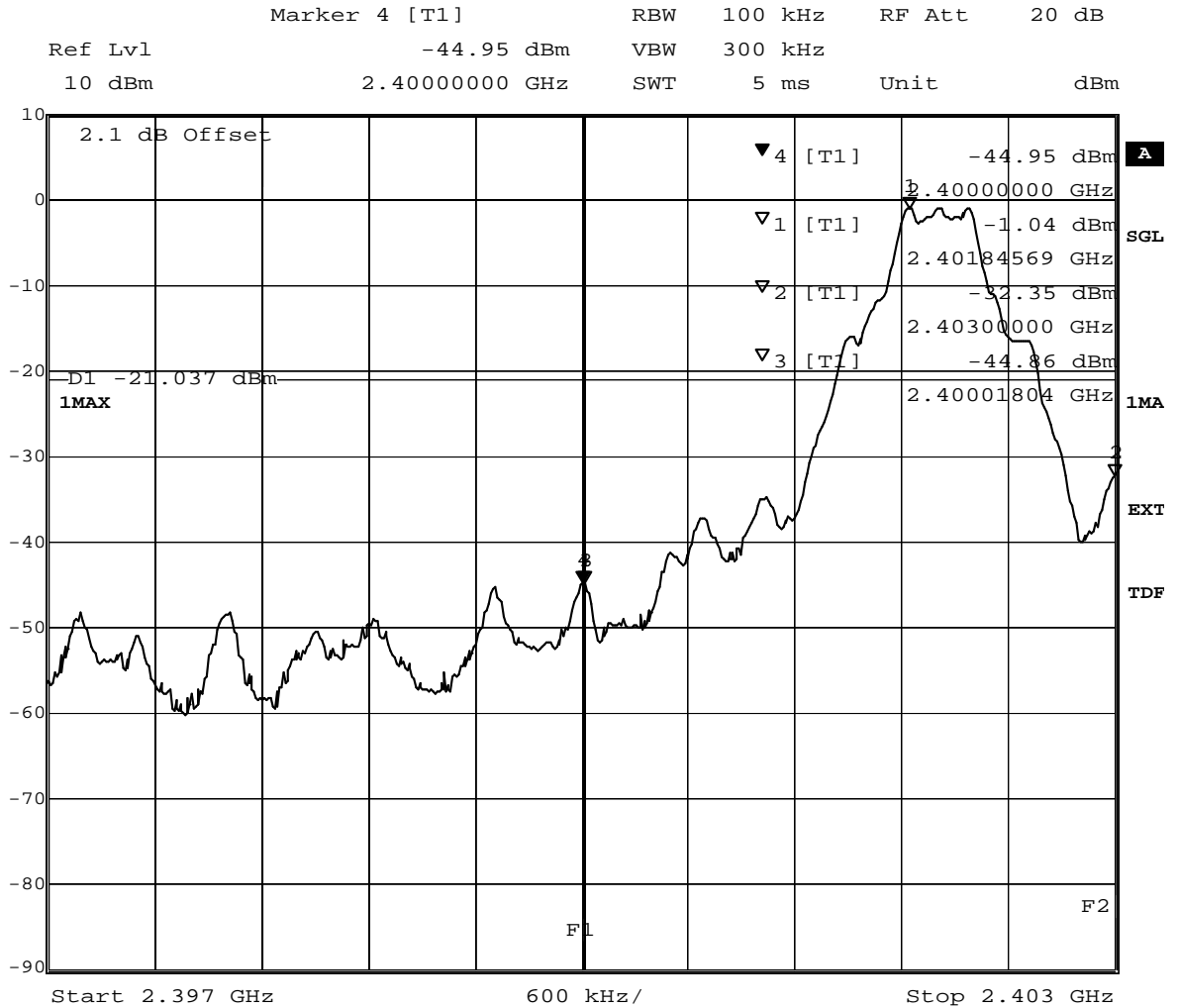

Title: Band Edge Compliance  
 Comment A: CH B: 2402 MHz  
 Date: 19.OCT.2009 08:02:44

(determination of reference value for spurious emissions measurement)



### 7.3.2 Spurious RF conducted emissions operating mode 1

#### Op. Mode

op-mode 1

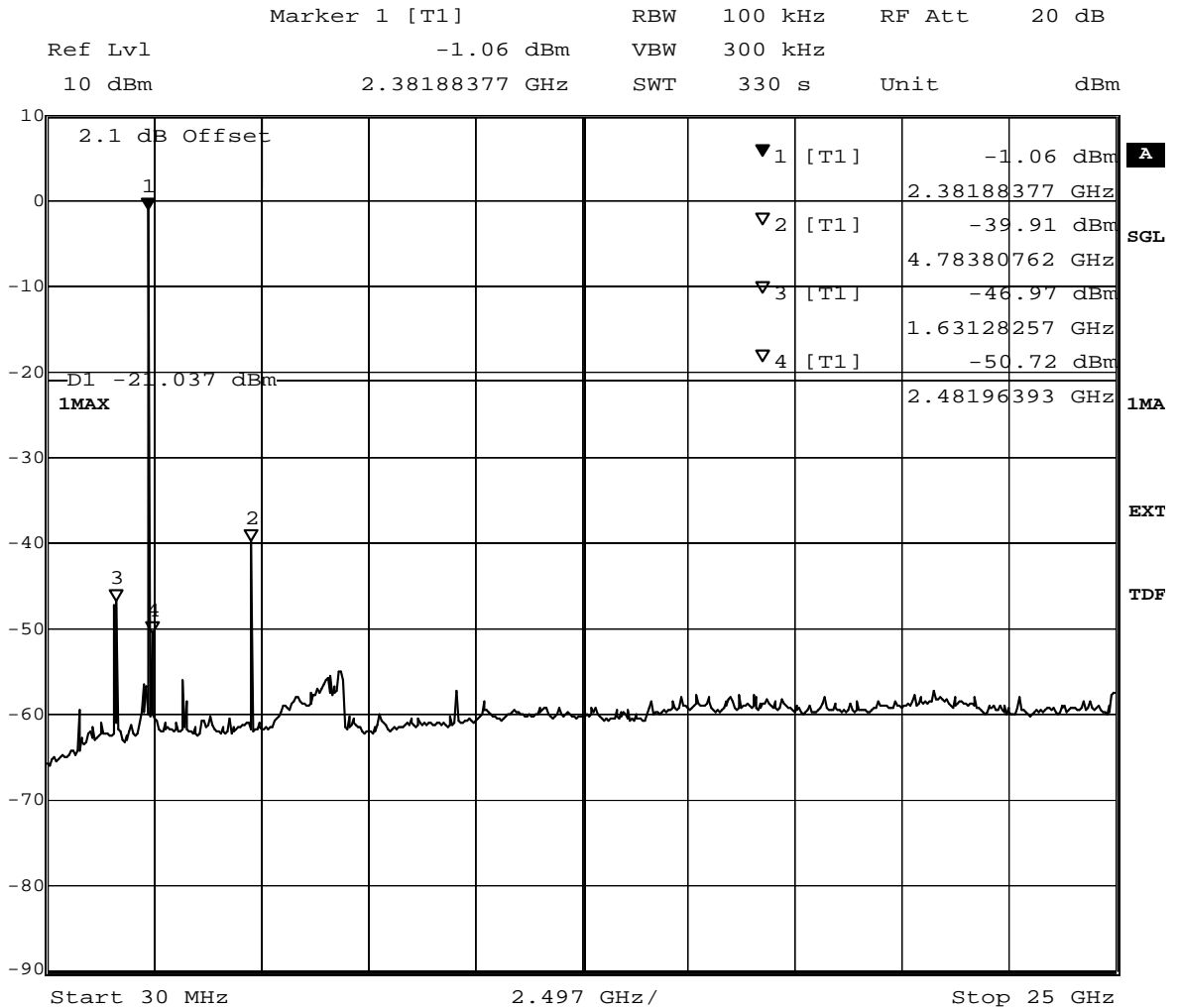

Title: spurious emissions  
 Comment A: CH B: 2402 MHz  
 Date: 19.OCT.2009 08:14:40

(spurious emissions measurement)





### 7.3.3 Spurious RF conducted emissions operating mode 2

#### Op. Mode

op-mode 2

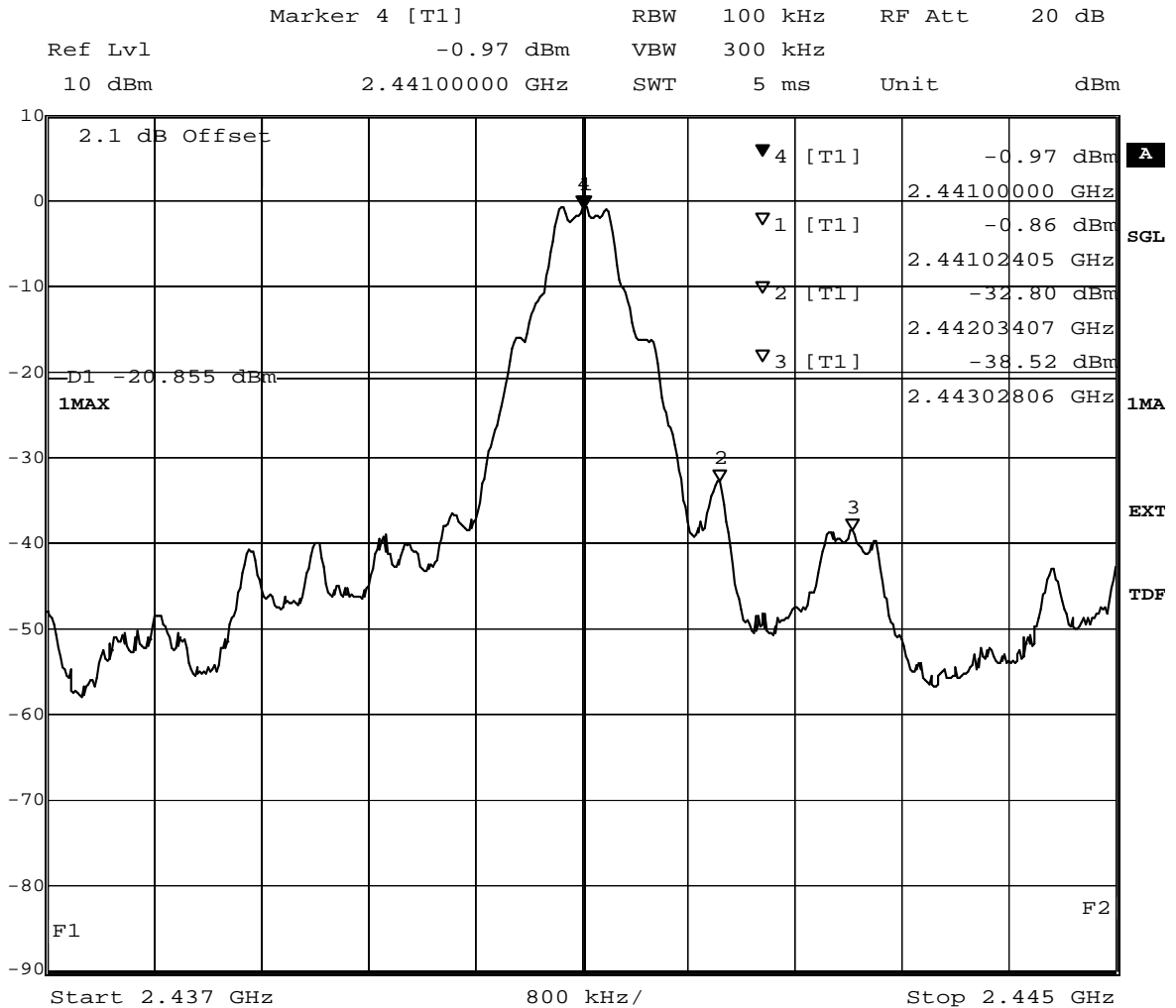

Title: Band Edge Compliance  
 Comment A: CH M: 2441 MHz  
 Date: 2.NOV.2009 10:01:55

(determination of reference value for spurious emissions measurement)

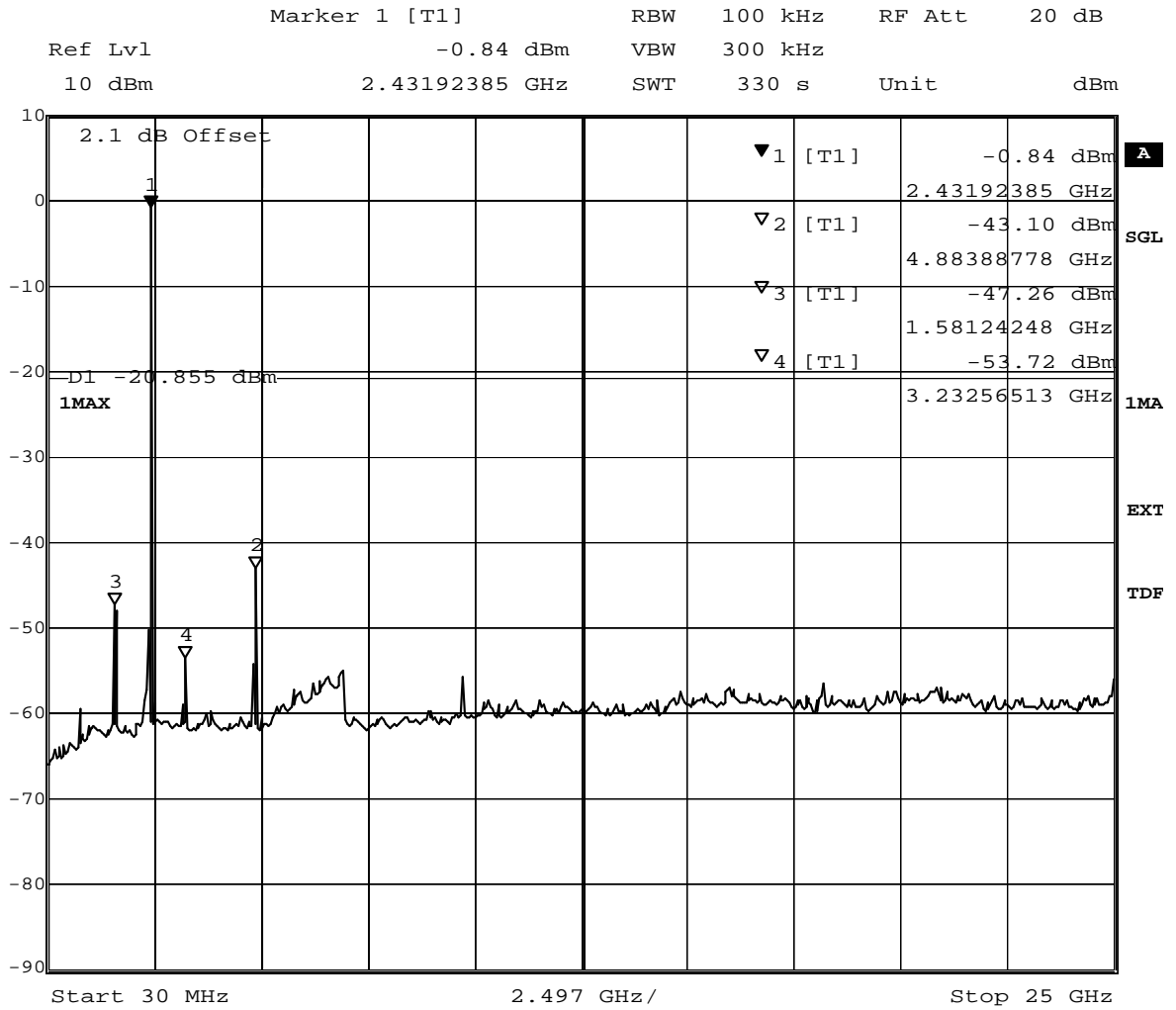

Title: spurious emissions  
 Comment A: CH M: 2441 MHz  
 Date: 2.NOV.2009 10:13:33

(spurious emissions measurement)



### 7.3.4 Band edge compliance conducted operating mode 3

#### Op. Mode

op-mode 3

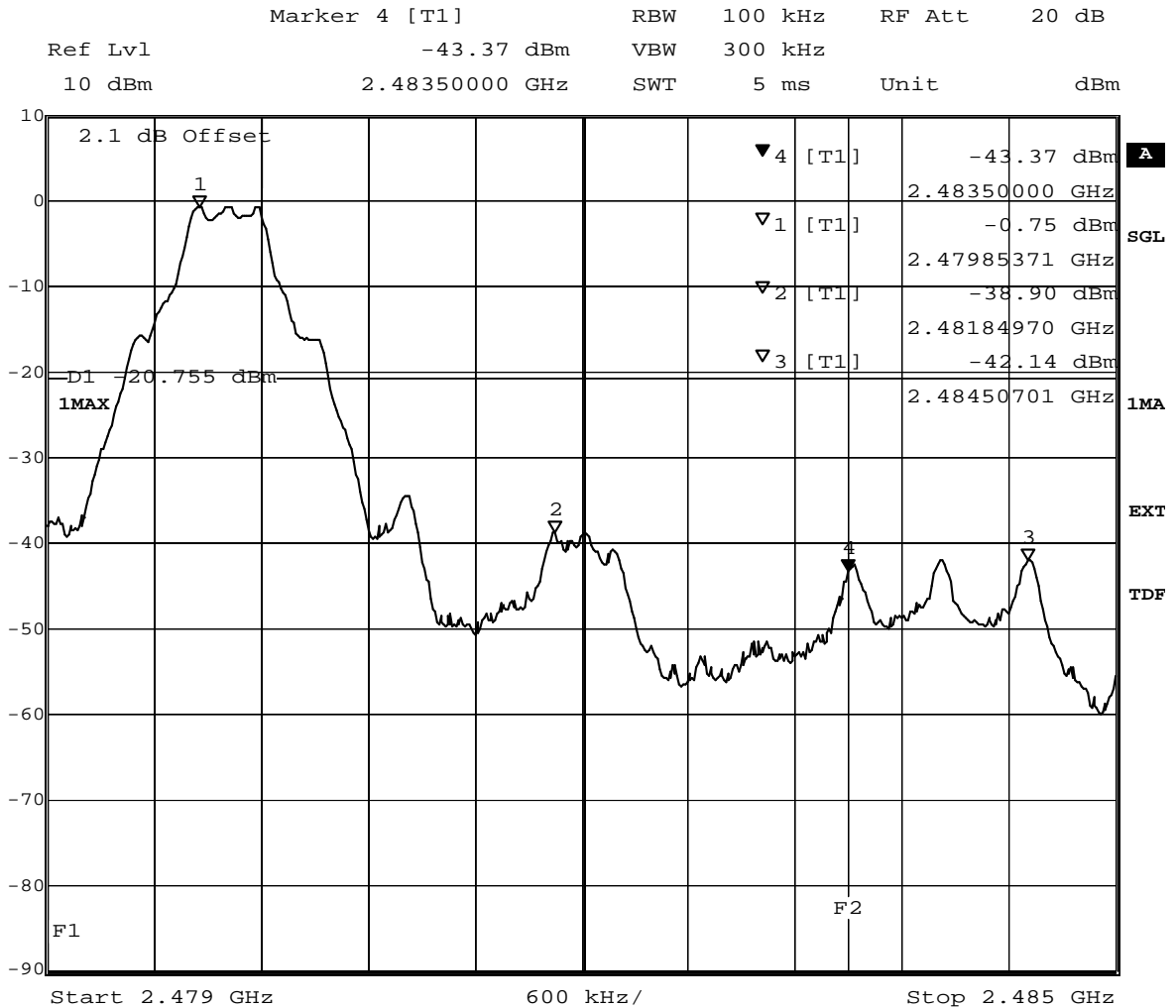

Title: Band Edge Compliance  
 Comment A: CH T: 2480 MHz  
 Date: 2.NOV.2009 10:15:31

(determination of reference value for spurious emissions measurement)



### 7.3.5 Spurious RF conducted emissions operating mode 3

#### Op. Mode

op-mode 3

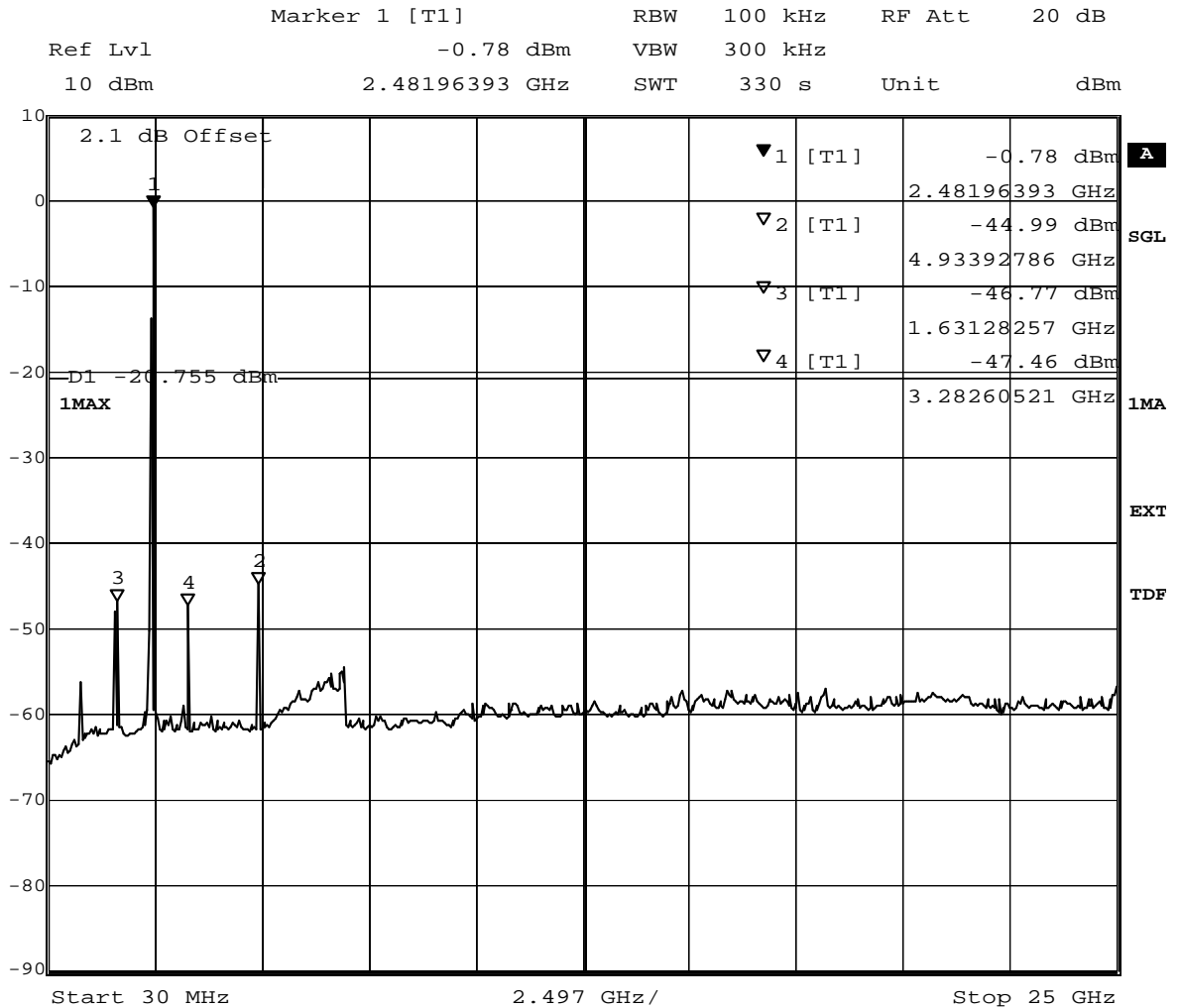

Title: spurious emissions  
 Comment A: CH T: 2480 MHz  
 Date: 2.NOV.2009 10:27:09

(spurious emissions measurement)



### 7.3.6 Band edge compliance conducted operating mode 6

#### Op. Mode

op-mode 6

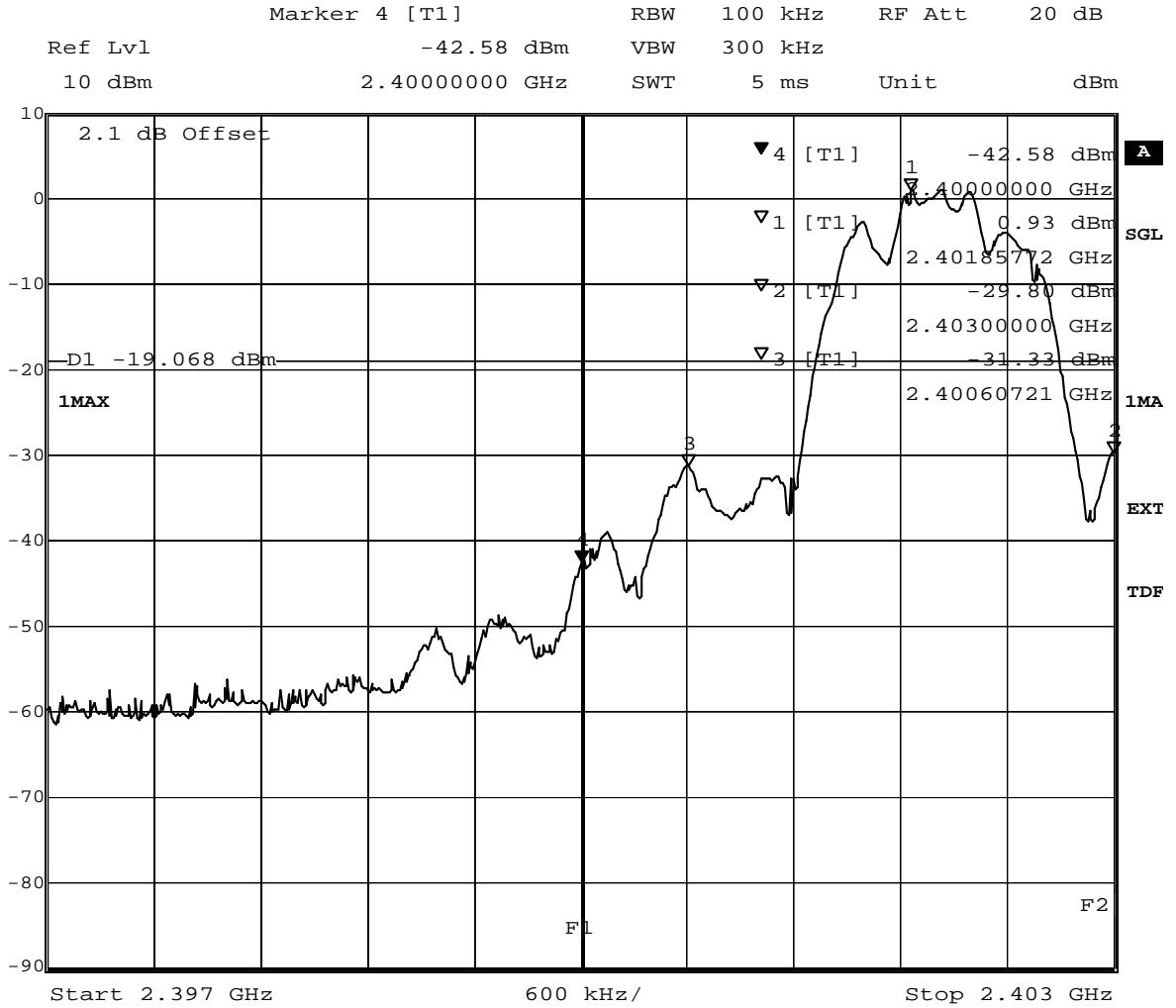

Title: Band Edge Compliance  
 Comment A: CH B: 2402 MHz  
 Date: 2.NOV.2009 14:00:24

(determination of reference value for spurious emissions measurement)



### 7.3.7 Spurious RF conducted emissions operating mode 6

#### Op. Mode

op-mode 6

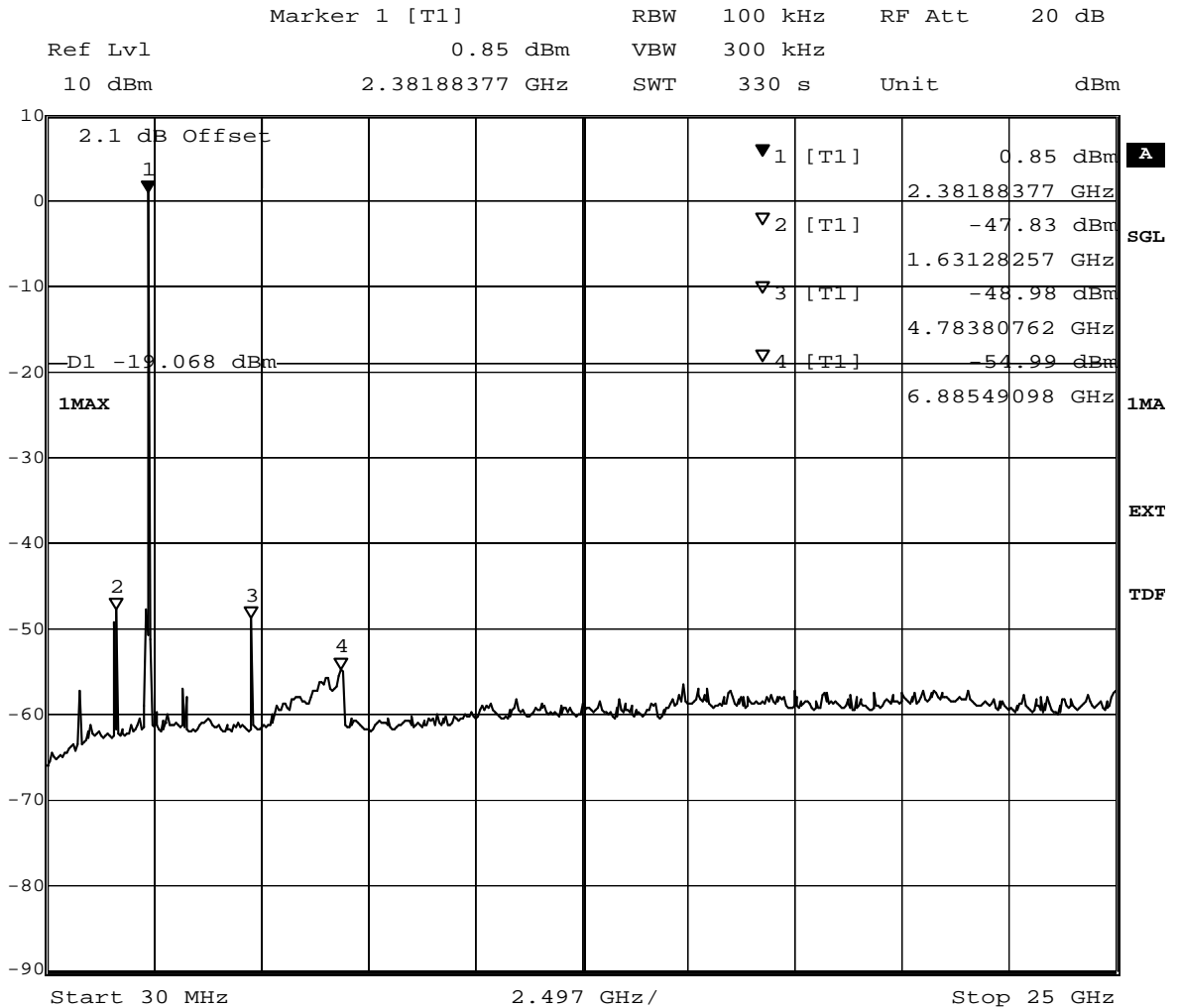

Title: spurious emissions  
 Comment A: CH B: 2402 MHz  
 Date: 2.NOV.2009 14:12:01

(spurious emissions measurement)



### 7.3.8 Spurious RF conducted emissions operating mode 7

#### Op. Mode

op-mode 7

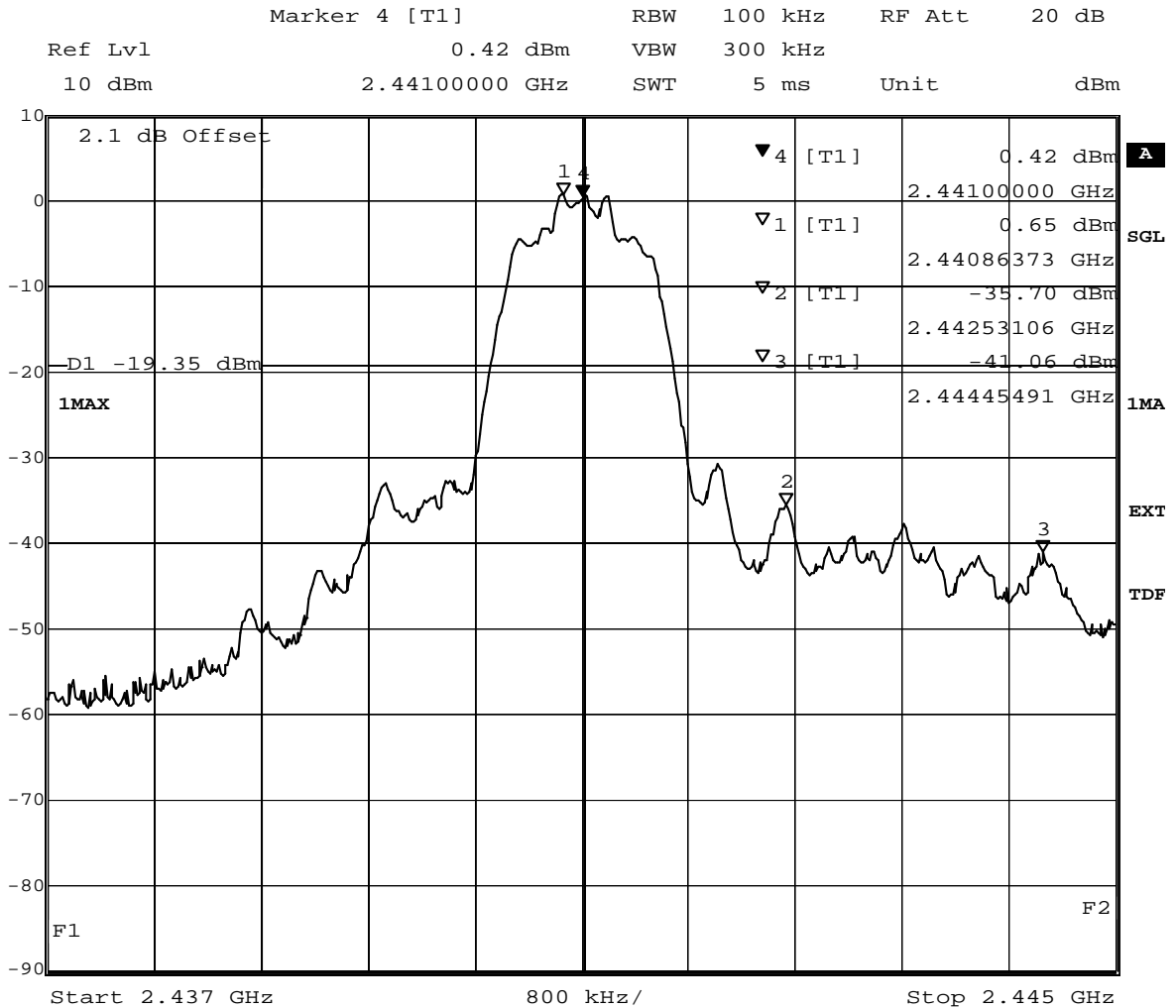

Title: Band Edge Compliance  
 Comment A: CH M: 2441 MHz  
 Date: 2.NOV.2009 14:17:02

(determination of reference value for spurious emissions measurement)

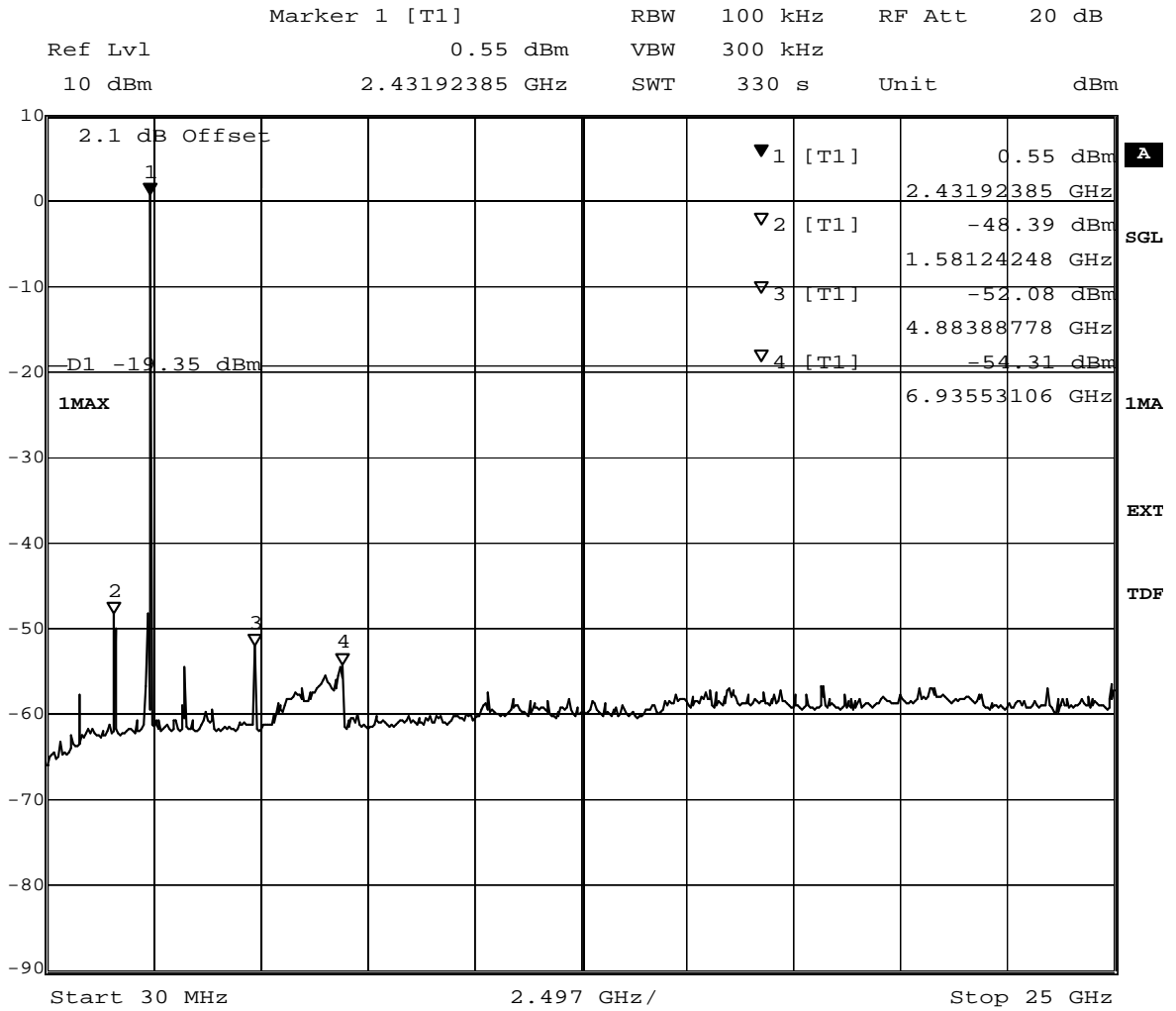

Title: spurious emissions  
 Comment A: CH M: 2441 MHz  
 Date: 2.NOV.2009 14:28:40

(spurious emissions measurement)





### 7.3.9 Band edge compliance conducted operating mode 8

#### Op. Mode

op-mode 8

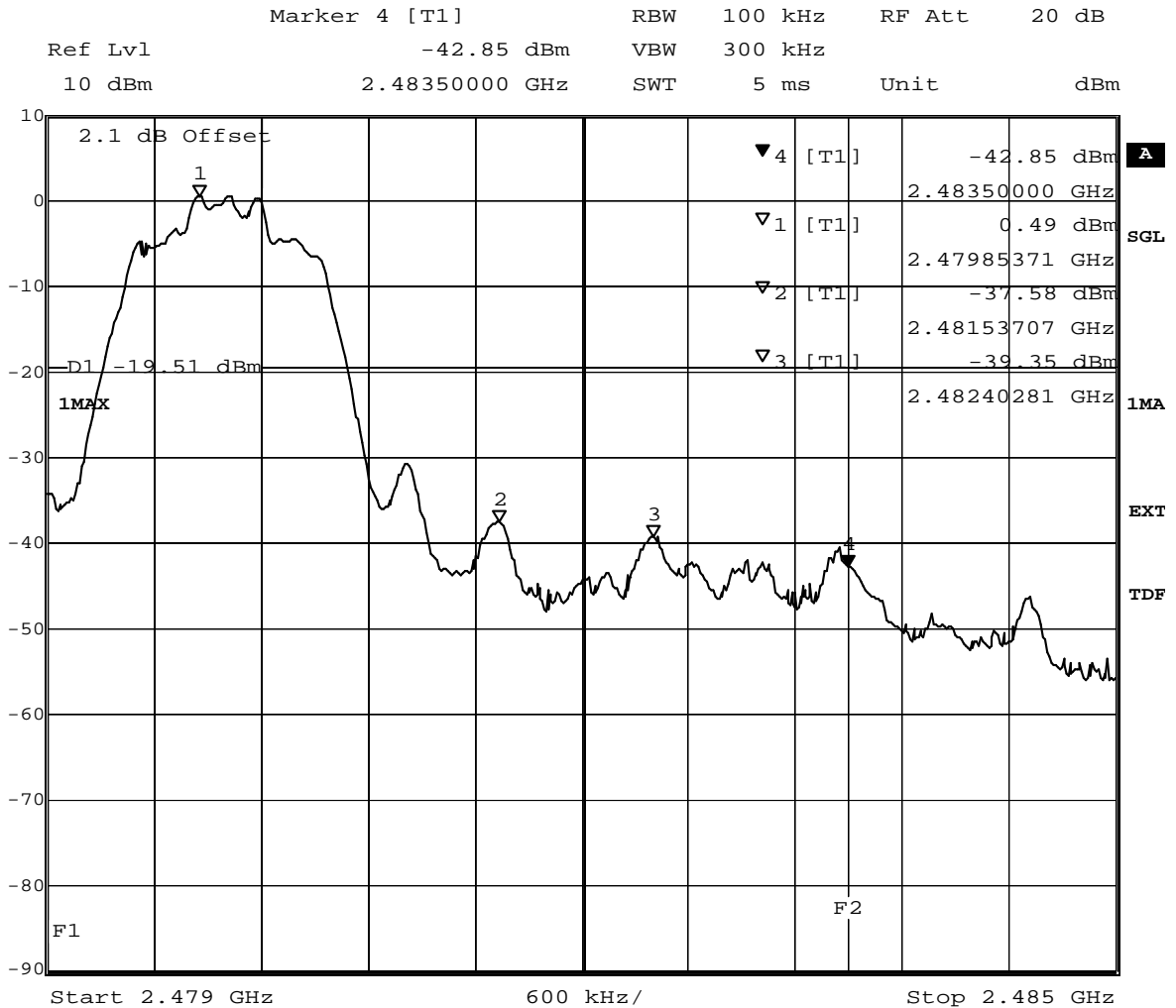

Title: Band Edge Compliance  
 Comment A: CH T: 2480 MHz  
 Date: 2.NOV.2009 14:42:16

(determination of reference value for spurious emissions measurement)



### 7.3.10 Spurious RF conducted emissions operating mode 8

#### Op. Mode

op-mode 8

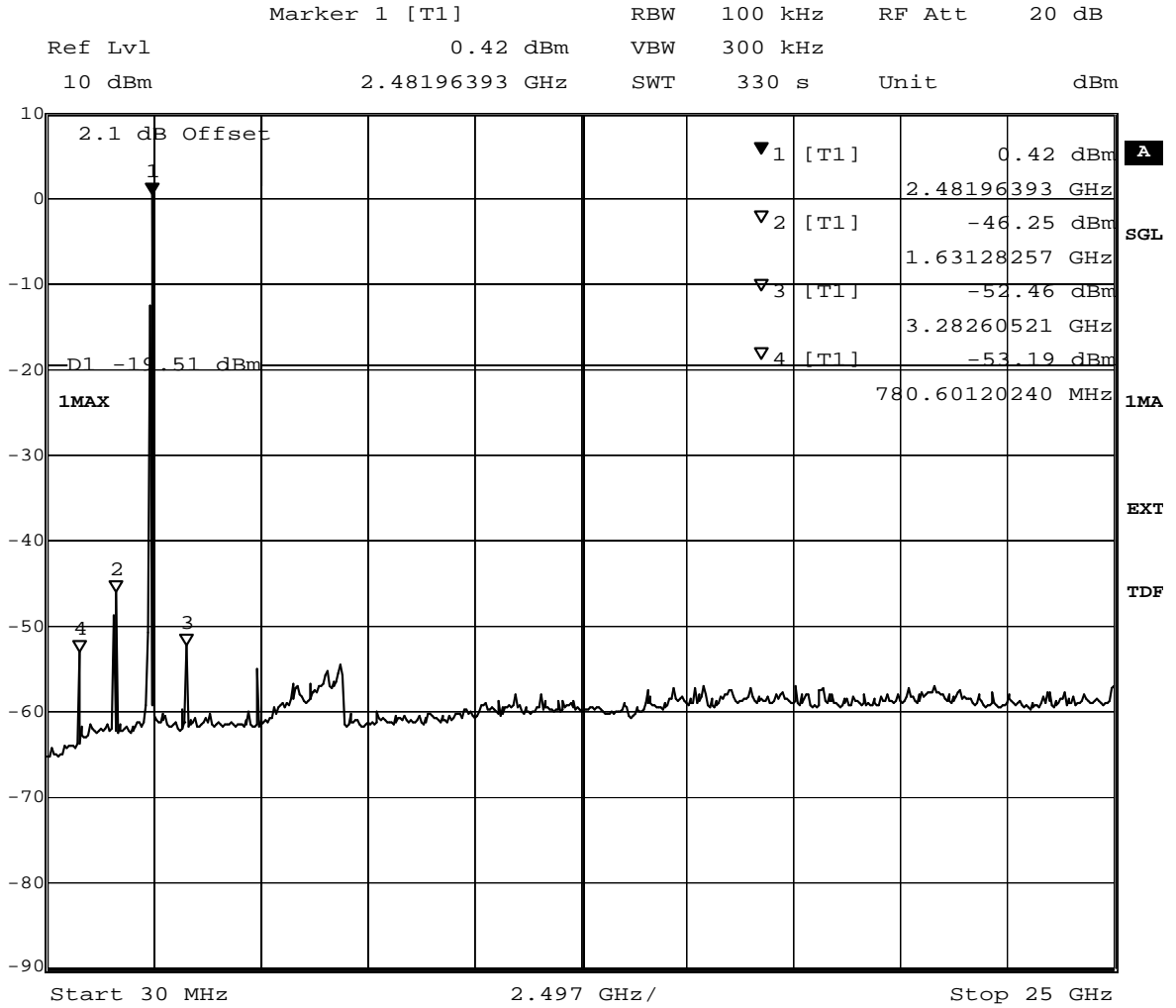

Title: spurious emissions  
 Comment A: CH T: 2480 MHz  
 Date: 2.NOV.2009 14:53:54

(spurious emissions measurement)



### 7.3.11 Band edge compliance conducted operating mode 10

#### Op. Mode

op-mode 10

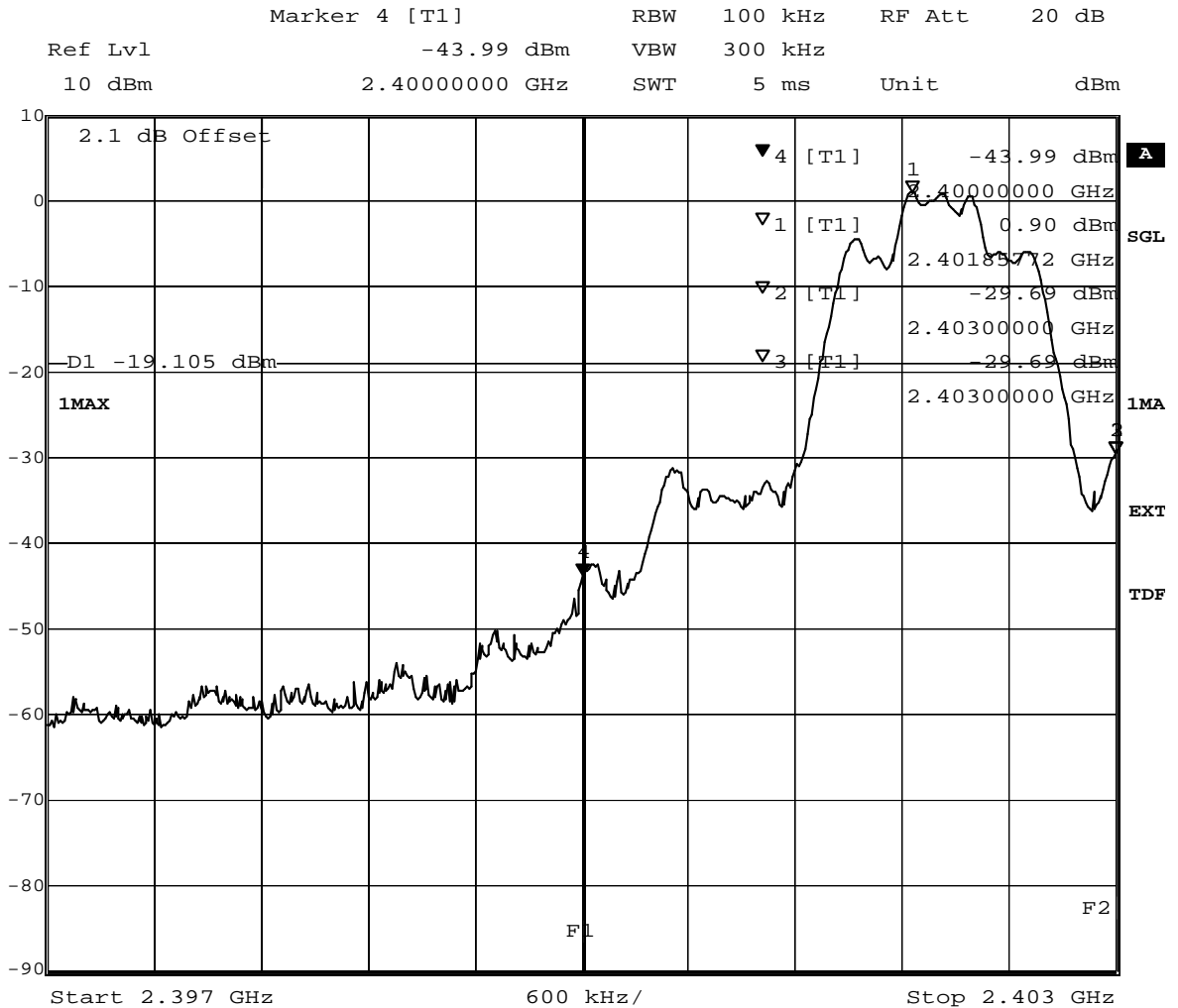

Title: Band Edge Compliance  
 Comment A: CH B: 2402 MHz  
 Date: 2.NOV.2009 11:18:41

(determination of reference value for spurious emissions measurement)



### 7.3.13 Band edge compliance conducted operating mode 11

#### Op. Mode

op-mode 11

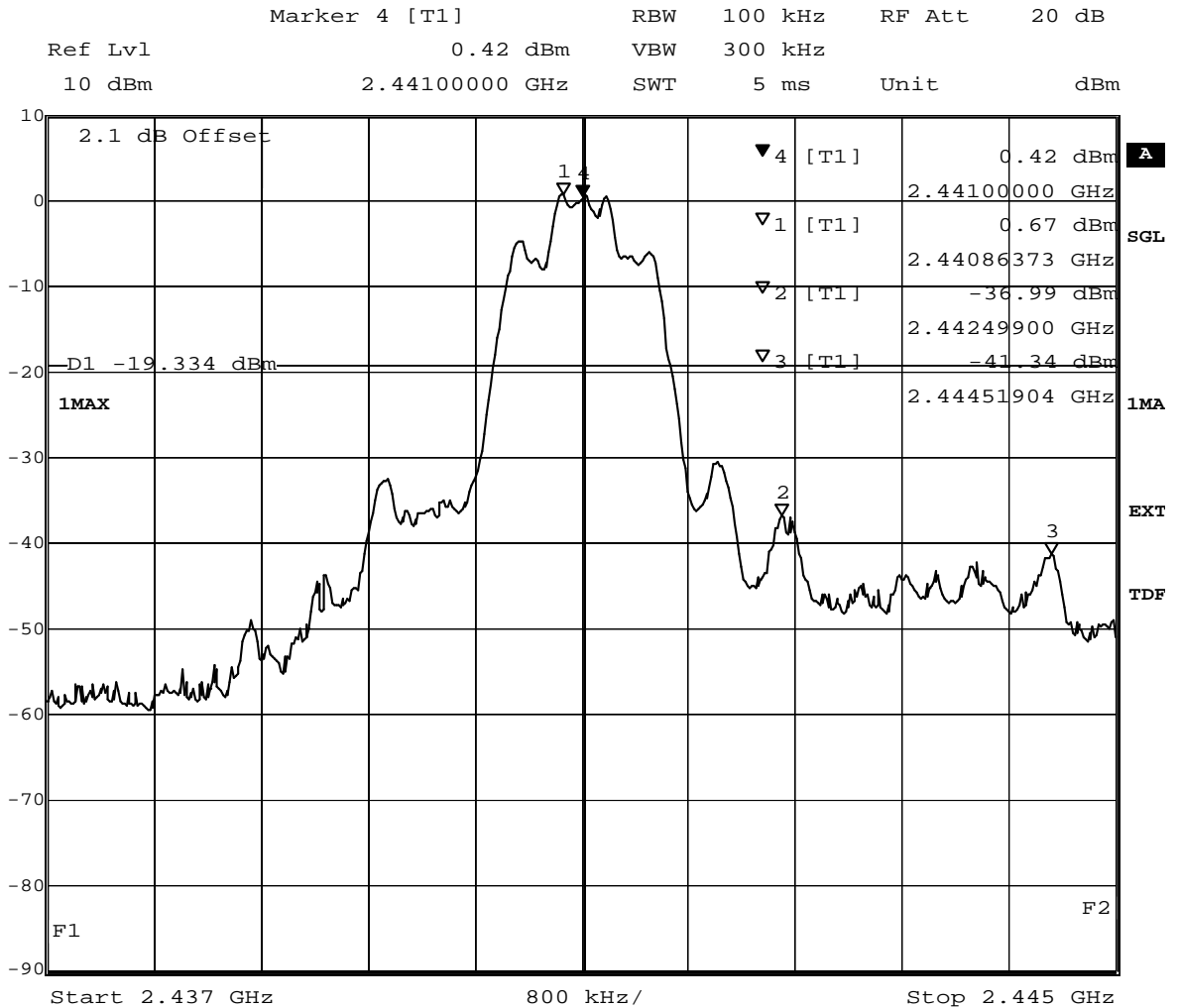

Title: Band Edge Compliance  
 Comment A: CH M: 2441 MHz  
 Date: 2.NOV.2009 11:32:54

(determination of reference value for spurious emissions measurement)



### 7.3.14 Spurious RF conducted emissions operating mode 11

#### Op. Mode

op-mode 11

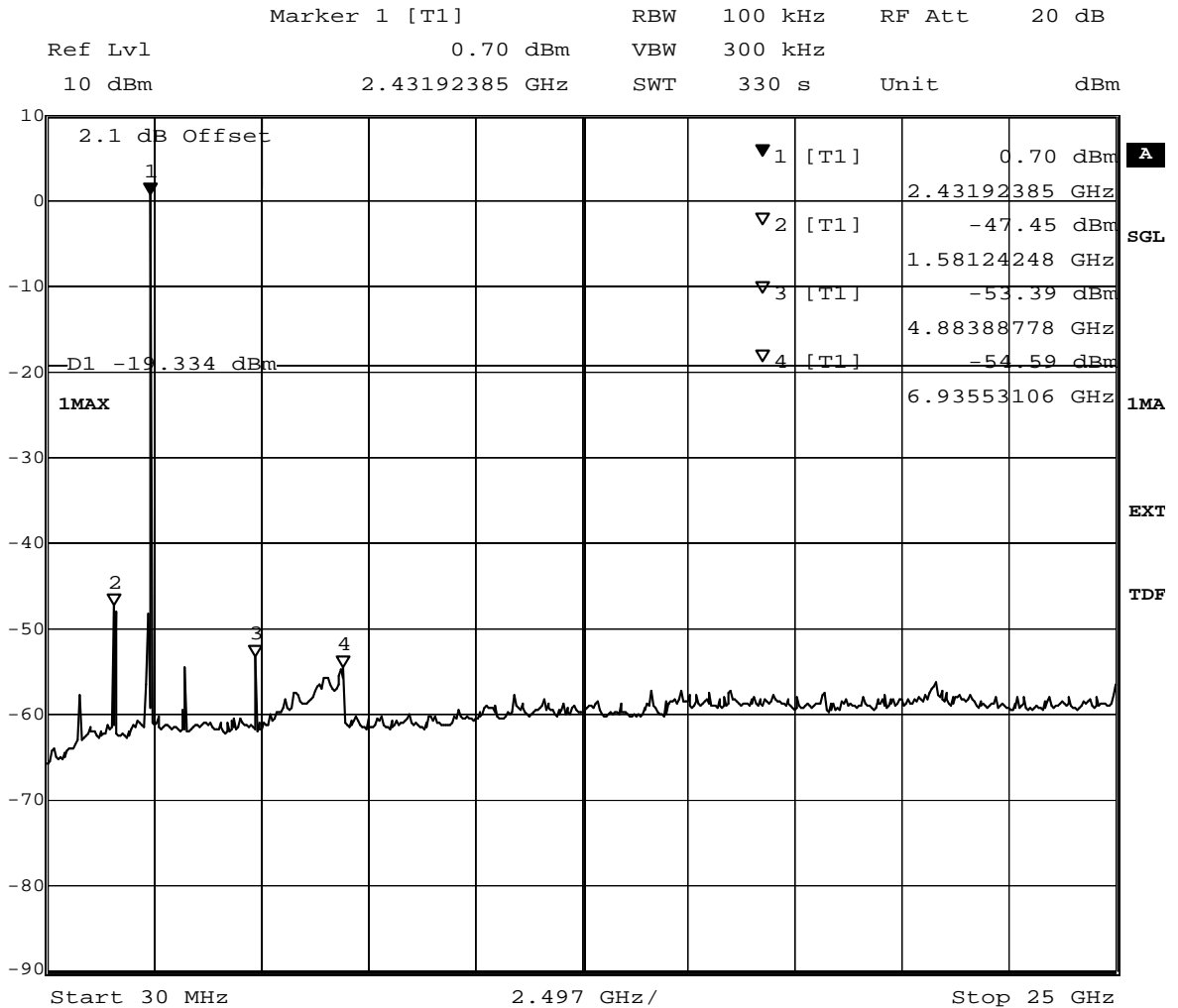

Title: spurious emissions  
 Comment A: CH M: 2441 MHz  
 Date: 2.NOV.2009 11:44:31

(spurious emissions measurement)



7.3.15 Band edge compliance conducted operating mode 12

Op. Mode

op-mode 12

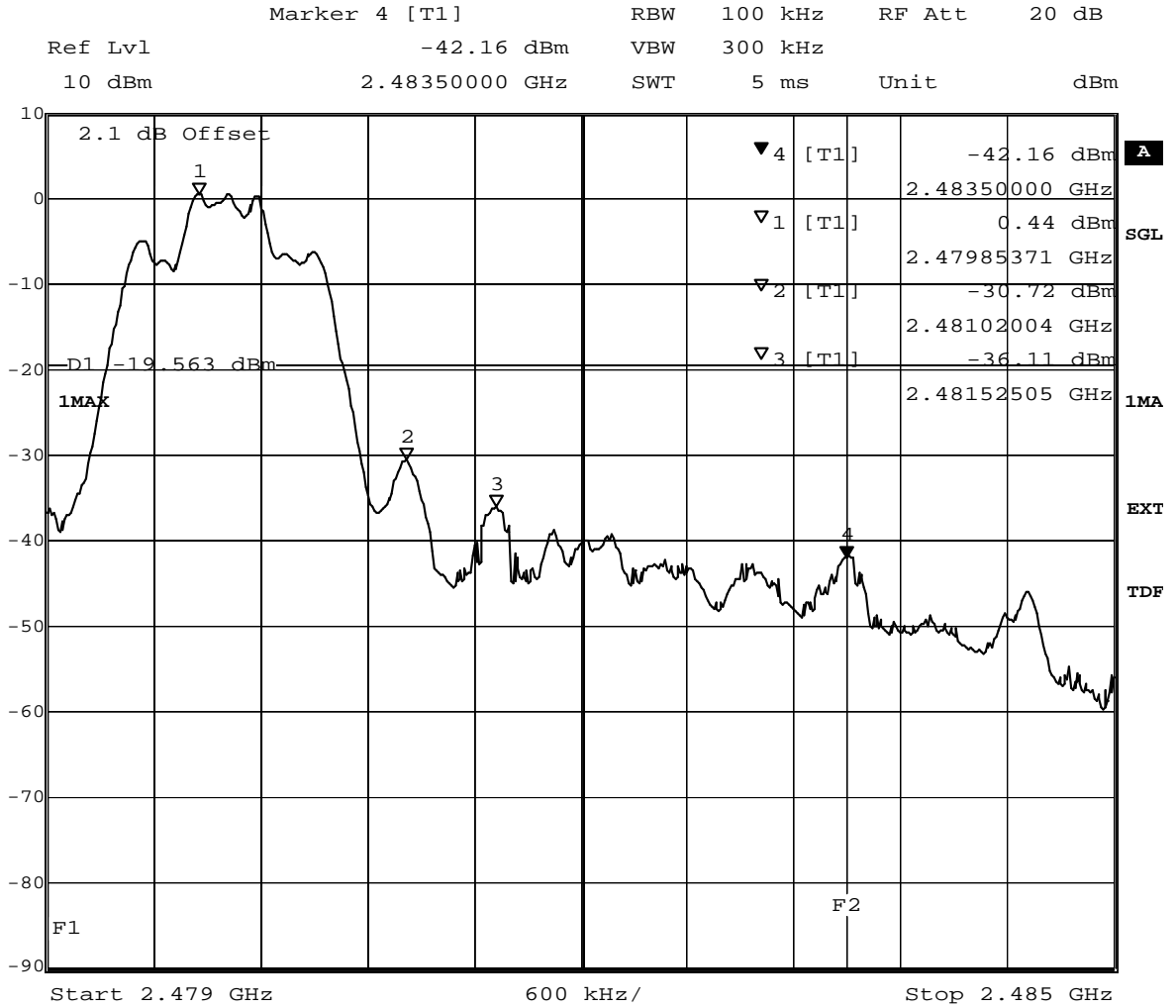

Title: Band Edge Compliance  
 Comment A: CH T: 2480 MHz  
 Date: 2.NOV.2009 12:14:17

(determination of reference value for spurious emissions measurement)



### 7.3.16 Spurious RF conducted emissions operating mode 12

#### Op. Mode

op-mode 12

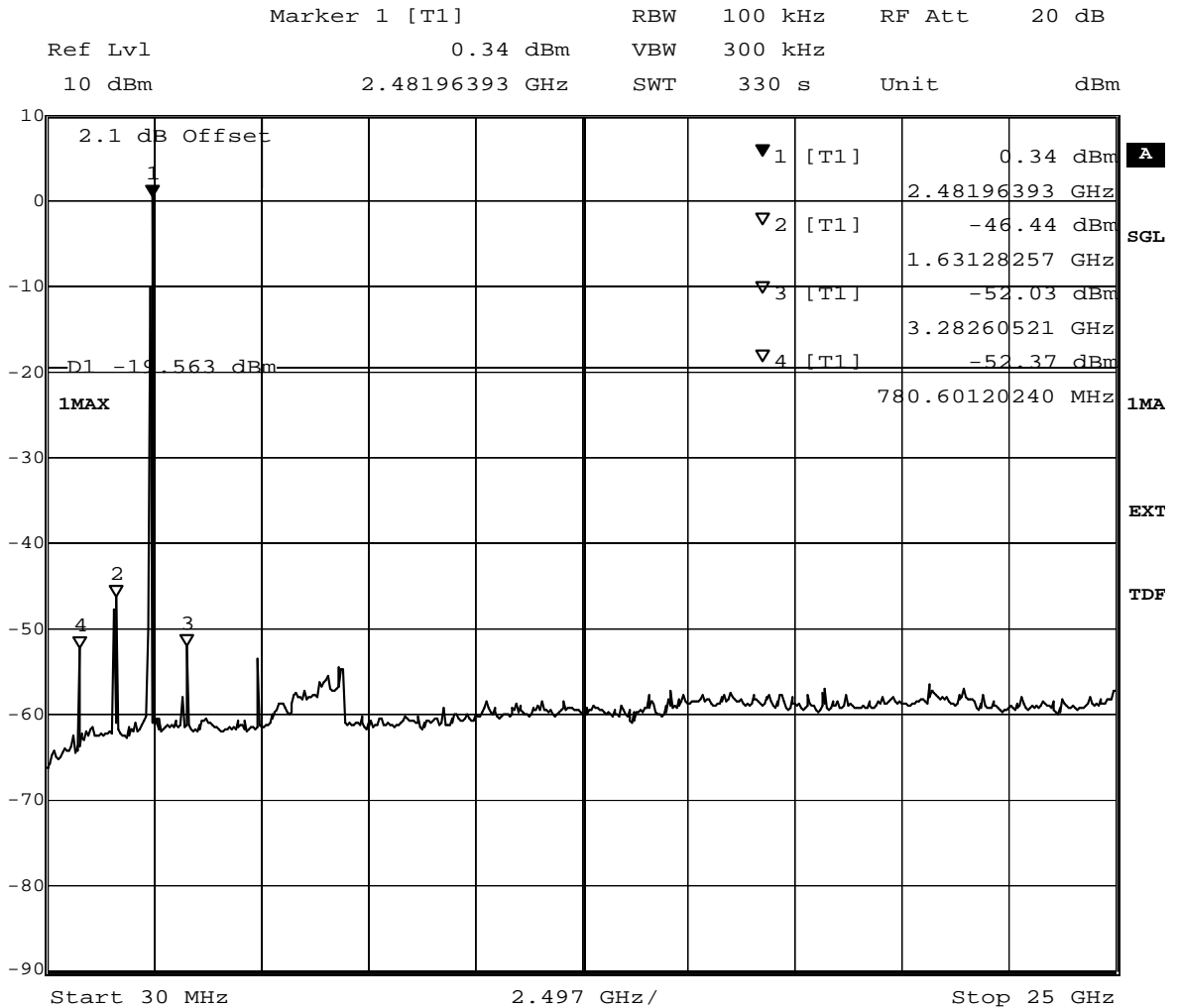

Title: spurious emissions  
 Comment A: CH T: 2480 MHz  
 Date: 2.NOV.2009 12:25:54

(spurious emissions measurement)



## 7.4 Band edge compliance radiated

### 7.4.1 Band edge compliance radiated operating mode 3

#### Op. Mode

op-mode 3

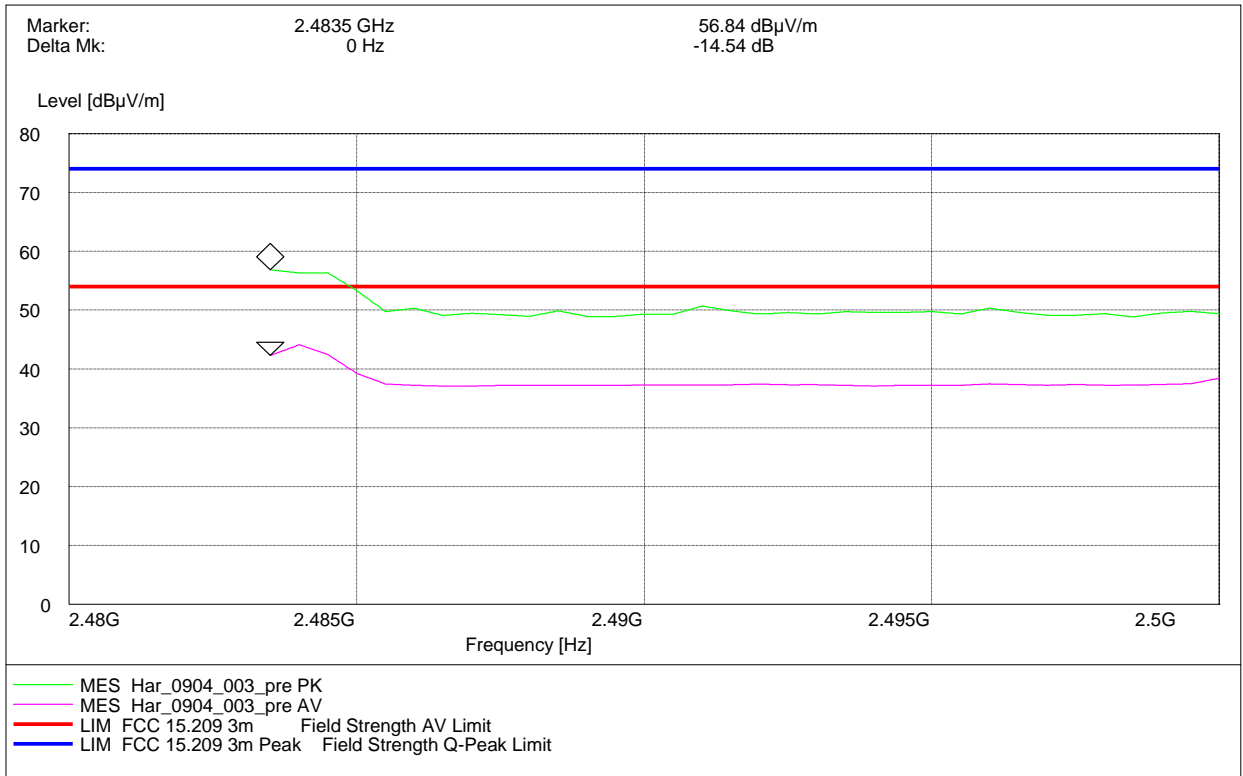

Radiated measurement (higher band edge)

### 7.4.2 Band edge compliance radiated operating mode 8

#### Op. Mode

op-mode 8

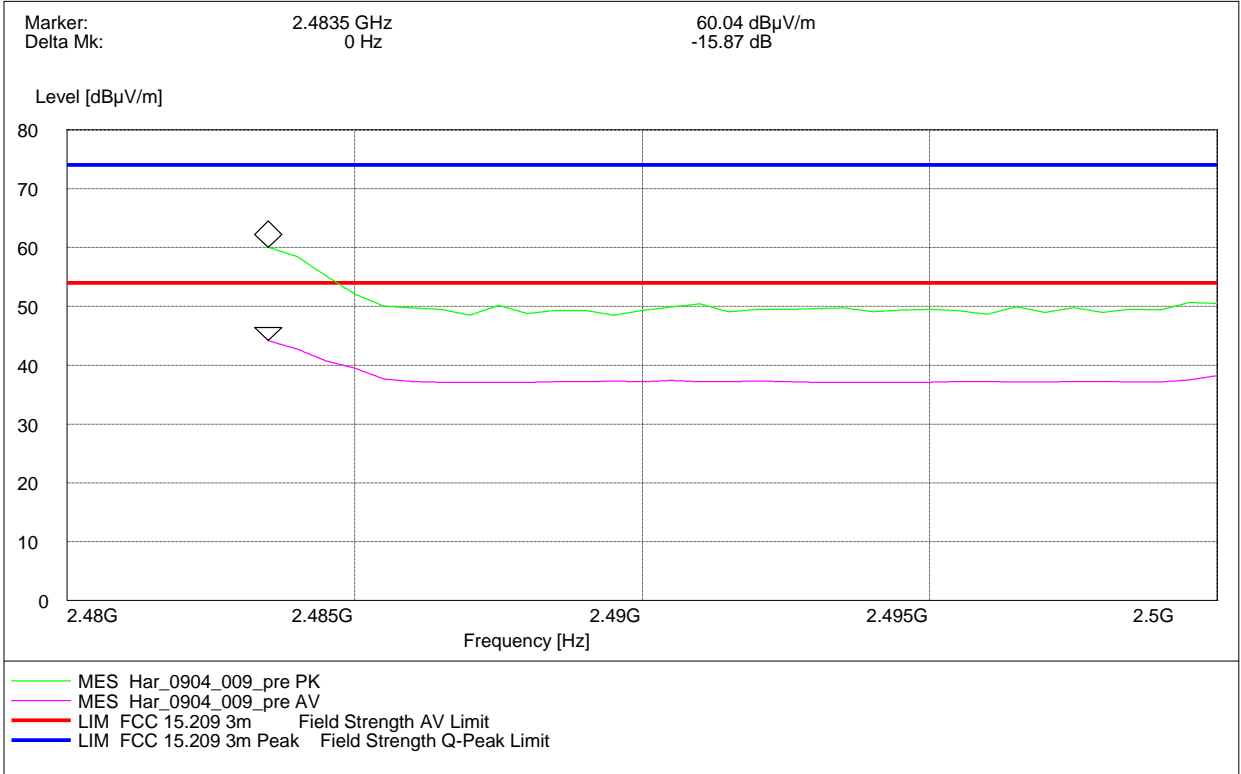

Radiated measurement (higher band edge)

### 7.4.3 Band edge compliance radiated operating mode 12

#### Op. Mode

op-mode 12

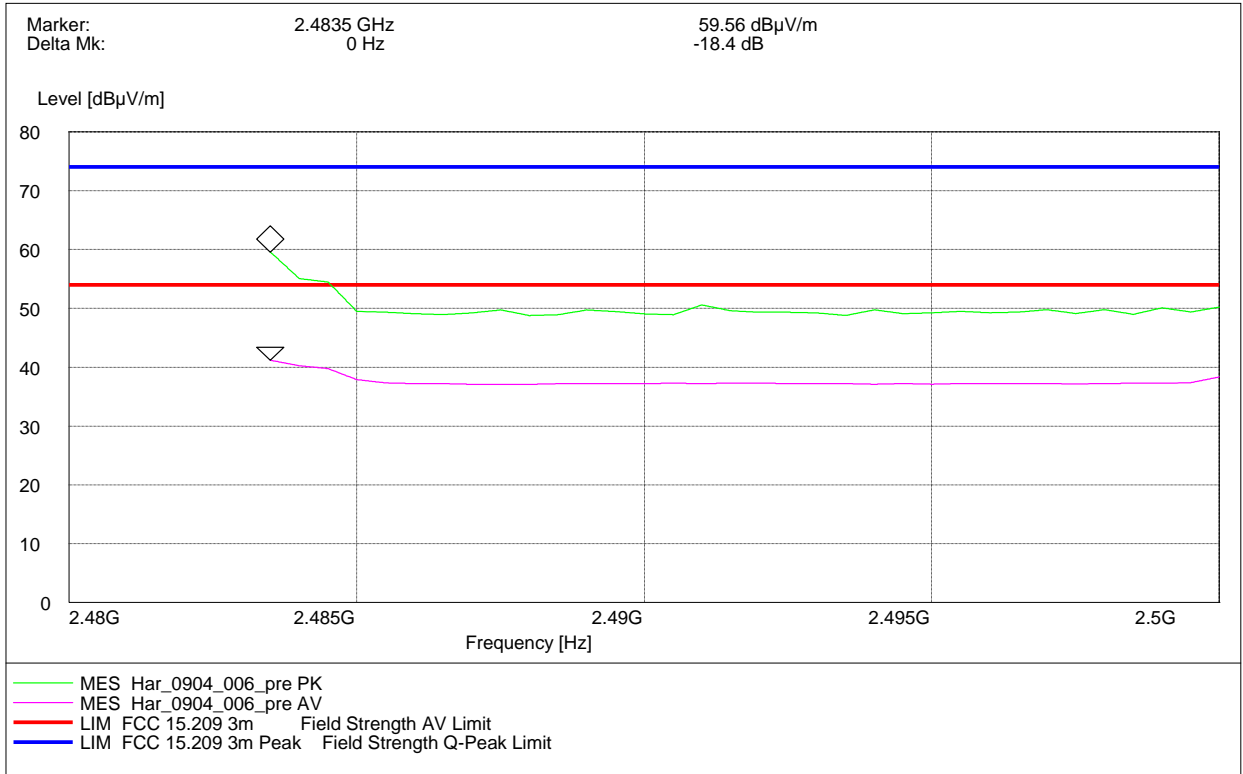

Radiated measurement (higher band edge)

## 7.5 Radiated emissions (f < 30 MHz)

### Op. Mode

op-mode 1

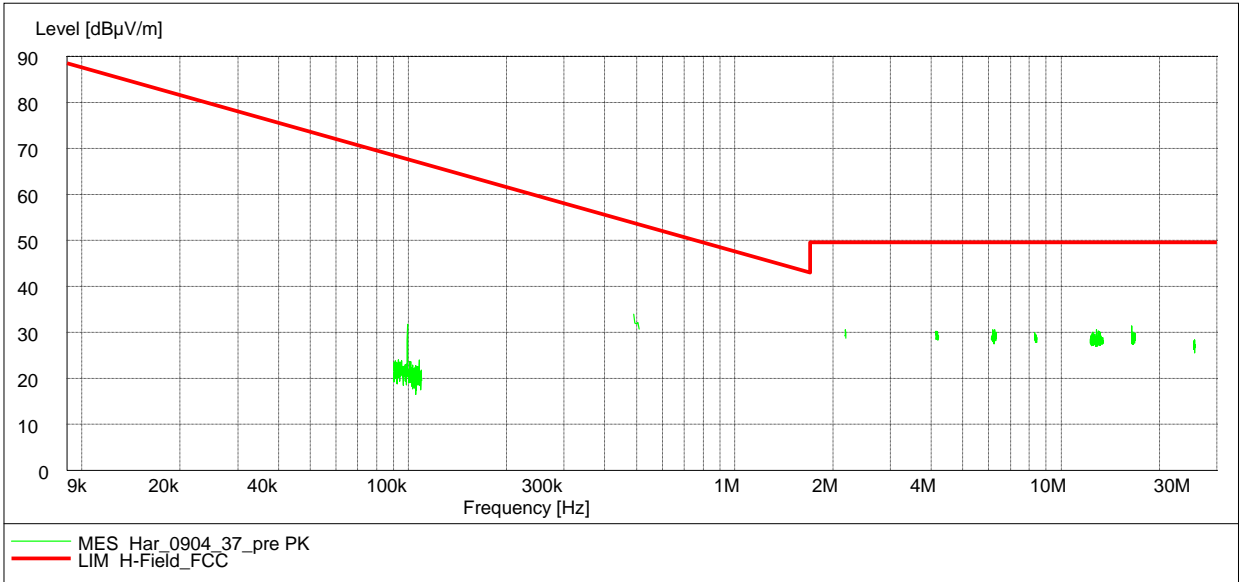

Antenna position 90°  
EUT position front side

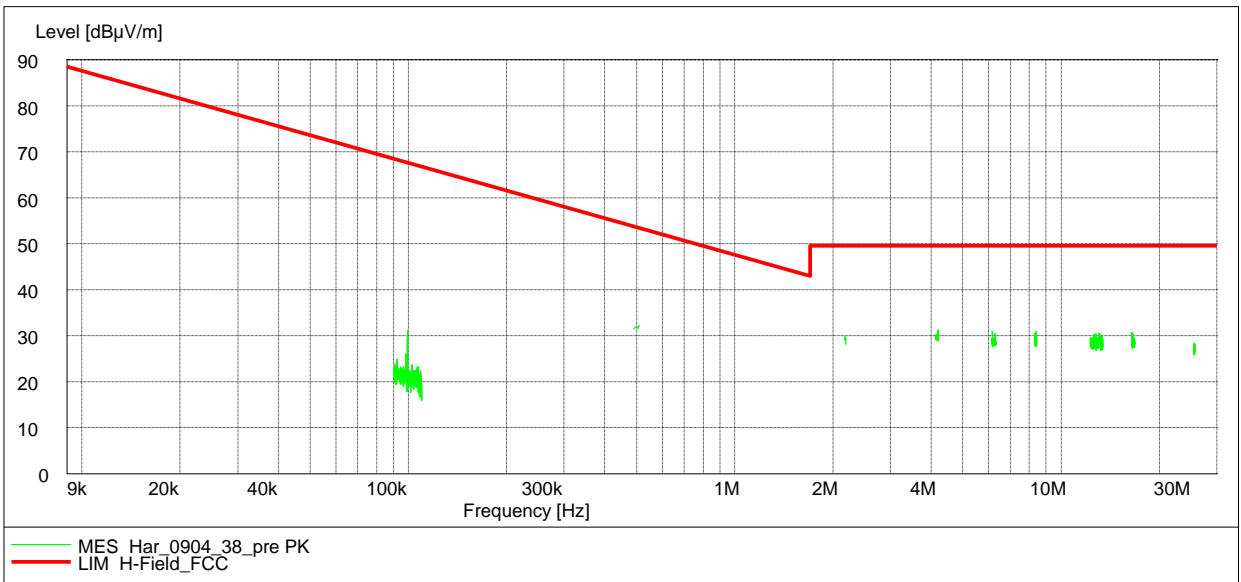

Antenna position 90°  
EUT position right side

**Op. Mode**

op-mode 1

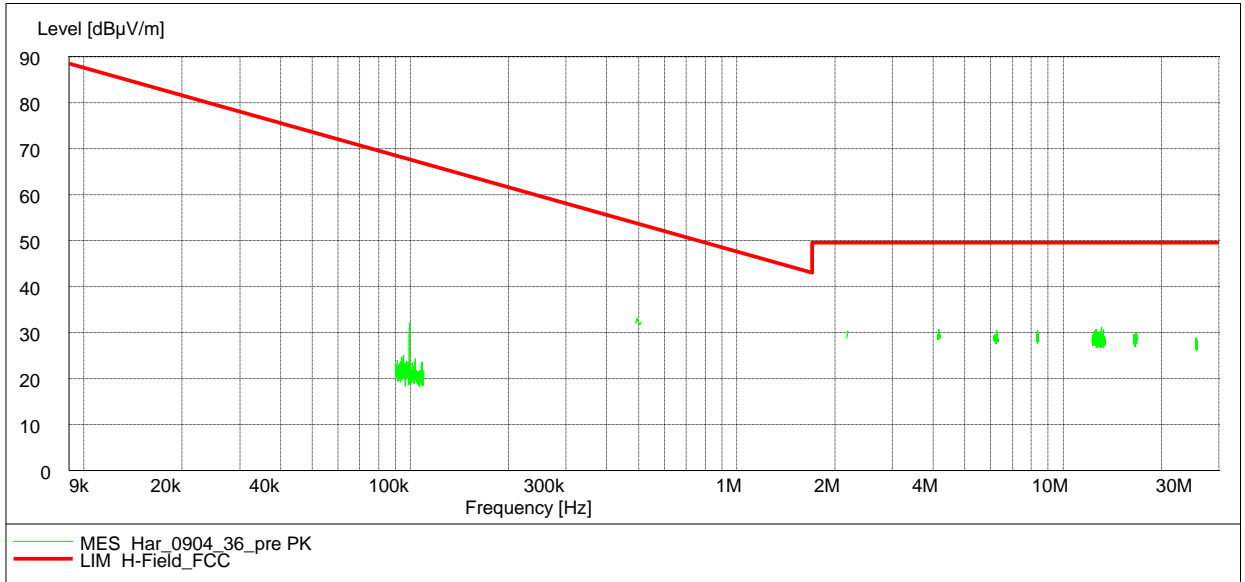

Antenna position 0°  
EUT position front side

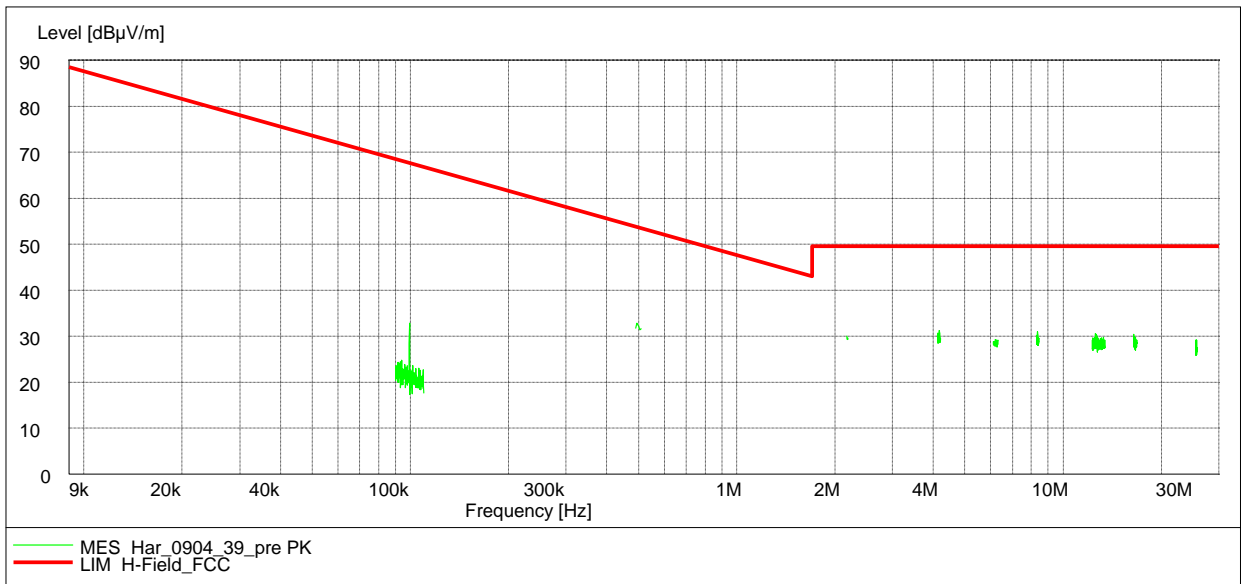

Antenna position 0°  
EUT position right side



## 7.6 Dwell time

### Op. Mode

op-mode 2 Time slot measurement of a DH5 packet

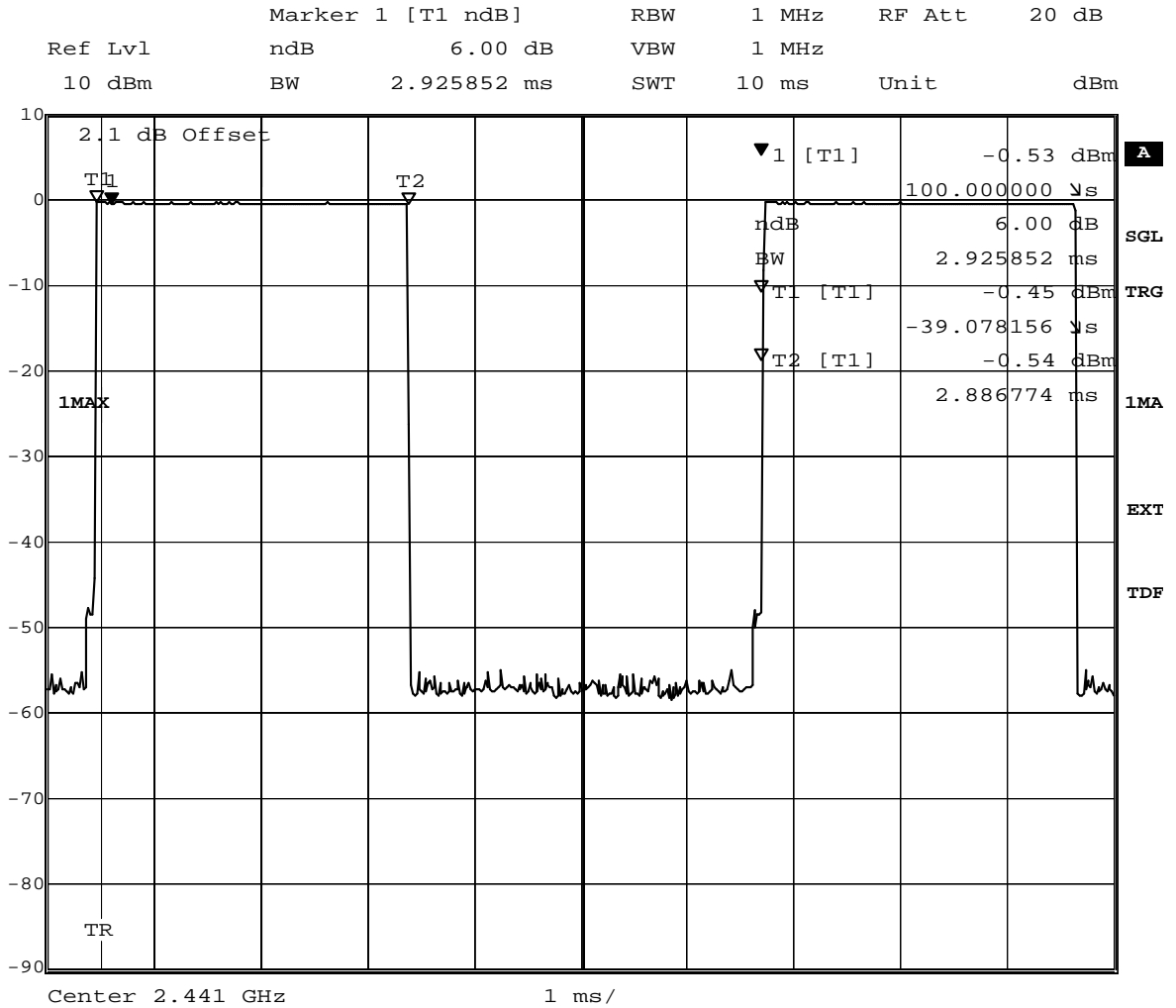

Title: Dwell time  
 Comment A: CH M: 2441 MHz  
 Date: 2.NOV.2009 11:17:14



## 7.7 Channel separation

### Op. Mode

op-mode 4

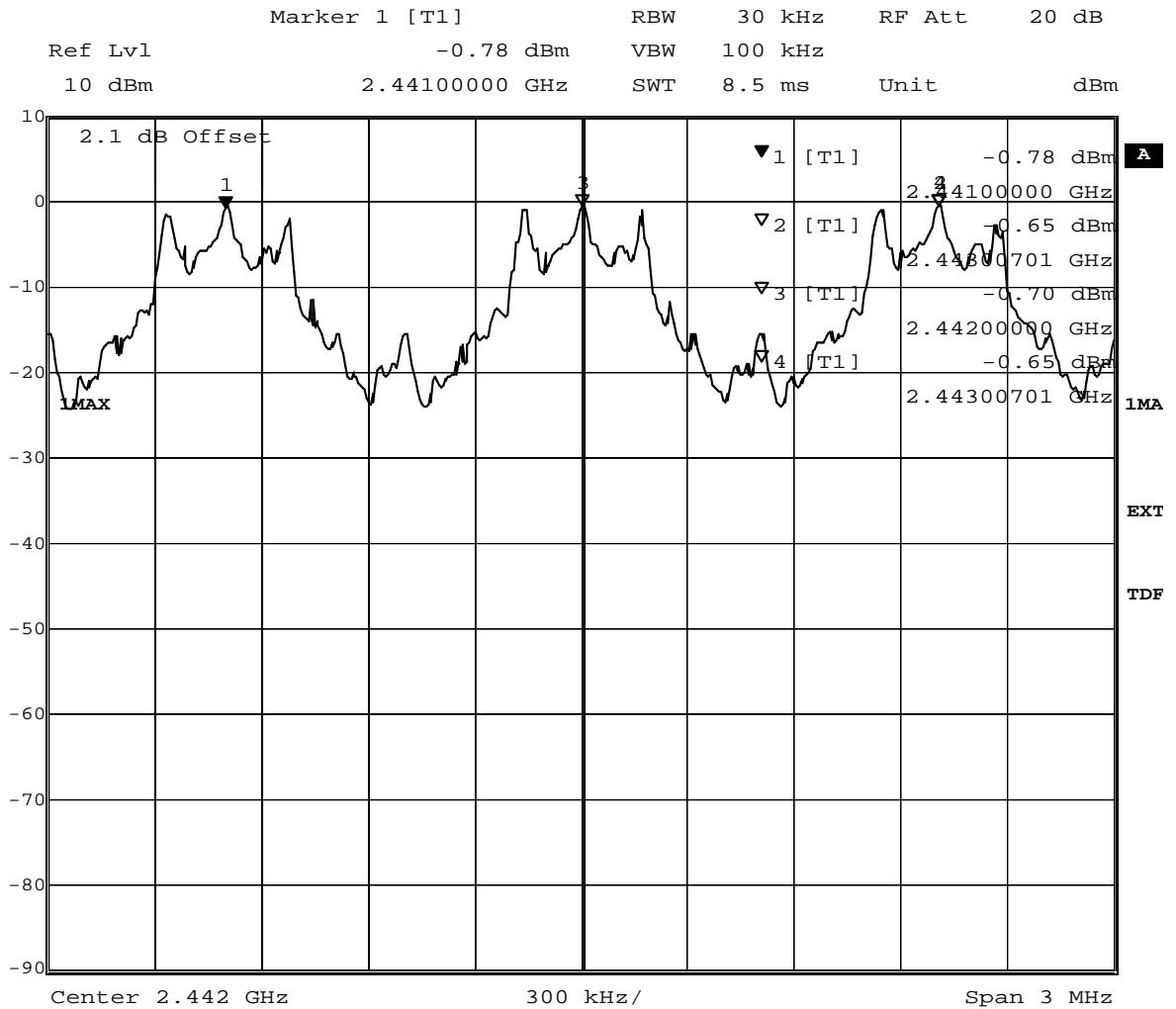

Title: Number of hopping frequencies  
 Comment A: CH H: Hopping  
 Date: 2.NOV.2009 11:12:56



## 7.8 Number of hopping frequencies

### Op. Mode

op-mode 4

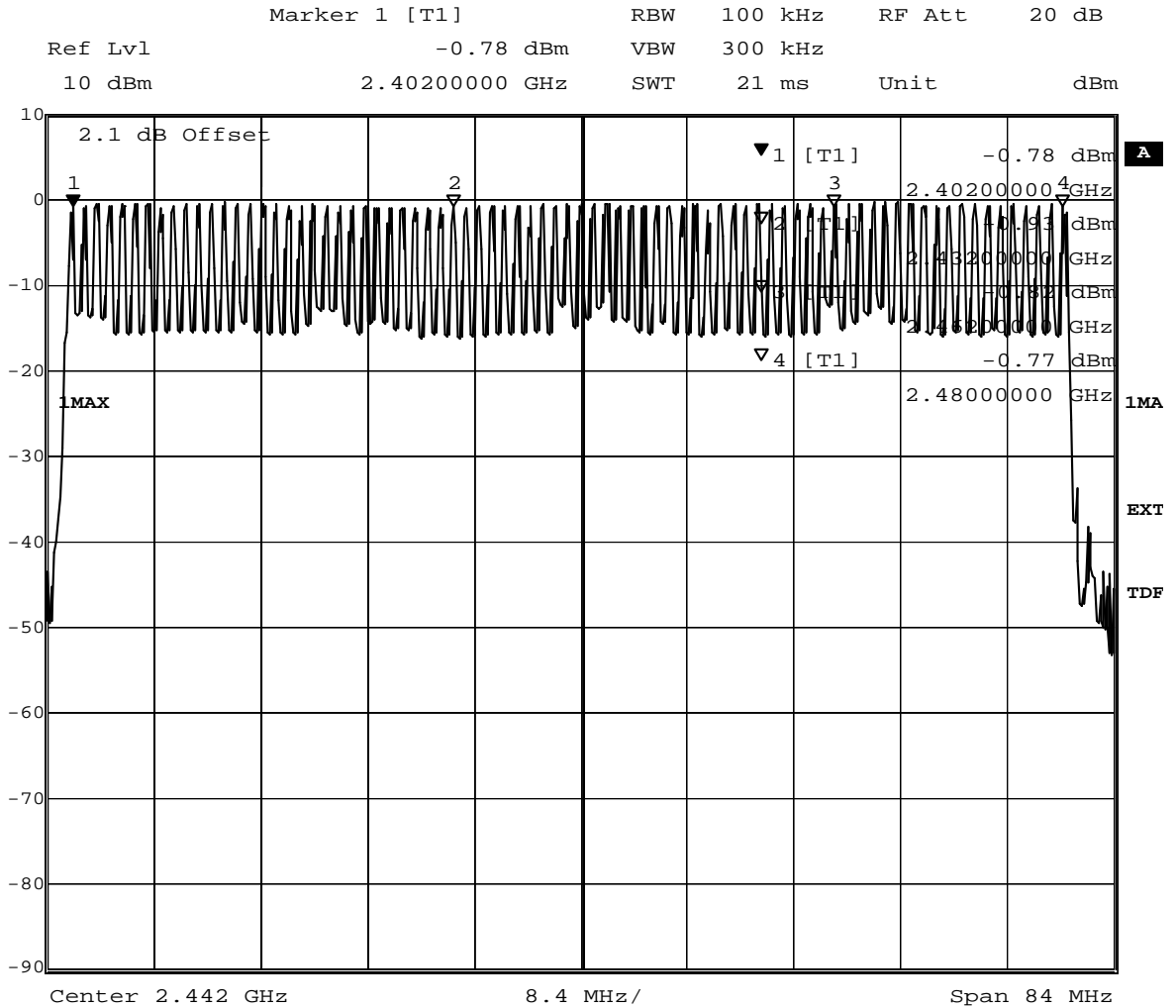

Title: Number of hopping frequencies  
Comment A: CH H: Hopping  
Date: 2.NOV.2009 11:15:26