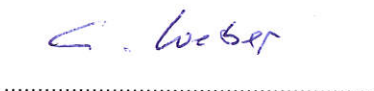

RADIO REPORT FCC 47 CFR Part 15C ISED Canada RSS-247 Digital transmission systems operating within the 2400 – 2483.5 MHz band	
Report Reference No	G0M-1702-6284-TFC247BL-V03
Testing Laboratory	Eurofins Product Service GmbH
Address	Storkower Str. 38c 15526 Reichenwalde Germany
Accreditation	 <p>A2LA Accredited Testing Laboratory, Certificate No.: 1983.01 FCC Filed Test Laboratory, Reg.-No.: 96970 IC Testing Laboratory site: 3470A-2</p>
Applicant	Panasonic Industrial Devices Europe GmbH
Address	Zeppelinstr. 19 21337 Lüneburg GERMANY
Test Specification	According to FCC/ISED rules
Standard	47 CFR Part 15C RSS-247, Issue 1, 2015-05
Non-Standard Test Method	None
Test Scope	Partial radio compliance test
Equipment under Test (EUT):	
Product Description	Class 2 Bluetooth Low Energy Module
Model(s)	ENW89837A5KF
Additional Model(s)	None
Brand Name(s)	PAN1026A
Hardware Version(s)	01
Software Version(s)	01
FCC-ID	T7VPAN10
IC	216Q-PAN10
Test Result	PASSED

Possible test case verdicts:		
required by standard but not tested	N/T	
not required by standard	N/R	
test object does meet the requirement	P(PASS)	
test object does not meet the requirement	F(FAIL)	
Testing:		
Test Lab Temperature	20 - 23 °C	
Test Lab Humidity	32 – 38 %	
Date of receipt of test item	2017-30-03	
Report:		
Compiled by	Wilfried Treffke	
Tested by (+ signature) (Responsible for Test)	Wilfried Treffke	
Approved by (+ signature) (Head of Lab)	Christian Weber	
Date of Issue	2017-07-28	
Total number of pages	75	
General Remarks:		
<p>The test results presented in this report relate only to the object tested.</p> <p>The results contained in this report reflect the results for this particular model and serial number. It is the responsibility of the manufacturer to ensure that all production models meet the intent of the requirements detailed within this report.</p> <p>This report shall not be reproduced, except in full, without the written approval of the Issuing testing laboratory.</p>		
Additional Comments:		
Partial test / Test selection for Class II Permissive change according to permissive change letter.		

VERSION HISTORY

Version History			
Version	Issue Date	Remarks	Revised By
01	2017-05-10	Initial Release	
02	2017-07-22	Model name; Hardware and Software corrected.	W. Treffke
03	2017-07-28	PMN corrected	C. Weber

ABBREVIATIONS AND ACRONYMS

Acronyms	
Acronym	Description
EUT	Equipment Under Test
FCC	Federal Communications Commission
ISED	Innovation, Science and Economic Development Canada
RBW	Resolution bandwidth
RMS	Root mean square
VBW	Video bandwidth
V _{NOM}	Nominal supply voltage

REPORT INDEX

1	Equipment (Test Item) Under Test.....	6
1.1	Photos – Equipment External.....	7
1.2	Photos – Equipment Internal.....	9
1.3	Photos – Test Setup.....	10
1.4	Support Equipment.....	11
1.5	Test Modes	12
1.6	Test Frequencies.....	13
1.7	Sample emission level calculation.....	14
2	Result Summary.....	15
3	Test Conditions and Results.....	16
3.1	Test Conditions and Results - Occupied bandwidth.....	16
3.2	Test Conditions and Results - Maximum peak conducted output power	20
3.3	Test Conditions and Results - Band-edge compliance.....	22
3.4	Test Conditions and Results - Conducted spurious emissions.....	25
3.5	Test Conditions and Results - Transmitter radiated emissions	29
3.6	Test Conditions and Results - Receiver radiated emissions	32
ANNEX A	Transmitter spurious emissions	34
ANNEX B	Receiver spurious emissions	66

1 Equipment (Test Item) Under Test

Description	Class 2 Bluetooth Low Energy Module	
Model	ENW89837A5KF	
Additional Model(s)	None	
Brand Name(s)	PAN1026A	
Serial Number(s)	12653	
Hardware Version(s)	01	
Software Version(s)	01	
PMN	PAN1026A	
HVIN	ENW89837A5KF	
FVIN	N/A	
HMN	N/A	
FCC-ID	T7VPAN10	
IC	216Q-PAN10	
Equipment type	Radio Module	
Radio type	Transceiver	
Assigned frequency bands	2400 - 2483.5 MHz	
Radio technology	Bluetooth LE	
Modulation	GFSK	
Number of antenna ports	1	
Antenna	Type	Integrated
	Model	ANT2012LL13R2400A
	Manufacturer	Yageo
	Gain	0.8 dBi (from declaration)
Supply Voltage	V_{NOM}	3.3 VDC
Operating Temperature	T_{NOM}	25 °C
AC/DC-Adaptor	Model	N/A
	Vendor	N/A
	Input	N/A
	Output	N/A
Manufacturer	Panasonic Industrial Devices Europe GmbH Zeppelinstr. 19 21337 Lüneburg GERMANY	

1.1 Photos – Equipment External

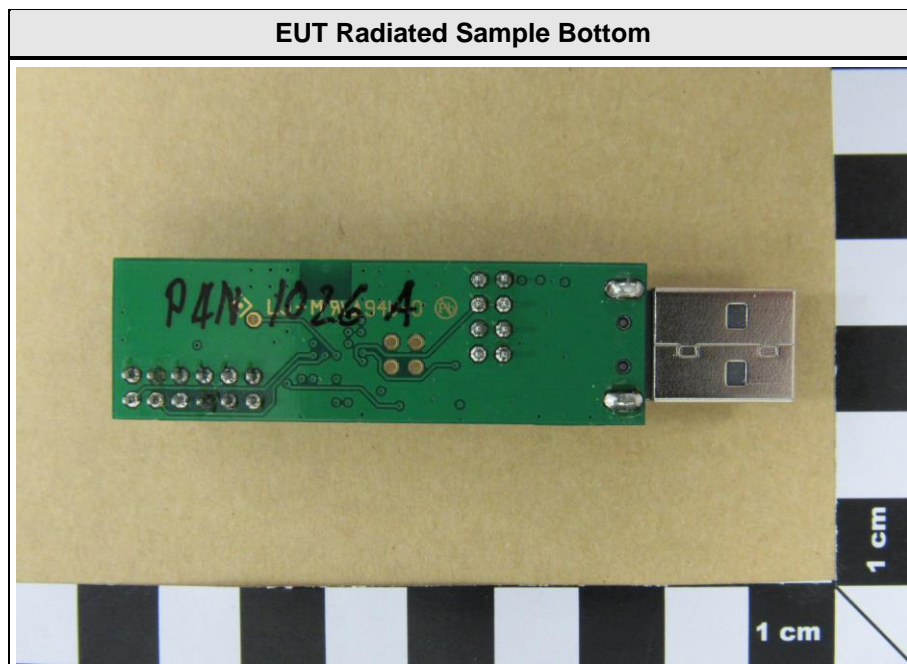
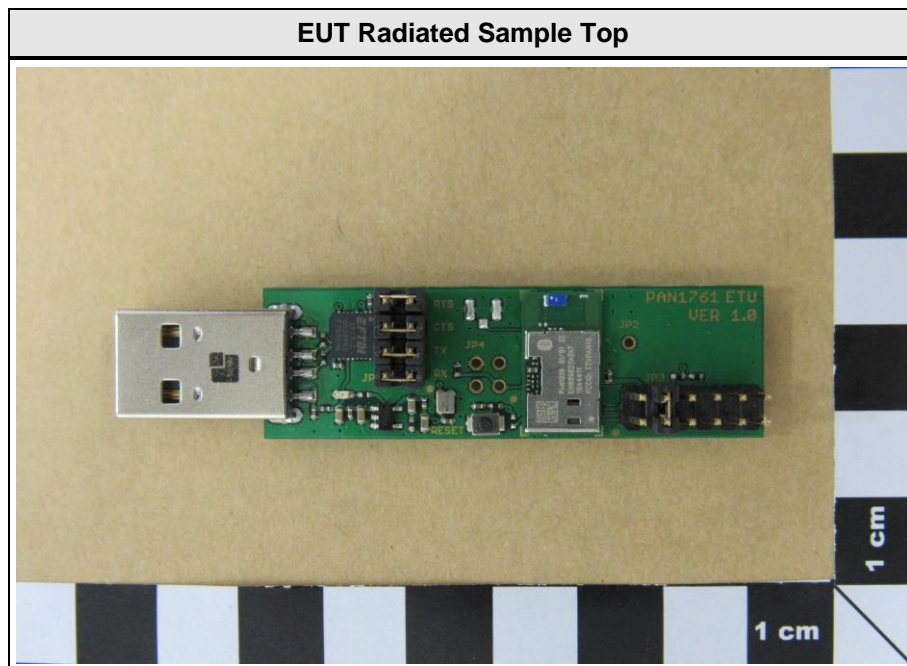

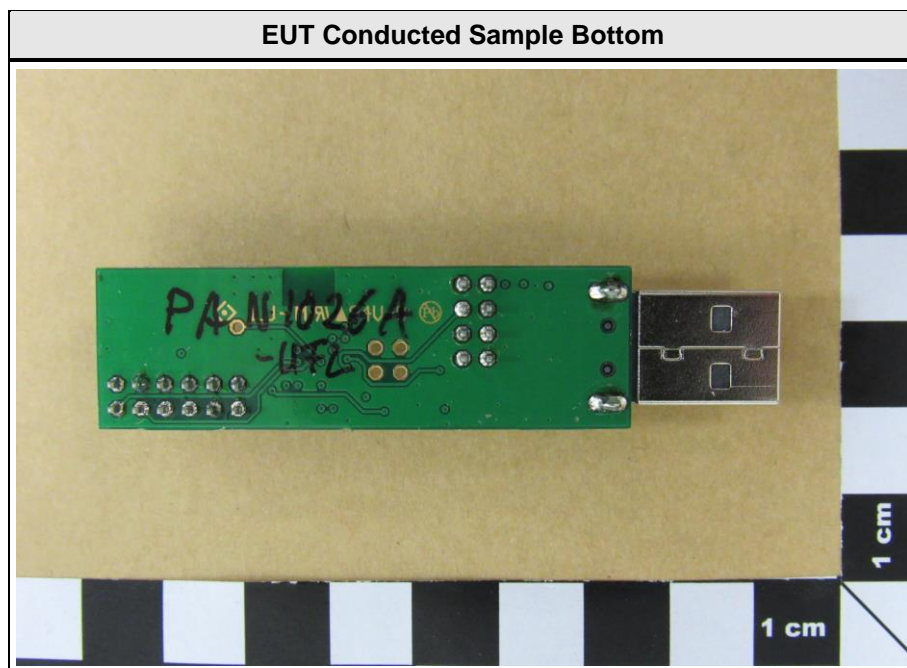
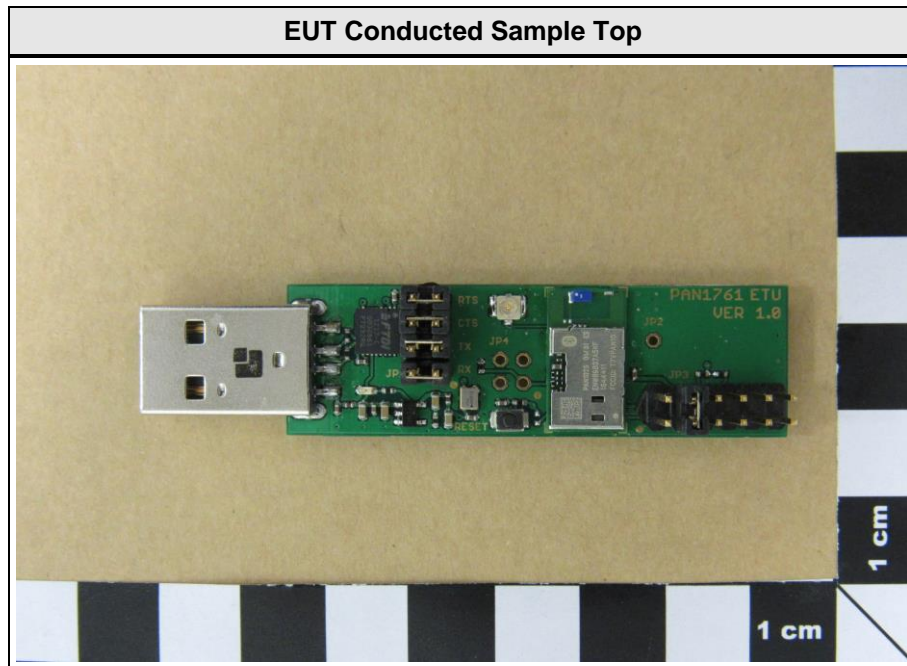

1.2 Photos – Equipment Internal

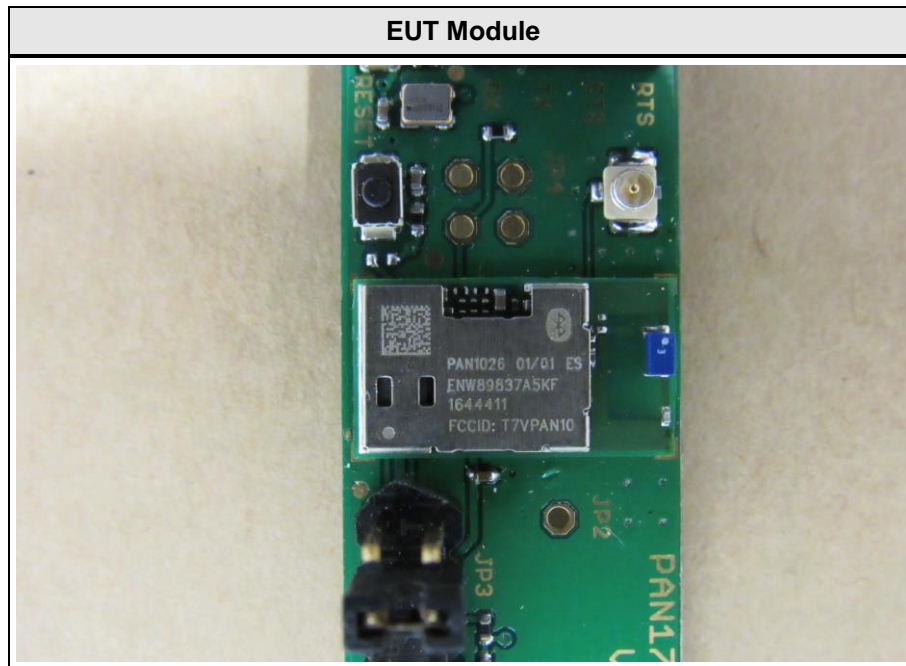

1.3 Photos – Test Setup

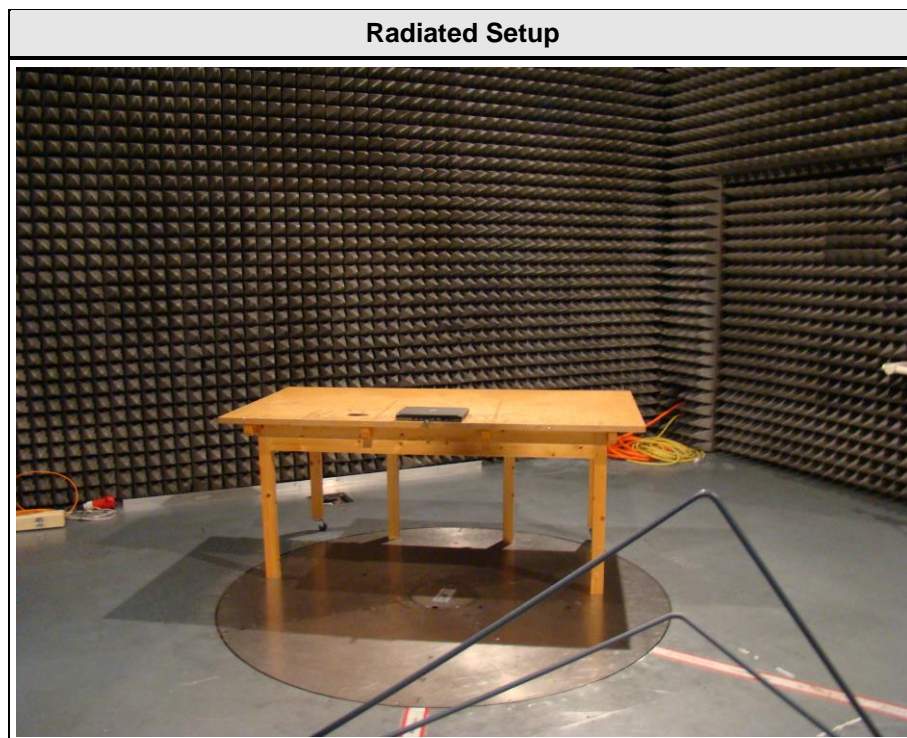
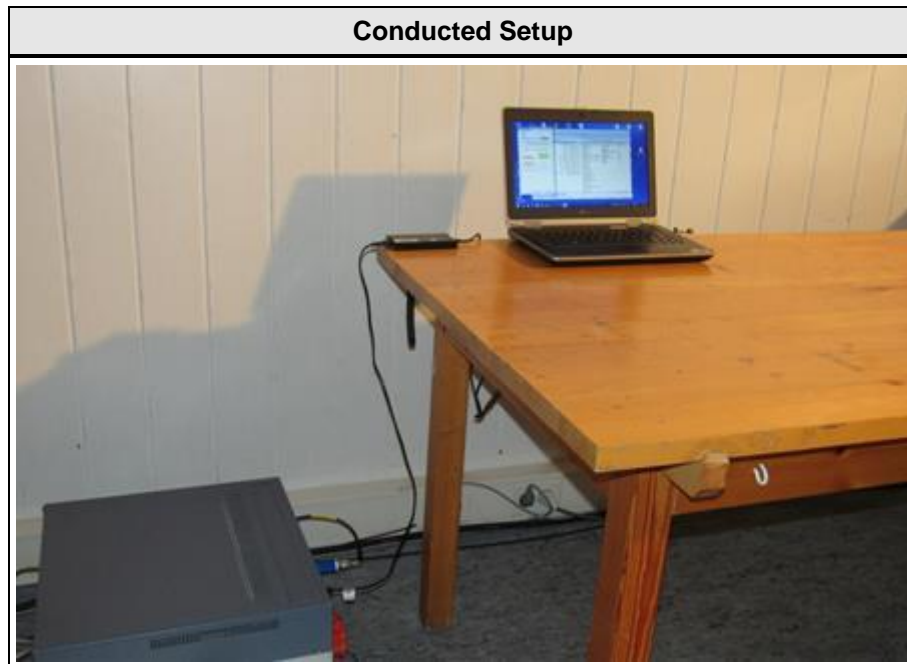

1.4 Support Equipment

Product Type	Device	Manufacturer	Model	Comment
AE	Power Supplay	Dell	FA65NE0-00	S/N RX929
AE	Laptop	Dell	Latitude E6420	S/N HPJ4R1
Description:				
AE	Auxillary Equipment			
SIM	Simulator			
CBL	Connecting Cable			
Comment:				

1.5 Test Modes

Mode	Description
GFSK	Mode = Transmit Modulation = GFSK Spreading = None Duty cycle = 100%
Receive	Mode = Receive
Comment:	

1.6 Test Frequencies

Designator	Mode	Channel	Frequency [MHz]
F1	Tx / Rx	0	2402
F2	Tx / Rx	19	2440
F3	Tx / Rx	39	2480

1.7 Sample emission level calculation

The following is a description of terms and a sample calculation, as appears in the radiated emissions data table. The numbers used in the calculation are for example only. There is no direct correlation to the specific data taken for the product described in this document:

Reading:

This is the reading obtained on the spectrum analyzer in dBµV. Any external preamplifiers used are taken into account through internal analyzer settings.

A.F.:

This is the antenna factor for the receiving antenna. It is a conversion factor, which converts electric fields strengths to voltages, which can be measured directly on the spectrum analyzer. It is treated as a loss in dB. Cable losses have been included with the A.F. to simplify the calculations. The antenna factor is used in calculations as follows:

$$\text{Reading on Analyzer (dB}\mu\text{V)} + \text{A.F. (dB)} = \text{Net field strength (dB}\mu\text{V/m)}$$

Net:

This is the net field strength measurement (as shown above).

Limit:

This is the FCC Class B radiated emission limit (in units of dBµV/m). The FCC limits are given in units of µV/m. The following formula is used to convert the units of µV/m to dBµV/m:

$$\text{Limit (dB}\mu\text{V/m)} = 20 \cdot \log(\mu\text{V/m})$$

Margin:

This is the margin of compliance below the FCC limit. The units are given in dB. A negative margin indicates the emission was below the limit. A positive margin indicates that the emission exceeds the limit.

Example only:

Reading + AF	=	Net Reading	:	Net reading	-	FCC limit	=	Margin
+21.5 dBµV		+ 26 dB = 47.5 dBµV/m		47.5 dBµV/m		- 57.0 dBµV/m		= -9.5 dB

2 Result Summary

FCC 47 CFR Part 15C, ISED RSS-247				
Product Standard Reference	Requirement	Reference Method	Result	Remarks
RSS-Gen 6.6	Occupied Bandwidth	ANSI C63.10	N/R	Informational only
FCC § 15.247(a)(2) ISED RSS-247 § 5.2	6 dB Bandwidth	ANSI C63.10	N/T	
FCC § 15.247(b)(3) ISED RSS-247 § 5.4	Maximum peak conducted power	ANSI C63.10	PASS	
FCC § 15.247(e) ISED RSS-247 § 5.2	Power spectral density	ANSI C63.10	N/T	
FCC § 15.207 ISED RSS-247 § 3.1	AC power line conducted emissions	ANSI C63.10	PASS	
FCC § 15.247(d) ISED RSS-247 § 5.5	Band edge compliance	ANSI C63.10	PASS	
FCC § 15.247(d) ISED RSS-247 § 5.5	Conducted spurious emissions	ANSI C63.10	PASS	
FCC § 15.247(d) FCC § 15.209 ISED RSS-GEN § 8.9	Transmitter radiated spurious emissions	ANSI C63.10	PASS	
ISED RSS-247 § 3.1	Receiver radiated spurious emissions	ANSI C63.10	PASS	
Comment:				

Possible Test Case Verdicts	
PASS	Test object does meet the requirements
FAIL	Test object does not meet the requirements
N/T	Required by standard but not tested
N/R	Not required by standard for the test object

3 Test Conditions and Results

3.1 Test Conditions and Results - Occupied bandwidth

3.1.1 Information

Test Information	
Reference	I SED RSS-Gen 6.6
Measurement Method	ANSI C63.10 6.9.3
Operator	Wilfried Treffke
Date	2017-05-04

3.1.2 Limits

Limits
None (Informational only)

3.1.3 Setup

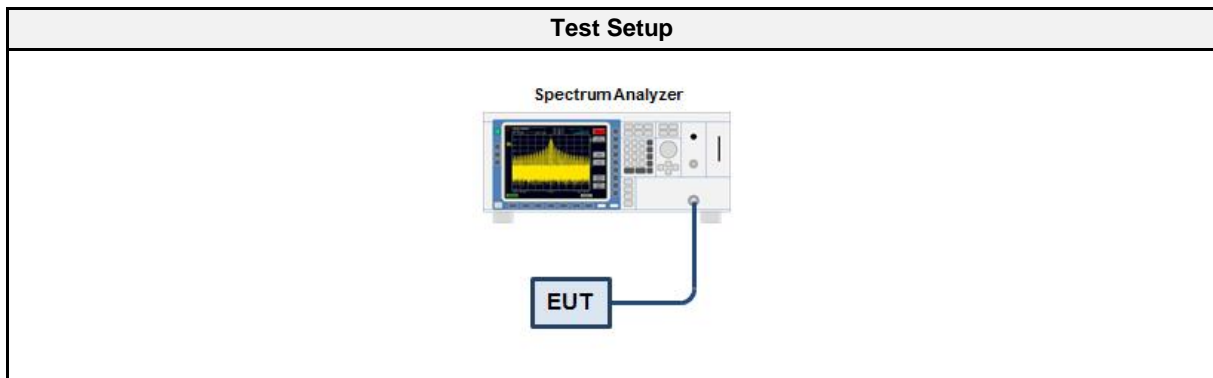

3.1.4 Equipment

Test Equipment					
Description	Manufacturer	Model	Identifier	Cal. Date	Cal. Due
Spectrum Analyzer	R&S	FSU 26	EF01003	2017-04	2018-04

3.1.5 Procedure

Test Procedure
<ol style="list-style-type: none"> 1. EUT transmitter is activated in test mode under normal conditions 2. The spectrum analyzer is set to peak detection and maximum hold with a span twice the emission spectrum 3. The resolution bandwidth is set to 1 % of the bandwidth 4. The occupied bandwidth is measured with the build-in analyzer function

3.1.6 Results

Test Results		
Mode	Frequency [MHz]	Bandwidth [MHz]
GFSK	2402	1.005
GFSK	2440	1.005
GFSK	2480	1.005

Occupied Bandwidth

Project Number: G0M-1702-6284
 Applicant: Panasonic Industrial Devices Europe GmbH
 Model Description: Class 2 Bluetooth Low Energy Module
 Model: ENW89837A5KF
 Test Sample ID: 12653
 Reference Standards: FCC 15.247, RSS-247
 Reference Method: ANSI C63.10:2013, Section 6.9.3
 Operational Mode: GFSK, Channel: 0, 2402 MHz
 Operating Conditions: Tnom/Vnom
 Operator: W. Treffke
 Test Site: Eurofins Product Service GmbH
 Test Date: 2017-05-04
 Occupied Bandwidth [MHz]: 1.005

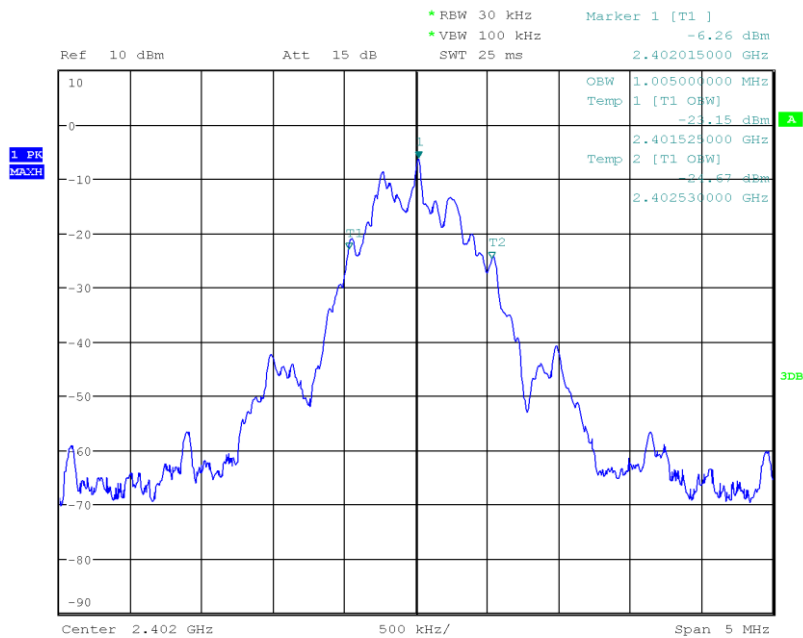

Date: 4.MAY.2017 10:06:33

Occupied Bandwidth

Project Number: G0M-1702-6284
 Applicant: Panasonic Industrial Devices Europe GmbH
 Model Description: Class 2 Bluetooth Low Energy Module
 Model: ENW89837A5KF
 Test Sample ID: 12653
 Reference Standards: FCC 15.247, RSS-247
 Reference Method: ANSI C63.10:2013, Section 6.9.3
 Operational Mode: GFSK, Channel: 39, 2480 MHz
 Operating Conditions: Tnom/Vnom
 Operator: W. Treffke
 Test Site: Eurofins Product Service GmbH
 Test Date: 2017-05-04
 Occupied Bandwidth [MHz]: 1.005

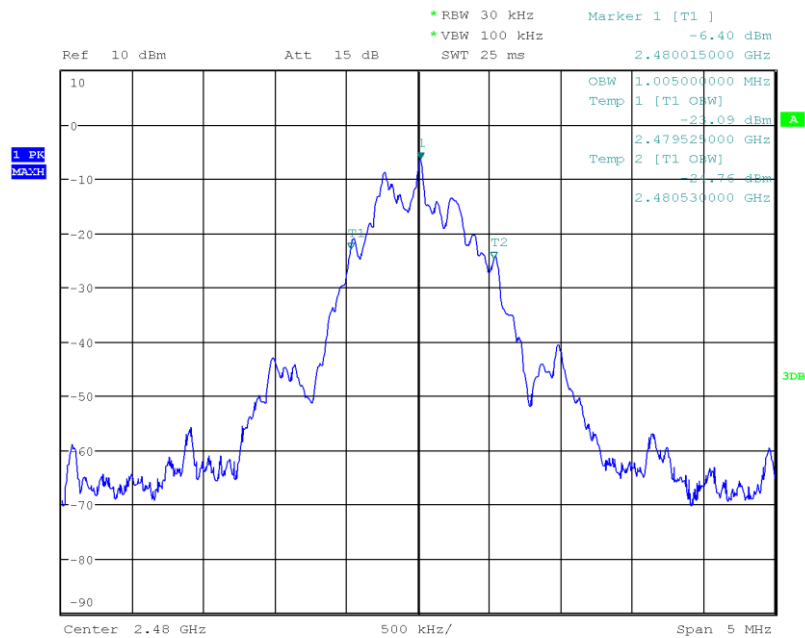

Date: 4.MAY.2017 10:13:00

3.2 Test Conditions and Results - Maximum peak conducted output power

3.2.1 Information

Test Information	
Reference	FCC 15.247(b)(1) / ISED RSS-247 5.4
Measurement Method	ANSI C63.10 11.9.1
Operator	Wilfried Treffke
Date	2017-05-04

3.2.2 Limits

Limits
1 W (30 dBm)
The conducted output power limit specified above is based on the use of antennas with directional gains that do not exceed 6 dBi. If transmitting antennas of directional gain greater than 6 dBi are used, the conducted output power from the intentional radiator shall be reduced below the stated values in the table, as appropriate, by the amount in dB that the directional gain of the antenna exceeds 6 dBi.

3.2.3 Setup

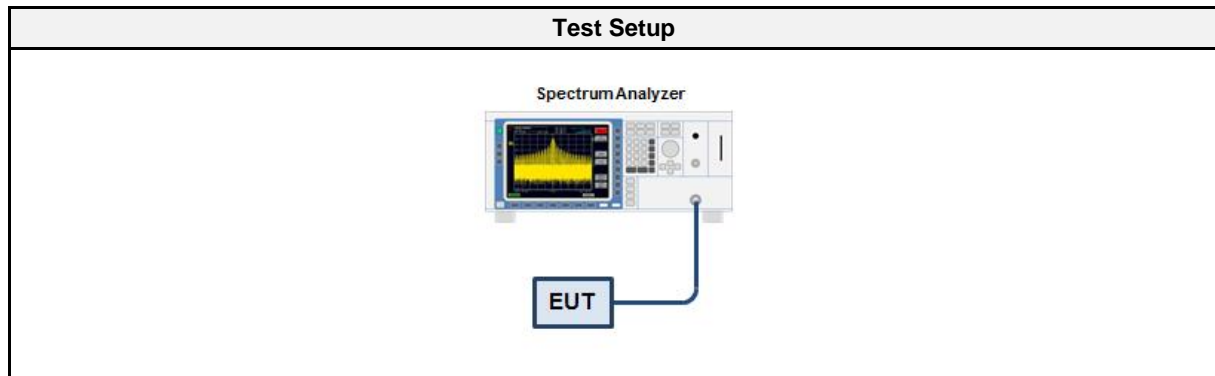

3.2.4 Equipment

Test Equipment					
Description	Manufacturer	Model	Identifier	Cal. Date	Cal. Due
Spectrum Analyzer	R&S	FSU 26	EF01003	2017-04	2018-04

3.2.5 Procedure

Test Procedure
<ol style="list-style-type: none"> 1. EUT set to test hopping mode (Communication tester is used if needed) 2. Analyzer resolution bandwidth is set \geq DTS bandwidth 3. Detector set to peak and max hold 4. Sweep time is set to auto 5. After the trace has stabilized a marker is set to peak of envelope

3.2.6 Results

Test Results				
Channel [MHz]	Power [dBm]	Power [W]	Limit [W]	Verdict
2402	-0.64	0.00086	1.0	PASS
2440	-0.34	0.00092	1.0	PASS
2480	-0.70	0.00085	1.0	PASS

3.3 Test Conditions and Results - Band-edge compliance

3.3.1 Information

Test Information	
Reference	FCC 15.247(d) / ISED RSS-247 5.5
Measurement Method	ANSI C63.10 11.11
Operator	Wilfried Treffke
Date	2017-05-04

3.3.2 Limits

Limits	
Power Measurement	Out-of-band attenuation [dB]
Peak	20
RMS	30

3.3.3 Setup

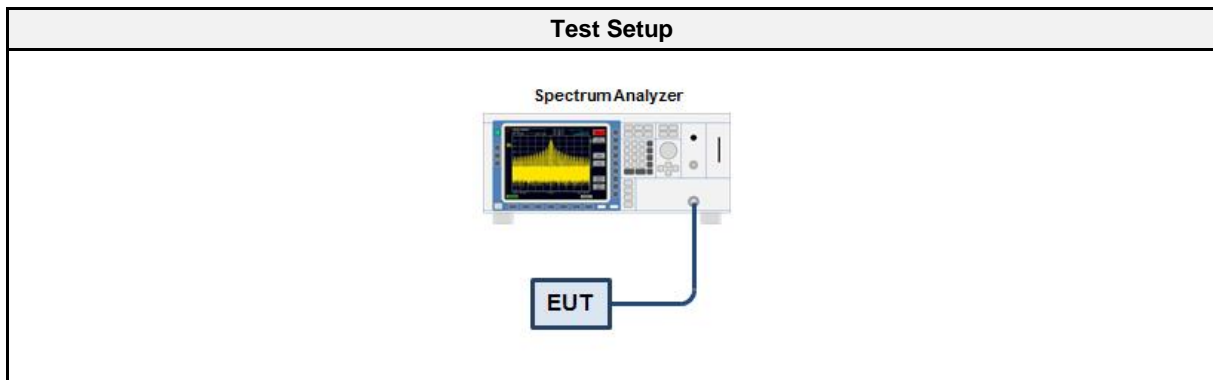

3.3.4 Equipment

Test Equipment					
Description	Manufacturer	Model	Identifier	Cal. Date	Cal. Due
Spectrum Analyzer	R&S	FSU 26	EF01003	2017-04	2018-04

3.3.5 Procedure

Test Procedure
<ol style="list-style-type: none"> 1. EUT set to test mode (Communication tester is used if needed) 2. Span set around lower band edge and detector is set to peak and max hold 3. Resolution bandwidth is set to 100 kHz 4. Markers are set to peak emission levels within frequency band and outside frequency band 5. Band edge attenuation is determined from level difference

3.3.6 Results

Test Results				
Mode	Channel [MHz]	Out-of-band Attenuation [dB]	Limit [dB]	Verdict
GFSK	2402	-47.31	-20	PASS
GFSK	2480	-48.37	-20	PASS

Band-edge Compliance

Project Number: G0M-1702-6284
 Applicant: Panasonic Industrial Devices Europe GmbH
 Model Description: Class 2 Bluetooth Low Energy Module
 Model: ENW89837A5KF
 Test Sample ID: 12653
 Reference Standards: FCC 15.247, RSS-247
 Reference Method: ANSI C63.10:2013, Section 11.11
 Operational Mode: GFSK, Channel: 0, 2402 MHz
 Operating Conditions: Tnom/Vnom
 Operator: W. Treffke
 Test Site: Eurofins Product Service GmbH
 Test Date: 2017-05-04
 Band-edge: Lower
 In-band Frequency [MHz]: 2402.016
 Max. in-band Level [dBm/100 kHz]: -0.851
 Out-of-band Frequency [MHz]: 2399.648
 Max. out-of-band Level [dBm/100 kHz]: -48.157
 Attenuation [dB]: -47.31

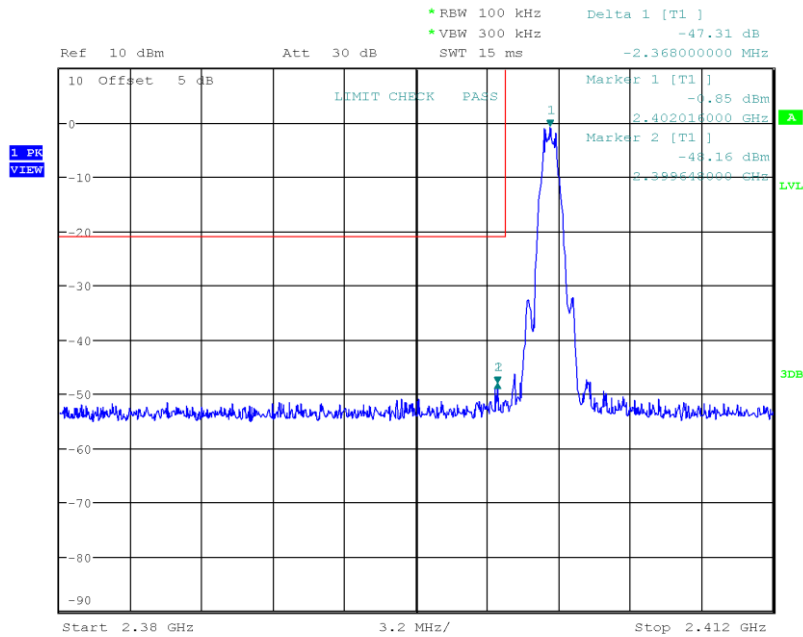

Date: 4.MAY.2017 11:02:54

Band-edge Compliance

Project Number: G0M-1702-6284
 Applicant: Panasonic Industrial Devices Europe GmbH
 Model Description: Class 2 Bluetooth Low Energy Module
 Model: ENW89837A5KF
 Test Sample ID: 12653
 Reference Standards: FCC 15.247, RSS-247
 Reference Method: ANSI C63.10:2013, Section 11.11
 Operational Mode: GFSK, Channel: 39, 2480 MHz
 Operating Conditions: Tnom/Vnom
 Operator: W. Treffke
 Test Site: Eurofins Product Service GmbH
 Test Date: 2017-05-04
 Band-edge: Upper
 In-band Frequency [MHz]: 2480.01
 Max. in-band Level [dBm/100 kHz]: -0.932
 Out-of-band Frequency [MHz]: 2483.685
 Max. out-of-band Level [dBm/100 kHz]: -49.302
 Attenuation [dB]: -48.37

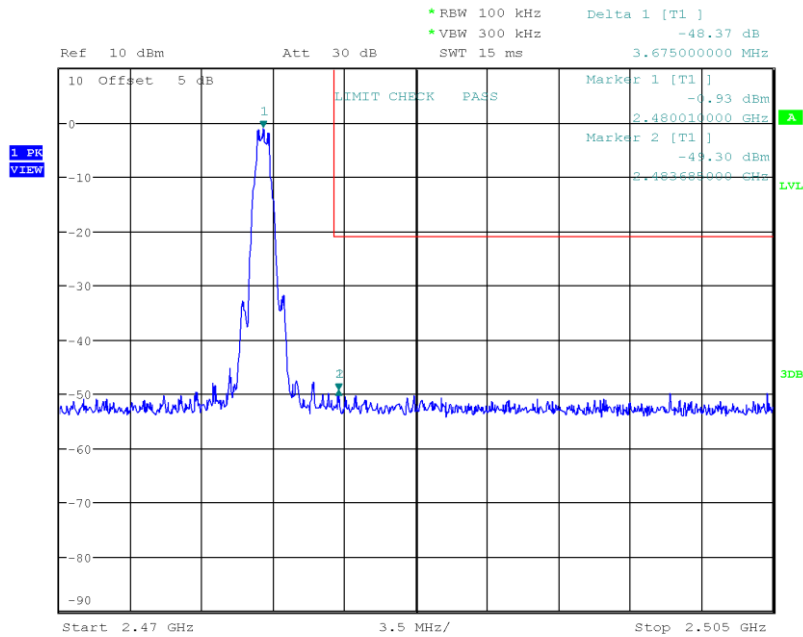

Date: 4.MAY.2017 11:04:37

3.4 Test Conditions and Results - Conducted spurious emissions

3.4.1 Information

Test Information	
Reference	FCC 15.247(d) / ISED RSS-247 5.5
Measurement Method	ANSI C63.10 11.11
Operator	Wilfried Treffke
Date	2017-05-04

3.4.2 Limits

Limits	
Power Measurement	Out-of-band attenuation [dB]
Peak	20
RMS	30

3.4.3 Setup

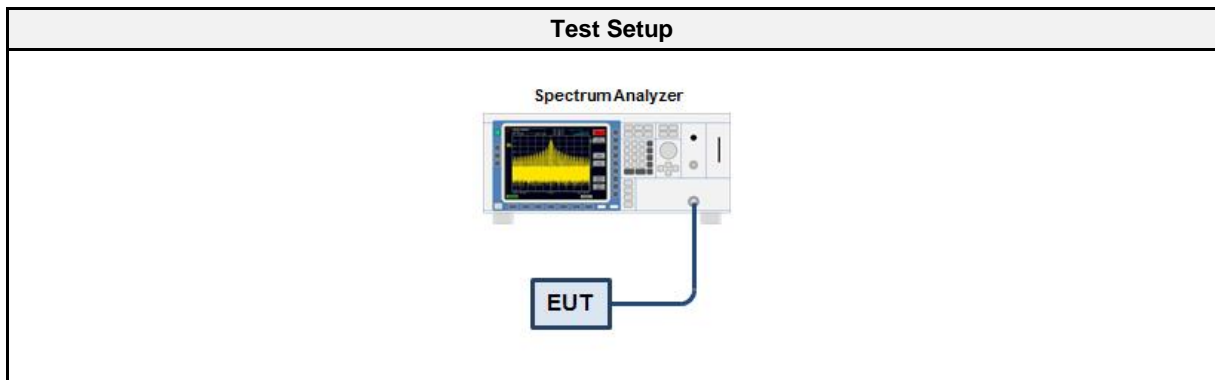

3.4.4 Equipment

Test Equipment					
Description	Manufacturer	Model	Identifier	Cal. Date	Cal. Due
Spectrum Analyzer	R&S	FSU 26	EF01003	2017-04	2018-04

3.4.5 Procedure

Test Procedure
<ol style="list-style-type: none"> 1. EUT set to test mode (Communication tester is used if needed) 2. Span set around lower band edge and detector is set to peak and max hold 3. Resolution bandwidth is set to 100 kHz 4. Markers are set to peak emission levels within frequency band and outside frequency band 5. Band edge attenuation is determined from level difference

3.4.6 Results

Test Results		
Mode	Channel [MHz]	Verdict
GFSK	2402	PASS
GFSK	2440	PASS
GFSK	2480	PASS

Conducted Spurious Emissions

Project Number: G0M-1702-6284
 Applicant: Panasonic Industrial Devices Europe GmbH
 Model Description: Class 2 Bluetooth Low Energy Module
 Model: ENW89837A5KF
 Test Sample ID: 12653
 Reference Standards: FCC 15.247, RSS-247
 Reference Method: ANSI C63.10:2013, Section 11.11
 Operational Mode: GFSK, Channel: 0, 2402 MHz
 Operating Conditions: Tnom/Vnom
 Operator: W. Treffke
 Test Site: Eurofins Product Service GmbH
 Test Date: 2017-05-04
 Max. in-band Frequency [MHz]: 2402.0
 Max. in-band Level [dBm/100 kHz]: -1.2
 Out-of-band Limit [dBm/100 kHz]: -21.2

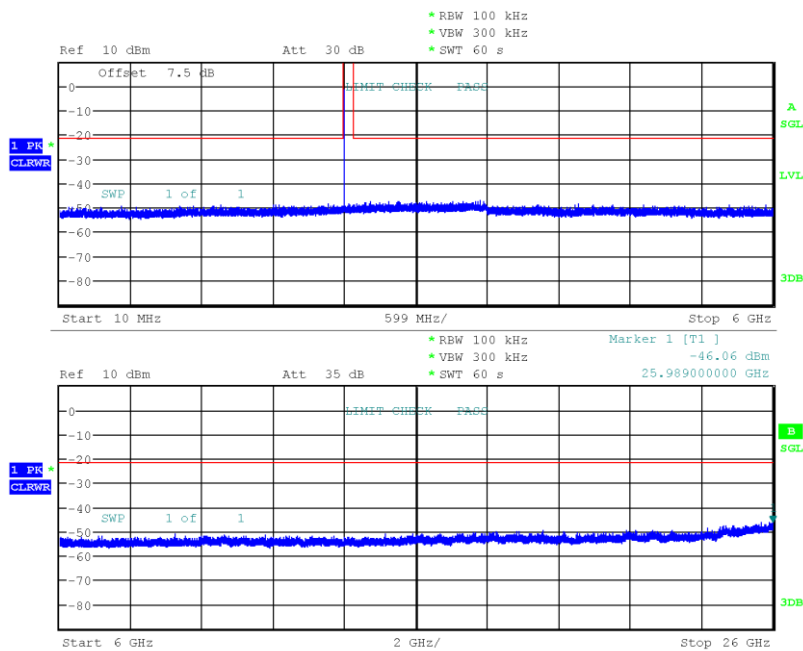

Date: 4.MAY.2017 11:47:12

Conducted Spurious Emissions

Project Number: G0M-1702-6284
 Applicant: Panasonic Industrial Devices Europe GmbH
 Model Description: Class 2 Bluetooth Low Energy Module
 Model: ENW89837A5KF
 Test Sample ID: 12653
 Reference Standards: FCC 15.247, RSS-247
 Reference Method: ANSI C63.10:2013, Section 11.11
 Operational Mode: GFSK, Channel: 19, 2440 MHz
 Operating Conditions: Tnom/Vnom
 Operator: W. Treffke
 Test Site: Eurofins Product Service GmbH
 Test Date: 2017-05-04
 Max. in-band Frequency [MHz]: 2440.0
 Max. in-band Level [dBm/100 kHz]: -1.1
 Out-of-band Limit [dBm/100 kHz]: -21.1

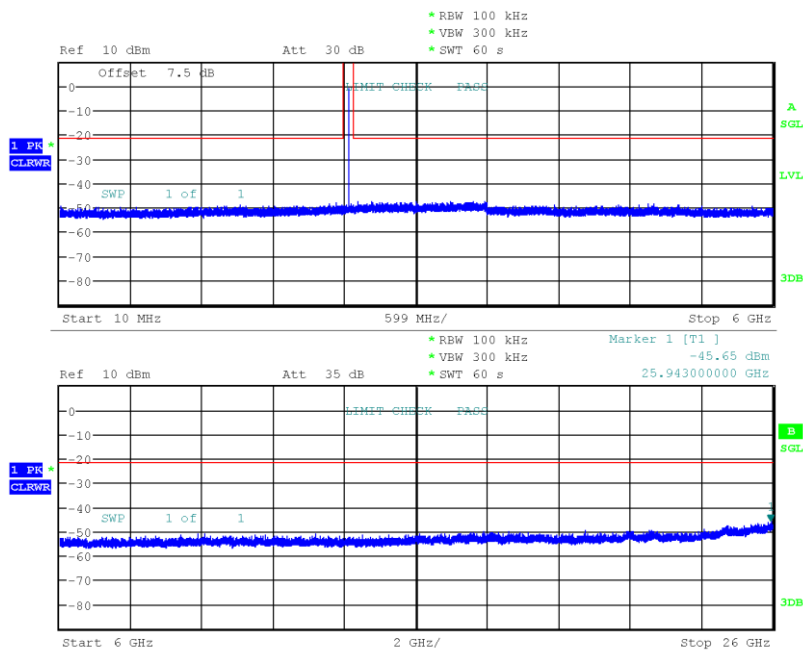

Date: 4.MAY.2017 11:59:47

Conducted Spurious Emissions

Project Number: G0M-1702-6284
 Applicant: Panasonic Industrial Devices Europe GmbH
 Model Description: Class 2 Bluetooth Low Energy Module
 Model: ENW89837A5KF
 Test Sample ID: 12653
 Reference Standards: FCC 15.247, RSS-247
 Reference Method: ANSI C63.10:2013, Section 11.11
 Operational Mode: GFSK, Channel: 39, 2480 MHz
 Operating Conditions: Tnom/Vnom
 Operator: W. Treffke
 Test Site: Eurofins Product Service GmbH
 Test Date: 2017-05-04
 Max. in-band Frequency [MHz]: 2480.0
 Max. in-band Level [dBm/100 kHz]: -1.4
 Out-of-band Limit [dBm/100 kHz]: -21.4

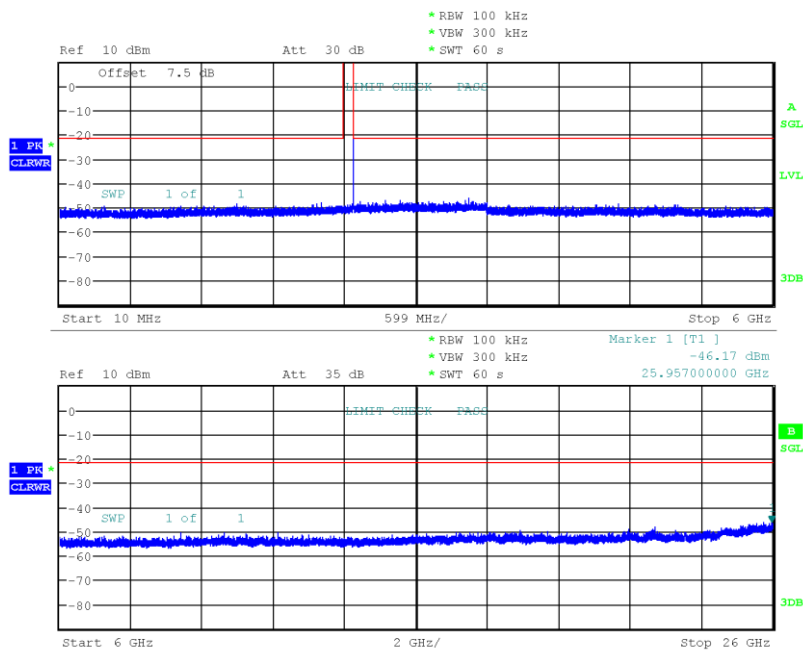

Date: 4.MAY.2017 12:44:54

3.5 Test Conditions and Results - Transmitter radiated emissions

3.5.1 Information

Test Information	
Reference	FCC 15.247(d) / ISED RSS-GEN 8.9
Measurement Method	ANSI C63.10 6.4, 6.5, 6.6, 11.12
Operator	Wilfried Treffke
Date	2017-05-04

3.5.2 Limits

Limits			
Frequency [MHz]	Detector	Field strength [dB μ V/m]	Measurement distance [m]
0.009 - 0.09	Average	2400/F[kHz]	300
0.09 - 0.110	Quasi-Peak	2400/F[kHz]	300
0.110 - 0.490	Average	2400/F[kHz]	300
0.490 - 1.705	Quasi-Peak	24000/F[kHz]	30
1.705 - 30.0	Quasi-Peak	30	30
30 - 88	Quasi-Peak	100	3
88 - 216	Quasi-Peak	150	3
216 - 960	Quasi-Peak	200	3
960 - 1000	Quasi-Peak	500	3
>1000	Average	500	3

3.5.3 Setup

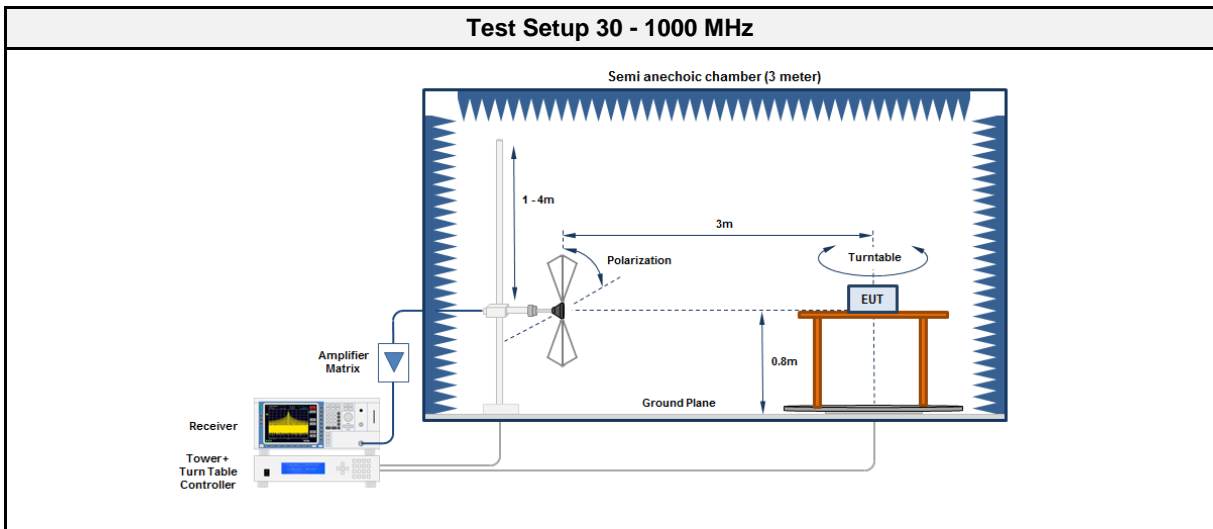

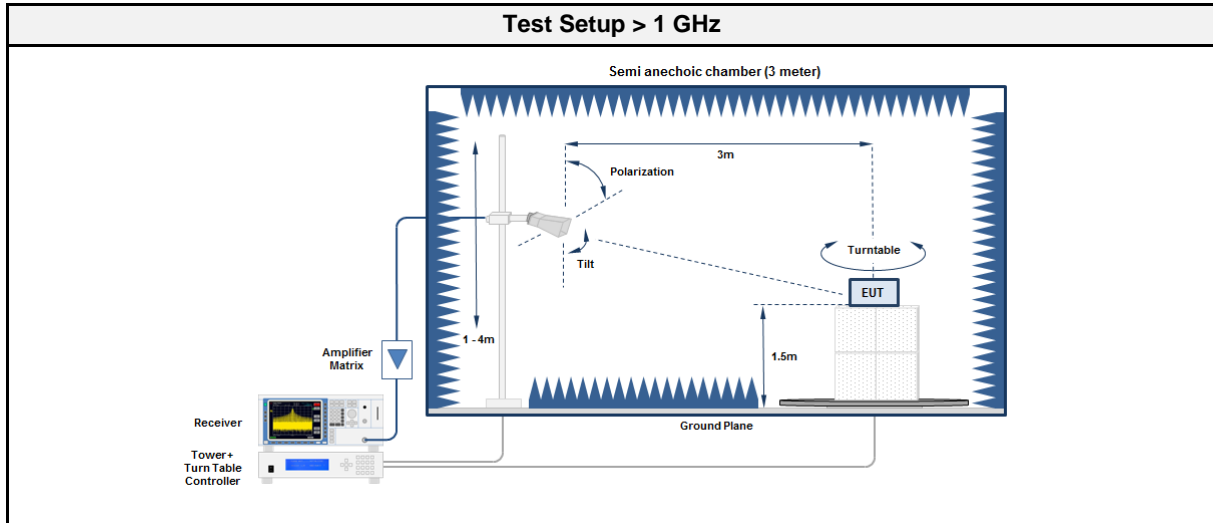

3.5.4 Equipment

Test Equipment 30 - 1000 MHz					
Description	Manufacturer	Model	Identifier	Cal. Date	Cal. Due
Anechoic Chamber	Frankonia	AC1	EF00062	2017-02	2020-02
Measurement Receiver	R&S	ESU 26	EF00887	2017-01	2018-01
Biconical antenna	R&S	HK116	EF00030	2016-04	2019-04
LPD antenna	R&S	HL223	EF00202	2016-02	2018-02

Test Equipment > 1 GHz					
Description	Manufacturer	Model	Identifier	Cal. Date	Cal. Due
Anechoic Chamber	Frankonia	AC1	EF00062	2017-02	2020-02
Measurement Receiver	R&S	ESU 26	EF00887	2017-01	2018-01
Horn antenna	Schwarzbeck	BBHA 9120D	EF00019	2016-09	2018-09

3.5.5 Procedure

Test Procedure 30 - 1000 MHz	
1.	EUT is placed on a non conducting support at the center of a turn table 0.8 m above the ground
2.	EUT set to test mode
3.	The receiver is set to peak detection with max hold
4.	The EUT is rotated through 360° and the height of the antenna is varied from 1 m to 4 m
5.	All significant emissions are measured again using the corresponding final detector

Test Procedure > 1 GHz	
1.	EUT is placed on a non conducting support at the center of a turn table 1.5 m above the ground
2.	EUT set to test mode
3.	The receiver is set to peak detection with max hold
4.	The EUT is rotated through 360° and the height of the antenna is varied from 1 m to 4 m
5.	All significant emissions are measured again using the corresponding final detector

3.5.6 Results

Test Results						
Channel [MHz]	Emission [MHz]	Level [dB μ V/m]	Det.	Pol.	Limit [dB μ V/m]	Margin [dB]
2402	2377.2	49.75	pk	ver	74.00	-24.25
2402	2377.2	37.49	RMS	ver	54.00	-16.51
2402	2389	50.24	pk	hor	74.00	-23.76
2402	2389	37.37	RMS	hor	54.00	-16.63
2480	2483.6	56.90	pk	hor	74.00	-17.10
2480	2483.6	40.00	RMS	hor	54.00	-14.00
2480	2483.6	57.81	pk	ver	74.00	-16.19
2480	2483.6	40.00	RMS	ver	54.00	-14.00

3.6 Test Conditions and Results - Receiver radiated emissions

3.6.1 Information

Test Information	
Reference	ISED RSS-247 3.1
Measurement Method	ANSI C63.10 6.5, 6.6, 11.12
Operator	Wilfried Treffke
Date	2017-05-04

3.6.2 Limits

Limits			
Frequency [MHz]	Detector	Field strength [dB μ V/m]	Measurement distance [m]
30 - 88	Quasi-Peak	100	3
88 - 216	Quasi-Peak	150	3
216 - 960	Quasi-Peak	200	3
960 - 1000	Quasi-Peak	500	3
>1000	Average	500	3

3.6.3 Setup

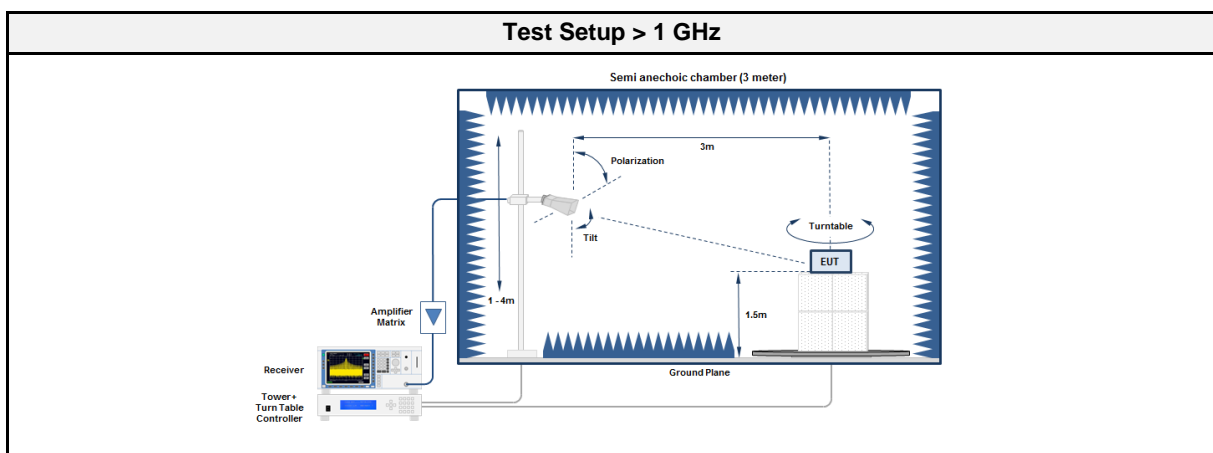
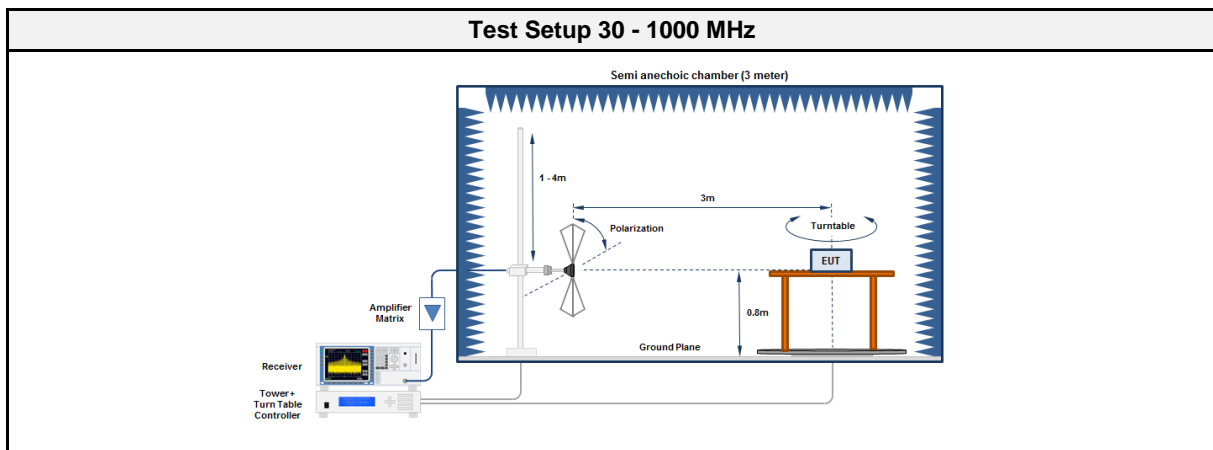

3.6.4 Equipment

Test Equipment 30 - 1000 MHz					
Description	Manufacturer	Model	Identifier	Cal. Date	Cal. Due
Anechoic Chamber	Frankonia	AC1	EF00062	2017-02	2020-02
Measurement Receiver	R&S	ESU 26	EF00887	2017-01	2018-01
Biconical antenna	R&S	HK116	EF00030	2016-04	2019-04
LPD antenna	R&S	HL223	EF00202	2016-02	2018-02

Test Equipment > 1 GHz					
Description	Manufacturer	Model	Identifier	Cal. Date	Cal. Due
Anechoic Chamber	Frankonia	AC1	EF00062	2017-02	2020-02
Measurement Receiver	R&S	ESU 26	EF00887	2017-01	2018-01
Horn antenna	Schwarzbeck	BBHA 9120D	EF00019	2016-09	2018-09

3.6.5 Procedure

Test Procedure 30 - 1000 MHz
<ol style="list-style-type: none"> EUT is placed on a non conducting support at the center of a turn table 0.8 m above the ground EUT set to test mode The receiver is set to peak detection with max hold The EUT is rotated through 360° and the height of the antenna is varied from 1 m to 4 m All significant emissions are measured again using the corresponding final detector

Test Procedure > 1 GHz
<ol style="list-style-type: none"> EUT is placed on a non conducting support at the center of a turn table 1.5 m above the ground EUT set to test mode The receiver is set to peak detection with max hold The EUT is rotated through 360° and the height of the antenna is varied from 1 m to 4 m All significant emissions are measured again using the corresponding final detector

3.6.6 Results

Test Results						
Channel [MHz]	Emission [MHz]	Level [dBµV/m]	Det.	Pol.	Limit [dBµV/m]	Margin [dB]
2440	7424	49.37	pk	hor	53.98	-04.61

ANNEX A Transmitter spurious emissions

Spurious emissions according to FCC 15.247

Project number: G0M-1702-6284

Applicant: Panasonic Industrial Devices Europe GmbH
 EUT Name: Class 2 Bluetooth Low Energy Module
 Model: ENW89837A5KF
 Test Site: Eurofins Product Service GmbH
 Operator: Mr. Treffke
 Test Conditions: Tnom: 24°C, Vnom: 3.3 VDC (5.0V USB evaluation board)
 Antenna: Rohde & Schwarz HK 116, Horizontal
 Measurement distance: 3 m
 Mode: TX; BLE; 2402 MHz
 Test Date: 2017-05-09
 Note:

Index 32

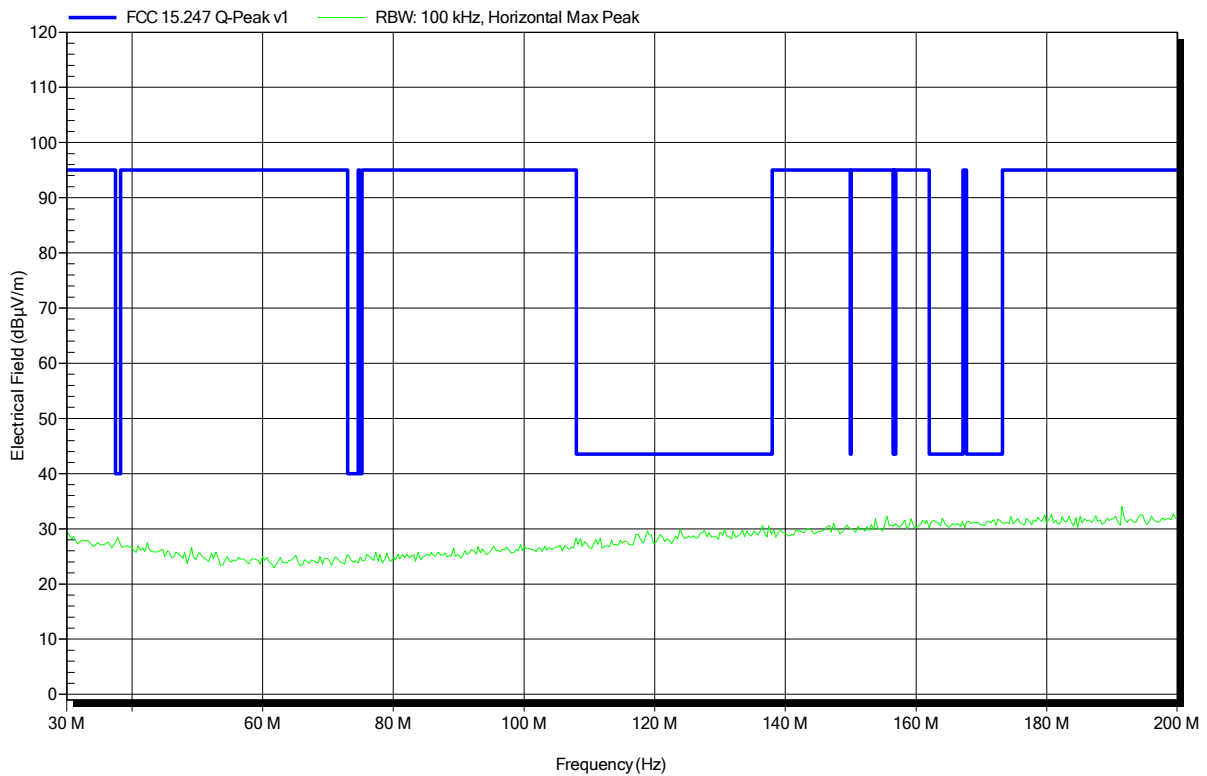

Spurious emissions according to FCC 15.247

Project number: G0M-1702-6284

Applicant: Panasonic Industrial Devices Europe GmbH
 EUT Name: Class 2 Bluetooth Low Energy Module
 Model: ENW89837A5KF
 Test Site: Eurofins Product Service GmbH
 Operator: Mr. Treffke
 Test Conditions: Tnom: 24°C, Vnom: 3.3 VDC (5.0V USB evaluation board)
 Antenna: Rohde & Schwarz HK 116, Horizontal
 Measurement distance: 3 m
 Mode: TX; BLE; 2402 MHz
 Test Date: 2017-05-09
 Note:

Index 33

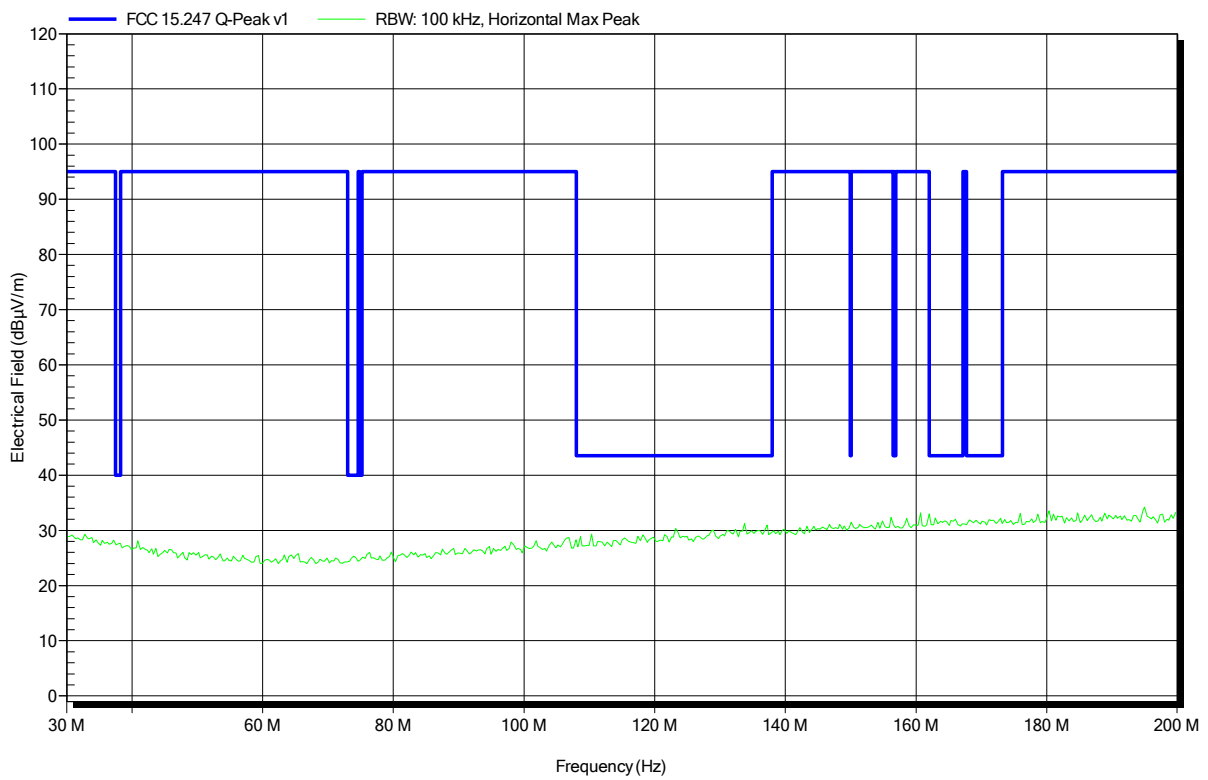

Spurious emissions according to FCC 15.247

Project number: G0M-1702-6284

Applicant: Panasonic Industrial Devices Europe GmbH
 EUT Name: Class 2 Bluetooth Low Energy Module
 Model: ENW89837A5KF
 Test Site: Eurofins Product Service GmbH
 Operator: Mr. Treffke
 Test Conditions: Tnom: 24°C, Vnom: 3.3 VDC (5.0V USB evaluation board)
 Antenna: Rohde & Schwarz HL 223, Horizontal
 Measurement distance: 3 m
 Mode: TX; BLE; 2402 MHz
 Test Date: 2017-05-09
 Note:

Index 34

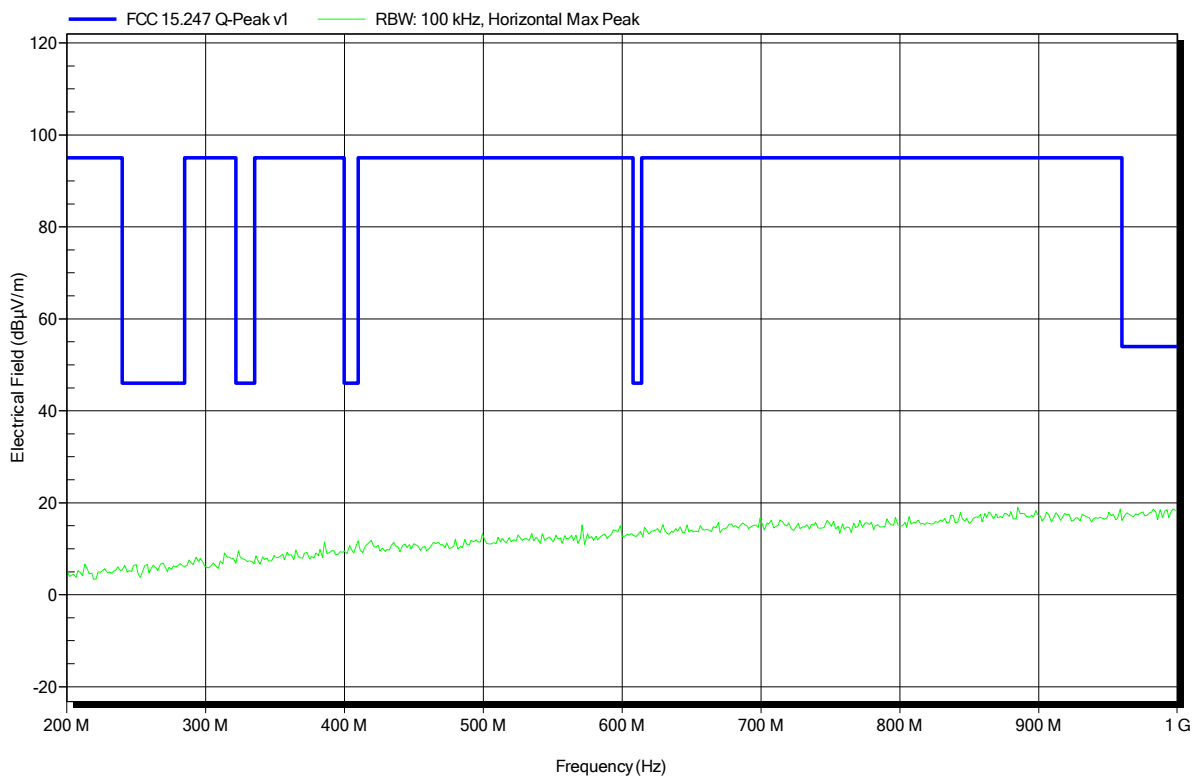

Spurious emissions according to FCC 15.247

Project number: G0M-1702-6284

Applicant: Panasonic Industrial Devices Europe GmbH
 EUT Name: Class 2 Bluetooth Low Energy Module
 Model: ENW89837A5KF
 Test Site: Eurofins Product Service GmbH
 Operator: Mr. Treffke
 Test Conditions: Tnom: 24°C, Vnom: 3.3 VDC (5.0V USB evaluation board)
 Antenna: Rohde & Schwarz HL 223, Vertical
 Measurement distance: 3 m
 Mode: TX; BLE; 2402 MHz
 Test Date: 2017-05-09
 Note:

Index 35

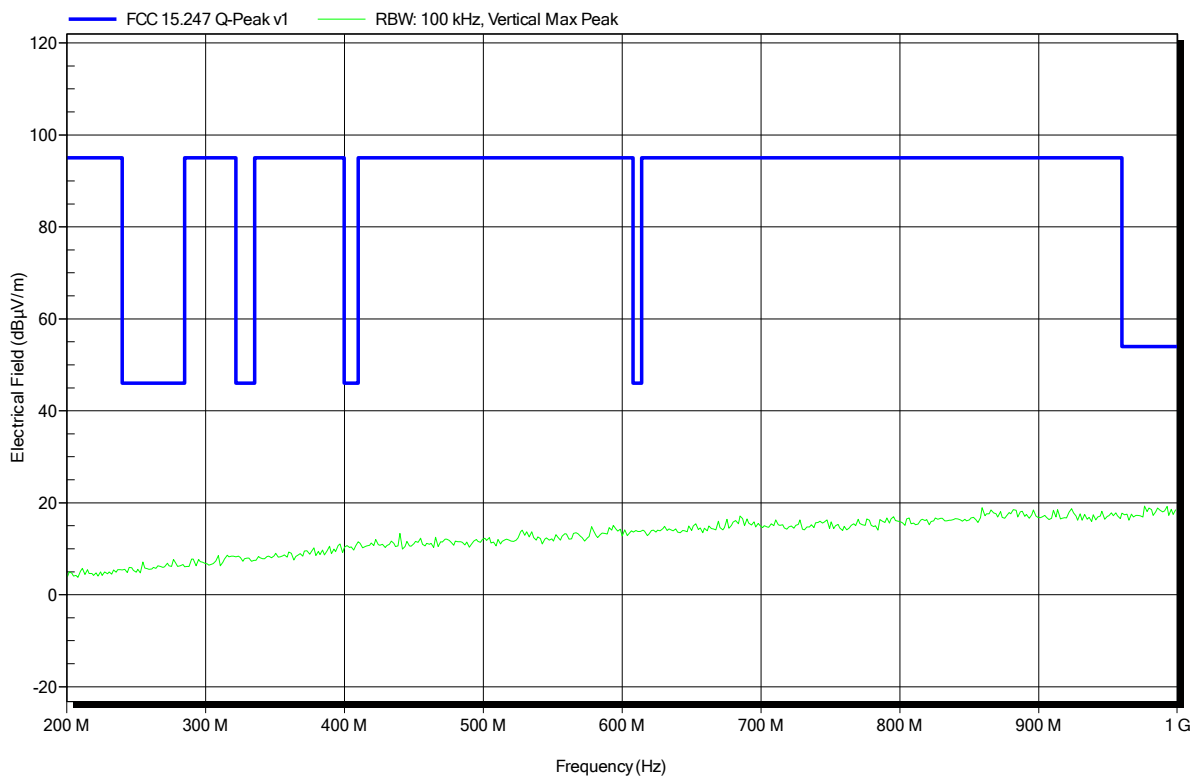

Spurious emissions according to FCC 15.247

Project number: G0M-1702-6284

Applicant: Panasonic Industrial Devices Europe GmbH
 EUT Name: Class 2 Bluetooth Low Energy Module
 Model: ENW89837A5KF
 Test Site: Eurofins Product Service GmbH
 Operator: Mr. Treffke
 Test Conditions: Tnom: 24°C, Vnom: 3.3 VDC (5.0V USB evaluation board)
 Antenna: Schwarzbeck BBHA 9120D, Horizontal
 Measurement distance: 1 m converted to 3m
 Mode: TX; BLE; 2402 MHz
 Test Date: 2017-05-08
 Note:

Index 3

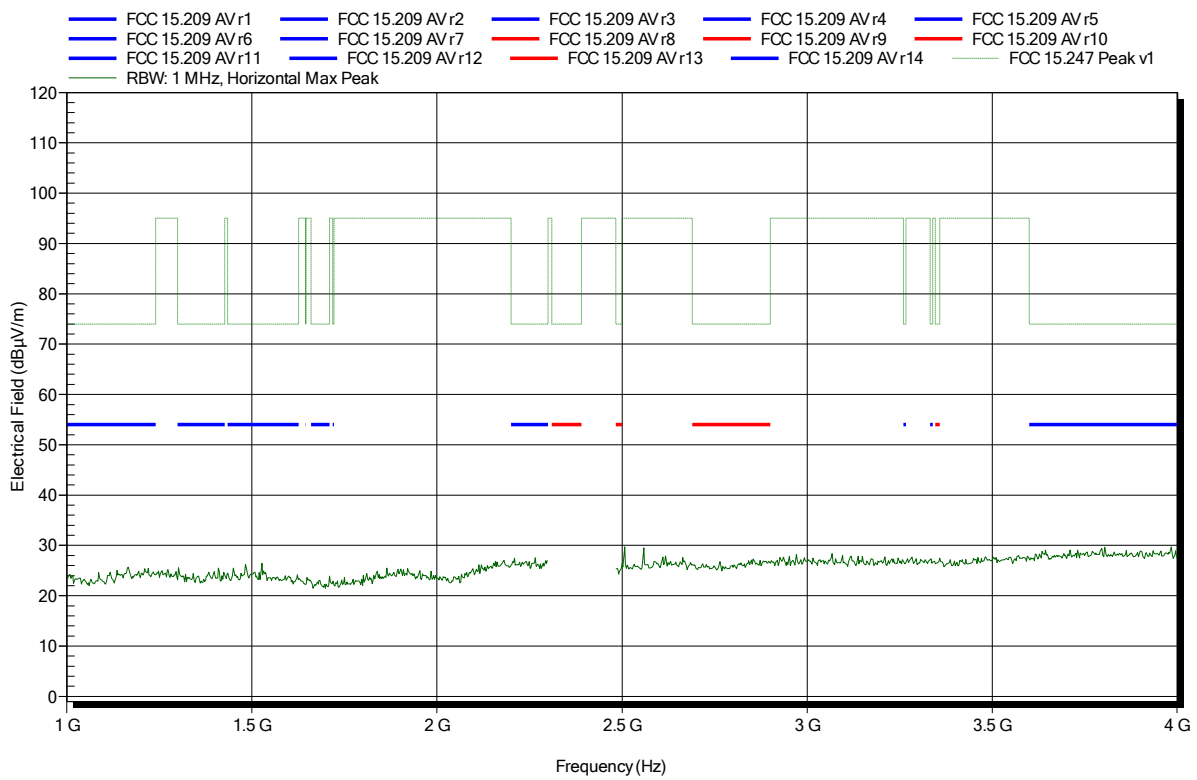

Spurious emissions according to FCC 15.247

Project number: G0M-1702-6284

Applicant: Panasonic Industrial Devices Europe GmbH
 EUT Name: Class 2 Bluetooth Low Energy Module
 Model: ENW89837A5KF
 Test Site: Eurofins Product Service GmbH
 Operator: Mr. Treffke
 Test Conditions: Tnom: 24°C, Vnom: 3.3 VDC (5.0V USB evaluation board)
 Antenna: Schwarzbeck BBHA 9120D, Vertical
 Measurement distance: 1 m converted to 3m
 Mode: TX; BLE; 2402 MHz
 Test Date: 2017-05-08
 Note:

Index 20

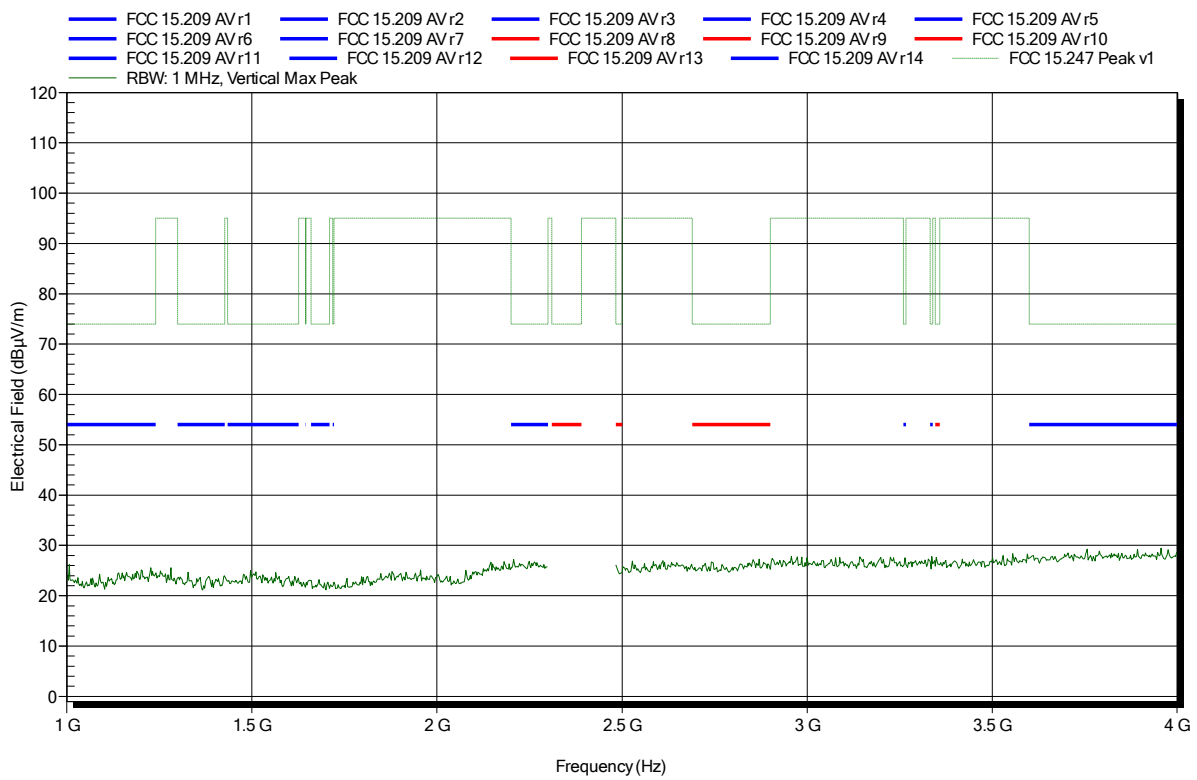

Spurious emissions according to FCC 15.247

Project number: G0M-1702-6284

Applicant: Panasonic Industrial Devices Europe GmbH
 EUT Name: Class 2 Bluetooth Low Energy Module
 Model: ENW89837A5KF
 Test Site: Eurofins Product Service GmbH
 Operator: Mr. Treffke
 Test Conditions: Tnom: 24°C, Vnom: 3.3 VDC (5.0V USB evaluation board)
 Antenna: Schwarzbeck BBHA 9120D, Horizontal
 Measurement distance: 1 m converted to 3m
 Mode: TX; BLE; 2402 MHz
 Test Date: 2017-05-08
 Note: lower bandedge

Index 2

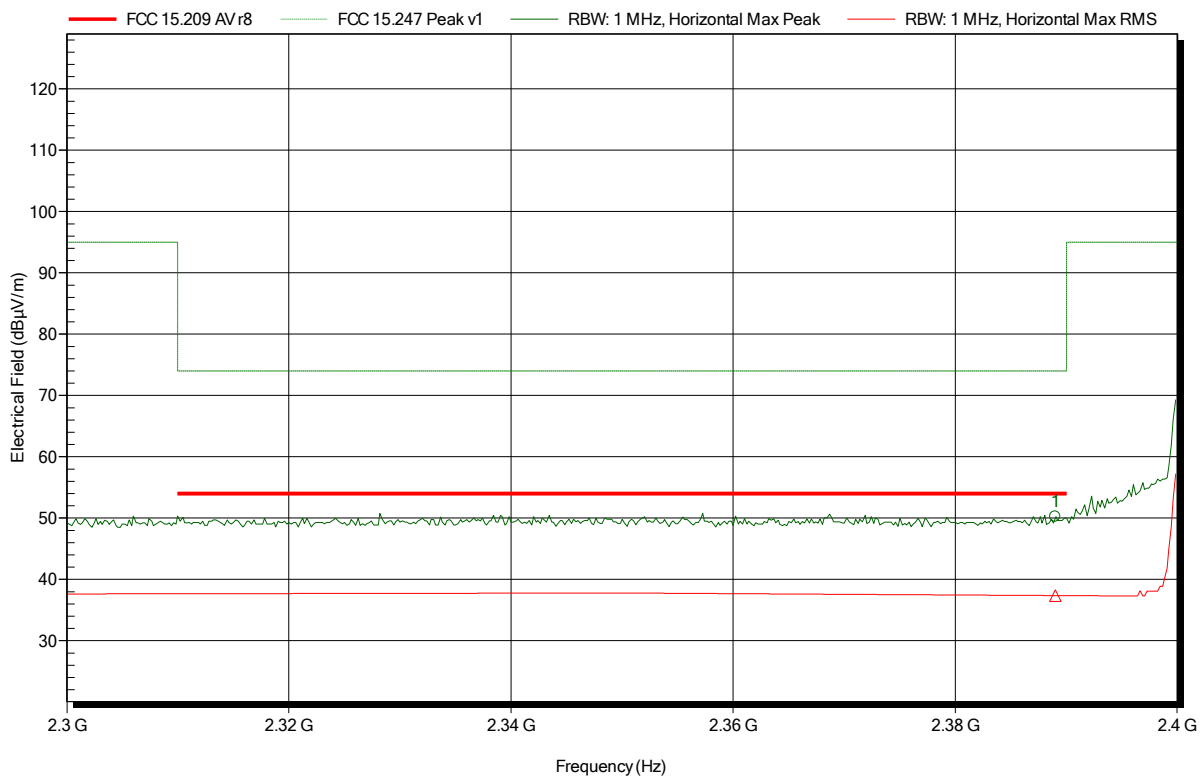

Frequency	Peak	Peak Limit	Peak Difference	Peak Status
2.389 GHz	50.24 dBµV/m	74 dBµV/m	-23.76 dB	Pass
Frequency	RMS	RMS Limit	RMS Difference	RMS Status
2.389 GHz	37.37 dBµV/m	54 dBµV/m	-16.63 dB	Pass

Spurious emissions according to FCC 15.247

Project number: G0M-1702-6284

Applicant: Panasonic Industrial Devices Europe GmbH
 EUT Name: Class 2 Bluetooth Low Energy Module
 Model: ENW89837A5KF
 Test Site: Eurofins Product Service GmbH
 Operator: Mr. Treffke
 Test Conditions: Tnom: 24°C, Vnom: 3.3 VDC (5.0V USB evaluation board)
 Antenna: Schwarzbeck BBHA 9120D, Vertical
 Measurement distance: 1 m converted to 3m
 Mode: TX; BLE; 2402 MHz
 Test Date: 2017-05-08
 Note: lower bandedge

Index 8

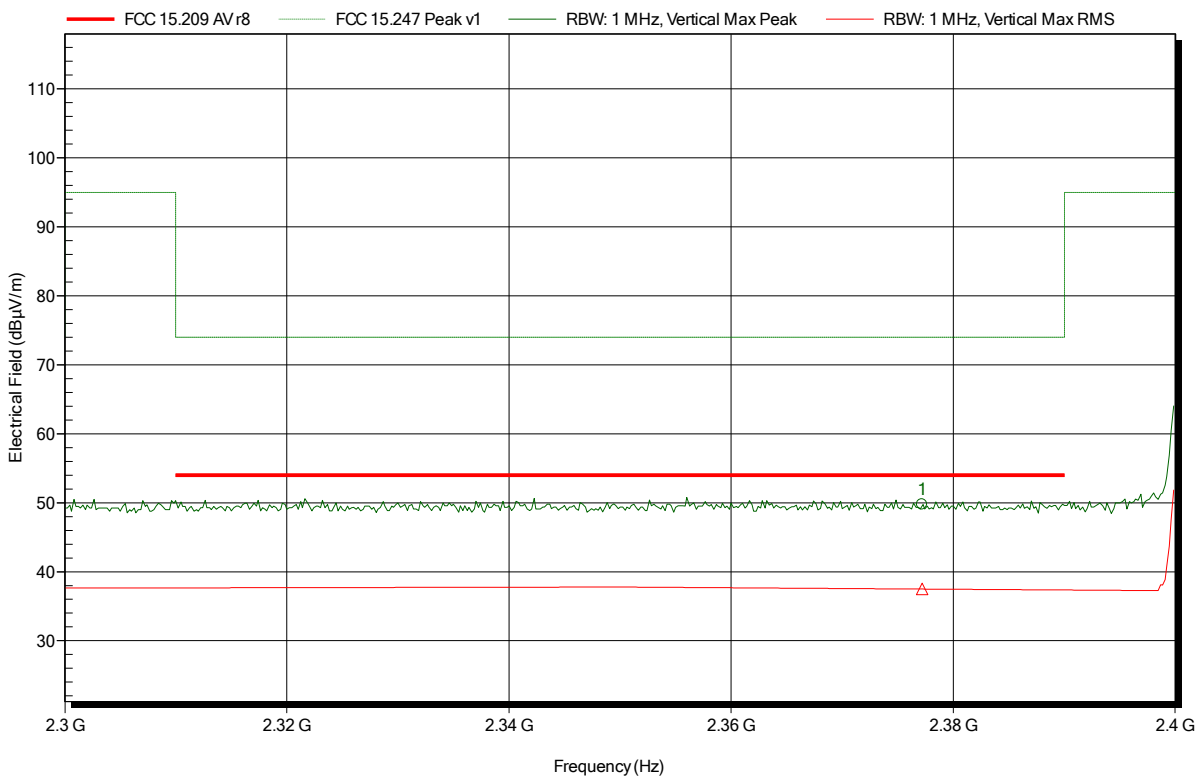

Frequency	Peak	Peak Limit	Peak Difference	Peak Status
2.3772 GHz	49.75 dBµV/m	74 dBµV/m	-24.25 dB	Pass
Frequency	RMS	RMS Limit	RMS Difference	RMS Status
2.3772 GHz	37.49 dBµV/m	54 dBµV/m	-16.51 dB	Pass

Spurious emissions according to FCC 15.247

Project number: G0M-1702-6284

Applicant: Panasonic Industrial Devices Europe GmbH
 EUT Name: Class 2 Bluetooth Low Energy Module
 Model: ENW89837A5KF
 Test Site: Eurofins Product Service GmbH
 Operator: Mr. Treffke
 Test Conditions: Tnom: 24°C, Vnom: 3.3 VDC (5.0V USB evaluation board)
 Antenna: Schwarzbeck BBHA 9120D, Horizontal
 Measurement distance: 1 m converted to 3m
 Mode: TX; BLE; 2402 MHz
 Test Date: 2017-05-08
 Note:

Index 4

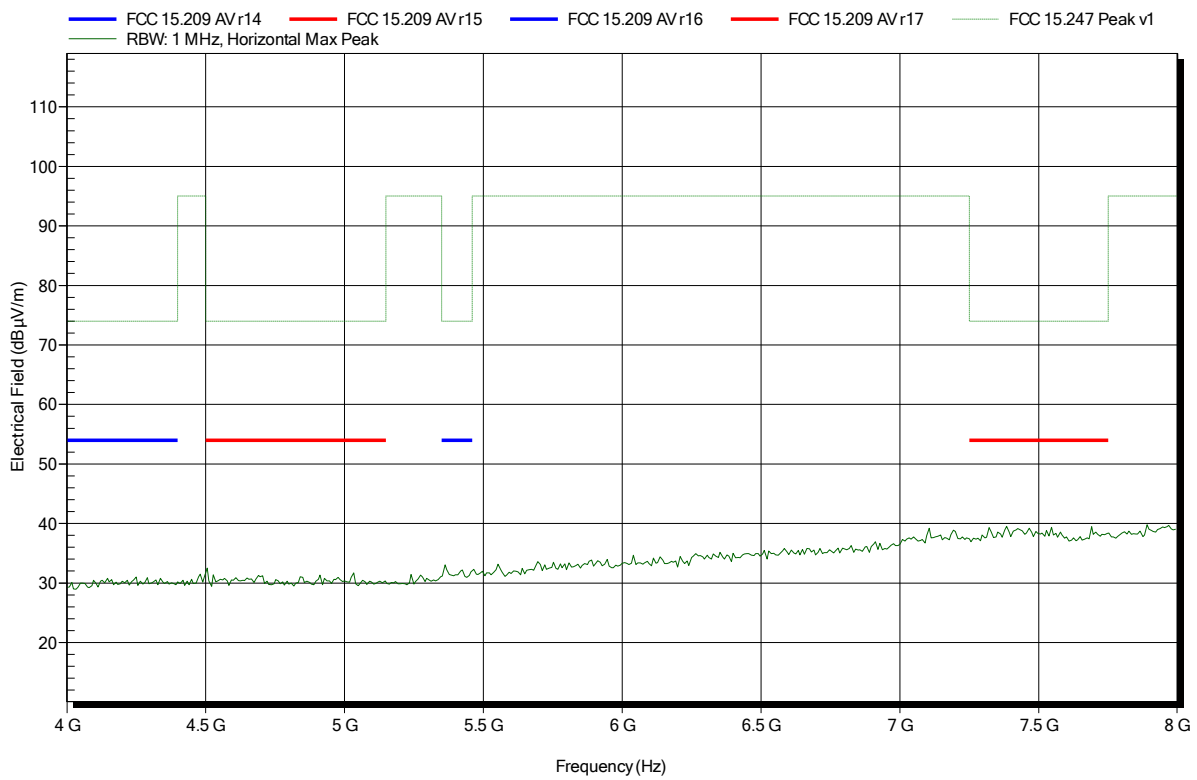

Spurious emissions according to FCC 15.247

Project number: G0M-1702-6284

Applicant: Panasonic Industrial Devices Europe GmbH
 EUT Name: Class 2 Bluetooth Low Energy Module
 Model: ENW89837A5KF
 Test Site: Eurofins Product Service GmbH
 Operator: Mr. Treffke
 Test Conditions: Tnom: 24°C, Vnom: 3.3 VDC (5.0V USB evaluation board)
 Antenna: Schwarzbeck BBHA 9120D, Vertical
 Measurement distance: 1 m converted to 3m
 Mode: TX; BLE; 2402 MHz
 Test Date: 2017-05-08
 Note:

Index 9

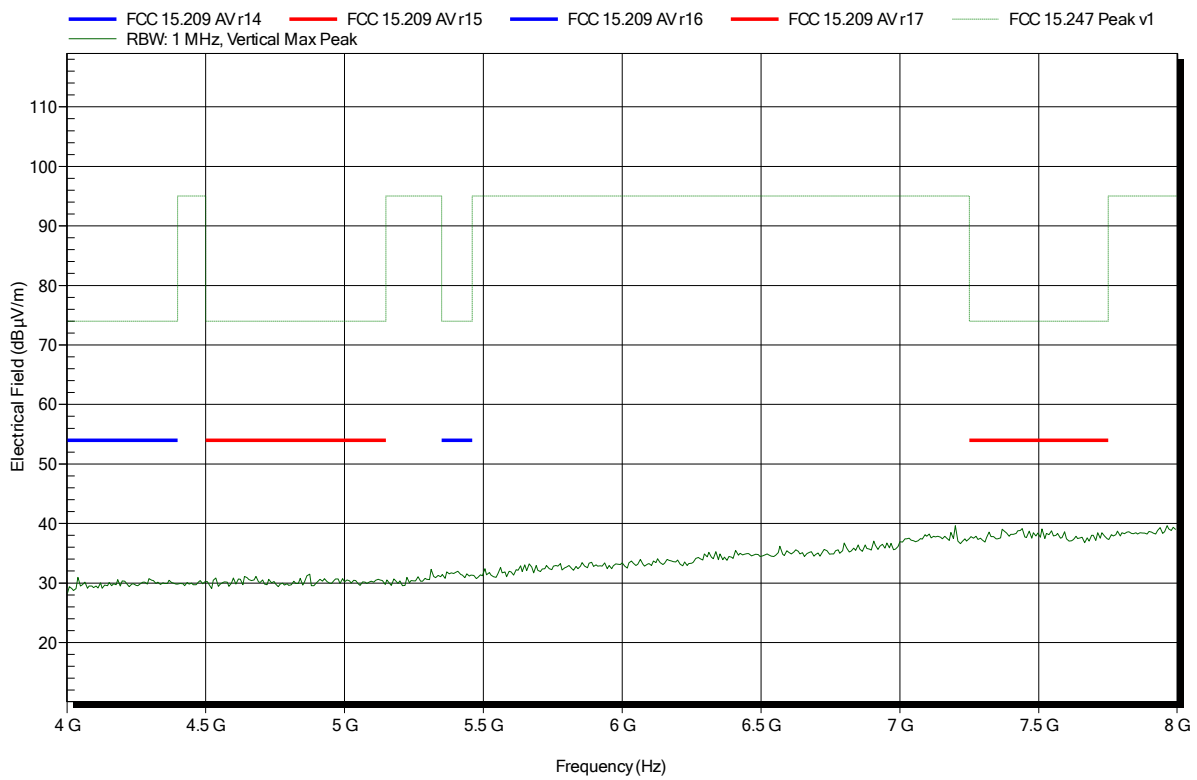

Spurious emissions according to FCC 15.247

Project number: G0M-1702-6284

Applicant: Panasonic Industrial Devices Europe GmbH
 EUT Name: Class 2 Bluetooth Low Energy Module
 Model: ENW89837A5KF
 Test Site: Eurofins Product Service GmbH
 Operator: Mr. Treffke
 Test Conditions: Tnom: 24°C, Vnom: 3.3 VDC (5.0V USB evaluation board)
 Antenna: Schwarzbeck BBHA 9120D, Horizontal
 Measurement distance: 1 m converted to 3m
 Mode: TX; BLE; 2402 MHz
 Test Date: 2017-05-08
 Note:

Index 5

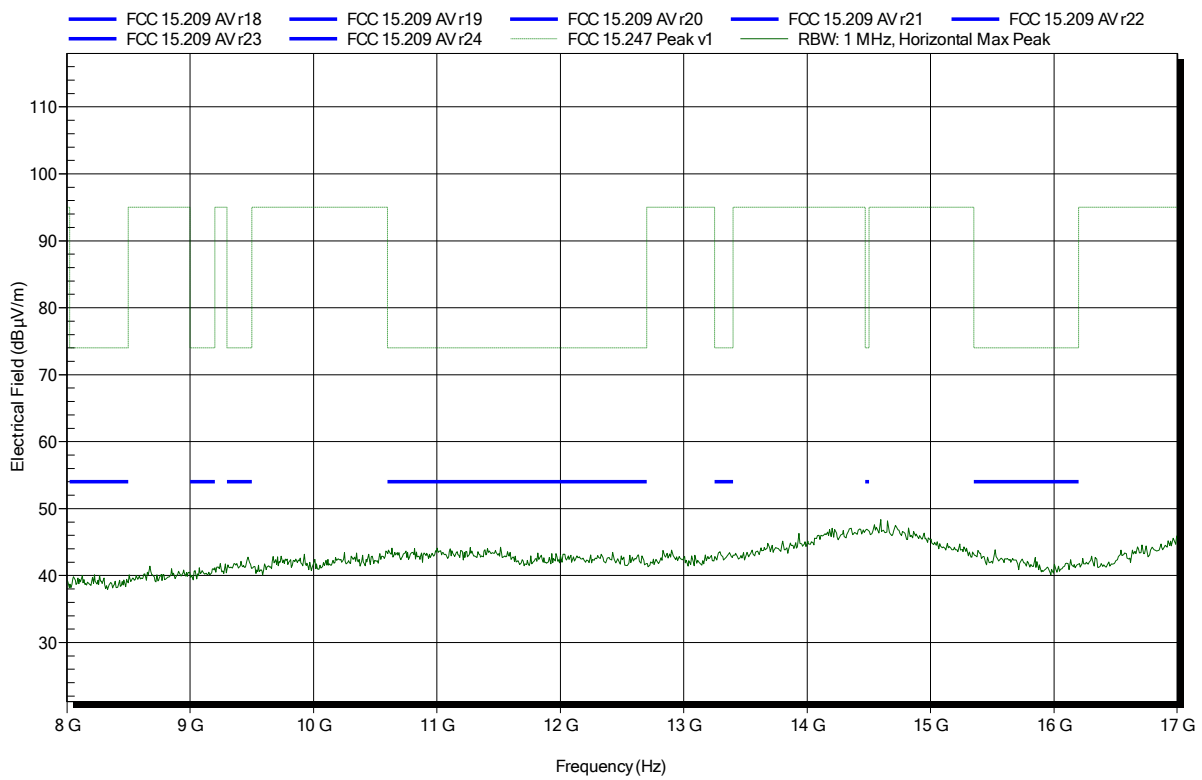

Spurious emissions according to FCC 15.247

Project number: G0M-1702-6284

Applicant: Panasonic Industrial Devices Europe GmbH
 EUT Name: Class 2 Bluetooth Low Energy Module
 Model: ENW89837A5KF
 Test Site: Eurofins Product Service GmbH
 Operator: Mr. Treffke
 Test Conditions: Tnom: 24°C, Vnom: 3.3 VDC (5.0V USB evaluation board)
 Antenna: Schwarzbeck BBHA 9120D, Vertical
 Measurement distance: 1 m converted to 3m
 Mode: TX; BLE; 2402 MHz
 Test Date: 2017-05-08
 Note:

Index 10

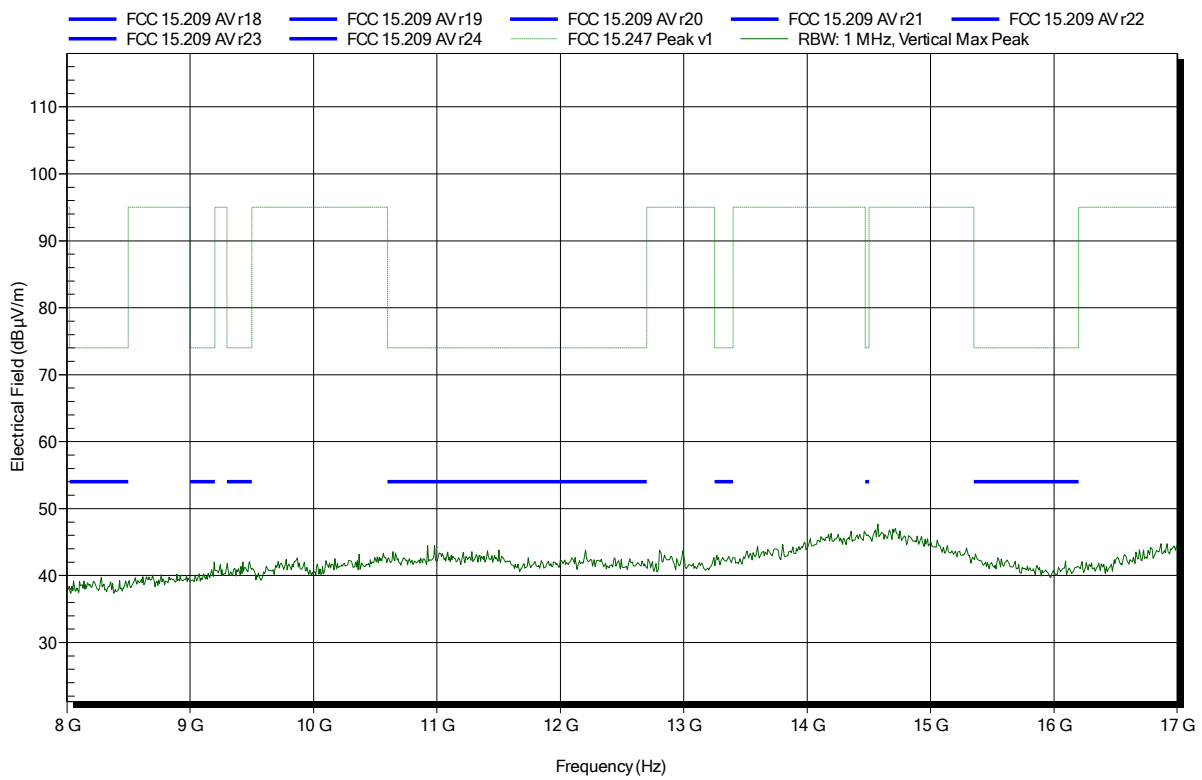

Spurious emissions according to FCC 15.247

Project number: G0M-1702-6284

Applicant: Panasonic Industrial Devices Europe GmbH
 EUT Name: Class 2 Bluetooth Low Energy Module
 Model: ENW89837A5KF
 Test Site: Eurofins Product Service GmbH
 Operator: Mr. Treffke
 Test Conditions: Tnom: 24°C, Vnom: 3.3 VDC (5.0V USB evaluation board)
 Antenna: Amplifier Research AT 4560 (old name) / ATH18G40 (new name),
 Horizontal
 Measurement distance: 1 m converted to 3m
 Mode: TX; BLE; 2402 MHz
 Test Date: 2017-05-08
 Note:

Index 6

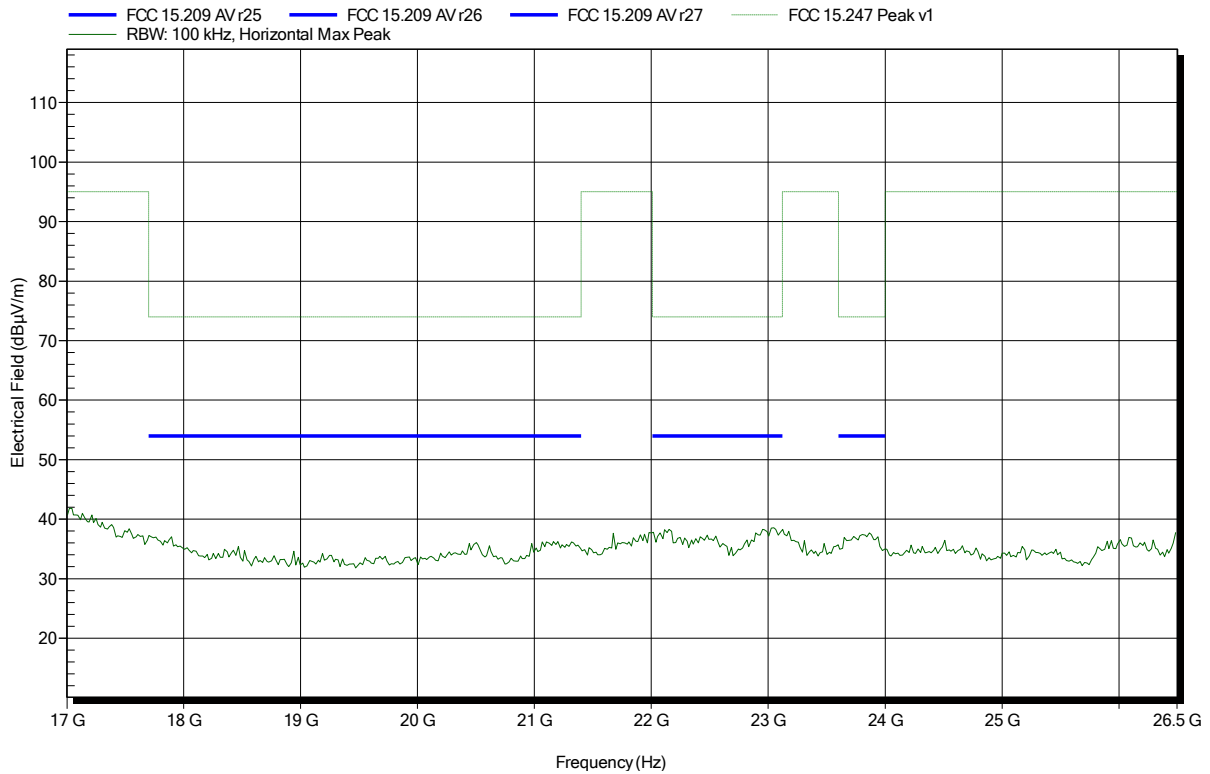

Spurious emissions according to FCC 15.247

Project number: G0M-1702-6284

Applicant: Panasonic Industrial Devices Europe GmbH
 EUT Name: Class 2 Bluetooth Low Energy Module
 Model: ENW89837A5KF
 Test Site: Eurofins Product Service GmbH
 Operator: Mr. Treffke
 Test Conditions: Tnom: 24°C, Vnom: 3.3 VDC (5.0V USB evaluation board)
 Antenna: Amplifier Research AT 4560 (old name) / ATH18G40 (new name), Vertical
 Measurement distance: 1 m converted to 3m
 Mode: TX; BLE; 2402 MHz
 Test Date: 2017-05-08
 Note:

Index 11

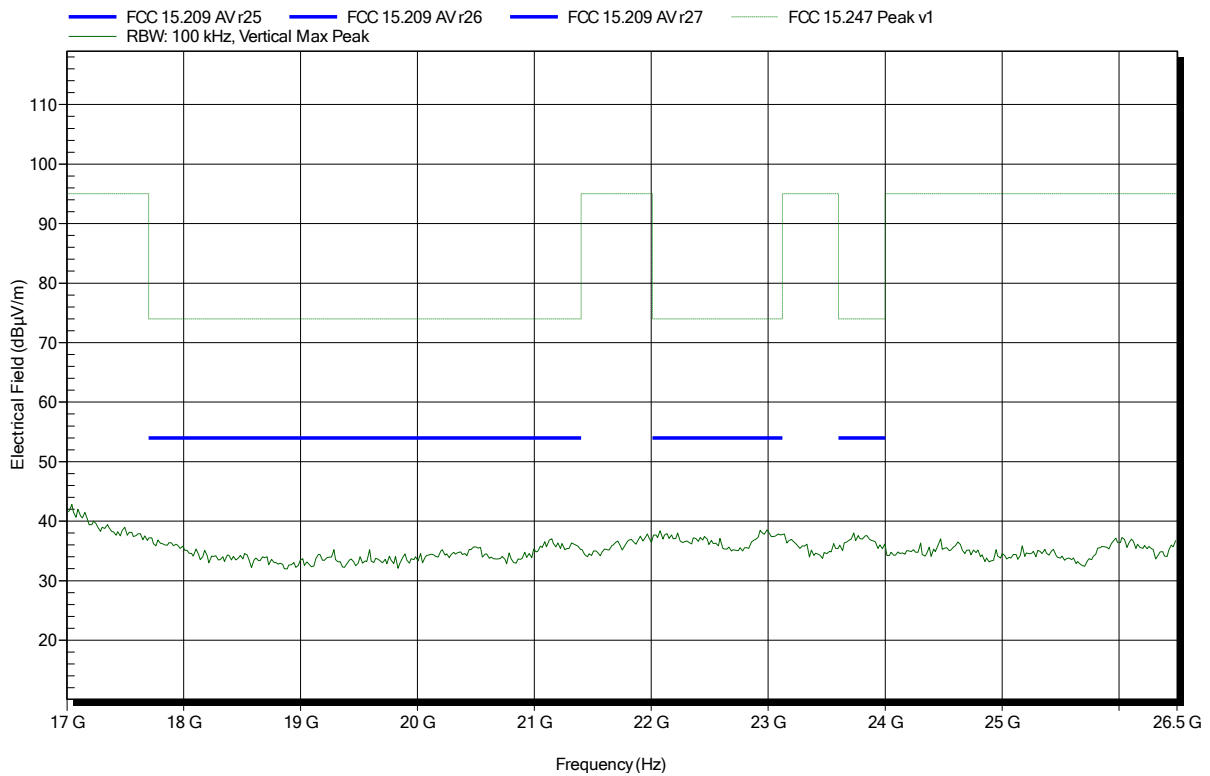

Spurious emissions according to FCC 15.247

Project number: G0M-1702-6284

Applicant: Panasonic Industrial Devices Europe GmbH
 EUT Name: Class 2 Bluetooth Low Energy Module
 Model: ENW89837A5KF
 Test Site: Eurofins Product Service GmbH
 Operator: Mr. Treffke
 Test Conditions: Tnom: 24°C, Vnom: 3.3 VDC (5.0V USB evaluation board)
 Antenna: Schwarzbeck BBHA 9120D, Horizontal
 Measurement distance: 1 m converted to 3m
 Mode: TX; BLE; 2440 MHz
 Test Date: 2017-05-08
 Note:

Index 12

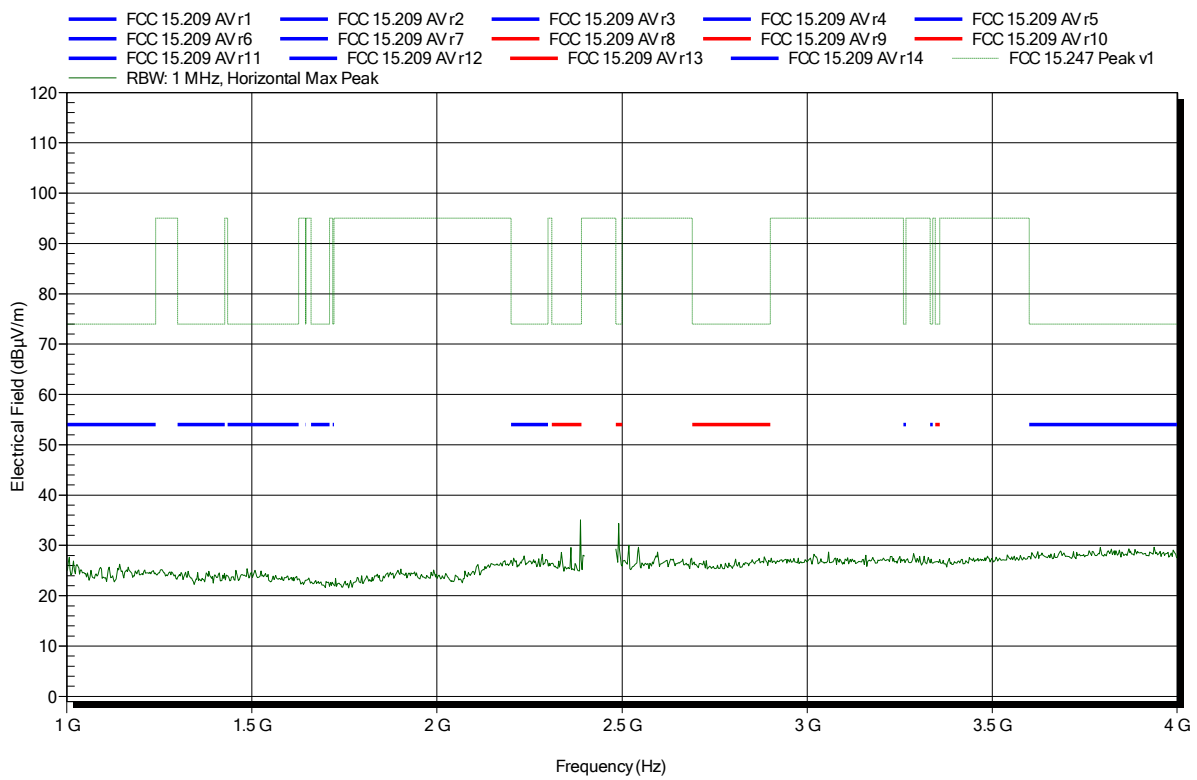

Spurious emissions according to FCC 15.247

Project number: G0M-1702-6284

Applicant: Panasonic Industrial Devices Europe GmbH
 EUT Name: Class 2 Bluetooth Low Energy Module
 Model: ENW89837A5KF
 Test Site: Eurofins Product Service GmbH
 Operator: Mr. Treffke
 Test Conditions: Tnom: 24°C, Vnom: 3.3 VDC (5.0V USB evaluation board)
 Antenna: Schwarzbeck BBHA 9120D, Vertical
 Measurement distance: 1 m converted to 3m
 Mode: TX; BLE; 2440 MHz
 Test Date: 2017-05-08
 Note:

Index 16

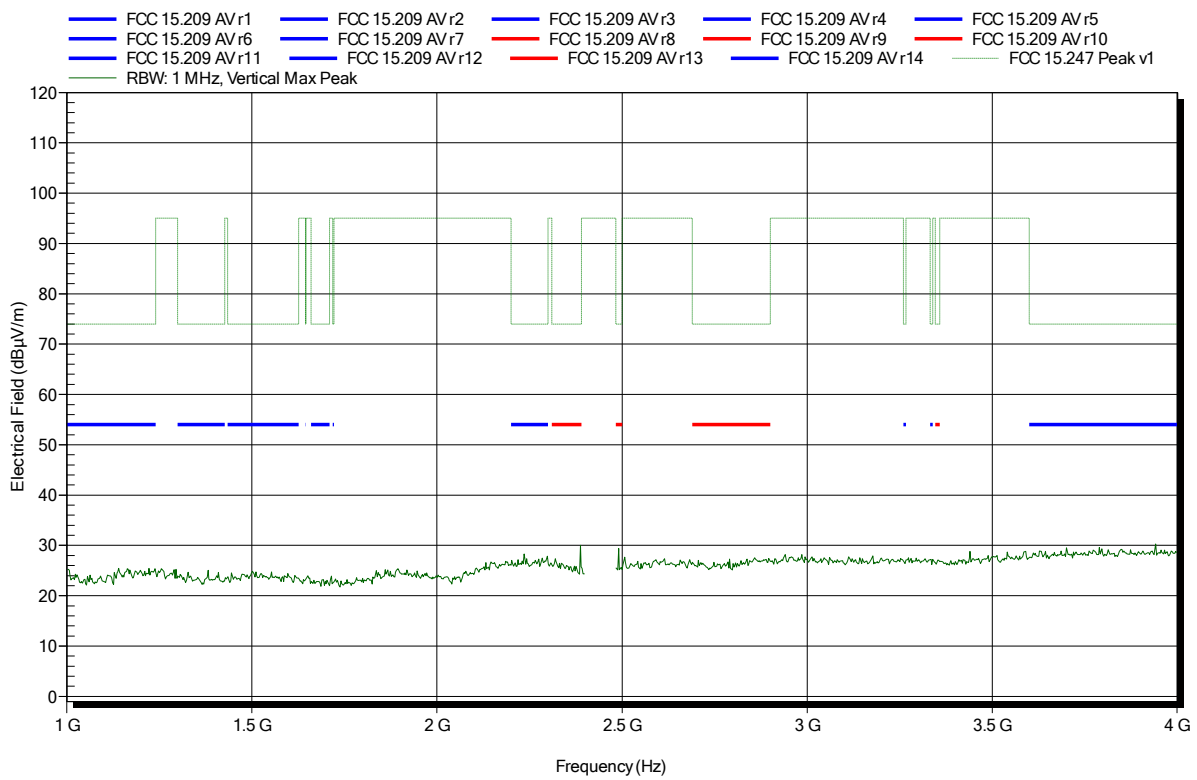

Spurious emissions according to FCC 15.247

Project number: G0M-1702-6284

Applicant: Panasonic Industrial Devices Europe GmbH
 EUT Name: Class 2 Bluetooth Low Energy Module
 Model: ENW89837A5KF
 Test Site: Eurofins Product Service GmbH
 Operator: Mr. Treffke
 Test Conditions: Tnom: 24°C, Vnom: 3.3 VDC (5.0V USB evaluation board)
 Antenna: Schwarzbeck BBHA 9120D, Horizontal
 Measurement distance: 1 m converted to 3m
 Mode: TX; BLE; 2440 MHz
 Test Date: 2017-05-08
 Note:

Index 13

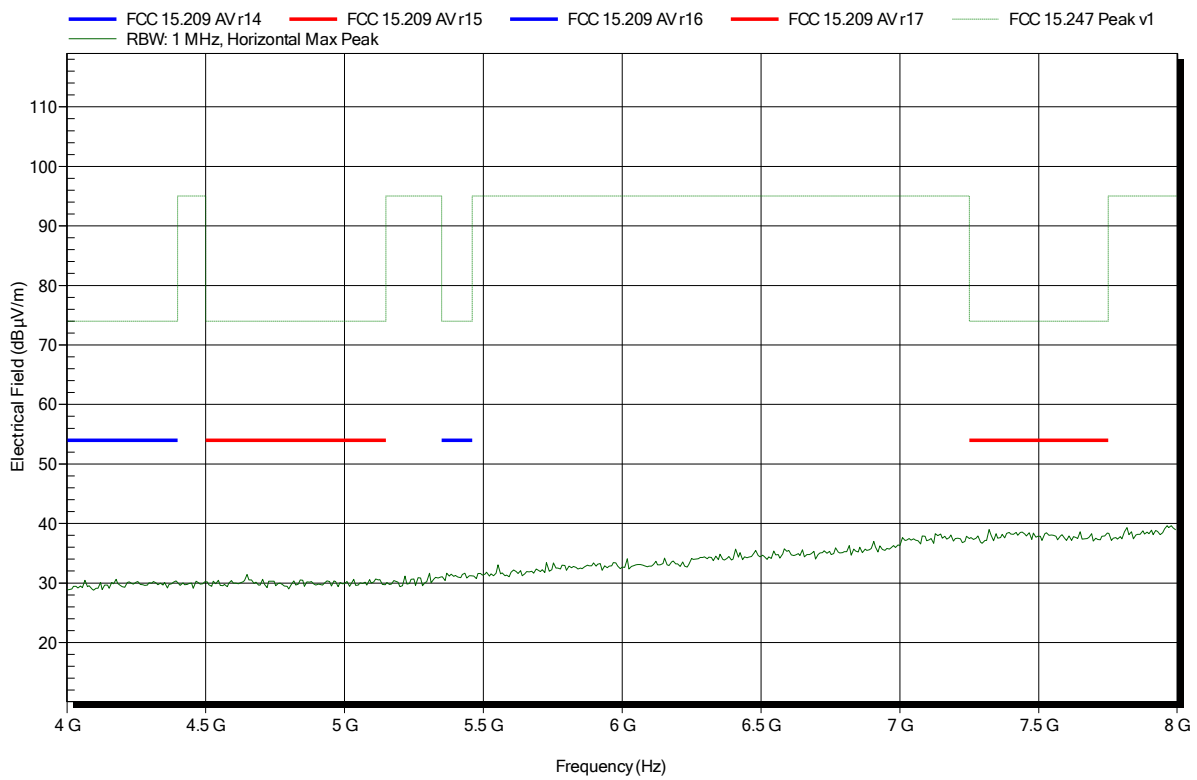

Spurious emissions according to FCC 15.247

Project number: G0M-1702-6284

Applicant: Panasonic Industrial Devices Europe GmbH
 EUT Name: Class 2 Bluetooth Low Energy Module
 Model: ENW89837A5KF
 Test Site: Eurofins Product Service GmbH
 Operator: Mr. Treffke
 Test Conditions: Tnom: 24°C, Vnom: 3.3 VDC (5.0V USB evaluation board)
 Antenna: Schwarzbeck BBHA 9120D, Vertical
 Measurement distance: 1 m converted to 3m
 Mode: TX; BLE; 2440 MHz
 Test Date: 2017-05-08
 Note:

Index 17

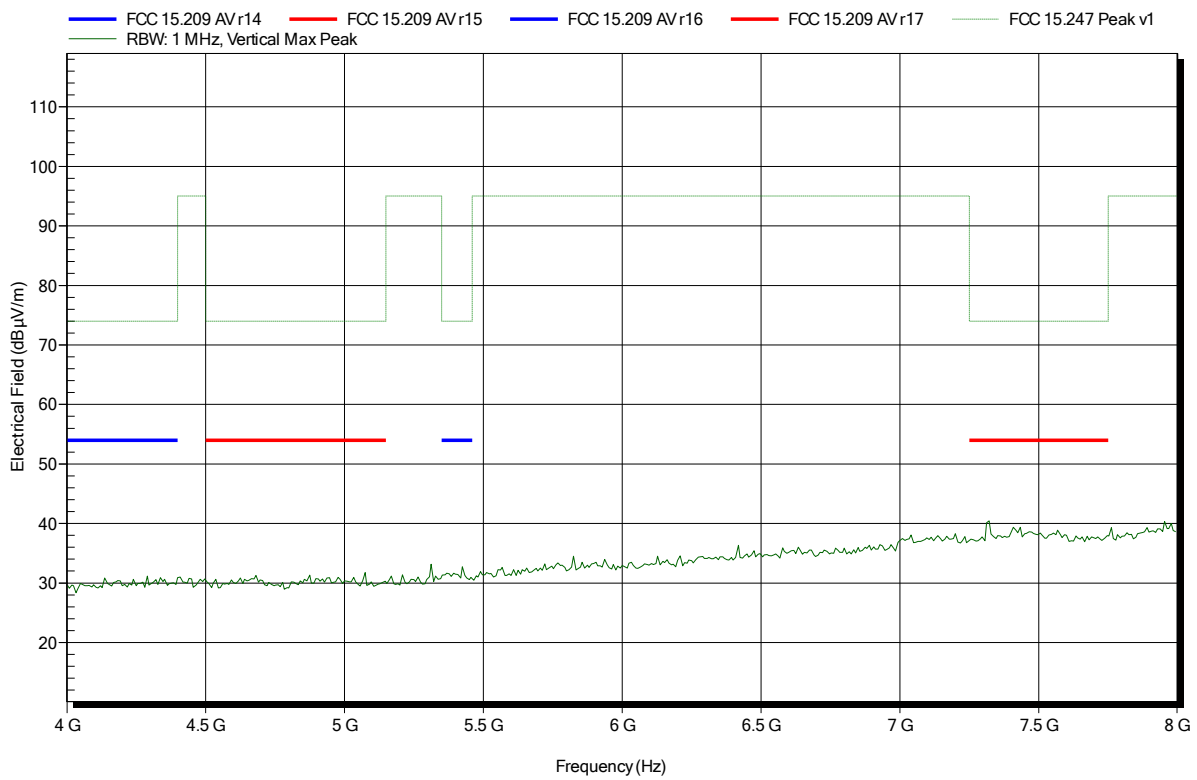

Spurious emissions according to FCC 15.247

Project number: G0M-1702-6284

Applicant: Panasonic Industrial Devices Europe GmbH
 EUT Name: Class 2 Bluetooth Low Energy Module
 Model: ENW89837A5KF
 Test Site: Eurofins Product Service GmbH
 Operator: Mr. Treffke
 Test Conditions: Tnom: 24°C, Vnom: 3.3 VDC (5.0V USB evaluation board)
 Antenna: Schwarzbeck BBHA 9120D, Horizontal
 Measurement distance: 1 m converted to 3m
 Mode: TX; BLE; 2440 MHz
 Test Date: 2017-05-08
 Note:

Index 14

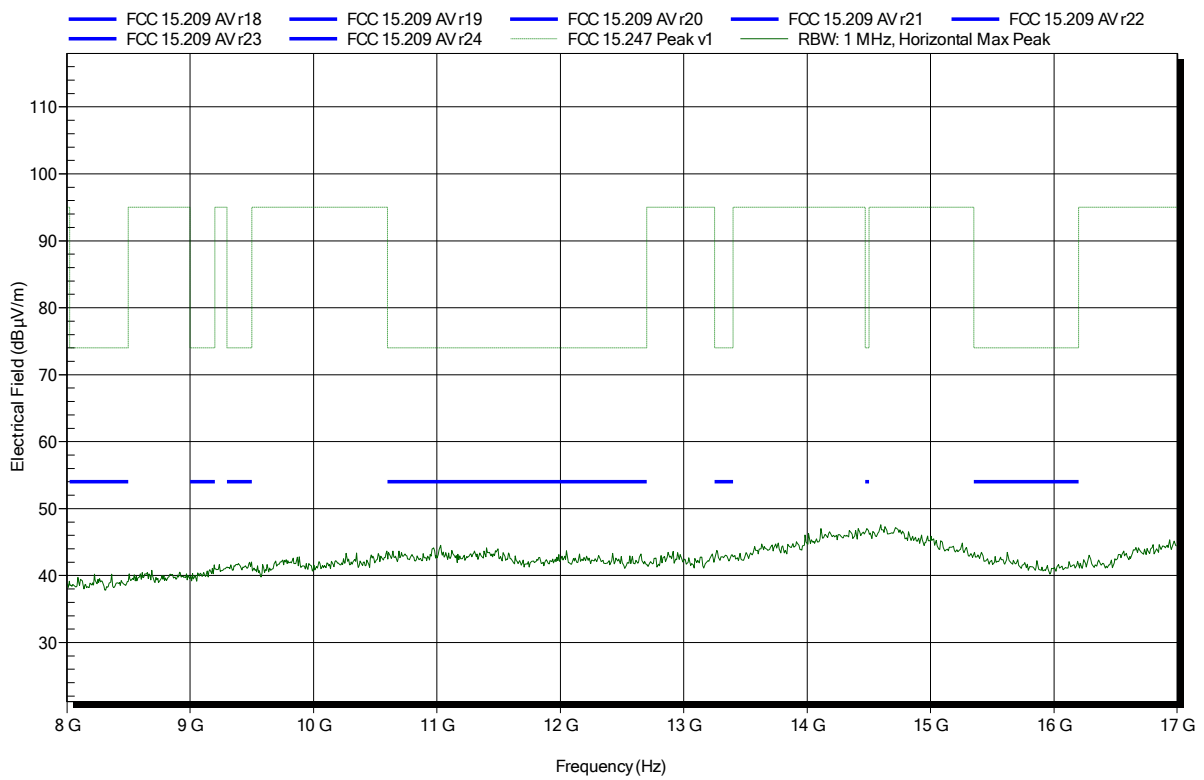

Spurious emissions according to FCC 15.247

Project number: G0M-1702-6284

Applicant: Panasonic Industrial Devices Europe GmbH
 EUT Name: Class 2 Bluetooth Low Energy Module
 Model: ENW89837A5KF
 Test Site: Eurofins Product Service GmbH
 Operator: Mr. Treffke
 Test Conditions: Tnom: 24°C, Vnom: 3.3 VDC (5.0V USB evaluation board)
 Antenna: Schwarzbeck BBHA 9120D, Vertical
 Measurement distance: 1 m converted to 3m
 Mode: TX; BLE; 2440 MHz
 Test Date: 2017-05-08
 Note:

Index 18

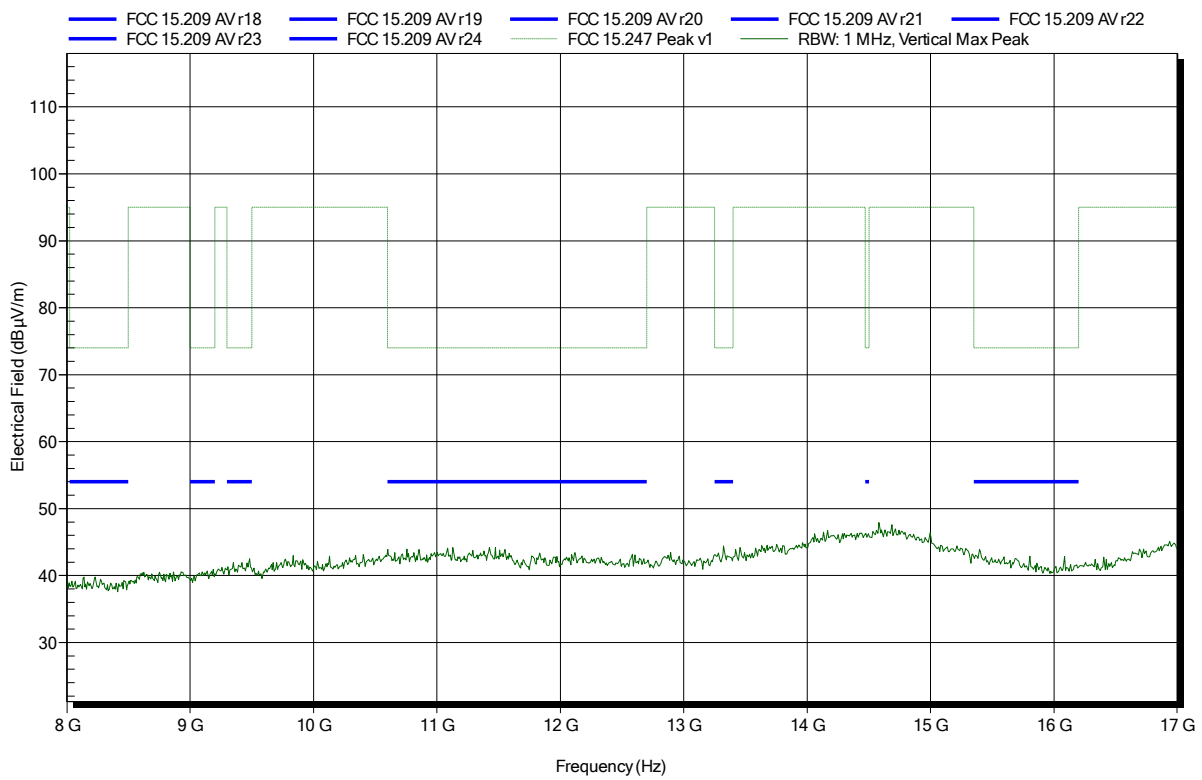

Spurious emissions according to FCC 15.247

Project number: G0M-1702-6284

Applicant: Panasonic Industrial Devices Europe GmbH
 EUT Name: Class 2 Bluetooth Low Energy Module
 Model: ENW89837A5KF
 Test Site: Eurofins Product Service GmbH
 Operator: Mr. Treffke
 Test Conditions: Tnom: 24°C, Vnom: 3.3 VDC (5.0V USB evaluation board)
 Antenna: Amplifier Research AT 4560 (old name) / ATH18G40 (new name),
 Horizontal
 Measurement distance: 1 m converted to 3m
 Mode: TX; BLE; 2440 MHz
 Test Date: 2017-05-08
 Note:

Index 15

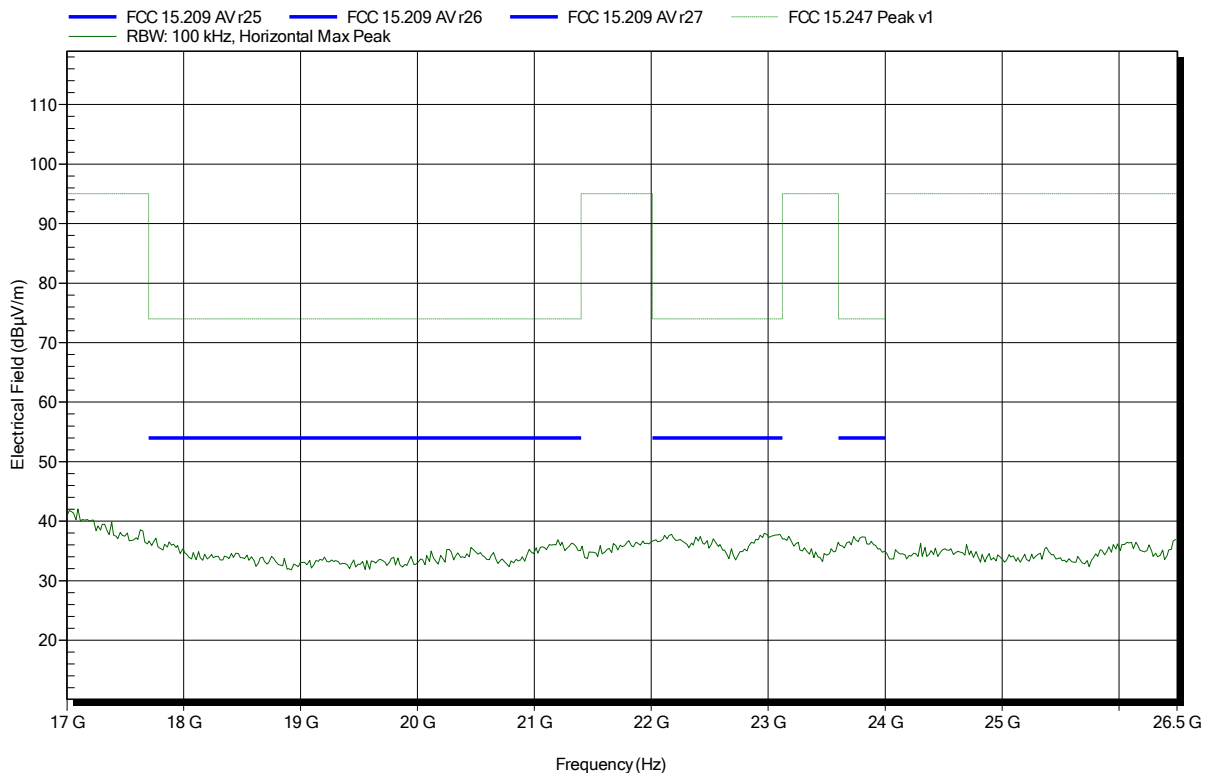

Spurious emissions according to FCC 15.247

Project number: G0M-1702-6284

Applicant: Panasonic Industrial Devices Europe GmbH
 EUT Name: Class 2 Bluetooth Low Energy Module
 Model: ENW89837A5KF
 Test Site: Eurofins Product Service GmbH
 Operator: Mr. Treffke
 Test Conditions: Tnom: 24°C, Vnom: 3.3 VDC (5.0V USB evaluation board)
 Antenna: Amplifier Research AT 4560 (old name) / ATH18G40 (new name), Vertical
 Measurement distance: 1 m converted to 3m
 Mode: TX; BLE; 2440 MHz
 Test Date: 2017-05-08
 Note:

Index 19

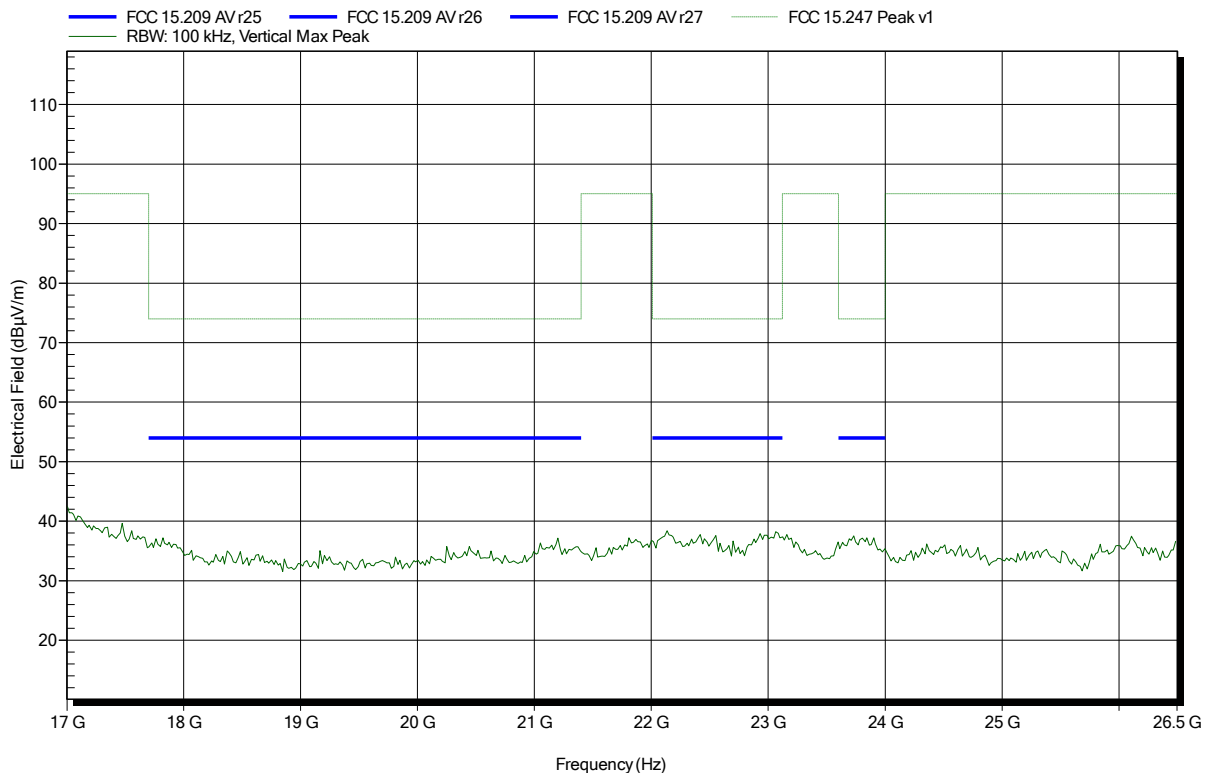

Spurious emissions according to FCC 15.247

Project number: G0M-1702-6284

Applicant: Panasonic Industrial Devices Europe GmbH
 EUT Name: Class 2 Bluetooth Low Energy Module
 Model: ENW89837A5KF
 Test Site: Eurofins Product Service GmbH
 Operator: Mr. Treffke
 Test Conditions: Tnom: 24°C, Vnom: 3.3 VDC (5.0V USB evaluation board)
 Antenna: Schwarzbeck BBHA 9120D, Horizontal
 Measurement distance: 1 m converted to 3m
 Mode: TX; BLE; 2480 MHz
 Test Date: 2017-05-08
 Note:

Index 21

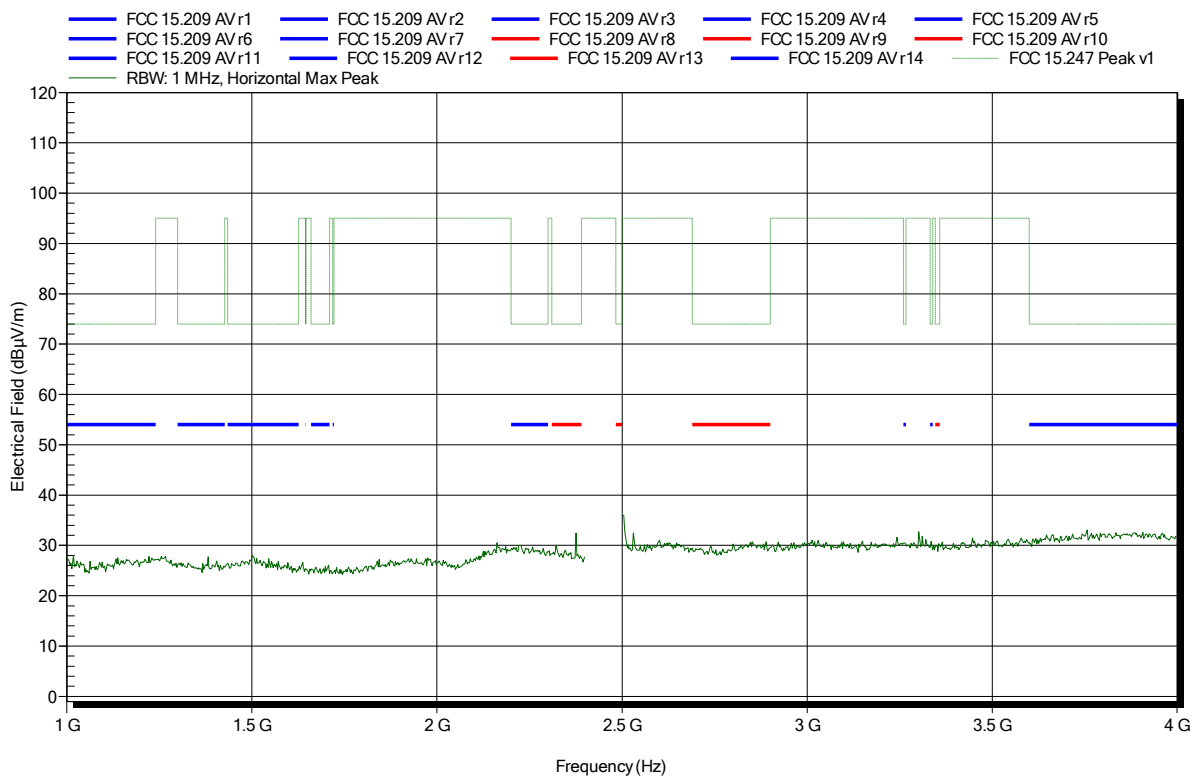

Spurious emissions according to FCC 15.247

Project number: G0M-1702-6284

Applicant: Panasonic Industrial Devices Europe GmbH
 EUT Name: Class 2 Bluetooth Low Energy Module
 Model: ENW89837A5KF
 Test Site: Eurofins Product Service GmbH
 Operator: Mr. Treffke
 Test Conditions: Tnom: 24°C, Vnom: 3.3 VDC (5.0V USB evaluation board)
 Antenna: Schwarzbeck BBHA 9120D, Vertical
 Measurement distance: 1 m converted to 3m
 Mode: TX; BLE; 2480 MHz
 Test Date: 2017-05-08
 Note:

Index 26

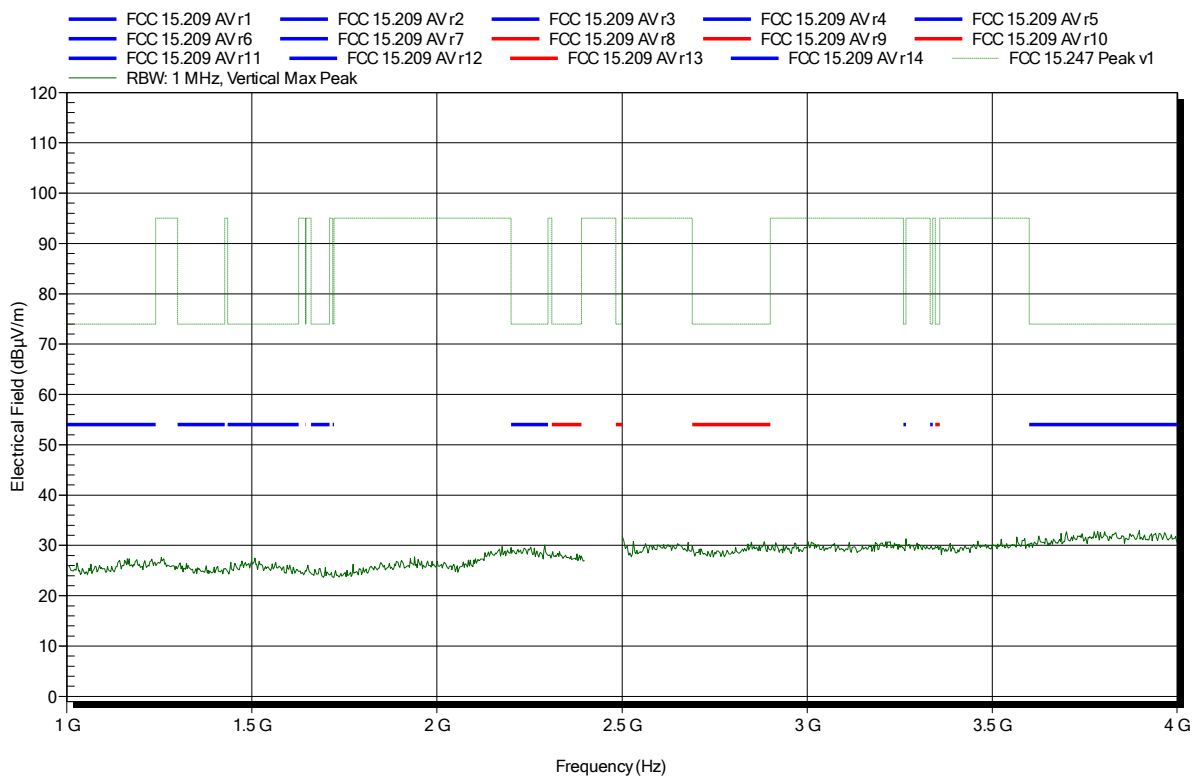

Spurious emissions according to FCC 15.247

Project number: G0M-1702-6284

Applicant: Panasonic Industrial Devices Europe GmbH
 EUT Name: Class 2 Bluetooth Low Energy Module
 Model: ENW89837A5KF
 Test Site: Eurofins Product Service GmbH
 Operator: Mr. Treffke
 Test Conditions: Tnom: 24°C, Vnom: 3.3 VDC (5.0V USB evaluation board)
 Antenna: Schwarzbeck BBHA 9120D, Horizontal
 Measurement distance: 1 m converted to 3m
 Mode: TX; BLE; 2480 MHz
 Test Date: 2017-05-08
 Note: upper bandedge

Index 22

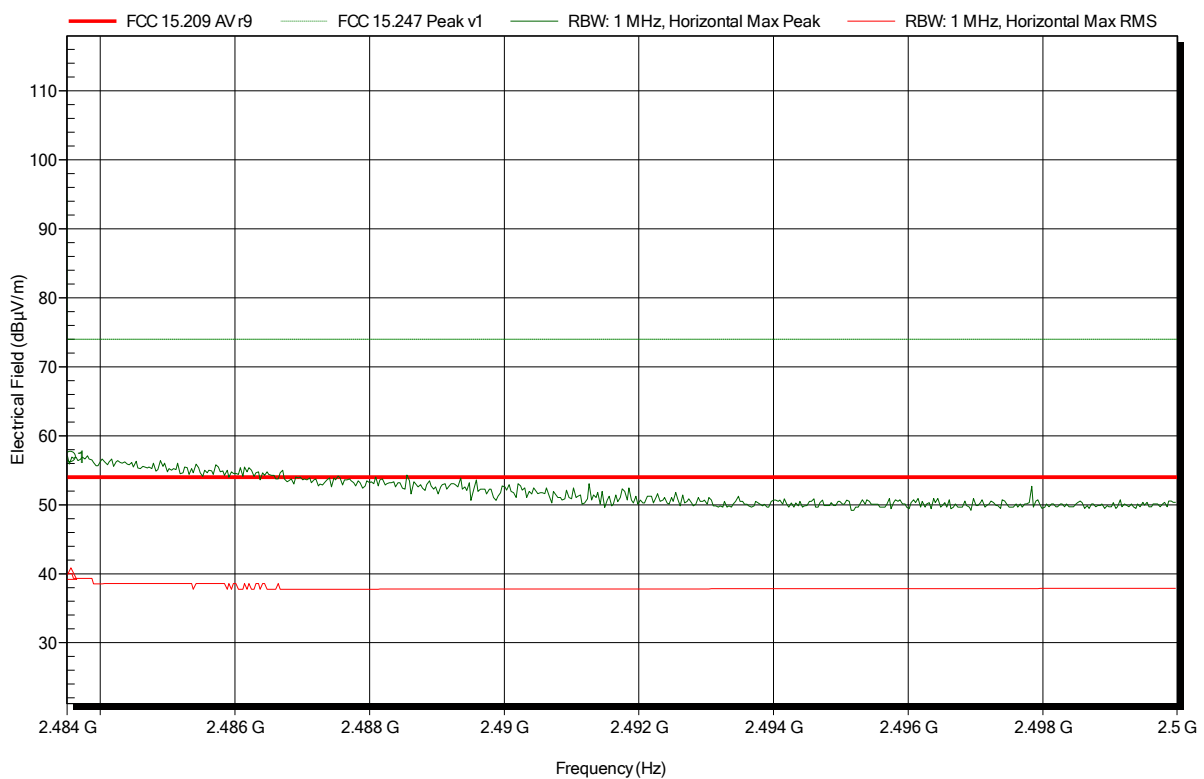

Frequency	Peak	Peak Limit	Peak Difference	Peak Status
2.4836 GHz	56.9 dBµV/m	74 dBµV/m	-17.1 dB	Pass
Frequency	RMS	RMS Limit	RMS Difference	RMS Status
2.4836 GHz	40 dBµV/m	54 dBµV/m	-14 dB	Pass

Spurious emissions according to FCC 15.247

Project number: G0M-1702-6284

Applicant: Panasonic Industrial Devices Europe GmbH
 EUT Name: Class 2 Bluetooth Low Energy Module
 Model: ENW89837A5KF
 Test Site: Eurofins Product Service GmbH
 Operator: Mr. Treffke
 Test Conditions: Tnom: 24°C, Vnom: 3.3 VDC (5.0V USB evaluation board)
 Antenna: Schwarzbeck BBHA 9120D, Vertical
 Measurement distance: 1 m converted to 3m
 Mode: TX; BLE; 2480 MHz
 Test Date: 2017-05-08
 Note: upper bandedge

Index 28

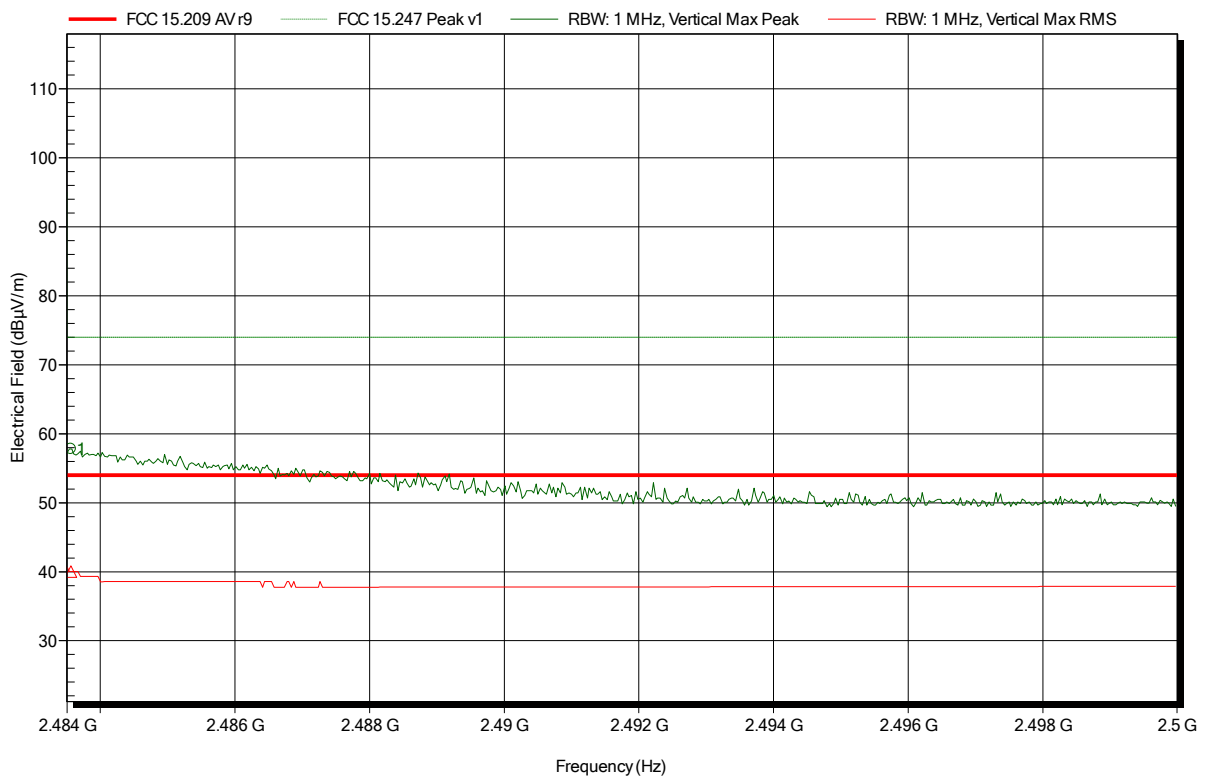

Frequency	Peak	Peak Limit	Peak Difference	Peak Status
2.4836 GHz	57.81 dBµV/m	74 dBµV/m	-16.19 dB	Pass
Frequency	RMS	RMS Limit	RMS Difference	RMS Status
2.4836 GHz	40 dBµV/m	54 dBµV/m	-14 dB	Pass

Spurious emissions according to FCC 15.247

Project number: G0M-1702-6284

Applicant: Panasonic Industrial Devices Europe GmbH
 EUT Name: Class 2 Bluetooth Low Energy Module
 Model: ENW89837A5KF
 Test Site: Eurofins Product Service GmbH
 Operator: Mr. Treffke
 Test Conditions: Tnom: 24°C, Vnom: 3.3 VDC (5.0V USB evaluation board)
 Antenna: Schwarzbeck BBHA 9120D, Horizontal
 Measurement distance: 1 m converted to 3m
 Mode: TX; BLE; 2480 MHz
 Test Date: 2017-05-08
 Note:

Index 23

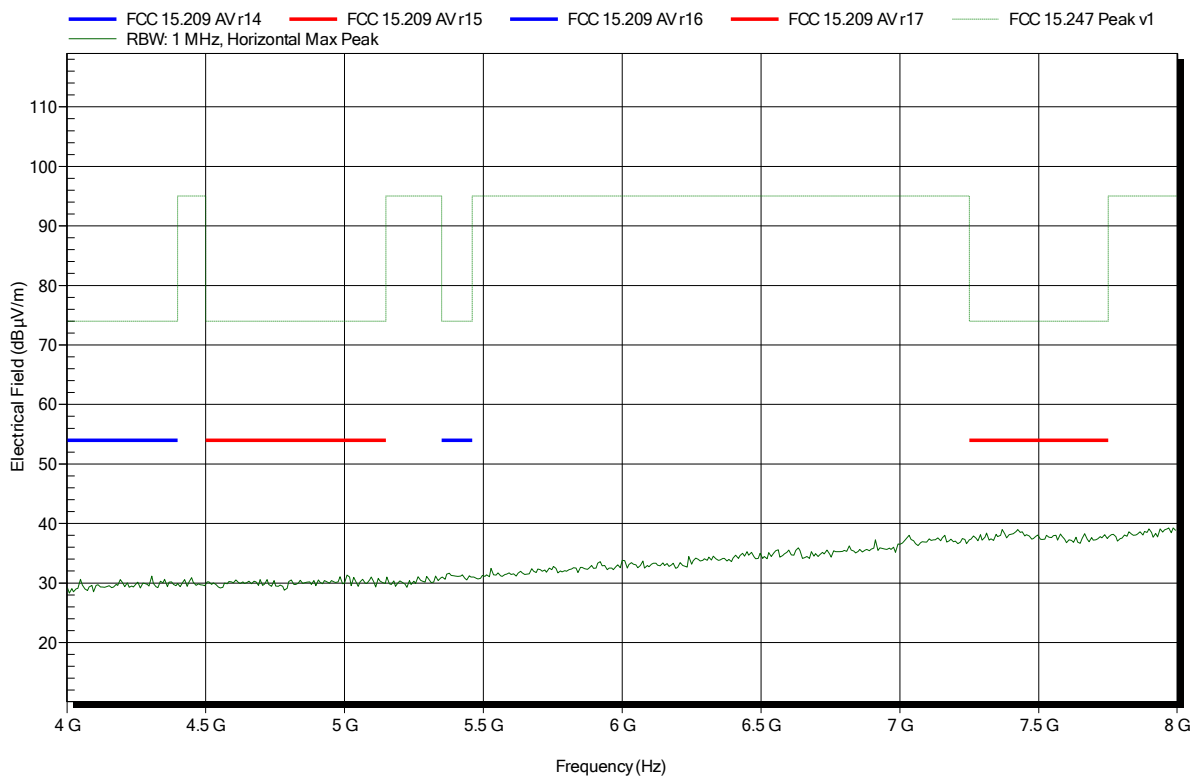

Spurious emissions according to FCC 15.247

Project number: G0M-1702-6284

Applicant: Panasonic Industrial Devices Europe GmbH
 EUT Name: Class 2 Bluetooth Low Energy Module
 Model: ENW89837A5KF
 Test Site: Eurofins Product Service GmbH
 Operator: Mr. Treffke
 Test Conditions: Tnom: 24°C, Vnom: 3.3 VDC (5.0V USB evaluation board)
 Antenna: Schwarzbeck BBHA 9120D, Vertical
 Measurement distance: 1 m converted to 3m
 Mode: TX; BLE; 2480 MHz
 Test Date: 2017-05-08
 Note:

Index 27

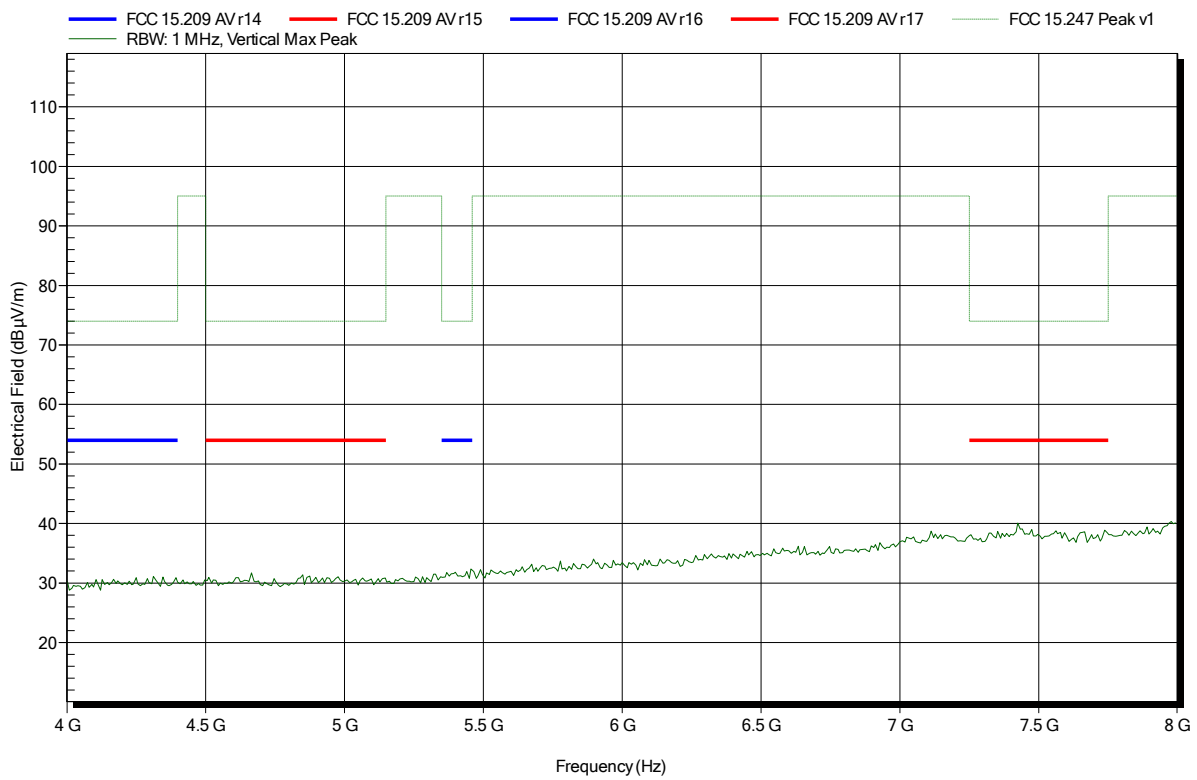

Spurious emissions according to FCC 15.247

Project number: G0M-1702-6284

Applicant: Panasonic Industrial Devices Europe GmbH
 EUT Name: Class 2 Bluetooth Low Energy Module
 Model: ENW89837A5KF
 Test Site: Eurofins Product Service GmbH
 Operator: Mr. Treffke
 Test Conditions: Tnom: 24°C, Vnom: 3.3 VDC (5.0V USB evaluation board)
 Antenna: Schwarzbeck BBHA 9120D, Horizontal
 Measurement distance: 1 m converted to 3m
 Mode: TX; BLE; 2480 MHz
 Test Date: 2017-05-08
 Note:

Index 24

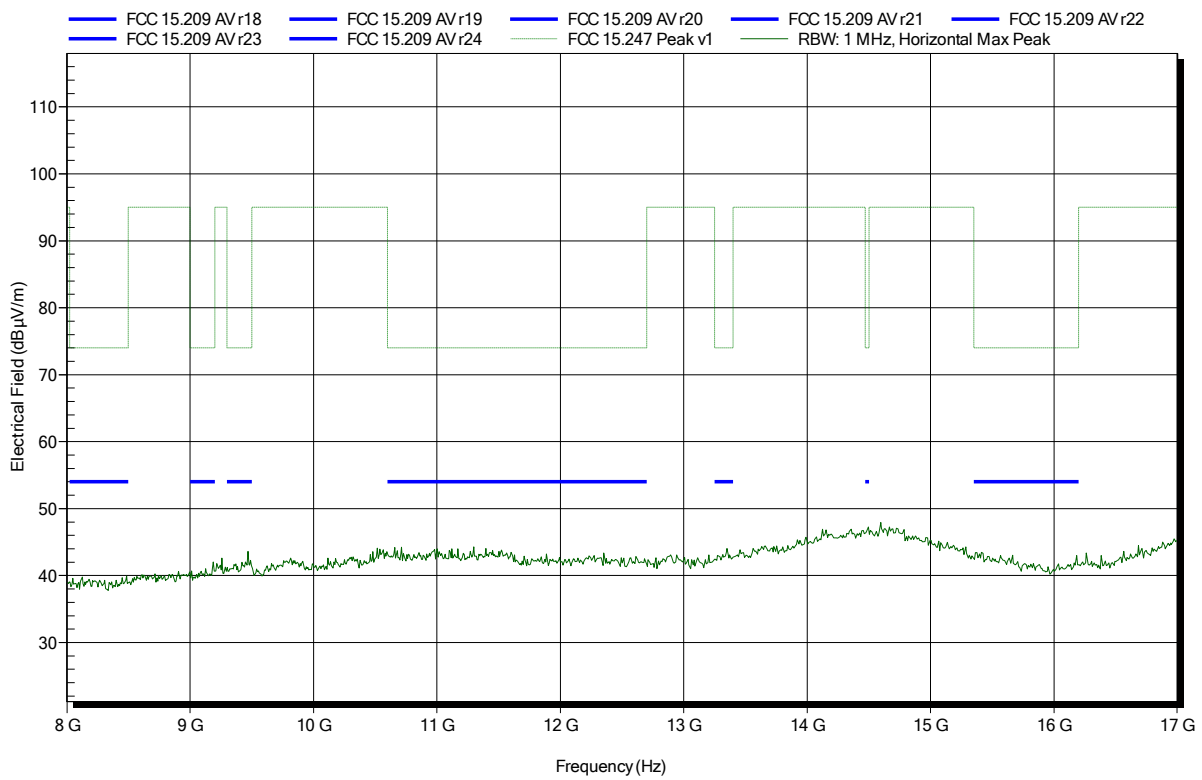

Spurious emissions according to FCC 15.247

Project number: G0M-1702-6284

Applicant: Panasonic Industrial Devices Europe GmbH
 EUT Name: Class 2 Bluetooth Low Energy Module
 Model: ENW89837A5KF
 Test Site: Eurofins Product Service GmbH
 Operator: Mr. Treffke
 Test Conditions: Tnom: 24°C, Vnom: 3.3 VDC (5.0V USB evaluation board)
 Antenna: Schwarzbeck BBHA 9120D, Vertical
 Measurement distance: 1 m converted to 3m
 Mode: TX; BLE; 2480 MHz
 Test Date: 2017-05-08
 Note:

Index 29

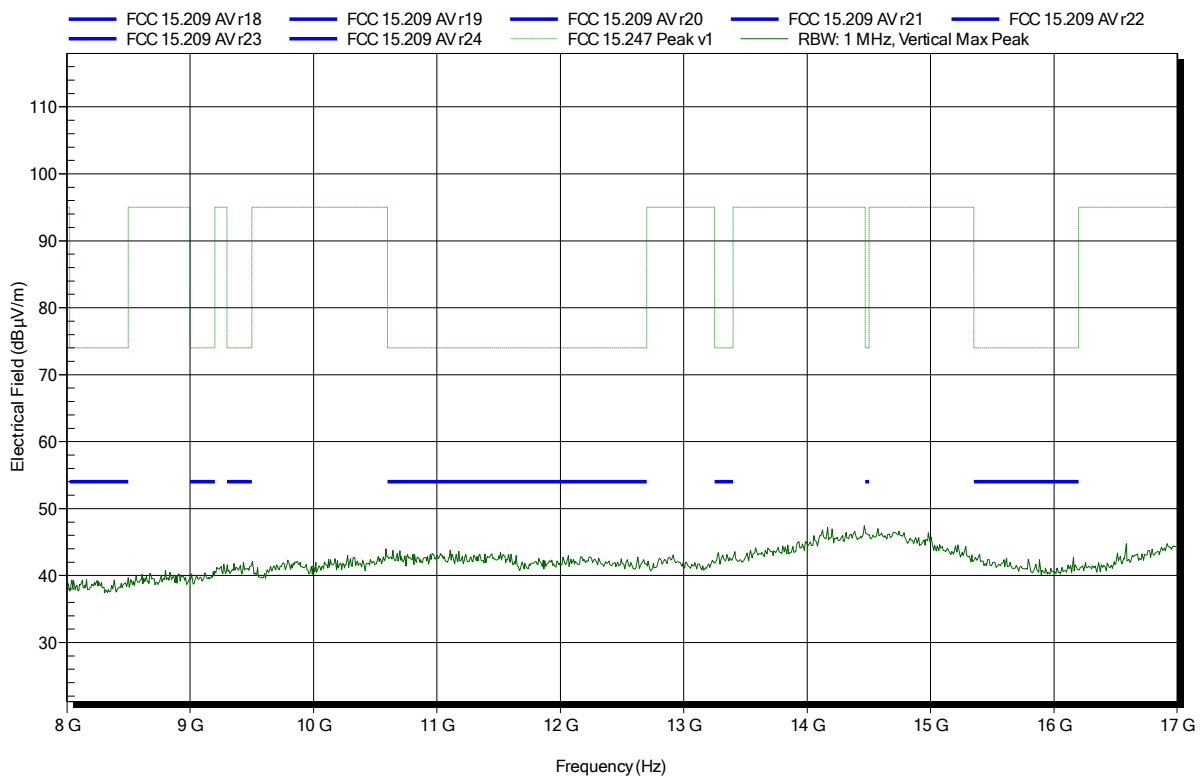

Spurious emissions according to FCC 15.247

Project number: G0M-1702-6284

Applicant: Panasonic Industrial Devices Europe GmbH
 EUT Name: Class 2 Bluetooth Low Energy Module
 Model: ENW89837A5KF
 Test Site: Eurofins Product Service GmbH
 Operator: Mr. Treffke
 Test Conditions: Tnom: 24°C, Vnom: 3.3 VDC (5.0V USB evaluation board)
 Antenna: Amplifier Research AT 4560 (old name) / ATH18G40 (new name),
 Horizontal
 Measurement distance: 1 m converted to 3m
 Mode: TX; BLE; 2480 MHz
 Test Date: 2017-05-08
 Note:

Index 25

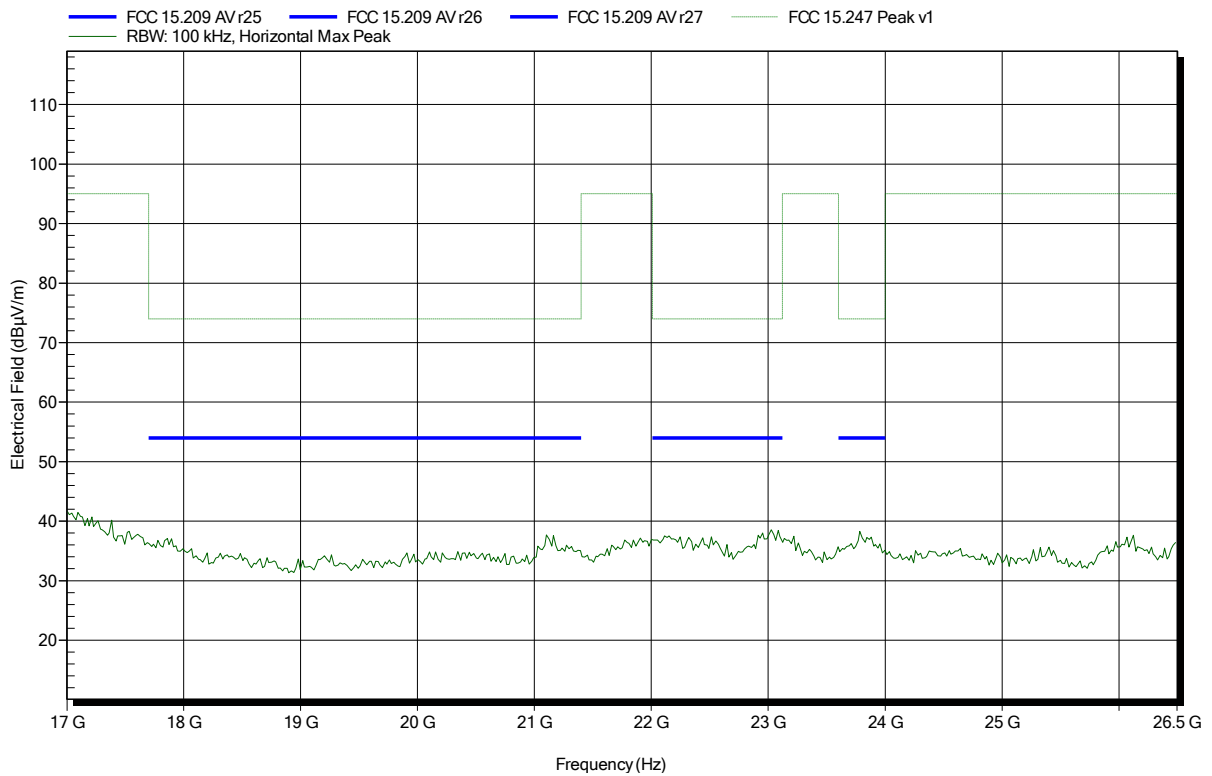

Spurious emissions according to FCC 15.247

Project number: G0M-1702-6284

Applicant: Panasonic Industrial Devices Europe GmbH
 EUT Name: Class 2 Bluetooth Low Energy Module
 Model: ENW89837A5KF
 Test Site: Eurofins Product Service GmbH
 Operator: Mr. Treffke
 Test Conditions: Tnom: 24°C, Vnom: 3.3 VDC (5.0V USB evaluation board)
 Antenna: Amplifier Research AT 4560 (old name) / ATH18G40 (new name), Vertical
 Measurement distance: 1 m converted to 3m
 Mode: TX; BLE; 2480 MHz
 Test Date: 2017-05-08
 Note:

Index 31

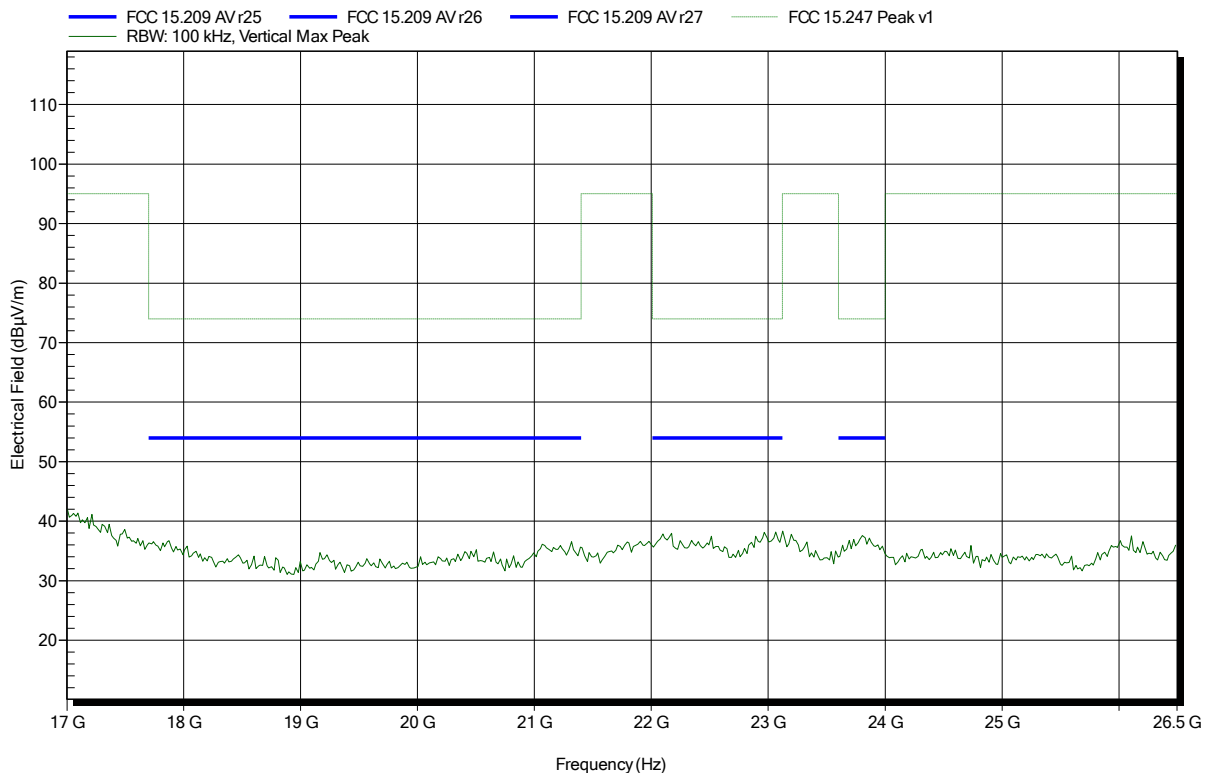

ANNEX B Receiver spurious emissions

Spurious emissions according to RSS-Gen Issue 4

Project number: G0M-1702-6284

Applicant: Panasonic Industrial Devices Europe GmbH
 EUT Name: Class 2 Bluetooth Low Energy Module
 Model: ENW89837A5KF
 Test Site: Eurofins Product Service GmbH
 Operator: Mr. Treffke
 Test Conditions: Tnom: 24°C, Vnom: 3.3 VDC (5.0V USB evaluation board)
 Antenna: Rohde & Schwarz HK 116, Horizontal
 Measurement distance: 3 m
 Mode: RX; BLE; 2440 MHz
 Test Date: 2017-05-09
 Note:

Index 36

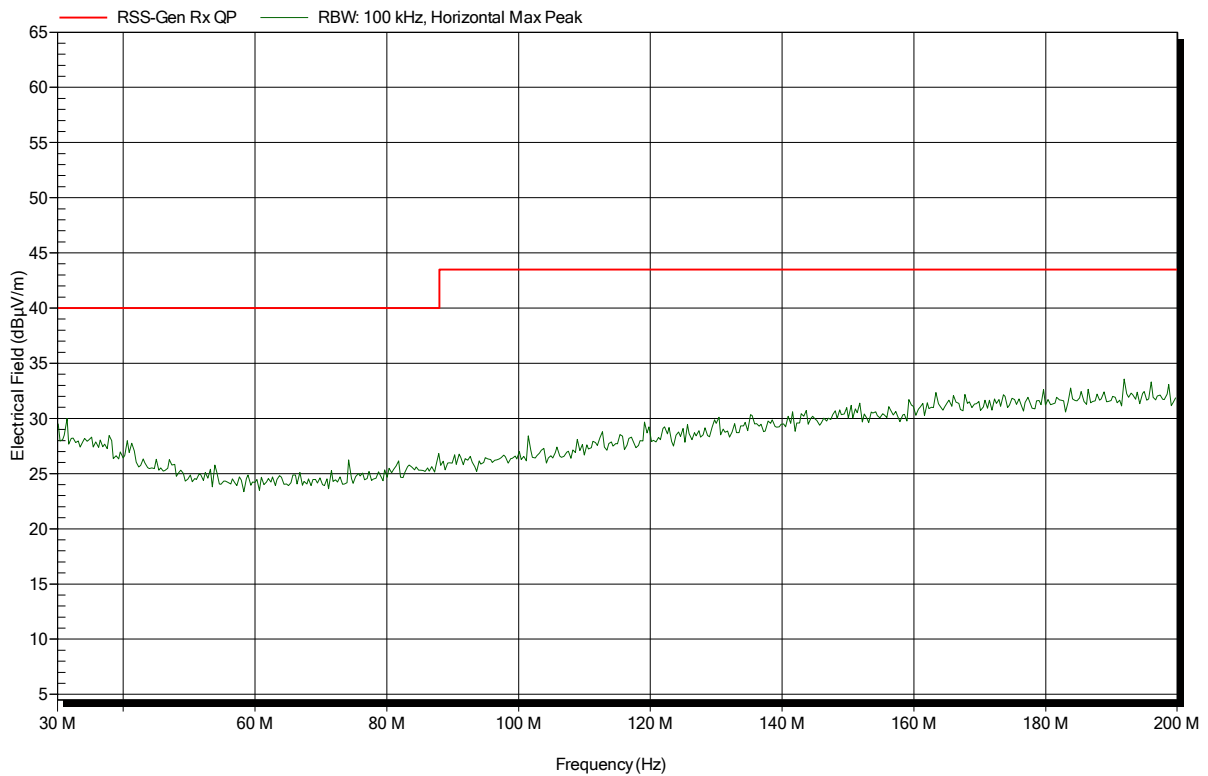

Spurious emissions according to RSS-Gen Issue 4

Project number: G0M-1702-6284

Applicant: Panasonic Industrial Devices Europe GmbH
 EUT Name: Class 2 Bluetooth Low Energy Module
 Model: ENW89837A5KF
 Test Site: Eurofins Product Service GmbH
 Operator: Mr. Treffke
 Test Conditions: Tnom: 24°C, Vnom: 3.3 VDC (5.0V USB evaluation board)
 Antenna: Rohde & Schwarz HK 116, Vertical
 Measurement distance: 3 m
 Mode: RX; BLE; 2440 MHz
 Test Date: 2017-05-09
 Note:

Index 37

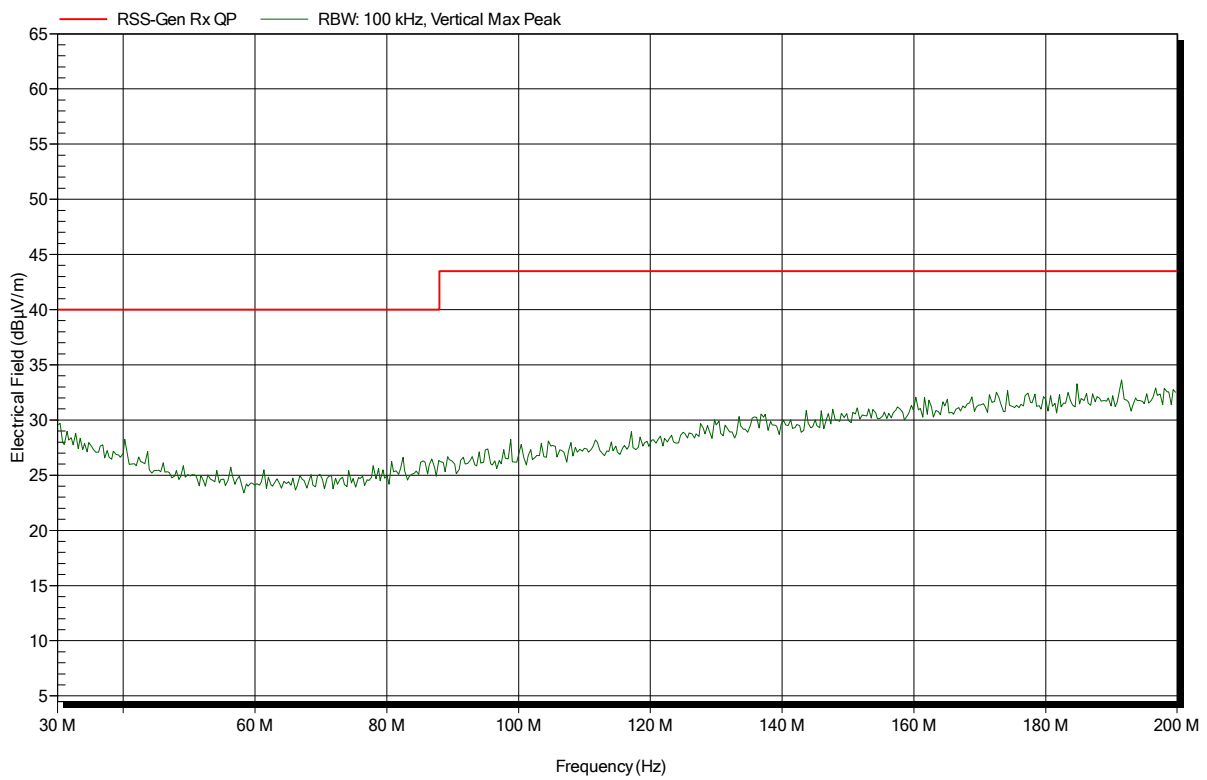

Spurious emissions according to RSS-Gen Issue 4

Project number: G0M-1702-6284

Applicant: Panasonic Industrial Devices Europe GmbH
 EUT Name: Class 2 Bluetooth Low Energy Module
 Model: ENW89837A5KF
 Test Site: Eurofins Product Service GmbH
 Operator: Mr. Treffke
 Test Conditions: Tnom: 24°C, Vnom: 3.3 VDC (5.0V USB evaluation board)
 Antenna: Rohde & Schwarz HL 223, Horizontal
 Measurement distance: 3 m
 Mode: RX; BLE; 2440 MHz
 Test Date: 2017-05-09
 Note:

Index 39

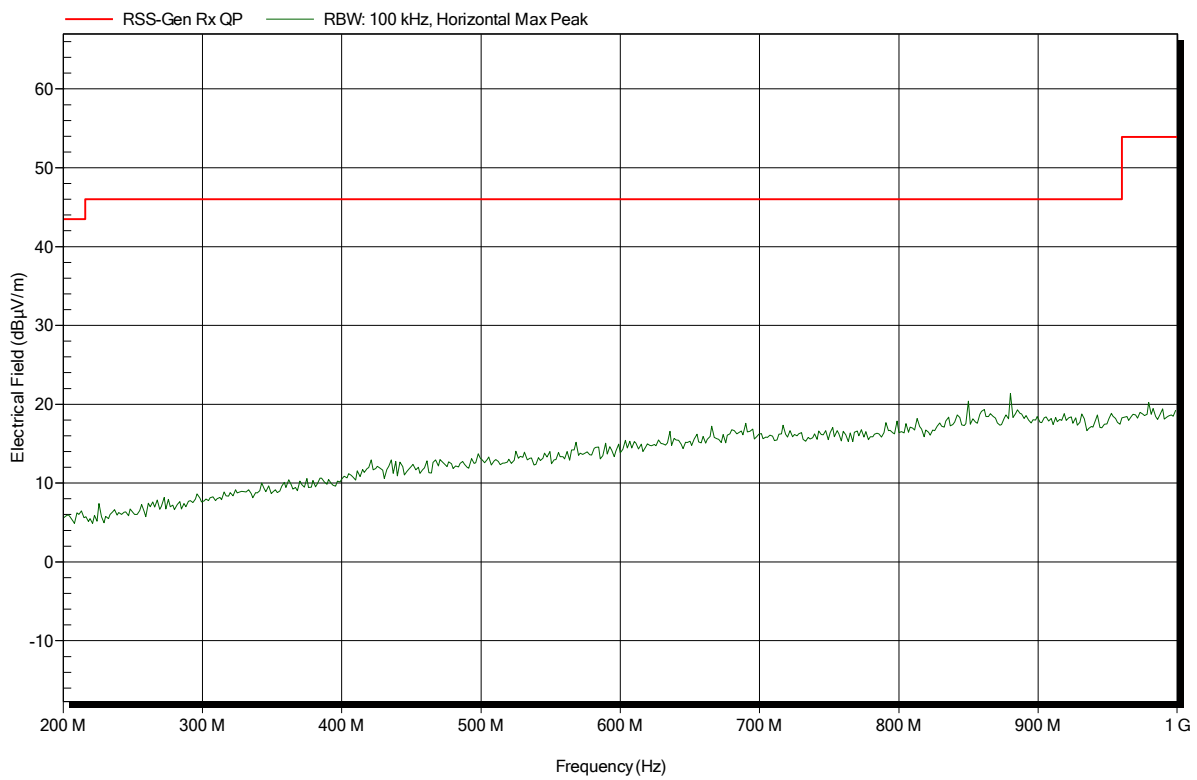

Spurious emissions according to RSS-Gen Issue 4

Project number: G0M-1702-6284

Applicant: Panasonic Industrial Devices Europe GmbH
 EUT Name: Class 2 Bluetooth Low Energy Module
 Model: ENW89837A5KF
 Test Site: Eurofins Product Service GmbH
 Operator: Mr. Treffke
 Test Conditions: Tnom: 24°C, Vnom: 3.3 VDC (5.0V USB evaluation board)
 Antenna: Rohde & Schwarz HL 223, Vertical
 Measurement distance: 3 m
 Mode: RX; BLE; 2440 MHz
 Test Date: 2017-05-09
 Note:

Index 40

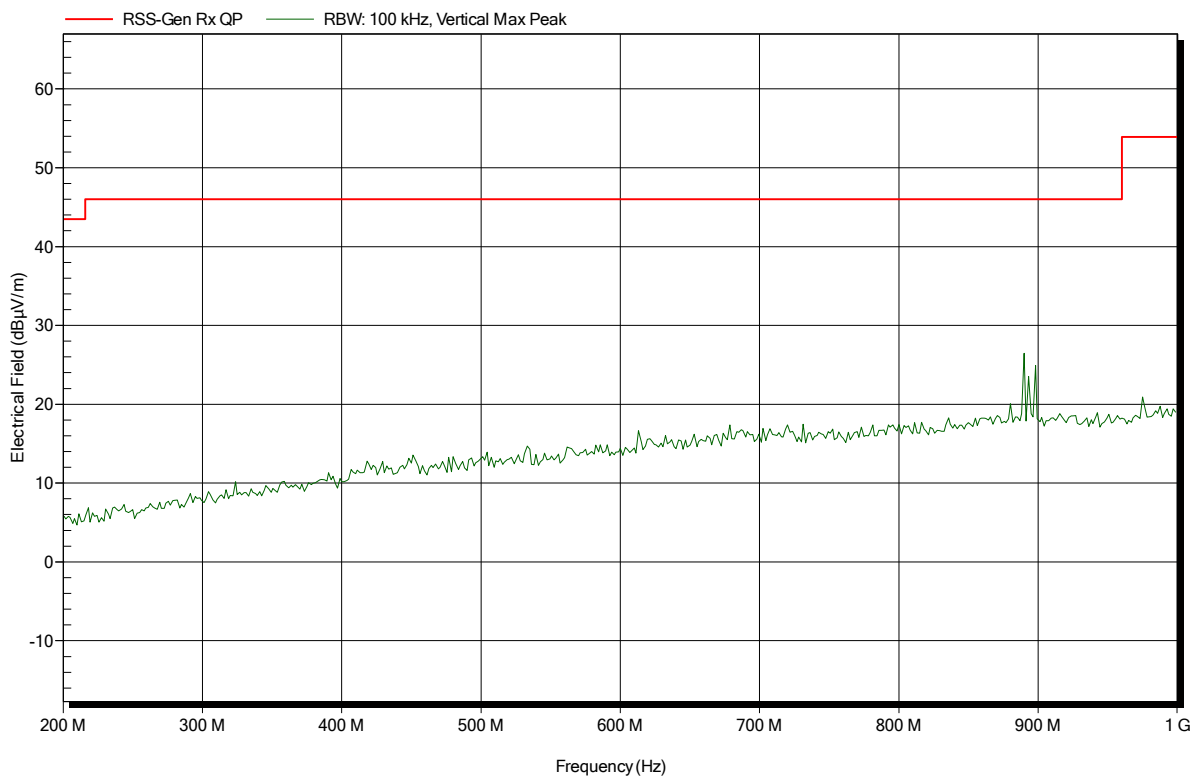

Spurious emissions according to RSS-Gen Issue 4

Project number: G0M-1702-6284

Applicant: Panasonic Industrial Devices Europe GmbH
 EUT Name: Class 2 Bluetooth Low Energy Module
 Model: ENW89837A5KF
 Test Site: Eurofins Product Service GmbH
 Operator: Mr. Treffke
 Test Conditions: Tnom: 24°C, Vnom: 3.3 VDC (5.0V USB evaluation board)
 Antenna: Schwarzbeck BBHA 9120D, Horizontal
 Measurement distance: 3 m
 Mode: RX; BLE; 2440 MHz
 Test Date: 2017-05-09
 Note:

Index 42

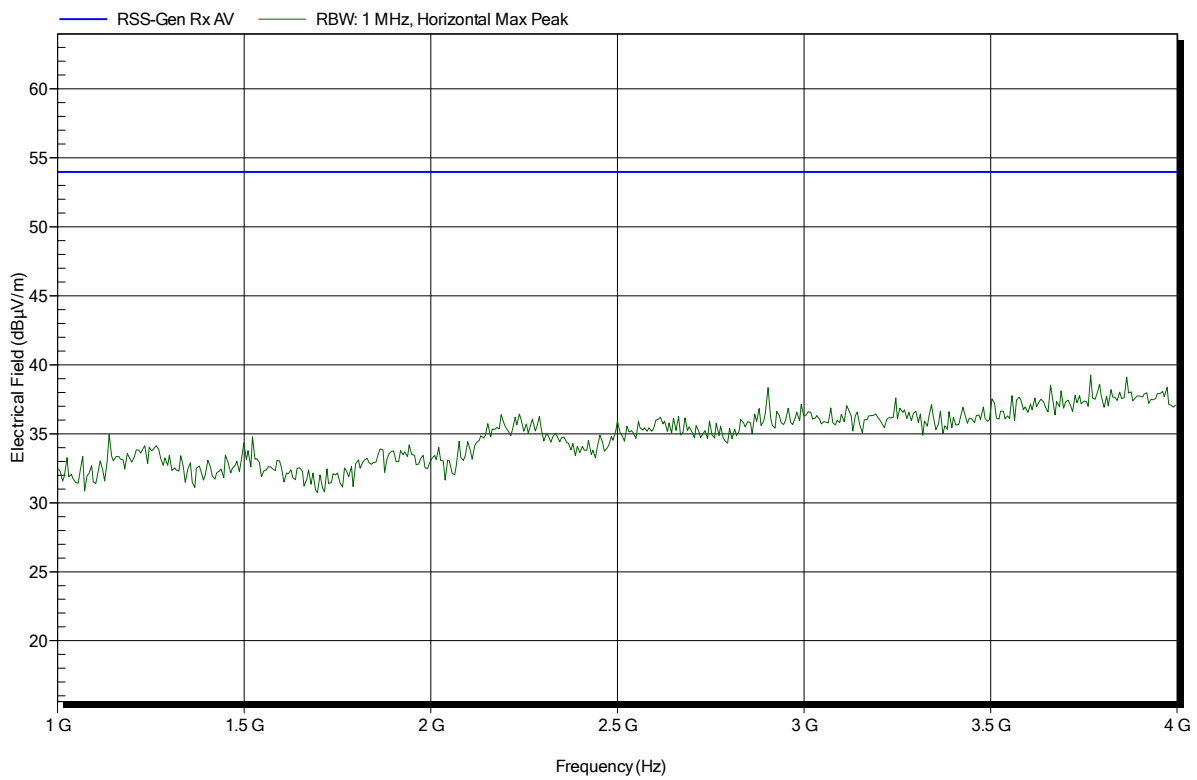

Spurious emissions according to RSS-Gen Issue 4

Project number: G0M-1702-6284

Applicant: Panasonic Industrial Devices Europe GmbH
 EUT Name: Class 2 Bluetooth Low Energy Module
 Model: ENW89837A5KF
 Test Site: Eurofins Product Service GmbH
 Operator: Mr. Treffke
 Test Conditions: Tnom: 24°C, Vnom: 3.3 VDC (5.0V USB evaluation board)
 Antenna: Schwarzbeck BBHA 9120D, Vertical
 Measurement distance: 3 m
 Mode: RX; BLE; 2440 MHz
 Test Date: 2017-05-09
 Note:

Index 46

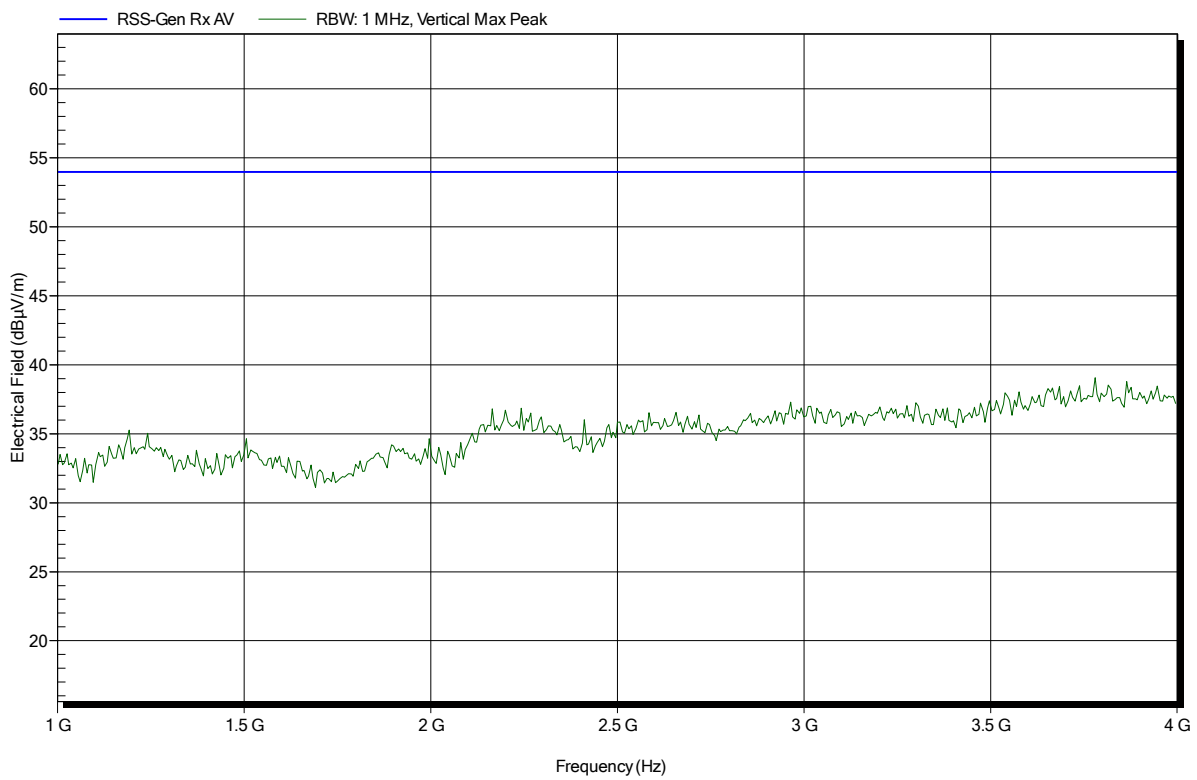

Spurious emissions according to RSS-Gen Issue 4

Project number: G0M-1702-6284

Applicant: Panasonic Industrial Devices Europe GmbH
 EUT Name: Class 2 Bluetooth Low Energy Module
 Model: ENW89837A5KF
 Test Site: Eurofins Product Service GmbH
 Operator: Mr. Treffke
 Test Conditions: Tnom: 24°C, Vnom: 3.3 VDC (5.0V USB evaluation board)
 Antenna: Schwarzbeck BBHA 9120D, Horizontal
 Measurement distance: 3 m
 Mode: RX; BLE; 2440 MHz
 Test Date: 2017-05-09
 Note:

Index 44

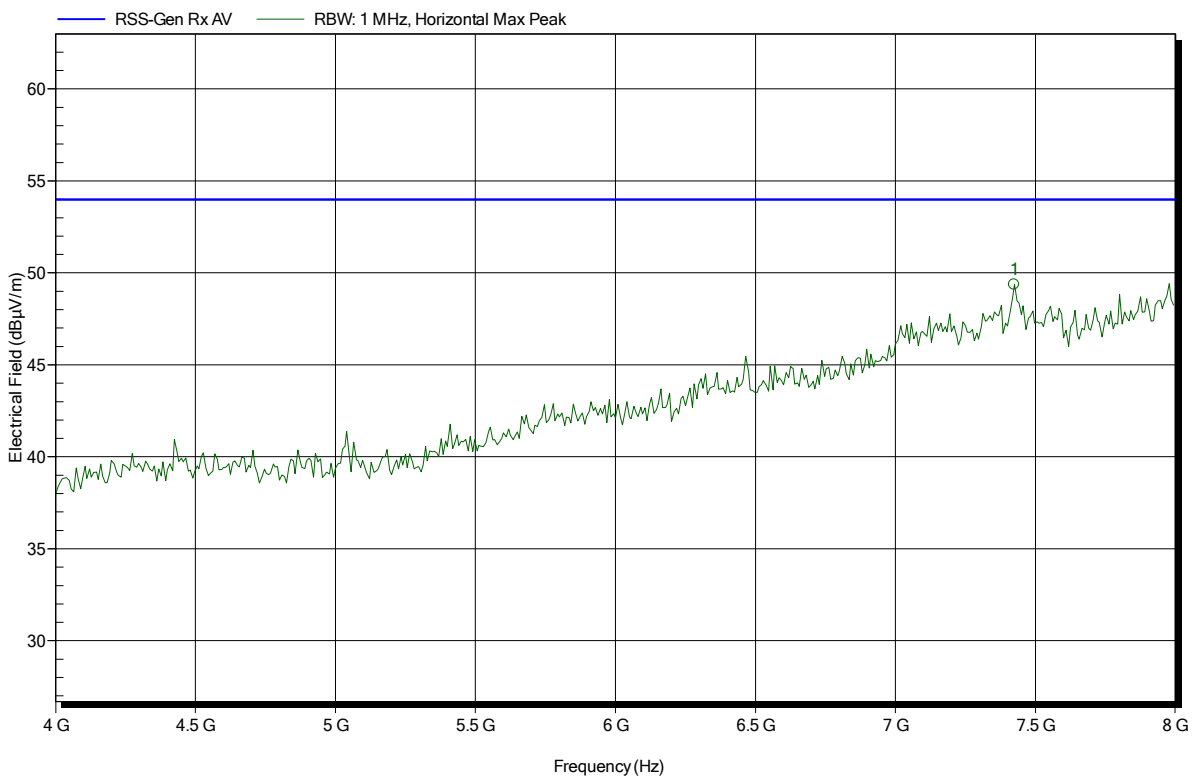

Frequency	Peak	Peak Limit	Peak Difference	Peak Status
7.424 GHz	49.37 dBµV/m	53.98 dBµV/m	-4.61 dB	Pass

Spurious emissions according to RSS-Gen Issue 4

Project number: G0M-1702-6284

Applicant: Panasonic Industrial Devices Europe GmbH
 EUT Name: Class 2 Bluetooth Low Energy Module
 Model: ENW89837A5KF
 Test Site: Eurofins Product Service GmbH
 Operator: Mr. Treffke
 Test Conditions: Tnom: 24°C, Vnom: 3.3 VDC (5.0V USB evaluation board)
 Antenna: Schwarzbeck BBHA 9120D, Vertical
 Measurement distance: 3 m
 Mode: RX; BLE; 2440 MHz
 Test Date: 2017-05-09
 Note:

Index 47

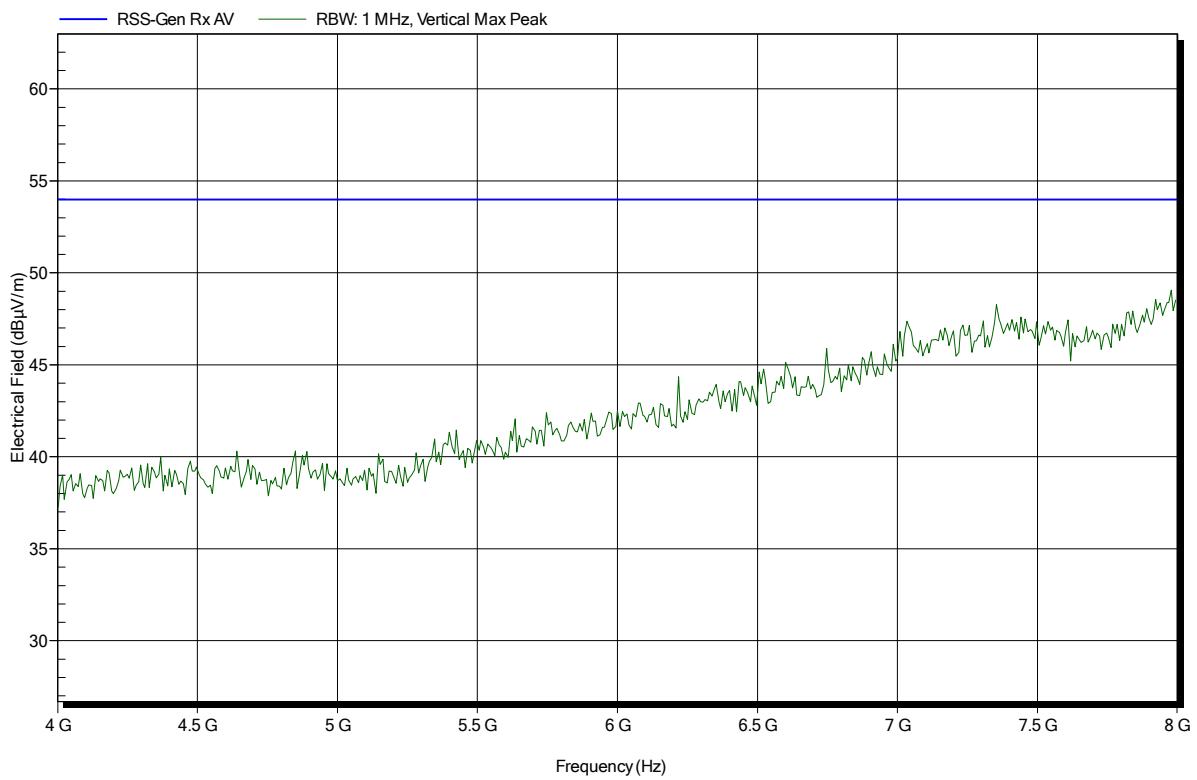

Spurious emissions according to RSS-Gen Issue 4

Project number: G0M-1702-6284

Applicant: Panasonic Industrial Devices Europe GmbH
 EUT Name: Class 2 Bluetooth Low Energy Module
 Model: ENW89837A5KF
 Test Site: Eurofins Product Service GmbH
 Operator: Mr. Treffke
 Test Conditions: Tnom: 24°C, Vnom: 3.3 VDC (5.0V USB evaluation board)
 Antenna: Schwarzbeck BBHA 9120D, Horizontal
 Measurement distance: 1 m converted to 3m
 Mode: RX; BLE; 2440 MHz
 Test Date: 2017-05-09
 Note:

Index 45

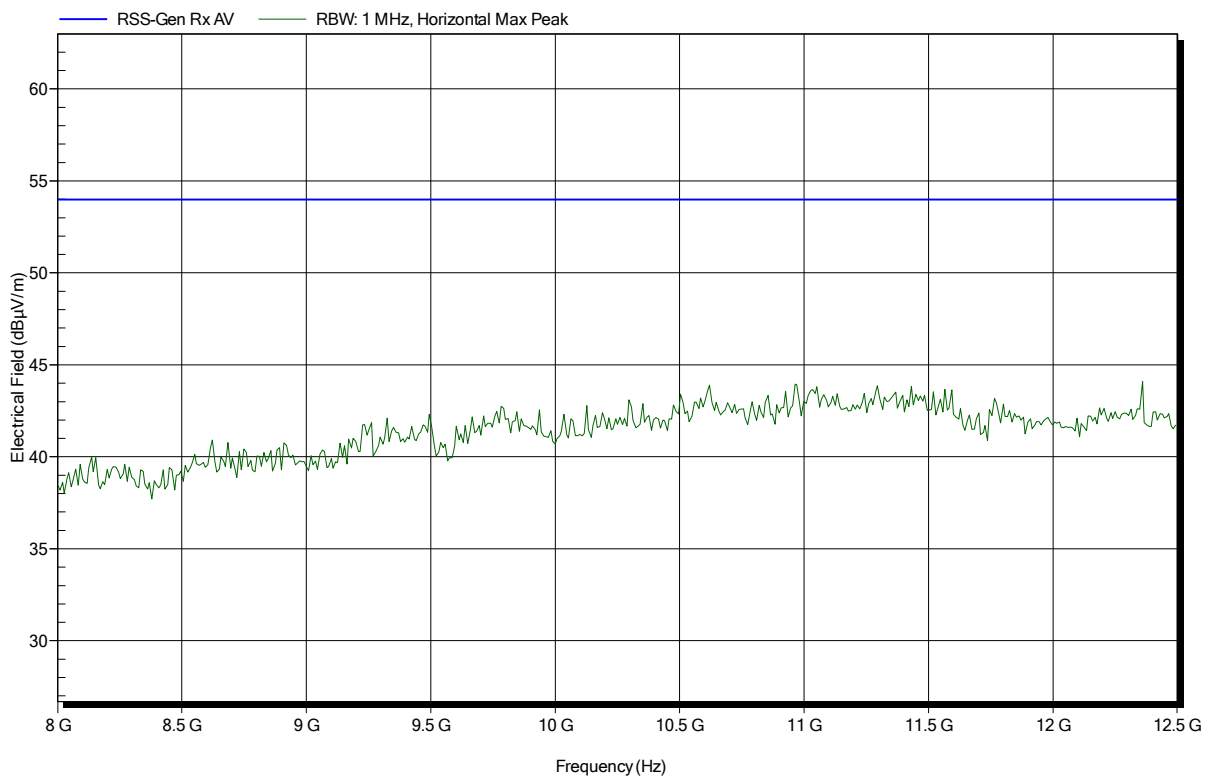

Spurious emissions according to RSS-Gen Issue 4

Project number: G0M-1702-6284

Applicant: Panasonic Industrial Devices Europe GmbH
 EUT Name: Class 2 Bluetooth Low Energy Module
 Model: ENW89837A5KF
 Test Site: Eurofins Product Service GmbH
 Operator: Mr. Treffke
 Test Conditions: Tnom: 24°C, Vnom: 3.3 VDC (5.0V USB evaluation board)
 Antenna: Schwarzbeck BBHA 9120D, Vertical
 Measurement distance: 1 m converted to 3m
 Mode: RX; BLE; 2440 MHz
 Test Date: 2017-05-09
 Note:

Index 48

