



TAOGLAS®



Datasheet

Part No:
GW.51.5153

Description:
Wi-Fi 2.4/5.8/7.1GHz 5dBi Dipole Terminal Mount Antenna RP-SMA(M) Hinged

Features:
2.4/5.8/7.1GHz Band Operation
Wi-Fi 6/7 Compatible
5dBi Gain
High Efficiency up to 80%
Hinged RP-SMA (M) Connector
Height: 198mm
Diameter: 13mm
RoHS & Reach Compliant

1. Introduction	3
2. Specifications	4
3. Antenna Characteristics	5
4. Radiation Patterns	7
5. Mechanical Drawing	14
6. Packaging	15
<hr/>	
Changelog	16

Taoglas makes no warranties based on the accuracy or completeness of the contents of this document and reserves the right to make changes to specifications and product descriptions at any time without notice. Taoglas reserves all rights to this document and the information contained herein. Reproduction, use or disclosure to third parties without express permission is strictly prohibited.



1. Introduction



The Taoglas GW.51 is a 2.4 & 5.8GHz Wi-Fi terminal mount dipole antenna. At just 198mm in height and 13mm in diameter, the robust TPEE enclosure can be mounted straight or at right angle to the device with its hinged RP-SMA(M) connector. It is ideal for applications such as Bluetooth, BLE, ZigBee, Wi-Fi 6 & 7 and Wireless LAN. The GW.51, designed for superior performance and reliability, has an omnidirectional radiation pattern and extremely high efficiency and gain on all Wi-Fi bands.

Typical applications include:

- Smart Home
- Gateways/Routers
- Connected Agriculture

The GW.51 has up to 5dBi Peak making it a cost-effective, high-performing choice for any indoor or outdoor application. Many module manufacturers specify peak gain limits for any antennas that are to be connected to that module. Those peak gain limits are based on free-space conditions. In practice, the peak gain of an antenna tested in free-space can degrade by at least 1 or 2dBi when installed. So ideally you should go for a slightly higher peak gain antenna than mentioned on the module specification to compensate for this effect.

This provides you with improved performance. Upon testing of any of our antennas with your device and appropriate layout, integration technique, or cable, we can work with you to make any of our antennas' perform below the peak gain limits. Taoglas can then issue a specification and/or report for the selected antenna in your device that will clearly show it complying with the peak gain limits. You can be assured that you are meeting the regulatory requirements for that module whilst getting the best performance possible, without exceeding the peak gain limits.

For further information, or support to test and integrate this product please contact your regional Taoglas customer support team.

2. Specifications

Electrical			
Frequency (MHz)	2400~2500	4900~5850	5925~7125
Efficiency (%)			
Free space	63	61	60
30X30cm Ground plane	64	65	64
Average Gain (dB)			
Free space	-1.99	-2.14	-2.23
30X30cm Ground plane	-1.94	-1.89	-1.94
Peak Gain (dBi)			
Free space	5.23	5.54	6.57
30X30cm Ground plane	4.52	6.38	8.83
Impedance	50Ω		
Polarization	Linear		
Radiation Pattern	Omni		
Max. input power	1W		
Mechanical			
Height	198 ±3.3 mm		
Planner Dimension	198*Ø13 mm		
Casing	TPEE		
Connector	RP-SMA(M)		
Weight	22.5 g		
Environmental			
Temperature Range	-40°C to 85°C		
Humidity	Non-condensing 65°C 95% RH		

3. Antenna Characteristics

3.1 Return Loss

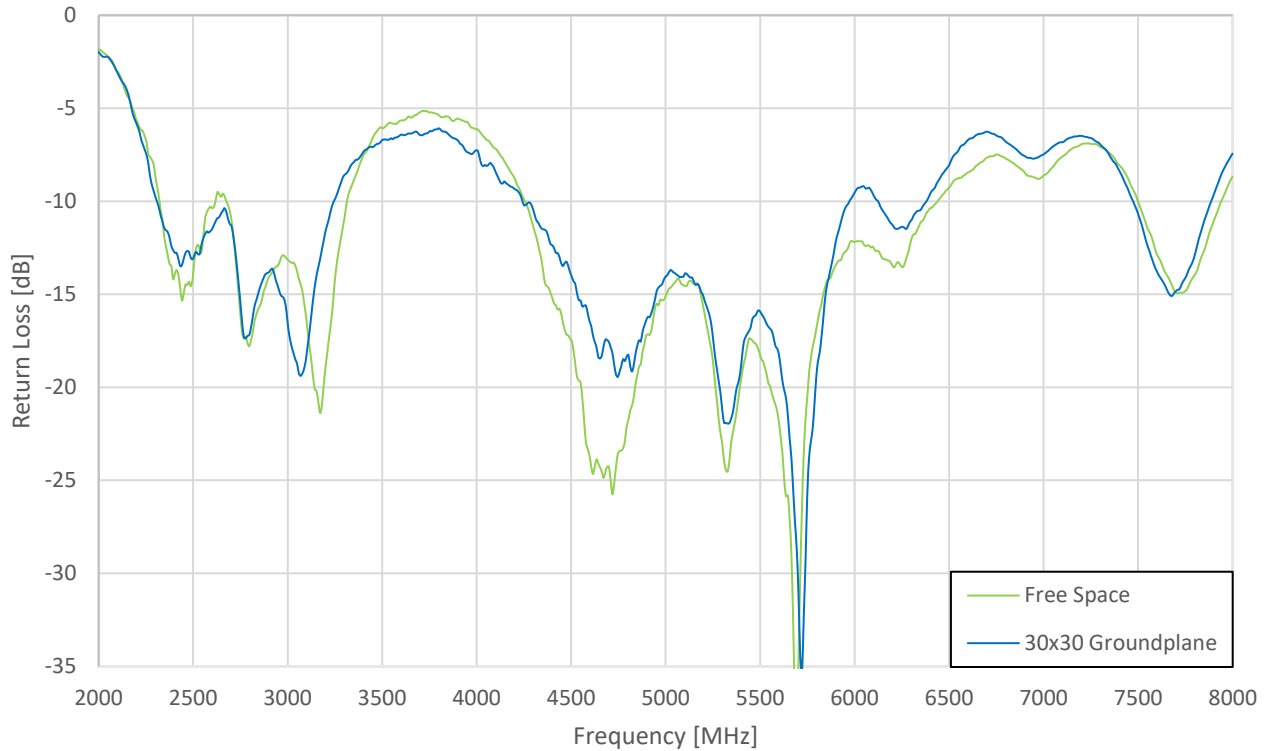

3.2 Efficiency

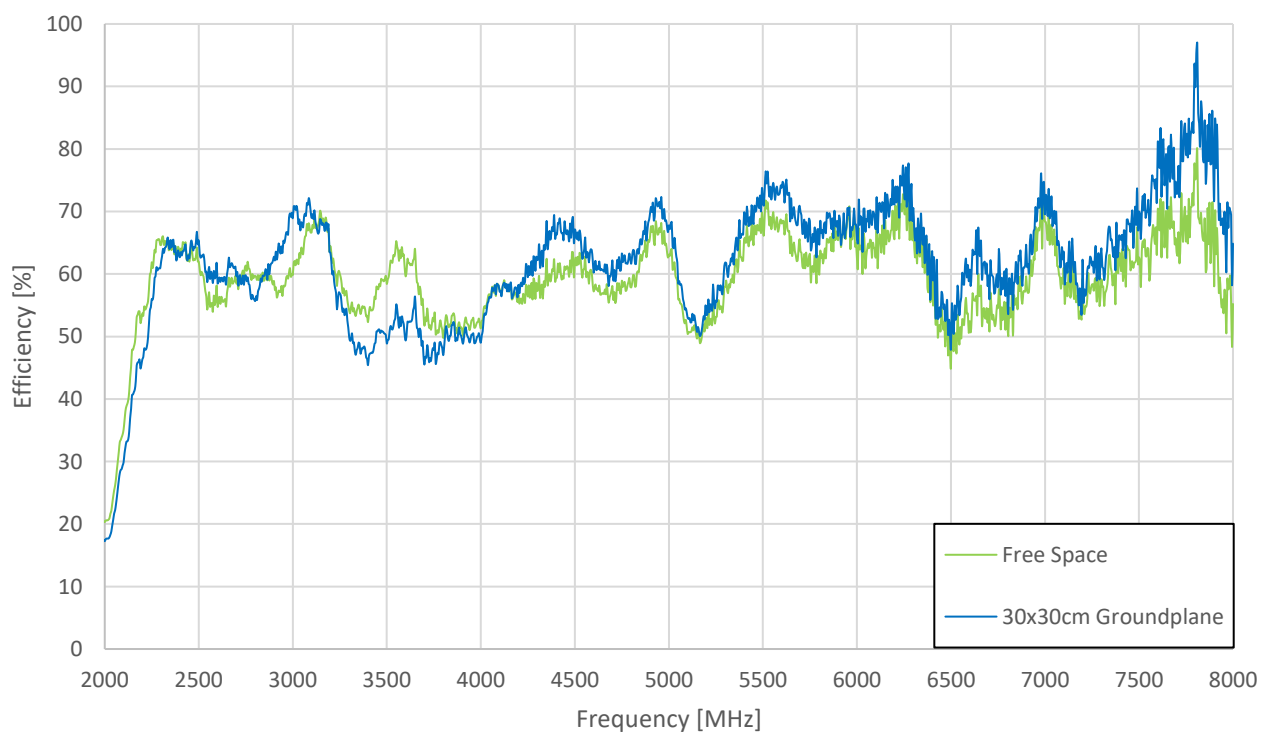

3.3 Average Gain

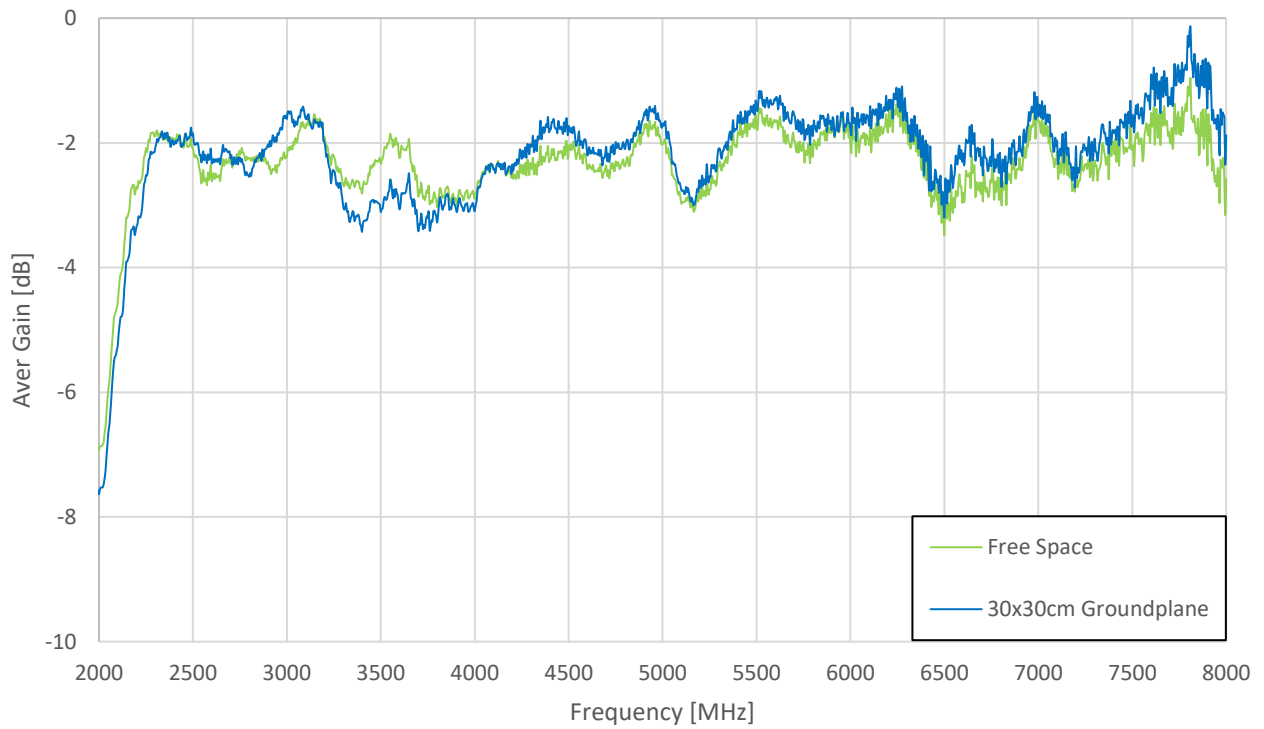

3.4 Peak Gain

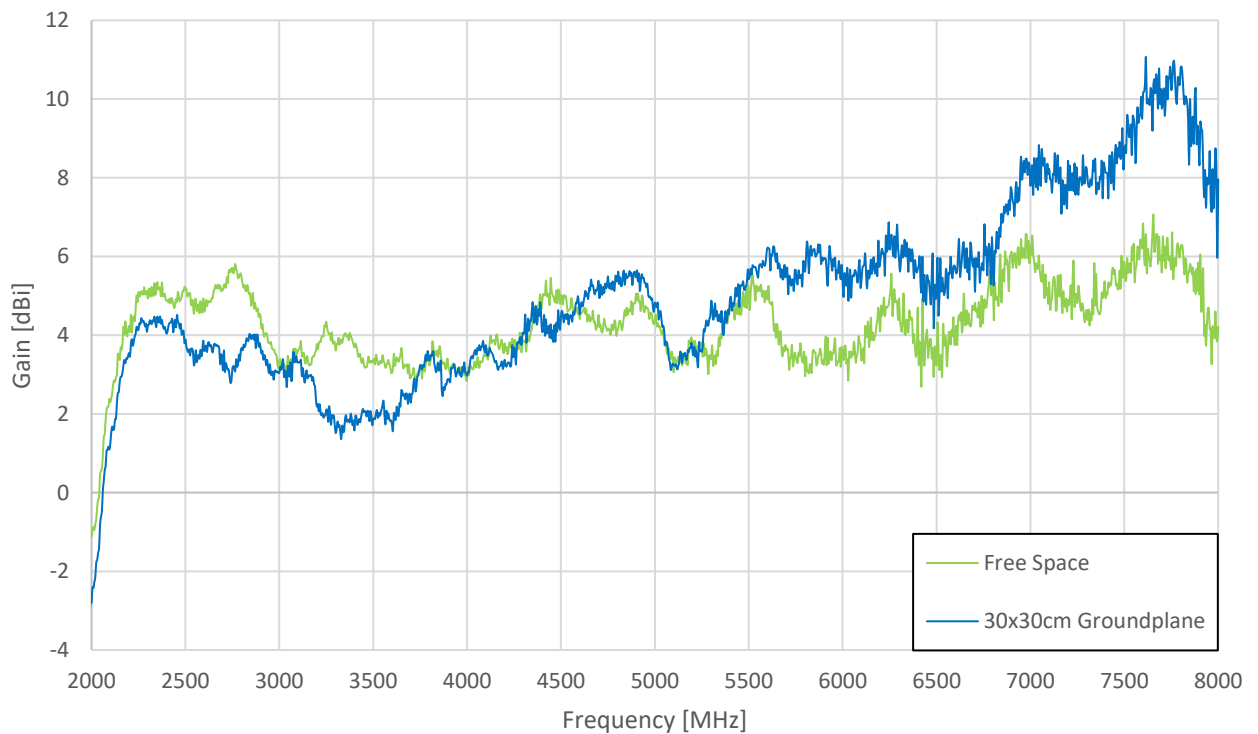

4. Radiation Patterns

4.1 Test Setup

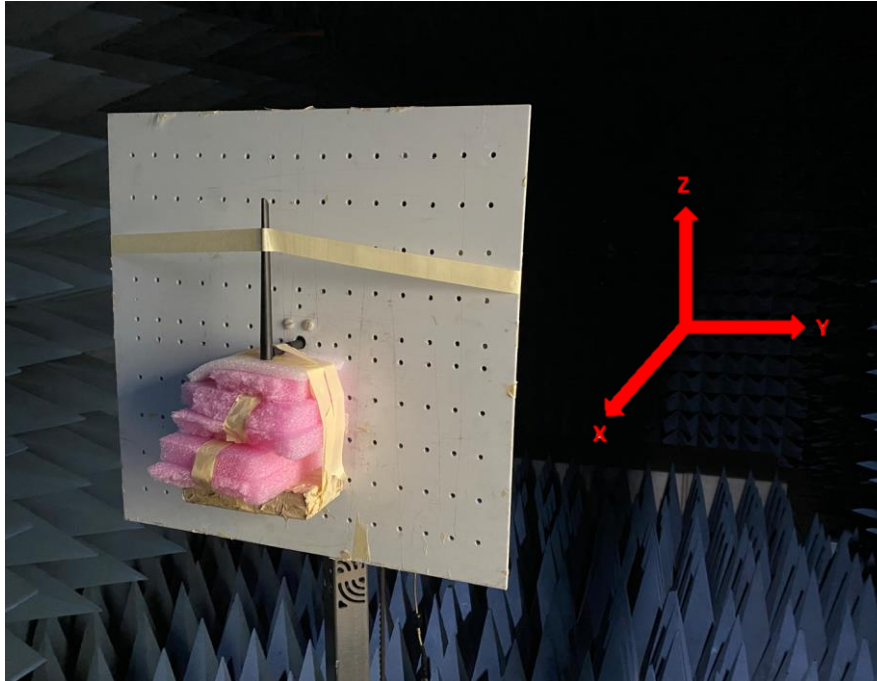

Free space

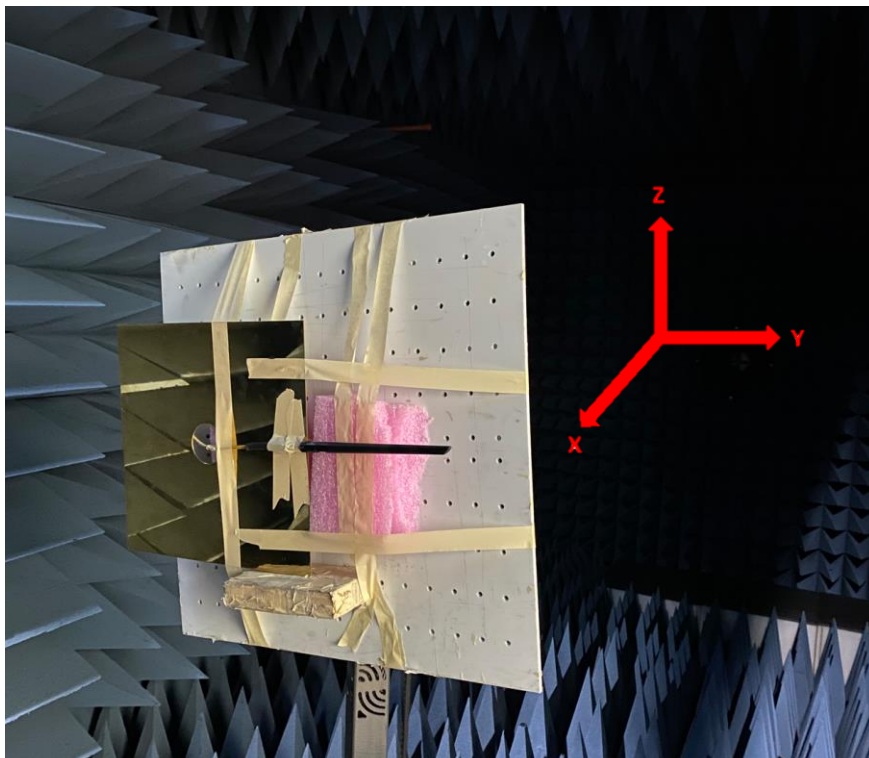

30x30cm Ground plane

4.2 2400MHz 3D and 2D Radiation Patterns - Free space

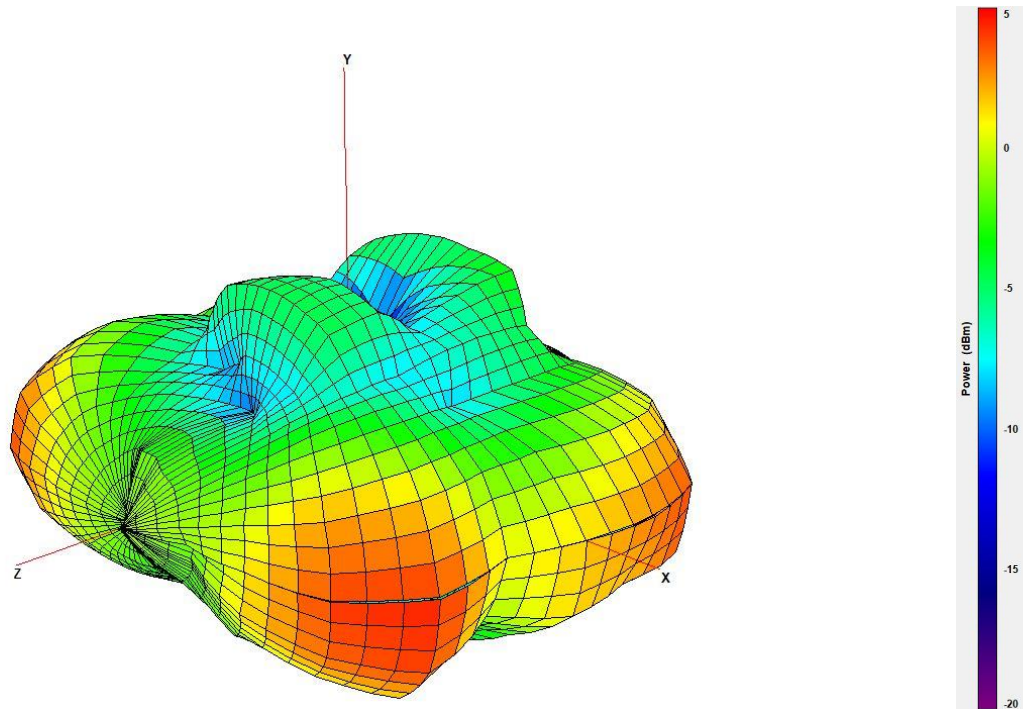

XY Plane XZ Plane YZ Plane

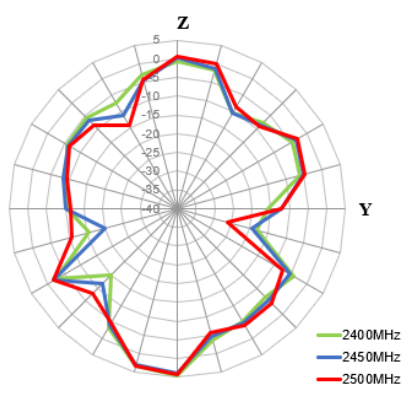
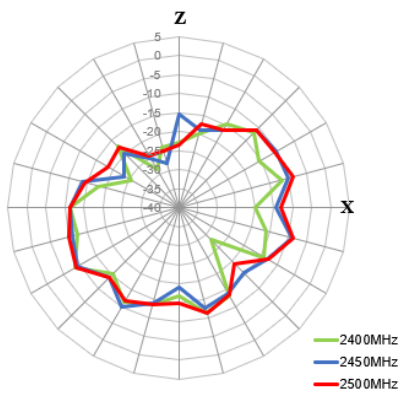
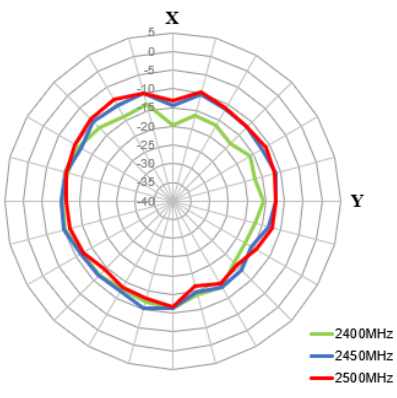

4.3 2400MHz 3D and 2D Radiation Patterns – 30x30cm Ground plane

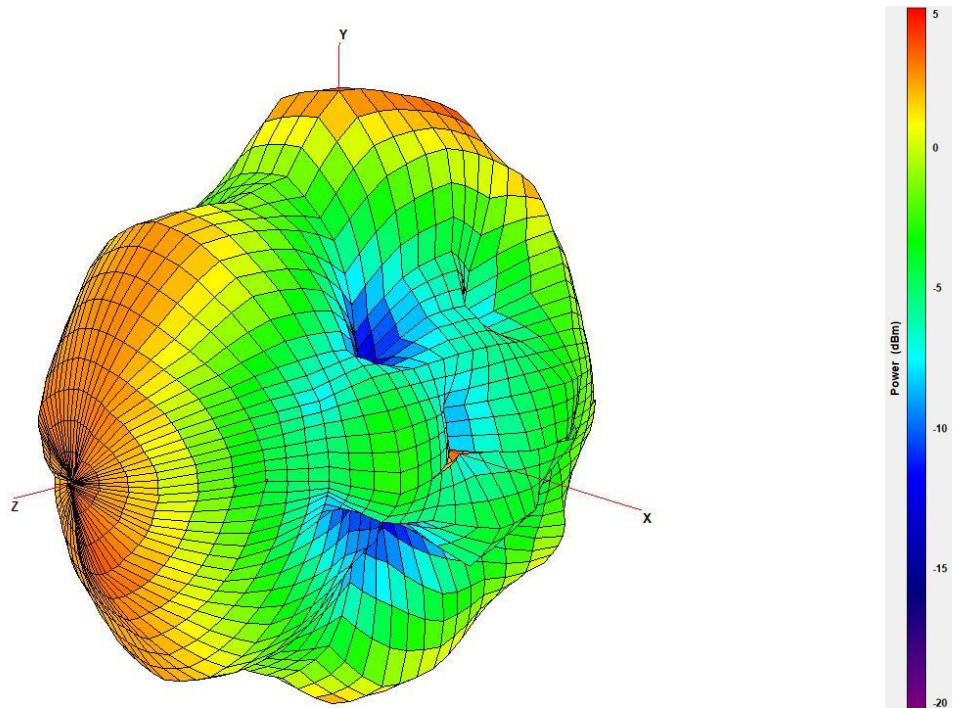

XY Plane

XZ Plane

YZ Plane

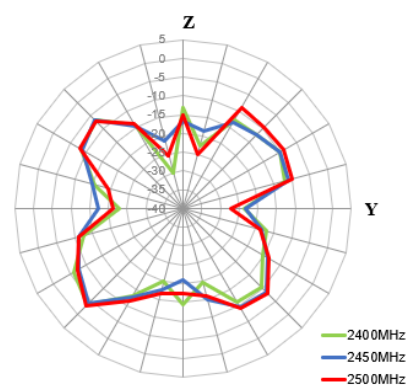
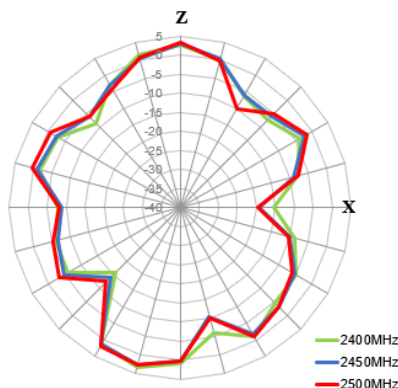
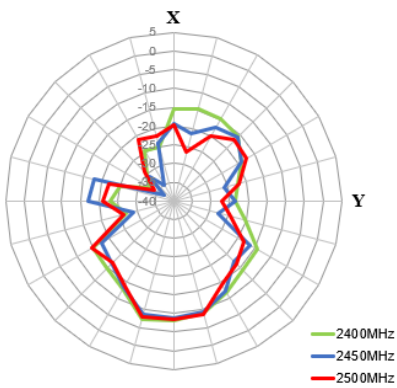

4.4 5800MHz 3D and 2D Radiation Patterns – Free space

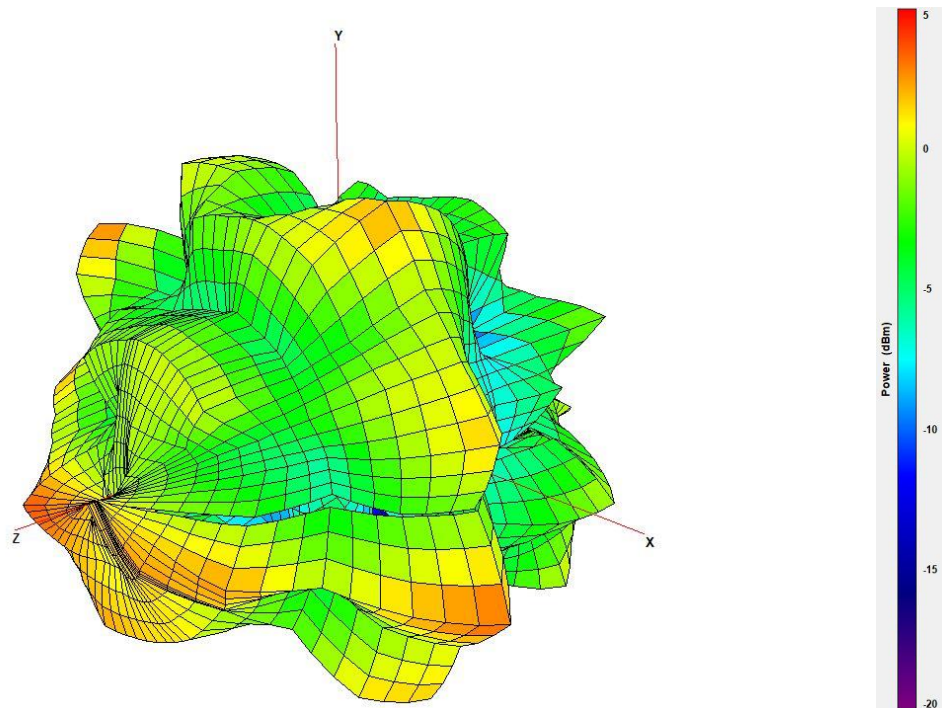

XY Plane

XZ Plane

YZ Plane

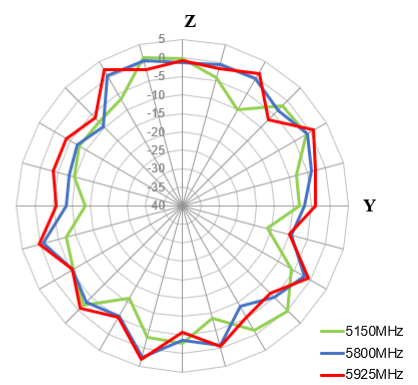
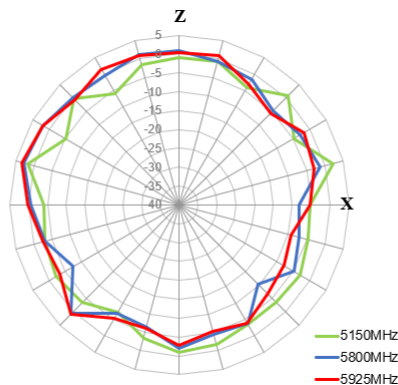
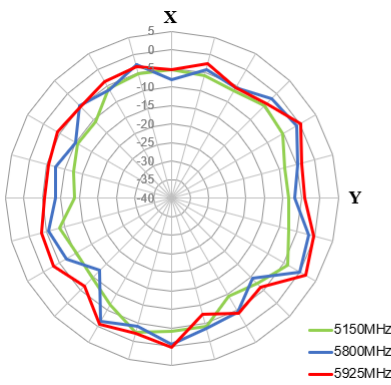

4.5 5800MHz 3D and 2D Radiation Patterns – 30x30cm Ground plane

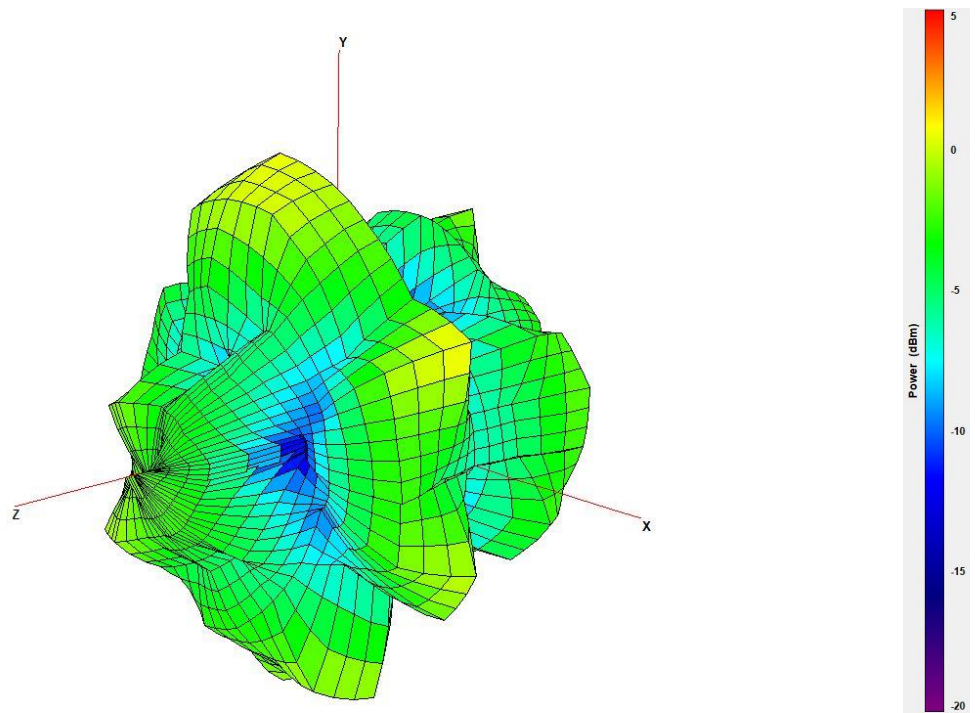

XY Plane XZ Plane YZ Plane

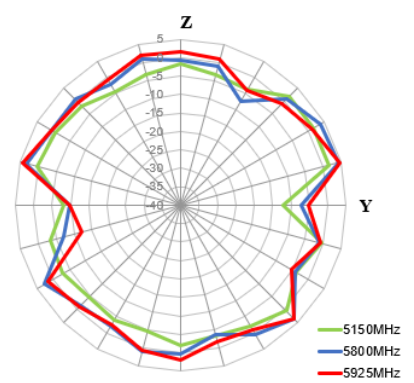
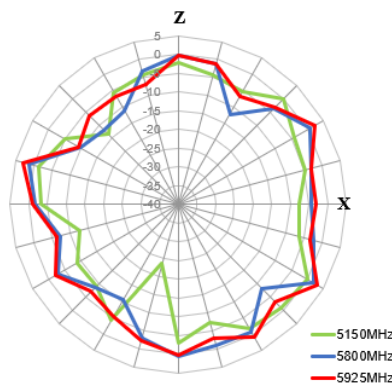
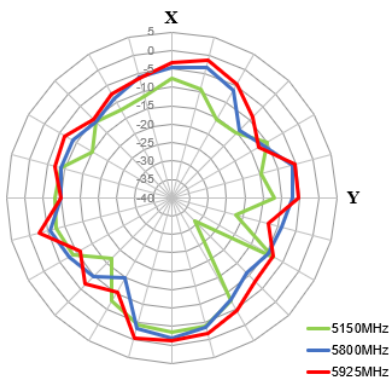

4.6 6500MHz 3D and 2D Radiation Patterns – Free space

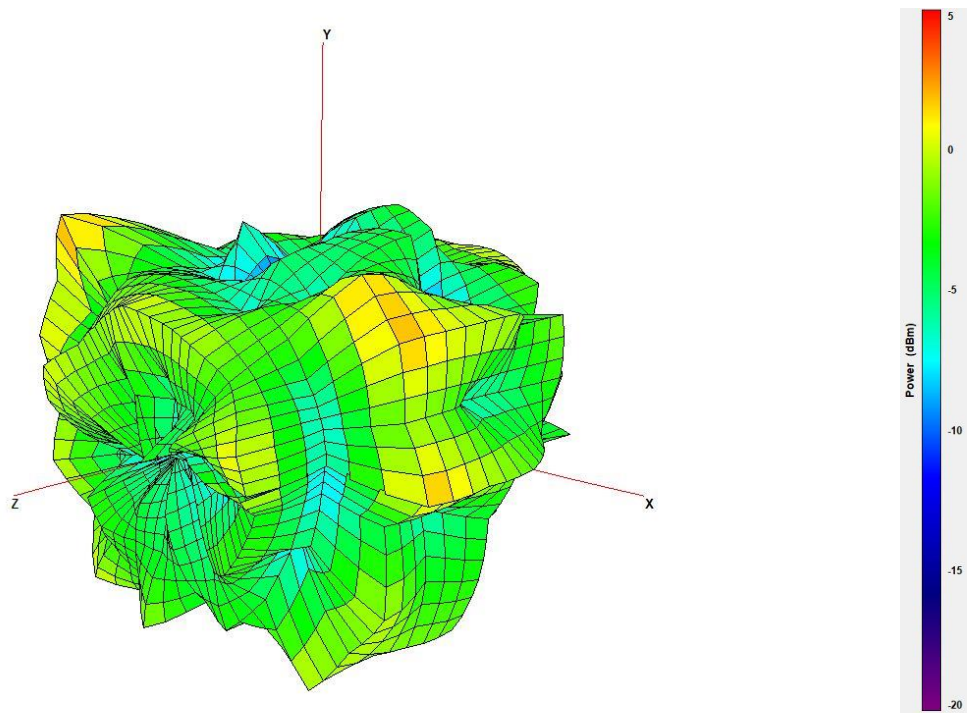

XY Plane XZ Plane YZ Plane

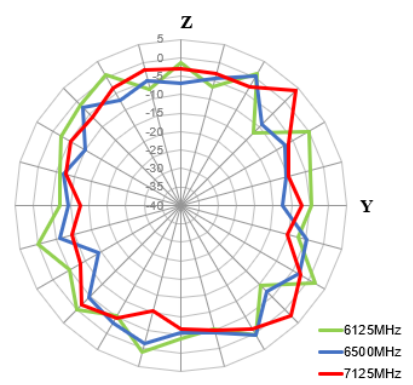
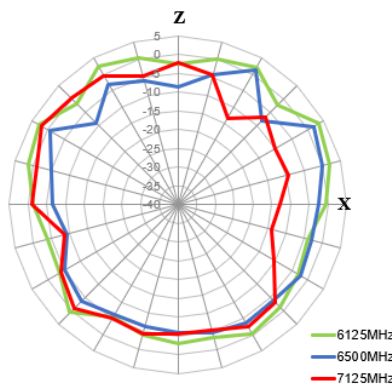
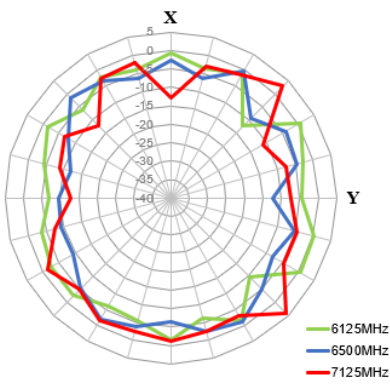

4.7 6500MHz 3D and 2D Radiation Patterns – 30x30cm Ground plane

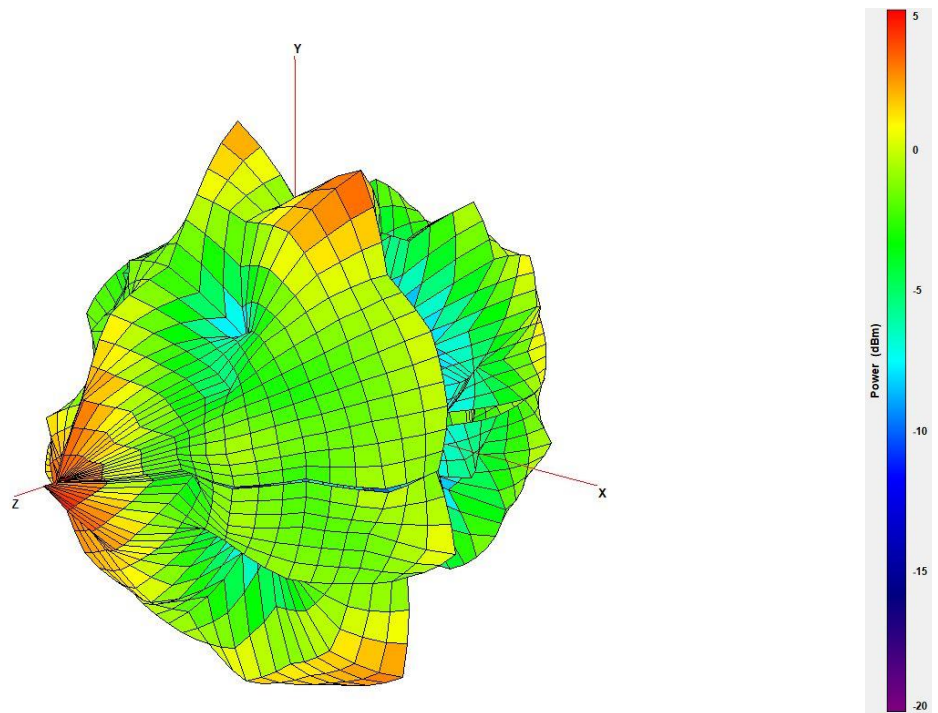

XY Plane XZ Plane YZ Plane

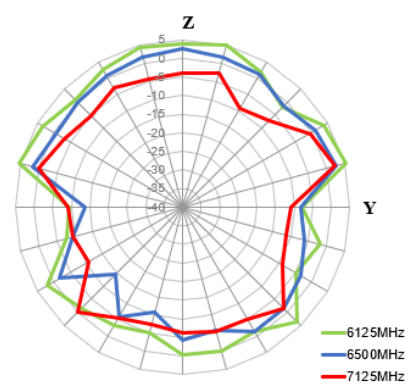
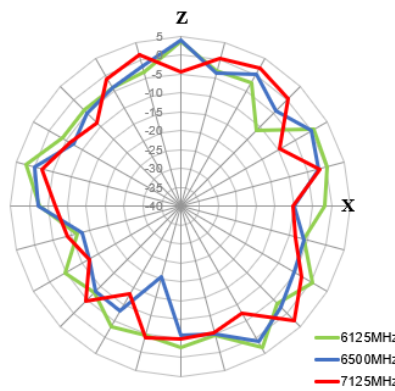
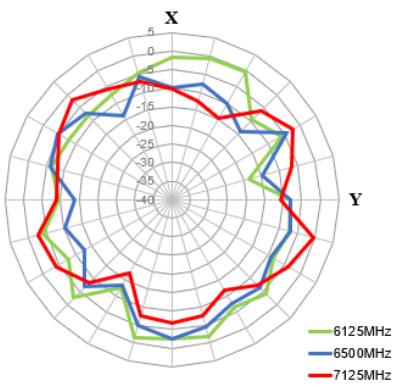

5. Mechanical Drawing (Units: mm)

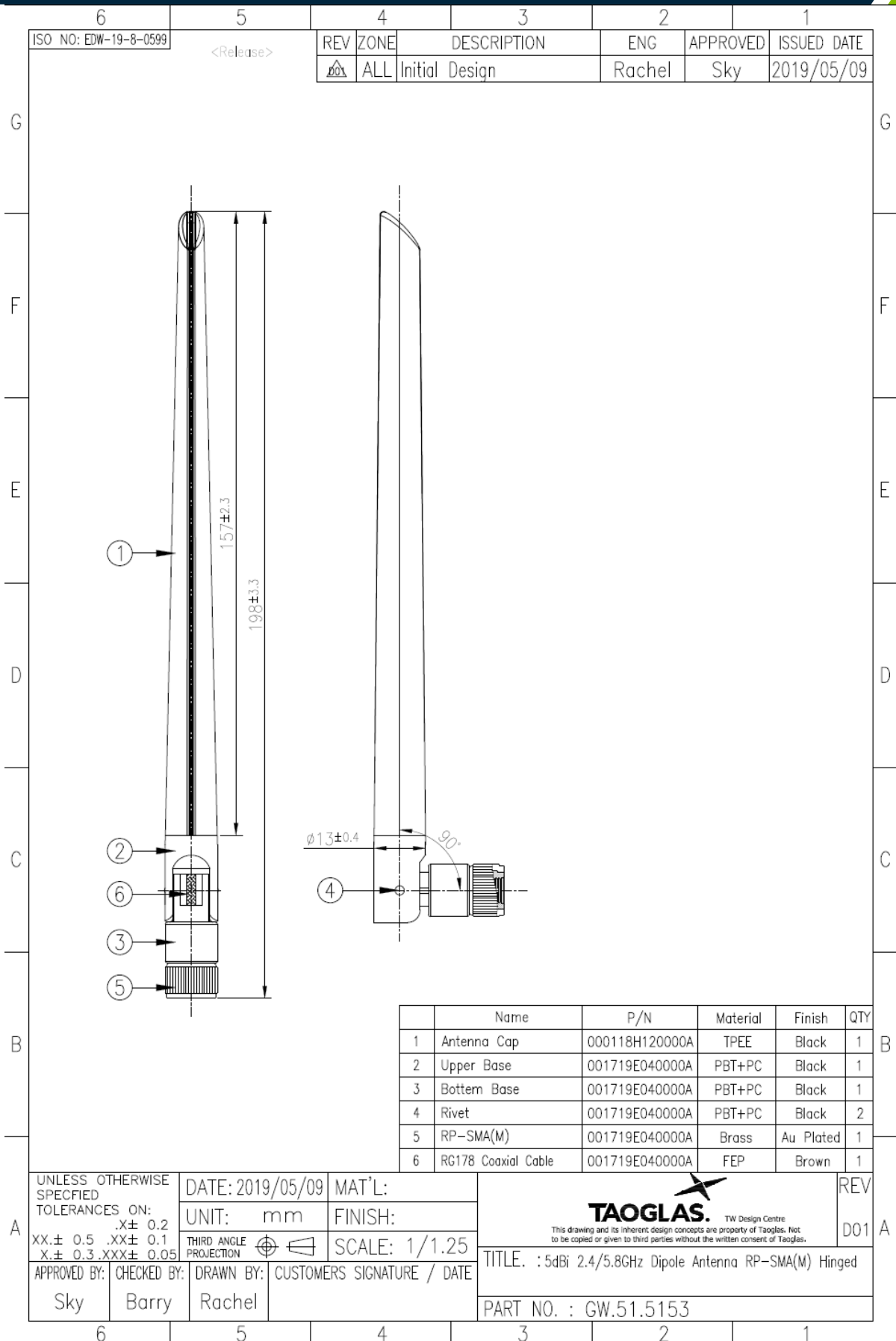

6. Packaging

1pc GW.51.5153 per PE Bag
 Bag Dimension: 245*30mm
 Weight: 22.5g

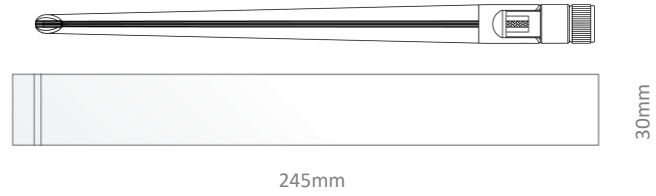

40pcs GW.51.5153 per Large PE Bag
 Bag Dimensions: 320*205mm
 Weight: 0.9Kg

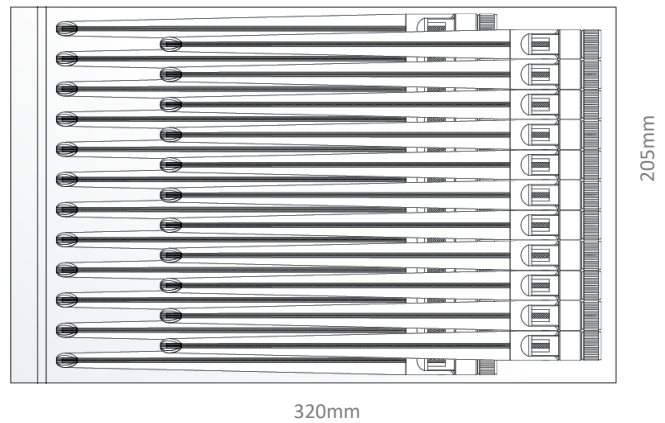

400pcs GW.51.5153 per Carton
 Dimensions: 320*250*230mm
 Weight: 10Kg

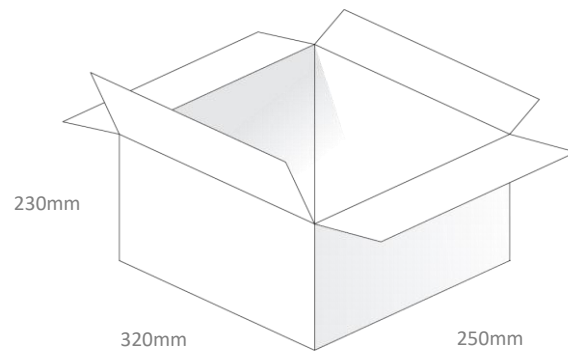

Pallet Dimensions:
 1200*1000*1350mm
 60 Cartons Per Pallet
 12 Cartons Per Layer, 5 Layers

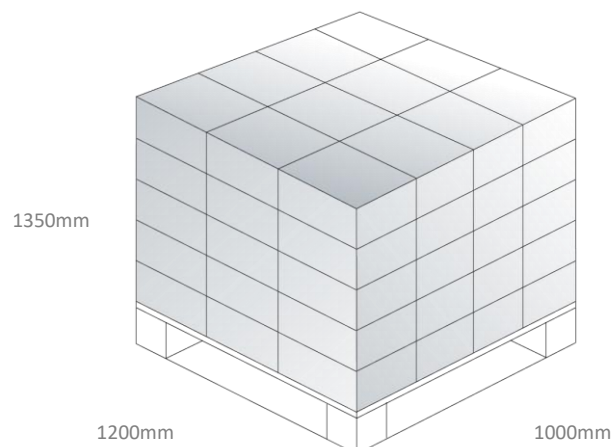

Changelog for the datasheet

SPE-19-8-087 – GW.51.5153

Revision: B (Current Version)

Date:	2022-07-29
Notes:	Updated data to include Wi-Fi 6.
Author:	Gary West

Previous Revisions

Revision: A (Original First Release)

Date:	2019-06-24
Notes:	
Author:	Jack Conroy



TAOGLAS®

www.taoglas.com

