



CIIPC CERTIFICATION TEST REPORT

Report Number. : 11494509-E2V1

Applicant : Panasonic Industrial Devices Europe GmbH
Zeppelinstr. 19
21337 Lüneburg, Germany

Model : PAN1316

FCC ID : T7V1316

IC ID : 216Q-1316

EUT Description : Bluetooth Module

Test Standard(s) : FCC 47 CFR PART 15 SUBPART C
INDUSTRY CANADA RSS - 247 ISSUE 1

Date Of Issue:

December 13, 2016

Prepared by:

UL Verification Services Inc.
47173 Benicia Street
Fremont, CA 94538, U.S.A.
TEL: (510) 771-1000
FAX: (510) 661-0888



NVLAP LAB CODE 200065-0

Revision History

<u>Rev.</u>	<u>Issue Date</u>	<u>Revisions</u>	<u>Revised By</u>
V1	12/8/2016	Initial Issue	D. CORONIA
V2	12/13/2016	Updated Section 6.2 reference report number	D. CORONIA

TABLE OF CONTENTS

1. ATTESTATION OF TEST RESULTS	4
2. TEST METHODOLOGY	5
3. FACILITIES AND ACCREDITATION	5
4. SUMMARY TABLE	5
5. CALIBRATION AND UNCERTAINTY	6
5.1. <i>MEASURING INSTRUMENT CALIBRATION</i>	6
5.2. <i>SAMPLE CALCULATION</i>	6
5.3. <i>MEASUREMENT UNCERTAINTY</i>	6
6. EQUIPMENT UNDER TEST	7
6.1. <i>DESCRIPTION OF EUT</i>	7
6.1. <i>DESCRIPTION OF CLASS II PERMISSIVE CHANGE</i>	7
6.2. <i>MAXIMUM OUTPUT POWER</i>	7
6.3. <i>DESCRIPTION OF AVAILABLE ANTENNAS</i>	7
6.4. <i>SOFTWARE AND FIRMWARE</i>	7
6.5. <i>WORST-CASE CONFIGURATION AND MODE</i>	7
6.6. <i>DESCRIPTION OF TEST SETUP</i>	8
7. TEST AND MEASUREMENT EQUIPMENT	10
8. MEASUREMENT METHODS	11
9. ANTENNA PORT TEST RESULTS	12
9.1. <i>ON TIME, DUTY CYCLE</i>	12
10. RADIATED TEST RESULTS	13
10.1. <i>LIMITS AND PROCEDURE</i>	13
10.2.1. <i>RESTRICTED BANDEDGE (LOW CHANNEL)</i>	14
10.2.2. <i>AUTHORIZED BANDEDGE (HIGH CHANNEL)</i>	16
10.2.3. <i>HARMONICS AND SPURIOUS EMISSIONS</i>	18
10.3. <i>WORST-CASE ABOVE 18 GHz</i>	24
10.4. <i>WORST-CASE BELOW 1 GHz</i>	26
10.5. <i>WORST-CASE BELOW 30 MHz</i>	28
11. AC POWER LINE CONDUCTED EMISSIONS	29
12. SETUP PHOTOS	32

1. ATTESTATION OF TEST RESULTS

COMPANY NAME: PANASONIC INDUSTRIAL DEVICES EUROPE G
EUT DESCRIPTION: BLUETOOTH MODULE
MODEL: PAN1316
SERIAL NUMBER: ENW89823C3KF
DATE TESTED: OCTOBER 27 – NOVEMBER 9, 2016

APPLICABLE STANDARDS	
STANDARD	TEST RESULTS
CFR 47 Part 15 Subpart C	Pass
INDUSTRY CANADA RSS-247 Issue 1	Pass
INDUSTRY CANADA RSS-GEN Issue 4	Pass

UL Verification Services Inc. tested the above equipment in accordance with the requirements set forth in the above standards. All indications of Pass/Fail in this report are opinions expressed by UL Verification Services Inc. based on interpretations and/or observations of test results. Measurement Uncertainties were not taken into account and are published for informational purposes only. The test results show that the equipment tested is capable of demonstrating compliance with the requirements as documented in this report.

Note: The results documented in this report apply only to the tested sample, under the conditions and modes of operation as described herein. This document may not be altered or revised in any way unless done so by UL Verification Services Inc. and all revisions are duly noted in the revisions section. Any alteration of this document not carried out by UL Verification Services Inc. will constitute fraud and shall nullify the document. This report must not be used by the client to claim product certification, approval, or endorsement by NVLAP, NIST, any agency of the Federal Government, or any agency of any government.

Approved & Released For
UL Verification Services Inc. By:

Prepared By:



DAN CORONIA
WiSE Project Lead
UL VERIFICATION SERVICES INC.

ANGEL ESCAMILLA
WiSE Lab Engineer
UL VERIFICATION SERVICES INC.

2. TEST METHODOLOGY

The tests documented in this report were performed in accordance with FCC CFR 47 Part 2, FCC CFR 47 Part 15, KDB 558074 D01 v03r05, ANSI C63.10-2013, RSS-GEN Issue 4, and RSS-247 Issue 1.

3. FACILITIES AND ACCREDITATION

The test sites and measurement facilities used to collect data are located at 47173 and 47266 Benicia Street, Fremont, California, USA. Line conducted emissions are measured only at the 47173 address. The following table identifies which facilities were utilized for radiated emission measurements documented in this report. Specific facilities are also identified in the test results sections.

47173 Benicia Street		47266 Benicia Street	
<input checked="" type="checkbox"/>	Chamber A (IC:2324B-1)	<input type="checkbox"/>	Chamber D (IC:2324B-4)
<input type="checkbox"/>	Chamber B (IC:2324B-2)	<input type="checkbox"/>	Chamber E (IC:2324B-5)
<input checked="" type="checkbox"/>	Chamber C (IC:2324B-3)	<input type="checkbox"/>	Chamber F (IC:2324B-6)
		<input type="checkbox"/>	Chamber G (IC:2324B-7)
		<input type="checkbox"/>	Chamber H (IC:2324B-8)

The above test sites and facilities are covered under FCC Test Firm Registration # 208313.

UL Verification Services Inc. is accredited by NVLAP, Laboratory Code 200065-0. The full scope of accreditation can be viewed at <http://ts.nist.gov/standards/scopes/2000650.htm>.

4. SUMMARY TABLE

FCC Part Section	RSS Section(s)	Test Description	Test Limit	Test Condition	Test Result
15.247 (a)(2)	RSS-247 5.2 (1)	Occupied Band width (6dB)	>500KHz	Conducted	Refer to original report
2.1051, 15.247 (d)	RSS-247 5.5	Band Edge / Conducted Spurious Emission	-20dBc		Refer to original report
15.247	RSS-247 5.4 (4)	TX conducted output power	<30dBm		Refer to original report
15.247	RSS-247 5.2 (2)	PSD	<8dBm		Refer to original report
15.207 (a)	RSS-GEN 8.8	AC Power Line conducted emissions	Section 10	Radiated	Pass
15.205, 15.209, 15.247	RSS-GEN 8.9	Radiated Spurious Emission	< 54dBuV/m		Pass

Note: Original test report number: GOM-1303-2693-TFC247W-V01

5. CALIBRATION AND UNCERTAINTY

5.1. MEASURING INSTRUMENT CALIBRATION

The measuring equipment utilized to perform the tests documented in this report has been calibrated in accordance with the manufacturer's recommendations, and is traceable to recognized national standards.

5.2. SAMPLE CALCULATION

Where relevant, the following sample calculation is provided:

$$\begin{aligned} \text{Field Strength (dBuV/m)} &= \text{Measured Voltage (dBuV)} + \text{Antenna Factor (dB/m)} + \\ &\text{Cable Loss (dB)} - \text{Preamp Gain (dB)} \\ 36.5 \text{ dBuV} + 18.7 \text{ dB/m} + 0.6 \text{ dB} - 26.9 \text{ dB} &= 28.9 \text{ dBuV/m} \end{aligned}$$

5.3. MEASUREMENT UNCERTAINTY

Where relevant, the following measurement uncertainty levels have been estimated for tests performed on the apparatus:

Parameter	Uncertainty
Worst Case Conducted Disturbance, 9KHz to 0.15 MHz	3.84 dB
Worst Case Conducted Disturbance, 0.15 to 30 MHz	3.65 dB
Worst Case Radiated Disturbance, 9KHz to 30 MHz	3.15 dB
Worst Case Radiated Disturbance, 30 to 1000 MHz	5.36 dB
Worst Case Radiated Disturbance, 1000 to 18000 MHz	4.32 dB
Worst Case Radiated Disturbance, 18000 to 26000 MHz	4.45 dB
Worst Case Radiated Disturbance, 26000 to 40000 MHz	5.24 dB

Uncertainty figures are valid to a confidence level of 95%.

6. EQUIPMENT UNDER TEST

6.1. DESCRIPTION OF EUT

The EUT is a Bluetooth Low Energy module that is manufactured by Panasonic Industrial Devices Europe GmbH.

6.1. DESCRIPTION OF CLASS II PERMISSIVE CHANGE

The purpose of this CIIPC is due to a new antenna type and higher gain.

6.2. MAXIMUM OUTPUT POWER

For conducted output power, refer to the original test report number: G0M-1303-2693-TFC247W-V01.

The output power was verified and measured at same or lower power setting compared to the original certification testing level.

6.3. DESCRIPTION OF AVAILABLE ANTENNAS

The radio utilizes a chip RF antenna with a maximum gain as below:

Frequency Band (GHz)	Antenna Gain (dBi)
2.4	2.72

6.4. SOFTWARE AND FIRMWARE

The software used to exercise the EUT during testing was Putty version 0.66.

6.5. WORST-CASE CONFIGURATION AND MODE

Above 1GHz Low/Middle/High channel were tested for radiated emissions. Below 1GHz, above 18GHz and conducted power line emissions, the channel with the highest output power was tested.

The fundamental of the EUT was investigated in three orthogonal orientations X/Y/Z, it was determined that Z orientation was worst-case orientation. Therefore, all final radiated testing was performed with the EUT in Z orientation.

Worst-case data rates were:

BLE: 1 Mbps.

6.6. DESCRIPTION OF TEST SETUP

SUPPORT EQUIPMENT

Support Equipment List				
Description	Manufacturer	Model	Serial Number	FCC ID
28VDC Power Supply	Sorensen	XEL 30-3	N/A	N/A
Support Laptop	Lenovo	T430	PB-05HPL	N/A
AC/DC Adapter	Lenovo	42T4430	N/A	N/A

I/O CABLES

I/O Cable List						
Cable No	Port	# of identical ports	Connector Type	Cable Type	Cable Length (m)	Remarks
1	AC	1	US115VAC	Unshielded	1.5	Power for Laptop
2	DC	1	DC PLUG	Unshielded	1.5	Power for Laptop
3	AC	1	AC PLUG	Unshielded	1.5	Power for DC Supply
4	USB	1	RS232	Unshielded	1	Data from Laptop
5	DC	1	4mm	Unshielded	0.5	Power for UUT

TEST SETUP

The EUT was powered by 28VDC Power Supply and connected to host laptop via USB/RS232 connector. Test software exercised the radio card.

SETUP DIAGRAM

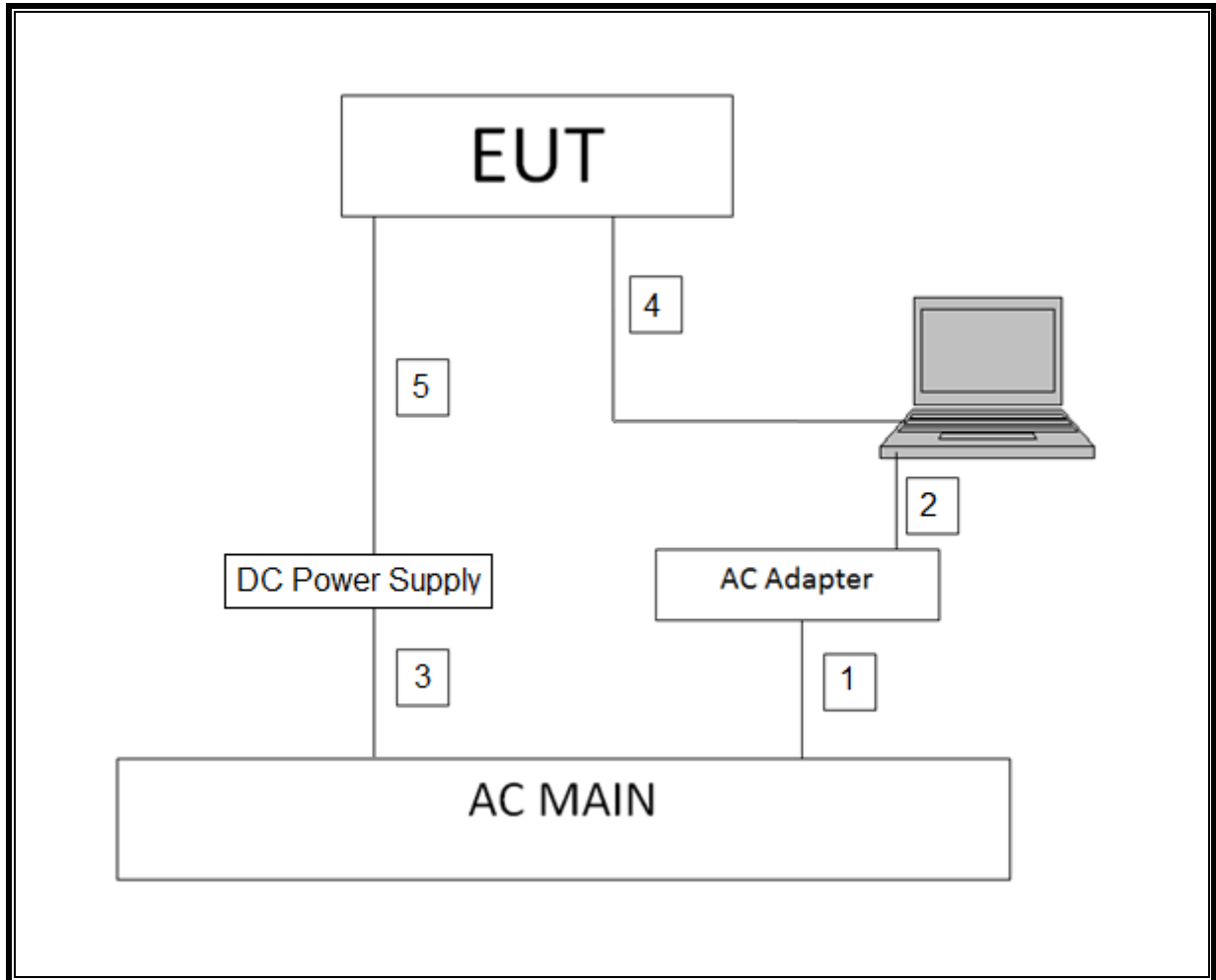

7. TEST AND MEASUREMENT EQUIPMENT

The following test and measurement equipment was utilized for the tests documented in this report:

Test Equipment List				
Description	Manufacturer	Model	T Number	Cal Due
Amplifier, 1-18GHz	Miteq	AFS42-00101800-25-S-42	493	03/09/17
Amplifier, 1-8GHz, 35 dB	Miteq	AMF-4D-01000800-30-29P	1156	03/09/17
Antenna, Biconolog, 30MHz-1 GHz	Sunol Sciences	JB1	130	09/23/17
Antenna, Horn, 18GHz	ETS Lindgren	3117	345	02/22/17
Antenna, Horn, 26.5 GHz	Seavey Division	MWH-1826/B	T449	05/26/17
ESR7 EMI Test Receiver 7GHz	Rohde & Schwarz	ESCI7	100935	09/10/17
High Pass Filter 3GHz	Micro-Tronics	HPS17543	485	03/09/17
High Pass Filter 3GHz	Micro-Tronics	HPS17543	486	08/01/17
High Pass Filter 6GHz	Micro-Tronics	HPS17542	483	03/09/17
High Pass Filter 6GHz	Micro-Tronics	HPS17542	484	08/01/17
LISN, 30 MHz	FCC	FCC-LISN-50/250-25-2	24	02/09/17
Low Pass Filter 5GHz	Micro-Tronics	LPS17541	482	03/09/17
Low Pass Filter 5GHz	Micro-Tronics	LPS17541	481	08/01/17
Power Meter	Keysight	N1911A	1262	07/08/17
RF Preamplifier, 26GHz - 40GHz	Miteq	NSP4000-SP2	88	04/07/17
Spectrum Analyzer, 44 GHz	Keysight	N9030A	907	01/06/17

Test Software List			
Description	Manufacturer	Model	Version
Radiated Software	UL	UL EMC	Ver 9.5, Apr 12, 2016
Conducted Software	UL	UL EMC	Ver 9.5, May 26, 2015
Conducted Port Software	UL	UL RF	Ver 4.7, Apr 28, 2016

8. MEASUREMENT METHODS

On Time and Duty Cycle: KDB 558074, Section 6.0

Out-of-band emissions in non-restricted bands: KDB 558074 D01 v03r05, Section 11.0.

Out-of-band emissions in restricted bands: KDB 558074 D01 v03r05, Section 12.1.

Band-edge: KDB 558074 D01 v03r05, Section 13.1.

AC Power Line Conducted Emissions: ANSI C63.10-2013, Section 6.2

9. ANTENNA PORT TEST RESULTS

9.1. ON TIME, DUTY CYCLE

ON TIME, DUTY CYCLE

LIMITS

None; for reporting purposes only.

PROCEDURE

KDB 558074 Zero-Span Spectrum Analyzer Method.

ON TIME AND DUTY CYCLE RESULTS

Mode	ON Time B (msec)	Period (msec)	Duty Cycle x (linear)	Duty Cycle (%)	Duty Cycle Correction Factor (dB)	1/B Minimum VBW (kHz)
BLE	4.133	4.133	1.000	100.00%	0.00	0.010

DUTY CYCLE PLOTS

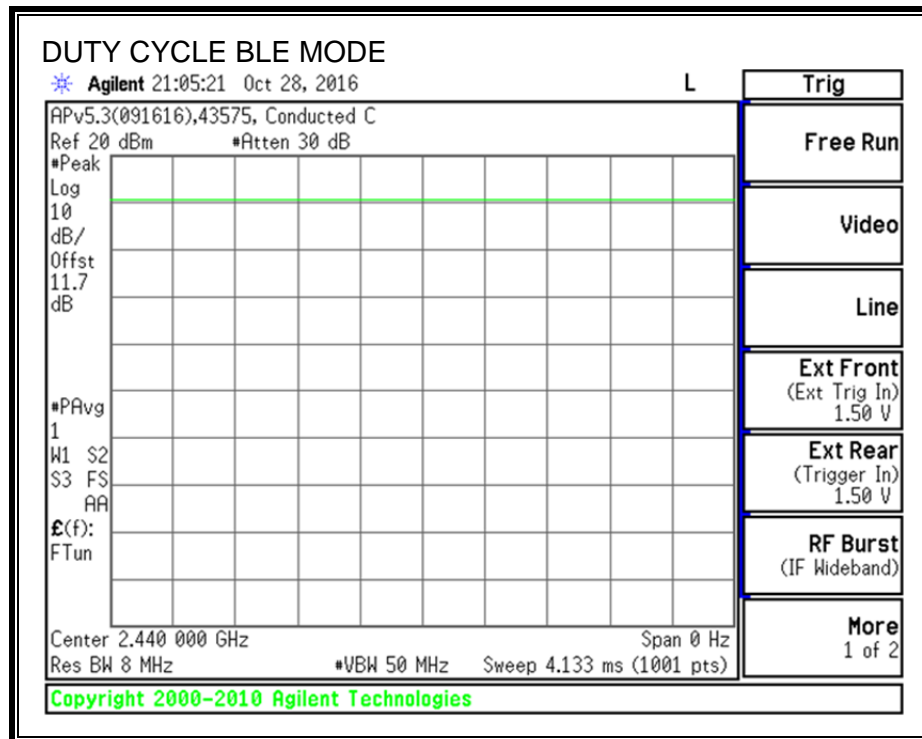

10. RADIATED TEST RESULTS

10.1. LIMITS AND PROCEDURE

LIMITS

FCC §15.205 and §15.209

IC RSS-GEN, Section 8.9 and 8.10.

Frequency Range (MHz)	Field Strength Limit (uV/m) at 3 m	Field Strength Limit (dBuV/m) at 3 m
0.009-0.490	2400/F(kHz) @ 300m	2400/F(kHz) @ 300m
0.490-1.705	24000/F(kHz) @ 30m	24000/F(kHz) @ 30m
1.705-30.0	30 @ 30m	30 @ 30m
30 - 88	100	40
88 - 216	150	43.5
216 - 960	200	46
Above 960	500	54

NOTE: KDB 937606 OATS and Chamber Correlation Justification

- Based on FCC 15.31 (f) (2): measurements may be performed at a distance closer than that specified in the regulations; however, an attempt should be made to avoid making measurements in the near field.
- OATs and chamber correlation testing had been performed and chamber measured test result is the worst case test result.

TEST PROCEDURE

The EUT is placed on a non-conducting table 80 cm above the ground plane for measurement below 1GHz; 1.5 m above the ground plane for measurement above 1GHz. The antenna to EUT distance is 3 meters. The EUT is configured in accordance with ANSI C63.10. The EUT is set to transmit in a continuous mode.

For measurements below 1 GHz the resolution bandwidth is set to 100 kHz for peak detection measurements or 120 kHz for quasi-peak detection measurements. Peak detection is used unless otherwise noted as quasi-peak.

For measurements above 1 GHz the resolution bandwidth is set to 1 MHz, then the video bandwidth is set to 3 MHz for peak measurements and 1 MHz resolution bandwidth with 3MHz video bandwidth with average detector for average measurements.

Note: The pre-scan measurements above 1GHz the VBW is set to 30 kHz.

For 2.4 GHz band, the spectrum from 9 kHz to 26 GHz is investigated with the transmitter set to the lowest, middle, and highest channels for above 1GHz. Below 1GHz, and above 18GHz emissions, the channel with the highest output power was tested.

The frequency range of interest is monitored at a fixed antenna height and EUT azimuth. The EUT is rotated through 360 degrees to maximize emissions received. The antenna is scanned from 1 to 4 meters above the ground plane to further maximize the emission. Measurements are made with the antenna polarized in both the vertical and the horizontal positions.

10.2.1. RESTRICTED BANDEDGE (LOW CHANNEL)

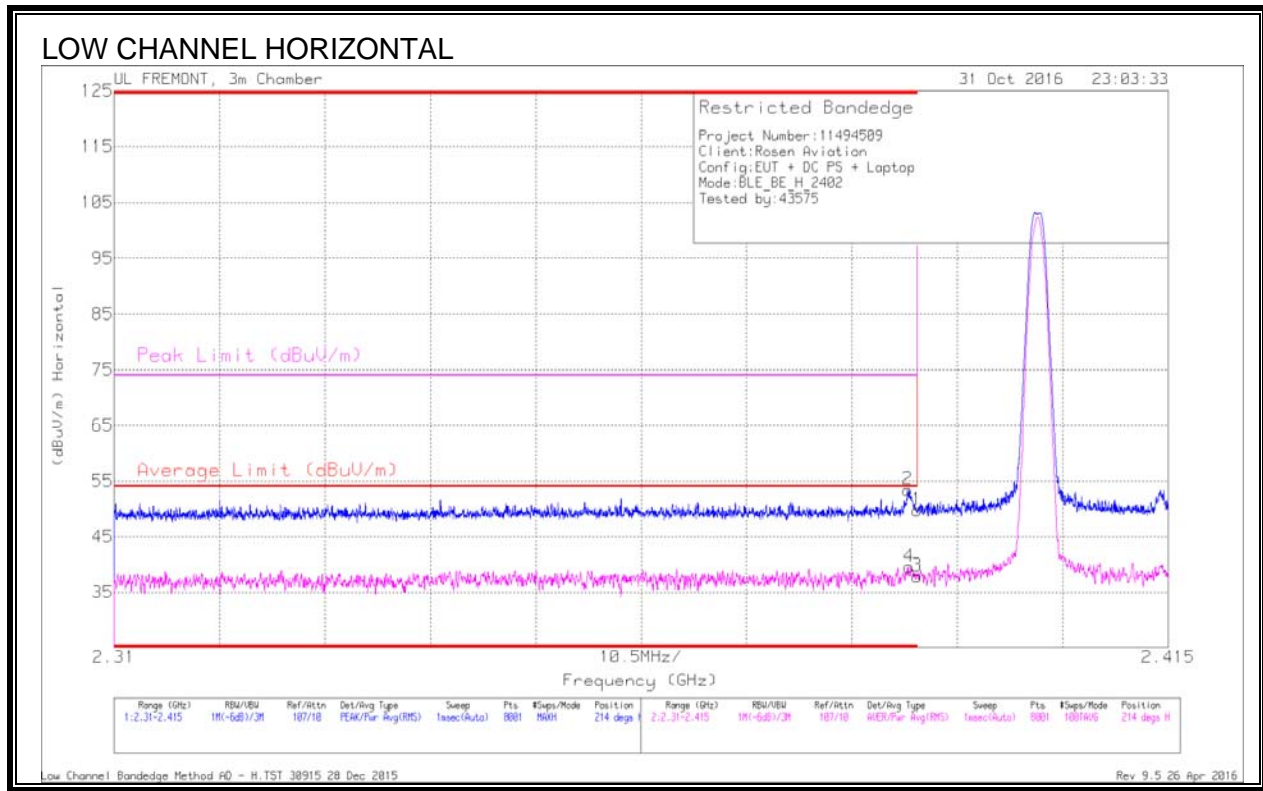

Trace Markers

Marker	Frequency (GHz)	Meter Reading (dBuV)	Det	AF T119 (dB/m)	Amp/Cbl/Filtr/Pad (dB)	Corrected Reading (dBuV/m)	Average Limit (dBuV/m)	Margin (dB)	Peak Limit (dBuV/m)	PK Margin (dB)	Azimuth (Degs)	Height (cm)	Polarity
1	* 2.39	38.44	Pk	32.1	-20.8	49.74	-	-	74	-24.26	214	341	H
2	* 2.389	42.14	Pk	32.1	-20.8	53.44	-	-	74	-20.56	214	341	H
3	* 2.39	26.6	RMS	32.1	-20.8	37.9	54	-16.1	-	-	214	341	H
4	* 2.389	28.28	RMS	32.1	-20.8	39.58	54	-14.42	-	-	214	341	H

* - indicates frequency in CFR47 Pt 15 / IC RSS-Restricted Band

Pk - Peak detector

RMS - RMS detection

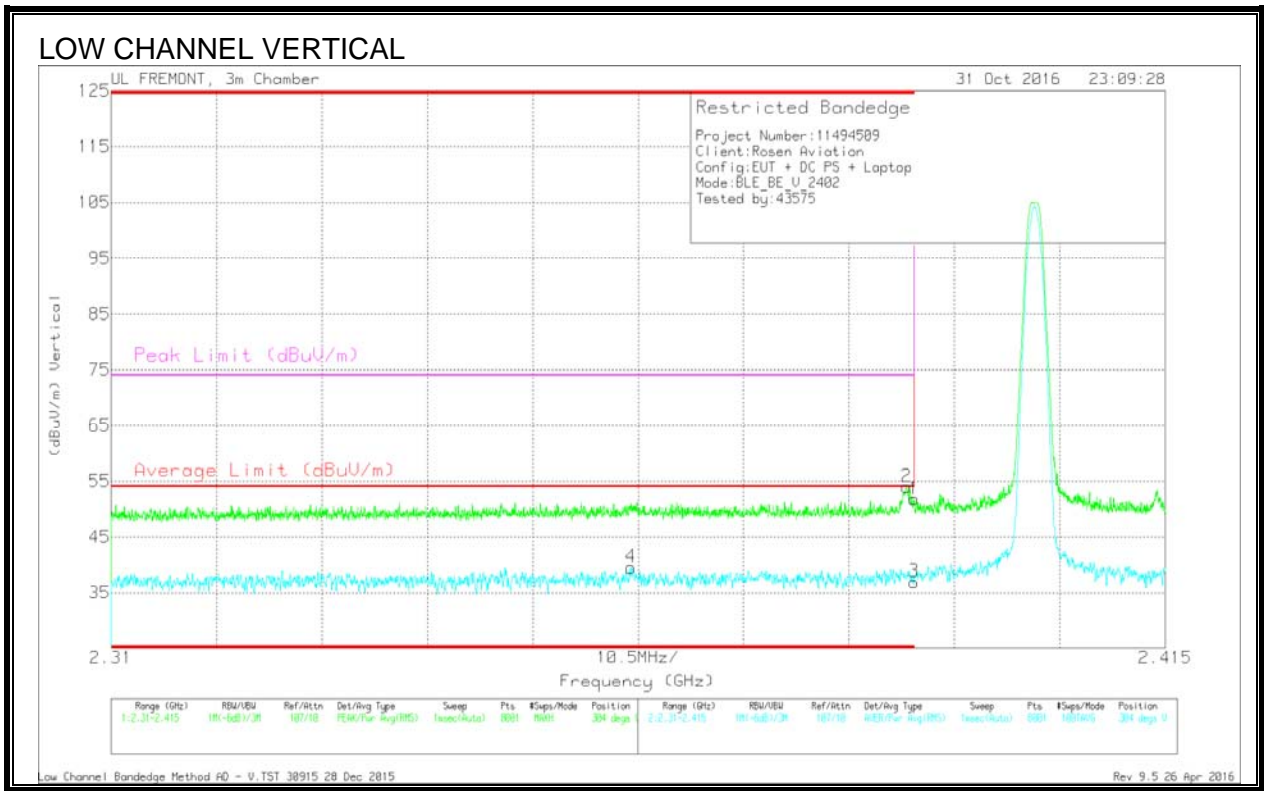

Trace Markers

Marker	Frequency (GHz)	Meter Reading (dBuV)	Det	AF T119 (dB/m)	Amp/Cbl/Filtr/Pad (dB)	Corrected Reading (dBuV/m)	Average Limit (dBuV/m)	Margin (dB)	Peak Limit (dBuV/m)	PK Margin (dB)	Azimuth (Degs)	Height (cm)	Polarity
4	* 2.362	28.42	RMS	31.9	-20.8	39.52	54	-14.48	-	-	304	345	V
2	* 2.389	42.66	PK	32.1	-20.8	53.96	-	-	74	-20.04	304	345	V
1	* 2.39	40.46	PK	32.1	-20.8	51.76	-	-	74	-22.24	304	345	V
3	* 2.39	25.62	RMS	32.1	-20.8	36.92	54	-17.08	-	-	304	345	V

* - indicates frequency in CFR47 Pt 15 / IC RSS-Restricted Band
 Pk - Peak detector

10.2.2. AUTHORIZED BANDEGE (HIGH CHANNEL)

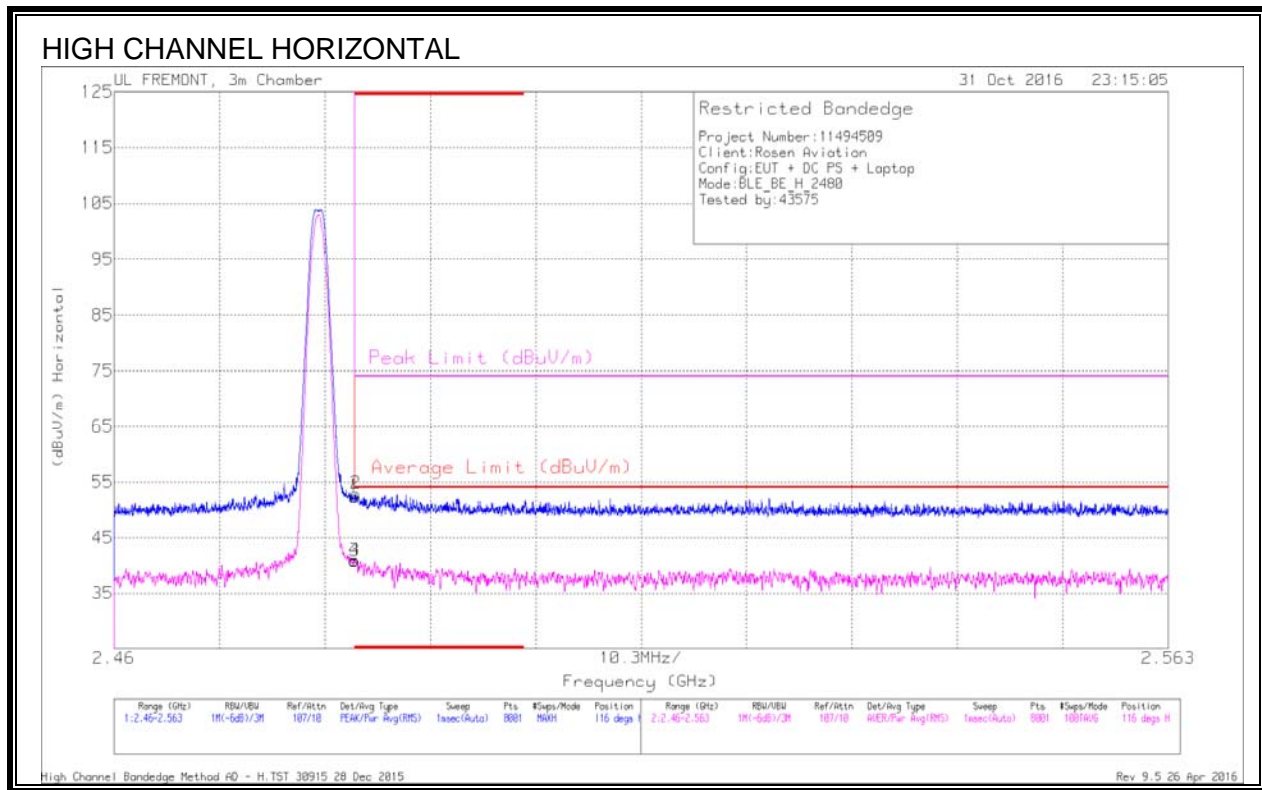

Trace Markers

Marker	Frequency (GHz)	Meter Reading (dBuV)	Det	Af T119 (dB/m)	Amp/Cb1/Filtr/Pad (dB)	Corrected Reading (dBuV/m)	Average Limit (dBuV/m)	Margin (dB)	Peak Limit (dBuV/m)	PK Margin (dB)	Azimuth (Degs)	Height (cm)	Polarity
1	* 2.484	40.81	Pk	32.4	-20.8	52.41	-	-	74	-21.59	116	381	H
2	* 2.484	41.27	Pk	32.4	-20.8	52.87	-	-	74	-21.13	116	381	H
3	* 2.484	29.18	RMS	32.4	-20.8	40.78	54	-13.22	-	-	116	381	H
4	* 2.484	29.29	RMS	32.4	-20.8	40.89	54	-13.11	-	-	116	381	H

* - indicates frequency in CFR47 Pt 15 / IC RSS-Restricted Band

Pk - Peak detector

RMS - RMS detection

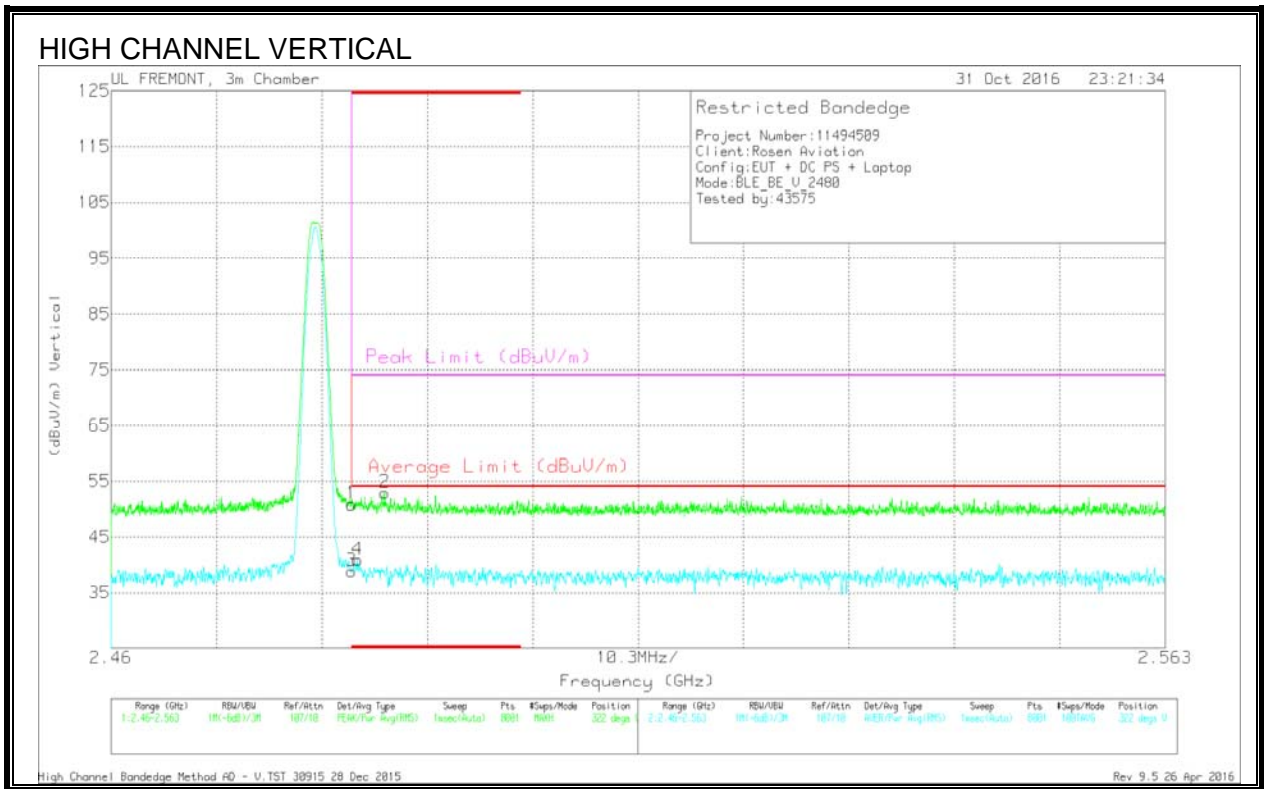

Trace Markers

Marker	Frequency (GHz)	Meter Reading (dBuV)	Det	AF T119 (dB/m)	Amp/Cbl/Filtr/Pad (dB)	Corrected Reading (dBuV/m)	Average Limit (dBuV/m)	Margin (dB)	Peak Limit (dBuV/m)	PK Margin (dB)	Azimuth (Degs)	Height (cm)	Polarity
1	* 2.484	39.3	Pk	32.4	-20.8	50.9	-	-	74	-23.1	322	342	V
3	* 2.484	27.29	RMS	32.4	-20.8	38.89	54	-15.11	-	-	322	342	V
4	* 2.484	29.3	RMS	32.4	-20.8	40.9	54	-13.1	-	-	322	342	V
2	* 2.487	41.43	Pk	32.4	-20.9	52.93	-	-	74	-21.07	322	342	V

* - indicates frequency in CFR47 Pt 15 / IC RSS-Restricted Band
 Pk - Peak detector
 RMS - RMS detection

10.2.3. HARMONICS AND SPURIOUS EMISSIONS

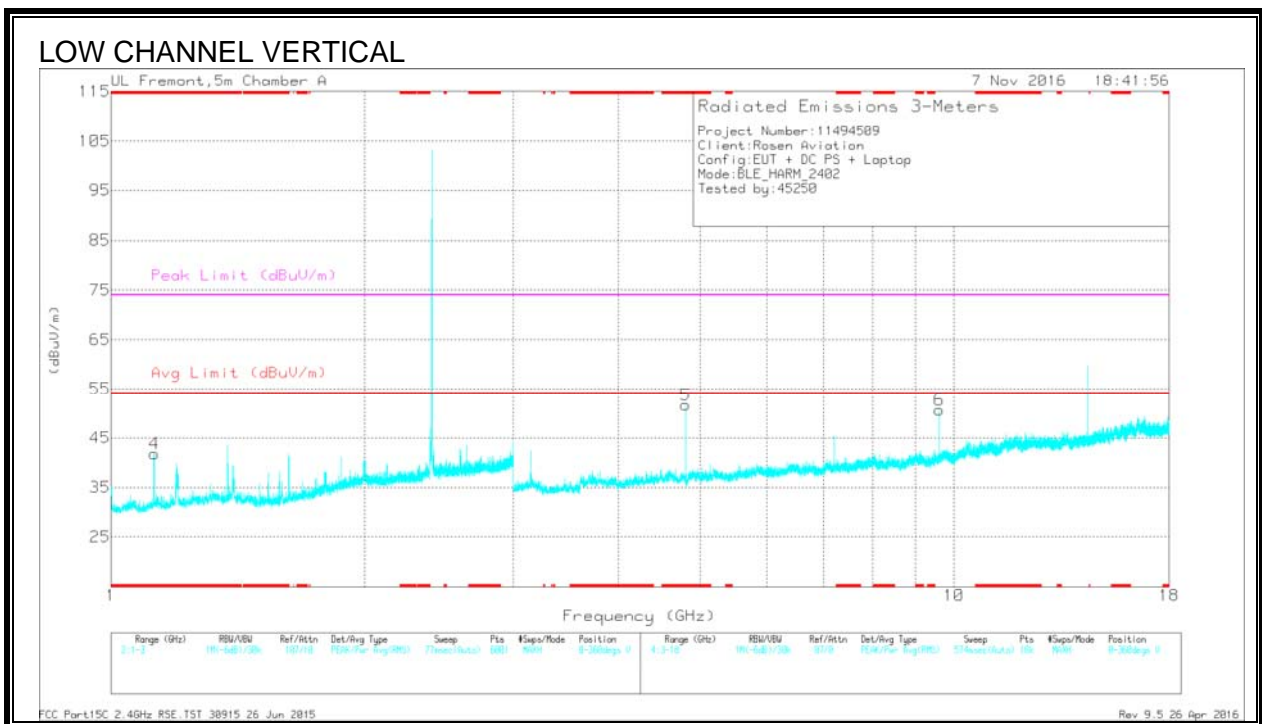
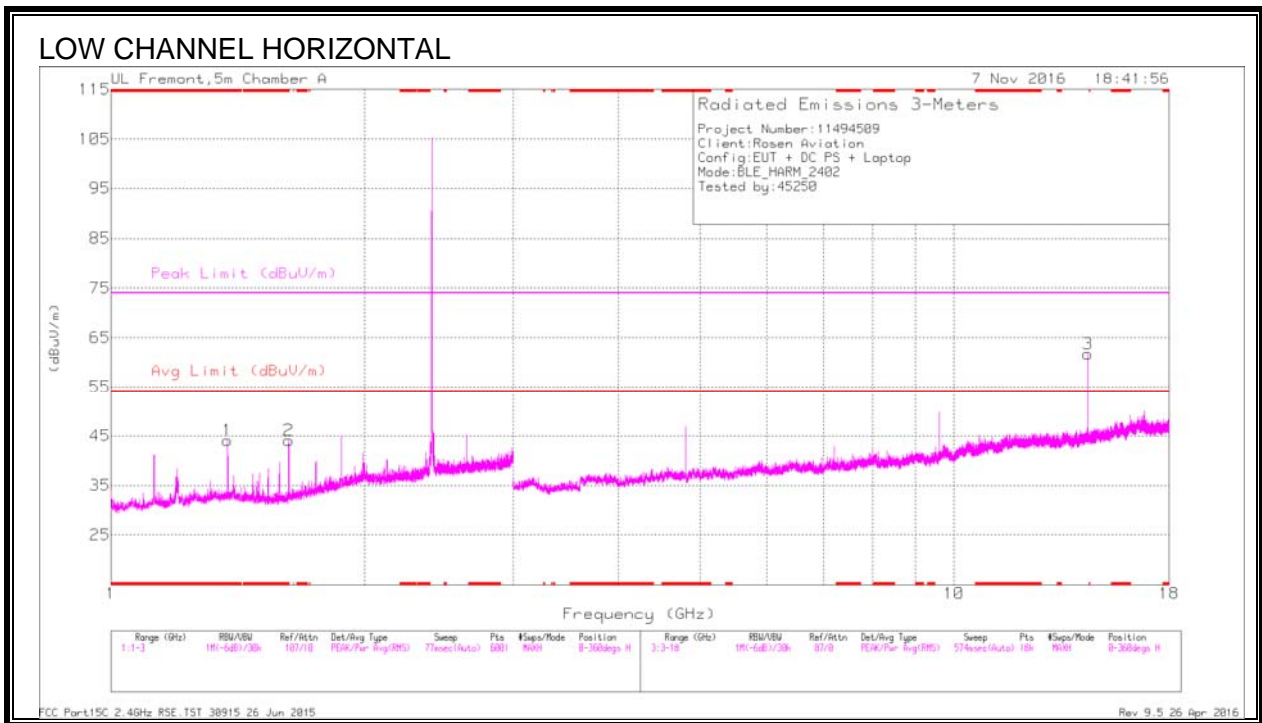

Radiated Emissions

Frequency (GHz)	Meter Reading (dBuV)	Det	AF T346 (db/m)	Amp/Cbl/Filtr/Pad (dB)	Corrected Reading (dBuV/m)	Avg Limit (dBuV/m)	Margin (dB)	Peak Limit (dBuV/m)	PK Margin (dB)	Azimuth (Degs)	Height (cm)	Polarity
* 1.375	42.93	PK2	29	-23.8	48.13	-	-	74	-25.87	111	104	H
* 1.375	37.58	MAv1	29	-23.8	42.78	54	-11.22	-	-	111	104	H
* 1.625	42.44	PK2	28.4	-23.6	47.24	-	-	74	-26.76	85	130	H
* 1.625	30.34	MAv1	28.4	-23.6	35.14	54	-18.86	-	-	85	130	H
* 1.125	42.46	PK2	27.9	-24.1	46.26	-	-	74	-27.74	77	124	V
* 1.125	35.2	MAv1	27.9	-24.1	39	54	-15	-	-	77	124	V
* 4.803	49.37	PK2	34.3	-28.6	55.07	-	-	74	-18.93	35	107	V
* 4.804	43.16	MAv1	34.3	-28.5	48.96	54	-5.04	-	-	35	107	V
**9.607	39.95	PK2	36.5	-22.1	54.35	-	-	-	-	31	110	V
**9.607	31.67	MAv1	36.5	-22.1	46.07	-	-	-	-	31	110	V
**14.41	47	PK2	39.3	-20.5	65.8	-	-	-	-	84	110	H
**14.41	39.93	MAv1	39.3	-20.5	58.73	-	-	-	-	84	110	H

* - indicates frequency in CFR47 Pt 15 / IC RSS-Restricted Band

** - indicates frequency not in Restricted Band

PK2 - KDB558074 Method: Maximum Peak

MAv1 - KDB558074 Option 1 Maximum RMS Average

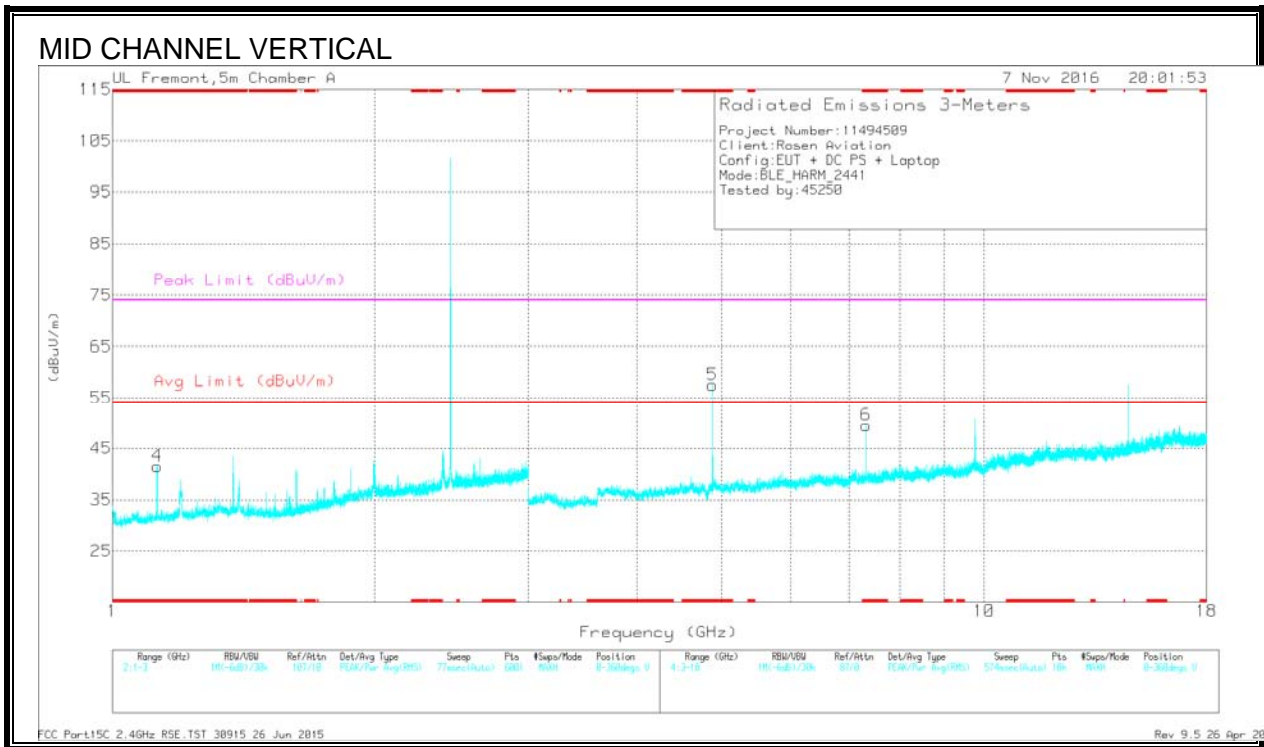
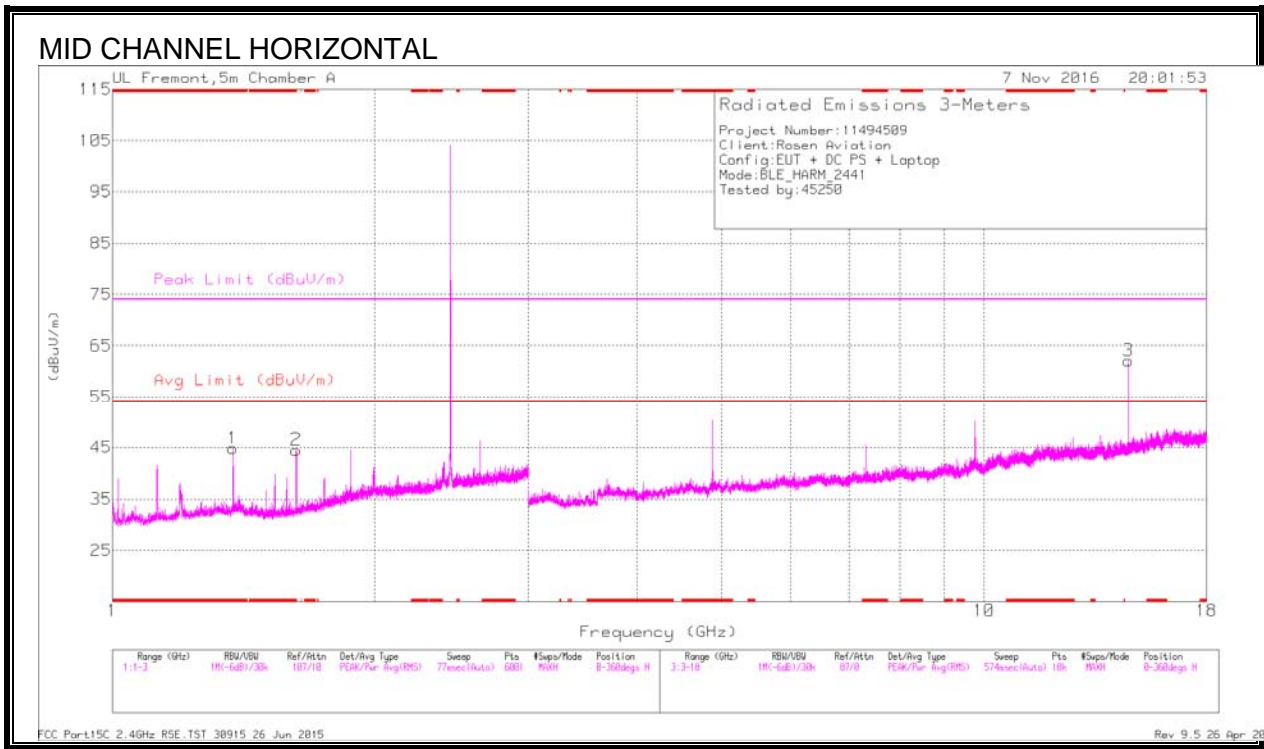

Radiated Emissions

Frequency (GHz)	Meter Reading (dBuV)	Det	AF T346 (db/m)	Amp/Cbl/Filtr/Pad (dB)	Corrected Reading (dBuV/m)	Avg Limit (dBuV/m)	Margin (dB)	Peak Limit (dBuV/m)	PK Margin (dB)	Azimuth (Degs)	Height (cm)	Polarity
* 1.375	42.65	PK2	29	-23.8	47.85	-	-	74	-26.15	112	105	H
* 1.375	35.23	MAv1	29	-23.8	40.43	54	-13.57	-	-	112	105	H
* 1.625	42.14	PK2	28.4	-23.6	46.94	-	-	74	-27.06	84	129	H
* 1.625	35.93	MAv1	28.4	-23.6	40.73	54	-13.27	-	-	84	129	H
* 1.125	42.55	PK2	27.9	-24.1	46.35	-	-	74	-27.65	76	129	V
* 1.125	35.5	MAv1	27.9	-24.1	39.3	54	-14.7	-	-	76	129	V
* 4.882	52.38	PK2	34.3	-27.8	58.88	-	-	74	-15.12	28	111	V
* 4.882	46.75	MAv1	34.3	-27.8	53.25	54	-7.5	-	-	28	111	V
* 7.323	43.15	PK2	35.7	-24.9	53.95	-	-	74	-20.05	22	201	V
* 7.324	35.49	MAv1	35.7	-24.9	46.29	54	-7.71	-	-	22	201	V
**14.647	44.77	PK2	39.6	-20.3	64.07	-	-	-	-	85	110	H
**14.647	38.05	MAv1	39.6	-20.4	57.25	-	-	-	-	85	110	H

* - indicates frequency in CFR47 Pt 15 / IC RSS-Restricted Band

** - indicates frequency not in Restricted Band

PK2 - KDB558074 Method: Maximum Peak

MAv1 - KDB558074 Option 1 Maximum RMS Average

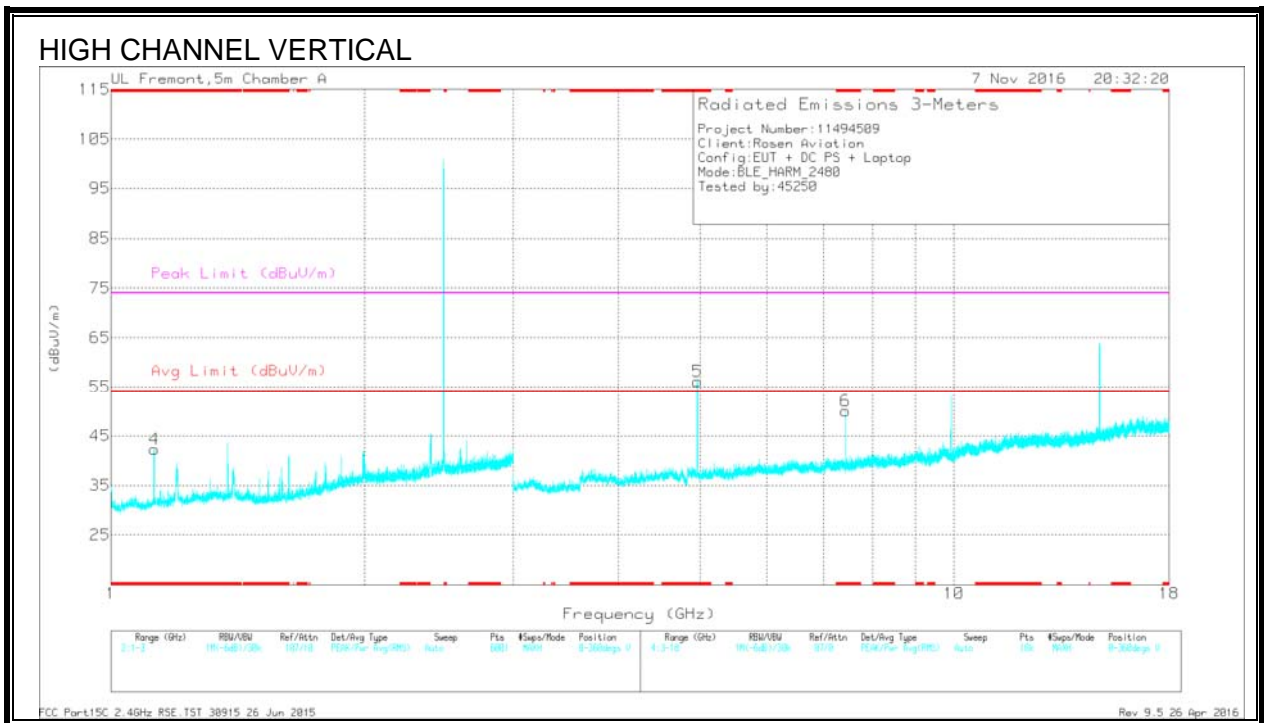
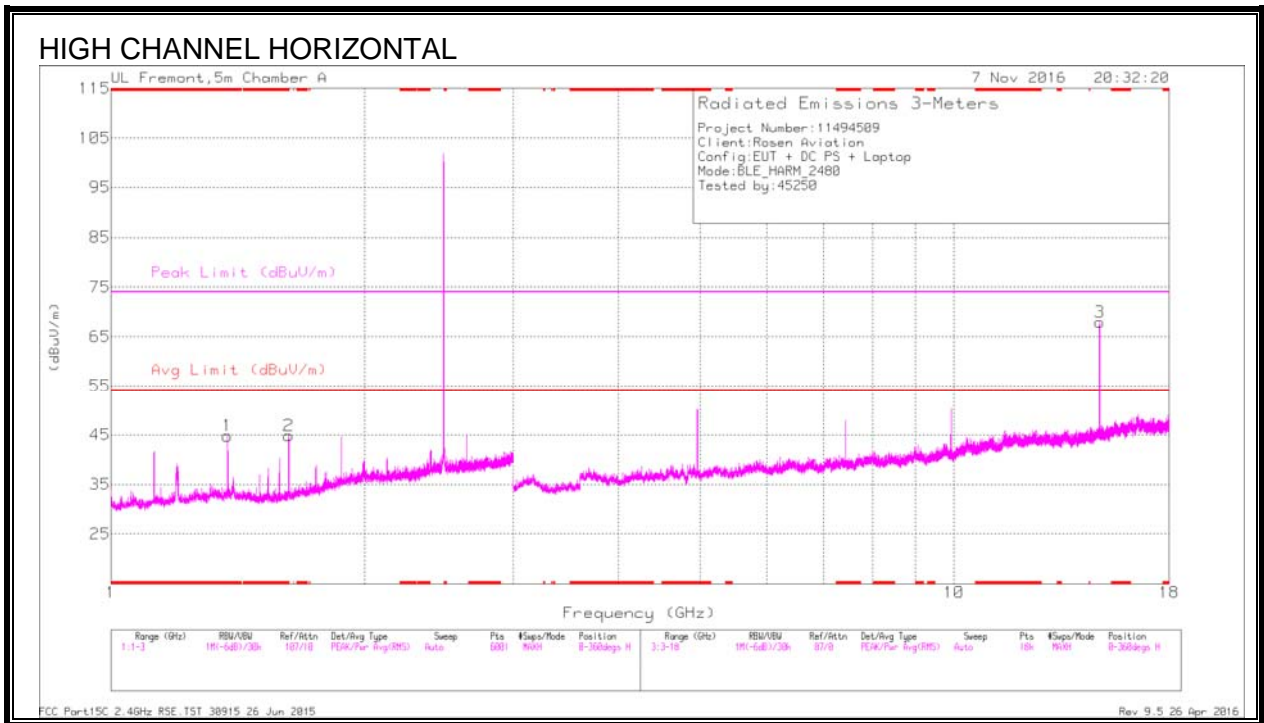

Radiated Emissions

Frequency (GHz)	Meter Reading (dBuV)	Det	AF T346 (db/m)	Amp/Cbl/Filtr/P ad (dB)	Corrected Reading (dBuV/m)	Avg Limit (dBuV/m)	Margin (dB)	Peak Limit (dBuV/m)	PK Margin (dB)	Azimuth (Degs)	Height (cm)	Polarity
* 1.375	42.93	PK2	29	-23.8	48.13	-	-	74	-25.87	111	103	H
* 1.375	36.37	MAv1	29	-23.8	41.57	54	-12.43	-	-	111	103	H
* 1.625	43.43	PK2	28.4	-23.6	48.23	-	-	74	-25.77	86	101	H
* 1.625	36.62	MAv1	28.4	-23.6	41.42	54	-12.58	-	-	86	101	H
* 1.125	42.73	PK2	27.9	-24.1	46.53	-	-	74	-27.47	82	129	V
* 1.125	35.39	MAv1	27.9	-24.1	39.19	54	-14.81	-	-	82	129	V
* 4.959	52.53	PK2	34.3	-28.2	58.63	-	-	74	-15.37	23	105	V
* 4.96	47.24	MAv1	34.3	-28.2	53.34	54	-6.66	-	-	23	105	V
* 7.441	41.93	PK2	35.8	-23.2	54.53	-	-	74	-19.47	18	183	V
* 7.441	34.48	MAv1	35.8	-23.2	47.08	54	-6.92	-	-	18	183	V
**14.881	46.8	PK2	39.8	-20.4	66.2	-	-	-	-	86	111	H
**14.881	40.56	MAv1	39.8	-20.4	59.96	-	-	-	-	86	111	H

* - indicates frequency in CFR47 Pt 15 / IC RSS-Restricted Band

** - indicates frequency not in Restricted Band

PK2 - KDB558074 Method: Maximum Peak

MAv1 - KDB558074 Option 1 Maximum RMS Average

10.3. WORST-CASE ABOVE 18 GHz

SPURIOUS EMISSIONS ABOVE 18GHz (WORST-CASE CONFIGURATION)

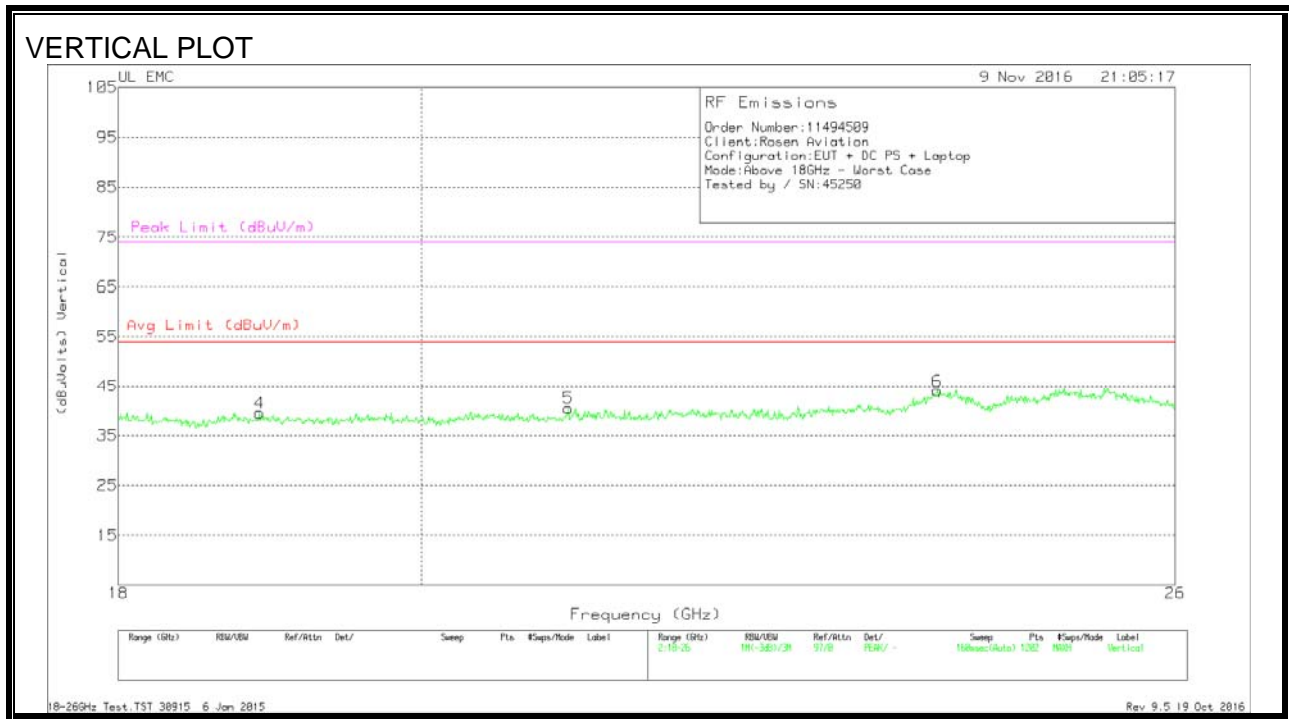
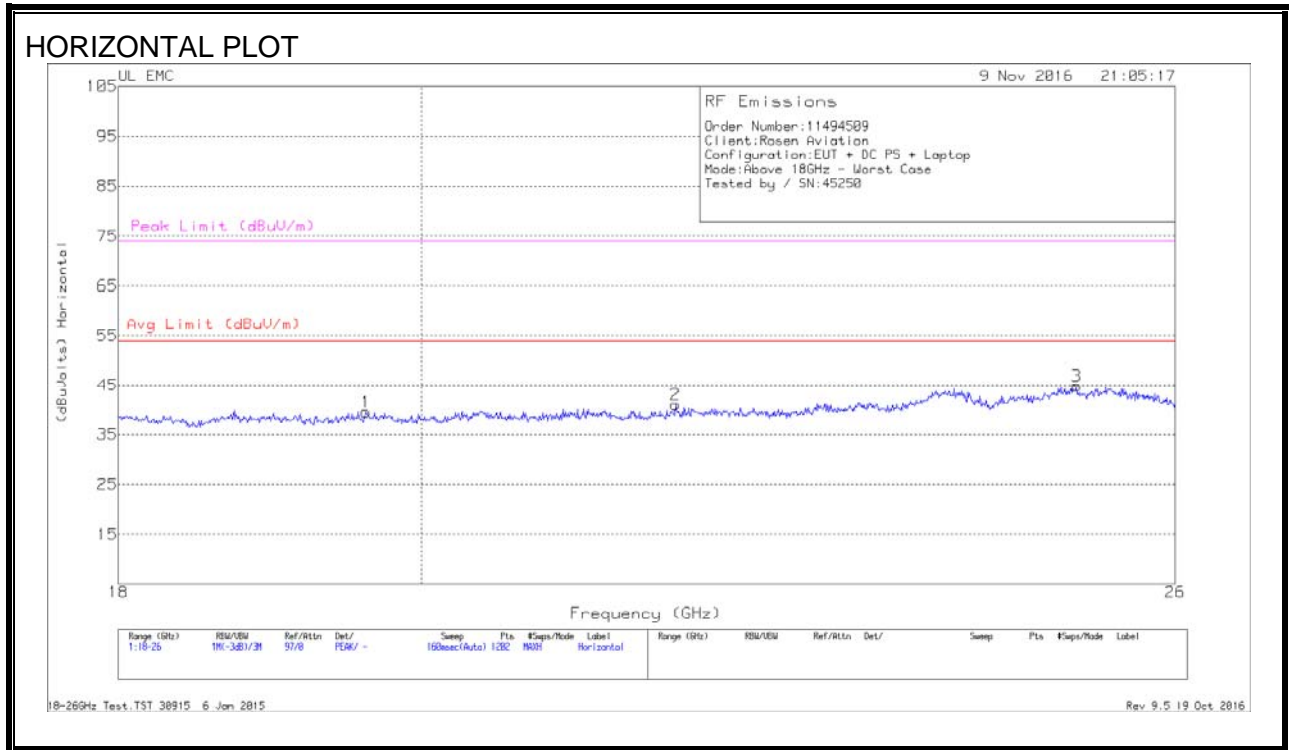

Trace Markers

Marker	Frequency (GHz)	Meter Reading (dBuV)	Det	AF T449 (dB/m)	Amp/Cbl (dB)	Dist Corr (dB)	Corrected Reading (dBuVolts)	Avg Limit (dBuV/m)	Margin (dB)	Peak Limit (dBuV/m)	PK Margin (dB)
1	19.619	41.20	Pk	32.7	-24.9	-9.5	39.50	54	-14.5	74	-34.50
2	21.850	41.90	Pk	33.3	-24.7	-9.5	41.00	54	-13.0	74	-33.00
3	25.121	44.63	Pk	34.3	-24.6	-9.5	44.83	54	-9.17	74	-29.17
4	18.906	41.90	Pk	32.5	-25.4	-9.5	39.50	54	-14.5	74	-34.50
5	21.051	42.20	Pk	33.1	-25.3	-9.5	40.50	54	-13.5	74	-33.50
6	23.935	43.60	Pk	34.0	-24.1	-9.5	44.00	54	-10.0	74	-30.00

Pk - Peak detector

10.4. WORST-CASE BELOW 1 GHz

SPURIOUS EMISSIONS 30 TO 1000 MHz (WORST-CASE CONFIGURATION)

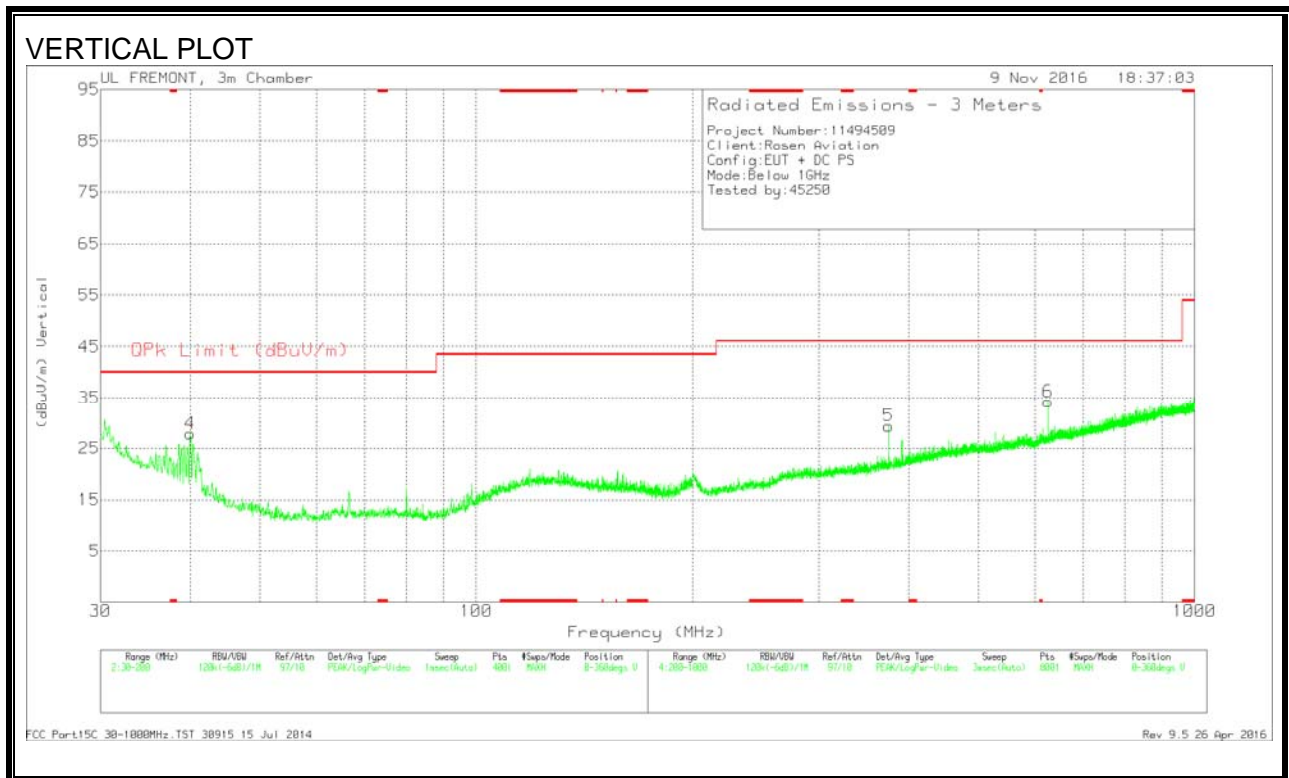
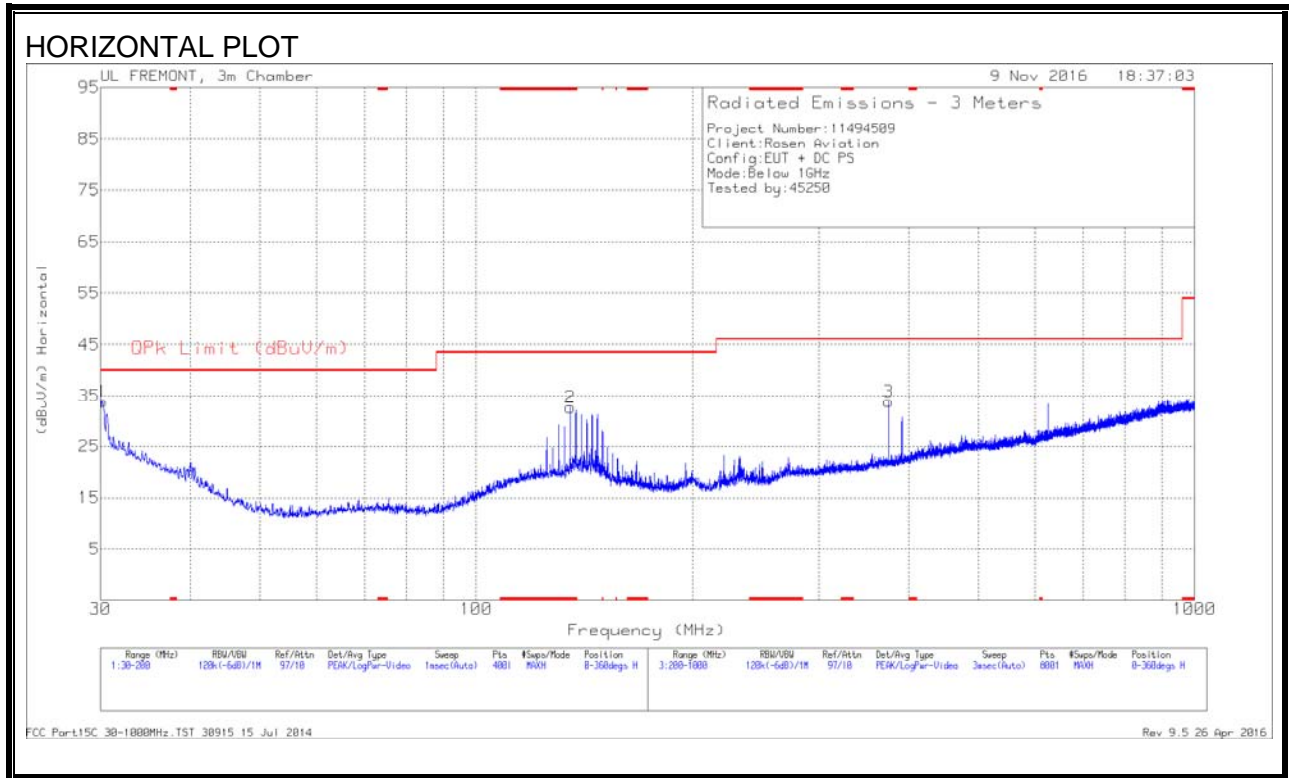

Radiated Emissions

Frequency (MHz)	Meter Reading (dBuV)	Det	AF T122 (dB/m)	Amp/Cbl (dB)	Corrected Reading (dBuV/m)	QPk Limit (dBuV/m)	Margin (dB)	Azimuth (Degs)	Height (cm)	Polarity
30.3784	20.55	Qp	25.0	-27.2	18.35	40.00	-21.65	82	104	H
* 135.2005	33.51	Qp	17.5	-25.8	25.21	43.52	-18.31	2	398	H
39.8781	21.00	Qp	17.9	-27.1	11.8	40.00	-28.2	286	103	V
374.9933	38.31	Qp	18.9	-24.5	32.71	46.02	-13.31	216	105	H
375	32.03	Qp	18.9	-24.5	26.43	46.02	-19.59	70	187	V
625.0168	34.02	Qp	23.2	-24.2	33.02	46.02	-13.00	13	174	V

* - indicates frequency in CFR47 Pt 15 / IC RSS-Restricted Band

Qp - Quasi-Peak detector

10.5. WORST-CASE BELOW 30 MHz

SPURIOUS EMISSIONS BELOW 30 MHz (WORST-CASE CONFIGURATION)

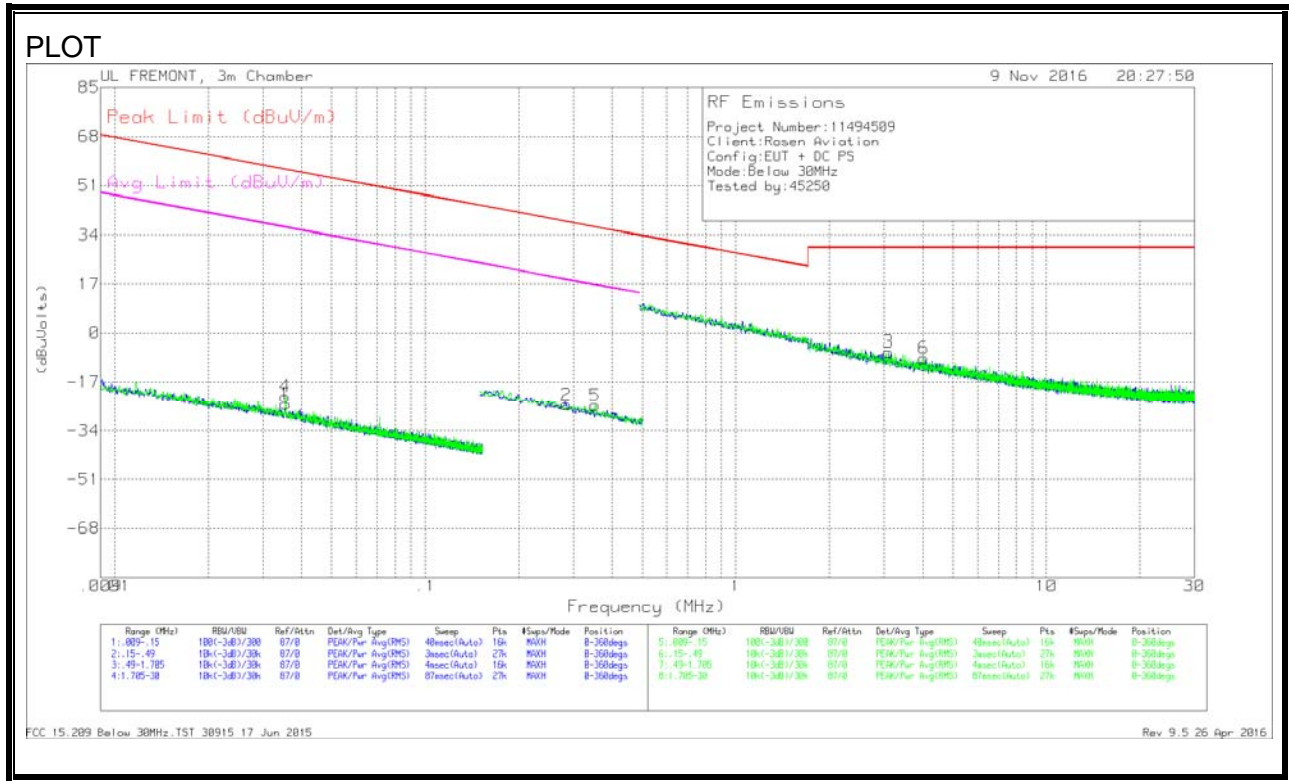

Trace Markers

Marker	Frequency (MHz)	Meter Reading (dBuV)	Det	Loop Antenna (dB/m)	Cbl (dB)	Dist Corr 300m	Corrected Reading (dBuVolts)	Peak Limit (dBuV/m)	Margin (dB)	Avg Limit (dBuV/m)	Margin (dB)	Azimuth (Degs)
4	.03549	44.09	PK	12.5	1.4	-80	-22.01	56.6	-78.61	36.6	-58.61	0-360
1	.0355	41.30	PK	12.5	1.4	-80	-24.80	56.6	-81.4	36.6	-61.4	0-360
2	.2847	42.68	PK	10.8	1.5	-80	-25.02	38.52	-63.54	18.52	-43.54	0-360
5	.3527	42.60	PK	10.7	1.5	-80	-25.20	36.66	-61.86	16.66	-41.86	0-360

Pk - Peak detector

Marker	Frequency (MHz)	Meter Reading (dBuV)	Det	Loop Antenna (dB/m)	Cbl (dB)	Dist Corr 30m	Corrected Reading (dBuVolts)	Peak Limit (dBuV/m)	Margin (dB)	Avg Limit (dBuV/m)	Margin (dB)	Azimuth (Degs)
3	3.10513	21.15	PK	10.8	1.5	-40	-6.55	29.54	-36.09	-	-	0-360
6	4.01951	18.88	PK	10.9	1.5	-40	-8.72	29.54	-38.26	-	-	0-360

Pk - Peak detector

11. AC POWER LINE CONDUCTED EMISSIONS

LIMITS

FCC §15.207 (a)

RSS-Gen 8.8

Frequency of Emission (MHz)	Conducted Limit (dB μ V)	
	Quasi-peak	Average
0.15-0.5	66 to 56 *	56 to 46 *
0.5-5	56	46
5-30	60	50

*Decreases with the logarithm of the frequency.

TEST PROCEDURE

The EUT is placed on a non-conducting table 40 cm from the vertical ground plane and 80 cm above the horizontal ground plane. The EUT is configured in accordance with ANSI C63.10.

The receiver is set to a resolution bandwidth of 9 kHz. Peak detection is used unless otherwise noted as quasi-peak or average.

Line conducted data is recorded for both NEUTRAL and HOT lines.

RESULTS

LINE 1 RESULTS

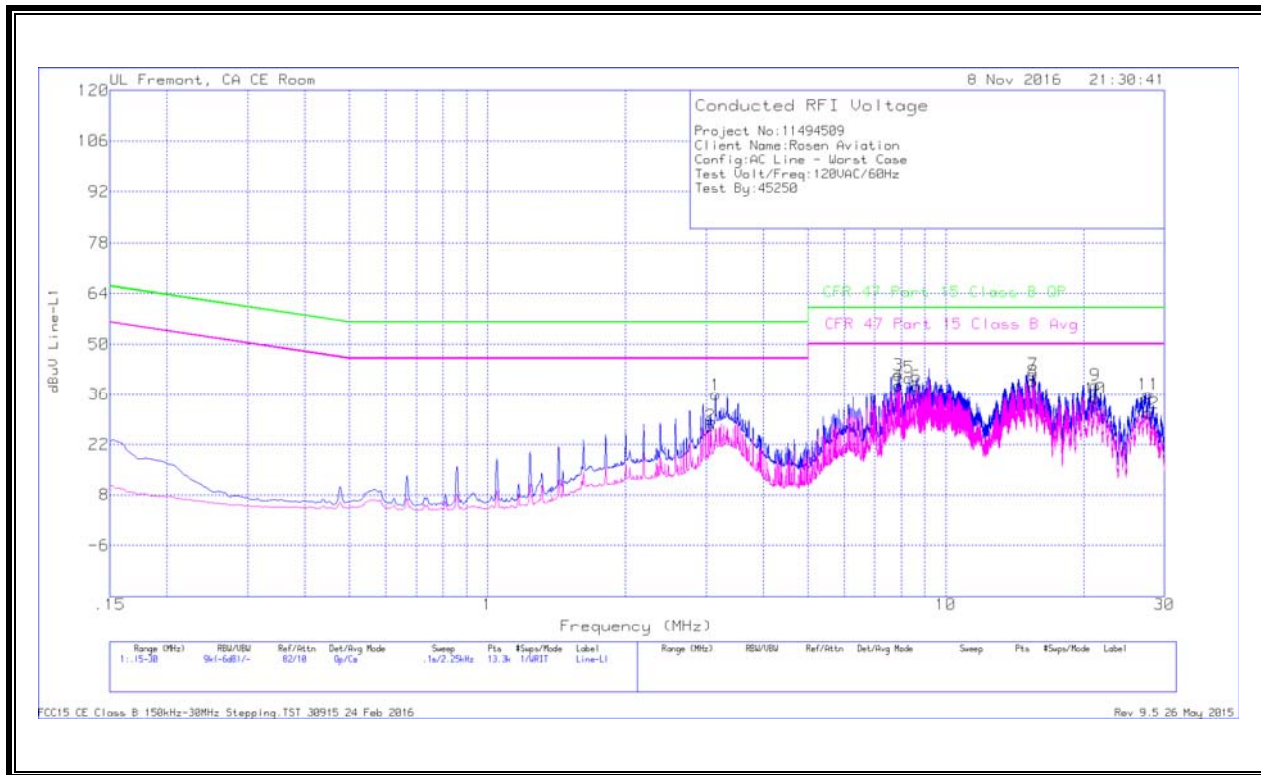

Trace Markers

Range 1: Line-L1 .15 - 30MHz

Marker	Frequency (MHz)	Meter Reading (dBuV)	Det	LISN L1	LC Cables 1&3	Limiter (dB)	Corrected Reading dBuV	CFR 47 Part 15 Class B QP	QP Margin (dB)	CFR 47 Part 15 Class B Avg	Av(CISPR) Margin (dB)
1	3.14475	25.66	Qp	0	.1	10.1	35.86	56	-20.14	-	-
2	3.06825	17	Ca	0	.1	10.1	27.2	-	-	46	-18.8
3	7.881	31.13	Qp	0	.1	10.2	41.43	60	-18.57	-	-
4	7.881	28.26	Ca	0	.1	10.2	38.56	-	-	50	-11.44
5	8.322	30.4	Qp	0	.1	10.2	40.7	60	-19.3	-	-
6	8.63925	28.04	Ca	0	.1	10.2	38.34	-	-	50	-11.66
7	15.51975	31.31	Qp	0	.2	10.2	41.71	60	-18.29	-	-
8	15.51975	29.4	Ca	0	.2	10.2	39.8	-	-	50	-10.2
9	21.19875	28.13	Qp	0	.2	10.4	38.73	60	-21.27	-	-
10	21.201	24.35	Ca	0	.2	10.4	34.95	-	-	50	-15.05
11	27.7395	25.18	Qp	.1	.3	10.5	36.08	60	-23.92	-	-
12	27.7395	19.83	Ca	.1	.3	10.5	30.73	-	-	50	-19.27

Qp - Quasi-Peak detector

Ca - CISPR average detection

LINE 2 RESULTS

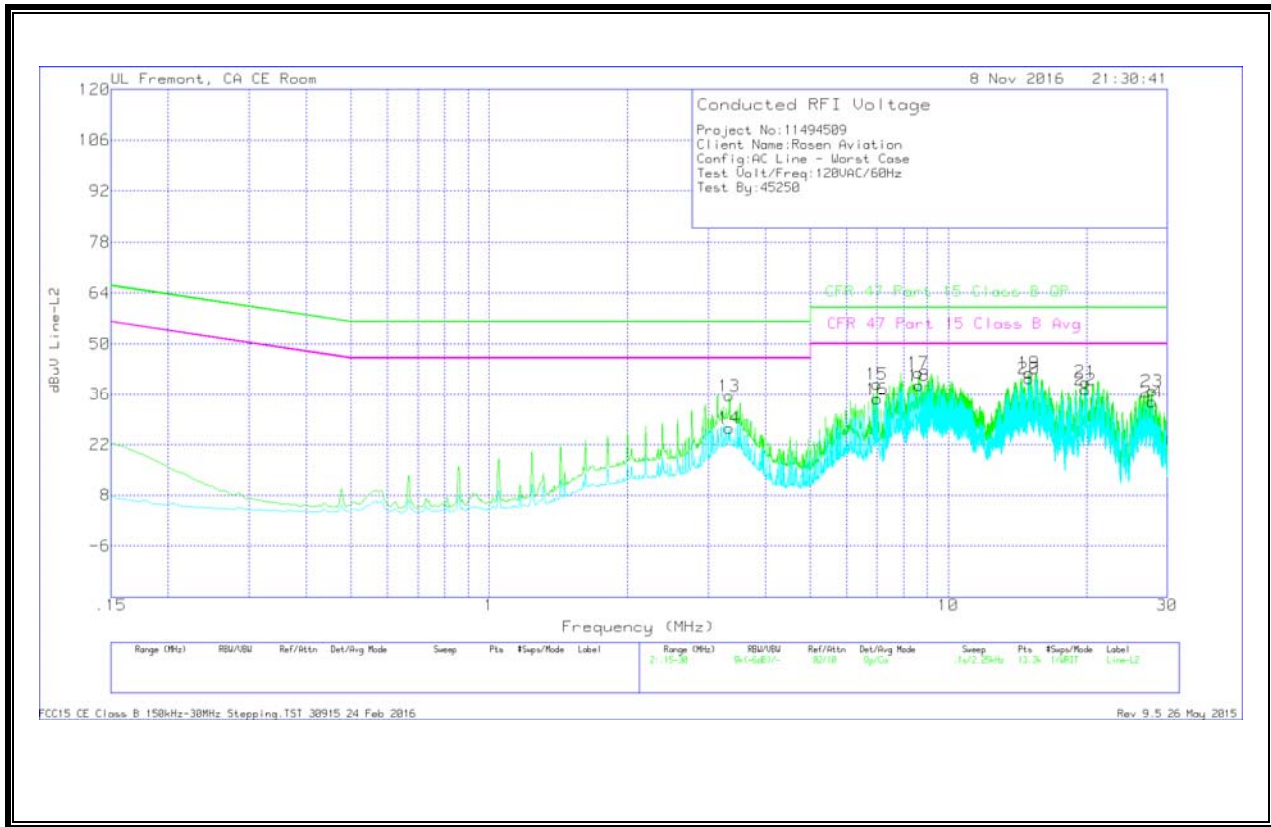

Range 2: Line-L2 .15 - 30MHz

Marker	Frequency (MHz)	Meter Reading (dBuV)	Det	LISN L2	LC Cables 2&3	Limiter (dB)	Corrected Reading dBuV	CFR 47 Part 15 Class B QP	QP Margin (dB)	CFR 47 Part 15 Class B Avg	Av(CISPR) Margin (dB)
13	3.33375	25.34	Qp	0	.1	10.1	35.54	56	-20.46	-	-
14	3.336	16.27	Ca	0	.1	10.1	26.47	-	-	46	-19.53
15	6.999	28.58	Qp	0	.1	10.2	38.88	60	-21.12	-	-
16	7.00125	24.41	Ca	0	.1	10.2	34.71	-	-	50	-15.29
17	8.601	31.64	Qp	0	.1	10.2	41.94	60	-18.06	-	-
18	8.63925	28.19	Ca	0	.1	10.2	38.49	-	-	50	-11.51
19	15	31.48	Qp	.1	.2	10.2	41.98	60	-18.02	-	-
20	15	29.92	Ca	.1	.2	10.2	40.42	-	-	50	-9.58
21	19.92075	28.98	Qp	0	.2	10.3	39.48	60	-20.52	-	-
22	19.92075	26.74	Ca	0	.2	10.3	37.24	-	-	50	-12.76
23	27.75975	26.07	Qp	.1	.3	10.5	36.97	60	-23.03	-	-
24	27.75975	23.01	Ca	.1	.3	10.5	33.91	-	-	50	-16.09

Qp - Quasi-Peak detector

Ca - CISPR average detection