

SME VoIP System Guide

*Installation & Configuration
Network Deployment
Operation & Management*

Technical Reference Document
Version 2.6
© Jan-2016 RTX A/S, Denmark

Trademarks

RTX and the combinations of its logo thereof are trademarks of RTX A/S, Denmark. Other product names used in this publication are for identification purposes and maybe the trademarks of their respective companies.

Disclaimer

The contents of this document are provided in connection with RTX products. RTX makes no representations with respect to completeness or accuracy of the contents of this publication and reserves the right to make changes to product descriptions, usage, etc., at any time without notice. No license, whether express, implied, to any intellectual property rights are granted by this publication

Confidentiality

This document should be regarded as confidential, unauthorized copying is not allowed

© Jan-2016 RTX A/S, Denmark, All rights reserved
<http://www.rtx.dk>

Contents

SME VoIP System Guide	1
.....	1
Contents	3
1 About This Document.....	7
1.1 Audience	7
1.2 When Should I Read This Guide	7
1.3 Important Assumptions	7
1.4 What’s Inside This Guide	7
1.5 What’s Not in This guide.....	8
1.6 Abbreviations.....	8
1.7 References/Related Documentation	9
1.8 Document History.....	9
1.9 Documentation Feedback	9
2 Introduction – System Overview	10
2.1 Hardware Setup.....	10
2.2 Components of SME VoIP System	11
2.3 Wireless Bands	11
2.4 System Capacity (in Summary)	12
2.5 Advantages of SME VoIP System	12
3 Installation of Base Stations/Repeater.....	13
3.1 Package – Contents/Damage Inspection.....	13
3.2 RTX Base station Mechanics	14
3.3 RTX Base Unit – Reset feature	14
3.4 Installing the Base Station	15
3.5 Find IP of Base Station.....	16
3.6 Login to Base SME Configuration Interface	17
4 Making Handset Ready.....	18
4.1 Package – Contents/Damage Inspection.....	18
4.2 Before Using the Phone.....	19
4.3 Using the Handset	20
5 SME VoIP Administration Interface	21
5.1 Web navigation.....	21
5.2 Home/Status.....	23
5.3 Extensions.....	24

5.4 Servers	35
5.5 Network	40
5.6 Management Settings Definitions	44
5.7 Firmware Update Definitions	48
5.8 Time Server	49
5.9 Country	51
5.10 Security	52
5.11 Central Directory and LDAP	54
5.12 Multi-cell Parameter Definitions	57
5.13 Repeaters.....	64
5.14 Alarm	68
5.15 Statistics.....	70
5.16 Settings – Configuration File Setup	74
5.17 Sys log	74
5.18 SIP Logs	75
6 Multi-cell Setup & Management	76
6.1 Adding Base stations	76
6.2 Synchronizing the Base stations	80
6.3 Summary of Procedure – Creating a Chain.....	82
6.4 Practical Configuration of Multi-cell System	83
7 Registration Management - Handset	88
7.1 Register handset to base (non multiline)	88
7.2 Register handset to base (multiline)	90
7.3 Register handset to base and specific extension (multiline).....	93
8 Firmware Upgrade Procedure	95
8.1 Network Dimensioning.....	95
8.2 TFTP Configuration	95
8.3 Create Firmware Directories	96
8.4 Handset Firmware Update Settings.....	98
8.5 Handset(s) and Repeater Firmware Upgrade.....	98
8.6 Base Station(s) Firmware Upgrade	100
9 Functionality Overview.....	102
9.1 Gateway Interface	102
9.2 Detail Feature List.....	102
Appendix.....	105

10	Appendix A: Basic Network Server(s) Configuration	105
10.1	Server setup.....	105
10.2	Requirements	105
10.3	DNS Server Installation/Setup	105
10.4	DHCP Server Setup	105
10.5	TFTP Server Setup.....	107
10.6	SIP Server Setup.....	108
11	Appendix B: Using Base with VLAN Network	111
11.1	Introduction.....	111
11.2	Backbone/ VLAN Aware Switches	112
11.3	How VLAN Switch Work: VLAN Tagging	113
11.4	Implementation Cases.....	113
11.5	Base station Setup	114
11.6	Configure Time Server	114
11.7	VLAN Setup: Base station	115
12	Appendix C: SME VoIP Network Planning/Optimization	116
12.1	Network Requirements	116
12.2	Deployment Considerations	116
12.3	Site Planning	116
12.4	Cell Coverage / Capacity Planning	117
12.5	Network Dimensioning.....	118
12.6	Environmental Considerations	119
12.7	Recommended Base station/Repeater Placement	119
12.8	Network Assessment/Optimisation	120
13	Appendix D: Local Central directory file handling	122
13.1	Central Directory Contact List Structure	122
13.2	Central Directory Contact List Filename Format	122
13.3	Import Contact List to Central Directory	123
13.4	Central directory using server	124
13.5	Verification of Contact List Import to Central Directory	124
14	Appendix E: Network Operations	125
14.1	Introduction.....	125
14.2	System Start Up	125
14.3	Terminal Attachment.....	125
14.4	Outgoing Calls.....	125

14.5 Incoming Calls.....	125
14.6 Handover	126
14.7 Roaming.....	127

1 About This Document

This document describes the configuration, customization, management, operation, maintenance and trouble shooting of the SME VoIP System (RTX8663 base, RTX8630 handset, RTX8430 handset, RTX8830 ruggedized handset and RTX4024 Repeater) in RTX generic mode. For customer specific modes refer to specific customer agreements, which describe the software operational deviations from this document. For handset detailed user guide refer to [1].

1.1 Audience

Who should read this guide? First, this guide is intended for networking professionals responsible for designing and implementing RTX based enterprise networks.

Second, network administrators and IT support personnel that need to install, configure, maintain and monitor elements in a “live” SME VoIP network will find this document helpful. Furthermore, anyone who wishes to gain knowledge on fundamental features in the Beatus system can also benefit from this material.

1.2 When Should I Read This Guide

Read this guide before you install the core network devices of VoIP SME System and when you are ready to setup or configure SIP server, NAT aware router, advanced VLAN settings, base stations, and multi cell setup.

This manual will enable you to set up components in your network to communicate with each other and also deploy a fully functionally VoIP SME System.

1.3 Important Assumptions

This document was written with the following assumptions in mind:

- 1) You have understanding of network deployment in general
- 2) You have working knowledge of basic TCP/IP/SIP protocols, Network Address Translation, etc...
- 3) A proper site survey has been performed, and the administrator have access to these plans

1.4 What’s Inside This Guide

We summarize the contents of this document in the table below:

Where Is It?	Content	Purpose
Chapter 2	Introduction to the SME VoIP Network	To gain knowledge about the different elements in a typical SME VoIP Network
Chapter 3	Installation of Base station/Repeater	Considerations to remember before unwrapping and installing base units and repeaters
Chapter 4	Making Handsets Ready	To determine precautions to take in preparing handsets for use in the system
Chapter 5	SME VoIP Administration Interface	To learn about the Configuration Interface and define full meaning of various parameters needed to be setup in the system.
Chapter 6	Multi-Cell Setup & Management	Learn how to add servers and setup multiple bases into a multi-cell network
Chapter 7	Registration Management -	Learn how to register handset and extensions to base

	Handsets	stations
Chapter 8	Firmware Upgrade/Downgrade Management	Provides the procedure of how to upgrade firmware to base stations and/or handsets and/or repeaters
Chapter 9	System Functionality Overview	To gain detail knowledge about the system features.
10 Appendix A	Basic Network Servers Configuration	To learn about operating the handset and base stations including detail description of handset MMI.
11 Appendix B	VLAN Setup Management	Examines how to setup VLAN in the SME network
12 Appendix C	SME VoIP Network Planning/Optimization	To learn radio network planning techniques including dimensioning, detailed capacity, coverage planning and network optimisation
13 Appendix D	Local central directory file handling	Detailed description of central directory file format and upload.
14 Appendix E	Network Operations	To study the operation of network elements during system start up, location registration, etc.

1.5 What's Not in This guide

This guide provides overview material on network deployment, how-to procedures, and configuration examples that will enable you to begin configuring your VoIP SME System.

It is not intended as a comprehensive reference to all detail and specific steps on how to configure other vendor specific components/devices needed to make the SME VoIP System functional. For such a reference to vendor specific devices, please contact the respective vendor documentation.

1.6 Abbreviations

For the purpose of this document, the following abbreviations hold:

DHCP:	Dynamic Host Configuration Protocol
DNS:	Domain Name Server
HTTP(S):	Hyper Text Transfer Protocol (Secure)
(T)FTP:	(Trivial) File Transfer Protocol
IOS:	Internetworking Operating System
PCMA:	A-law Pulse Code Modulation
PCMU:	mu-law Pulse Code Modulation
PoE:	Power over Ethernet
RTP:	Real-time Transport Protocol
RPORT:	Response Port (Refer to RFC3581 for details)
SIP:	Session Initiation Protocol
SME:	Small and Medium scale Enterprise
VLAN:	Virtual Local Access Network
TOS:	Type of Service (policy based routing)
URL:	Uniform Resource Locator
UA:	User Agent

1.7 References/Related Documentation

- [1]: RTX8430 Handset_Manual_Operations_v1.1
 RTX8630 Handset_Manual_Operations_v1.2
 RTX8830_Handset_Manual_Operations V1.3
- [2]: How to Deploy SME VOIP System v1.4
- [3]: Provisioning of SME VoIP System (10)

1.8 Document History

Revision	Author	Issue Date	Comments
2.2	KMR	24-July-2014	Document updated to include the new RTX8830 handset and features
2.1	KMR	2-April-2014	Document updated to match V316 software feature level in generic mode Server page: Added TLS, SRTP, server alias Updated other parts affected by server alias Repeater page: Added repeater alias References versions updated
2.0	KMR	1-Oct-2013	Document updated to match V306 software feature level in generic mode Home status: Base status added Extension page: Sort function added, Registration control added. Added unique extension note. Network: VLAN sync added Management: language moved to country Time: Added save button Country: Added language selection Security: Password double confirm added Central dir/LDAP: Reload option added Multicell: In status added Sync data IP Repeaters: Added stop registration Statistics: Added repeater statistics Section 6.3 multicell – modified sequence
1.9	KMR	17-July-2013	Document updated to match V303 software feature level (security, multiline, time settings). Primary Data Sync IP: Added note about data sync source.
1.8	KMR	18-Feb-2013	Restructured and updated to software V273 operation
2.3	KMR	8-Sep-2014	Updated to V322 operation with RTX8830 handset
2.4	KMR	5-Jan-2015	Aligned with V323B14 operation
2.5	KMR	16-Feb-2015	Aligned with V324 operation
2.6	KMR	12-Jan-2016	Added V355 system size capabilities

1.9 Documentation Feedback

We always strive to produce the best and we also value your comments and suggestions about our documentation. If you have any comments about this guide, please enter them through the Feedback link on the RTX website. We will use your feedback to improve the documentation.

2 Introduction – System Overview

In a typical telephony system, the network setup is the interconnection between Base-stations, “fat” routers, repeaters, portable parts, etc. The back-bone of the network depends on the deployment scenario but a ring or hub topology is used. The network has centralized monitoring, and maintenance system.

The system is easy to scale up and supports from 1 to 50 bases in the same network. Further it is able to support up to 1000 registered handsets (RTX8630, RTX8830 and RTX8430). The Small and Medium Scale Enterprise (SME) VoIP system setup is illustrated below. Based on PoE interface each base station is easy to install without additional wires other than the LAN cable. The system supports the IP DECT CAT-IQ repeater RTX4024 with support up to 5 channels simultaneous call sessions.

The following figure gives a graphical overview of the architecture of the SME VoIP System:

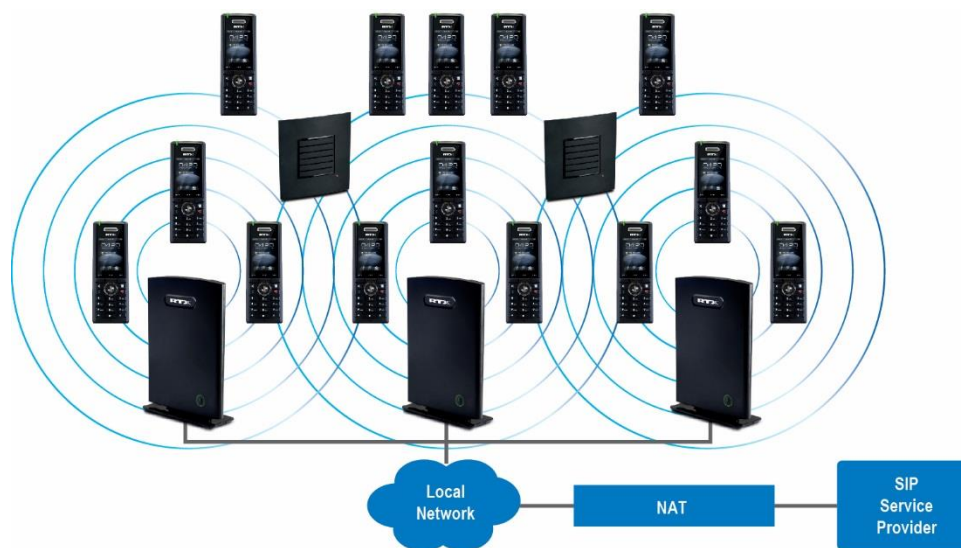

2.1 Hardware Setup

SME network hardware setup can be deployed as follows:

Base-station(s) are connected via Layer 3 and/or VLAN Aware Router depending on the deployment requirements. The Layer 3 router implements the switching function.

The base-stations are mounted on walls or lamp poles so that each base-station is separated from each other by up to 50m indoor¹ (300m outdoor). Radio coverage can be extended using repeaters that are installed with the same distance to base-station(s). Repeaters are range extenders and cannot be used to solve local call capacity issues. In this case, additional bases must be used.

The base-station antenna mechanism is based on space diversity, which improves coverage. The base-stations use a complete DECT MAC protocol layer and IP media stream audio encoding feature to provide up to 10 simultaneous calls.

¹ Measured with European DECT radio and depends on local building layout and material

2.2 Components of SME VoIP System

RTX SME VoIP system is made up of (but not limited to) the following components:

- At least one RTX Base Station is connected over an IP network and using DECT as air-core interface.
- RTX IP DECT wireless Handset.
- RTX SME VoIP Configuration Interface; is a management interface for SME VoIP Wireless Solution. It runs on all IP DECT Base stations. Each Base station has its own unique settings.

2.2.1 RTX Base Stations

The Base Station converts IP protocol to DECT protocol and transmits the traffic to and from the end-nodes (i.e. wireless handsets) over a channel. It has 12 available channels.

In a multi-cell setup, each base station has:

- 8 channels have associated DSP resources for media streams.
- The remaining 4 channels are reserved for control signalling between IP Base Stations and the SIP/DECT end nodes (or phones).

Base Stations are grouped into clusters. Within each Cluster, Base Stations are synchronized to enable a seamless handover when a user moves from one base station coverage to another. For synchronization purposes, it is not necessary for Base Stations to communicate directly with each other in the system. E.g. a Base Station may only need to communicate with the next in the chain. It is advisable for a Base Station to identify more than one Base Station to guarantee synchronization in the situation that one of the Base Stations fails.

The 4 control signalling channels are used to carry bearer signals that enable a handset to initiate a handover process.

2.2.2 SME VoIP Administration Server/Software

This server is referred to as SME VoIP Configuration Interface.

The SME VoIP Configuration Interface is a web based administration page used for configuration and programming of the base station and relevant network end-nodes. E.g. handsets can be registered or de-registered from the system using this interface.

The configuration interface can be used as a setup tool for software or firmware download to base stations, repeaters and handsets. Further, it is used to check relevant system logs that can be useful to administrator. These logs can be used to troubleshoot the system when the system faces unforeseen operational issues.

2.2.3 RTX Wireless Handset

The handset is a lightweight, ergonomically and portable unit compatible with Wideband Audio (G.722), DECT, GAP standard, CAT-iq audio compliant.

The handset includes Colour display with graphical user interface. It can also provide the subscriber with most of the features available for a wired phone, in addition to its roaming and handover capabilities. Refer to the relevant handset manuals for full details handset features.

2.3 Wireless Bands

The bands supported in the SME VoIP are summarized as follows:

Frequency bands:	1880 – 1930 MHz (DECT)
	1880 – 1900 MHz (10 carriers) Europe/ETSI
	1910 – 1930 MHz (10 carriers) LATAM
	1920 – 1930 MHz (5 carriers) US

2.4 System Capacity (in Summary)

SME network capacity of relevant components can be summarised as follows:

Description	Capacity
Min ## of Bases Single Cell Setup	1
Max ## of Bases in Multi-cell Setup (configurable)	50/127/254
Single/Multi Cell Setup: Max ## of Repeaters	50 bases and 3 repeater per Base 127 bases and 1 repeater pr Base 254 bases and 0 repeaters
Multi-cell Setup: Total Max ## of Repeaters	100
Max ## of Users (SIP registrations) per Base	30
Max ## of Users per SME VoIP System	limited to 1000
Multi-cell Setup: Max ## of Synchronisation levels	24
Single Cell Setup: Max ## Simultaneous Calls	10 per Base station
Multi-cell Setup: Max ## of Calls	8 per Base station
Total Max ## Simultaneous Calls (Multi-cell Setup)	Limited to 1000
Repeater: Max ## of Calls (Narrow band)	5
Repeater: Max ## of Calls (G722)	2

Quick Definitions

Single Cell Setup:	SME telephony network composed of one base station
Multi-cell Setup:	Telephony network that consists of more than one base station
Synchronisation Level:	Is the air core interface between two base stations.

2.5 Advantages of SME VoIP System

They include (but not limited to):

- 1. Simplicity.** Integrating functionalities leads to reduced maintenance and troubleshooting, and significant cost reductions.
- 2. Flexibility.** Single network architecture can be employed and managed. Furthermore, the architecture is amenable to different deployment scenarios, including isolated buildings for in-building coverage, location with co-located partners, and large to medium scale enterprises deployment for wide coverage.
- 3. Scalability.** SME network architecture can easily be scaled to the required size depending on customer requirement.
- 4. Performance.** The integration of different network functionalities leads to the collapse of the protocol stack in a single network element and thereby eliminates transmission delays between network elements and reduces the call setup time and packet fragmentation and aggregation delays.

3 Installation of Base Stations/Repeater

After planning the network, next is to determine the proper places or location the relevant base stations will be installed. Therefore, we briefly describe the how to install the base station in this chapter.

3.1 Package – Contents/Damage Inspection

Before Package Is Opened:

Examine the shipping package for evidence of physical damage or mishandling prior to opening. If there is a proof of mishandling prior to opening, you must report it to the relevant support centre of the regional representative or operator.

Contents of Package:

Make sure all relevant components are available in the package before proceeding to the next step. Every shipped base unit package/box contains the following items:

- 2 x mounting screws and 2 x Anchors
- 1 x Plastic stand
- Base unit

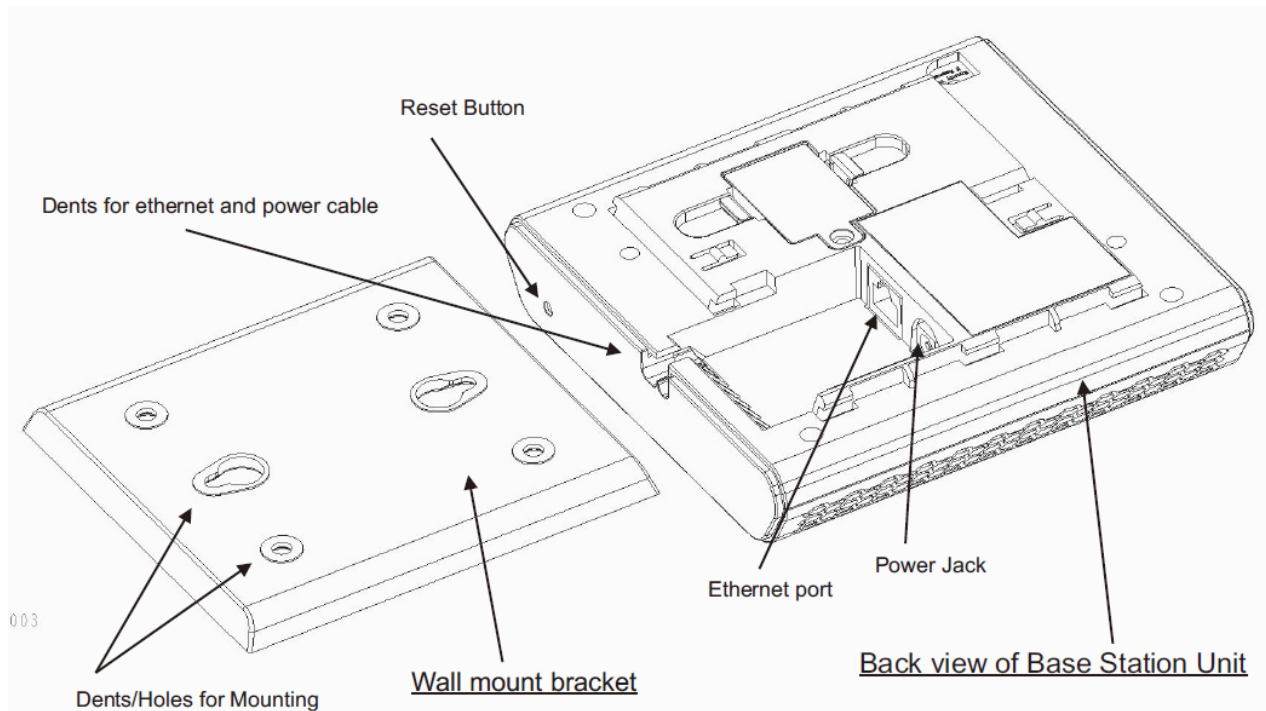

Damage Inspection:

The following are the recommended procedure for you to use for inspection:

1. Examine all relevant components for damage.
2. Make a “defective on arrival – DOA” report or RMA to the operator. Do not move the shipping carton until it has been examined by the operator. If possible send pictures of the damage. The operator/regional representative will initiate the necessary procedure to process this RMA. They will guide the network administrator on how to return the damaged package if necessary.
3. If no damage is found then unwrap all the components and dispose of empty package/carton(s) in accordance with country specific environmental regulations.

3.2 RTX Base station Mechanics

The base station front end shows an LED indicator that signals different functional states of the base unit and occasionally of the overall network. The indicator is off when the base unit is not powered.

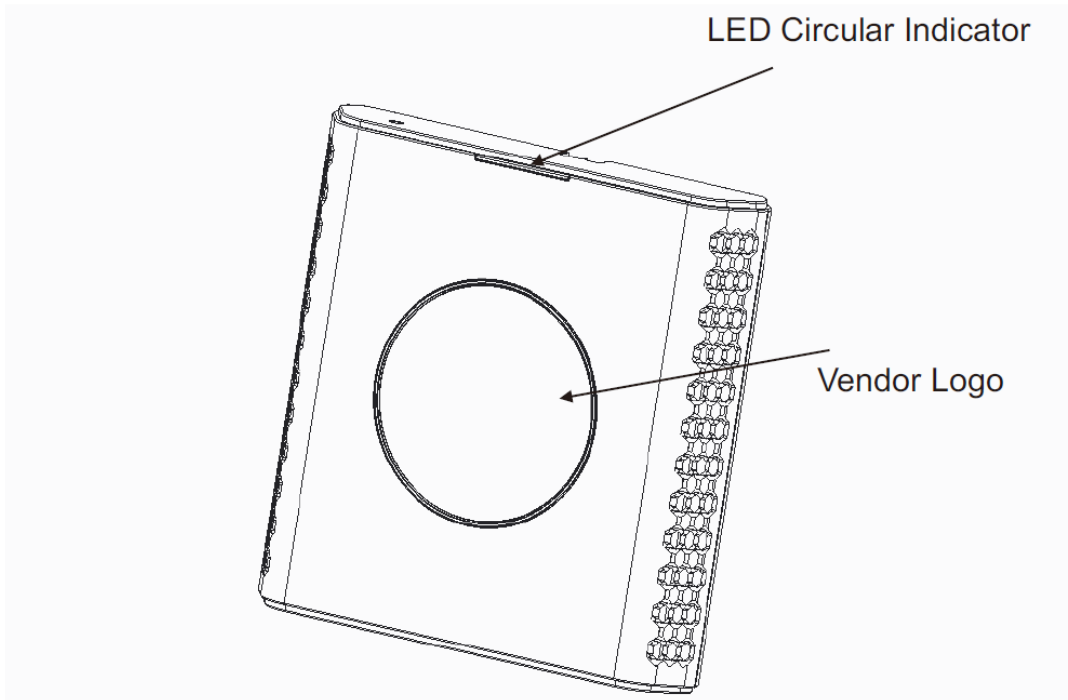

The table below summarises the various LED states:

LED State	State
Unlit	No power in unit
Unlit/Solid red	Error condition
Blinking green	Initialisation
Solid red	Factory reset warning or long press in BS reset button
Blinking red	Factory setting in progress
Solid green	Ethernet connection available (Normal operation)
Blinking red	Ethernet connect not available OR handset de/registration failed
Solid red	Critical error (can only be identified by RTX Engineers). Symptoms include no system/SIP debug logs are logged, etc.
Orange	Press reset button of base station.
Blinking orange	No IP address received

3.3 RTX Base Unit – Reset feature

It is possible to restart or reset the base station unit by pressing a knob at the rear side of the unit. Alternatively, it can be reset from the SME Configuration Interface. We do not recommend this; but unplugging and plugging the Ethernet cable back to the PoE port of the base station also resets the base unit.

3.4 Installing the Base Station

First determine the best location that will provide an optimal coverage taking account the construction of the building, architecture and choice of building materials.

Next, mount the Base Station on a wall to cover range between 50 – 300 meters (i.e. 164 to 984 feet), depending whether it's an indoor or outdoor installation. Please refer to chapter 10 for important information regarding network requirements, deployment considerations, site planning, cell coverage/capacity planning, environmental considerations and recommended Base station placement.

3.4.1 Mounting the Base Stations/Repeaters:

We recommend the base station be mounted an angle other than vertical on both concrete/wood/plaster pillars and walls for optimal radio coverage. Avoid mounting the base units upside down as it significantly reduces radio coverage.

Mount the base unit as high as possible to clear all nearby objects (e.g. office cubicles and cabinets, etc.). Occasionally extend coverage to remote offices/halls with lower telephony users by installing Repeaters.

Make sure that when you fix the base stations with screws, the screws do not touch the PCB on the unit. Secondly, avoid all contacts with any high voltage lines.

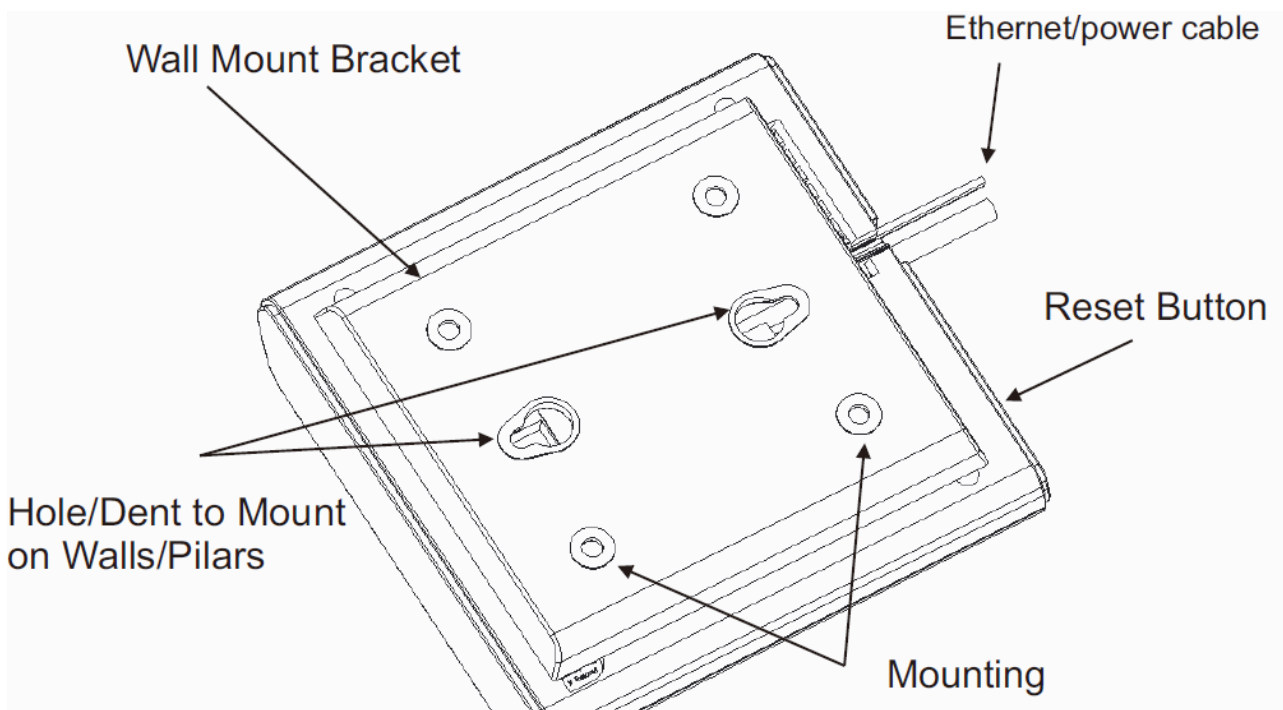

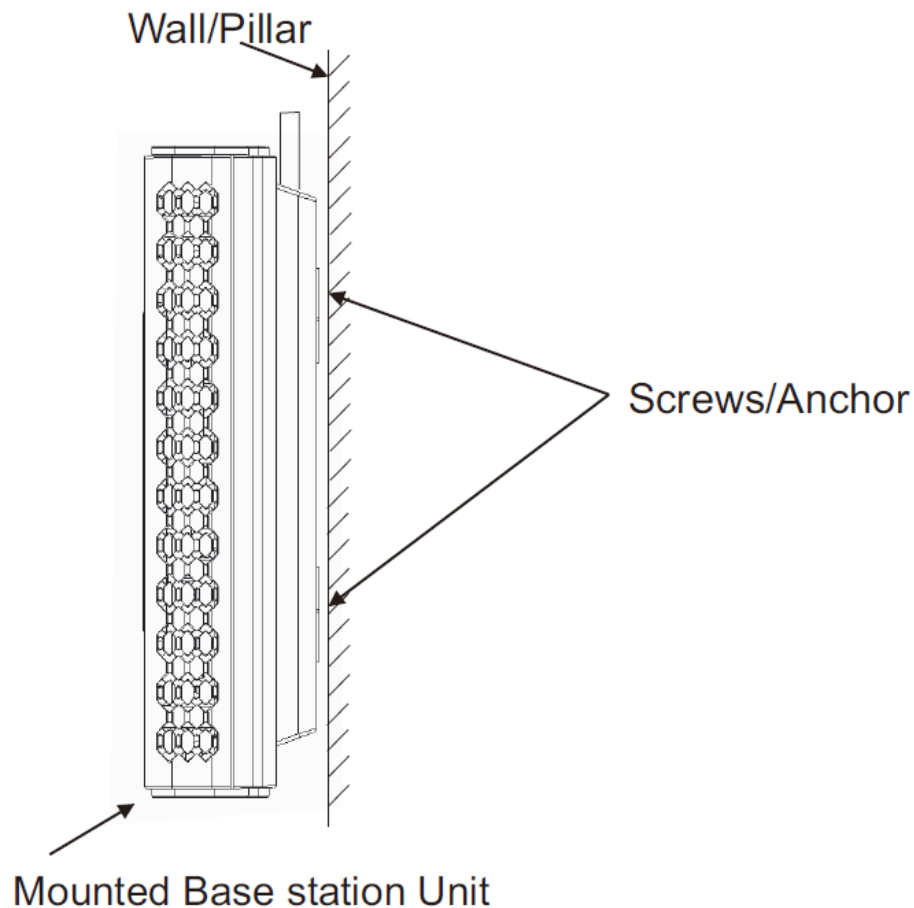

3.5 Find IP of Base Station

To find IP of the installed base station two methods can be used; Using handset Find IP feature or browser IPDECT feature.

3.5.1 Using handset Find IP feature

On the handset press “Menu” key followed by the keys: *47* to get the handset into find bases menu. The handset will now scan for 8663 bases. Depending on the amount of powered on bases with active radios and the distance to the base it can take up to minutes to find a base.

- Use the cursor down/up to select the base MAC address for the base
- The base IP address will be shown in the display

The feature is also used for deployment. For further details refer to reference [2].

3.5.2 Using browser IPDECT

Open any standard browser and enter the address:

<http://ipdect<MAC-Address-Base-Station>>

for e.g. <http://ipdect00087B00AA10>. This will retrieve the HTTP Web Server page from the base station with hardware address **00087B00AA10**.

This feature requires an available DNS server.

3.6 Login to Base SME Configuration Interface

- STEP 1** Connect the Base station to a private network via standard Ethernet cable (CAT-5).
- STEP 2** Use the IP find menu in the handset (Menu * 4 7 *) to determine the IP-address of the base station by matching the MAC address on the back of the base station with the MAC address list in the handset.
- STEP 3** On the Login page, enter your authenticating credentials (i.e. username and password). By default the username and password is **admin**. Click **OK** button.



- STEP 4** Once you have authenticated, the browser will display front end of the SME Configuration Interface. The front end will show relevant information of the base station.

SME (RTX Chain Canteen- static IP)

<ul style="list-style-type: none"> Home/Status Extensions Servers Network Management Firmware Update Time Country Security Central Directory Multi cell Repeaters Alarm Statistics Configuration Syslog SIP Log Logout 	<h4 style="margin: 0;">Welcome</h4> <table style="width: 100%; border: none;"> <tr> <td style="width: 50%; vertical-align: top;"> <p>System Information:</p> <p>Phone Type: System Type: RF Band: Current local time: Operation time: RFPI Address: MAC Address: IP Address: Firmware Version: Firmware URL:</p> </td> <td style="width: 50%; vertical-align: top;"> <p>Multi cell Ready(Keep Alive) Secondary</p> <p>IPDECT Generic SIP (RFC 3261) Unknown (F/R/C0/C1) (00/00/00/7f) 19/Mar/2015 14:11:42 2 Days 20:21:07 (H:M:S) 116E61A600; RPN:00 00087b085f51 192.168.11.90 IPDECT/03.24/B0005/16-Mar-2015 13:07 Firmware update server address: 10.1.24.101 Firmware path: /Fwutest</p> </td> </tr> </table> <p>Base Station Status: Idle</p> <p>SIP Identity Status on this Base Station:</p> <p>Press button to reboot.</p> <div style="display: flex; justify-content: space-around;"> Reboot Forced Reboot </div>	<p>System Information:</p> <p>Phone Type: System Type: RF Band: Current local time: Operation time: RFPI Address: MAC Address: IP Address: Firmware Version: Firmware URL:</p>	<p>Multi cell Ready(Keep Alive) Secondary</p> <p>IPDECT Generic SIP (RFC 3261) Unknown (F/R/C0/C1) (00/00/00/7f) 19/Mar/2015 14:11:42 2 Days 20:21:07 (H:M:S) 116E61A600; RPN:00 00087b085f51 192.168.11.90 IPDECT/03.24/B0005/16-Mar-2015 13:07 Firmware update server address: 10.1.24.101 Firmware path: /Fwutest</p>
<p>System Information:</p> <p>Phone Type: System Type: RF Band: Current local time: Operation time: RFPI Address: MAC Address: IP Address: Firmware Version: Firmware URL:</p>	<p>Multi cell Ready(Keep Alive) Secondary</p> <p>IPDECT Generic SIP (RFC 3261) Unknown (F/R/C0/C1) (00/00/00/7f) 19/Mar/2015 14:11:42 2 Days 20:21:07 (H:M:S) 116E61A600; RPN:00 00087b085f51 192.168.11.90 IPDECT/03.24/B0005/16-Mar-2015 13:07 Firmware update server address: 10.1.24.101 Firmware path: /Fwutest</p>		

4 Making Handset Ready

In this chapter we briefly describe how to prepare the handset for use, install, insert and charge new batteries. Please refer to an accompanying Handset User Guide for more information of the features available in the Handset.

4.1 Package – Contents/Damage Inspection

Before Package Is Opened:

Examine the shipping package for evidence of physical damage or mishandling prior to opening. If there is a proof of mishandling prior to opening, you must report it to the relevant support centre of the regional representative or operator.

Contents of Package:

Make sure all relevant components are available in the package before proceeding to the next step.

Every shipped base unit package/box contains the following items:

- 2 x mounting screws and 2 x Anchors
- 1 x Handset hook
- 1 x A/C Adaptor
- 1 x Battery
- 1 x charger
- 1 x Handset Unit, 1 x Battery cover

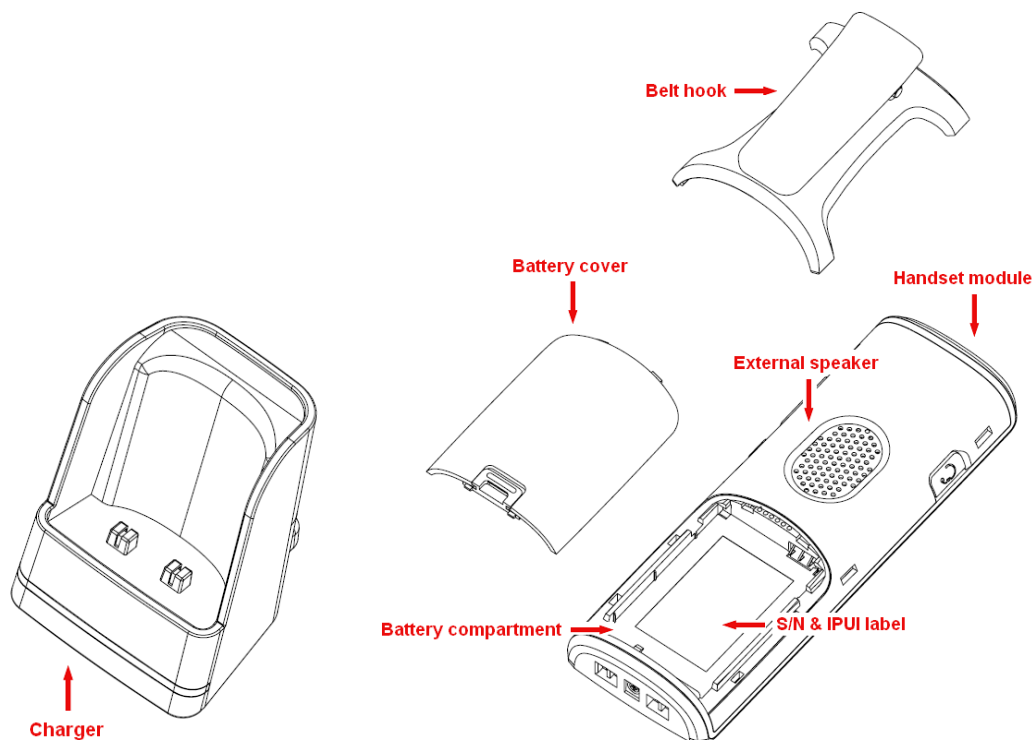

Damage Inspection:

The following are the recommended procedure for you to use for inspection:

1. Examine all relevant components for damage.
2. Make a “defective on arrival – DOA” report or RMA to the operator. Do not move the shipping carton until it has been examined by the operator. The operator/regional representative will initiate the necessary procedure to process this RMA. They will guide the network administrator on how to return the damaged package if necessary.
3. If no damage is found then unwrap all the components and dispose of empty package/carton(s) in accordance with country specific environmental regulations.

4.2 Before Using the Phone

Here are the pre-cautions users should read before using the Handset:

Installing the Battery

1. Never dispose battery in fires, otherwise it will explode.
2. Never replace the batteries in potentially explosive environments, e.g. close to inflammable liquids/gases.
3. ONLY use approved batteries and chargers from the vendor or operator.
4. Do not disassemble, customise or short circuit the battery

Using the Charger

Each handset is charged through the use of a handset charger. The charger is a compact desktop unit designed to charge and automatically maintain the correct battery charge levels and voltage.

The charger Handset is powered by AC supply from 110-240VAC that supplies 5.5VDC at 600mA.

When charging the battery for the first time, it is necessary to leave the handset in the charger for at least 10 hours before the battery is fully charged and the handset ready for use.

Handset in the Charger

For correct charging, ensure that the room temperature is between 0°C and 25°C/32°F and 77°F. Do not place the handset in direct sunlight. The battery has a built-in heat sensor which will stop charging if the battery temperature is too high.

If the handset is turned off when placed in charger, only the LED indicates the charging. When handset is turned off, the LED flashes at a low frequency while charging and lights constantly when the charging is finished. There will be response for incoming calls.

If the handset is turned on when charging, the display shows the charging status.

Open Back Cover

1. Press down the back cover and slide it towards the bottom of the handset.
2. Remove Back Cover from Handset

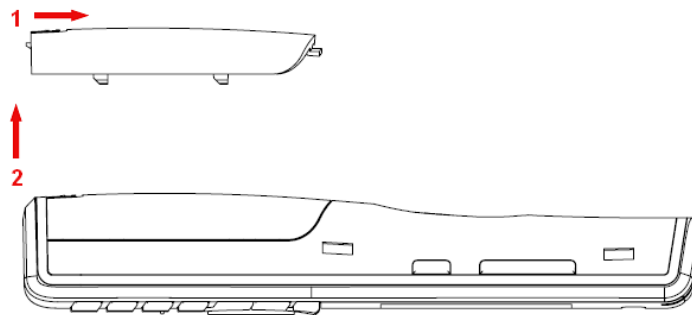

Handset Serial Number

The serial number (IPEI/IPUI number) of each handset is found either on a label, which is placed behind the battery, or on the packaging label. First, lift off handset back cover and lift the battery and read the serial number.

The serial number is needed to enable service to the handset. It must be programmed into the system database via the SME VoIP Configuration interface.

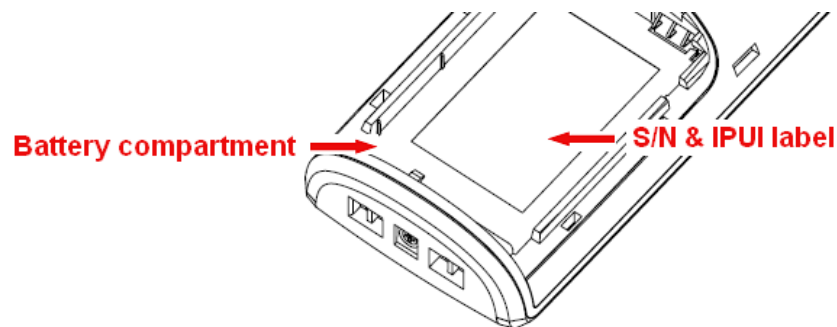

Replace Battery

Remove Back Cover from Handset. Remove the old battery and replace with a new one.

4.3 Using the Handset

Please refer handset manual for detailed description of how to use the handset features [1].

5 SME VoIP Administration Interface

The SME VoIP Administration Interface is also known as SME VoIP Configuration. It is the main interface through which the system is managed and debugged.

The SME VoIP Configuration Interface is an in-built HTTP Web Server service residing in each base station. This interface is a user friendly interface and easy to handle even to a first time user.

Note: Enabling secure web is not possible. For secure configuration use secure provisioning.

This chapter seeks to define various variables/parameters available for configuration in the network.

5.1 Web navigation

We describe the left menu in the front end of the SME VoIP Administration Interface.

The screenshot displays the 'SME VoIP (RTX Chain B202 - 4)' interface. On the left is a dark blue navigation menu with the following items: Home/Status, Extensions, Servers, Network, Management, Firmware Update, Time, Country, Security, Central Directory, Multi cell, Repeaters, Alarm, Statistics, Configuration, Syslog, SIP Log, and Logout. The main content area is titled 'Welcome' and contains the following information:

- System Information:**
 - Phone Type: Multi cell Ready(Keep Alive) Secondary
 - System Type: IPDECT
 - RF Band: Generic SIP (RFC 3261)
 - Current local time: Unknown (F/R/C0/C1) (00/00/00/7f)
 - Operation time: 19/Mar/2015 14:15:10
 - RFPI Address: 2 Days 20:24:38 (H:M:S)
 - MAC Address: 116E61A604; RPN:04
 - IP Address: 00087b079223
 - Firmware Version: 192.168.11.134
 - Firmware URL: IPDECT/03.24/B0005/16-Mar-2015 13:07
 - Base Station Status: Firmware update server address: 10.1.24.101
- SIP Identity Status on this Base Station:**
 - 2676@192.168.11.99 (Asterisk 1) Status: OK
 - 2520@192.168.11.10 (3CX) Status: OK
 - 2689@192.168.11.99 (Asterisk 1) Status: OK
 - 2691@192.168.11.99 (Asterisk 1) Status: OK
- Reboot Options:**
 - Press button to reboot.
 - Buttons: Reboot, Forced Reboot

Feature	Description
Home/Status	This is the front end of the Base station's HTTP web interface. This page shows the summary of current operating condition and settings of the Base station and Handset(s).
Extensions	Administration of extensions and handsets in the system

Servers	On this page the user can define which SIP/NAT server the network should connect to.
Network	<p>Typically the user configures the Network settings from here.</p> <p>NAT provisioning: allows configuration of features for resolving of the NAT – Network Address Translation. These features enable interoperability with most types of routers.</p> <p>DHCP: allows changes in protocol for getting a dynamic IP address.</p> <p>Virtual LAN: specifies the Virtual LAN ID and the User priority.</p> <p>IP Mode: specifies using dynamic (DHCP) or static IP address for your SME network.</p> <p>IP address: if using DHCP leave it empty. Only write in, when you use static IP address.</p> <p>Subnet mask: if using DHCP, leave it empty. Only write in, when you use static IP address.</p> <p>DNS server: specify if using DHCP, leave it empty. Only write in the DNS server address of your Internet service provider, when you use static IP address. (DNS = Dynamic Name Server)</p> <p>Default gateway: if using DHCP, leave it empty. Write in the IP address of your router, when you use static IP address.</p>
Management	Defines the Configuration server address, Management transfer protocol, sizes of logs/traces that should be catalogued in the system.
Firmware Update	Remote firmware updates (HTTP(s)/TFTP) settings of Base stations and handsets.
Time	Here the user can configure the Time server. It should be used as time server in relevant country for exact time. The time servers have to deliver the time to conform to the Network Time Protocol (NTP). Handsets are synchronised to this time. Base units synchronise to the master using the Time server.
Country	<p>Specifying the country/territory where the SME network is located ensures that your phone connection functions properly.</p> <p>Note: The base language and country setting are independent of each other.</p>
Security	The users can administrate certificates and create account credentials with which they can log in or log out of the embedded HTTP web server.
Central Directory	<p>Interface to common directory load of up to 3000 entries using *csv format or configuration of LDAP directory.</p> <p>Note: LDAP and central directory cannot operate at the same time.</p>
Multi cell	Specify to connect base station or chain of base stations to the network. Make sure the system ID for the relevant base stations are the same otherwise the multi-cell feature will not work.
Repeaters	Administration and configuration of repeaters of the system
Alarm	Administration and configuration of the alarm settings on the system. This controls the settings for alarms that can be sent to the handsets. This feature is only available on certain types of handsets.
Statistics	Overview of system and call statistics for a system.
Configuration	This shows detail and complete SME network settings for base station(s), HTTP/DNS/DHCP/TFTP server, SIP server, etc.
Syslog	Overall network related events or logs are displayed here (only live feed is shown).
SIP Log	SIP related logs can be retrieved from url link. It is also possible to clear logs from this feature.

5.2 Home/Status

We describe the parameters found in the Welcome front end home/status of the SME VoIP Administration Interface.

Screenshot

Welcome

System Information:

Phone Type: IPDECT
System Type: Generic SIP (RFC 3261)
RF Band: Unknown (F/R/C0/C1) (00/00/00/7f)
Current local time: 19/Mar/2015 14:15:10
Operation time: 2 Days 20:24:38 (H:M:S)
RFPI Address: 116E61A604; RPN:04
MAC Address: 00087b079223
IP Address: 192.168.11.134
Firmware Version: IPDECT/03.24/B0005/16-Mar-2015 13:07
Firmware URL: Firmware update server address: 10.1.24.101
Firmware path: /Fwutest

Multi cell Ready(Keep Alive) Secondary

Base Station Status: Idle

SIP Identity Status on this Base Station:

[2676@192.168.11.99 \(Asterisk 1\)](#) Status: OK
[2520@192.168.11.10 \(3CX\)](#) Status: OK
[2689@192.168.11.99 \(Asterisk 1\)](#) Status: OK
[2691@192.168.11.99 \(Asterisk 1\)](#) Status: OK

Press button to reboot.

Reboot Forced Reboot

Parameter	Description
System information	This base current multi-cell state
Phone Type	Always IPDECT
System Type	This base customer configuration
RF Band	This base RF band setting. The parameter is defined in production and relates to the radio approvals shown on the label of the base.
Current local time	This base local time
Operation time	Operation is operation time for the base since last reboot
RFPI-Address	This base RFPI address
MAC-Address	This base MAC address
IP-Address	This base IP address
Firmware version	This base firmware version
Firmware URL	Firmware update server address and firmware path on server
Base Station Status	“Idle” : When no calls on base “In use” : When active calls on base
SIP identity status	List of extensions present at this base station. Format: “extension”@“this base IP address”(“server name”) followed by status to the right. Below is listed possible status: OK: Handset is ok SIP Error: SIP registration error
Reboot	Reboot after all connections is stopped on base. Connections are active calls, directory access, firmware update active
Forced Reboot	Reboot immediately.

5.3 Extensions

In this section, we describe the different parameters available whenever the administrator is creating extensions for handsets. Note, it is not possible to add extensions if no servers are defined. As well the section describes the administration of extensions and handsets using the extension list and the extension list menu.

Software supports customer configurations with and without the multiline feature. Section 5.3.1 describes “add extensions” without multiline and 5.3.2 with “multiline”.

The system can handle maximum 1000 extensions matching 1000 handsets which can be divided between servers. When 1000 handsets are registered it is not possible to add more extensions. With active multiline feature the system can handle maximum 1000 extensions. With 4 active lines in multiline maximum 200 handsets can be active in the system.

Note: Within servers or even with multi servers, extensions must always be unique. This means same extension number on server 1 cannot be re-used on server 2.

5.3.1 Add extension (no multiline)

Screenshot

Parameter	Default Value(s)	Description
Extension	Empty	Handset phone number or SIP username depending on the setup. Possible value(s): 8-bit string length Example: 1024, etc. Note: The Extension must also be configured in SIP server in order for this feature to function.
Authentication User Name	Empty	Username: SIP authentication username Permitted value(s): 8-bit string length

Authentication Password	Empty	Password: SIP authentication password. Permitted value(s): 8-bit string length
Display Name	Empty	Human readable name used for the given extension Permitted value(s): 8-bit string length
Mailbox Name	Empty	Name of centralised system used to store phone voice messages that can be retrieved by recipient at a later time. Valid Input(s): 8-bit string Latin characters for the Name
Mailbox Number	Empty	Dialled mail box number by long key press on key 1. Valid Input(s): 0 – 9, *, # Note: Mailbox Number parameter is available only when it's enabled from SIP server.
Server	Server 1 IP	FQDN or IP address of SIP server. Drop down menu to select between the defined Servers of SME VoIP Service provider.
Call waiting feature:	Enabled	Used to enable/disable Call Waiting feature. When disabled a second incoming call will be rejected. If enabled a second call will be presented as call waiting.
Broadsoft Feature Event Package	Disabled	If enabled the given SIP extension subscribes for the Broadsoft Application Server Feature Event Package, and it becomes ready for reception of SIP NOTIFY with status on the following Broadsoft Server Services: -Do Not Disturb -Call Forwarding (Always, Busy, No answer) The received status will be displayed in the handset idle display. Reference section 5.3.3
Forwarding Unconditional Number	Empty	Number to which incoming calls must be re-routed to irrespective of the current state of the handset. Forwarding Unconditional must be enabled to function. Note: Feature must be enabled in the SIP server before it can function in the network
	Disabled	
Forwarding No Answer Number	Empty	Number to which incoming calls must be re-routed to when there is no response from the SIP end node. Forwarding No Answer Number must be enabled to function. Note: Feature must be enabled in the SIP server before it can function in the network Specify delay from call to forward in seconds.
	Disabled	
	90	
Forwarding On Busy Number	Empty	Number to which incoming calls must be re-routed to when SIP node is busy. Forwarding On Busy Number must be enabled to function. Note: Feature must be enabled in the SIP server before it can function in the network
	Disabled	

5.3.1.1 Extensions list (no multiline)

The added extensions will be shown in the extension lists.

The list can be sorted by any of the top headlines, by mouse click on the headline link.

Extensions

[Add extension](#)
[Stop Registration](#)

<input type="checkbox"/>	Idx	Extension	Display Name	Server	Server Alias	IPEI	State	FW Info	FWU Progress
<input type="checkbox"/>	0	2301	Jacob Jensen	192.168.11.99	Asterisk	1188704544	SIP Registered@RPN00	316.1	Complete
<input checked="" type="checkbox"/>	1	2302	Peter Hansen	192.168.11.99	Asterisk	116E50033D	SIP Registered@RPN00	316.1	Complete
<input type="checkbox"/>	2	2303	Kim Petersen	192.168.11.99	Asterisk	116E5002E4	SIP Registered@RPN00	316.1	Complete
<input checked="" type="checkbox"/>	3	2304	Tim Andersen	192.168.11.99	Asterisk	116E500359	SIP Registered@RPN00	316.1	Complete
<input type="checkbox"/>	4	2305	2305	192.168.11.99	Asterisk	FFFFFFFF			

[Check All /Uncheck All](#)
 With selected: [Delete Handset\(s\)](#) [Register Handset\(s\)](#) [Deregister Handset\(s\)](#)

Parameter	Description
Idx	Select / deselect for delete, register and deregister handsets
Extension	Given extension is displayed
Display Name	Given display name is displayed. If no name given this field will be empty
Server	Server IP or URL
Server Alias	Given server alias is displayed. If no alias given this field will be empty.
IPEI	Handset IPEI. IPEI is unique DECT identification number.
State	SIP registration state – if empty the handset is not SIP registered.
FW info	Firmware version of handset
FWU Progress	Possible FWU progress states: Off: Means sw version is specified to 0 = fwu is off Initializing: Means FWU is starting and progress is 0%. X% : FWU ongoing Verifying X%: FWU writing is done and now verifying before swap "Waiting for charger" (HS) / "Conn. term. wait" (Repeater): All FWU is complete and is now waiting for handset/repeater restart. Complete HS/repeater: FWU complete Error: Not able to fwu e.g. file not found, file not valid etc

5.3.1.2 Handset and extension list top/sub-menus

The handset extension list menu is used to control pairing or deletion of handset to the system (DECT registration/de-registrations) and to control SIP registration/de-registrations to the system.

Above and below the list are found commands for making operations on handsets/and extensions. The top menu is general operations, and the sub menu is always operating on selected handsets/extensions.

Screenshots

[Add extension](#)
[Stop Registration](#)

[Check All /Uncheck All](#)
 With selected: [Delete Handset\(s\)](#) [Register Handset\(s\)](#) [Deregister Handset\(s\)](#)

In the below table each command is described.

Actions	Description
Add extension	Access to the “Add extension” sub menu
Stop Registration	Manually stop DECT registration mode of the system. This prevents any handset from registering to the system
Delete Handset(s)	Deregister selected handset(s), but do not delete the extension(s).
Register Handset(s)	Enable registration mode for the system making it possible to register at a specific extension (selected by checkbox)
Deregister Handset(s)	Deregister the selected handset(s) and delete the extension(s).

Note: By power off the handset the handset will SIP deregister the PBX.

5.3.1.3 Edit Extension (no multiline)

To edit extension use the mouse to click the link of the extension.

Screenshot

Edit extension

Extension:

Authentication User Name:

Authentication Password:

Display Name:

Mailbox Name:

Mailbox Number:

Server:

Call waiting feature:

Forwarding Unconditional Number:

Forwarding No Answer Number: s

Forwarding on Busy Number:

5.3.2 Multiline: Add extension

With active multiline feature the system distinguish between extensions, physical handsets and maximum 4 lines.

To add a physical handset first an extension must be available. The “add extension” is available from the Extension web top.

Screenshot

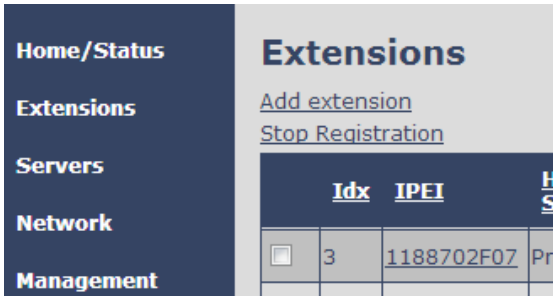

By pressing the link the “add extension” menu will appear. In the following the parameters are explained.

Screenshot

Parameter	Default Value(s)	Description
Line Name	Empty	Name of line shown to be used to show from which line the incoming call is coming and used when user must select from which line to make outgoing call.
Handset	New Handset	The extension must be associated to a handset. By default a new handset can be configured, alternatively the user can select an already existing handset Idx.

Extension	Empty	Handset phone number or SIP username depending on the setup. Possible value(s): 8-bit string length Example: 1024, etc. Note: The Extension must also be configured in SIP server in order for this feature to function.
Authentication User Name	Empty	Username: SIP authentication username Permitted value(s): 8-bit string length
Authentication Password	Empty	Password: SIP authentication password. Permitted value(s): 8-bit string length
Display Name	Empty	Human readable name used for the given extension Permitted value(s): 8-bit string length
Mailbox Name	Empty	Name of centralised system used to store phone voice messages that can be retrieved by recipient at a later time. Valid Input(s): 8-bit string Latin characters for the Name
Mailbox Number	Empty	Dialled mail box number by long key press on key 1. Valid Input(s): 0 – 9, *, # Note: Mailbox Number parameter is available only when it's enabled from SIP server.
Server	Server 1 IP	DNS or IP address of SIP server. Drop down menu to select between the defined Servers of SME VoIP Service provider.
Call waiting feature	Enabled	Used to enable/disable Call Waiting feature. When disabled a second incoming call will be rejected. If enabled a second call will be presented as call waiting.
BroadWorks Shared Call Appearance	Disabled	If enabled the given SIP extension is considered part of a BroadWorks shared call appearance group (SCA). This enables the Shared Call Appearance Settings section on the Handset page for the handset that the extension is connected to. Note: BroadWorks SCAs and their respective extensions must be configured in the BroadWorks application server web interface prior to being added on this page. The extension entered here must match the extension configured in BroadWorks.
Broadsoft Feature Event Package	Disabled	If enabled the given SIP extension subscribes for the Broadsoft Application Server Feature Event Package, and it becomes ready for reception of SIP NOTIFY with status on the following Broadsoft Server Services: -Do Not Disturb -Call Forwarding (Always, Busy, No answer) The received status will be displayed in the handset idle display.
Forwarding Unconditional Number	Empty	Number to which incoming calls must be re-routed to irrespective of the current state of the handset. Forwarding Unconditional must be enabled to function. Note: Feature must be enabled in the SIP server before it can function in the network
Forwarding No Answer Number	Disabled	Number to which incoming calls must be re-routed to when there is no response from the SIP end node. Forwarding No Answer Number must be enabled to function. Note: Feature must be enabled in the SIP server before it can function in the network Specify delay from call to forward in seconds.
	Empty	

Forwarding On Busy Number	Disabled	Number to which incoming calls must be re-routed to when SIP node is busy. Forwarding On Busy Number must be enabled to function. Note: Feature must be enabled in the SIP server before it can function in the network
	90	
	Empty	

The location selection feature, which is available in the add extension screen in non-multiline mode, is moved to edit handset from the handset and extension list. Edit handset screen is found by pressing the handset IPEI link.

Screenshot

Then maximum extensions supported per handset are 4. There are no restrictions for adding more, but only the first four will attempt to SIP register.

5.3.2.1 Multiline: Handset and extensions list

Added handset and extensions will be shown in the extension list.

The extension list is the access to the handset location control and the edit extension feature.

The list can be sorted by any of the top headlines, by mouse click on the headline link.

Screenshot

Idx	IPEI	Handset State	Handset Type FW Info	FWU Progress	VoIP Idx	Extension	Display Name	Server	Server Alias	State	
<input type="checkbox"/>	1	116E5002BD	Present@RPN00 UXP1240H 323.14	Complete	<input type="checkbox"/>	1	6000	KMH1	192.168.11.99		SIP Registered@RPN00
<input type="checkbox"/>	2	1188700CDF	Present@RPN04 8630 323.14	Complete	<input type="checkbox"/>	2	6001	KMH2 - VM	192.168.11.99		SIP Registered@RPN04
<input type="checkbox"/>	3	0255580E77	Present@RPN00 8830 323.14	Complete	<input type="checkbox"/>	3	6002	KMH3	192.168.11.99		SIP Registered@RPN00
<input type="checkbox"/>	4	02555356FA	Present@RPN00 8430 323.14	Complete	<input type="checkbox"/>	4	6003	KMH4	192.168.11.99		SIP Registered@RPN00

Check All / Uncheck All Check All Extensions / Uncheck All Extensions

With selected: Delete Handset(s) Register Handset(s) Deregister Handset(s) Start SIP Registration(s) SIP Delete Extension(s)

Parameter	Description
Idx	Index of handsets
IPEI	Handset IPEI. IPEI is unique DECT identification number.
Handset State	The state of the given handset: Present@RPNxx: The handset is DECT located at the base with RPNxx Detached: The handset is detached from the system (e.g. powered off) Located: The handset is configured to locate on a specific base, but is has not been possible to do so (e.g if the base is powered off) Removed: The handset has been out of sight for a specified amount of time (~one hour).

Handset Type	Name of the handset type
FW Info	Firmware version of handset
FWU Progress	<p>Possible FWU progress states:</p> <p>Off: Means sw version is specified to 0 = fwu is off</p> <p>Initializing: Means FWU is starting and progress is 0%.</p> <p>X% : FWU ongoing</p> <p>Verifying X%: FWU writing is done and now verifying before swap</p> <p>"Waiting for charger" (HS) / "Conn. term. wait" (Repeater): All FWU is complete and is now waiting for handset/repeater restart.</p> <p>Complete HS/repeater: FWU complete</p> <p>Error: Not able to fwu e.g. file not found, file not valid etc</p>
VoIP Idx	Index of the configured SIP extensions. Select/deselect to start SIP registration or delete extension.
Extension	Given extension is displayed
Display Name	Given display name is displayed. If no name given this field will be empty
Server	Server IP or URL
Server Alias	Given server alias is displayed. If no alias given this field will be empty.
State	SIP registration state – if empty the handset is not SIP registered.

5.3.2.2 Multiline: Edit Extension

To edit extension use the mouse to click the link of the extension. Basically the same options are available for edit extension as for add extension.

Screenshot

Edit extension

Line name: Asteris

Handset: Handset Idx: 1

Extension: 2628

Authentication User Name: 2628

Authentication Password: ●●●●●●●●

Display Name: 2628

Mailbox Name:

Mailbox Number:

Server: Server 2: 192.168.11.12

Call waiting feature: Enabled

BroadWorks Shared Call Appearance: Disabled

Broadsoft Feature Event Package: Disabled

Forwarding Unconditional Number: Disabled

Forwarding No Answer Number: Disabled 90 s

Forwarding on Busy Number: Disabled

Save Cancel

5.3.2.3 Multiline: Edit handset

Use the mouse to click the handset IPEI link to open the handset edit window. In the handset edit view the handset SIP location can be fixed to either any or a specific base.

Screenshot

Handset

Location:

IPEI:

AC:

Emergency Line:

Emergency Number:

Emergency Profiles:

Profile	Alarm Type	
Profile 0	Not configured	<input type="checkbox"/>
Profile 1	Not configured	<input type="checkbox"/>
Profile 2	Not configured	<input type="checkbox"/>
Profile 3	Not configured	<input type="checkbox"/>
Profile 4	Not configured	<input type="checkbox"/>
Profile 5	Not configured	<input type="checkbox"/>
Profile 6	Not configured	<input type="checkbox"/>
Profile 7	Not configured	<input type="checkbox"/>

Shared Call Appearance Settings:

Idx	Extension
1	<input type="text" value="Not configured"/>
2	<input type="text" value="Not configured"/>
3	<input type="text" value="Not configured"/>
4	<input type="text" value="Not configured"/>
5	<input type="text" value="Not configured"/>
6	<input type="text" value="Not configured"/>
7	<input type="text" value="Not configured"/>
8	<input type="text" value="Not configured"/>

Parameter	Default Value(s)	Description
Location	ANY	Specify a handset to be located at a specific base station or ANY base station. A location of a handset controls the DECT registration and the SIP registrations. Binding a handset to a specific base will bind the SIP registrations to this base.
IPEI	Handset IPEI	Shows the handset IPEI. For an already registered handset changing the IPEI will deregister the handset at next handset location update.
AC	Handset AC code	Shows the handset AC code. AC code is used at handset registration. Changing the AC code for an already registered handset will have no effect.
Alarm Line	No Alarm Line Selected	The line of multilines to be used for alarm call feature
Alarm Number	Empty	Number to be dialled in case of handset alarm key is pressed (Long keypress > 3 seconds on navigation center key)
Alarm Profiles	Not configured	Check the wanted alarm profiles for the particular handset.
Shared Call Appearance Settings	Not configured	<p>Each of the eight rows in the table represents an SCA status LED on the handset Idle screen. For each row it is possible to specify which shared line an LED should display the state of.</p> <ul style="list-style-type: none"> • Only shared lines can be selected, that is, only extensions defined for the handset for which BroadWorks Shared Call Appearance is enabled are included in the selector. • A shared line can be reused for several LEDs. Each LED with the same shared line then corresponds to different appearance-indexes for that line (1 LED = appearance-index 1, 2 LEDs = appearance-indexes 1 and 2, and so on). <p>It is not necessary to select a shared line for all of the LEDs. If an LED is not assigned a line, its position on the screen is simply empty.</p>

5.3.2.4 Multiline: Handset and extension list top/sub-menus

The handset extension list menu is used to control pairing or deletion of handset to the system (DECT registration/de-registrations) and to control SIP registration/de-registrations to the system. Above and below the list are found commands for making operations on handsets/and extensions. The top menu is general operations, and the sub menu is always operating on selected handsets/extensions.

Screenshots

[Add extension](#)
[Stop Registration](#)

[Check All / Uncheck All](#) [Check All Extensions / Uncheck All Extensions](#)
With selected: Delete Handset(s) Register Handset(s) Deregister Handset(s) Start SIP Registration(s) SIP Delete Extension(s)

In the below table each command is described.

Actions	Description
Add extension	Access to the “Add extension” sub menu
Stop Registration	Manually stop DECT registration mode of the system. This prevents any handset from registering to the system
Delete Handset(s)	Deregister selected handset(s), but do not delete the extension(s).
Register Handset(s)	Enable registration mode for the system making it possible to register at a specific extension (selected by checkbox)
Deregister Handset(s)	Deregister the selected handset(s) and delete the extension(s).
Start SIP Registration(s)	Manually start SIP registration for selected handset(s).
SIP Delete Extension(s)	Deregister the selected handset(s) and delete the extension(s).

After creation of extensions check the handset Idx and click “Register Handset(s)” to DECT register the handset to the base. First SIP registration is made by the system automatically by the handset DECT registration procedure. For new extensions click “Start SIP Registration(s)” to SIP register the extensions to the defined server.

Screenshot

Use the same procedure for other handsets, where the reference is the idx. no. when adding new extensions to existing handsets.

5.3.3 Broadsoft Feature Event Package

If enabled the given SIP extension subscribes for the Broadsoft Application Server Feature Event Package, and it becomes ready for reception of SIP NOTIFY with status on the following Broadsoft Server Services:

- Do Not Disturb
- Call Forwarding (Always, Busy, No answer)

The received status will be displayed in the handset idle display.

After pressing save the extension screen will appear with removed configuration option for the forward feature as shown in the below picture.

Note: Call forwarding can as well be configured from the handset by the user (for operation refer to the handset guide).

Screenshot

Call waiting feature:

Broadsoft Feature Event Package:

Forwarding Unconditional Number:

Forward No Answer Number: s

Forwarding on Busy Number:

5.4 Servers

In this section, we describe the different parameters available in the Servers configurations menu. Maximum 10 servers can be configured.

Screenshot

Servers

- Asterisk_1:** 192.168.11.99
- 3CX:** 192.168.11.10
- Siemens:** 192.168.11.12
- Asterisk_2:** 192.168.11.99
- Dandial:** 62.61.147.218
- Server 6:** 192.168.111.222
- Server 7:** 111.222.333.444

[Add Server](#)
[Remove Server](#)

Asterisk_1:

Server Alias:

NAT Adaption:

Registrar:

Outbound Proxy:

Conference Server:

Call Log Server:

Reregistration time (s):

SIP Session Timers:

Session Timer Value (s):

SIP Transport:

Signal TCP Source Port:

Use One TCP Connection per SIP Extension:

RTP from own base station:

Keep Alive:

Show Extension on Handset Idle Screen:

Hold Behaviour:

Attended Transfer Behaviour:

Use Own Codec Priority:

DTMF Signalling:

DTMF Payload Type:

Remote Caller ID Source Priority:

Codec Priority:

RTP Packet Size:

Secure RTP:

Secure RTP Auth:

SRTP Crypto Suites:

Parameter	Default value	Description
Server Alias	Empty	Parameter for server alias
NAT Adaption	Disabled	To ensure all SIP messages goes directly to the NAT gateway in the SIP aware router.

		<p>If the system receives a SIP response to a REGISTER request with a “Via” header that includes the “received” parameter (ex: “Via: SIP/2.0/UDP 10.1.1.1:4540;received=68.44.20.1”), the base will adapt its contact information to the IP address from the “received” parameter. Thus, the base will issue another REGISTER request with the updated contact information. If NAT Adaption is disabled, the “received” parameter is ignored.</p>
Registrar	Empty	<p>SIP Server proxy DNS or IP address Permitted value(s): AAA.BBB.CCC.DDD:<Port-Number> or <URL>:<Port-Number> Note: Specifying the Port Number is optional.</p>
Outbound Proxy	Empty	<p>This is a Session Border Controller DNS or IP address (OR SIP server outbound proxy address) Set the Outbound proxy to the address and port of private NAT gateway so that SIP messages sent via the NAT gateway. Permitted value(s): AAA.BBB.CCC.DDD or <URL> or <URL>:<Port-Number> Examples: “192.168.0.1”, “192.168.0.1:5062”, “nat.company.com” and “sip:nat@company.com:5065”. If empty call is made via Registrar.</p>
Conference Server	Empty	<p>Broadsoft conference feature. Set the IP address of the conference server. In case an IP is specified pressing handset conference will establish a connection to the conference server. If the field is empty the original 3-party local conference on 8630 is used.</p>
Call Log Server	Empty	<p>Broadsoft call log feature. Set the IP address of the XSI call log server. In case an IP is specified pressing handset will use the call log server. If the field is empty the local call log is used</p>
Re-registration time	600	<p>The “expires” value 36nalyse36n in SIP REGISTER requests. This value indicates how long the current SIP registration is valid, and hence is specifies the maximum time between SIP registrations for the given SIP account. Permitted value(s): A value below 60 sec is not recommended, Maximum value 65636</p>
SIP Session Timers:	Disabled	<p>RFC 4028. A “keep-alive” mechanism for calls. The session timer value specifies the maximum time between “keep-alive” or more correctly session refresh signals. If no session refresh is received when the timer expires the call will be terminated. Default value is 1800 s according to the RFC. Min: 90 s. Max: 65636. If disabled session timers will not be used.</p>
Session Timer Values (s):	1800	<p>Default value is 1800s according to the RFC. If disabled session timers will not be used. Permitted value(s): Minimum value 90, Maximum 65636</p>

SIP Transport	UDP	Select UDP, TCP, TLS 1.0
Signal TCP Source Port	Disabled	When SIP Transport is set to TCP or TLS, a TCP (or TLS) connection will be established for each SIP extension. The source port of the connection will be chosen by the TCP stack, and hence the local SIP port parameter, specified within the SIP/RTP Settings (see 5.5.5) will not be used. The "Signal TCP Source Port" parameter specifies if the used source port shall be signaled explicitly in the SIP messages.
Use One TCP/TLS Connection per SIP Extension:	Disabled	When using TCP or TLS as SIP transport, choose if a TCP/TLS connection shall be established for each SIP extension or if the base station shall establish one connection which all SIP extensions use. Please note that if TLS is used and SIP server requires client authentication (and requests a client certificate), this setting must be set to disabled. 0: Disabled. (Use one TCP/TLS connection for all SIP extensions) 1: Enabled. (Use one TCP/TLS connection per SIP extensions).
RTP from own base station:	Disabled	If disabled RTP stream will be send from the base, where the handset is located. By enable the RTP stream will always be send from the base, where the SIP registration is made. This setting is typically enabled for operation with Cisco.
Keep Alive	Enabled	This directive defines the window period (30 sec.) to keep opening the port of relevant NAT-aware router(s), etc.
Show Extension on Handset Idle Screen	Enabled	If enabled extension will be shown on handset idle screen.
Hold Behaviour	RFC 3264	Specify the hold behaviour by handset hold feature. RFC 3264: Hold is signalled according to RFC 3264, i.e. the connection information part of the SDP contains the IP Address of the endpoint, and the direction attribute is sendonly, recvonly or inactive dependant of the context RFC 2543: The "old" way of signalling HOLD. The connection information part of the SDP is set to 0.0.0.0, and the direction attribute is sendonly, recvonly or inactive dependant of the context
Attended Transfer Behaviour	Hold 2 nd Call	When we have two calls, and one call is on hold, it is possible to perform attended transfer. When the transfer soft key is pressed in this situation, we have traditionally also put the active call on hold before the SIP REFER request is sent. However, we have experienced that some PBXes do not expect that the 2nd call is put on hold, and therefore attended transfer fails on these PBXes. The "Attended Transfer Behavior" feature defines whether or not the 2nd call shall be put on hold before the REFER is sent.

		<p>If "Hold 2nd Call" is selected, the 2nd call will be held before REFER is sent.</p> <p>If "Do Not Hold 2nd Call" is selected, the 2nd call will not be held before the REFER is sent</p>
Use Own Codec Priority	Disabled	<p>Default disabled.</p> <p>By enable the system codec priority during incoming call is used instead of the calling party priority.</p> <p>E.g. If base has G722 as top codec and the calling party has Alaw on top and G722 further down the list, the G722 will be chosen as codec for the call.</p>
DTMF Signalling	RFC 2833	<p>Conversion of decimal digits (and '*' and '#') into sounds that share similar characteristics with voice to easily traverse networks designed for voice</p> <p>SIP INFO: Carries application level data along SIP signalling path (e.g.: Carries DTMF digits generated during SIP session OR sending of DTMF tones via data packets in the <u>same</u> internet layer as the Voice Stream, etc.).</p> <p>RFC 2833: DTMF handling for gateways, end systems and RTP trunks (e.g.: Sending DTMF tones via data packets in <u>different</u> internet layer as the voice stream)</p> <p>Both: Enables SIP INFO and RFC 2833 modes.</p>
DTMF Payload Type	101	This feature enables the user to specify a value for the DTMF payload type / telephone event (RFC2833).
Remote Caller ID Source Priority	FROM	<p>SIP information field used for Caller ID source:</p> <p>PAI - FROM</p> <p>FROM</p> <p>ALERT_INFO - PAI - FROM</p>
Codec Priority	G.711U G.711A G.726	<p>Defines the codec priority that base stations uses for audio compression and transmission.</p> <p>Possible Option(s): G.711U,G.711A, G.726, G.729, G.722.</p> <p>Note: Modifications of the codec list must be followed by a "reset codes" and "Reboot chain" on the multipage in order to change and update handsets.</p> <p>Note:</p> <p>With G.722 as first priority the number of simultaneous calls per base station will be reduced from 10 (8) to 4 calls.</p> <p>With G.722 in the list the codec negotiation algorithm is active causing the handset (phone) setup time to be slightly slower than if G.722 is removed from the list.</p> <p>With G.729 add on DSP module for the base is required.</p> <p>Contact RTX sales for purchase number 96101203.</p>
RTP Packet size	20ms	<p>The packet size offered as preferred RTP packet size by 8630 when RTP packet size negotiation.</p> <p>Selections available: 20ms, 40ms, 60ms, 80ms</p>
Secure RTP	Disabled	With enable RTP will be encrypted (AES-128) using the key negotiated via the SDP protocol at call setup.
Secure RTP Auth	Disabled	<p>With enable secure RTP is using authentication of the RTP packages.</p> <p>Note: with enabled SRTP authentication maximum 4</p>

		concurrent calls is possible per base in a single or multicell system.
SRTP Crypto Suites	AES_CM_128_HMAX_SHA1_32 AES_CM_128_HMAX_SHA1_80	Field list of supported SRTP Crypto Suites. The device is born with two suites.

Note: Within servers or even with multi servers, extensions must always be unique. This means same extension number on server 1 cannot be re-used on server 2.

5.5 Network

In this section, we describe the different parameters available in the network configurations menu.

5.5.1 IP Settings

Screenshot

IP settings

DHCP/Static IP:

IP Address:

Subnet Mask:

Default gateway:

DNS (primary):

DNS (secondary):

Parameter	Default Values	Description
DHCP/Static IP	DHCP	If DHCP is enabled, the device automatically obtains TCP/IP parameters. Possible value(s): Static, DHCP DHCP: IP addresses are allocated automatically from a pool of leased address. Static IP: IP addresses are manually assigned by the network administrator. If the user chooses DHCP option, the other IP settings or options are not available.
IP Address	NA	32-bit IP address of device (e.g. base station). 64-bit IP address will be supported in the future. Permitted value(s): AAA.BBB.CCC.DDD
Subnet Mask	NA	Is device subnet mask. Permitted value(s): AAA.BBB.CCC.DDD This is a 32-bit combination used to describe which portion an IP address refers to the subnet and which part refers to the host. A network mask helps users know which portion of the address identifies the network and which portion of the address identifies the node.
Default Gateway	NA	Device's default network router/gateway (32-bit). Permitted value(s): AAA.BBB.CCC.DDD e.g. 192.168.50.0 IP address of network router that acts as entrance to other network. This device provides a default route for TCP/IP hosts to use when communicating with other hosts on hosts networks.
DNS (Primary)	NA	Main server to which a device directs Domain Name System (DNS) queries. Permitted value(s): AAA.BBB.CCC.DDD or <URL> This is the IP address of server that contains mappings of DNS domain names to various data, e.g. IP address, etc. The user needs to specify this option when static IP address option is chosen.
DNS (Secondary)	NA	This is an alternate DNS server.

5.5.2 VLAN Settings

Enable users to define devices (e.g. Base station, etc.) with different physical connection to communicate as if they are connected on a single network segment.

The VLAN settings can be used on a managed network with separate Virtual LANs (VLANs) for sending voice and data traffic. To work on these networks, the base stations can tag voice traffic it generates on a specific “voice VLAN” using the IEEE 802.1q specification.

Screenshot

Parameter	Default Values	Description
VLAN id	0	Is a 12 bit identification of the 802.1Q VLAN. Permitted value(s): 0 to 4094 (only decimal values are accepted) A VLAN ID of 0 is used to identify priority frames and ID of 4095 (i.e. FFF) is reserved. Null means no VLAN tagging or No VLAN discovery through DHCP.
VLAN User Priority	0	This is a 3 bit value that defines the user priority. Values are from 0 (best effort) to 7 (highest); 1 represents the lowest priority. These values can be used to prioritize different classes of traffic (voice, video, data, etc). Permitted value(s): 8 priority levels (i.e. 0 to 7)
VLAN Synchronization	Disabled	Default disabled. By enabled the VLAN ID is automatic synchronised between the bases in the chain. Bases will be automatic rebooted during the synchronization.

For further help on VLAN configuration refer to Appendix.

5.5.3 DHCP Options

Screenshot

Parameter	Default Values	Description
Plug-n-Play	Disabled	Enabled: DHCP option 66 to automatically provide PBX IP address to base.

5.5.4 NAT Settings

We define some options available when NAT aware routers are enabled in the network.

Screenshot

Parameter	Default Values	Description
Enable STUN	Disabled	Enable to use STUN
STUN Server	NA	Permitted value(s): AAA.BBB.CCC.DDD (Currently only Ipv4 are supported) or url (e.g.: firmware.rtx.net).
STUN Bindtime Determine	Enabled	
STUN Bindtime Guard	80	Permitted values: Positive integer default is 90, unit is in seconds
Enable RPORT	Disabled	Enable to use RPORT in SIP messages.
Keep alive time	90	This defines the frequency of how keep-alive are sent to maintain NAT bindings. Permitted values: Positive integer default is 90, unit is in seconds

5.5.5 SIP/RTP Settings

These are some definitions of SIP/RTP settings:

Screenshot

Parameter	Default Values	Description
Use Different SIP Ports	Disabled	If disabled, the Local SIP port parameter specifies the source port used for SIP signalling in the system. If enabled, the Local SIP Port parameter specifies the source port used for first user agent (UA) instance. Succeeding UA's will get succeeding ports.

RTP Collision Detection	Enabled	Enable: If two sources with same SSRC, the following RTX is discarded. Disabled: No check – device will accept all sources.
Local SIP port	5060	The source port used for SIP signalling Permitted values: Port number default 5060.
SIP ToS/QoS	0x68	Priority of call control signalling traffic based on both IP Layers of Type of Service (ToS) byte. ToS is referred to as Quality of Service (QoS) in packet based networks. Permitted values: Positive integer, default is 0x68
RTP port	50004	The first RTP port to use for RTP audio streaming. Permitted values: Port number default 50004 (depending on the setup).
RTP port range	40	The number of ports that can be used for RTP audio streaming. Permitted values: Positive integers, default is 40
RTP TOS/QoS	0xB8	Priority of RTP traffic based on the IP layer ToS (Type of Service) byte. ToS is referred to as Quality of Service (QoS) in packet based networks. See RFC 1349 for details. “cost bit” is not supported. <ul style="list-style-type: none"> o Bit 7..5 defines precedence. o Bit 4..2 defines Type of Service. o Bit 1..0 are ignored. Setting all three of bit 4..2 will be ignored. Permitted values: Positive integer, default is 0xB8

5.6 Management Settings Definitions

The administrator can configure base stations to perform some specific functions such as configuration of file transfers, firmware up/downgrades, password management, and SIP/debug logs.

Screenshot

Management Settings

Base Station Name: SME VoIP

Management Transfer Protocol: TFTP

HTTP Management upload script: /CfgUpload

HTTP Management password:

Configuration Server Address:

Base Specific File:

Multi Cell Specific File:

Configuration File Download: Base Specific File

DHCP Controlled Config Server: DHCP Option 66

DHCP Custom Option:

DHCP Custom Option Type:

Text Messaging: Enabled Without Server

Text Messaging & Alarm Server:

Text Messaging Port: 1300

Text Messaging Keep Alive (m): 30

Text Messaging Response (s): 30

Text Messaging TTL: 0

SIP Log Server Address:

Upload of SIP Log: Disabled

Syslog Server IP Address:

Syslog Server Port: 514

Syslog Level: Normal Operation

Enable Automatic Prefix: Disabled

Set Maximum Digits of Internal Numbers: 0

Set Prefix for Outgoing Calls:

Save and Reboot Save Cancel Default Base Station

Parameter	Default value	Description
Base Station Name:	SME VoIP	It indicates the title that appears at the top window of the browser and is used in the multicell page. Maximum characters: 35
Management Transfer Protocol	TFTP	The protocol assigned for configuration file and central directory Valid Input(s): TFTP, HTTP, HTTPs
HTTP	Empty	The folder location or directory path that contains the configuration

Management upload script		files of the Configuration server. The configuration upload script is a file located in e.g. TFTP server or Apache Server which is also the configuration server. Permitted value(s): /<configuration-file-directory> Example: /CfgUpload Note: Must begin with (/) slash character. Either / or \ can be used.
HTTP Management password	Empty	Password that should be entered in order to have access to the configuration server. HTTP client credentials are formed by “User name” and the “HTTP Management password”. Permitted value(s): 8-bit string length
Configuration server address	Empty	Server/device that provides configuration file to base station. Type: DNS or IP address Permitted value(s): AAA.BBB.CCC.DDD or <URL>
Base Specific File	Empty	Base configuration file
Multi Cell Specific File	Empty	The file name must be the chain id of the system. E.g 00087b0a00b3.cfg Permitted value(s): Format of file is chain ID.cfg
Configuration File Download	Disabled	Base Specific file: Used when configuring a single cell base Multicell Specific File: Used when configuring a multicell based system Base and Multicell Specific File: Used on out of factory bases to specify VLAN and Multicell ID and settings.
DHCP Controlled Config Server	Disabled	Provisioning server options. DHCP Option 66: Look for provision file by TFTP boot up server. DHCP Custom Option: Look for provision file by custom option DHCP Custom Option & Option 66: Look for provision file by first custom option and then option 66.
DHCP Custom Option	Empty	By default option 160, but custom option can be defined. An option 160 URL defines the protocol and path information by using a fully qualified domain name for clients that can use DNS.
DHCP Custom Option Type	Empty	URL: URL of server with path. Example of URL: http://myconfigs.com:5060/configs Default configuration file on server must follow the name: MAC.cfg IP Address: IP of server with path.
Text Messaging	Disabled	Disable/enable messaging with Mobicall server The third option is to “Enable Without Server”. With this setting handset can send messages to other handsets, which support messaging. Note: Contact Mobicall to get the proper version and setup for Mobicall server
Text Messaging & Alarm server	Empty	Permitted value(s): AAA.BBB.CCC.DDD or <URL>
Text Messaging Port	1300	Port number of message server.
Text Messaging Keep Alive	30	This defines the frequency of how keep-alive are sent Permitted values: Positive integer, unit is in minutes

(m)		
Text Messaging Response (s)	30	This defines the frequency of how response timeout Permitted values: Positive integer, unit is in seconds
Text Messaging TTL	0	This defines the text messaging time to live Permitted values: Positive integer, unit is in seconds
SIP Log Server Address	Empty	Permitted value(s): AAA.BBB.CCC.DDD or <URL> Requires a predefined folder named: \SIP
Upload of SIP Log	Disabled	Enable this option to save low level SIP debug messages to the server. The SIP logs are saved in the file format: <MAC_Address><Time_Stamp>SIP.log
Syslog Server IP-Address	Empty	Permitted value(s): AAA.BBB.CCC.DDD or <URL>
Syslog Server Port	Empty	Port number of syslog server.
Syslog Level	Off	Off: No data is saved on syslog server Normal Operation: Normal operation events are logged, incoming call, outgoing calls, handset registration, DECT location, and call lost due to busy, critical system errors, general system information. System Analyze: Handset roaming, handset firmware updates status. The system 46nalyse level also contains the messages from normal operation. Debug: Used by RTX for debug. Should not be enabled during normal operation.
Enable Automatic Prefix	Disabled	Disabled: Feature off. Enabled: The base will add the leading digit defined in “Set Prefix for Outgoing Calls”. Enabled + fall through on * and #: Will enable detection of * or # at the first digit of a dialled number. In case of detection the base will not complete the dialled number with a leading 0. Examples: 1: dialled number on handset * 1234 -> dialled number to the pabx *1234 2: dialled number on handset #1234 -> dialled number to the pabx #1234 3: dialled number on handset 1234 -> dialled number to the pabx 01234
Set Maximum Digits of Internal Numbers	0	Used to detect internal numbers. In case of internal numbers no prefix number will be added to the dialled number.
Set Prefix for Outgoing Calls	Empty	Prefix number for the enabled automatic prefix feature. Permitted value(s): 1 to 9999

There are three ways of configuring the system.

1. Manual configuration by use of the Web server in the base station(s)
2. By use of configuration files that are uploaded from a disk via the “Configuration” page on the Web server.
3. By use of configuration files which the base station(s) download(s) from a configuration server.

For further details refer to doc reference [3].

5.7 Firmware Update Definitions

In this page, the system administrator can configure how base stations and SIP nodes upgrade/downgrade to the relevant firmware. Handset firmware update status can be found in the extensions page and repeater firmware update status in the repeater page. Base firmware update status is found in the multicell page.

Screenshot

Parameter	Default Value(s)	Description
Firmware update server address	Empty	IP address or DNS of firmware update files source Valid Inputs: AAA.BBB.CCC.DDD or <URL> Example: firmware.rtx.net or 10.10.104.41
Firmware path	Empty	Location of firmware on server (or firmware update server path where firmware update files are located). Example: /East_Fwu Note: Must begin with (/) slash character
Required Version Type	Empty	Version of firmware to be upgraded (or downgraded) on handset type or repeater. Valid Input(s): 8-bit string length. E.g. 280 Note: Value version 0 will disable firmware upgrade for handsets and/or repeater Note: Two handset types will be serial firmware upgraded. First type 8630 then type 8430.
Required Version base	Empty	Version of firmware to be upgraded (or downgraded) on Base station. Base units are referred to as gateways over here. Valid Input(s): 8-bit string length. E.g. 280

5.8 Time Server

In this section, we describe the different parameters available in the Time Server menu.

The Time server supplies the time used for data synchronisation in a multi-cell configuration. As such it is mandatory for a multi-cell configuration. The system will not work without a time server configured.

As well the time server is used in the debug logs and for SIP traces information pages, and used to determine when to check for new configuration and firmware files.

NOTE: It is not necessary to set the time server for standalone base stations (optional).

Press the “Time PC” button to grab the current PC time and use in the time server fields.

NOTE:

When time server parameters are modified/changed synchronisation between base stations can take up to 15 minutes before all base stations are synchronised, depending on the number of base stations in the system. Changing time settings will require a reboot of system.

Screenshot

Parameter	Default Values	Description
Time Server	Empty	DNS name or IP address of NTP server. Enter the IP/DNS address of the server that distributes reference clock information to its clients including Base stations, Handsets, etc. Valid Input(s): AAA.BBB.CCC.DDD or URL (e.g. time.server.com) Currently only Ipv4 address (32-bit) nomenclature is supported.
Allow broadcast NTP	Checked	By checked time server is used.
Refresh time (h)	Empty	The window time in hours within which time server refreshes. Valid Inputs: positive integer
Set timezone by country/region	Checked	By checked country setting is used (refer to country web page).
Time Zone	0	Refers to local time in GMT or UTC format. Min: -12:00 Max: +13:00
Set DST by country/region	Checked	By checked country setting is used (refer to country web page).
Daylight Saving Time (DST)	Disabled	The system administrator can Enable or Disable DST manually. Automatic: Enter the start and stop dates if you select Automatic.
DST Fixed By Day	Use Month and Date	You determine when DST actually changes. Choose the relevant date or day of the week, etc. from the drop down menu.
DST Start Month	March	Month that DST begins Valid Input(s): Gregorian months (e.g. January, February, etc.)
DST Start Date	25	Numerical day of month DST comes to effect when DST is fixed to a specific date Valid Inputs: positive integer
DST Start Time	3	DST start time in the day Valid Inputs: positive integer
DST Start Day of Week	Monday	Day within the week DST begins
DST Start Day of Week, Last in Month	Last in Month	Specify the week that DST will actually start.
DST Stop Month	October	The month that DST actually stops.
DST Stop Date	1	The numerical day of month that DST turns off. Valid Inputs: positive integer (1 to 12)
DST Stop Time	2	The time of day DST stops Valid Inputs: positive integer (1 to 12)
DST Stop Day of Week	Sunday	The day of week DST stops
DST Stop Day of Week Last in Month	First in Month	The week within the month that DST will turn off.

5.9 Country

The country setting controls the in-band tones used by the system. To select web interface language go to the management page.

Screenshot

Parameter	Default Values	Description
Select Country	Germany	Supported countries: Australia, Belgium, Brasil, Denmark, Germany, Spain, France, Ireland, Italia, Luxembourg, Nederland, New Zealand, Norway, Portugal, Swiss, Finland, Sweden, Tyrkey, United Kingdom, US/Canade, Austria
State / Region	NA	Only shown by country selection US/Canada, Autralia, Brasil
Select Language	English	Web interface language. Number of available languages: English, Dansk, Italiano, Tyrkie, Deutsch, Portuguese, Hrvatski, Srpski, Slovenian, Nederlands, Francaise, Espanol, Russian, Polski.
Set timezone by country/region	checked	When checked timezone will follow country/region
Set DST by country/region	checked	When checked DST will follow country/region
Notes	Empty	Only showing notes to time setting for countries: US/Canada, Brasil

NOTE: By checked timezone and DST the parameters in web page Time will be discarded.

The following types of in-band tones are supported:

- Dial tone
- Busy tone
- Ring Back tone
- Call Waiting tone
- Re-order tone

5.10 Security

The security section is used for loading of certificates and for selecting if only trusted certificates are used. Furthermore, web password can be configured.

The Security web is divided into three sections: Certificates (trusted), SIP Client Certificates (and keys) and Password administration.

To setup secure fwu and configuration file download select HTTPs for the Management Transfer Protocol (refer to management web).

SIP and RTP security is server dependent and in order to configure user must use the web option Servers (refer to servers web).

5.10.1 Certificates

The certificates list contains the list of loaded certificates for the system. Using the left column check mark it is possible to check and delete certificates. To import a new certificate use the mouse “select file” and browse to the selected file. When file is selected, use the “Load” button to load the certificate.

The certificate format supported is DER encoded binary X.509 (.cer).

Screenshot

Certificates list

Parameter	Default Values	Description
Idx	Fixed indexes	Index number
Issued To	Empty	IP address – which is part of the certificate file
Issued To	Empty	Organisation, Company – which is part of the certificate file
Valid Until	Empty	Date Time Year – which is part of the certificate file

Screenshot

By enabling Use Only Trusted Certificates, the certificates the base will receive from the server must be valid and loaded into the system. If no valid matching certificate is found during the TLS connection establishment, the connection will fail. When Use Only Trusted Certificates is disabled, all certificates received from the server will be accepted.

sNote: It is important to use correct date and time of the system when using trusted certificates. In case of time/date not defined the certificate validation can fail.

5.10.2 SIP Client Certificates

To be able to establish a TLS connection in scenarios, where the server requests a client certificate, a certificate/key pair must be loaded into the base. This is currently supported only for SIP.

To load a client certificate/key pair, both files must be selected at the same time, and it is done by pressing “select files” under “Import SIP Client Certificate and Key Pair” and then select the certificate file as well as the key file at the same time. Afterwards, press load.

The certificate must be provided as a DER encoded binary X.509 (.cer) file, and the key must be provided as a binary PKCS#8 file.

Note: Use Chrome for loading SIP Client Certificates

Screenshot

5.10.3 Password

In the below the password parameters are defined.

Screenshot

Parameter	Default Values	Description
Username	Admin	Can be modified to any supported character and number Maximum characters: 15
Current Password	Admin	Can be modified to any supported character and number
New Password	Empty	Change to new password Maximum characters: 15
Confirm Password	Empty	Confirm password to reduce accidentally wrong changes of passwords

Password valid special signs: @/|<>_-.!?*+##

Password valid numbers: 0-9

Password valid letters: a-z and A-Z

5.11 Central Directory and LDAP

The SME VOIP system support two types of central directories, a local central directory or LDAP directory.

For both directories caller id look up is made with match for 6 digits of the phone number.

5.11.1 Local Central Directory

Select local and save for local central directory.

Screenshot

Parameter	Default Values	Description
Local	Local	Drop down menu to select between local central directory and LDAP based central directory
Server	Empty	The parameter is used if directory file is located on server. Valid Inputs: AAA.BBB.CCC.DDD or <URL> Refer to appendix for further details.
Filename	Empty	The parameter is used if directory file is located on server. Refer to appendix for further details
Phonebook reload interval (s)	0	The parameter is controlling the reload interface of phonebook in seconds. The feature is for automatic reload the base phonebook file from the server with intervals. It is recommended to specify a conservative value to avoid overload of the base station. With default value setting 0 the reload feature is disabled.

5.11.1.1 Import Central Directory

The import central directory feature is using a browse file approach. After file selection press the load button to load the file. The system support only the original *.csv format. Please note that some excel csv

formats are not the original csv format. The central directory feature can handle up to 3000 contacts. For further details of the central directory feature refer to appendix.

5.11.2 LDAP

Select LDAP Server and save for LDAP server configuration.

Screenshot

Screenshot

Parameter	Default Values	Description
LDAP Server	LDAP Server	Drop down menu to select between local central directory and LDAP based central directory. LDAP Server is displayed when LDAP server is selected.
Server	Empty	IP address of the LDAP server. Valid Inputs: AAA.BBB.CCC.DDD or <URL>

Port	Empty	The server port number that is open for LDAP connections.
Sbase	Empty	Search Base. The criteria depends on the configuration of the LDAP server. Example of the setting is CN=Users, DC=umber, DC=loc
LDAP filter	Empty	LDAP Filter is used to as a search filter, e.g. setting LDAP filter to ((givenName=%*)(sn=%*)) the IP-DECT will use this filter when requesting entries from the LDAP server. % will be replaced with the entered prefix e.g searching on J will give the filter ((givenName=J*)(sn=J*)) resulting in a search for given name starting with a J or surname starting with J.
Bind	Empty	Bind is the username that will be used when the IP-DECT phone connects to the server
Password	Empty	Password is the password for the LDAP Server
Virtual Lists	Disabled	By enable, virtual list searching is possible
Name	Empty	The name can be used to specify if sn+givenName or cn (common name) is return in the LDAP search results
Work Number	Empty	Work number is used to specify that LDAP attribute that will be mapped to the handset work number
Home Number	Empty	Home number is used to specify that LDAP attribute that will be mapped to the handset home number
Mobile Number	Empty	Mobile number is used to specify that LDAP attribute that will be mapped to the handset mobile number

5.11.3 Characters supported

The below table shows which characters are supported in the communication between RTX8663 and handset.

	0	1	2	3	4	5	6	7	8	9	A	B	C	D	E	F
0			0	@	P	`	p	€	ı		ı	À	Đ	à	đ	
1		!	1	A	Q	a	q	ı	'	ı	±	Á	Ñ	á	ñ	
2		"	2	B	R	b	r	,	'	ø	Č	Â	Ò	â	ò	
3		#	3	C	S	c	s	f	"	£	č	Ă	Ó	ă	ó	
4		\$	4	D	T	d	t	„	"	¤	´	Ä	Ô	ä	ô	
5		%	5	E	U	e	u	...	•	¥	µ	Å	Ö	å	ö	
6		&	6	F	V	f	v	†	-	ı	¶	Æ	Ö	æ	ö	
7		'	7	G	W	g	w	‡	—	§	·	Ç	×	ç	÷	
8		(8	H	X	h	x	^	˘	¨	˙	È	Ø	è	ø	
9)	9	I	Y	i	y	Ř	ř	Û	Đ	É	Ù	é	ù	
A		*	:	J	Z	j	z	Š	š	ú	đ	Ê	Ú	ê	ú	
B		+	;	K	[k	{	<	>	«	»	Ë	Û	ë	û	
C		,	<	L	\	l		œ	œ	Ë	Ť	İ	Ü	ı	ü	
D		-	=	M]	m	}	Ş	ş	ě	ı	Í	Ý	í	ý	
E		.	>	N	^	n	~	Ž	ž	Ň	ň	İ	ı	ı	ı	
F		/	?	O	_	o	ö	ÿ	ı	ı	ı	ı	ı	ı	ı	

5.12 Multi-cell Parameter Definitions

In this section, we describe the different parameters available in the Multi-cell configurations menu.

5.12.1 Settings for Base Unit

Description of Settings for Specific Base units is as follows:

Screenshot

Multicell status covers status of data synchronization. The status “Keep-alive” means normal operation.

Parameter	Default values	Description
Multi cell system	Disabled	Enable this option to allow the Base unit to be set in multi-cell mode (can be set either as master or slave in the multi-cell chain system – refer to MAC-units in Chain section for details). Valid Inputs: Enable, Disable Must “save and reboot” after change from disabled to enable.
System chain ID	Empty	This is an identifier (in string format e.g. 2275) that is unique for a specific multi-cell system. The Chain ID value MUST not be equal to a used SIP account. The Chain ID use up a SIP account with this value. Note: Chain ID is used as SIP account for check Sync. Default value is 512, which means extension 512 must not be used – unless the chain ID is modified. Chain ID can be modified by provisioning only. Note: There can be several multi-cell systems in SME network. Up to 24 levels of base stations chains are permitted in a setup. Valid Input: The Web site allow max 5 digits in this field.
Synchronization time (s)	60 sec	This specifies the period in seconds when elements/nodes (e.g. Base units) in a specific Multi-cell will synchronise to each other.

		If no keep-alive packets are received within a period of 2*NETWORK_SYNC_TIME, the base will be indicated as lost in the multi cell configuration. The parameter is also used with “Auto create multi primary” feature.
Data Sync:	Multicast	To select between multicast or Peer to Peer data synchronisation mode. The multicast port range and IP addresses used is calculated from the chain id. The multicast feature uses the port range: 49200 – 49999 The multicast feature IP range: 224.1.0.0 – 225.1.0.0 Multicast uses UDP.
Primary Data Sync IP	Empty	IP of base station data sync source – the base handling the data synchronisation. Using multicast this base IP is selected automatically. The data sync feature uses the port range: 49200 – 49999 NOTE: Using Peer to Peer mode the IP of the base used for data sync. source MUST be defined. NOTE: Using Peer to Peer mode with version below V306 limits the system automatic recovery feature – as there is no automatic recovery of the data sync. source in Peer to Peer mode.
Multi cell debug	None	Enable this feature, if you want the system to catalogue low level multi-cell debug information or traces. Options: Data Sync: Writes header information for all packets received and sent to be used to debug any special issues. Generates LOTS of SysLog signaling and is only recommended to enable shortly when debugging. Auto Tree: Writes states and data related to the Auto Tree Configuration feature. Both: Both Data Sync and Auto Tree are enabled. NOTE: Must only be used for debug purpose and not enabled on a normal running system

5.12.2 DECT System Settings

Description of DECT Settings for Specific Base units is as follows:

Screenshot

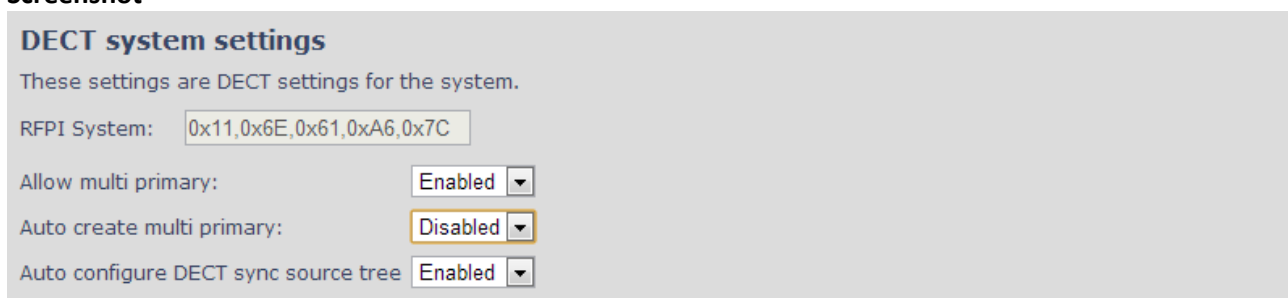

Parameter	Default values	Description
DECT system RFPI	Not able	This is a radio network identity accessed by all Base units in a specific multi-cell system. It composed of 5 octets. It is actually 5 different variables combined together. RFPI Format: XX XX XX XX XX (where XX are HEX values)

Allow multi primary:	Disabled	This feature is used for multi-location setups. Allows two or more primary in the same system. The two cells will be unsynchronized and handover will not be possible. "Auto Configure DECT sync source tree" must be enabled for this feature to also be enabled
Auto create multi primary:	Disabled	By enabled the system can generate cells in case a base goes into faulty mode. Two cells will only be generated in case no radio connection between the two cells is present. In order to recover the full system after establish of the faulty base, the system must be rebooted. Allow multi primary must be enabled for this feature to also be enabled.
Auto configure DECT sync source tree	Enabled	Enable this to allow the system to automatically synchronise the multi-cell chain/tree. NOTE: Must be enabled in order to allow a new primary recover in case the original primary goes into faulty mode.

Note: To run with a system with two separate primary in two locations "Allow multi primary" and "Auto configure DECT sync source tree" must be enabled. To add the second primary the slave must manually be configured as primary. Alternatively the "Auto create multi primary" must be enabled.

5.12.3 Base System Settings

Description of SIP Settings for Specific Base units is as follows:

Screenshot

Base station settings

Number of SIP accounts before distributed load:

SIP Server support for multiple registrations per account: (used for roaming signalling)

System combination (Number of base stations/Repeaters per base station):

Parameter	Default Values	Description
Number of SIP accounts before distributed load	8	The maximum number of handsets or SIP end nodes that are permitted to perform location registration on a specific Base unit before load is distributed to other base units. The parameter can be used to optimize the handset distribution among visible basestations. Note: A maximum of 8 simultaneous calls can be routed through each Base unit in a multi-cell setup. Permitted Input: Positive Integers (e.g. 6)
SIP Server support for multiple registrations per account	Disabled	Disable this option so it is possible to use same extension (i.e. SIP Account) on multiple phones (SIP end nodes). These phones will ring simultaneously for all incoming calls. When a phone (from a SIP account group) initiates a handover from Base X to Base Y, this phone will de-register from Base X, and register to Base Y after a call. Permitted Input: Disabled: No SIP de-registration will be made when a handset

		<p>roams to another base station</p> <p>Enabled: The old SIP registration will be deleted with a SIP Deregistration, when a handset roams to another base station</p>
System combination (Number of base stations/Repeaters per base station):	50/3	<p>Select between basic base configurations.</p> <p>50/3 : 50 bases and 3 repeaters</p> <p>127/1 : 127 bases and 1 repeater</p> <p>254/0 : 254 bases and 0 repeater</p> <p>The configuration cannot be modified after a system is established.</p> <p>The configuration must be set during first multicell configuration.</p>

5.12.4 Base Station Group

The Base station group list various parameter settings for base stations including chain level information.

Screenshot:

Base Station Group									
ID	RPN	Version	MAC-Address	IP-Address	IP Status	DECT sync source	DECT property	Base Station Name	
<input type="checkbox"/>	0	00	280	00087B0A00B3	192.168.11.159	This Unit	Select as primary	Primary	1
<input type="checkbox"/>	1	04	280	00087B09FECA	192.168.11.116	Connected	Primary:RPN00 (-24dBm)	Locked	2
<input type="checkbox"/>	2	08	280	00087B09FE45	192.168.11.113	Connected	Level 1:RPN04 (-24dBm)	Locked	3
<input type="checkbox"/>	3	0C	280	00087B09FF08	192.168.11.109	Connected	Level 2:RPN08 (-24dBm)	Locked	4
<input type="checkbox"/>	4	10	280	00087B09FE4A	192.168.11.166	Connected	Level 3:RPN0C (-24dBm)	Locked	5
<input type="checkbox"/>	5	14	280	00087B079205	192.168.11.133	Connected	Level 4:RPN10 (-24dBm)	Locked	6

[Check All](#) / [Uncheck All](#)
 With selected: [Remove from chain](#)

Parameters	Description
ID	Base unit identity in the chained network. Permitted Output: Positive Integers
RPN	The Radio Fixed Part Number is an 8-bit DECT cell identity allocated by the installer. The allocated RPN within the SME must be geographically unique. Permitted Output: 0 to 255 (DEC) OR 0x00 to 0xFF (HEX)
Version	Base station current firmware version. Permitted Output: positive Integers with dot (e.g. 273.1)
MAC Address	Contains the hardware Ethernet MAC address of the base station. It varies from Base station to Base stations.
IP Status	Current Base station behaviour in the SME network. Possible Outputs Connected: The relevant Base station(s) is online in the network Connection Loss: Base station unexpectedly lost connection to network This Unit: Current Base station whose http Web Interface is currently being accessed
DECT Sync source	With setting “Auto configure DECT sync source tree” set to Enable, this three will automatically be generated. If manual configured the administrator should choose the relevant “multi cell chain” level its wants a specific Base unit be placed. Maximum number of “multi-cell chain” levels is 12. Format of the selection: “AAAAAxx: RPNyy (-zz dBm)” AAAAA: indication of sync. source for the base. Can be “Primary” or “Level xx” xx: Sync. source base sync. level yy: Sync. source base RPN zz: RSSI level of sync. source base seen from the actual base “(Any) RPN”: When a base is not synchronized to other base. State after reboot of chain.
Dect Property	Base station characteristics in connection to the current multi cell network.

	<p>Possible Output(s)</p> <p>Primary: Main Base station unto which all other nodes in the chain synchronises to.</p> <p>Locked: The Base unit is currently synchronized and locked to the master Base unit.</p> <p>Searching: Base unit in the process of locating to a Master/slave as specified in Dect sync source</p> <p>Free Running: A locked Base unit that suddenly lost synchronisation to the Master.</p> <p>Unknown: No current connection information from specific Base unit</p> <p>Assisted lock: Base has lost DECT sync. source and Ethernet is used for synchronization</p> <p>Sync. Lost: Handset has an active DECT connection with the base. But the base has lost DECT sync. source connection. The base will stay working as long as the call is active and will go into searching mode when call is stopped.</p>
<p>Base Station Name</p>	<p>Name from management settings.</p>

5.12.5 DECT Chain

Below the Base Group Table is the DECT Chain tree. The DECT Chain tree is a graphical presentation of the Base Group table levels and connections. Repeaters are shown with green highlight.

Screenshot: DECT Chain tree of above configuration

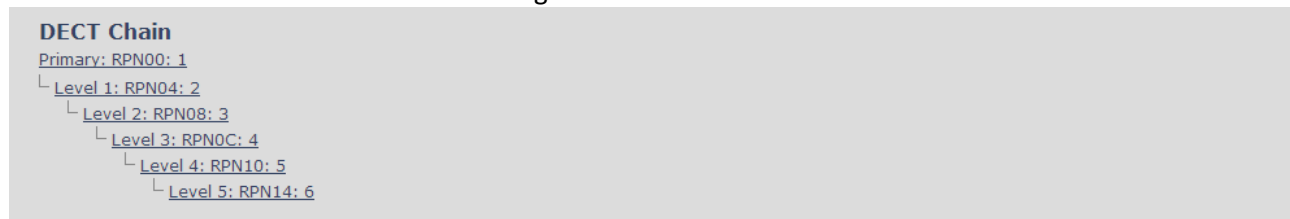

Screenshot: Example of part of DECT Chain tree with repeaters



Screenshot: Example of part of DECT Chain tree with units in Base Group but not in tree by various reasons.

The screenshot displays a DECT Chain tree configuration interface. The tree structure is as follows:

- Level 6: RPN4: SME VoIP (RTX Chain A214)
 - Level 7: RPN2C: SME VoIP (RTX Chain A214)
- Level 2: RPN7D: Repeater (01:5A:D9:E2:C0)
 - Level 3: RPN7E: Repeater (01:5A:D9:E2:48)
 - Level 4: RPN7F: Repeater (01:5A:D9:E2:26)
- Level 1: RPN1: Repeater (00:5A:D8:5E:E8)
 - Level 2: RPNB2: Repeater (00:5A:D8:5D:F0)
 - Level 3: RPNB3: Repeater (01:5A:D9:E1:C6)

Below the tree, a list of warning messages is shown with red backgrounds:

- Warning: RPN00: (RTX Chain Canteen) - static IP
- Warning: RPN04: SME VoIP (RTX Chain B106)
- Warning: RPN20: SME VoIP (RTX Chain Hall 3)
- Warning: RPN31:
- Warning: RPN50: SME VoIP (RTX Chain D102)
- Warning: RPN59: SME VoIP (RTX Chain D112)
- Warning: RPN5c: SME VoIP (RTX Chain D103)
- Warning: RPN64: SME VoIP (RTX Chain D108)

At the bottom of the interface, there are three buttons: "Reboot chain", "Force reboot chain", and "Reconfigure DECT Tree".

When a base or repeater has not joined the tree it will be shown with read background below the tree.

5.13 Repeaters

Within this section we describe the repeater parameter, and how to operate the repeater.

5.13.1 Add repeater

From repeaters web select “Add Repeater”

Screenshot

The screenshot shows the 'Repeaters' management page. At the top, there are links for 'Add Repeater', 'Refresh', and 'Stop Registration'. Below these is a table with the following columns: Id#, RPN, Name/IPEI, DECT sync source, DECT sync mode, State, FW Info, and FWU Progress. The table contains three entries:

Id#	RPN	Name/IPEI	DECT sync source	DECT sync mode	State	FW Info	FWU Progress
<input type="checkbox"/> 0	RPN01	Office A100/ 005AD85FB0	RPN00 (-26dBm)	Manually	Present@RPN00	39	Off
<input type="checkbox"/> 1	RPN02	Office B120/ 005AD85D90	RPN01 (-34dBm)	Manually	Present@RPN00	39	Off
<input type="checkbox"/> 2	RPN03	Office D130/ 015AD85E80	RPN02 (-34dBm)	Manually	Present@RPN00	39	Off

Below the table, there are links for 'Check All / Uncheck All' and a note: 'With selected: [Delete Repeater\(s\)](#), [Register Repeater\(s\)](#) [Deregister Repeater\(s\)](#)'.

Then select “DECT Sync mode”

Screenshot

Parameters	Description
Name	Repeater name. If no name specified the field will be empty
DECT sync mode	<p>Manually: User controlled by manually assign “Repeater RPN” and “DECT sync source RPN”</p> <p>Local Automatical: Repeater controlled by auto detects best base signal and auto assign RPN.</p>

Repeater

Name:

DECT sync mode:

RPN	DECT sync source
<input type="text" value="RPN01"/>	<input type="text" value="RPN00 (-∞dBm) (RTX Chain Canteen1 - static IP)"/>

5.13.1.1 Manually

User controlled by manually assign “Repeater RPN” and “DECT sync source RPN”. The parameters are selected from the drop down menu.

Screenshot

Repeater

Name:

DECT sync mode:

RPN	DECT sync source
<input type="text" value="RPN01"/>	<input type="text" value="RPN00 (-∞dBm) (RTX Chain Canteen1 - static IP)"/>

Parameters	Description
Idx	System counter
RPN	<p>SINGLE CELL SYSTEM: The base has always RPN00, first repeater will then be RPN01, second repeater RPN02 and third RPN03 (3 repeaters maximum per base)</p> <p>MULTI CELL SYSTEM: Bases are increment by 2^2 in hex, means first base RPN00 second base RPN04 etc., in between RPN01, 02, 03 addressed for repeaters at Primary base and 05, 06, 07 addressed for Secondary base (3 repeaters maximum per base)</p>
DECT sync source	Select the base or repeater the repeater has to be synchronized to.

5.13.1.2 Local Automatical

Repeater controlled by auto detects best base signal and auto assign RPN. The RPN and DECT sync source are greyed out.

Repeater

Name:

DECT sync mode:

RPN	DECT sync source
ERROR	RPN00 (-∞dBm) (RTX Chain Canteen1 - static IP)

The repeater RPN is dynamic assigned in base RPN range.
 With local automatical mode repeater on repeater (chain) is not supported.

5.13.2 Register Repeater

Adding a repeater makes it possible to register the repeater. Registration is made by select the repeater and pressing register repeater. The base window for repeater registration will be open until the registration is stopped. By stopping the registration all registration on the system will be stopped inclusive handset registration.

Idx	RPN	IPEI	DECT sync source	DECT sync mode	State	FW Info	FWU Progress
<input checked="" type="checkbox"/>	<u>0</u>	RPN01	FF:FF:FF:FF:FF	RPN00 (-∞dBm)	Local Automatical		

[Check All](#) / [Uncheck All](#)
 With selected: [Delete Repeater\(s\)](#), [Register Repeater\(s\)](#), [Deregister Repeater\(s\)](#)

5.13.3 Repeaters list

Repeaters

[Add Repeater](#)

[Refresh](#)

[Stop Registration](#)

Idx	RPN	Name/ IPEI	DECT sync source	DECT sync mode	State	FW Info	FWU Progress
<input type="checkbox"/>	<u>0</u>	RPN01	Office A100/ 005AD85FB0	RPN00 (-26dBm)	Manually	Present@RPN00 39	Off
<input type="checkbox"/>	<u>1</u>	RPN02	Office B120/ 005AD85D90	RPN01 (-34dBm)	Manually	Present@RPN00 39	Off
<input type="checkbox"/>	<u>2</u>	RPN03	Office D130/ 015AD85E80	RPN02 (-34dBm)	Manually	Present@RPN00 39	Off

[Check All](#) / [Uncheck All](#)
 With selected: [Delete Repeater\(s\)](#), [Register Repeater\(s\)](#), [Deregister Repeater\(s\)](#)

Parameters	Description
IDx	Repeater unit identity in the chained network. Permitted Output: Positive Integers
RPN	The Radio Fixed Part Number is an 8-bit DECT cell identity allocated by the installer. The allocated RPN within the SME must be geographically unique. Permitted Output: 0 to 255 (DEC) OR 0x00 to 0xFF (HEX)
Name/IPEI	Contains the name and the unique DECT serial number of the repeater. If name is given the field will be empty.
DECT sync Source	The “multi cell chain” connection to the specific Base/repeater unit. Maximum number of chain levels is 12. Sync. source format: “RPNyy (-zz dBm)” yy: RPN of source zz: RSSI level seen from the actual repeater
DECT sync Mode	Manually: User controlled by manually assign “Repeater RPN” and “DECT sync source RPN” Local Automatical: Repeater controlled by auto detects best base signal and auto assign RPN. Chaining Automatical: Base controlled by auto detects best base or repeater signal and auto assign RPN. This feature will be supported in a future version
State	Present@unit means connected to unit with RPN yy
FW info	Firmware version
FWU Progress	Possible FWU progress states: Off: Means sw version is specified to 0 = fwu is off Initializing: Means FWU is starting and progress is 0%. X% : FWU ongoing Verifying X%: FWU writing is done and now verifying before swap “Conn. term. wait” (Repeater): All FWU is complete and is now waiting for connections to stop before repeater restart. Complete HS/repeater: FWU complete Error: Not able to fwu e.g. file not found, file not valid etc

5.14 Alarm

In the Alarm Settings menu, it is controlled how an alarm appears on the handset. For example if the handset detects “Man Down”, then it is defined in this menu what alarm signal this type of alarm will send out and if a pre-alarm shall be signaled etc.

Alarm

Idx	Profile Alias	Alarm Type	Alarm Signal	Stop Alarm from Handset	Trigger Delay	Stop Pre-Alarm from Handset	Pre-Alarm Delay	Howling
0		Alarm Button ▼	Call ▼	Enabled ▼	0	Enabled ▼	5	Disabled ▼
1		Pull Cord ▼	Message ▼	Enabled ▼	0	Enabled ▼	0	Disabled ▼
2		Running ▼	Call ▼	Enabled ▼	0	Enabled ▼	2	Disabled ▼
3		No Movement ▼	Message ▼	Enabled ▼	0	Enabled ▼	0	Disabled ▼
4		Man Down ▼	Call ▼	Enabled ▼	0	Enabled ▼	0	Disabled ▼
5		Disabled ▼	Call ▼	Enabled ▼	0	Enabled ▼	0	Disabled ▼
6		Disabled ▼	Call ▼	Enabled ▼	0	Enabled ▼	0	Disabled ▼
7		Disabled ▼	Call ▼	Enabled ▼	0	Enabled ▼	0	Disabled ▼

All configuration of the handset Alarm Settings is done from the base station. The concept is that on the “Alarm” page on the web server, eight different alarm profiles can be configured. Afterwards for each handset, it can be selected which of the configured alarm profiles, the given handset shall subscribe to. When this is done the selected alarm profiles are sent to the handset.

See section 5.3.2.3 Multiline: Edit handset

The parameters that can be configured are:

Parameters	Description
Idx	Indicates the index number of a specific alarm.
Profile Alias	An alias or user-friendly name to help identify the different profiles when selecting which profiles to enable for the individual handsets.
Alarm Type	The type of alarm is dependent of what kind of event that has triggered the alarm on the handset. The handset supports either of the following categories: Man Down No Movement Running Pull Cord Emergency Button Disabled
Alarm Signal	The way the alarm is signalled as it received on the handset. Message: A text message to an alarm server. Call: An outgoing call to the specified emergency number.
Stop Alarm from Handset	Enable/disable the possibility to stop/cancel the alarm from the handset.
Trigger Delay	The period from when the alarm has fired until the handset shows a pre-alarm warning. If set to 0, there will be no pre-alarm warning, and the alarm will be signalled immediately. The alarm algorithm typically needs about 6 sec. to detect e.g. man down etc.
Stop Pre-Alarm from Handset	Enable/disable the possibility to stop/cancel the pre-alarm from the handset.
Pre-Alarm Delay	The period from the pre-alarm warning is shown until the actual alarm is

	signalled. The maximum value is 255.
Howling	Enable/disable if howling shall be started in the handset, when the alarm is signalled. If disabled, only the configured signal is sent (call or message).

NOTE This alarm feature is only available on some types of handsets (e.g. the RTX8830)
After configuration, the handset must be rebooted.

5.14.1 Use of Emergency Alarms

As described above, it can be configured if it shall be possible to stop an alarm from the handset. If the possibility to stop an alarm from the handset is disabled, it is ensured that an alarm is not stopped before someone at e.g. an emergency center has received the alarm and reacted upon it.

The behavior of a handset when an alarm “is sent” depends on the configured Alarm Signal:

- **Call:** When the Alarm Signal is configured as “Call”, the handset will make a call to the specified emergency number, and the alarm is considered stopped when the call is terminated. If it is not allowed to stop the alarm from the handset, it will not be possible to terminate the call from handset, and the alarm will be considered as stopped only when the remote end (e.g. the emergency center) terminates the call.
- **Message:** When the Alarm Signal is configured as “Message”, the handset will send an alarm message to the specified alarm server, and enable auto answer mode. If Howling is enabled, the handset will also start the Howling tone. The alarm will not stop until a call is made, and since auto answer mode is enabled, the emergency center can make the call, and the person with the handset does not have to do anything to answer the call, it will answer automatically. Again, the alarm is considered stopped, when the call is terminated with the same restrictions as for the Call alarm signal.

All type of alarms have the same priority. This means that once an alarm is active, it cannot be overruled by another alarm until the alarm has been stopped. However, if the alarm is not yet active, i.e. if it is in “pre-alarm” state and an alarm configured with no pre-alarm is fired, then the new alarm will become active and stop the pending alarm.

Alarms with no pre-alarm are considered important, and there is no possibility to cancel them before they are sent, and therefore alarms with no pre-alarm, are given higher priority than alarms in pre-alarm state.

The Emergency Button could be an example of an alarm which would be configured without pre-alarm. Thus, when the Emergency Button is pressed you want to be sure the alarm is sent. However, if another alarm was already in pre-alarm state, it could potentially be cancelled, and if the Emergency Button alarm was ignored in this case, no alarm would be sent. This is the reason why alarms with no pre-alarm, are given higher priority than alarms in pre-alarm state.

5.15 Statistics

The statistic feature is divided into four administrative web pages, which can be access from any base.

1. System
2. Calls
3. Repeater
4. DECT data

All four views have an embedded export function, which export all data to comma separated file. By pressing the clear button all data in the full system is cleared.

5.15.1 System data

The system data web is access by <http://ip/SystemStatistics.html> and data is organised in a table as shown in below example.

Screenshot

The screenshot shows a web interface titled "Statistics" with "Export" and "Clear" buttons. Below the buttons are navigation links: [System](#) / [Calls](#) / [Repeater](#) / [DECT](#). The main data is presented in a table with the following content:

Base Station Name	Operation/Duration D-H:M:S	Busy	Busy Duration D-H:M:S	SIP Failed	Handset Removed	Searching	Free Running	DECT Source Changed
192.168.11.181 SME VoIP	4-00:29:48/ 4-03:12:50	0		0	0	1	0	0
192.168.11.180 SME VoIP	1-05:47:59/ 4-03:10:27	0		0	0	3	0	0
Sum	Max 4-00:29:48/ 4-03:12:50 Min 1-05:47:59/ 4-03:10:27	0		0	0	4	0	0

The table is organised with headline row, data pr. base rows and with last row containing the sum of all base parameters.

Parameters	Description
Base Station Name	Base IP address and base station name from management settings
Operation/Duration D-H:M:S	Operation is operation time for the base since last reboot. Duration is the operation time for the base since last reset of statistics, or firmware upgrade.
Busy	Busy Count is the number of times the base has been busy.
Busy Duration D-H:M:S	Busy duration is the total time a base has been busy for speech (8 or more calls active).
SIP Failed	Failed SIP registrations count the number of times a SIP registration has failed
Handset Removed	Handset removed count is the number of times a handset has been marked as removed
Searching	Base searching is the number of times a base has been searching for it's sync

	source
Free Running	Base free running is the number of times a base has been free running
DECT Source Changed	Number of time a base has changed sync source

5.15.2 Call data

The call data web is access by <http://ip/CallStatistics.html> and data are organised in a table as shown in below example.

Screenshot

System / **Calls** / Repeater / DECT

Base Station Name	Operation/ Duration D-H:M:S	Count	Dropped	No Response	Duration D-H:M:S	Active	Max Active	Codec G711U: G711A: G722: G726:	Handover Success	Handover Failed
192.168.11.181 SME VoIP	4-00:31:48/ 4-03:14:50	7	0	0	0-00:00:37	0	1	0:2:0:0	0	0
192.168.11.180 SME VoIP	1-05:50:09/ 4-03:12:27	6	0	0	0-00:00:27	0	1	0:1:0:0	0	0
Sum	Max 4-00:31:48/ 4-03:14:50 Min 1-05:50:09/ 4-03:12:27	13	0	0	0-00:01:04	0	2	0:3:0:0	0	0

The table is organised with headline row, data pr. base rows and with last row containing the sum of all base parameters.

Parameters	Description
Base Station Name	Base IP address and base station name from management settings
Operation time/Duration	Total operation time for the base since last reboot or reset Duration is the time from data was cleared or system has been firmware upgraded.
Count	Counts number of calls on a base.
Dropped	Dropped calls are the number of active calls that was dropped. E.g. if a user has an active call and walks out of range, the calls will be counted as a dropped call. An entry is stored in the syslog when a call is dropped.
No response	No response calls is the number of calls that have no response, e.g. if a external user tries to make a call to a handset that is out of range the call is counted as no response. An entry is stored in the syslog when a call is no response.
Duration	Call duration is total time that calls are active on the base.
Active	Active call shows how many active calls that are active on the base (Not active DECT calls, but active calls). On one base there can be up to 30 active calls.
Max Active	Maximum active calls are the maximum number of calls that has been active at the same time.
Codecs	Logging and count of used codec types on each call.
Handover Success	Counts the number of successful handovers.
Handover Failed	Counts the number of failed handovers.

5.15.3 Repeater data

Statistics

Export Clear

System / Calls / **Repeater** / DECT

Idx/Name	Operation D-H:M:S	Busy	Busy Duration D-H:M:S	Max Active	Searching	Recovery	DECT Source Changed	Wide Band	Narrow Band
0/Office A100	7-23:17:43	38	0-00:13:13	12	1	0	0	0	225
1/Office B120	7-23:18:08	21	0-00:11:01	10	1	1	0	0	137
2/Office D130	2-20:48:49	13	0-00:10:27	10	1	1	0	0	58
Sum	Max 7-23:18:08 Min 2-20:48:49	72	0-00:34:41	32	3	2	0	0	420

The table is organised with headline row, data pr. base rows and with last row containing the sum of all base parameters.

Parameters	Description
Idx/Name	Base IP address and base station name from management settings
Operation D-H:M:S	Total operation time for the repeater since last reboot or reset Duration is the time from data was cleared or system has been firmware upgraded.
Busy	Busy Count is the number of times the repeater has been busy.
Busy Duration D-H:M:S	Busy duration is the total time a repeater has been busy for speech (5 or more calls active).
Max Active	Maximum active calls are the maximum number of calls that has been active at the same time.
Searching	Repeater searching is the number of times a repeater has been searching for it's sync source
Recovery	In case the sync source is not present anymore the repeater will go into lock on another base or repeater and show recovery mode
DECT Source Changed	Number of time a repeater has changed sync source
Wide Band	Number of wideband calls on repeaters
Narrow Band	Number of narrow band calls on repeaters

5.15.4 DECT data

The DECT data web is access by <http://ip/DectStatistics.html> and data is organised in a table as shown in below example.

Screenshot

Statistics

System / Calls / DECT

	Slot0	Slot1	Slot2	Slot3	Slot4	Slot5	Slot6	Slot7	Slot8	Slot9	Slot10	Slot11
Frequency0	0	0	0	0	0	0	0	0	0	0	0	0
Frequency1	0	0	0	0	0	0	0	0	0	0	0	0
Frequency2	0	0	0	0	0	0	0	0	0	0	0	0
Frequency3	2	3	2	9	4	3	2	3	9	5	3	4
Frequency4	4	7	5	1	5	3	3	6	4	3	4	4
Frequency5	6	0	2	2	1	5	5	2	4	3	5	6
Frequency6	3	3	7	3	4	3	4	5	4	4	3	2
Frequency7	5	2	4	3	4	4	2	4	1	5	3	3
Frequency8	3	1	3	2	2	1	4	2	3	2	2	1
Frequency9	3	3	4	7	8	7	7	2	5	3	2	6

Please note 3 frequencies are manually removed in the example system.

5.16 Settings – Configuration File Setup

This page provides non editable information showing the native format of entire SME VoIP Configuration parameter settings. The **settings** format is exactly what is used in the configuration file. The configuration file is found in the TFTP server.

The filename for the configuration server is **<MAC_Address>.cfg**. The configuration file is saved in the folder **/Config** in the TFTP sever.

There are three ways to edit the configuration file or make changes to the **settings** page:

- 1) Using the SME VoIP Configuration interface to make changes. Each page of the HTTP web interface is a template for which the user can customise settings in the configuration file.
- 2) Retrieving the relevant configuration file from the TFTP and modify and enter new changes. This should be done with an expert network administrator.
- 3) Navigate to the settings page of the VoIP SME Configuration interface > copy the contents of settings > save them to any standard text editor e.g. notepad > modify the relevant contents, make sure you keep the formatting intact > Save the file as **<Enter_MAC_Address_of_RFP>.cfg** > upload it into the relevant TFTP server.

For details refer to [3].

An example of contents of settings is as follows:

```
~RELEASE=UMBER_FP_V0054
%GMT_TIME_ZONE%:16
%COUNTRY_VARIANT_ID%:18
%FWU_POLLING_ENABLE%:0
%FWU_POLLING_MODE%:0
%FWU_POLLING_PERIOD%:86400
%FWU_POLLING_TIME_HH%:3
%FWU_POLLING_TIME_MM%:0
%DST_ENABLE%:2
%DST_FIXED_DAY_ENABLE%:0
%DST_START_MONTH%:3
%DST_START_DATE%:1
....
....
```

5.17 Sys log

This page shows live feed of system level messages of the current base station. The messages the administrator see here depends on what is configured at the Management settings. The Debug logs can show only **Boot Log** or **Everything** that is all system logs including boot logs.

The Debug log is saved in the file format **<Time_Stamp>b.log** in a relevant location in the TFTP server as specified in the upload script.

A sample of debug logs is as follows:

```
0101000013 [N] (01):DHCP Enabled
0101000013 [N] (01):IP Address: 192.168.10.101
0101000013 [N] (01):Gateway Address: 192.168.10.254
0101000013 [N] (01):Subnet Mask: 255.255.255.0
0101000013 [N] (01):TFTP boot server not set by DHCP. Using Static.
0101000013 [N] (01):DHCP Discover completed
0101000013 [N] (01):Time Server: 192.168.10.11
0101000013 [N] (01):Boot server: 10.10.104.63 path: Config/ Type: TFTP
0101000013 [N] (01):RemCfg: Download request of Config/00087b077cd9.cfg from
10.10.104.63 using TFTP
```

```
0101000014 [N] (01):accept called from task 7
0101000014 [N] (01):TrelAccept success [4]. Listening on port 10010
0101000019 [N] (01):RemCfg: Download request of Config/00087b077cd9.cfg from
10.10.104.63 using TFTP
0101000019 [W] (01):Load of Config/00087b077cd9.cfg from 10.10.104.63 failed
```

To dump the log simply copy and page the full contents.

5.18 SIP Logs

This page shows SIP server related messages that are logged during the operation of the SME system. The full native format of SIP logs is saved in the TFTP server as **<MAC_Address><Time_Stamp>SIP.log**. These logs are saved in 2 blocks of 17Kbytes. When a specific SIP log is fully dumped to one block, the next SIP logs are dumped to the other blocks. An example of SIP logs is shown below:

```
.....
Sent to udp:192.168.10.10:5080 at 12/11/2010 11:56:42 (791 bytes)
REGISTER sip:192.168.10.10:5080 SIP/2.0
Via: SIP/2.0/UDP 192.168.10.101:5063;branch=z9hG4bKrlga4nkuhimpnj4.qx
Max-Forwards: 70
From: <sip:Ext003@192.168.10.10:5080>;tag=3o51314
To: <sip:Ext003@192.168.10.10:5080>
Call-ID: p9st.zzrfff66.ah8
CSeq: 6562 REGISTER
Contact: <sip:Ext003@192.168.10.101:5063>
Allow: INVITE, CANCEL, BYE, ACK, REGISTER, OPTIONS, REFER, SUBSCRIBE, NOTIFY,
MESSAGE, INFO, PRACK
Expires: 120
User-Agent: Generic-DPV-001-A-XX(Generic_SIPEXT2MLUA_v1)
Content-Type: application/X-Generic_SIPEXT2MLv1
Content-Length: 251
.....
```

To dump the log simply copy and page the full contents.

6 Multi-cell Setup & Management

This chapter seeks to describe how to install, add and synchronize one or multiple base stations to the network. There are two main procedures involved:

- 1) Proper placement of the base stations (which is called network dimensioning). The present chapter does not address this issue. Refer to Chapter 12 for details.
- 2) Creating and adding base station profiles to the network via the SME Configuration Tool (to form a multi-cell system).

This chapter describes the second procedure.

6.1 Adding Base stations

Here are the recommended steps to add Base stations to network:

- STEP 1** Connect the Base station to a private network via standard Ethernet cable (CAT-5).
- STEP 2** Use one of the two methods to determine the base station IP address.
- a. Use the IP find menu in the handset (Menu * 4 7 *) to determine the IP address of the base station by matching the MAC address on the back of the base station with the MAC address list in the handset.
 - b. Use the IPdect feature
- STEP 3** Open browser on the computer and type in the IP address of the base. Press “Enter” to access the base Login to base station.
- STEP 4** Once you have authenticated, the browser will display front end of the SME Configuration Interface. The front end will show relevant information of the base station.



6.1.1 Time Server Setup

- STEP 5** Navigate to the Time settings and configure it. Scroll on the left column and click on **Time** url link to Open the **Time Settings** Page. Use the PC time feature or enter the relevant parameters on this page and press the **Save and Reboot** button. Make sure there is contact to the “Time server” otherwise the Multi-cell feature will not work. You can verify whether the Time server is reachable af rebooting the base station by verifying the correct Time Server IP address is still in place.

Time Settings

Time Server:

Allow broadcast NTP:

Refresh time (h):

Timezone:

Daylight Saving Time (DST):

DST Fixed By Day:

DST Start Month:

DST Start Date:

DST Start Time:

DST Start Day of Week:

DST Start Day of Week Last in Month:

DST Stop Month:

DST Stop Date:

DST Stop Time:

DST Stop Day of Week:

DST Stop Day of Week Last in Month:

6.1.2 SIP Server (or PBX Server) Setup

- STEP 6** Create the relevant SIP server (or PBX Server) information in the system. Each service provider/customer should refer SIP server vendor on how to setup SIP servers. Click the link “**Server**” at the left hand column of home page, you can add your SIP server for base station use. Next, from the Server page, click on the **Add Server** URL and enter the relevant SIP server information (an example is shown below). Choose “**Disabled**” on NAT adaption parameter if NAT function of the SIP aware router is not enabled. Enter the relevant parameters based on the description in the table below. Select **Save** button.

Server 1:

NAT Adaption:

Registrar:

Outbound Proxy:

Conference Server:

Reregistration time (s):

SIP Session Timers:

Session Timer Value (s):

SIP Transport:

Signal TCP Source Port:

Secure RTP:

Secure RTP Auth:

RTP from own base station:

Keep Alive:

Show Extension on Handset Idle Screen:

Hold Behaviour:

Use Own Codec Priority:

DTMF Signalling:

Codec Priority:

RTP Packet Size:

6.1.3 Multi-cell Setup

STEP 7 Click on **Multi Cell** url link in the **SME VoIP Configuration** to view the current **Multi cell settings** status of the current base station. Brand new base stations have **Multi cell system** feature disabled by default.

[Home/Status](#)
[Extensions](#)
[Servers](#)
[Network](#)
[Management](#)
[Firmware Update](#)
[Time](#)
[Country](#)
[Web Security](#)

Multi cell Settings

Multi Cell Status

System Information: Idle

Last packet received from IP:

Settings for this unit

These settings are used to connect this unit to a system.

Multi cell system:

System chain ID:

Synchronization time (s):

Data Sync:

Multi cell debug:

STEP 8 Next, the system administrator needs to create and Enable Multi Settings profile for the current base station. On the **Multi Cell settings** Page, choose **Enable** option from the drop down menu of the **Multi cell system** parameter. Enable the **Multi cell debug** option if the system administrator wants some Multi-cell related logs to be catalogued by the system.

Settings for this unit

These settings are used to connect this unit to a system.

Multi cell system:

System chain ID:

Synchronization time (s):

Data Sync:

Multi cell debug:

STEP 9 On the same **Multi Cell Settings** page > Enter the relevant values for **System chain ID** and **Synchronization time (s)** respectively. The **System chain ID** is a geographically unique DECT cell identity allocated to bridge several base stations together in a chain. An example is **55555**. The **Synchronization time (s)** parameter is defined as window/period of time in seconds a specific base station synchronises to the master base station unit (by default 60).

Note: Do NOT use a chain ID similar to an extension.

Multi Cell Settings

Multi Cell Status

System Information: Keep-alive
 Last packet received from IP: 192.168.11.158 01/Jul/2013 14:03:00
 Sync Data from IP: 192.168.11.129

Settings for this unit

These settings are used to connect this unit to a system.

Multi cell system:

System chain ID:

Synchronization time (s):

Data Sync:

Primary Data Sync IP:

Multi cell debug:

Click on **Save** button to keep modified changes of multi cell settings into the base station.

The parameters are successfully saved
You will be redirected after 3 seconds

NOTE The Multi Cell data synchronization ONLY works when the relevant **Time Server** is set in the system before Server/Subscriber profile is added or created. Refer to **STEP 5**.

IMPORTANT: Base stations must be rebooted after the time server has been set.

STEP 10 Repeat **STEP 1-9** as explained above for each base stations.

IMPORTANT: It takes up to 5 minutes (synchronization time) to add a new base station to a Multi Cell System.

6.2 Synchronizing the Base stations

STEP 11 On each **SME VoIP Configuration** interface for the base station(s) navigate to the Home/Status page and Click the Reboot button.

The screenshot shows the 'Welcome' page of the RTx web interface. The left sidebar contains navigation options: Home/Status, Extensions, Servers, Network, Management, Firmware Update, Time, Country, Web Security, Central Directory, Multi cell, Configuration, Syslog, SIP Log, and Logout. The main content area displays 'Welcome' and 'System Information' including Phone Type, System Type, RF Band, Current local time, Operation time, RFPI-Address, MAC-Address, IP-Address, Firmware-Version, and Firmware-URL. It also shows 'Multi cell Disabled' status and 'SIP Identity Status on this Base Station' with a list of identities and their statuses. A blue dialog box titled 'Message from webpage' is overlaid on the page, containing a question mark icon and the text: 'Are you sure you want to reboot base station? NOTE: Ongoing call will delay the reboot until all active calls on the base station is ended.' Below the dialog are 'OK' and 'Cancel' buttons. At the bottom of the page, there are 'Reboot' and 'Forced Reboot' buttons.

This will trigger **Are you sure you want to reboot base station?** window. Click **OK** button on this window. A successful restart of the base stations will lead to a display of the page: **Gateway has been reset.**

The screenshot shows the 'Gateway has been reset' page of the RTx web interface. The left sidebar contains navigation options: Home/Status, Extensions, Servers, and Network. The main content area displays 'Gateway has been reset' in large bold text, followed by the message 'Please wait, gateway rebooting'. Below the message is a 'Home' button.

STEP 12 Navigate back to the **Multi cell settings** page by clicking **Multi-cell** url link at the left column. The revised **Multi cell settings** page shows the relevant base stations synchronized together. By default, the system uses the first registered base station as the master base unit.

These settings are DECT settings for the system.

RFPI System:

Allow multi primary:

Auto configure DECT sync source tree

Base station settings

Number of SIP accounts before distributed load:

SIP Server support for multiple registrations per account: (used for roaming signalling)

Base Station Group

	ID	RPN	Version	MAC-Address	IP-Address	IP Status	DECT sync source	DECT property	Base Station Name
<input type="checkbox"/>	0	00	163	00:08:7B:07:7C:E8	192.168.11.105	This Unit	Primary:RPN00	Primary	SME VoIP Configuration
<input type="checkbox"/>	1	04	163	00:08:7B:07:7D:11	192.168.11.104	Connected	(any) RPN		

[Check All](#) / [Uncheck All](#)
 With selected: [Remove from chain](#)

DECT Chain
 Primary: RPN00: SME VoIP Configuration
 Warning: RPN04

STEP 13 On the Multi-cell settings page, scroll to the **DECT system settings** and Enable or Disable the “**Auto configure DECT sync option source tree**” (See description in the table below). The DECT system RFPI parameter is computed by the system (It’s often greyed in a multi-cell system configuration).

DECT system settings

These settings are DECT settings for the system.

DECT system RFPI:

Auto configure DECT sync source tree

STEP 14 Next, on the **MAC-units in chains** section, you can manually configure the synchronisation source tree of the multi-cell system. Multi-cell settings page, scroll to the DECT system settings and Enable or Disable the “**Auto configure DECT sync option source tree**” (See description in the table below). The DECT system RFPI parameter is computed by the system (Its often greyed in a multi-cell system)

MAC-units in chain

	ID	RPN	MAC address	IP address	Version	Status	DECT sync source	Dect Property
<input type="checkbox"/>	0	00	00:08:7B:07:7C:BC	192.168.50.71	34	Connected	0 - RPN: 00	Master
<input type="checkbox"/>	1	04	00:08:7B:07:7C:F7	192.168.50.114	34	Connected	0 - RPN: 00	Unknown!

[Check All](#) / [Uncheck All](#)
 With selected: [Remove from chain](#)

6.3 Summary of Procedure – Creating a Chain

We enumerate the short version of how to add 3 base stations units in a multi-cell setup. This can be applied for up to 40 number of base units.

This procedure is divided into four (4) main stages. Apply this procedure if all base unit are straight from production.

6.3.1 Stage 1

Skip this stage if relevant base stations are already in the network.

- a) Add 3 base stations i.e. RFP1, RFP2, RFP3 > Disable the “Multi cell system” option and “Save”
- b) RFP1, RFP2, RFP3: Reboot from the HTTP SME Configuration Main Page
- c) RFP1, RFP2, RFP3: Default by pressing reset button 12-sec.

6.3.2 Stage 2

Choosing 1st base unit i.e. RFP1 as Primary

- a) RFP1: Define Time server and “Save and reboot” from the **Time** page
- b) RFP1: Reboot automatically
- c) RFP1: Press “Add server” and define SIP server IP and “Save” from the **Servers** page
- d) RFP1: On the **extension** page add one extension (no handset needs to be registered). This step is important for allow secondary base to join
- e) RFP1: Multi cell system = enable and “Save” from the **Multi-cell** page
- f) RFP1: Reboot (Verify from Debug log “**SYNCMGR: This base is ready to be Primary in a Chain**”)

6.3.3 Stage 3

Choose another base unit, RFP2 as Secondary

- a) RFP2: Select chain ID same as RFP1.
- b) RFP2: Multi cell system = enable and “Save”
- c) RFP2: Reboot (Verify from Debug log “**SYNCMGR: This base is ready to join into another Chain**”)
- d) RFP1, RFP2: Wait 2min for stable Primary-Secondary chain (check for the message: **SYNCMGR: Socket#10 creation success**)

6.3.4 Stage 4

Choose the 3rd base unit, RFP3 as Secondary

- e) RFP3: Multi cell system = enable and “Save”
- f) RFP3: Reboot (Verify Debug log “**SYNCMGR: This base is ready to join into another Chain**”)
- g) RFP1, RFP3: Wait 2min for stable Master-Slave chain (**SYNCMGR: Socket#10 creation success**)
- h) RFP3: Check mark ID2/RPN08 and select dropdown “1 – RPN: 04” and “Save”
- i) RFP3: Reboot (**SYNCMGR: Socket#8 creation success**)

Multi-cell chain of 3 base stations has been created successfully. Next step involves adding extensions to the system.

6.4 Practical Configuration of Multi-cell System

In this chapter we describe what exactly to configure in the SME VoIP Configuration Interface ensure these scenarios really work.

6.4.1 Case ##1: Isolated Buildings

The optimal configuration for isolated buildings is standalone base stations setting. In this setting, you must:

- Using the figure below as illustration, log into the Configuration Interface of each base station.
- Configure the Time Server, SIP Server, Extensions as described in the previous chapters.
- On the main page of the configuration interface, click **Network** URL > disable the Multi-cell parameter of each base station > Save and Reboot each base to complete the Case ##1 setup.

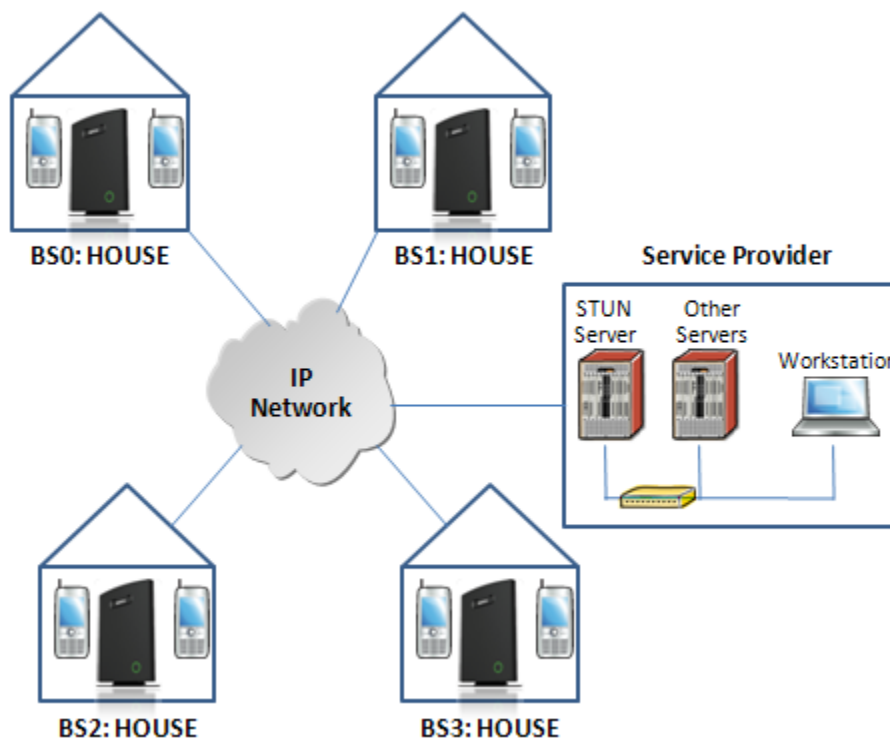

Disable Multi Cell option of Base Stations

Settings for this unit

These settings are used to connect this unit to a system.

Multi cell system:	<input type="text" value="Disable"/>
System chain ID:	<input type="text" value="2275"/>
Synchronization time (s):	<input type="text" value="60"/>
Multi cell debug:	<input type="text" value="Disable"/>

6.4.2 Case ##2: Location with co-located partners

Example includes Department shops, Retail location with co-located photo kiosk or pharmacy, etc. To illustrate this setup, two slave base stations are synchronised to one master base in the two office blocks.

Here is diagram to illustrate Case ##2.

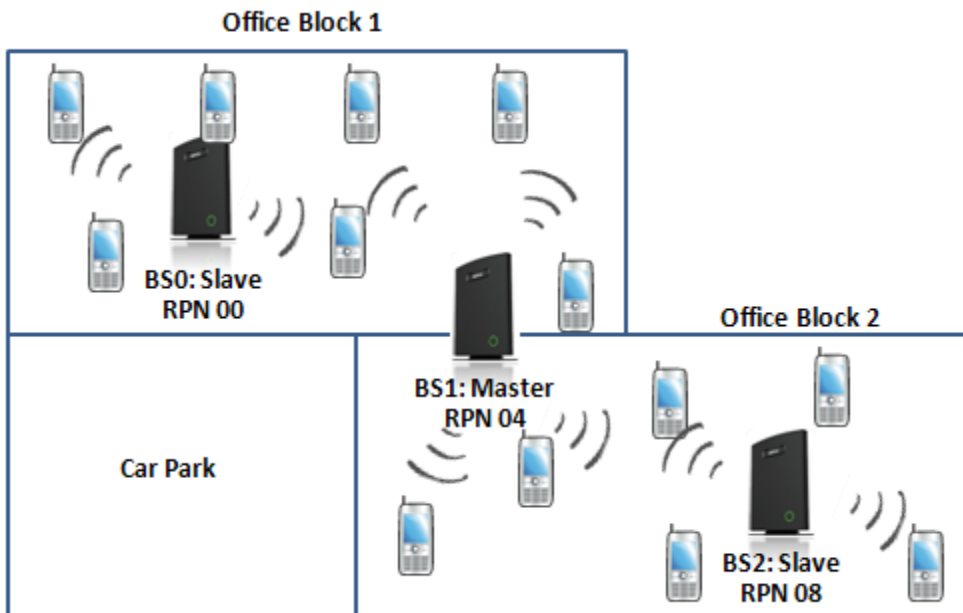

The procedure:

- STEP 1** Follow the steps described in section 0
- STEP 2** On the **Network** page of each base define the **DECT sync source** settings as illustrated in the table below.
- STEP 3** Save and reboot each base to complete case ##2 setup

Multi Cell Page of Base Stations

Recommended settings of MAC-units in Chain section of page (Other different settings exist):

RPN	Ver	MAC Addr	IP Addr	IP Status	DECT sync source	DECT Property
00	XX	XX:XX:XX...	XXX.XXX...	Connected	1: RPN:04	
04	XX	XX:XX:XX...	XXX.XXX...	Connected	1: RPN:04	Primary
08	XX	XX:XX:XX...	XXX.XXX...	Connected	1: RPN:04	

6.4.3 Case ##3: Large to Medium Sized Enterprises

In this scenario, we have five slave bases synchronised to one master base. The master base is located in office block B while the slave bases are spread across the whole enterprise. No base station is deployed in the lift because it has high attenuation properties that will drastically reduce radio signals.

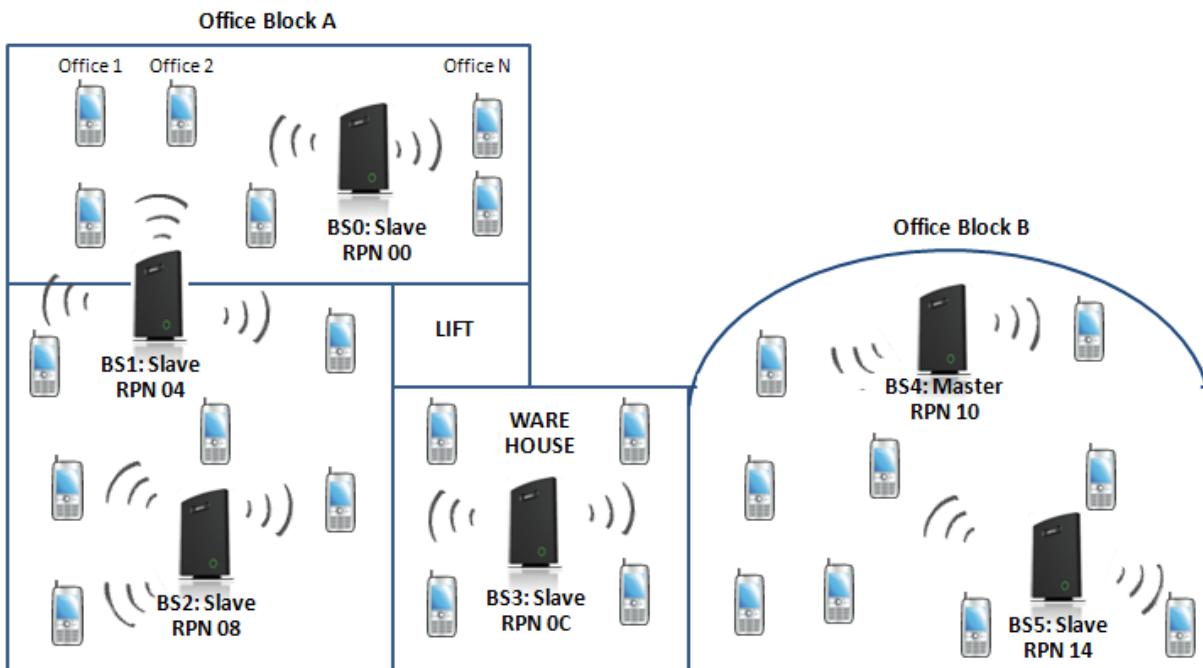

The procedure:

- STEP 1** Follow the steps described in sections 0
- STEP 2** On the **Network** page of each base define the **DECT sync source** settings as illustrated in the table below.
- STEP 3** Save and reboot each base to complete case ## 3 setup

Multi Cell Page of Base Stations

Recommended settings of MAC-units in Chain section of page (Other valid setting exists):

NOTE:

The number of chains cannot exceed **24** levels.

RPN	Ver	MAC Addr	IP Addr	IP Status	DECT sync source	DECT Property
00	XX	XX:XX:XX...	XXX.XXX...	Connected	1: RPN:04	
04	XX	XX:XX:XX...	XXX.XXX...	Connected	2: RPN:08	
08	XX	XX:XX:XX...	XXX.XXX...	Connected	3: RPN:0C	
0C	XX	XX:XX:XX...	XXX.XXX...	Connected	4: RPN:10	
10	XX	XX:XX:XX...	XXX.XXX...	Connected	4: RPN:10	Primary
14	XX	XX:XX:XX...	XXX.XXX...	Connected	4: RPN:10	

6.4.4 Case ##4: Large Enterprises at Different Locations

In this scenario, multi-cell systems are deployed at different locations; geographically separated from each other. Each location has a master base station with more than one slave base synchronise to it.

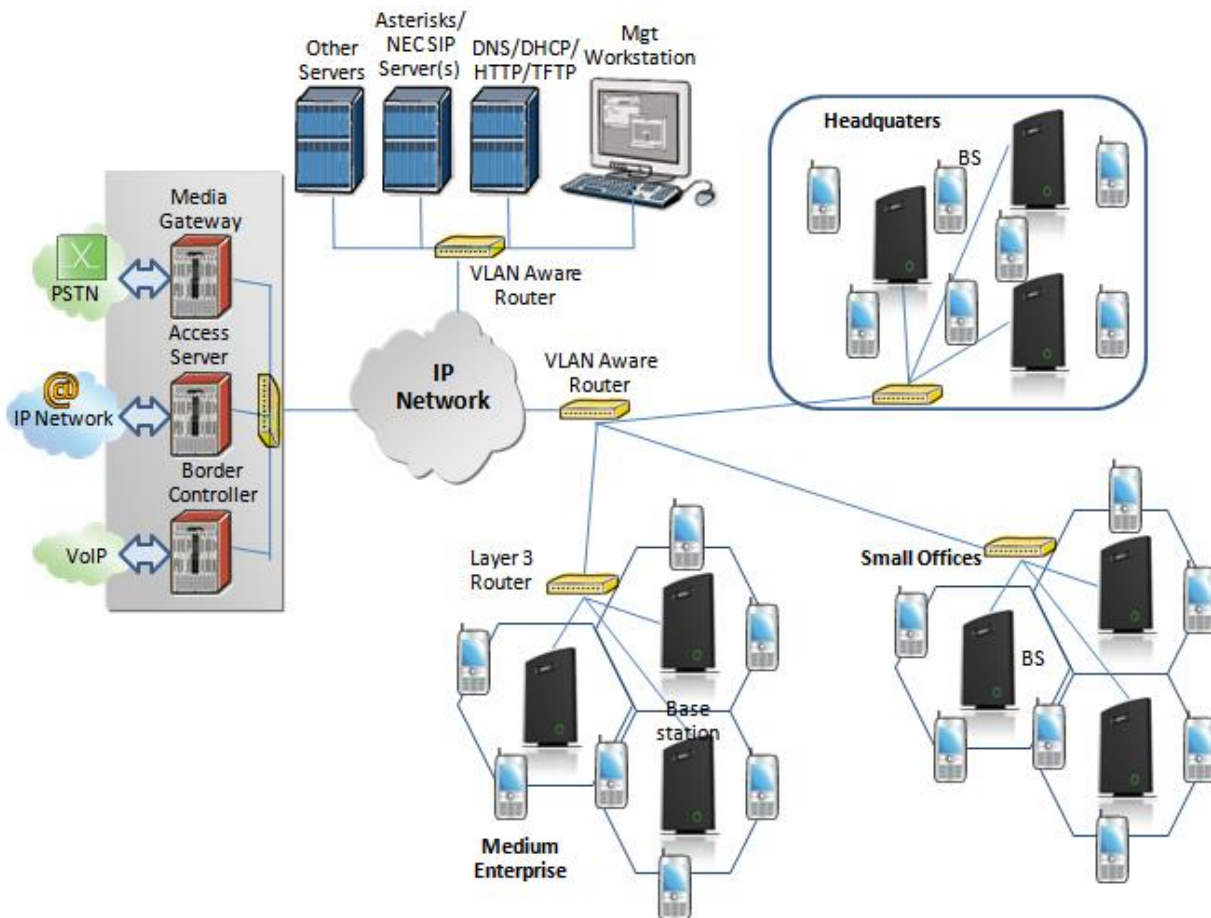

The procedure:

- STEP 1** Follow the steps described in sections 6
- STEP 2** On the **Network** page of each base define the **DECT sync source** settings as illustrated in the table below.
- STEP 3** Save and reboot each base to complete case ## 4 setup
- STEP 4** Important for this configuration is to enable “Allow multi primary” on the multi cell page. This allows the handset to locate on both systems make it possible for the user move from one location to the other and still use the same handset.

Multi Cell Page of Base Stations

Recommended settings of MAC-units in Chain section of page (Other valid setting exists):

RPN	Ver	MAC Addr	IP Addr	IP Status	DECT sync source	DECT Property
00	XX	XX:XX:XX...	XXX.XXX...	Connected	0: RPN:00	Primary for HQ
04	XX	XX:XX:XX...	XXX.XXX...	Connected	0: RPN:00	
08	XX	XX:XX:XX...	XXX.XXX...	Connected	1: RPN:04	

0C	XX	XX:XX:XX...	XXX.XXX...	Connected	3: RPN:0C	Primary for Offices
10	XX	XX:XX:XX...	XXX.XXX...	Connected	3: RPN:0C	
14	XX	XX:XX:XX...	XXX.XXX...	Connected	4: RPN:10	
18	XX	XX:XX:XX...	XXX.XXX...	Connected	6: RPN:18	Primary for Enterprises
1C	XX	XX:XX:XX...	XXX.XXX...	Connected	6: RPN:18	
20	XX	XX:XX:XX...	XXX.XXX...	Connected	7: RPN:1C	

7 Registration Management - Handset

In this chapter we briefly describe how to register handsets in the SME VoIP Network. A precondition for handset registration is a proper configured single or multi-base system. For this refer to chapter 6.1.

7.1 Register handset to base (non multiline)

This section describes how to register the wireless handset to the base station.

NOTE:

Minimum one server must be registered to the base (system), otherwise a handset cannot be registered to the system. Please see chapter 6.1.2.

- STEP 1** Login to a base station.
- STEP 2** Select “Extensions” URL and click “Add extension” link
- STEP 3** Fill out the form and click “Save”. In the example below we add the extension “3020” and this SIP account got the same number as “Authentication User Name” and “Password”. The “Server 1” is selected by default as server for this extension.

- STEP 4** In the extensions list set a Check mark on the extension which shall be assigned to the handset you want to register and click “Register handset (s)”. The base is now open (ready state) for handset registrations for 5 minutes.

Idx	Extension	Display Name	IPEI
<input checked="" type="checkbox"/>	3020	Matthew	FF:FF:FF:FF

STEP 5 Start the registration procedure on the handset by following step “a” to “d” below.

a) Select main menu “Connectivity”



b) Select menu “Register”

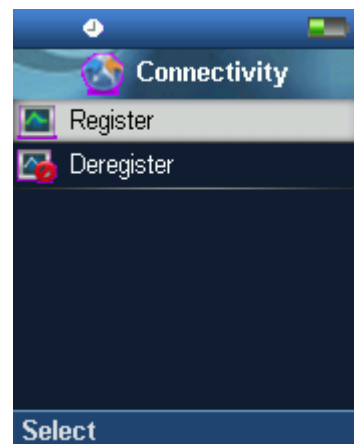

c) Type in the “AC code” and press “OK” to start the registration. The default AC code is “0000”.

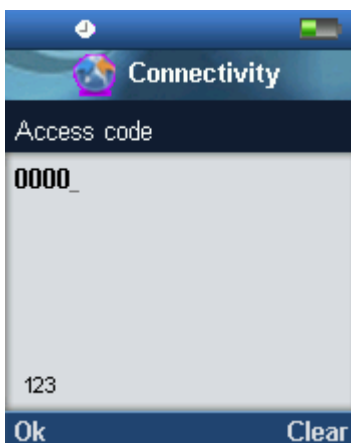

d) After a while the handset is registered, and the idle display is shown.

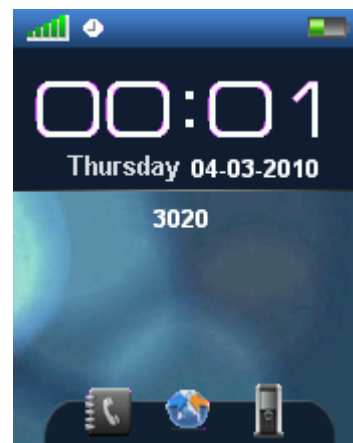

NOTE:

The unique handset IPEI is displayed on sheet “Extensions” when the handset is successfully registered. The web page must be manually updated by pressing “F5” to see that the handset is registered; otherwise the handset IPEI (International Portable Equipment Identity) isn’t displayed on the web page.

We illustrate how extensions page will be when you register several handsets.

Server 1:					
	Idx	Extension	Display Name	IPEI	State
<input type="checkbox"/>	0	165	165	11:6E:50:02:17	Present@RPN00
<input type="checkbox"/>	1	164	164	11:6E:50:01:19	Present@RPN00
<input type="checkbox"/>	2	163	163	01:6E:50:00:78	
<input type="checkbox"/>	3	162	162	11:6E:50:00:F6	Present@RPN04
<input type="checkbox"/>	4	161	161	11:6E:50:01:10	Present@RPN00
<input type="checkbox"/>	5	160	160	11:6E:50:01:23	Present@RPN04

7.2 Register handset to base (multiline)

This section describes how to register the wireless handset to a system with active multiline feature.

NOTE:

Minimum one server must be registered to the base (system), otherwise a handset cannot be registered to the system. Please see chapter 6.1.2.

- STEP 1** Login to a base station.
- STEP 2** Select “Extensions” URL and click “Add extension” link
- STEP 3** Fill out the form and click “Save”. In the example below we add the extension “3020” and this SIP account got the same number as “Authentication User Name”, “Password” and “Display Name”.

Add extension

Line name:

Handset:

Extension:

Authentication User Name:

Authentication Password:

Display Name:

- STEP 4** In the handset and extensions list set a Check mark on the handset Idx, which you want to register and click “Register handset (s)”. The base is now open (ready state) for handset registrations for 5 minutes.

Extensions

Server 1:
192.168.11.99

[Add extension](#)

[Refresh](#)

Idx	IPEI	Handset State	FW Info	FWU Progress	VoIP Idx	Extension	Display Name	State		
<input type="checkbox"/>	0	021727B541	Present@RPN00	303	Complete	<input type="checkbox"/>	0	2308	2308	SIP Registered@RPN00
<input type="checkbox"/>	1	1188700011	Present@RPN00	303	Complete	<input type="checkbox"/>	1	2309	2309	SIP Registered@RPN00
<input checked="" type="checkbox"/>	2	FFFFFFFF				<input type="checkbox"/>	2	3020	3020	

[Check All / Uncheck All](#) [Check All Extensions / Uncheck All Extensions](#)

With selected: Delete Handset(s) Register Handset(s) Deregister Handset(s) Start SIP Registration(s) SIP Delete Extension(s)

- STEP 5** Start the registration procedure on the handset by following step “a” to “d” below.

a) Select main menu "Connectivity"



b) Select menu "Register"

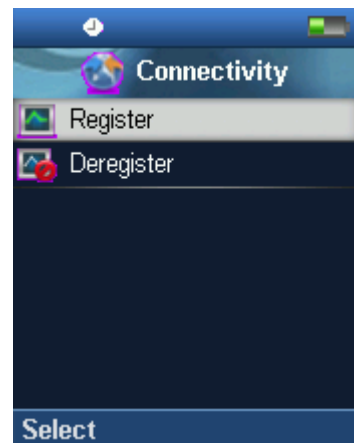

c) Type in the "AC code" and press "OK" to start the registration. The default AC code is "0000".

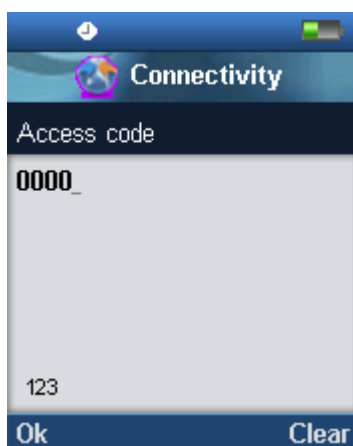

d) After a while the handset is registered, and the idle display is shown

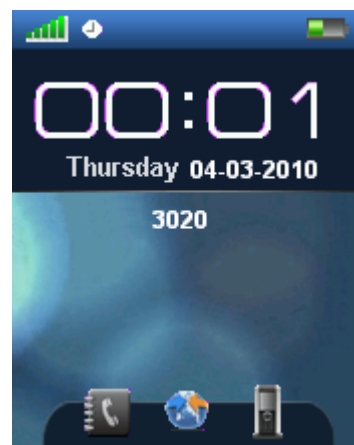

STEP 6 Confirm the registration from the unique handset IPEI is displayed in column "IPEI" when the handset is successfully registered.

Note: The web page must be manually updated by pressing "F5" to see that the handset is registered; otherwise the handset IPEI (International Portable Equipment Identity) isn't displayed on the web page.

STEP 7 SIP registration for first extension is made automatically. For the second extension start the SIP registration procedure on the base by Check the extension and click "Start SIP Registration(s)".

Extensions

Server 1:
192.168.11.99

[Add extension](#)

[Refresh](#)

Server 1:

	Idx	IPEI	Handset State	FW Info	FWU Progress		VoIP Idx	Extension	Display Name	State
<input type="checkbox"/>	0	021727B541	Present@RPN04	303	Complete	<input type="checkbox"/>	0	2308	2308	SIP Registered@RPN04
<input type="checkbox"/>	1	1188700011	Present@RPN00	303	Complete	<input type="checkbox"/>	1	2309	2309	SIP Registered@RPN00
<input type="checkbox"/>	2	021727B55F	Present@RPN04	303	Complete	<input checked="" type="checkbox"/>	2	3020	3020	SIP Registered@RPN04
Check All / Uncheck All						Check All Extensions / Uncheck All Extensions				

With selected: [Delete Handset\(s\)](#) [Register Handset\(s\)](#) [Deregister Handset\(s\)](#) [Start SIP Registration\(s\)](#) [SIP Delete Extension\(s\)](#)

STEP 8 Confirm the SIP registration by SIP State in right column.

Extensions

Server 1:
192.168.11.99

[Add extension](#)

[Refresh](#)

Server 1:

	Idx	IPEI	Handset State	FW Info	FWU Progress		VoIP Idx	Extension	Display Name	State
<input type="checkbox"/>	0	021727B541	Present@RPN04	303	Complete	<input type="checkbox"/>	0	2308	2308	SIP Registered@RPN04
<input type="checkbox"/>	1	1188700011	Present@RPN00	303	Complete	<input type="checkbox"/>	1	2309	2309	SIP Registered@RPN00
<input type="checkbox"/>	2	021727B55F	Present@RPN04	303	Complete	<input type="checkbox"/>	2	3020	3020	SIP Registered@RPN04
Check All / Uncheck All						Check All Extensions / Uncheck All Extensions				

With selected: [Delete Handset\(s\)](#) [Register Handset\(s\)](#) [Deregister Handset\(s\)](#) [Start SIP Registration\(s\)](#) [SIP Delete Extension\(s\)](#)

Note: The web page must be manually updated by pressing “F5” to see that the handset is SIP registered; otherwise the handset SIP state isn’t displayed on the web page.

7.3 Register handset to base and specific extension (multiline)

This section gives an example of controlling handset registration to a specific extension.

- STEP 1** Login to a base station.
- STEP 2** Select “Extensions” URL and click “Add extension” link
- STEP 3** Fill out the form and click “Save”. In the example below we add the extension “2512” with display name “Reserved”

Extensions

Server 1:

Server 1:
192.168.11.99

Server 2
192.168.11.10

Server 3
192.168.11.12

Server 4
192.168.11.12

[Add extension](#)

[Refresh](#)

Idx	IPEI	Handset State	FW Info	FWU Progress	VoIP Idx	Extension	Display Name	State
<input type="checkbox"/> 0	118870423A	Present@RPN98	300	Off	N/A	N/A	N/A	N/A
<input type="checkbox"/> 2	1188700BA9	Present@RPN7C	300	Off	<input type="checkbox"/> 128	2628	2628	SIP Registered@RPN7C
<input type="checkbox"/> 4	FFFFFFFF				N/A	N/A	N/A	N/A
<input type="checkbox"/> 5	FFFFFFFF				<input type="checkbox"/> 4	4444	444	
<input type="checkbox"/> 6	FFFFFFFF				<input type="checkbox"/> 5	2511	Reserved	
<input type="checkbox"/> 7	FFFFFFFF				<input type="checkbox"/> 152	5555	5555	
<input type="checkbox"/> 8	FFFFFFFF				<input type="checkbox"/> 153	7777	7777	
<input type="checkbox"/> 9	FFFFFFFF				<input type="checkbox"/> 6	2512	Reserved	
<input type="checkbox"/> 10	FFFFFFFF				<input type="checkbox"/> 7	2513	Reserved	

- STEP 4** Extension 2512 is now listed with handset IPEI “FFFFFFFF”. Click the IPEI “FFFFFFFF” link and get the below view.

Handset

Location:

IPEI:

AC:

- STEP 5** Enter the IPEI of handset which must register to this particular extension and press “Save”

Handset

Location:

IPEI:

AC:

- STEP 6** Check mark the handset Idx in left column and press “Register Handset(s)”
- STEP 7** With the handset run the handset registration procedure using AC code “0000”
- STEP 8** Confirm the registration success by “Handset State” column.

Extensions

Server 1:
192.168.11.99

Server 2:
192.168.11.10

Server 3:
192.168.11.12

Server 4:
192.168.11.12

[Add extension](#)

[Refresh](#)

Server 1:

Idx	IPEI	Handset State	FW Info	FWU Progress	VoIP Idx	Extension	Display Name	State	
<input type="checkbox"/>	0	118870423A	Present@RPN98	300	Off	N/A	N/A	N/A	
<input type="checkbox"/>	2	1188700BA9	Present@RPN7C	300	Off	<input type="checkbox"/> 128	2628	2628	SIP Registered@RPN7C
<input type="checkbox"/>	4	FFFFFFFFF				N/A	N/A	N/A	
<input type="checkbox"/>	5	FFFFFFFFF				<input type="checkbox"/> 4	4444	444	
						<input type="checkbox"/> 5	2511	Reserved	
						<input type="checkbox"/> 152	55555	5555	
						<input type="checkbox"/> 153	7777	7777	
<input type="checkbox"/>	6	021727B3A	Present@RPN04	300	Off	<input type="checkbox"/> 6	2512	Reserved	SIP Registered@RPN04
<input type="checkbox"/>	7	FFFFFFFFF				<input type="checkbox"/> 7	2513	Reserved	

Note: It is possible with similar procedure to register using a different AC code than 0000 simply by changing the AC code in step 5.

Note: It is possible to SIP register a handset with extensions on different servers by using the edit extension link and pair the extension to a handset Idx.

8 Firmware Upgrade Procedure

This step-by-step chapter describes how to upgrade or downgrade base station(s) and/or handset(s) / repeater (s) to the relevant firmware provided by RTX.

8.1 Network Dimensioning

In principle, a number of hardware and software components should be available or be satisfied before base station/handset update can be possible.

The minimum hardware and software components that are required to be able update via TFTP include the following (but not limited to):

- Handsets
- Base stations
- TFTP Server (Several Windows and Linux applications are available)
- DHCP Server (Several Windows and Linux applications are available)
- Workstation (e.g. Normal terminal or PC)
- Any standard browser (e.g. Firefox)
- Public/Private Network

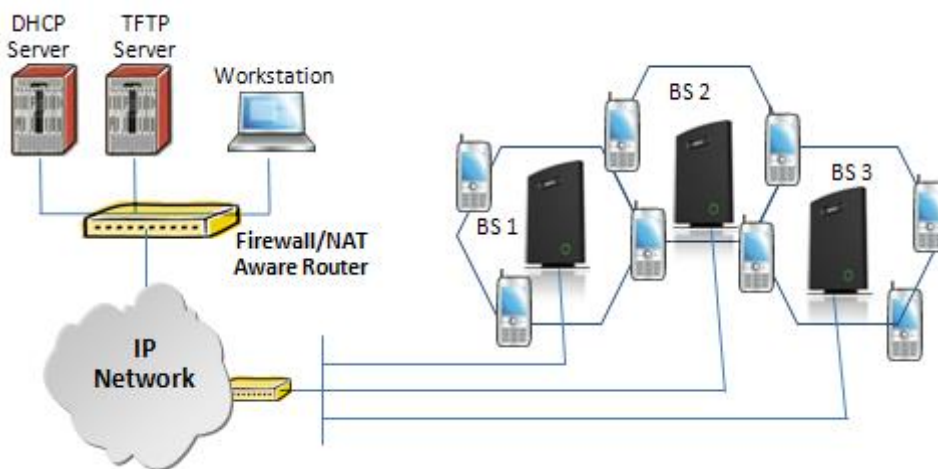

8.2 TFTP Configuration

This section illustrate TFTP Server configuration using “SolarWinds” vendor TFTP Server. Create the following relevant folders as shown in the snap shots and choose defaults settings for the remaining options and save.

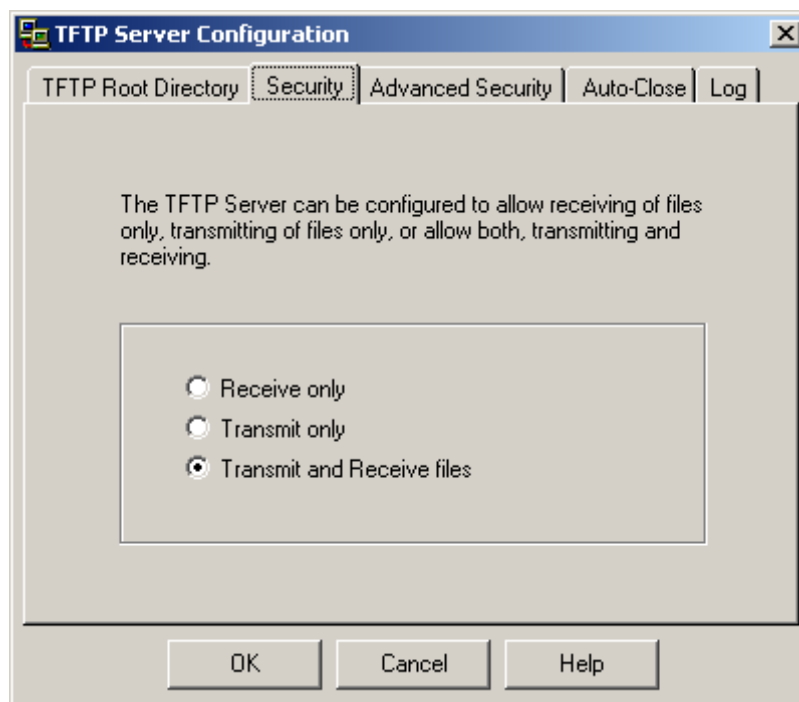
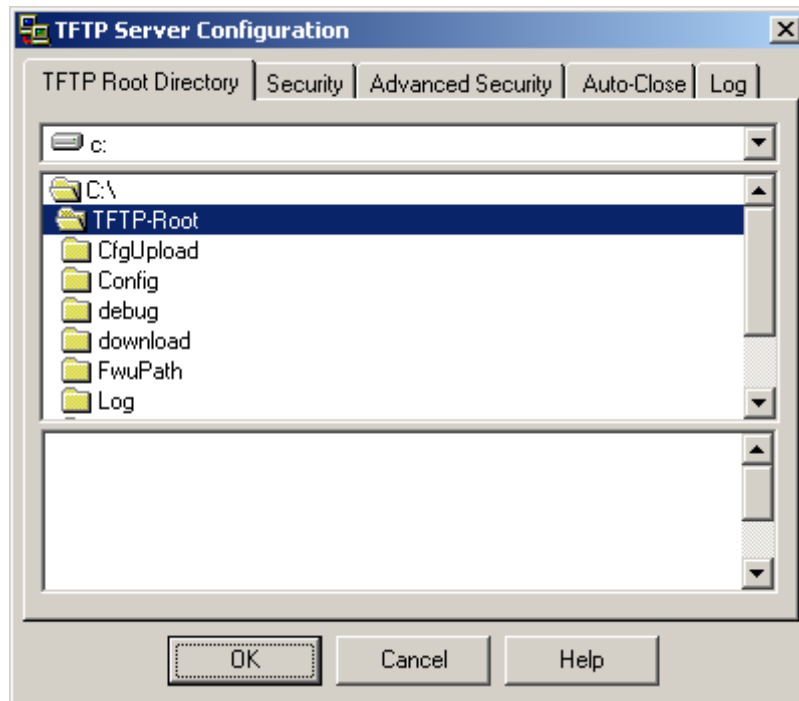

NOTE: If TFTP server timeout settings are too short firmware upgrade might not complete. Recommended time out setting is more than 3 seconds.

8.3 Create Firmware Directories

The admin from the service provider’s side must create the relevant firmware directory in the server where both old and new firmware(s) can be placed in it. (See the STEP above)

8.3.1 Base:

On the TFTP server root, create directory “Beatus”.

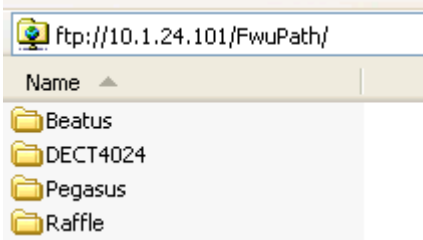

Copy Base station firmware to the named directory.

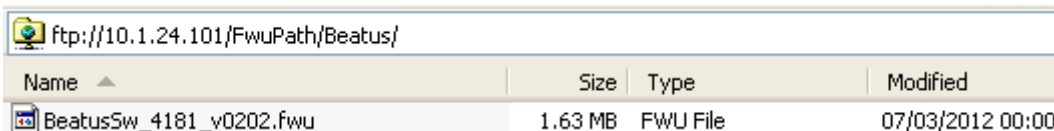

IMPORTANT:

The **Beatus** directory name cannot be changed.

8.3.2 Handsets/Repeaters:

On the TFTP server root, create directory “Pegasus” or “Raffle” or “Razor” or “DECT4024” depending on type.

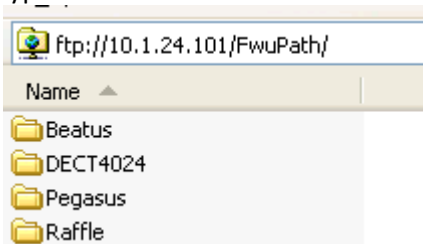

Copy handset/repeater firmware to the named directory.

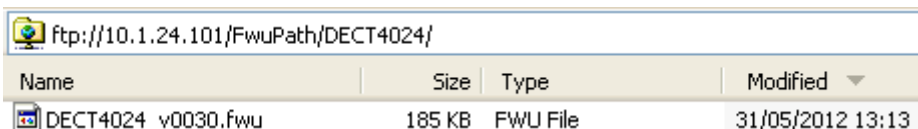
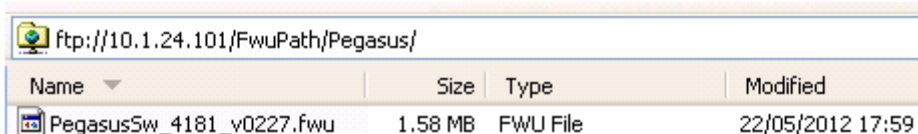
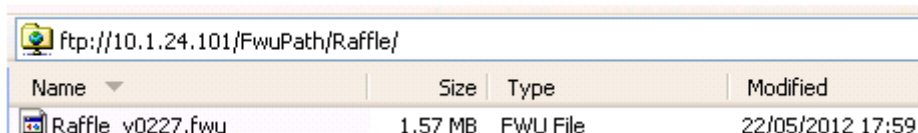

IMPORTANT:

The **Raffle**, **Pegasus**, **DECT4024** directory names cannot be changed.

8.4 Handset Firmware Update Settings

Scroll down and Click on **Firmware Update** url link in the **SME VoIP Configuration Interface** to view the **Firmware Update Settings** page.

Firmware Update Settings

Firmware update server address:

Firmware path:

Type	Required Version	
UXP1240H	<input type="text" value="0"/>	Pegasus
8630	<input type="text" value="227"/>	Raffle
DECT4024	<input type="text" value="0"/>	Repeater

Update Base Stations

Update this Base Station only

Update all Base Stations

Required Version

Type IP address and firmware path followed by save.

For Http download the firmware update server settings must be entered as follows:

SME VoIP (RTX Chain B208 - 1)

Firmware Update Settings

Firmware update server address:

Firmware path:

8.5 Handset(s) and Repeater Firmware Upgrade

On the **Firmware Update Settings** page enter the relevant handset/repeater firmware for each type (e.g. 273 for V273) to upgrade or downgrade > press **Save** button to initialize the process of updating all handsets.

Firmware Update Settings

Firmware update server address:

Firmware path:

Type	Required Version
8630	<input type="text" value="280"/>
DECT4024	<input type="text" value="33"/>
8430	<input type="text" value="7"/>

NOTE: To disable handset/repeater firmware process type version 0 in the required version field, followed by the save button. It is recommended to use version 0 after all units are upgraded.

NOTE: For handset TFTP/HTTP download only one handset type can be downloaded at the same time. In case two handset models are defined for fwu at the same time fwu will fail.

8.5.1 Monitor handset firmware upgrade

Handset firmware upgrade status is monitored on the handset extensions page, right column.

Extensions

Server 1:
192.168.11.99

Idx	Extension	Display Name	IPEI	State	FW Info	FWU Progress
<input type="checkbox"/>	114	2614	2614	11:6E:50:02:F8	SIP Registered@RPN04	273.1 Complete
<input type="checkbox"/>	115	2615	2615	11:6E:50:03:3D	SIP Registered@RPN98	273.1 Complete
<input type="checkbox"/>	116	2616	2616	11:6E:50:03:56	SIP Registered@RPN7C	273.1 Complete
<input type="checkbox"/>	117	2617	2617	FF:FF:FF:FF:FF		
<input type="checkbox"/>	118	2618	2618	11:6E:50:02:6C	SIP Registered@RPN98	273.1 Complete
<input type="checkbox"/>	119	2619	2619	FF:FF:FF:FF:FF		
<input type="checkbox"/>	120	2620	2620	11:6E:50:02:EC	SIP Registered@RPN68	273.1 Complete
<input type="checkbox"/>	121	2621	2621	11:6E:50:02:EB	SIP Registered@RPN28	273.1 Complete
<input type="checkbox"/>	122	2622	2622	11:6E:50:02:FB		
<input type="checkbox"/>	123	2623	2623	11:6E:50:02:B3	SIP Registered@RPN68	273.1 Complete
<input type="checkbox"/>	124	2624	2624	11:6E:50:03:62	SIP Registered@RPN58	273.1 Complete
<input type="checkbox"/>	125	2625	2625	11:6E:50:03:25	SIP Registered@RPN28	273.1 Complete

[Check All](#) / [Uncheck All](#)
 With selected: [Delete Extension\(s\)](#), [Register Handset\(s\)](#), [Deregister Handset\(s\)](#)

Handset firmware update time from start to complete takes minimum 40 minutes.

8.5.2 Monitor Repeater firmware upgrade

Repeater firmware upgrade status is monitored on the Repeater page, right column.

Repeater firmware upgrade time from start to complete takes minimum 20 minutes.

8.5.3 Verification of Firmware Upgrade

The firmware upgrade is confirmed by the FWU Progress status in the second and first right column on the handset extension list or repeater list. The “FWU info” column contains the software version and the “FWU Progress” column contains the status. In case status is “Complete”, the unit is firmware upgraded.

Alternatively the handset firmware can be verified from the Handset **Menu** by navigate to **Settings** > Scroll down to **Status** this will list information regarding Base station and Handset firmware versions.

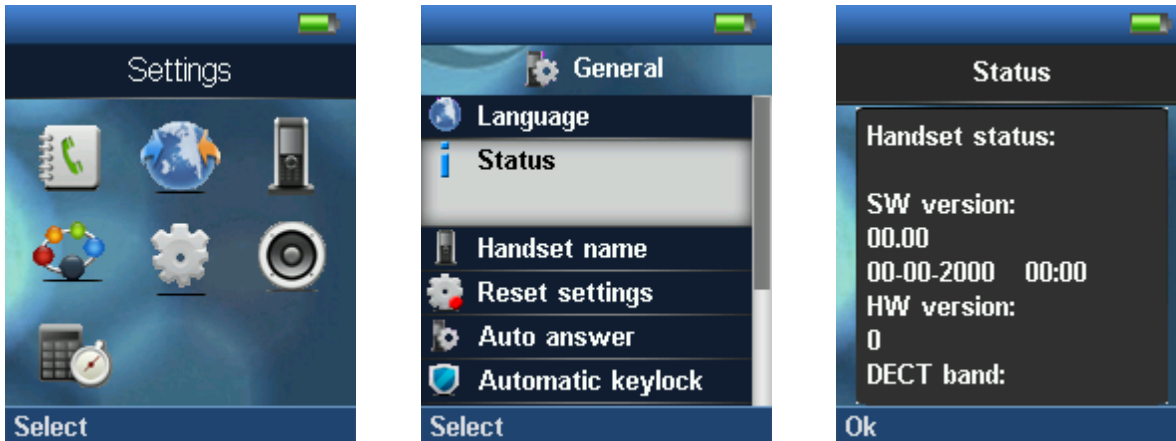

8.6 Base Station(s) Firmware Upgrade

On the **Firmware Update Settings** page > scroll down to the **Update Gateways** section > Enter the relevant firmware version of the base station to upgrade or to downgrade. Enter 202 for base version V0202.

For multi cell upgrade remember to check “update all Base Stations”.

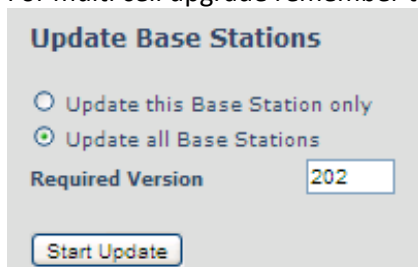

Efter entering required version choose **Start update** button > select **OK** button from the dialog window to start the update/downgrade procedure.

The relevant base station(s) will automatically reboot and retrieve the firmware specified from the server and update itself accordingly.

The base firmware update behaviour is: Base will fetch the fwu file for approximately 3 minutes, then reboot and start flashing the LED - indicated by LED fast flashing for approximately 3 minutes and reboots in new version.

Note: All on-going voice calls are dropped from the base station(s) immediately the firmware update procedure starts.

8.6.1 Base firmware confirmation

Base station firmware version status in a multicell environment can be seen in the multicell base station group overview page, column 4.

Base station settings

Number of SIP accounts before distributed load:

SIP Server support for multiple registrations per account: (used for roaming signalling)

Base Station Group

ID	RPN	Version	MAC-Address	IP-Address	IP Status	DECT sync source	DECT property	Base Station Name
<input type="checkbox"/>	0	00	273.1	00:08:7B:08:5F:51	192.168.11.90	Connected	Level 11:RPN44 (-62dBm)	Locked (RTX Chain Canteen1 - static IP)
<input type="checkbox"/>	40	A0	273.1	00:08:7B:08:02:6D	192.168.11.147	Connected	Select as primary	Primary SME VoIP (RTX Chain B214)
<input type="checkbox"/>	41	A4	273.1	00:08:7B:08:5F:91	192.168.11.101	Connected	Level 4:RPN4C (-35dBm)	Locked SME VoIP (RTX Chain A214)
<input type="checkbox"/>	43	AC	273.1	00:08:7B:08:42:1C	192.168.11.106	Connected	Level 4:RPN84 (-50dBm)	Locked SME VoIP (RTX Chain B220)
<input type="checkbox"/>	44	B0	273.1	00:08:7B:08:41:94	192.168.11.155	Connected	Level 1:RPN7C (-22dBm)	Locked SME VoIP (RTX Chain B208 - 2)
<input type="checkbox"/>	49	C4	273.1	00:08:7B:08:02:6C	192.168.11.163	Connected	Level 3:RPN30 (-45dBm)	Locked SME VoIP (RTX Chain B103)

[Check All](#) / [Uncheck All](#)
With selected: [Remove from chain](#)

8.6.2 Verification of Firmware Upgrade

Syslog information when Management Syslog level is set to “Debug”

```
[ FWU Downloading File tftp://10.1.24.101/FwuPath/Beatus/BeatusSw_4181_v0202.fwu]
[ Base FWU started]
[ Base FWU ended with exit code 2101 (NE_FILE_TRANSFER_EOF): End of file]
```

The log window of the TFTP server:

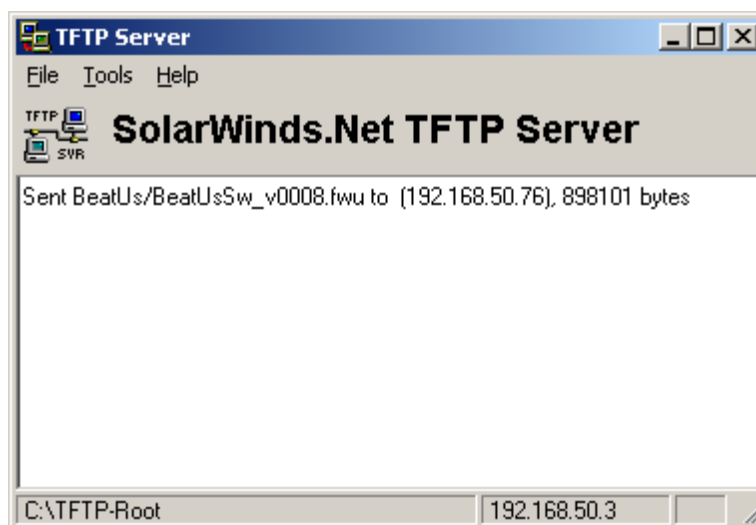

9 Functionality Overview

So far we have setup our SME VoIP system. Next, in this chapter we list what features and functionalities are available in the system. The SME VOIP system supports all traditional and advanced features of most telephony networks. In addition, 3rd party components handle features like voice mail, call forward, conference calls, etc. A brief description of SME VOIP network functionalities are:

- **Outgoing/incoming voice call management:** The SME VOIP system can provide multiple priority user classes. Further, up to 3 repeaters can be linked to a Base-station.
- **Internal handover:** User locations are reported to SIP Server in order to provide differentiated services and tariff management. Within a DECT traffic area, established calls can seamlessly be handover between Base-stations using connection handover procedures.
- **Security:** The RTX SME VOIP system also supports robust security functionalities for Base-stations. Most security² functionality is intrinsically woven into the SME VOIP network structure so that network connections can be encrypted and terminal authentication can be performed.

9.1 Gateway Interface

Connector interfaces	
Power	Connector: Ethernet PoE (Ethernet adaptor for normal power) IEEE 802.3: Power class 2 (3.84 – 6.49W)
LAN Interface	Standard : 10BASE-T(IEEE 802.3 100Mbps) Connector: RJ45 8/8
Internet Protocol:	<ul style="list-style-type: none"> • IPv4 • IPv6
Keys	
	1 x Reset key
LED indicator	
	One Status LED (multicolor, red, green, orange)
RF	
Frequency Bands	1880 – 1900 MHz (EMEA) 1910 – 1930 MHz (Latam) 1920 – 1930 MHz (USA) This is software settings and to be set when it is packed in factory.
Output Power	<250 mW (for USA < 140mW)
Antenna	Two antennas for diversity
Software update	
Downloadable	Remote firmware update HTTPS/TFTP

9.2 Detail Feature List

CODECs	
G.711 PCM A-law & U-law	Uncompressed voice Silence suppression (No)
G.722	Allows HD sound for the handset
G.726	ADPCM, 32 Kbps
G.729	A G.729.1 (ehem. G.729 EV)

² With active security with authentication 4 channels is supported

	Note: Only with additional module, this is an extra option that requires a board connector mounted in Gateway. Per default not mounted.
SIP	
RFC2327	SDP: Session Description Protocol
RFC2396	Uniform Resource Identifiers (URI): Generic Syntax
RFC2833	In-Band DTMF/Out of band DTMF support
RFC2976	The SIP INFO method
RFC3261	SIP 2.0
RFC3262	Reliability of Provisional Responses in the Session Initiation Protocol (PRACK)
RFC3263	Locating SIP Servers (DNS SRV, redundant server support)
RFC3264	Offer/Answer Model with SDP
RFC3265	Specific Event Notification
RFC3311	The Session Initiation Protocol UPDATE Method
RFC3325	P-Asserted Identity
RFC3326	The Reason Header Field for the Session Initiation Protocol (SIP)
RFC3489	STUN
RFC3515	REFER: Call Transfer
RFC3550	RTP: A Transport Protocol for Real-Time Application
RFC3581	Rport
RFC3842	Message Waiting Indication
RFC3891	Replace header support
RFC3892	The Session Initiation Protocol (SIP) Referred-By Mechanism
RFC3960	Early Media and Ringing Tone Generation in the Session Initiation Protocol (SIP)
RFC4475	Session Initiation Protocol (SIP) Torture Test Messages
SIPS	
SRTP	Will limit number of active calls pr. base when enabled.
Web server	
	Embedded web server HTTP
Other features	
Quality of service	Type of Service (ToS) including DiffServ Tagging, and QoS per IEEE 802.1p/q
IP Quality	Warning – Network outage, VoIP service outage
	Adaptive Jitter Buffer support
Automatic DST	
Tone Scheme	Country Depend Tone Scheme
Ethernet features	
Speed duplex	10 & 100 duplex
VLAN	VLAN (802.1p/q)
DHCP Support	
Static IP	
TLS 1.0	For secure connections (AES 128)
TFTP	For configuration download.
HTTP	For configuration download.
HTTPS	For secure configuration download.
TCP/IP/UDP	
SNTP	For internet clock synchronization
Quality of service	Type of Service (ToS) including DiffServ Tagging, and QoS per IEEE 802.1p/q
DHCP option	66
DNS srv	
DECT	
DECT CAP	Connectionless handover, enhanced location registration
CAT-IQ v1.0	Wideband Speech
General Telephony	
Handset Support	10 simultaneous handsets supported (single cell) (10 call / single cell and 8 call/Multi cell) Total 1000 simultaneous call supported / system

VoIP Accounts	30 VoIP accounts per base – (maximum 254 bases per installation) Total 1000 VoIP accounts / system
	Maximum 1000 handsets per installation
Simultaneous Calls	4 Wideband calls (g.722) or 10 single cell, 8 multi cell narrowband calls (PCMA, PCMU, G.726) or mixed wideband and narrowband.
Call features	Codec Negotiation
	Codec Switching
	Missed call notification
	Voice message waiting notification
	Date and Time synchronization
	Parallel calls
	Common parallel call procedures
	Call transfer unannounced
	Call transfer announced
	Conference
	Call Waiting
	Calling line identity restriction
	Outgoing call
	Call Toggle
	Incoming call
	Line identification
	Multiple Lines
	Multiple calls
	Call identification
	Calling Name Identification Presentation (CNIP)
	Calling Line Identification Presentation (CLIP)
	Call Hold
	List of registered handsets
Call log	50 mixed between Incoming, outgoing, missed calls
Phone Book	Common Phonebook with up to 3000 entries (Import via csv format)
	Common Phonebook LDAP V2.0
	Local Phonebook (100 entries 8630 and 50 entries 8430)
DND	Do Not Disturb
Call Forward	All
	No Answer
	Busy
	Individual Speed dial
	Programmable Function keys

Appendix

10 Appendix A: Basic Network Server(s) Configuration

In this chapter we describe how to setup the various server elements in the system.

10.1 Server setup

In the SME network, the server environment is installed as a centralized system.

The main server types hosted on the network include SIP, DNS/DHCP and HTTP/TFTP Servers. These servers can be hosted both in one or multiple windows and/or Linux Server environment.

Management servers are normally installed to monitor and manage the network in detail. Each Base-station status can be checked. Each Repeater and each Subscriber Terminal can be monitored over the air from a centralized location.

Further, new software can be uploaded to all system elements from the centralized location (typically a TFTP server) on an individual basis. This includes Subscriber Handsets where the latest software is downloaded over the air.

10.2 Requirements

Regardless of whether or not you will be installing a centrally provisioned system, you must perform basic TCP/IP network setup, such as IP address and subnet mask configuration, to get your organization's phones up and running.

10.3 DNS Server Installation/Setup

Name server is a name server service installed in a server for mapping or resolution of humanly memorable domain names and hostnames into the corresponding numeric Internet Protocol (IP) addresses.

The customer should refer to the platform vendor either windows or Linux vendor for detail step-by-step guide on how to install and configure Domain Name System for internet access. In this section, we briefly describe hints on how to setup DNS behind NAT or Firewall.

10.3.1.1 Hints on how to Configure DNS behind a Firewall/NAT

Proxy and Network Address Translation (NAT) devices can restrict access to ports. Set the DNS to use UDP port 53 and TCP port 53. For windows Servers, set the RCP option on the DNS Service Management console and configure the RCP to use port 135.

These settings should be enough to resolve some of potential issues that may occur when you configure DNS and firewalls/NAT.

10.4 DHCP Server Setup

A DHCP Server allows diskless clients to connect to a network and automatically obtain an IP address. This server is capable of supplying each network client with an IP address, subnet mask, default gateway, an IP address for a WINS server, and an IP address for a DNS server. This is very often used in enterprise networks to reduce configuration efforts. All IP addresses of all computers/routers/bases are stored in a database that resides on a server machine.

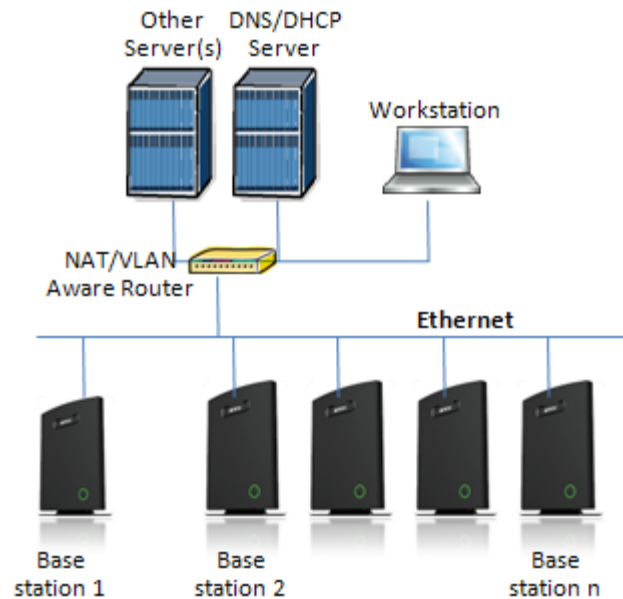

The network administrator should contact the relevant vendors for detail information or step-by-step procedure on how to install and setup DHCP process or service on windows/Linux servers. In this section, we will provide some hints of how to resolve potential problems to be encountered you setup DHCP Servers.

10.4.1 Hint: Getting DHCP Server to Work

Windows Server:

1) Clients are unable to obtain an IP address

If a DHCP client does not have a configured IP address; it generally means that the client has not been able to contact a DHCP server. This is either because of a network problem or because the DHCP server is unavailable. If the DHCP server has started and other clients have been able to obtain a valid address, verify that the client has a valid network connection and that all related client hardware devices (including cables and network adapters) are working properly.

2) The DHCP server is unavailable

When a DHCP server does not provide leased addresses to clients, it is often because the DHCP service has failed to start. If this is the case, the server may not have been authorized to operate on the network. If you were previously able to start the DHCP service, but it has since stopped, use Event Viewer to check the system log for any entries that may explain the cause.

Next, restart the DHCP service, click **Start**, click **Run**, type **cmd**, and then press ENTER. Type **net start dhcpserver**, and then press ENTER.

Linux Platform:

Troubleshooting DHCP, check the following:

- 1) Incorrect settings in the `/etc/dhcpd.conf` file such as not defining the networks for which the DHCP server is responsible;
- 2) NAT/Firewall rules that block the DHCP **bootp** protocol on UDP ports 67 and 68;
- 3) Routers failing to forward the **bootp** packets to the DHCP server when the clients reside on a separate network. Always check your `/var/logs/messages` file for dhcpd errors.
- 4) Finally restart the **dhcpd** service daemon

10.5 TFTP Server Setup

There are several TFTP servers in the market place; in this section we describe how to setup a commonly used TFTP Server.

10.5.1 TFTP Server Settings

The administrator must configure basic parameters of the TFTP application:

- Specify UDP 69 port – for TFTP incoming requests and TCP 12000 – for remote management of the server. For file transmission the server opens UDP ports with random numbers. In case the option **Enable NAT or firewall support** is activated on the server, the server uses the same port for files transmission and listening to the TFTP incoming requests (UDP 69 port on default).
- Specify the interface bindings, TFTP root directory, port which the TFTP Server will listen, timeout and number of retries, and TFTP options supported by the server.

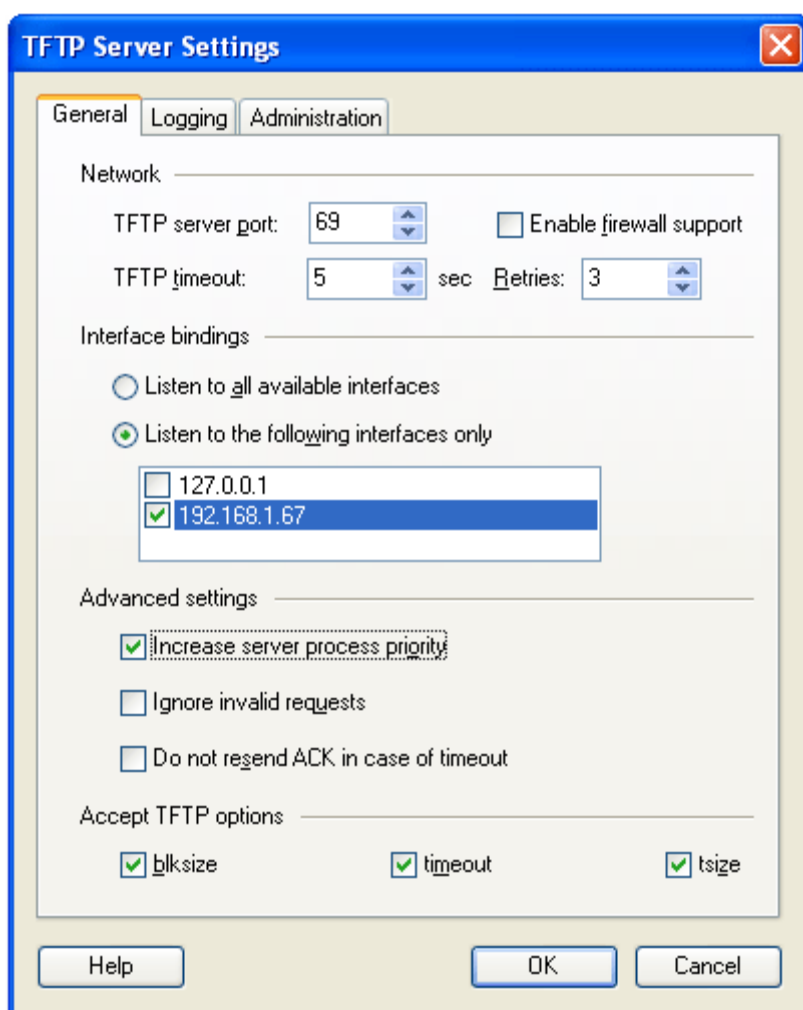

- Configure the relevant TFTP virtual folder in the server. The TFTP virtual folder is the file folder, visible for TFTP clients under a certain name. You can set security settings separately for every virtual TFTP folder. Next, set rights to access TFTP folders according to the relevant clients.

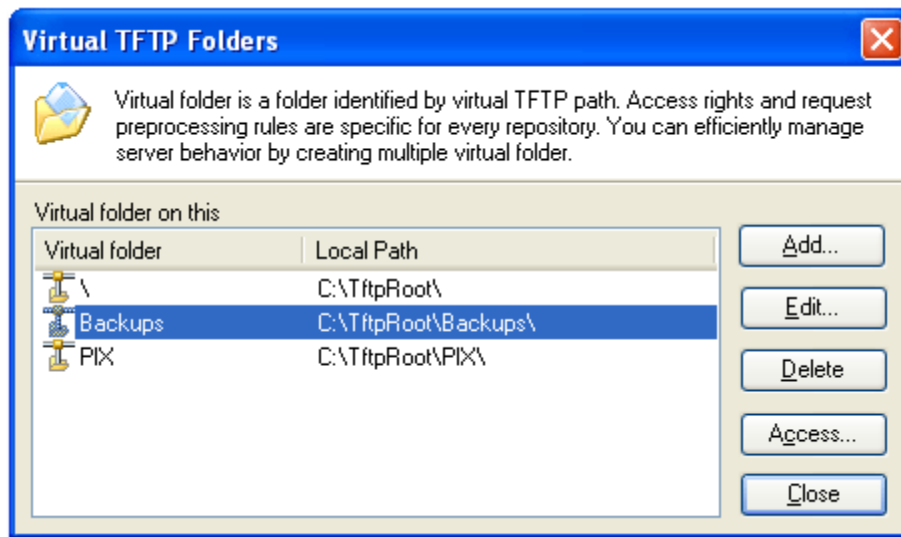

10.6 SIP Server Setup

SIP server is one of the main components of an SME network, dealing with the setup of all SIP calls in the network. A SIP server is also referred to as a SIP Proxy or a Registrar.

Although the SIP server is the most important part of the SIP based phone system, some servers only handles call setup and call tear down. It does not actually transmit or receive any audio. This is done by the media server in RTP.

The RTX SME family of network phones are fully interoperable with the most of SIP Server applications. There are many off-the-shelf vendor and open source SIP servers. In this section, we will briefly explain settings required to take full advantage of FreePBX SIP Server feature set. The settings are similar for other SIP servers.

10.6.1 FreePBX SIP Server

FreePBX is an easy to use GUI (graphical user interface) that controls and manages Asterisk, which the most popular open source telephony engine software.

The administrator should refer to the relevant detail step-by-step procedure of how to install FreePBX SIP server. This section briefly describes SIP Server setup parameters.

1) SIP Server Setup

Settings	Description
NAT	<p>This option determines the settings for users connecting to an asterisk server.</p> <p>Possible values: Yes, No, Never, Route</p> <p>NAT=route Asterisk will send the audio to the port and IP where it's receiving the audio from. Instead of relying on the addresses in the SIP and SDP messages. This will only work if the phone behind NAT send and receive audio on the same port and if they send and receive the signalling on the same port. (The signalling port does not have to be the same as the RTP audio port).</p> <p>NAT=No Asterisk will add an RPORT to the via header of the SIP messages</p> <p>NAT=never This will cause asterisk not to add an RPORT in the VIA line of the sip invite</p>

	header
Other NAT Settings	Choose the relevant option or enter the settings in IP configuration, External IP, Local Network.
Codecs	Some SIP Servers supports dynamic codec support. Codecs are algorithm used to compress or decompress speech or audio signals. The user should select the relevant Codecs and other speech compression techniques whose traffic will be routed to the SME network.
Video Codecs	The user should enable this option if SME network supports video telephony.
Media & RTP Settings	This option should be enabled to provide for deliver media streams (e.g., audio and video) or out-of-band events signalling (DTMF in separate payload type).

The screenshot shows the 'Edit Settings' page for Asterisk SIP. The left sidebar contains navigation links like 'Setup', 'Tools', 'Admin', 'FreePBX System Status', 'Module Admin', 'Support', 'Asterisk Logfiles', 'FreePBX Support', 'System Administration', 'Asterisk SIP Settings', 'Asterisk Info', 'Backup & Restore', 'Custom Destinations', and 'Custom Extensions'. The main content area is titled 'Edit Settings' and is divided into several sections:

- NAT Settings:** Includes radio buttons for NAT (yes, no, never, route), IP Configuration (Public IP, Static IP, Dynamic IP), External IP, and Local Networks (with a text input field and a dropdown menu showing '255.255.255.0'). There are buttons for 'Auto Configure' and 'Add Local Network Field'.
- Audio Codecs:** Includes checkboxes for various codecs: ulaw, alaw, gsm, png, lpc10, speex, g722, adpcm, jpeg, g723, slin, g726, g729, ilbc, and g726aal2.
- Non-Standard g726:** Includes radio buttons for Yes and No.
- T38 Pass-Through:** Includes radio buttons for Yes and No.
- Video Codecs:** Includes a radio button for Video Support (Enabled/Disabled).
- MEDIA & RTP Settings:** This section is partially visible at the bottom of the screenshot.

2) Extensions

This feature allows administrators create handset profiles in the SME network. In other words, Extensions describes the Dial plan for the PBX SIP system. Enter the relevant parameters

FreePBX[®] Admin Reports Panel Recordings Help

FreePBX 2.7.0.2 on 192.168.50.77 **Apply Configuration Changes** Logged in: admin (Logout)

English

Add SIP Extension

Add Extension

User Extension

Display Name

CID Num Alias

SIP Alias

Extension Options

Outbound CID

Ring Time

Call Waiting

Call Screening

Pinless Dialing

Emergency CID

Assigned DID/CID

DID Description

Add Inbound DID

Add Inbound CID

Add Extension

- 117 <117>
- 118 <118>
- 119 <119>
- 201 <201>
- 400 <400>
- 1234 <1234>
- MYA <2275>
- MYA1 <2276>
- 3000 <3000>
- 3001 <3001>
- 3002 <3002>
- 3003 <3003>
- 3004 <3004>
- 3005 <3005>
- 3006 <3006>
- 3007 <3007>
- 3008 <3008>
- 3009 <3009>

11 Appendix B: Using Base with VLAN Network

In this chapter we describe how to setup a typical VLAN in the network.

11.1 Introduction

In this chapter, we describe how to setup VLAN to typical network. There are three main stages involved in this procedure:

- 1) Configure a VLAN Aware Switch to a specific (un)tagged VLAN ID, so the SME system can process untagged frames forwarded to it.
- 2) Setup the Time Server (NTP Server) and other relevant network servers.
- 3) Configure the HTTP server in relevant Base stations to access the features in the PBX or SME system.

VLAN allows administrators to separate logical network connectivity from physical connectivity analogous to traditional LAN which is limited by its physical connectivity. Normally, users in a LAN belong to a single broadcast domain and communicate with each other at the Data Link Layer or “Layer 2”. LANs are segmented into smaller units for each IP subnets and here communication between subnets is possible at the Network Layer or “Layer 3”, using IP routers.

A VLAN can be described as a single physical network that can be logically divided into discrete LANs that can operate independently of each other.

An Illustration of using VLANs to create independent broadcast domains across switches is shown below:

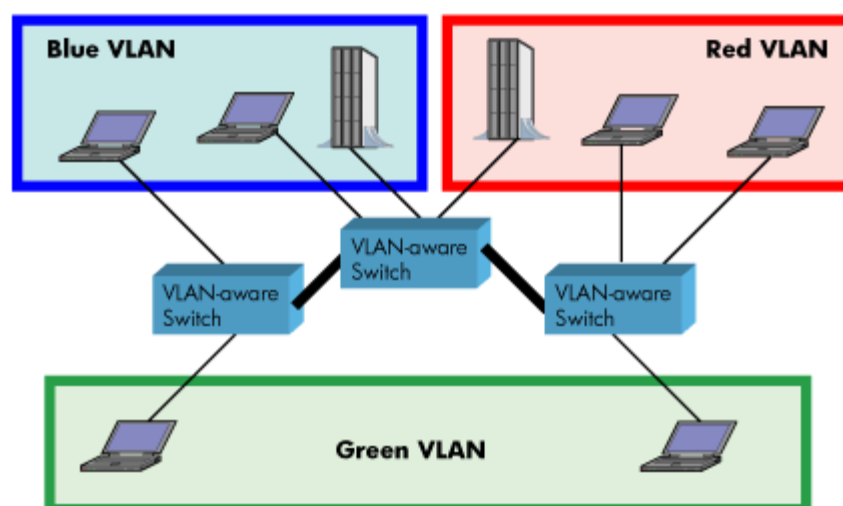

The figure above highlights several key differences between traditional LANs and VLANs.

- All switches are interconnected to each other. However, there are three different VLANs or broadcast domains on the network. Physical isolation is not required to define broadcast domains. If the figure was a traditional LAN without VLAN-aware switches, all stations would belong to one broadcast domain.
- All switch ports can communicate with one another at the Data Link Layer, if they become members of the same VLAN.

- The physical location of an end station does not define its LAN boundary.
 1. An end station can be physically moved from one switch port to another without losing its “view of the network”. That is, the set of stations it can communicate with at the Data Link Layer remains the same, provided that its VLAN membership is also migrated from port to port.
 2. By reconfiguring the VLAN membership of the switch port an end station is attached to, you can change the network view of the end station easily, without requiring a physical move from port to port.

11.2 Backbone/ VLAN Aware Switches

To implement a VLAN in your network, you must use VLAN-aware switches.

Before we continue, let consider two rules to remember regarding the functioning of a regular LAN switch:

1. When the switch receives a broadcast or multicast frame from a port, it floods (or broadcasts) the frame to all other ports on the switch.
2. When the switch receives a unicast frame, it forwards it only to the port to which it is addressed.

A VLAN-aware switch changes the above two rules as follows:

1. When the switch receives a broadcast or multicast frame from a port, it floods the frame to only those ports that belong to the same VLAN as the frame.
2. When a switch receives a unicast frame, it forwards it to the port to which it is addressed, only if the port belongs to the same VLAN as the frame.
3. A unique number called the VLAN ID identifies each VLAN.

Which VLAN Does a Frame Belong To?

The previous section notes that a frame can belong to a VLAN. The next question is—how is this association made?

- A VLAN-aware switch can make the association based on various attributes of the type of frame, destination of MAC address, IP address, TCP port, Network Layer protocol, and so on.

An illustration of IEEE 802.1Q VLAN tag in Ethernet frame is as follows:

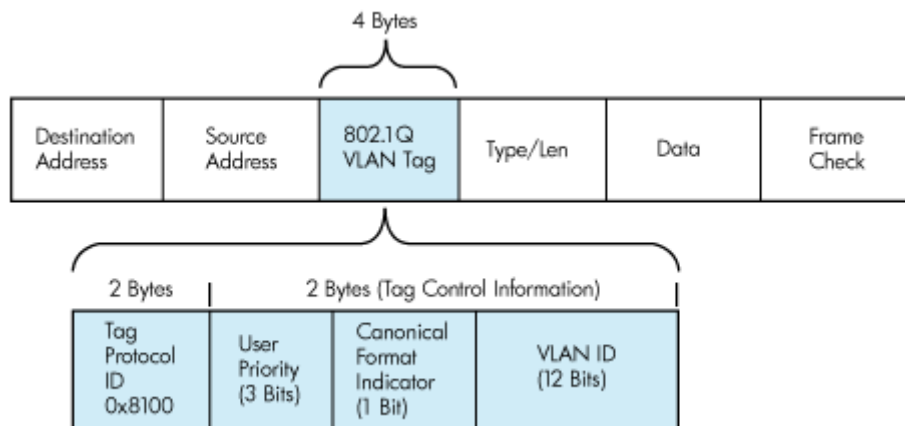

11.3 How VLAN Switch Work: VLAN Tagging

VLAN functionality can be implemented via explicit frame tagging by switches and end stations. Network switches and end stations that know about VLANs are said to be VLAN aware. Network switches and end stations that can interpret VLAN tags are said to be VLAN tag aware. VLAN-tag-aware switches and end stations add VLAN tags to standard Ethernet frames—a process called explicit tagging. In explicit tagging, the end station or switch determines the VLAN membership of a frame and inserts a VLAN tag in the frame header (see figure above for VLAN tagging), so that downstream link partners can examine just the tag to determine the VLAN membership.

11.4 Implementation Cases

Common types of usage scenarios for VLANs on typical VLAN switches: port-based VLANs, protocol-based VLANs, and IP subnet-based VLANs. Before figuring out which usage scenario suits your needs, you must understand what each type of usage scenario implies.

- **Port-based VLAN:** All frames transmitted by a NIC are tagged using only one VLAN ID. The NIC does not transmit or receive any untagged frames.

All protocols and applications use this virtual interface’s virtual PPA to transmit data traffic. Therefore all frames transmitted by that NIC port are tagged with the VLAN ID of that Virtual Interface.

- **Protocol-based VLAN:** The NIC assigns a unique VLAN ID for each Layer 3 protocol (such as IPv4, IPv6, IPX, and so on). Therefore, the VLAN ID of outbound frames is different for each protocol. An inbound frame is dropped if the protocol and VLAN ID do not match.
- **IP subnet-based VLAN:** The NIC assigns a unique VLAN ID for each IP subnet it belongs to. Therefore, the VLAN ID of outbound frames is different for different destination subnets. An inbound frame is dropped if the IP subnet and VLAN ID do not match.

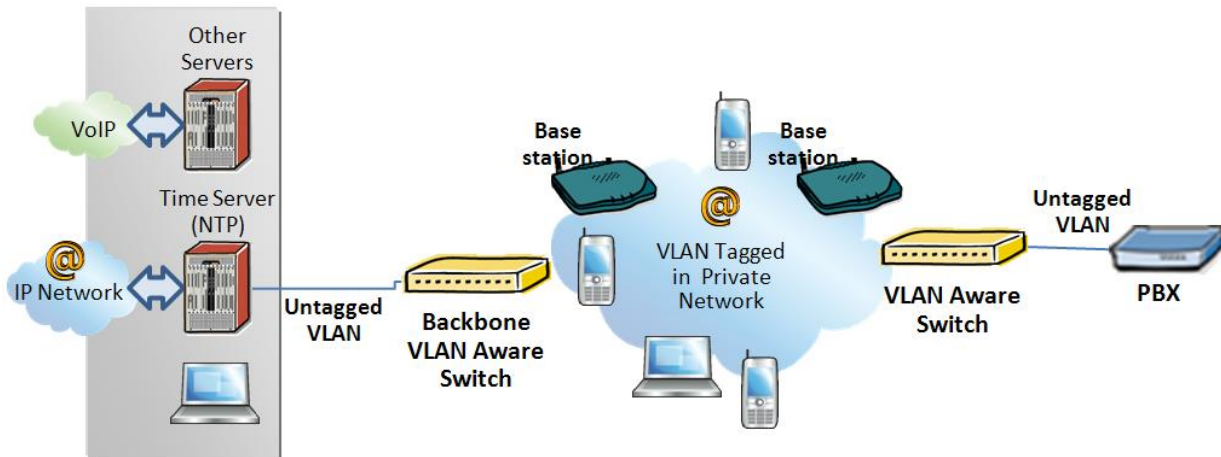

11.5 Base station Setup

After the admin have setup the Backbone switch, next is to configure the Base stations via HTTP interface.

- STEP 1** Connect the Base station to a private network via standard Ethernet cable (CAT-5).
- STEP 2** Use one of the two methods to find the base IP
- STEP 3** On the Login page, enter your authenticating credentials (the username and password is **admin** by default unless it is changed). Click **OK** button.
- STEP 4** Once you have authenticated, the browser will display front end of the SME Configuration Interface. The front end will show relevant information of the base station.
- STEP 5** Create the relevant SIP server information in the system. Each service provider/customer should refer SIP server vendor on how to setup SIP servers.

11.6 Configure Time Server

- STEP 6** Navigate to the Time settings and configure it. Scroll on the left column and click on **Time** url link to Open the **Time Settings** Page. Enter the relevant parameters on this page and press the **Save** button.

Home/Status	<h2>Time Settings</h2>
Extensions	Time server: <input type="text" value="192.168.50.3"/>
Servers	Time server refresh interval: <input type="text" value="1"/>
Network	Timezone: <input type="text" value="+1:00"/>
Management	Daylight Saving Time (DST): <input type="text" value="Automatic"/>
Firmware Update	DST Fixed By Day: <input type="text" value="Use Month and Day of Week"/>
Time	DST Start Month: <input type="text" value="March"/>
Country	DST Start Date: <input type="text" value="1"/>
Security	DST Start Time: <input type="text" value="2"/>
Contact List	DST Start Day of Week: <input type="text" value="Sunday"/>
Multi cell	DST Start Day of Week Last in Month: <input type="text" value="Last In Month"/>
Settings	DST Stop Month: <input type="text" value="October"/>
Debug Log	DST Stop Date: <input type="text" value="1"/>
SIP Log	DST Stop Time: <input type="text" value="2"/>
	DST Stop Day of Week: <input type="text" value="Sunday"/>
	DST Stop Day of Week Last in Month: <input type="text" value="Last In Month"/>
	<input type="button" value="Save"/> <input type="button" value="Cancel"/>

11.7 VLAN Setup: Base station

STEP 7 Navigate to the **Network** url > On the network page enter the relevant settings in the VLAN section > VLAN Id should be the same as those configured into the backbone.

Home/Status	<h2>Network Settings</h2>	
Extensions	<h3>IP settings</h3> DHCP/Static IP: <input type="text" value="DHCP"/> IP Address: <input type="text" value="192.168.10.106"/> Subnet Mask: <input type="text" value="255.255.255.0"/> Default gateway: <input type="text" value="192.168.10.254"/> DNS (primary): <input type="text" value="192.168.10.10"/> DNS (secondary): <input type="text"/>	<h3>NAT Settings</h3> Enable RPORT: <input type="text" value="No"/> Keep alive time: <input type="text" value="90"/>
Servers	<h3>SIP/RTP Settings</h3> Local SIP port: <input type="text" value="5060"/> SIP ToS/QoS: <input type="text" value="104"/> RTP port: <input type="text" value="50004"/> RTP port range: <input type="text" value="40"/> RTP ToS/QoS: <input type="text" value="184"/>	
Network	<h3>VLAN Settings</h3> VLAN Id: <input type="text" value="500"/> VLAN User Priority: <input type="text" value="0"/>	
Management	<h3>Boot Server Options</h3> Boot Server DHCP Option: <input type="text" value="Disabled"/> Customer DHCP Option: <input type="text" value="160"/> Option Content Type: <input type="text" value="String"/>	
Firmware Update	<input type="button" value="Save"/> <input type="button" value="Cancel"/>	
Time		
Country		
Security		
Contact List		
Multi cell		
Settings		
Debug Log		
SIP Log		
Logout		

12 Appendix C: SME VoIP Network Planning/Optimization

In this chapter, we describe SME VoIP radio network planning techniques including dimensioning, detailed capacity and coverage planning, and network optimisation.

12.1 Network Requirements

Network requirement is essential to determine elements necessary to achieve the overall expectations of the customer. Typical network requirements includes (but not limited to):

- The geographical area to be covered
- The type or architecture of building and/or topology, etc.
- The estimated traffic on each zone or region or building
- The blocking criteria in each traffic area.
- The relevant quality targets expected to be achieved

12.2 Deployment Considerations

The following radio considerations must be examined before deploying a SME VoIP System. These includes (but not limited to):

Building Penetration:

When a signal strikes a building it is diffracted or absorbed; therefore to some extent the signal is reduced. The amount of absorption is dependent of the kind of building and its environment, the amount of solid structure. This is an important consideration in coverage planning.

Interference Sources:

Signals to receiving antenna can be weakened by virtue of interference from other signals. These signals may be from the same network or other man-made objects. Interference sources must be identified and avoided or minimized.

12.3 Site Planning

12.3.1 Location Probability

The quality of coverage is determined by location probability. Please see the How to Deploy SME VOIP System manual for more information.

12.3.2 Handover Mechanics/Planning

Handsets should seamlessly move between coverage areas. In other words, handset should be able to move in a multi-cell setup of base stations and/or repeaters from one base station to another without terminating or causing hindrance while receiving continuous service and maintaining call-sessions in progress.

For efficient handover of conversations between Base stations in multi-cell setup, deploy Base stations with wide overlap between them (i.e., plan for some areas to be covered by more than one Base station).

Overlaps are necessary to maintain seamless handover and to establish synchronization chains. A good example may be a cafeteria during lunch hour where temporary concentrations of handsets may occur. The overlap carries the excess call load to adjacent Base stations to provide uninterrupted services to subscribers.

12.4 Cell Coverage / Capacity Planning

12.4.1 Cell Coverage

Due to the unexpected nature of RF propagation in an indoor environment, an actual on-site test must be performed before the deploying and/or installing core network elements. An extensive guide to effective RF coverage planning is outside the scope of this document. This should be noted:

The Base stations provides typical RF coverage of up to 50 meters/164 feet in a typical indoor office environment and up to 300 meters/984 feet in an open area (line-of-sight-LOS), extending in all directions from the Base stations (i.e. Omni directional). The exact coverage range depends on the building architecture, wall material and surroundings. The figure below show the correct installation of base stations spaced at the recommended distances from each other:

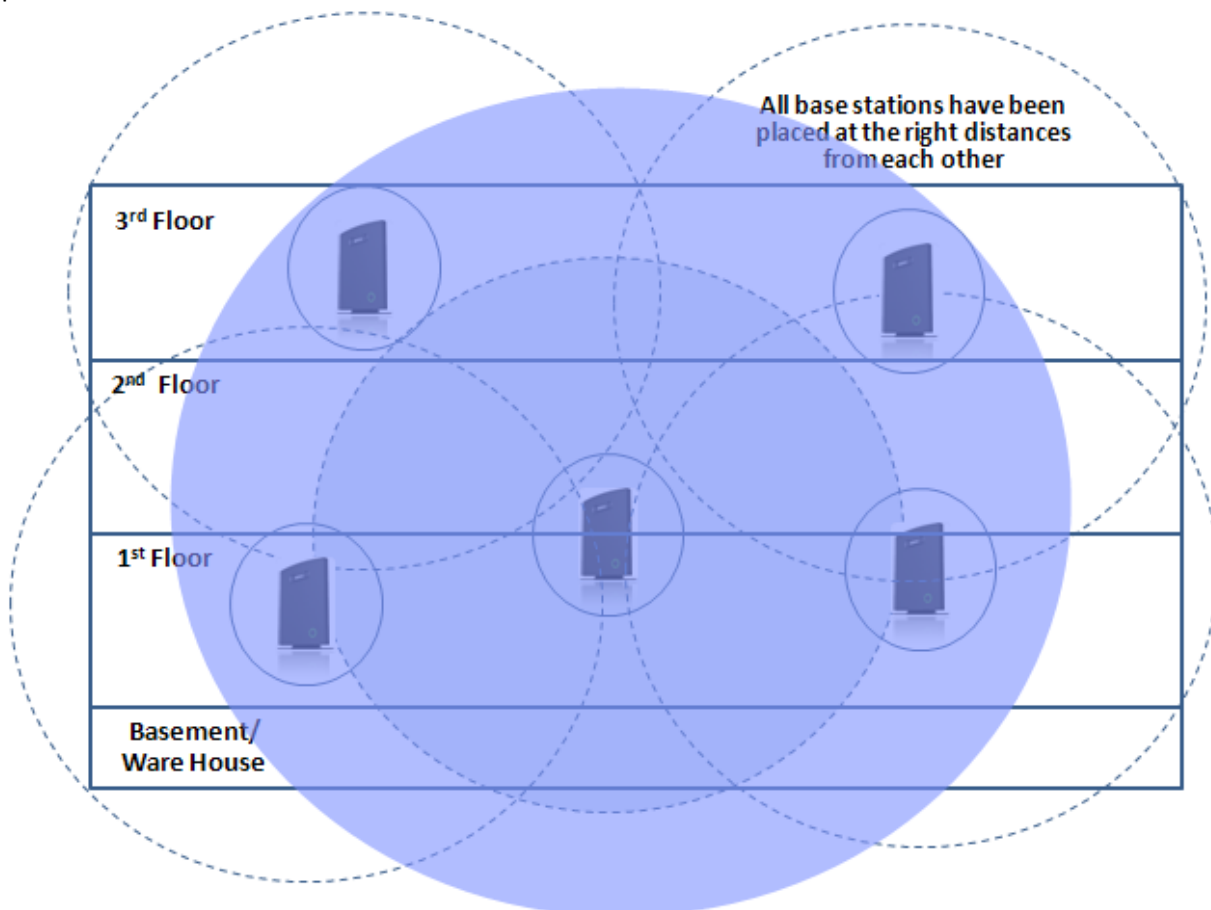

Typically, installations such as office buildings, hotels and hospitals should be equipped with both base stations and repeaters on several floors to create uniform and complete radio coverage.

Open areas can be covered with a sparse network of base stations. In such deployments, the base stations and/or repeaters cover an extended range due to the extended line-of-sight radio propagation capability

The figure below shows an example of an installation where base stations are not spaced at the right distances:

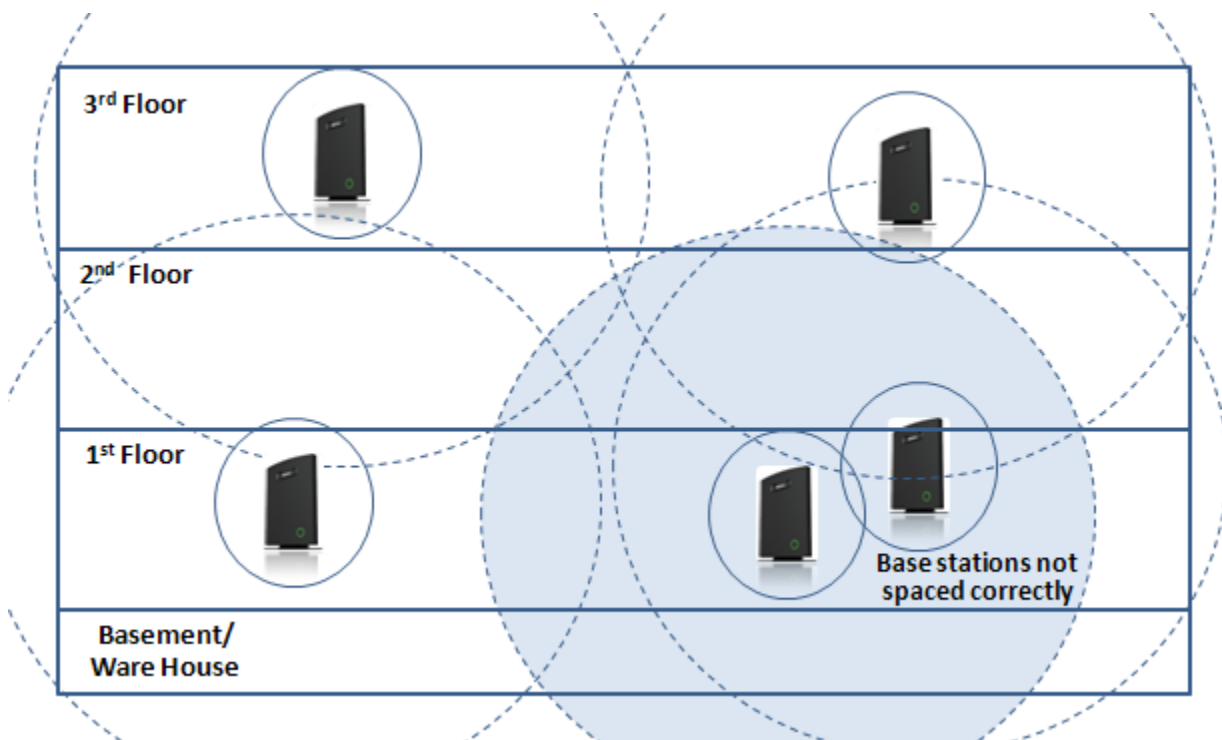

12.4.2 Capacity Planning

This is where the Network provider estimates how many calls will be initiated in a typical window/time frame and how many users will be initiating them.

Another aspect of capacity planning should address the user growth pattern of a typical SME VoIP network. How many users will be using this network in for example two years window, etc. Based on these estimations, the network dimensioning can be planned orderly bearing in mind the SME capacity.

12.5 Network Dimensioning

After the network requirements are clearly defined, the number of users that are expected to use the network must be estimated. Based on that, you should estimate and identify the number and type of equipment required in order to cater for the capacity, coverage and quality requirements. The more accurate the dimensioning, the more efficient the network rollout.

Handsets/SIP End-Nodes:

In a typical setup, the system can support up to 1000 handsets depending on the configuration.

Base stations/Repeaters:

The system can easily scale up to 50 base stations. Depending on the network setup, coverage can be extended by up to 3 repeaters pr. base station. The planner should bear in mind that base stations can support 10 simultaneously call sessions while repeaters can support 5 call sessions.

Core Network Equipment:

This equipment is at the premises of the service operator or data centre. Depending on the network requirements the following devices should be available:

VLAN/NAT aware router(s), Session Border Controller, DHCP/TFTP/FTP Servers, STUN Server, Media Server, Access Gateway, SIP Server, etc.

12.6 Environmental Considerations

In this section, we enumerate some environmental conditions that need to be considered prior to planning, deployment and optimisation of the SME network. The considerations are as follows:

- Ensure that the installation area is clean and dry.
- Ensure that the floor of the installation area is finished with linoleum, vinyl, ceramic, wooden flooring, computer floor tiles, or polished sealed concrete.
- Ensure that the ceiling of the installation area is finished or treated to prevent particle discharge.
- Ensure that the installation area is well lit, and that the light source is uniformly diffused without shadows. Adequate lighting should provide a comfortable reading level and allow the identification of wire insulator colours without undue eye fatigue. Lighting should be comparable to an office work environment, with a minimum level of 21 meter/68.9 feet at each work surface. As a rule of thumb, in a room with a 2.5 meters/8.2 feet ceiling, one 1.2 meters/4 feet fluorescent tube provides sufficient illumination for 1.9-2.4 square meters/20.5-25.9 square feet.
- Ensure that ventilation of the installation area is capable of maintaining an ambient temperature of 0-40°C/32-104°F, and a relative humidity of 20-80% non-condensing, while the system is operating. The maximum power rating of a base station under full load should not exceed 315W/1070 BTU/Hr. These figures are for each cabinet only, and do not take into account heat generated by other equipment. In particular, charging fully-discharged batteries may generate a considerable amount of heat, depending on battery capacity and rate of charge. Refer to the equipment manufacturer data for more information.
- Ensure that the installation area is free of caustic or corrosive liquids, substances, or materials. If batteries will be installed as part of the system, ensure that adequate precautions are taken (such as special ventilation) to prevent corrosive emissions from the batteries. Check local building codes for additional requirements.

12.7 Recommended Base station/Repeater Placement

There is no one strategy for deploying base stations. These are some recommended Base station and/or Repeater placement strategies:

Around Corridors:

Base stations/repeater should be deployed vertically preferably at corridor intersections where propagation patterns follow the corridor patterns. The base station/repeater should point towards the corridor and preferably in the middle height between the floor and the actual ceiling. In case there are high objects in the area, the base station/repeater should be installed above those objects but still kept distant from the ceiling.

Multi-Storey Buildings:

Base stations and repeaters can be installed on opposite sides of the floors to take advantage of the floor-to-floor coverage. The coverage design cannot rely entirely on floor-to-floor propagation; each case must be verified due to variations in local attenuation patterns.

Open Areas/ Large Halls:

Base stations and repeaters can be deployed in open areas for buildings that contain a central open space area with windows to the other areas. This provides a good coverage for the rooms in the inner circle on all floors (e.g. hotels).

In large halls, Base stations/repeater should be installed vertically in the middle of the space below the drop ceiling.

Mounting Positions:

When Base stations and repeaters are mounted vertically on a wall, the radio coverage in front of these devices is twice as large as the coverage at the rear.

Repeaters should be installed in the middle of corridors and small rooms.

Metallic Structures/Objects:

Base stations and repeaters should not be deployed near large metallic objects.

Reinforced Concrete Structures:

These structures have a high attenuation factor inside the building. They reduce the radio coverage range of the Base stations and repeaters and therefore require a higher number of base stations or repeaters in the building. Lighter types of construction materials require fewer base stations since attenuation figures are considerably lower.

Others Recommendations:

- Maximum distance between two base stations varies depending on material and construction of buildings, but there must always be synchronization chains and radio coverage overlap between the two base stations or handover between radio units. The time it takes a person to cross the common coverage area must be 10 seconds or more, as the handset needs time to scan for an alternative base stations.
- Ensure that the installation area is located no closer than 6.1meters/20.0 feet from electric devices that produce large electro-magnetic fields (EMF) or high levels of radio frequency energy. Possible EMF sources are radio transmitters, electric arc welding machines, copying machines, electric motors, refrigeration units, power transformers, electric load centres, and main circuit breaker panels.
- Ensure that the electrical service is sufficient and located in close proximity to the Base stations.

12.8 Network Assessment/Optimisation

This involves monitoring, verifying and improving the performance of the SME VoIP network. Depending on the network setup and varying deployment conditions and network usage some requirements have to be monitored and corrected.

The main focus of network optimisation should be telephony quality, handovers, network traffic and other related measurements.

The quality of the network is ultimately determined by the satisfaction of users of the network. Therefore before SME VoIP Networks are handed over to customers, Network providers must perform deployment testing. Please see the How to Deploy SME VOIP System manual for more information.

Collect statistics of the network an example is illustrated in the table below:

Parameters	Value	Comments
## Call Setup failures		
## Dropped calls		
## HO successes		
## HO failures		
Traffic Blocking Rate (%)		
Traffic Blocking (Erl)		
Receiver level (dBm)		
Receiver Quality (%)		

After collecting the necessary information, you should fine tune signalling and radio resource sharing parameters. Network optimisation is a continuous process during and after the launch of the network.

For example, if it is found that an area within a building has low signal level. There should be an immediate scrutiny of base station and/or repeater locations, heights and tilts. The problem is sorted out by moving the relevant devices and altering the tilts of these devices.

For buildings/halls constructed with high signal attenuation materials, deploying additional base stations will be one of the solutions.

13 Appendix D: Local Central directory file handling

In this appendix the Local Central Directory file format, import and configuration is described.

13.1 Central Directory Contact List Structure

The structure of Contact List is simple. The figure below shows an example of structure of Contact List in Text format and in Xml format. **Contact name must not contain more than 23 characters and contact number must not contain more than 21 digits.**

.csv or .txt

```
File Edit Format View Help
Dennis Iversen,+4596322382
Torsten Krogh Elgaard,2381
Rune Thor Jensen,2445
Maija-Liisa Knudsen,2377
Jesper Jensen,2346
Kristian Kjaer,2447
Gitte Dyhr Petersen,2470
Sukesh Reddy,2749
Morten Fredegod,4726
Annemarie Dahl,2861
Hans Back,2721
Henrik Olsen,2733
Jens Martin Jensen,2782
Kenneth Skiveren,2363
Lars Christensen (RTX),2433
```

.xml

```
File Edit Format View Help
<IPPhonedirectory>
<DirectoryEntry>
<Name>Mark Ross</Name>
<Telephone>100</Telephone>
<Office>+4 501234 56789</Office>
<Mobile>+4 511234 56789</Mobile>
<Fax>+4 521234 56789</Fax>
</DirectoryEntry>
</IPPhonedirectory>
```

Txt file limitations:

- Contact name must NOT be longer than 23 characters (name will be truncated)
- Contact name must NOT contain “,”
- Contact number must be limited to 21 digits (entry will be discarded, no warning)
- Contact number digits must be: +0123456789
- Contact number does not support SIP-URI
- Spaces between name section “,” and number section is not supported

13.2 Central Directory Contact List Filename Format

The Contact list is saved as file format: .txt .csv or .xml

13.3 Import Contact List to Central Directory

On the **Central Directory** page, the admin should click on **Browse** button and the **Choose File to Load** dialog window will be shown.

On the **Choose File to Upload** dialog window, navigate to the directory or folder that contains the right file to be imported to the base station > Click on **Open** button.

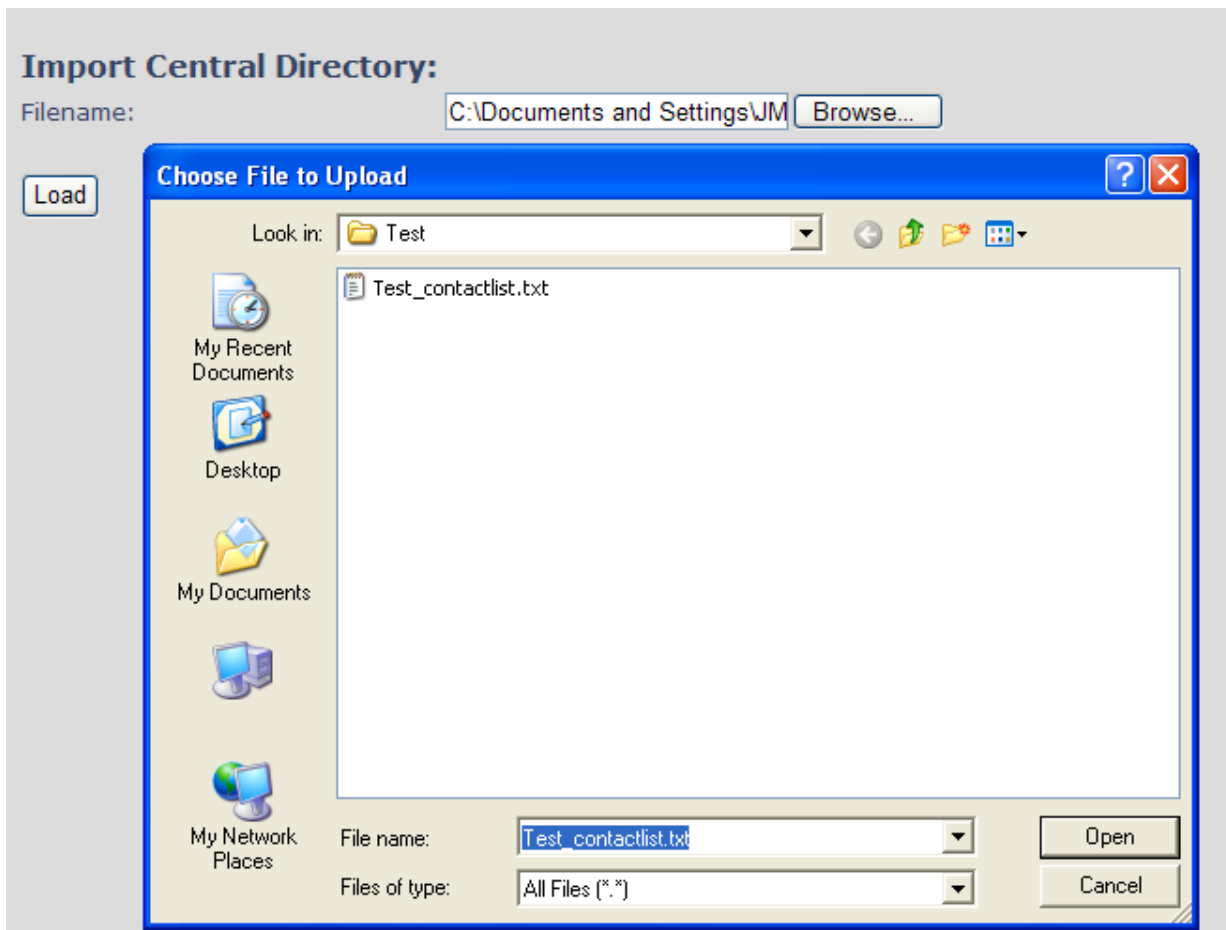

Next, click on the **Load** button. This will import the contents of contacts in the selected file into the relevant Base station.

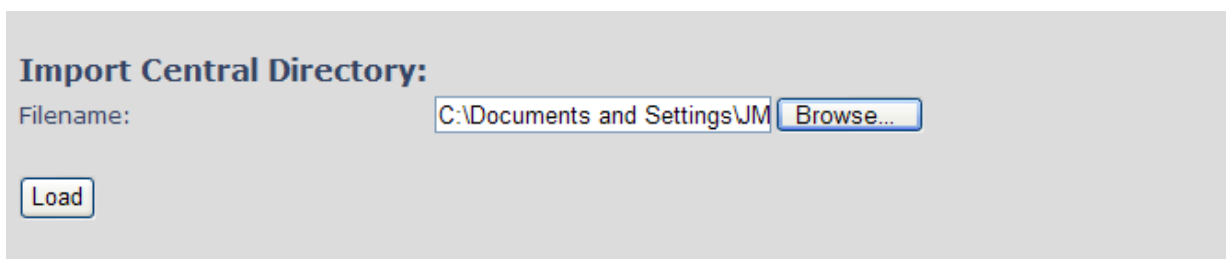

The figure below shows the import procedure is in process.

The parameters are successfully saved
You will be redirected after 3 seconds

13.4 Central directory using server

Alternative way to import a Contact List is to get it from a server. First click on Management url to get Management Settings page, then select the protocol of your server (TFTP/HTTP) in Management Transfer Protocol, then save the setting by clicking Save.

Management Transfer Protocol:	TFTP
HTTP Management upload script:	TFTP
HTTP Management password:	HTTP

Go back to Central Directory page and enter Server IP address (inclusive the path in the end of the address) and Filename of the contact list, then save the setting by clicking Save. (See example below).

Central Directory

Server:

Filename:

Then reboot the Base station to ensure that the changes take effect.

13.5 Verification of Contact List Import to Central Directory

On the Handset, navigate to Central Directory where the correct contact list should populate to the contacts uploaded to the Base station.

14 Appendix E: Network Operations

14.1 Introduction

In this chapter, we will provide an overview of the operation of the network during system start-up, location registration and speech calls including illustration of different call scenarios.

14.2 System Start Up

When a Base station Unit is powered up, it achieves IP address from DHCP server and time from the Time-Server.

Optionally the base retrieves its configuration from a file on the TFTP server. This configuration file describes used network and cluster configuration parameters (optional and not needed).

The SME VoIP network has successfully started up.

14.3 Terminal Attachment

When a DECT Terminal (also called handset or SIP node) is turned on or moved into the coverage area of a Base-station it has to get attached to the network. When more Base-stations are available, the Terminal selects the one with best RF signal. This procedure, called *Location Registration*, always keeps the network informed about where a Terminal is located and enables it receive or originate calls. This procedure also authenticates the Terminal and checks the validity of the associated subscription.

14.4 Outgoing Calls

Outgoing calls are initiated by the Terminal. It selects the Base-station with best RF signal and establishes a radio communication link to Base-station. DECT call control messages are exchanged between Terminal, Base station and other servers. This server forwards the outgoing call as SIP messages to the external SIP Server. The RTP stream is established between the involved Base-station (and the Media Gateway for PSTN calls). If the call is between two Terminals the media stream may be routed directly between the two involved Base-stations depending on the SIP Server routing strategy.

14.5 Incoming Calls

Incoming calls are initiated by SIP INVITE messages from the SIP Server to the Base unit; inviting it to participate in an incoming session. The system sends paging messages to all the Base-station where the Terminal last performed a *Location Registration*. When the paging is received the Terminal establishes a radio communication link to the best available Base-station and sends a response back to DECT controller. DECT call control messages are exchanged and the Terminal starts ringing. When the user answers the call, a connect message is sent to the IP DECT controller that completes the incoming call by sending 200 OK back to the SIP Server and establishes an RTP media stream between Base-station (and Media Gateway from PSTN line). For internal calls the media stream may be routed directly between the involved Base-stations.

14.6 Handover

14.6.1 RTP Stream Remains at Initial Base Station

When the call is set up, the handset is located at base station 1. Thus, the DECT communication takes place between the handset and station 1, and the SIP signalling as well as the RTP stream takes place between base station 1 and the SIP server/media gateway. The figure below illustrates this application:

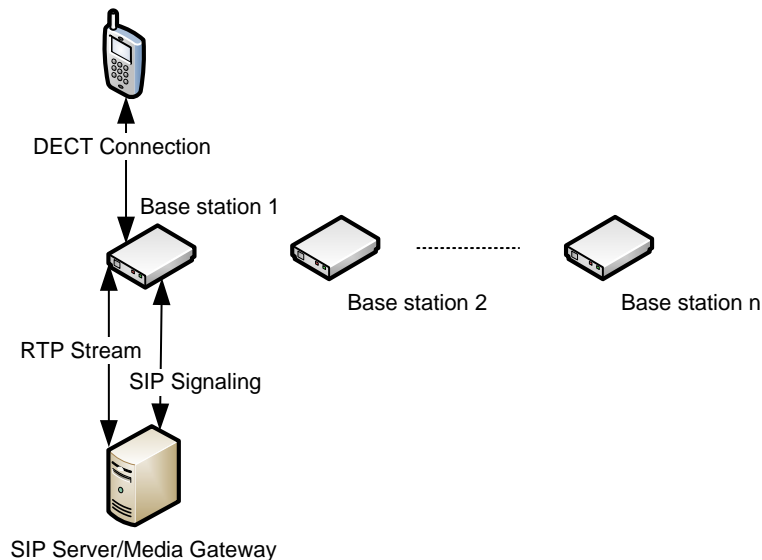

Stage 1: Before handover the handset is located at BS 1.

After handover, the handset is located at base station 2, and hence the DECT communication goes on between the handset and base station 2. However, to avoid disruption of the audio, the RTP stream is relayed via the initial base station, since a transfer of the RTP stream to another base station may cause the media gateway (or whatever the remote endpoint is) to re-initialize the RTP stream with a small disruption of the RTP stream as consequence. Thus, from the point of view of the remote endpoint, the RTP stream is not affected by the handover, and since the call control also remains at base station 1 the SIP signalling is also unaffected, as shown below:

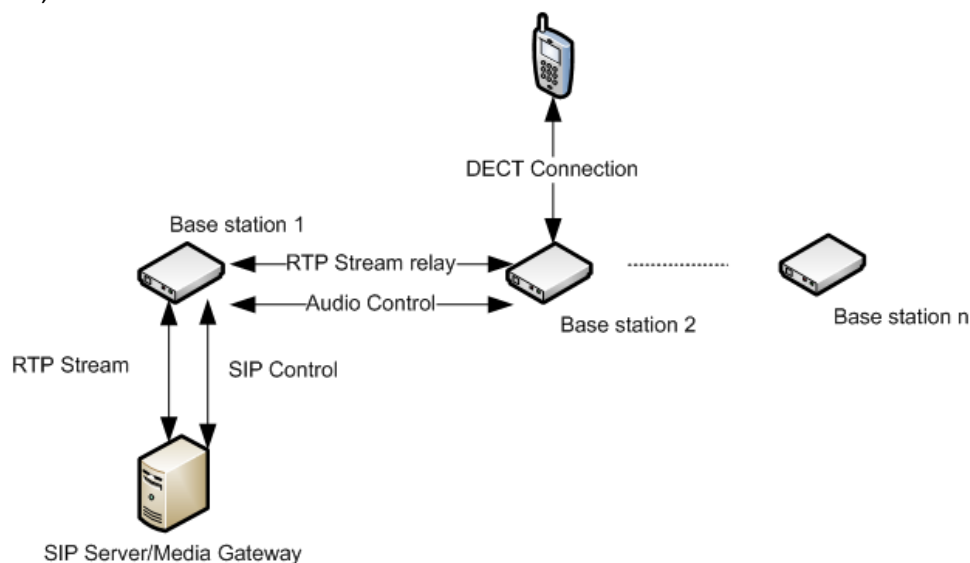

Stage 2: After handover to BS 2, the HS is located at BS 2, and the RTP stream is relayed via BS 1.

Since the call control and hence the SIP User Agent remains at the initial base station, the SIP registration is also unaffected by the handover.

If the handset makes yet another handover, the RTP stream will still be relayed via the base station at which, the call was established (here base station 1). This is illustrated as follows:

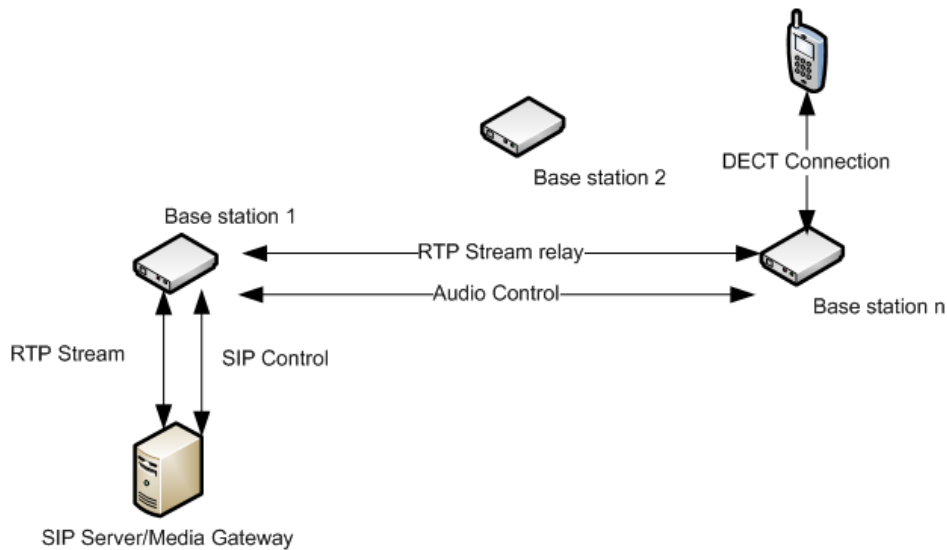

After handover to BS *n* the handset is located at BS *n*, and the RTP stream is relayed via BS 1.

14.7 Roaming

By roaming means the handset moves its SIP and DECT registration from one base station to another base station. Roaming can only be initiated from idle.

Roaming does not immediately result in a new SIP registration, because this may cause a lot of unnecessary signalling. Therefore, the handset will not perform a new DECT Location Registration until it has resided on the same base station for a defined period of time. Since the SIP registration is initiated by the completion of the Location Registration, a new SIP registration will also not be done until this procedure has completed on a new base station. Thus, a handset must stay on the same base station as given in the rules stated below, before a new SIP registration will be made.

Timing Criteria for Location Registration; or roaming will be initiated when:

1. Handsets lose contact to first base unit due to reset/power off/heavy DECT traffic.
2. After 5 minutes (configuration is possible) but before 5+2 minutes
 - a. The plus maximum 2 minutes will occur when service connection traffic is signaled at the same time as location should happen. In this case the location registration procedure will be delayed.

If an incoming call arrives while the handset has moved to another base station (base station 2) but still not performed a new Location Registration, the SIP call will arrive at the initial base station (base station 1), but the RTP stream will be set up between base station 2 and the remote endpoint (refer to figure below). Alternatively, in the case of an outgoing call, the SIP call will be established from the initial base station, and the RTP stream will be set up between base station 2 and the remote endpoint.

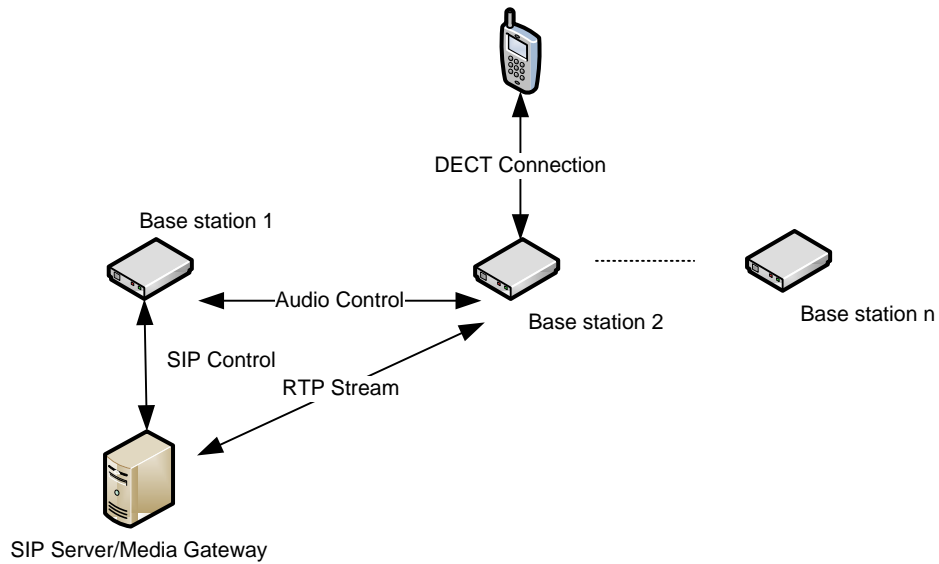

An illustration of Handset moving to another base station, but call control is still handled by the initial base station.

FCC Caution:

Any Changes or modifications not expressly approved by the party responsible for compliance could void the user's authority to operate the equipment.

This device complies with part 15 of the FCC Rules. Operation is subject to the following two conditions: (1) This device may not cause harmful interference, and (2) this device must accept any interference received, including interference that may cause undesired operation.

Note: This equipment has been tested and found to comply with the limits for a Class B digital device, pursuant to part 15 of the FCC Rules. These limits are designed to provide reasonable protection against harmful interference in a residential installation. This equipment generates, uses and can radiate radio frequency energy and, if not installed and used in accordance with the instructions, may cause harmful interference to radio communications. However, there is no guarantee that interference will not occur in a particular installation. If this equipment does cause harmful interference to radio or television reception, which can be determined by turning the equipment off and on, the user is encouraged to try to correct the interference by one or more of the following measures:

- Reorient or relocate the receiving antenna.
- Increase the separation between the equipment and receiver.
- Connect the equipment into an outlet on a circuit different from that to which the receiver is connected.
- Consult the dealer or an experienced radio/TV technician for help.

Privacy of communications may not be ensured when using this telephone!

FCC Radiation Exposure Statement:

This equipment complies with FCC radiation exposure limits set forth for an uncontrolled environment. This equipment should be installed and operated with minimum distance 20cm between the radiator & your body.

This transmitter must not be co-located or operating in conjunction with any other antenna or transmitter.

IC:

This device complies with Industry Canada licence-exempt RSS standard(s). Operation is subject to the following two conditions:

- (1) this device may not cause interference, and
- (2) this device must accept any interference, including interference that may cause undesired operation of the device.

Le présent appareil est conforme aux CNR d'Industrie Canada applicables aux appareils radio exempts de licence. L'exploitation est autorisée aux deux conditions suivantes : (1) l'appareil ne doit pas produire de brouillage, et (2) l'utilisateur de l'appareil doit accepter tout brouillage radioélectrique subi, même si le brouillage est susceptible d'en compromettre le fonctionnement

The device is compliance with RF exposure guidelines, users can obtain Canadian information on RF exposure and compliance. The minimum distance from body to use the device is 20cm.

Le présent appareil est conforme

Après examen de ce matériel aux conformité ou aux limites d'intensité de champ RF, les utilisateurs peuvent sur l'exposition aux radiofréquences et la conformité and compliance d'acquérir les informations correspondantes. La distance minimale du corps à utiliser le dispositif est de 20cm.