



FCC PART 15D
MEASUREMENT AND TEST REPORT

For

RTX Hong Kong Ltd.

8/F Corporation Square, 8 Lam Lok Street, Kowloon Bay, Hong Kong

FCC ID: T7HR4026

| | |
|--|--|
| Report Type: Original Report | Product Type: RTX4026 |
| Report Number: | RSZ190613006-00 |
| Report Date: | 2019-07-25 |
| Reviewed By: | Hill He RF Engineer <i>HYM HR</i> |
| Prepared By: | Bay Area Compliance Laboratories Corp. (Shenzhen) 6/F., West Wing, Third Phase of Wanli Industrial Building, Shihua Road, Futian Free Trade Zone, Shenzhen, Guangdong, China Tel: +86-755-33320018 Fax: +86-755-33320008 www.baclcorp.com.cn |

Note: This report must not be used by the customer to claim product certification, approval, or endorsement by A2LA* or any agency of the Federal Government. * This report may contain data that are not covered by the A2LA accreditation and are marked with an asterisk “*”.

The information marked # is provided by the applicant, the laboratory is not responsible for its authenticity.

TABLE OF CONTENTS

| | |
|---|-----------|
| GENERAL INFORMATION..... | 4 |
| PRODUCT DESCRIPTION FOR EQUIPMENT UNDER TEST (EUT) | 4 |
| OBJECTIVE | 4 |
| RELATED SUBMITTAL(S)/GRANT(S)..... | 4 |
| TEST METHODOLOGY | 4 |
| MEASUREMENT UNCERTAINTY | 5 |
| TEST FACILITY | 5 |
| SYSTEM TEST CONFIGURATION..... | 6 |
| DESCRIPTION OF TEST CONFIGURATION | 6 |
| EQUIPMENT MODIFICATIONS | 6 |
| LOCAL SUPPORT EQUIPMENT LIST AND DETAILS | 6 |
| EXTERNAL I/O CABLE..... | 6 |
| BLOCK DIAGRAM OF TEST SETUP | 7 |
| SUMMARY OF TEST RESULTS | 8 |
| TEST EQUIPMENT LIST | 9 |
| §1.1307 (B) (1) & §2.1091- MAXIMUM PERMISSIBLE EXPOSURE (MPE)..... | 10 |
| APPLICABLE STANDARD | 10 |
| MPE CALCULATION..... | 10 |
| FCC §15.317 & §15.203 - ANTENNA REQUIREMENT | 11 |
| APPLICABLE STANDARD | 11 |
| ANTENNA CONNECTOR CONSTRUCTION | 11 |
| FCC §15.315 & §15.207 - CONDUCTED EMISSIONS..... | 12 |
| APPLICABLE STANDARD | 12 |
| EUT SETUP..... | 12 |
| EMI TEST RECEIVER SETUP..... | 12 |
| TEST PROCEDURE | 13 |
| CORRECTED FACTOR & MARGIN CALCULATION | 13 |
| TEST RESULTS SUMMARY | 13 |
| TEST DATA | 13 |
| FCC §15.323 (A) - EMISSION BANDWIDTH..... | 16 |
| APPLICABLE STANDARD | 16 |
| TEST PROCEDURE | 16 |
| TEST DATA | 16 |
| FCC §15.319 (C) - PEAK TRANSMIT POWER..... | 19 |
| APPLICABLE STANDARD | 19 |
| TEST PROCEDURE | 19 |
| TEST DATA | 19 |
| FCC §15.319 (D) - POWER SPECTRAL DENSITY | 22 |
| APPLICABLE STANDARD | 22 |
| TEST PROCEDURE | 22 |
| TEST DATA | 22 |

FCC §15.323 (D) - EMISSION INSIDE AND OUTSIDE THE SUB-BAND26
 APPLICABLE STANDARD26
 TEST PROCEDURE26
 TEST DATA26

FCC §15.323 (F) - FREQUENCY STABILITY36
 APPLICABLE STANDARD36
 TEST PROCEDURE36
 TEST DATA36

FCC §15.323 (C) (E) & §15.319(F) – SPECIFIC REQUIREMENTS FOR UPCS DEVICE.....38
 APPLICABLE STANDARD38
 TEST PROCEDURE38
 TEST DATA38
 1) AUTOMATIC DISCONTINUATION OF TRANSMISSION, FCC §15.319(F)39
 2) MONITORING TIME, FCC §15.323(c) (1)39
 3) LOWER MONITORING THRESHOLD, FCC §15.323(c) (2)39
 4) MAXIMUM TRANSMIT PERIOD, FCC §15.323(c) (3)40
 5) SYSTEM ACKNOWLEDGEMENT, FCC §15.323(c) (4)40
 6) LEAST INTERFERED CHANNEL (LIC), FCC §15.323(c) (5)41
 7) RANDOM WAITING, FCC §15.323(c) (6)43
 8) MONITORING BANDWIDTH AND REACTION TIME, FCC §15.323(c) (7)43
 9) MONITORING ANTENNA, FCC §15.323(c) (8)44
 10) MONITORING THRESHOLD RELAXATION, FCC §15.323(c) (9)45
 11) DUPLEX CONNECTIONS, FCC §15.323(c) (10)45
 12) ALTERNATIVE MONITORING INTERVAL, FCC §15.323(c) (11)46
 13) FAIR ACCESS, FCC §15.323(c) (12)47
 14) FRAME REPETITION STABILITY FRAME PERIOD AND JITTER, FCC §15.323 (E)47

GENERAL INFORMATION

Product Description for Equipment under Test (EUT)

| | |
|-----------------------------|---|
| Product | RTX4026 |
| Tested Models | RTX4026 |
| Multiple Model [#] | RPT-110-3PC-NA-K9, RPT-110-3PC-CE-K9, RPT-110-3PC-AU-K9, RPT-110-3PC-UK-K9 |
| Frequency Range | DECT: 1921.536~1928.448MHz |
| Transmit Power | 20.03 dBm |
| Modulation Technique | GFSK |
| Antenna Specification | PCB Antenna 2 dBi |
| Voltage Range | DC 5V from adapter |
| Date of Test | 2019/06/22~2019/06/24 |
| Sample serial number | 190613006 |
| Received date | 2019/06/13 |
| Sample/EUT Status | Good condition |
| US Adapter Information | Model: S003GU0500060 Input: AC 100-240V, 50/60Hz, 150mA Output: DC 5.0V 600mA |

Notes: This series products model: RPT-110-3PC-NA-K9, RPT-110-3PC-CE-K9, RPT-110-3PC-AU-K9, RPT-110-3PC-UK-K9 and RTX4026 are electrically identical, these models are electrically identical, the different between them can be referred to the declaration which was stated and guaranteed by the applicant.

Objective

This test report was based on the *RTX Hong Kong Ltd.* tests performed on the EUT. The EMI measurements were performed according to the measurement procedure described in ANSI C63.17 - 2013.

The tests were performed in order to determine the compliance of the EUT with FCC Part 15-Subpart D, section 15.207, 15.315, 15.317, 15.319 and 15.323 rules.

Related Submittal(s)/Grant(s)

No related submission.

Test Methodology

All measurements contained in this report were conducted with ANSI C63.17 - 2013, American National Standard Methods of Measurement of the Electromagnetic and Operational Compatibility of Unlicensed Personal Communications Services (UPCS) Devices.

All emissions measurement was performed at Bay Area Compliance Laboratories Corp. (Shenzhen). The radiated testing was performed at an antenna-to-EUT distance of 3 meters.

Measurement Uncertainty

| Item | Uncertainty |
|------------------------------------|-----------------------|
| AC Power Lines Conducted Emissions | $\pm 1.95\text{dB}$ |
| RF conducted test with spectrum | $\pm 1.5\text{dB}$ |
| Occupied Bandwidth | $\pm 5\%$ |
| Temperature | $\pm 3^\circ\text{C}$ |
| Humidity | $\pm 6\%$ |
| Supply voltages | $\pm 0.4\%$ |

Note: Otherwise required by the applicant or Product Regulations, Decision Rule in this report did not consider the uncertainty.

Test Facility

The Test site used by Bay Area Compliance Laboratories Corp. (Shenzhen) to collect test data is located on the 6/F., West Wing, Third Phase of Wanli Industrial Building, Shihua Road, Futian Free Trade Zone, Shenzhen, Guangdong, China.

The test site has been approved by the FCC under the KDB 974614 D01 and is listed in the FCC Public Access Link (PAL) database, FCC Registration No.: 342867, the FCC Designation No.: CN1221.

The test site has been registered with ISED Canada under ISED Canada Registration Number 3062B.

SYSTEM TEST CONFIGURATION

Description of Test Configuration

The system was configured to testing mode which is provided by the manufacturer.

Equipment Modifications

No modification was made to the EUT tested.

Local Support Equipment List and Details

| Manufacturer | Description | Model | Serial Number |
|-----------------|----------------------------------|-------|---------------|
| Rohde & Schwarz | Digital Radio Communication Test | CMD60 | 830861/029 |

External I/O Cable

| Cable Description | Length (m) | From Port | To |
|-------------------------------------|------------|-----------|-----|
| Un-shielding Un-detachable DC Cable | 1.9 | Adapter | EUT |

Block Diagram of Test Setup

For conducted emissions:

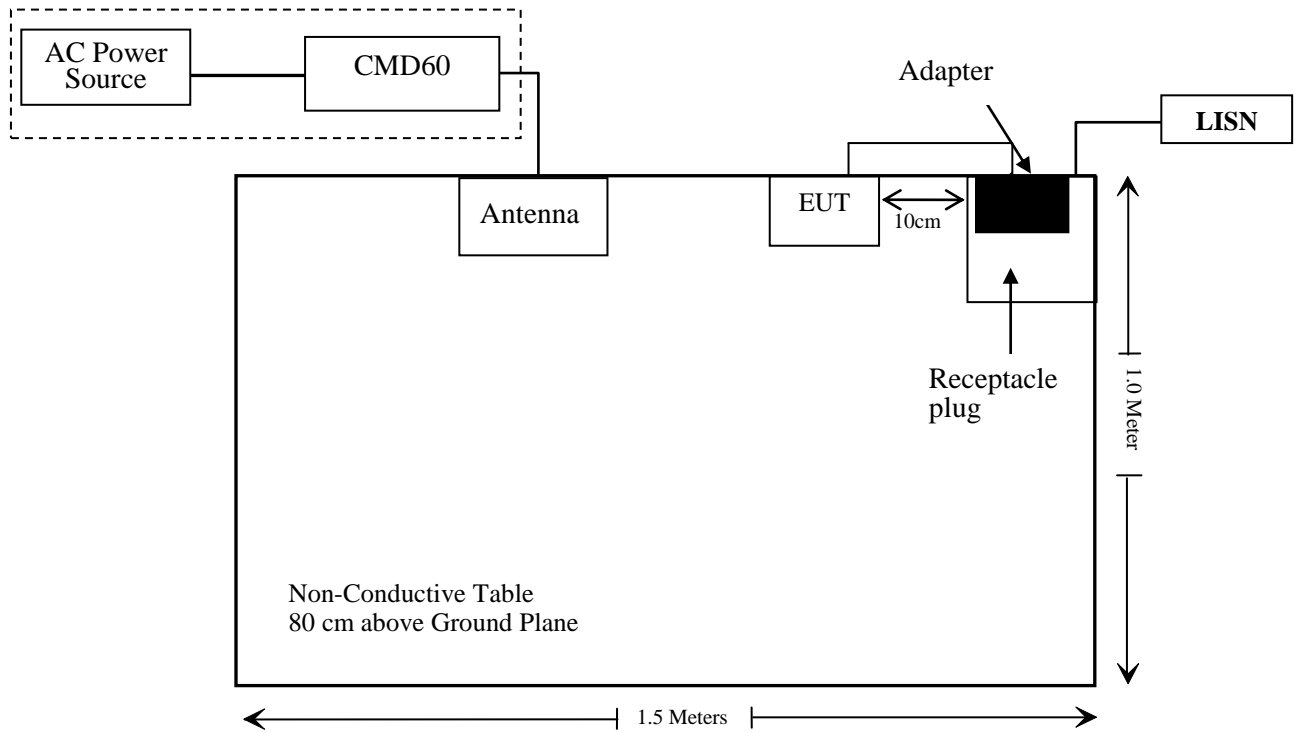

SUMMARY OF TEST RESULTS

| FCC Rules | Description of Test | Result |
|---------------------------------|--|----------------|
| § 15.319 (i)&2.1091 | Maximum Permissible exposure (MPE) | Compliance |
| § 15.317, § 15.203 | Antenna Requirement | Compliance |
| § 15.315, § 15.207 | Conducted Emission | Compliance |
| § 15.323 (a) | Emission Bandwidth | Compliance |
| § 15.319 (c) | Peak Transmit Power | Compliance |
| § 15.319 (d) | Power Spectral Density | Compliance |
| § 15.323 (d) | Emission Inside and Outside the sub-band | Compliance |
| § 15.319 (g) | Radiated Emission | Not Applicable |
| § 15.323 (f) | Frequency Stability Handset | Compliance |
| § 15.323 (c)(e) § 15.319 (f) | Specific Requirements for UPCS | Compliance |

Not Applicable: EUT is compliance with 15.323 (d).

Note: Pre-scan with two symmetrical antennas for conducted peak power, and antenna 1 for the max power one, which was selected to test conducted items.

TEST EQUIPMENT LIST

| Manufacturer | Description | Model | Serial Number | Calibration Date | Calibration Due Date |
|---------------------------------|-------------------------------------|-------------|------------------------|------------------|----------------------|
| Conducted Emissions Test | | | | | |
| Rohde & Schwarz | EMI Test Receiver | ESCS30 | 100176 | 2018-07-11 | 2019-07-11 |
| Rohde & Schwarz | LISN | ENV216 | 3560.6650.12-101613-Yb | 2018-12-21 | 2019-12-21 |
| Rohde & Schwarz | Transient Limiter | ESH3Z2 | DE25985 | 2018-11-12 | 2019-11-12 |
| Rohde & Schwarz | CE Test software | EMC 32 | V8.53.0 | NCR | NCR |
| Unknown | Conducted Emission Cable | 78652 | UF A210B-1-0720-504504 | 2018-11-12 | 2019-11-12 |
| RF Conducted test | | | | | |
| Ducommun technologies | RF Cable | RG-214 | 3 | Each Time | |
| WEINSCHL | 10dB Attenuator | 5324 | AU 3842 | Each Time | |
| WEINSCHL | 6dB Attenuator | 50-6 | R4376 | Each Time | |
| Rohde & Schwarz | Spectrum Analyzer | FSU26 | 200120 | 2018-12-24 | 2019-12-24 |
| HONOVA | Power Splitter | ZFRSC-14-S+ | 019411452 | 2019-06-12 | 2020-06-12 |
| Rohde & Schwarz | Digital Radio Communication Test | CMD60 | 830861/029 | 2019-06-23 | 2020-06-23 |
| TDK | Chamber | Chamber B | 1# | 2016-12-06 | 2019-12-06 |
| Rohde & Schwarz | Wideband Radio Communication Tester | CMW500 | 1201.002K50-146520-wh | 2019-06-23 | 2020-06-23 |

* **Statement of Traceability:** Bay Area Compliance Laboratories Corp. (Shenzhen) attests that all calibrations have been performed in accordance to requirements that traceable to National Primary Standards and International System of Units (SI).

§1.1307 (b) (1) & §2.1091- MAXIMUM PERMISSIBLE EXPOSURE (MPE)

Applicable Standard

According to FCC §15.319(i) and §1.1307(b)(1), systems operating under the provisions of this section shall be operated in a manner that ensures that the public is not exposed to radio frequency energy level in excess of the Commission’s guidelines.

Limits for Maximum Permissible Exposure (MPE) (§1.1310, §2.1091)

| Frequency Range (MHz) | Electric Field Strength (V/m) | Magnetic Field Strength (A/m) | Power Density (mW/cm ²) | Averaging Time (minute) |
|--|-------------------------------|-------------------------------|-------------------------------------|-------------------------|
| Limits for General Population/Uncontrolled Exposure | | | | |
| 0.3-1.34 | 614 | 1.63 | *(100) | 30 |
| 1.34-30 | 842/f | 2.19/f | *(180/f ²) | 30 |
| 30-300 | 27.5 | 0.073 | 0.2 | 30 |
| 300-1500 | / | / | f/1500 | 30 |
| 1500-100,000 | / | / | 1.0 | 30 |

f = frequency in MHz

* = Plane-wave equivalent power density

MPE Calculation

Predication of MPE limit at a given distance

$$S = \frac{PG}{4\pi R^2}$$

Where: S = power density (in appropriate units, e.g. mW/cm²);

P = power input to the antenna (in appropriate units, e.g., mW);

G = power gain of the antenna in the direction of interest relative to an isotropic radiator

R = distance to the center of radiation of the antenna (appropriate units, e.g., cm);

For worst case:

| Frequency (MHz) | Antenna Gain | | Tune-up conducted power | | Evaluation Distance (cm) | Power Density (mW/cm ²) | MPE Limit (mW/cm ²) |
|-----------------|--------------|-----------|-------------------------|-------|--------------------------|-------------------------------------|---------------------------------|
| | (dBi) | (numeric) | (dBm) | (mW) | | | |
| 1920 - 1930 | 2 | 1.58 | 20.1 | 102.3 | 20 | 0.03 | 1.0 |

Result: Compliance. To maintain compliance with the FCC’s RF exposure guidelines, place the equipment at least 20cm from nearby persons.

FCC §15.317 & §15.203 - ANTENNA REQUIREMENT

Applicable Standard

According to FCC § 15.203, an intentional radiator shall be designed to ensure that no antenna other than that furnished by the responsible party shall be used with the device. The use of a permanently attached antenna or of an antenna that uses a unique coupling to the intentional radiator shall be considered sufficient to comply with the provisions of this Section. The manufacturer may design the unit so that a broken antenna can be replaced by the user, but the use of a standard antenna jack or electrical connector is prohibited.

Antenna Connector Construction

The EUT has two internal antennas arrangement, which were permanently attached and the gain is 2 dBi, fulfill the requirement of this section. Please refer to the EUT photos.

Result: Compliant.

FCC §15.315 & §15.207 - CONDUCTED EMISSIONS

Applicable Standard

FCC §15.315, an unlicensed PCS device that is designed to be connected to the public utility (AC) power line must meet the limits specified in §15.207.

EUT Setup

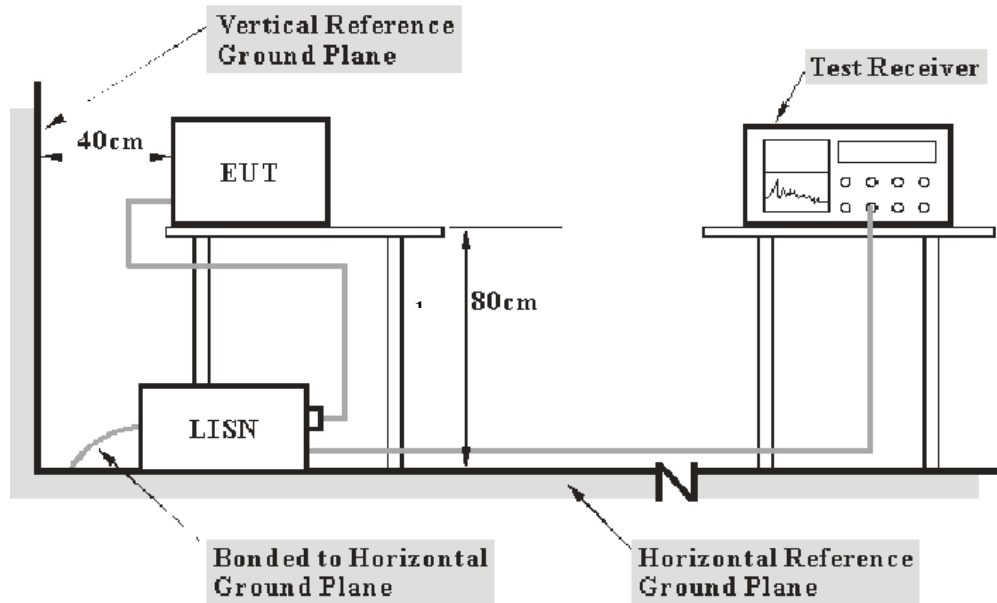

- Note: 1. Support units were connected to second LISN.
 2. Both of LISNs (AMN) 80 cm from EUT and at the least 80 cm from other units and other metal planes support units.

The setup of EUT is according with per ANSI C63.10-2013 measurement procedure. The specification used was with the FCC 15.315 and FCC 15.207 limits.

The external I/O cables were draped along the test table and formed a bundle 30 to 40 cm long in the middle.

The spacing between the peripherals was 10 cm.

The adapter was connected to a 120 VAC/60 Hz power source.

EMI Test Receiver Setup

The EMI test receiver was set to investigate the spectrum from 150 kHz to 30 MHz.

During the conducted emission test, the EMI test receiver was set with the following configurations:

| Frequency Range | IF B/W |
|------------------|--------|
| 150 kHz – 30 MHz | 9 kHz |

Test Procedure

During the conducted emission test, adapter was connected to the outlet of the LISN.

Maximizing procedure was performed on the six (6) highest emissions of the EUT.

All final data was recorded in the Quasi-peak and average detection mode.

Corrected Factor & Margin Calculation

The Corrected factor is calculated by adding the Outlet Cable Loss, LISN Insertion Loss, Cable Loss and Transient Limiter Attenuation. The basic equation is as follows:

Correction Factor = Outlet Cable Loss + LISN Insertion Loss + Cable Loss + Transient Limiter Attenuation

The “**Margin**” column of the following data tables indicates the degree of compliance with the applicable limit. For example, a margin of 7 dB means the emission is 7 dB below the limit. The equation for margin calculation is as follows:

$$\text{Margin} = \text{Limit} - \text{Corrected Amplitude}$$

Test Results Summary

According to the recorded data in following table, the EUT complied with the FCC Part 15.207.

Refer to CISPR16-4-2:2011 and CISPR 16-4-1:2009, the measured level is in compliance with the limit if

$$L_m + U_{(L_m)} \leq L_{\text{lim}} + U_{\text{cispr}}$$

In BACL, $U_{(L_m)}$ is less than U_{cispr} , if L_m is less than L_{lim} , it implies that the EUT complies with the limit.

Test Data

Environmental Conditions

| | |
|---------------------------|-----------|
| Temperature: | 25 °C |
| Relative Humidity: | 52 % |
| ATM Pressure: | 101.0 kPa |

The testing was performed by Haiguo Li on 2019-06-24.

Test mode: Transmitting

AC 120V/60 Hz, Line

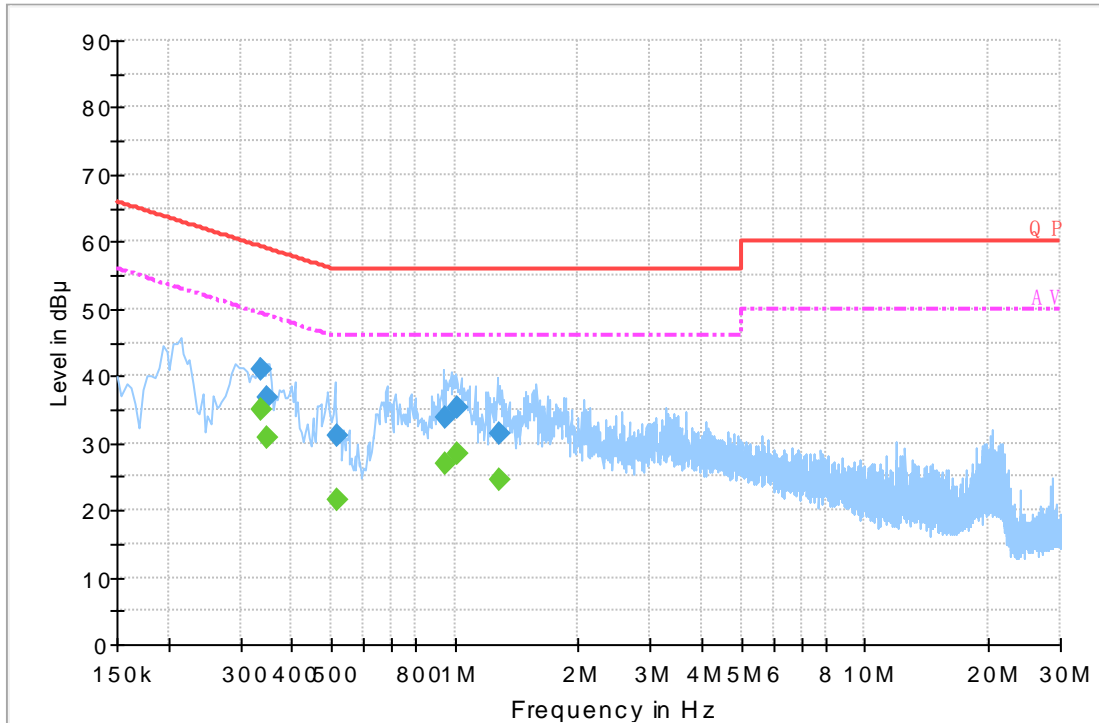

| Frequency (MHz) | Corrected Amplitude (dBµV) | Correction Factor (dB) | Limit (dBµV) | Margin (dB) | Detector (PK/Ave./QP) |
|-----------------|----------------------------|------------------------|--------------|-------------|-----------------------|
| 0.339010 | 40.8 | 19.9 | 59.2 | 18.4 | QP |
| 0.348690 | 36.7 | 19.9 | 59.0 | 22.3 | QP |
| 0.514350 | 31.0 | 19.8 | 56.0 | 25.0 | QP |
| 0.943930 | 33.7 | 19.8 | 56.0 | 22.3 | QP |
| 1.018490 | 35.1 | 19.9 | 56.0 | 20.9 | QP |
| 1.290890 | 31.5 | 19.8 | 56.0 | 24.5 | QP |
| 0.339010 | 35.0 | 19.9 | 49.2 | 14.2 | Ave. |
| 0.348690 | 30.7 | 19.9 | 49.0 | 18.3 | Ave. |
| 0.514350 | 21.5 | 19.8 | 46.0 | 24.5 | Ave. |
| 0.943930 | 26.9 | 19.8 | 46.0 | 19.1 | Ave. |
| 1.018490 | 28.5 | 19.9 | 46.0 | 17.5 | Ave. |
| 1.290890 | 24.6 | 19.8 | 46.0 | 21.4 | Ave. |

AC 120V/60 Hz, Neutral

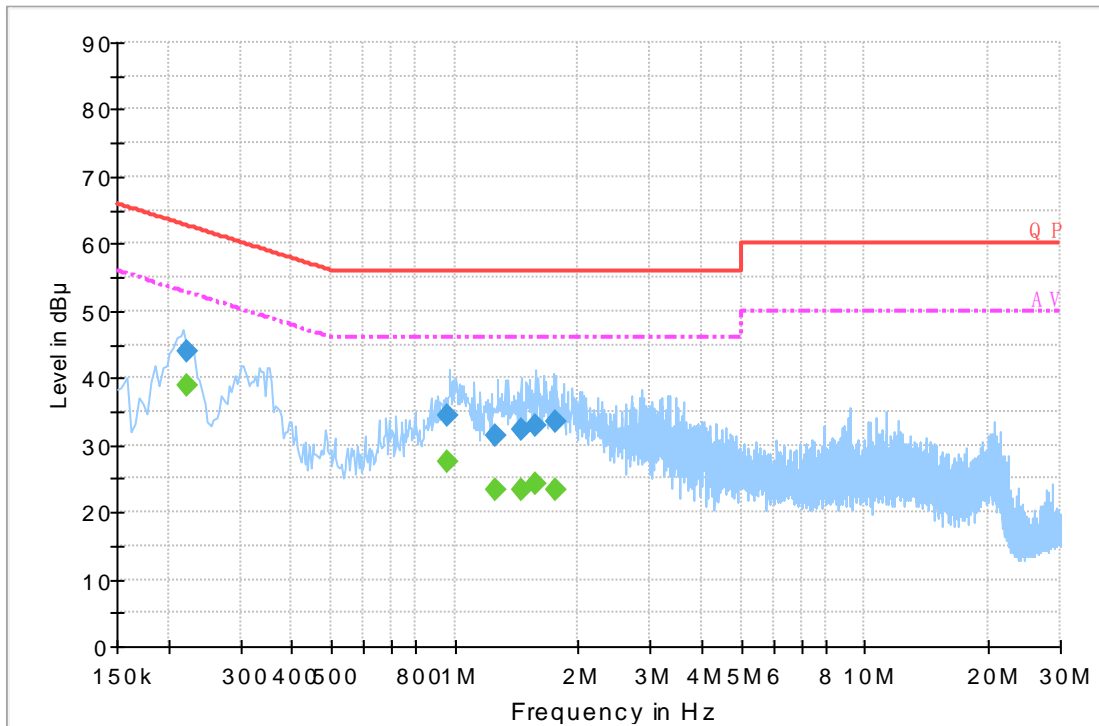

| Frequency (MHz) | Corrected Amplitude (dBµV) | Correction Factor (dB) | Limit (dBµV) | Margin (dB) | Detector (PK/Ave./QP) |
|-----------------|----------------------------|------------------------|--------------|-------------|-----------------------|
| 0.221500 | 43.9 | 19.8 | 62.8 | 18.9 | QP |
| 0.959450 | 34.5 | 19.8 | 56.0 | 21.5 | QP |
| 1.254890 | 31.3 | 19.8 | 56.0 | 24.7 | QP |
| 1.460250 | 32.3 | 19.8 | 56.0 | 23.7 | QP |
| 1.566510 | 32.8 | 19.8 | 56.0 | 23.2 | QP |
| 1.759930 | 33.5 | 19.8 | 56.0 | 22.5 | QP |
| 0.221500 | 38.7 | 19.8 | 52.8 | 14.1 | Ave. |
| 0.959450 | 27.4 | 19.8 | 46.0 | 18.6 | Ave. |
| 1.254890 | 23.2 | 19.8 | 46.0 | 22.8 | Ave. |
| 1.460250 | 23.5 | 19.8 | 46.0 | 22.5 | Ave. |
| 1.566510 | 24.2 | 19.8 | 46.0 | 21.8 | Ave. |
| 1.759930 | 23.4 | 19.8 | 46.0 | 22.6 | Ave. |

Note:

- 1) Correction Factor = LISN VDF (Voltage Division Factor) + Cable Loss + Transient Limiter Attenuation
- 2) Corrected Amplitude = Reading + Correction Factor
- 3) Margin = Limit – Corrected Amplitude

FCC §15.323 (a) - EMISSION BANDWIDTH

Applicable Standard

Operation shall be contained within the 1920–1930 MHz band. The emission bandwidth shall be less than 2.5 MHz and greater than 50 kHz.

The emission bandwidth is measured in accordance with ANSI C63.17 sub-clause 6.1.3 using the setup below:

Test Setup 1:

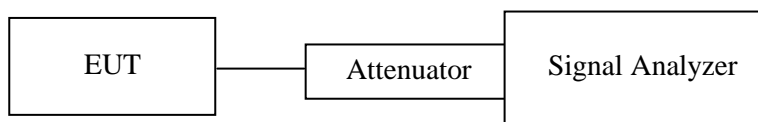

The width, in Hz, of the signal between two points, one below the carrier center frequency and one above the carrier center frequency, that is 26 dB down relative to the maximum level of the modulated carrier. It is based on the use of measurement instrumentation employing a peak detector function with an instrument resolution bandwidth approximately equal to 1% of the emission band-width of the device under measurement. [Extraction from 47 CFR 15, subpart D, 15.303 (C)].

Test Procedure

Using the manufacturer’s information on occupied bandwidth set the spectrum analyzer as follows:

| | |
|----------------------|---|
| Resolution bandwidth | 1.0% of the emission bandwidth (as close as possible) |
| Video bandwidth | >3 times the resolution bandwidth |
| Number of sweeps | sufficient to stability the trace |
| Detection mode | peak detection with maximum hold |

Test Data

Environmental Conditions

| | |
|---------------------------|-----------|
| Temperature: | 25 °C |
| Relative Humidity: | 52 % |
| ATM Pressure: | 101.0 kPa |

The testing was performed by Kieroy Luo on 2019-06-22.

Test mode: Transmitting

| Channel | Center Frequency (MHz) | 26 dB Emission Bandwidth (MHz) | Limit |
|---------|------------------------|--------------------------------|------------------|
| Low | 1921.536 | 1.423 | 50 kHz ~ 2.5 MHz |
| Middle | 1924.992 | 1.428 | 50 kHz ~ 2.5 MHz |
| High | 1928.448 | 1.428 | 50 kHz ~ 2.5 MHz |

Test Result: Compliance. Please refer to the following plots.

Low Channel

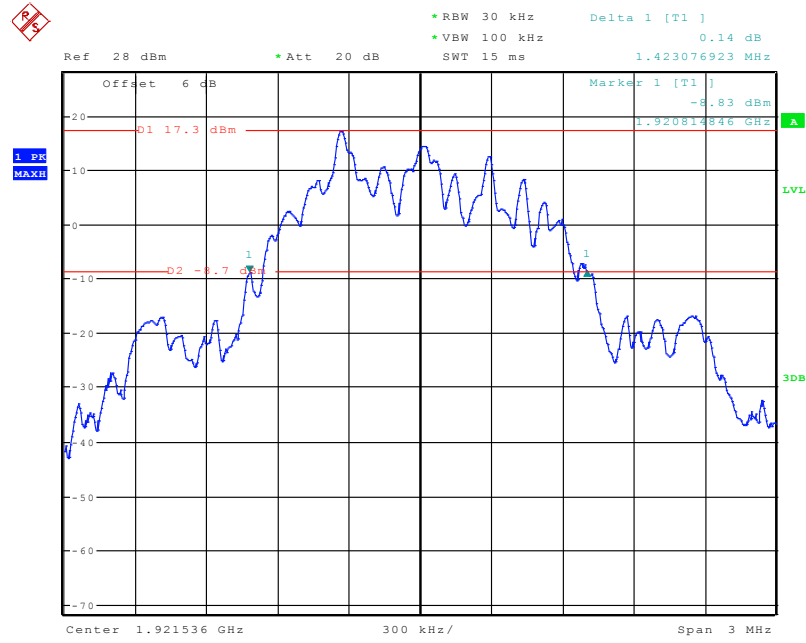

Date: 22.JUN.2019 17:23:23

Middle Channel

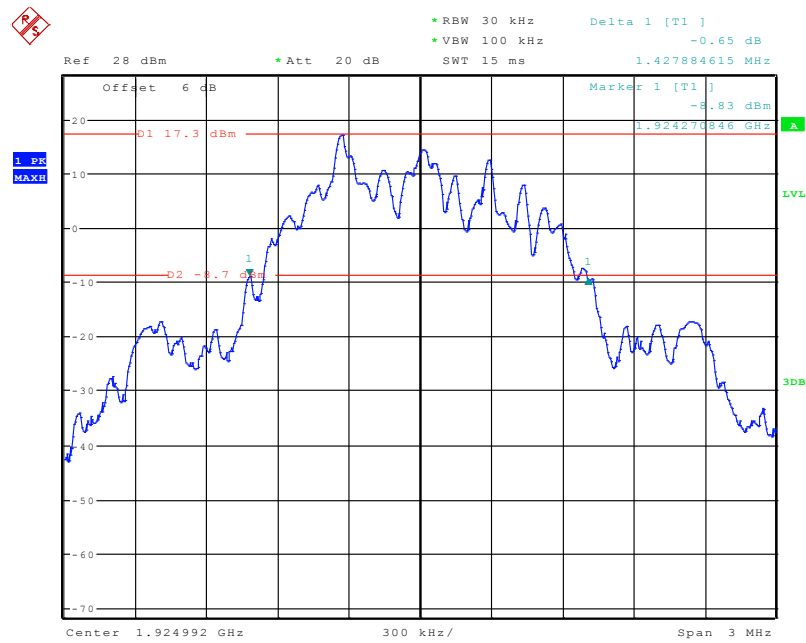

Date: 22.JUN.2019 17:21:15

High Channel

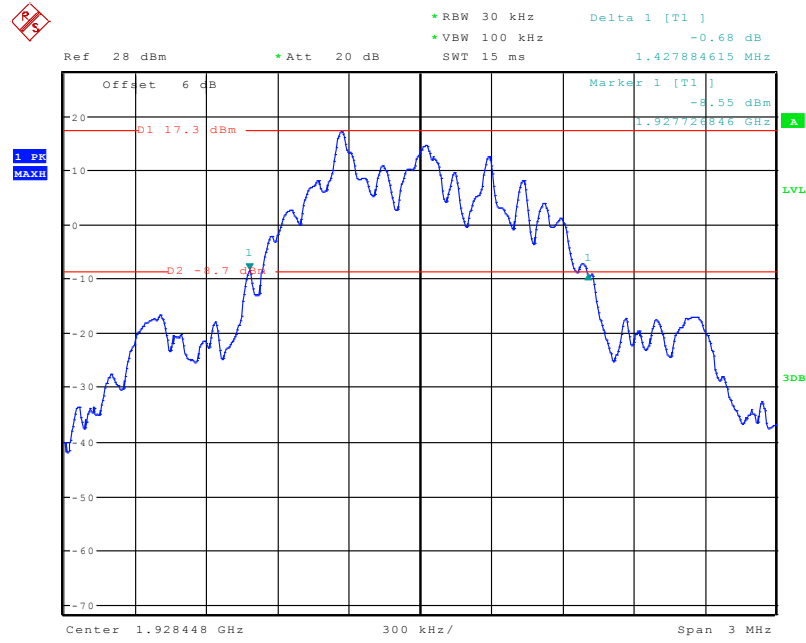

Date: 22.JUN.2019 17:18:27

FCC §15.319 (c) - PEAK TRANSMIT POWER

Applicable Standard

The peak power output as measured over an interval of time equal to the frame rate or transmission burst of the device under all conditions of modulation. Usually this parameter is measured as a conducted emission by direct connection of a calibrated test instrument to the equipment under test. If the device cannot be connected directly, alternative techniques acceptable to the Commission may be used[47 CFR 15, subpart D, 15.303].

The peak transmit power is according to ANSI C63.17-2013 §6.1.2

Per FCC Part 15.319 (c) Peak transmit power shall not exceed 100 microwatts multiplied by the square root of the emission bandwidth in hertz. Peak transmit power must be measured over any interval of continuous transmission using instrumentation calibrated in terms of an rms-equivalent voltage. The measurement results shall be properly adjusted for any instrument limitations, such as detector response times, limited resolution bandwidth capability when compared to the emission bandwidth, sensitivity, etc., so as to obtain a true peak measurement for the emission in question over the full bandwidth of the channel.

Per FCC Part 15.319 (e), the peak transmit power shall be reduced by the amount in decibels that the maximum directional gain of the antenna exceeds 3 dBi.

Calculation of Peak Transmit Power Limit:

$$\text{Peak Transmit Power Limit} = 100\mu\text{W} \times (\text{EBW})^{1/2}$$

EBW is the transmit emission bandwidth in Hz determined in the other test item:

Test Procedure

Using the manufacturer's information on occupied bandwidth set the spectrum analyzer as follows:

| | |
|------------------|---|
| RBW | ≥ Emission bandwidth |
| Video bandwidth | ≥ RBW |
| Span | Zero |
| Center frequency | Nominal center frequency of channels |
| Amplitude scale | Log (linear may be used if analyzer has sufficient linear dynamic range and accuracy) |
| Detection | Peak detection |
| Trigger | Video |
| Sweep rate | Sufficiently rapid to permit the transmit pulse to be resolved accurately |

Test Data

Environmental Conditions

| | |
|---------------------------|-----------|
| Temperature: | 25 °C |
| Relative Humidity: | 52 % |
| ATM Pressure: | 101.0 kPa |

The testing was performed by Kieroy Luo on 2019-06-22.

Test Result: Compliance. Please refer to the following table and plots.

Test mode: Transmitting:

| Channel | Frequency (MHz) | Peak Transmit Power (dBm) | Limit (dBm) |
|---|-----------------|---------------------------|-------------|
| Low | 1921.536 | 20.03 | 20.77 |
| Middle | 1924.992 | 19.95 | 20.77 |
| High | 1928.448 | 19.89 | 20.77 |
| EBW _{Low channel} = 1423000Hz, EBW _{Middle channel} = 1428000 Hz, EBW _{High channel} = 1428000 Hz Peak Transmit Power Limit = $100(\text{EBW})^{1/2} \mu\text{W}$ | | | |

Low Channel

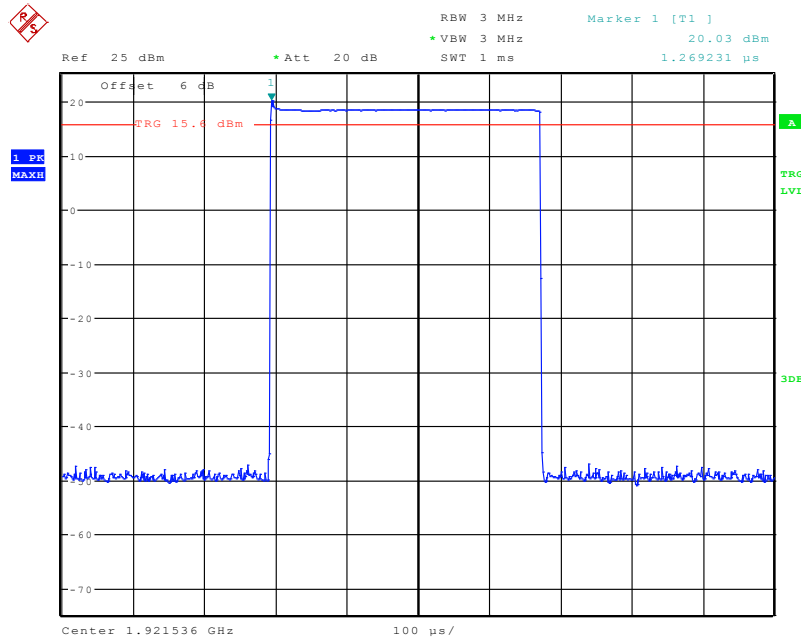

Date: 22.JUN.2019 16:09:03

Middle Channel

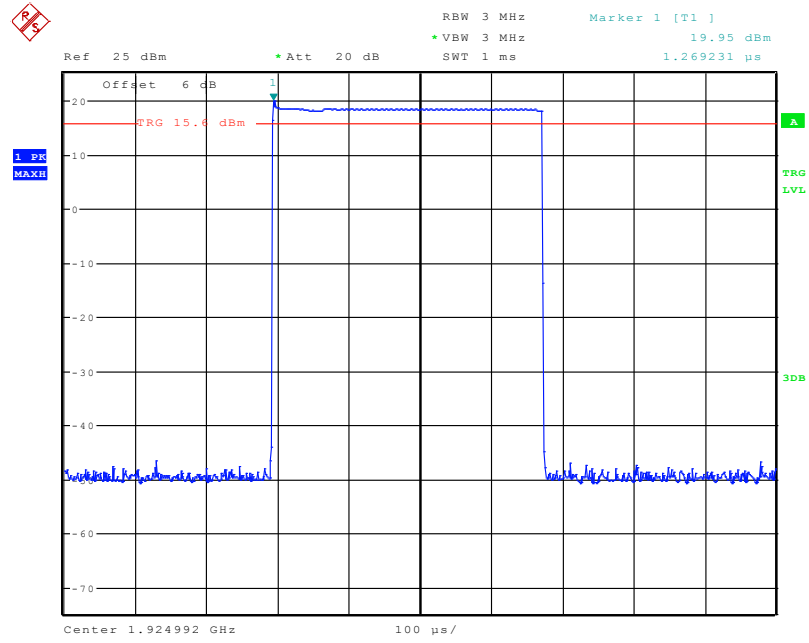

Date: 22.JUN.2019 16:08:29

High Channel

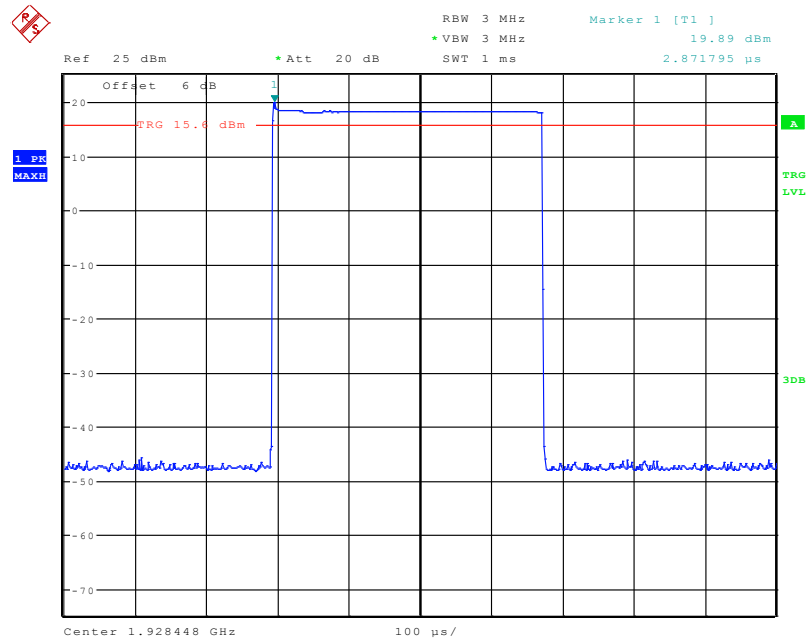

Date: 22.JUN.2019 16:06:34

FCC §15.319 (d) - POWER SPECTRAL DENSITY

Applicable Standard

The average pulse energy in a 3 kHz bandwidth is divided by the pulse duration.

The power spectral density shall not exceed 3mW in any 3 kHz bandwidth as measured with a spectrum analyzer having a resolution bandwidth of 3 kHz.

The power spectral density is measured in accordance with ANSI C63.17.2013 Clause 6.1.5.

Test Procedure

Using the manufacturer's information on occupied bandwidth set the spectrum analyzer as follows:

| | |
|------------------|---|
| RBW | 3 kHz |
| Video bandwidth | $\geq 3 \times \text{RBW}$ |
| Span | Zero span at frequency with the maximum level (frequency determined in 6.1.3 if the same type of signal (continuous versus burst) was used in 6.1.3) |
| Center frequency | Spectral peak as determined in 6.1.3 |
| Sweep time | For burst signals, sufficient to include essentially all of the maximum length burst at the output of a 3 kHz filter (e.g., maximum input burst duration plus 600 μs). For continuous signals, 20 ms. |
| Amplitude scale | Log power |
| Detection | Sample detection and averaged for a minimum of 100 sweeps |
| Trigger | External or internal |

Test Data

Environmental Conditions

| | |
|---------------------------|-----------|
| Temperature: | 25 °C |
| Relative Humidity: | 52 % |
| ATM Pressure: | 101.0 kPa |

The testing was performed by Kieroy Luo on 2019-06-24.

Test Result: Compliance. Please refer to following table and plots

Test mode: Transmitting

Note: Test under PRBS modulation

| Channel | Frequency (MHz) | Power Spectral Density | | Limit (mW/3kHz) | Result |
|---------|-----------------|------------------------|-----------|-----------------|--------|
| | | (dBm/3kHz) | (mW/3kHz) | | |
| Low | 1921.536 | -5.15 | 0.31 | 3 | Pass |
| Middle | 1924.992 | -5.45 | 0.29 | 3 | Pass |
| High | 1928.448 | -5.21 | 0.30 | 3 | Pass |

Low Channel

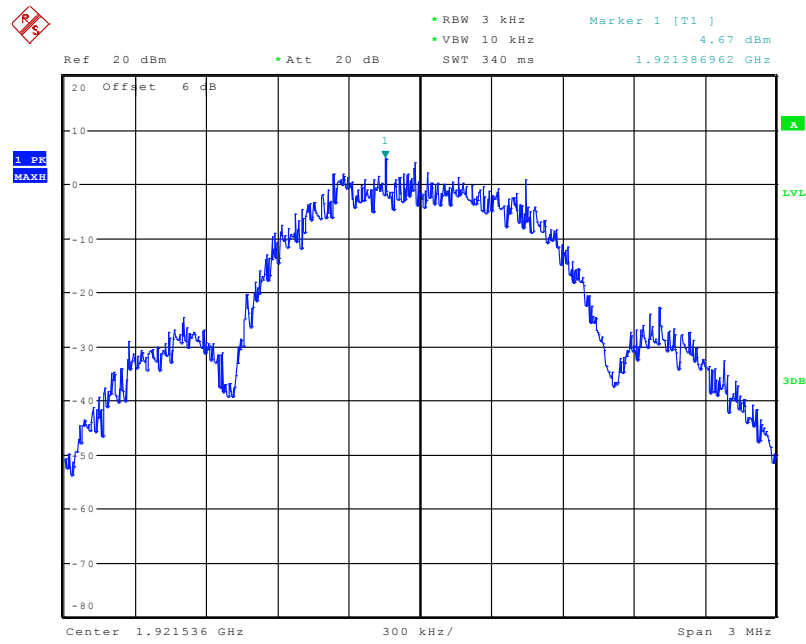

Date: 24.JUN.2019 17:14:15

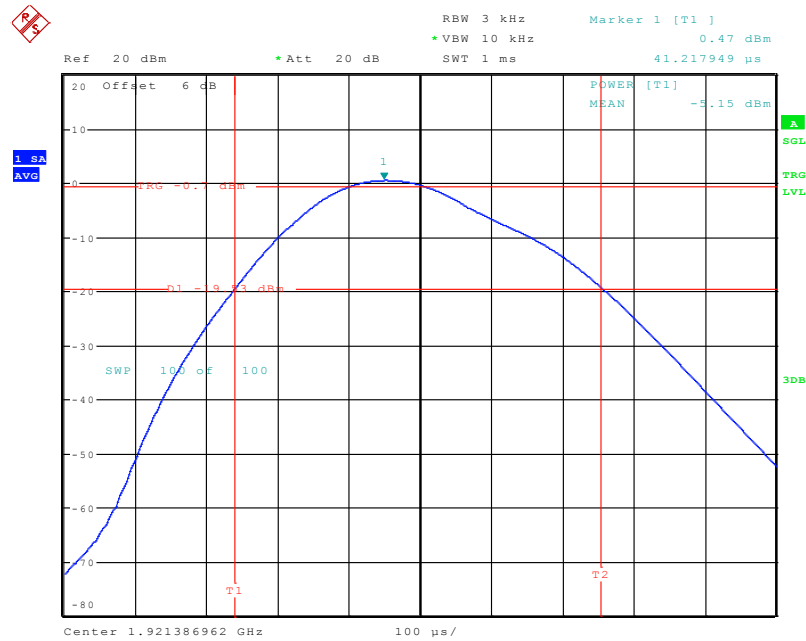

Date: 24.JUN.2019 17:15:30

Middle Channel

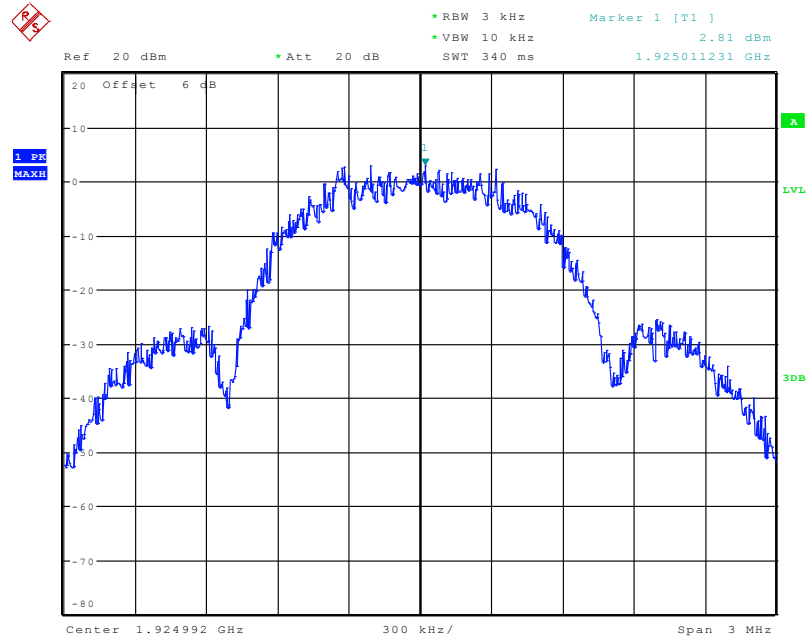

Date: 24.JUN.2019 17:10:02

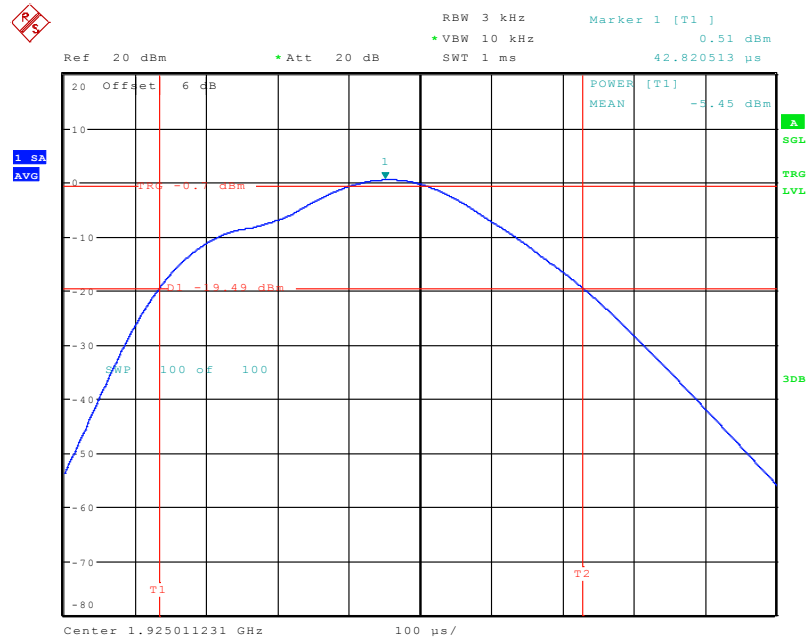

Date: 24.JUN.2019 17:12:05

High Channel

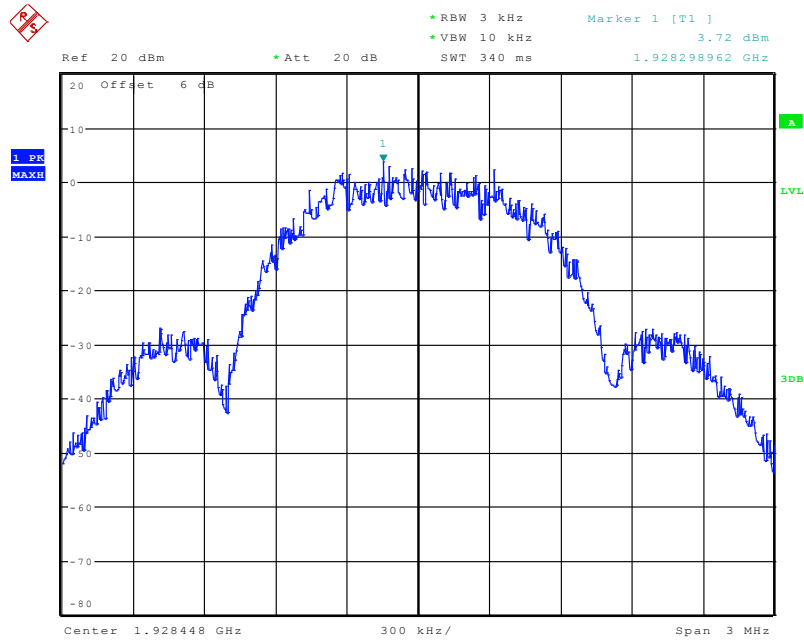

Date: 24.JUN.2019 17:06:12

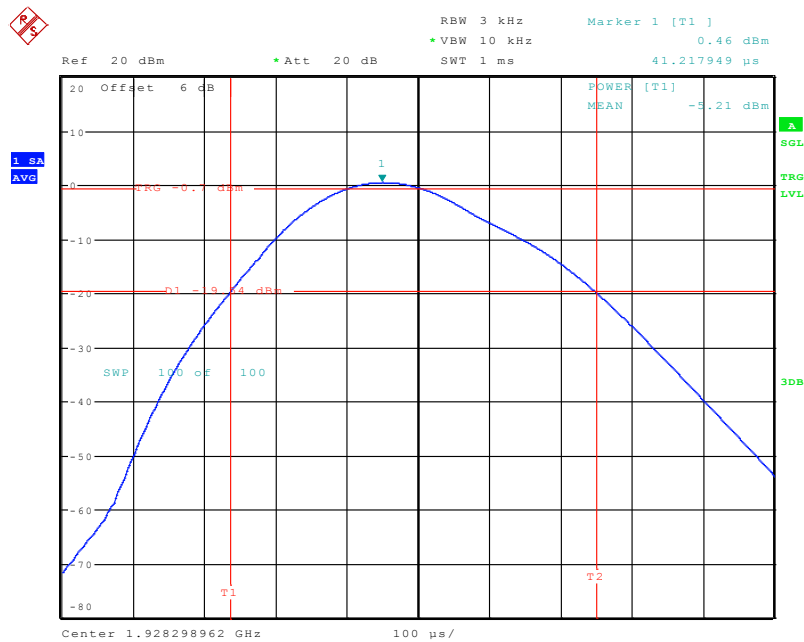

Date: 24.JUN.2019 17:08:00

FCC §15.323 (d) - EMISSION INSIDE AND OUTSIDE THE SUB-BAND

Applicable Standard

Emissions inside the sub-band must comply with the following emission mask:

1. In the bands between 1B and 2B measured from the center of the emission bandwidth the total power emitted by the device shall be at least 30 dB below the transmit power permitted for that device;
2. in the bands between 2B and 3B measured from the center of the emission bandwidth the total power emitted by an intentional radiator shall be at least 50 dB below the transmit power permitted for that radiator;
3. in the bands between 3B and the sub-band edge the total power emitted by an intentional radiator in the measurement bandwidth shall be at least 60 dB below the transmit power permitted for that radiator.

Where B = emission bandwidth

Emission Outside the sub-band shall be attenuated below a reference power of 112 mw (20.5 dBm) as follows:

1. 30 dB between the sub-band and 1.25 MHz above or below the sub-band;
2. 50 dB between 1.25 and 2.5 MHz above or below the sub-band;
3. 60 dB at 2.5 MHz or greater above or below the sub-band.

Test Procedure

According to ANSI C63.17.2013 Clause 6.1.6.

Test Data

Environmental Conditions

| | |
|---------------------------|-----------|
| Temperature: | 25 °C |
| Relative Humidity: | 52 % |
| ATM Pressure: | 101.0 kPa |

The testing was performed by Kieroy Luo on 2019-06-22.

Test mode: Transmitting

Test Result: Compliance. Please refer to following plots

Low Channel (Unwanted Emission inside the Sub-band)

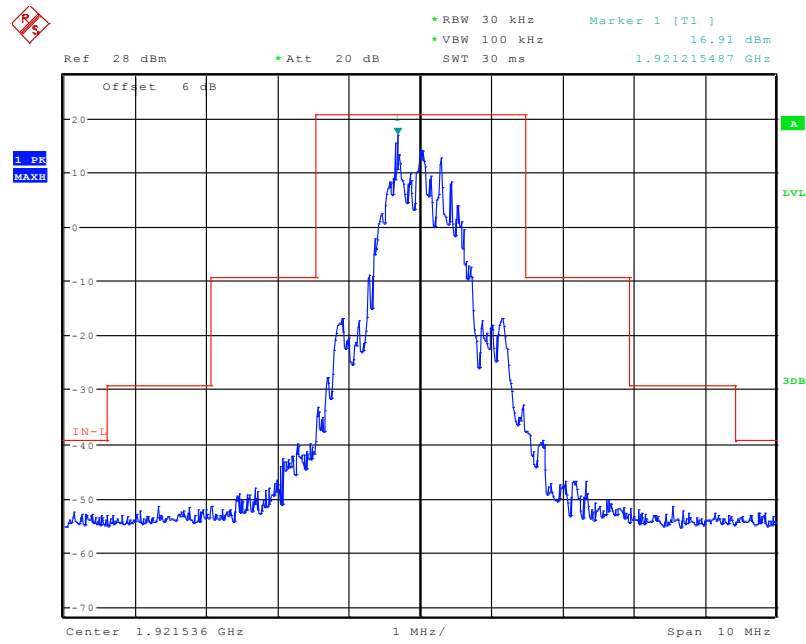

Date: 22.JUN.2019 17:11:39

Middle Channel (Unwanted Emission inside the Sub-band)

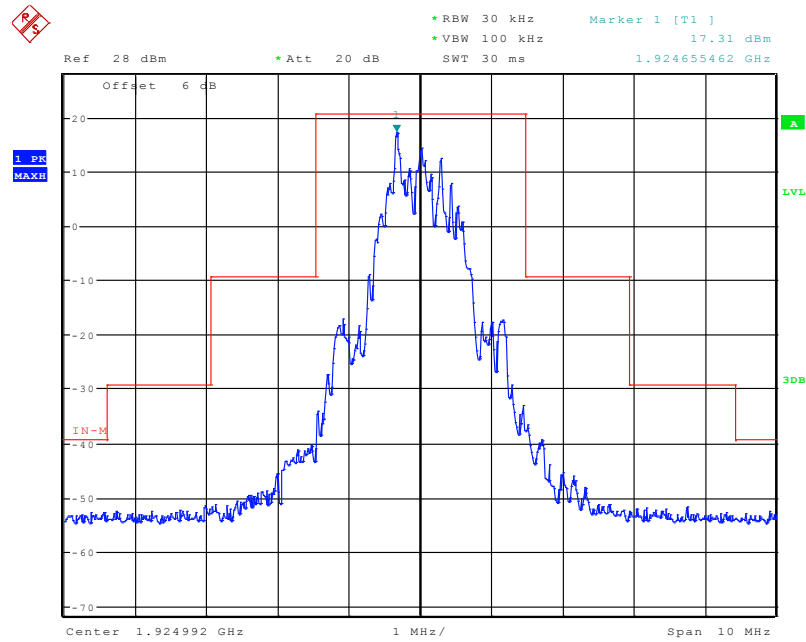

Date: 22.JUN.2019 17:13:04

High Channel (Unwanted Emission inside the Sub-band)

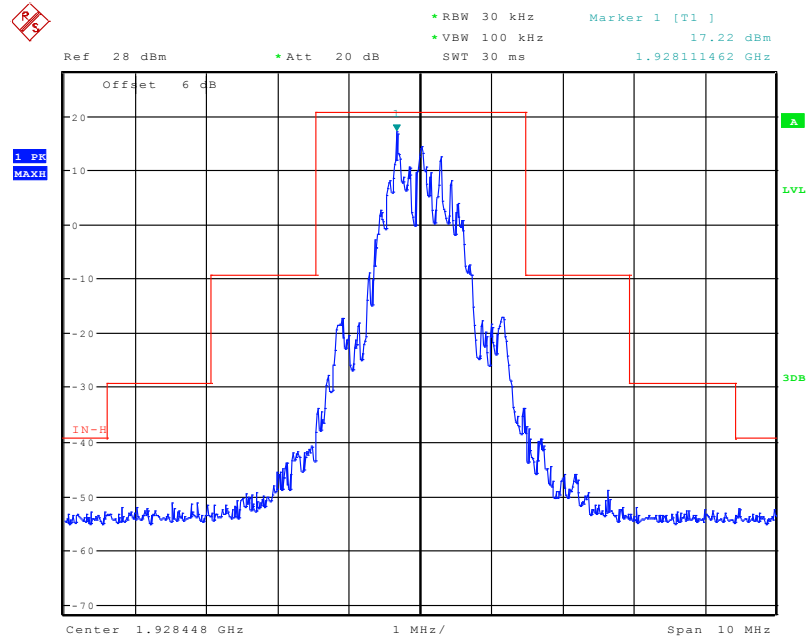

Date: 22.JUN.2019 17:13:56

Low Channel (Unwanted Emission outside the Sub-band)

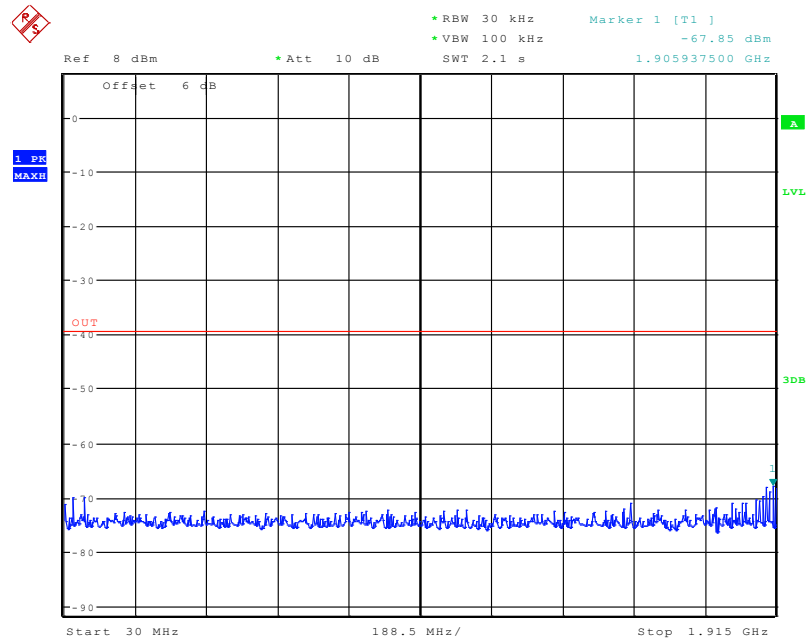

Date: 22.JUN.2019 17:08:35

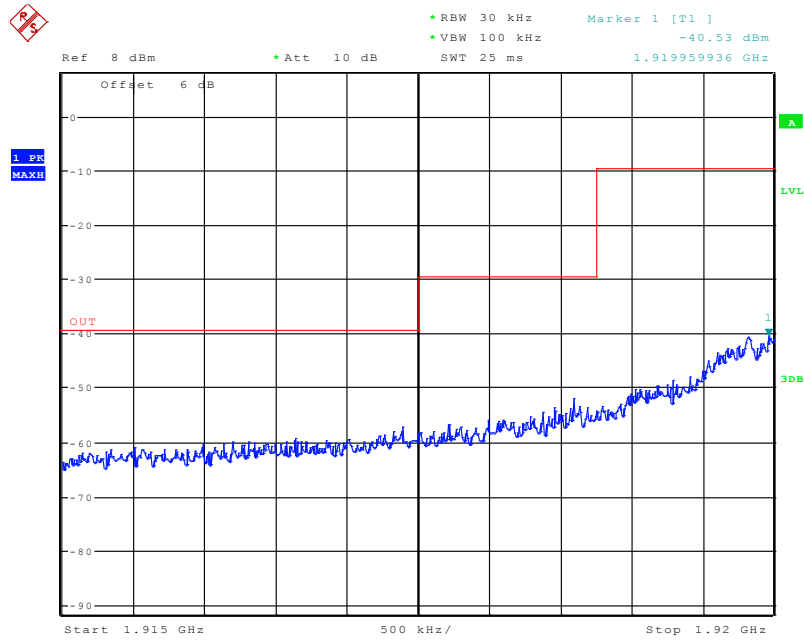

Date: 22.JUN.2019 17:08:04

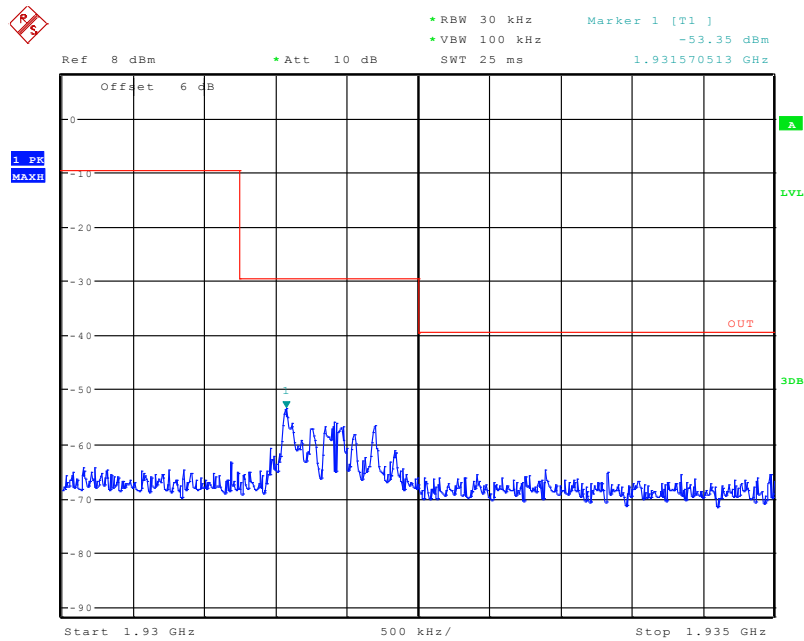

Date: 22.JUN.2019 17:09:15

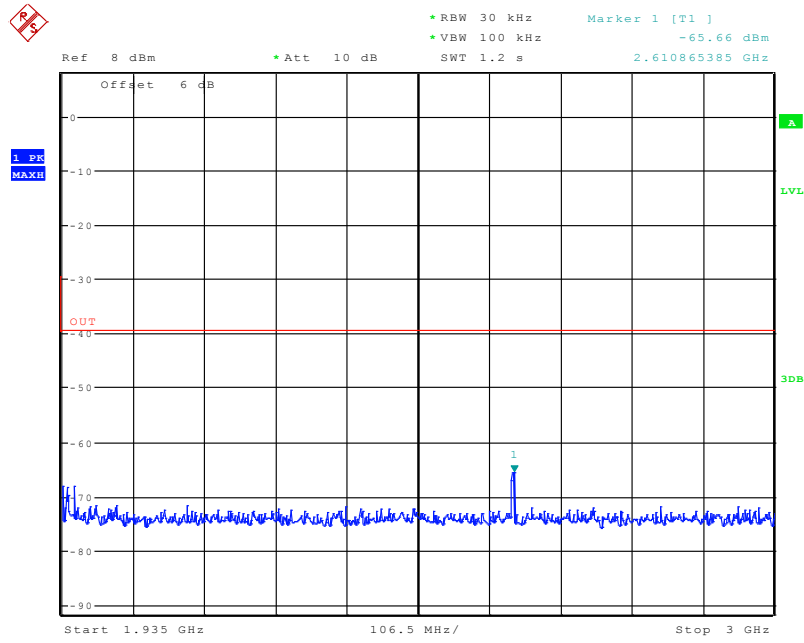

Date: 22.JUN.2019 17:09:39

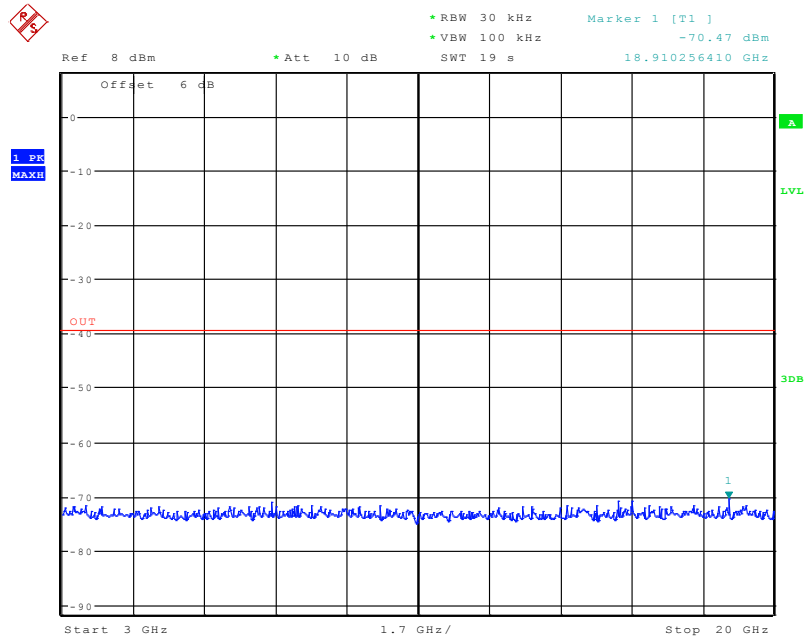

Date: 22.JUN.2019 17:10:32

Middle Channel (Unwanted Emission outside the Sub-band)

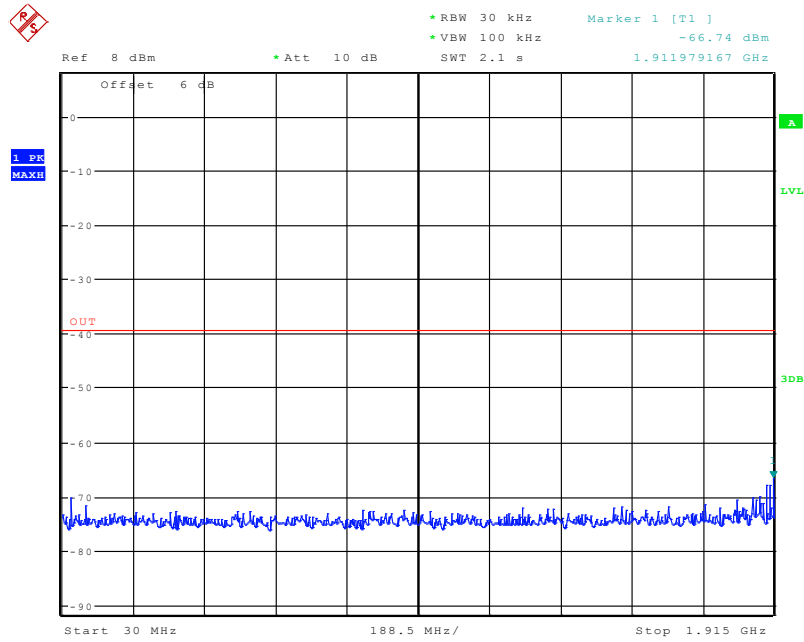

Date: 22.JUN.2019 16:58:44

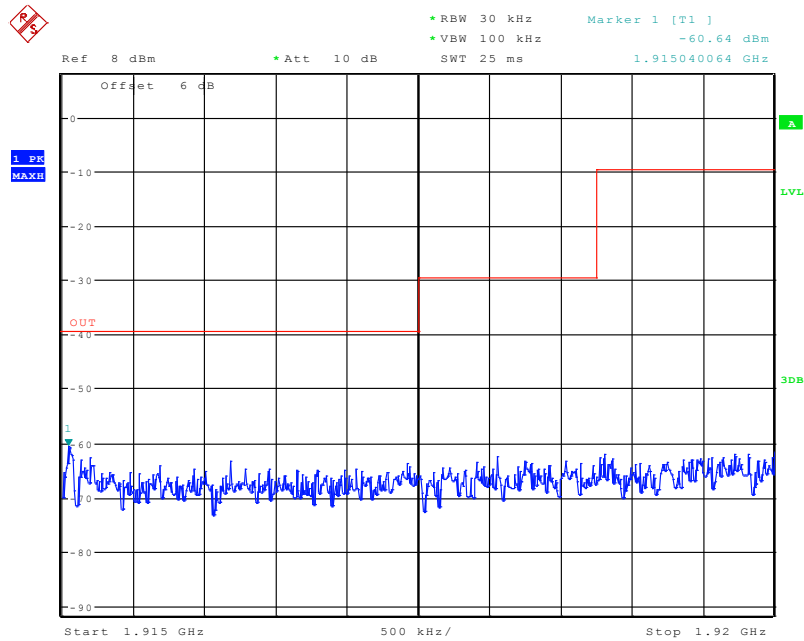

Date: 22.JUN.2019 16:59:03

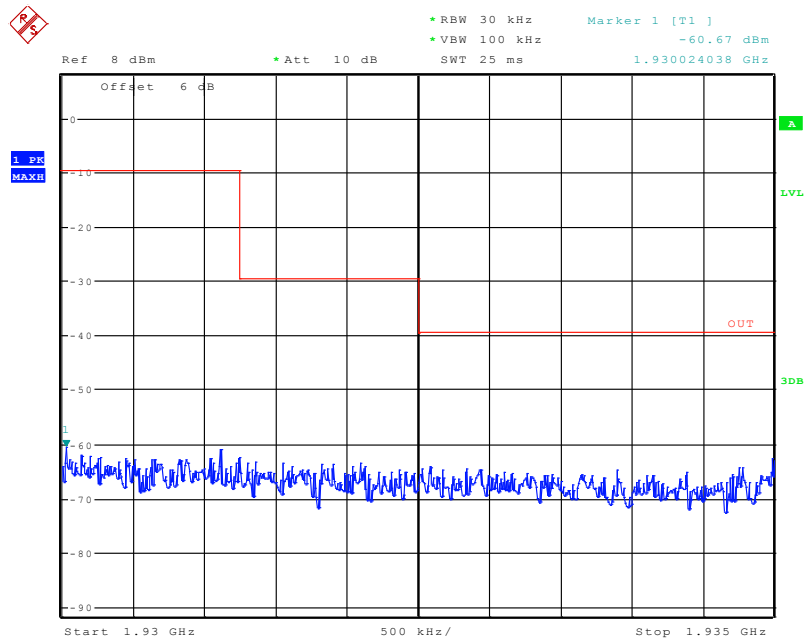

Date: 22.JUN.2019 16:59:52

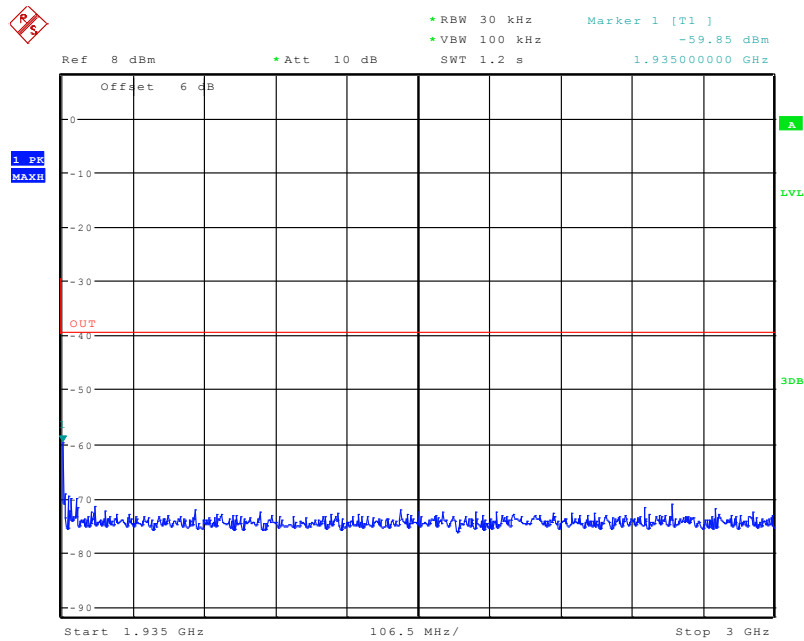

Date: 22.JUN.2019 17:00:20

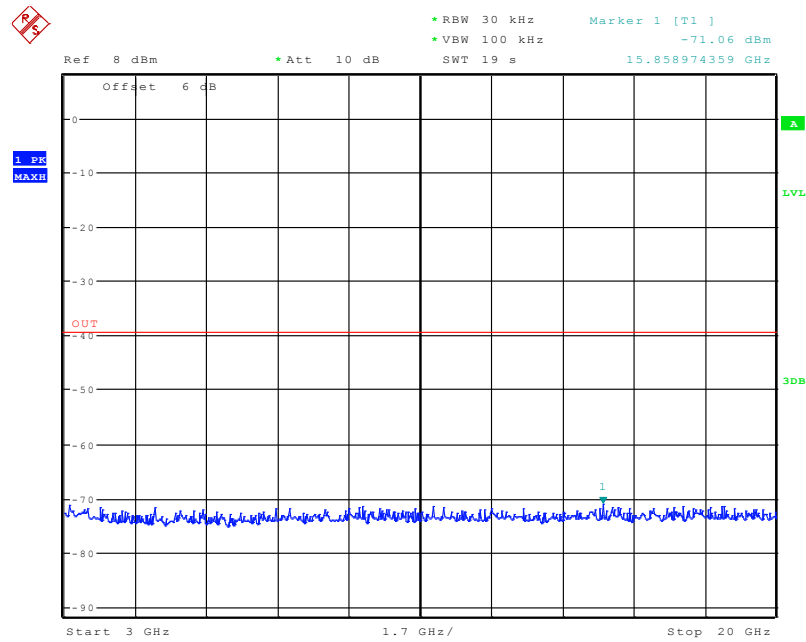

Date: 22.JUN.2019 17:01:06

High Channel (Unwanted Emission outside the Sub-band)

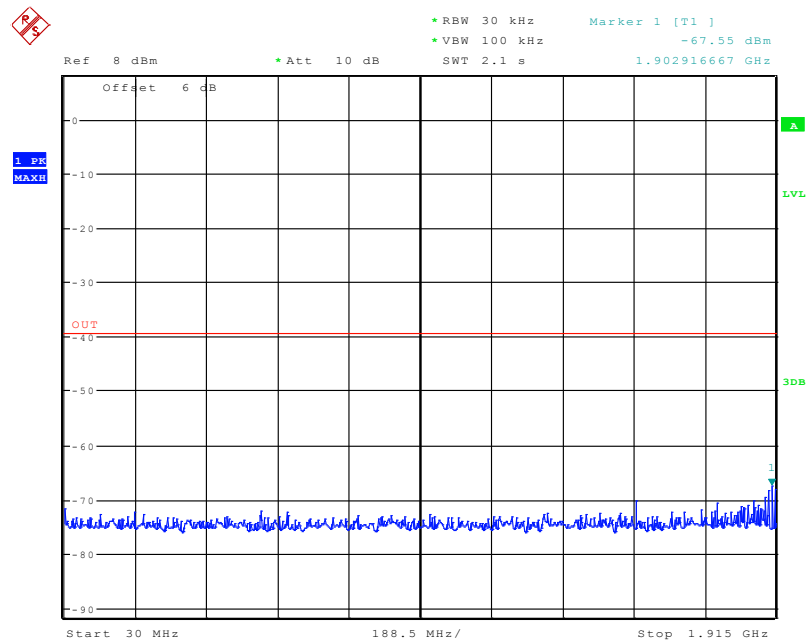

Date: 22.JUN.2019 17:06:22

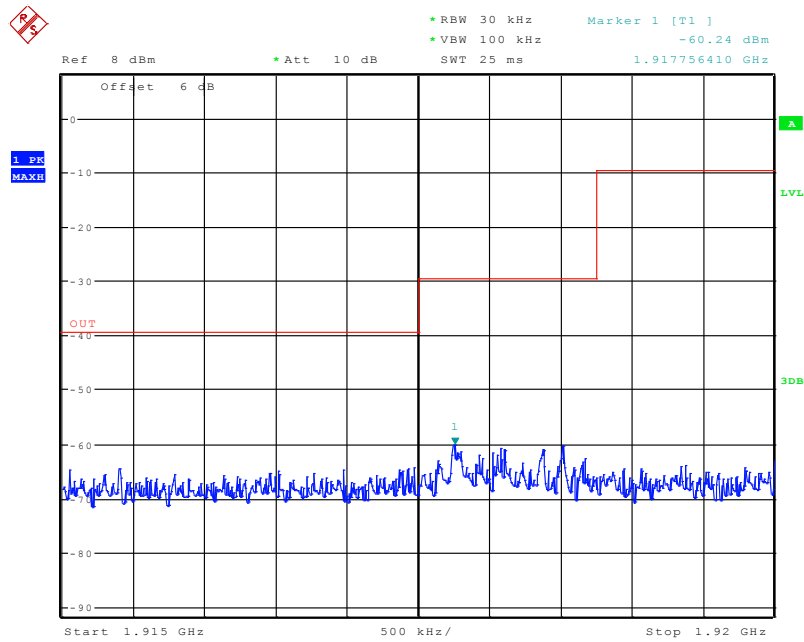

Date: 22.JUN.2019 17:06:44

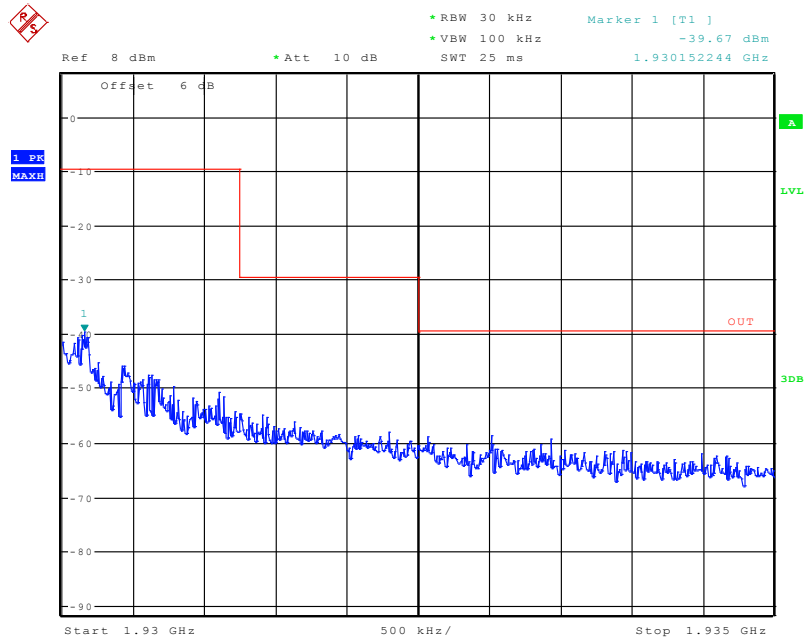

Date: 22.JUN.2019 17:04:36

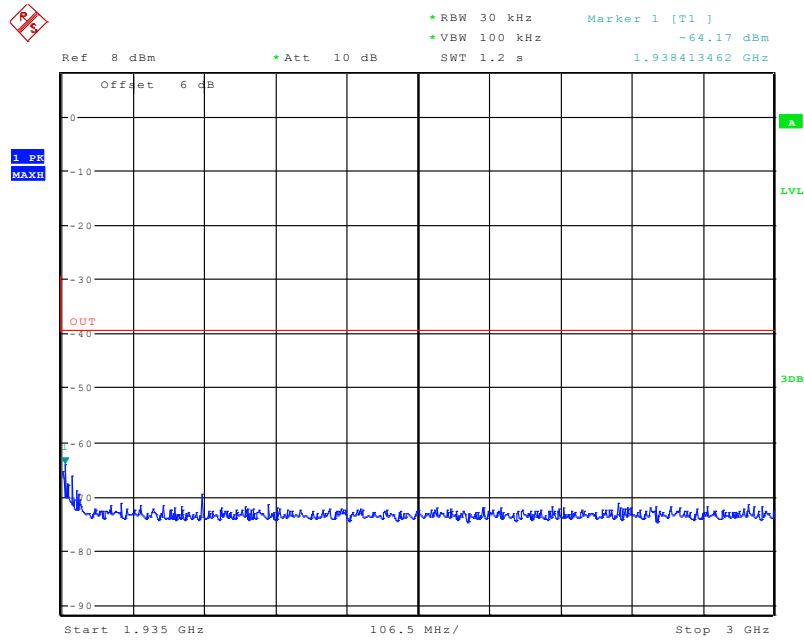

Date: 22.JUN.2019 17:05:15

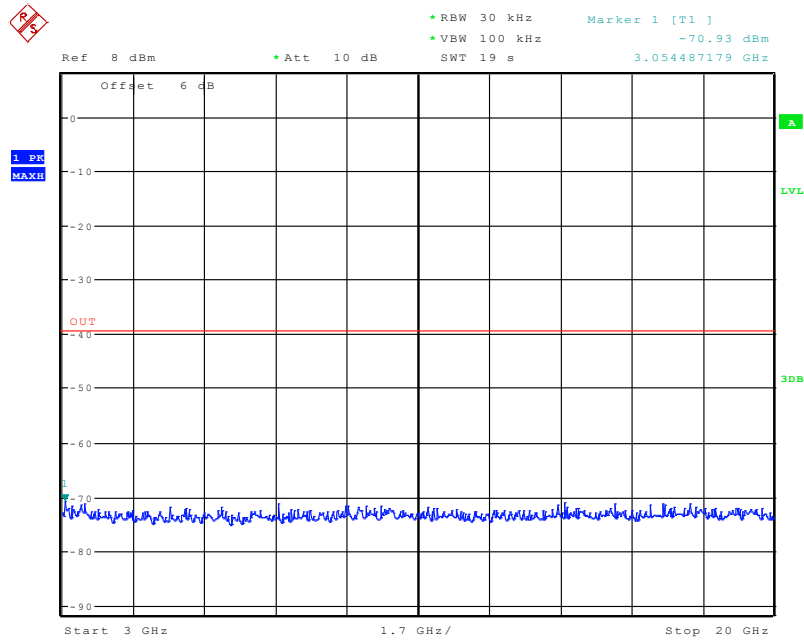

Date: 22.JUN.2019 17:02:01

FCC §15.323 (f) - FREQUENCY STABILITY

Applicable Standard

Per §15.323(f), the frequency stability of the carrier frequency of the intentional radiator shall be maintained within ± 10 ppm over 1 hour or the interval between channel access monitoring, whichever is shorter. The frequency stability shall be maintained over a temperature variation of -20°C to $+50^{\circ}\text{C}$ at normal supply voltage, and over a variation in the primary supply voltage of 85 percent to 115 percent of the rated supply voltage at a temperature of 20°C . For equipment that is capable only of operating from a battery, the frequency stability tests shall be performed using a new battery without any further requirement to vary supply voltage.

Test Procedure

This procedure should be carried out for each of the following test cases:

| Temperature | Supply Voltage |
|-----------------------|--------------------------|
| 20°C | 85-115% or new batteries |
| -20°C | Normal |
| $+50^{\circ}\text{C}$ | Normal |

During test, the equipment shall be placed in the boxes and set the temperature to the specified requirement until the thermal balance has been reached.

Using the mean carrier frequency at 20°C and at nominal supply voltage as the reference, the mean carrier frequency shall be maintained within ± 10 ppm at the two extreme temperatures (or as declared by the manufacturer) and at normal temperature (typically 20°C) at the two extreme supply voltages. This test does not apply to a EUT that is capable only of operating from a battery.

Test Data

Environmental Conditions

| | |
|---------------------------|-----------|
| Temperature: | 25 °C |
| Relative Humidity: | 52 % |
| ATM Pressure: | 101.0 kPa |

The testing was performed by Kieroy Luo on 2019-06-22.

Test Result: Compliance.

Test mode: Transmitting

| Temperature (°C) | Voltage (V _{AC}) | Channel Frequency (MHz) | Measured Frequency Offset (kHz) | Measured Frequency Offset (ppm) | Limit (ppm) |
|------------------|----------------------------|-------------------------|---------------------------------|---------------------------------|-------------|
| -20 | 120 | 1924.992 | 3.8 | 1.97 | ±10 |
| 20 | 102 | 1924.992 | 3.6 | 1.87 | ±10 |
| | 138 | 1924.992 | 4.5 | 2.34 | ±10 |
| 50 | 120 | 1924.992 | 3.7 | 1.92 | ±10 |

FCC §15.323 (c) (e) & §15.319(f) – SPECIFIC REQUIREMENTS FOR UPCS DEVICE

Applicable Standard

FCC §15.323(c)(e) & §15.319(f) Specific Requirements for UPCS device.
 ANSI C63.17 2013 §6.2 Frequency and time stability and §7. Monitoring tests and §8. Time and spectrum window access procedure.

Test Procedure

Measurement method according to ANSI C63.17 2013

Test configuration as below

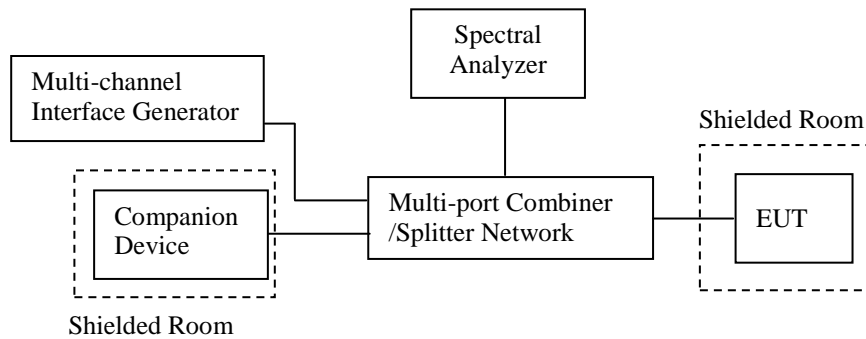

Test Data

Environmental Conditions

| | |
|---------------------------|-----------|
| Temperature: | 25 °C |
| Relative Humidity: | 52 % |
| ATM Pressure: | 101.0 kPa |

The testing was performed by Kieroy Luo on 2019-06-22.

Test Result: Compliance, please see the below data

1) Automatic Discontinuation of Transmission, FCC §15.319(f)

The device shall automatically discontinue transmission in case of either absence of information to transmit or operational failure. The provisions in this section are not intended to preclude transmission of control and signaling information or use of repetitive codes used by certain digital technologies to complete frame or burst intervals.

Test result:

Not applicable for PP.

2) Monitoring Time, FCC §15.323(c) (1)

Immediately prior to initiating transmission, devices must monitor the combined time and spectrum window in which they intend to transmit. For a period of at least 10 milliseconds for systems designed to use a 10 milliseconds or shorter frame period or at least 20 milliseconds for systems designed to use a 20 milliseconds frame period

Test procedure:

Measurement method is in according to ANSI C63.17 2013 clause 7.3.3.

RF signal generators apply uniform CW interference on all system carriers except two carriers (designated f_1 and f_2), each at level $T_L + U_M$. EUT can only transmit on these two carriers.

Test result:

This requirement is covered by the results of Least Interfered Channel (LIC).

| Interference (Refer to ANSI C63.17 clause 7.3.3) | Reaction of EUT | Results |
|--|------------------------|---------|
| a) Apply the interference on f_1 at level $T_L + U_M + 20\text{dB}$ and no interference on f_2 . Initiate transmission and verify the transmission only on f_2 . Then terminate it. | EUT transmits on f_2 | Pass |
| b) Apply the interference on f_2 at level $T_L + U_M + 20\text{dB}$ and immediately remove all interference from f_1 . The EUT should immediately attempt transmission on f_1 (but at least 20 ms after the interference on f_2 is applied), verify the transmission only on f_1 . | EUT transmission f_1 | Pass |

3) Lower Monitoring Threshold, FCC §15.323(c) (2)

The monitoring threshold must not be more than 30 dB above the thermal noise power for a bandwidth equivalent to the emission bandwidth used by the device.

Test procedure:

Measurement method according to ANSI C63.17 2013 clause 7.3.1

Test result:

Not applicable because the EUT has more 40 defined duplex system access channels and meet the provision of the Least Interfered Channel (LIC) based on FCC §15.323(c) (5).

4) Maximum Transmit Period, FCC §15.323(c) (3)

If no signal above the threshold level is detected, transmission may commence and continue with the same emission bandwidth in the monitored time and spectrum windows without further monitoring. However, occupation of the same combined time and spectrum windows by a device or group of cooperating devices continuously over a period of time longer than 8 hours is not permitted without repeating the access criteria.

Test procedure:

Measurement method according to ANSI C63.17 2013 clause 8.2.2

The test procedure is as follows:

- a) Activate the EUT and initiate a communication channel with the companion device, and start a timer or frame counter.
- b) The centre frequency of spectrum analyzer was set to the carrier frequency and SPAN was set to ZERO. The spectrum analyzer was used to monitor the time and spectrum window of the communication channel.
- c) Stop the timer at the end of the EUT transmission on the current time and frequency window (measure the time until the EUT changes to a different slot).

Test result:

| Repetition of Access Criteria | Measured Maximum Transmission Time (Second) | Limit (Second) | Results |
|-------------------------------|---|----------------|---------|
| First | 17388 | 28,800 | Pass |
| Second | 17468 | 28,800 | Pass |

5) System Acknowledgement, FCC §15.323(c) (4)

Once access to specific combined time and spectrum windows is obtained an acknowledgment from a system participant must be received by the initiating transmitter within one second or transmission must cease. Periodic acknowledgments must be received at least every 30 seconds or transmission must cease. Channels used exclusively for control and signaling information may transmit continuously for 30 seconds without receiving an acknowledgment, at which time the access criteria must be repeated.

Test procedure:

Measurement method according to ANSI C63.17 2013 clause 8.2.1

During testing initial transmission without acknowledgement, the signal from the EUT to the companion device is blocked by the circulator.

The test of the transmission time after loss of acknowledgements is performed by cutting off the signal from the companion device by a RF switch and measuring the time until the EUT stops transmitting.

Test result:

| Test | Time taken (second) | Limit (second) | Result |
|---|---------------------|----------------|--------|
| Initial Connection acknowledgement | 0.38 | 1 | Pass |
| Change of access criteria for control information | N/A | 30 | N/A |
| Transmission cease time after loss of acknowledgement | 3.88 | 30 | Pass |

Note: N/A=Not Applicable

6) Least Interfered Channel (LIC), FCC §15.323(c) (5)

If access to spectrum is not available as determined by the above, and a minimum of 20 duplex system access channels are defined for the system, the time and spectrum windows with the lowest power level may be accessed.

A device utilizing the provisions of this paragraph (5) must have monitored all access channels defined for its system within the last 10 seconds and must verify, within the 20 milliseconds (40 milliseconds for devices designed to use a 20 millisecond frame period) immediately preceding actual channel access, that the detected power of the selected time and spectrum windows is no higher than the previously detected value.

The power measurement resolution bandwidth for this comparison must be accurate to within 6 dB.

No device or group of cooperating devices located within 1 metre of each other shall during any frame period occupy more than 6 MHz of aggregate bandwidth, or alternatively, more than one third of the time and spectrum windows defined by the system.

Calculation of monitoring threshold limits for isochroous devices:

Lower threshold: $T_L = -174 + 10\log_{10}B + M_L + P_{MAX} - P_{EUT}$ (dBm)

Where: B=Emission bandwidth (Hz)

M_L = dB the threshold may exceed thermal noise (30 for T_L)

$P_{MAX} = 5\log_{10}B - 10$ (dBm)

P_{EUT} = Transmitted power (dBm)

Calculated thresholds:

| Monitor Threshold | B(MHz) | M_L (dB) | P_{MAX} (dBm) | P_{EUT} (dBm) | Threshold (dBm) |
|-------------------|--------|------------|-----------------|-----------------|-----------------|
| Lower threshold | 1.43 | 30 | 20.78 | 20.03 | -81.72 |

Note: 1. The upper threshold is applicable as the EUT utilizes more than 20 duplex system channels

Test procedure:

Measurement method according to ANSI C63.17 clause 7.3.2, 7.3.3

C63.17 clause 7.3.2, LIC procedure test:

- a) Allow EUT transmission on only two carrier frequencies, which will be designated f_1 and f_2 .
- b) Apply interference to the EUT on f_1 at a level of $TL + UM + 7$ dB and on f_2 at a level of $TL + UM$. Initiate transmission. The EUT should transmit on f_2 . Terminate the connection. Repeat five times. If the EUT transmits once on f_1 , the test failed.
- c) Apply interference to the EUT on f_1 at a level of $TL + UM$ and on f_2 at a level of $TL + UM + 7$ dB. Initiate transmission. The EUT should transmit on f_1 . Terminate the connection. Repeat five times. If the EUT transmits once on f_2 , the test failed.
- d) Apply interference to the EUT on f_1 at a level of $TL + UM + 1$ dB and on f_2 at a level of $TL + UM - 6$ dB. Initiate transmission. If the EUT transmits on f_2 , terminate the connection. Repeat five times. If the EUT transmits once on f_1 , the test failed.
- e) Apply interference to the EUT on f_1 at a level of $TL + UM - 6$ dB and on f_2 at a level of $TL + UM + 1$ dB. Initiate transmission. If the EUT transmits on f_1 , terminate the connection. Repeat five times. If the EUT transmits once on f_2 , the test failed.

C63.17 clause 7.3.3, Selected channel confirmation:

- a) Allow EUT transmission on only two carrier frequencies, which will be designated f_1 and f_2 . This limitation to carriers f_1 and f_2 is performed preferably by administration commands for the EUT, or alternatively by applying by a multicarrier interference generator uniform interference on all system carriers except f_1 and f_2 , at a level of $TL + UM + 20$ dB in-band per carrier. Set the interference level to the EUT on f_1 to a level of $TL + UM + 20$ dB, and let there be no interference applied on f_2 .
- b) Initiate transmission and verify that the EUT transmits on f_2 . If a connection was made, terminate it.
- c) Apply interference on f_2 at a level of $TL + UM + 20$ dB in-band, and immediately remove all interference from f_1 and immediately (but not sooner than 20 ms after the interference on f_2 is applied) cause the EUT to attempt transmission. The EUT should now transmit on f_1 , if it transmits.
- d) If the EUT transmits on f_2 , it fails.

Test result:**1) LIC procedure test:**

| Interference (Refer to ANSI C63.17 clause 7.3.3) | Reaction of EUT | Results |
|---|------------------------|---------|
| a) Apply the interference on f_1 at level T_L+U_M+7 dB and the interference on f_2 at level T_L+U_M . Initiate transmission and verify the transmission only on f_2 . Repeat 5 times. | EUT transmits on f_2 | Pass |
| b) Apply the interference on f_1 at level T_L+U_M and the interference on f_2 at level T_L+U_M+7 dB. Initiate transmission and verify the transmission only on f_1 . Repeat 5 times. | EUT transmits on f_1 | Pass |
| c) Apply the interference on f_1 at level T_L+U_M+1 dB the interference on f_2 at level T_L+U_M-6 dB. Initiate transmission and verify the transmission only on f_2 . Repeat 5 times. | EUT transmits on f_2 | Pass |
| d) Apply the interference on f_1 at level T_L+U_M-6 dB and the interference on f_2 at level T_L+U_M+1 dB. Initiate transmission and verify the transmission only on f_1 . Repeat 5 times. | EUT transmits on f_1 | Pass |

2) Selected channel confirmation:

| Interference (Refer to ANSI C63.17 clause 7.3.4) | Reaction of EUT | Results |
|--|------------------------|---------|
| a) Apply the interference on f_1 at level T_U+U_M and no interference on f_2 . Initiate transmission and verify the transmission only on f_2 . Then terminate it. | EUT transmits on f_2 | Pass |
| b) Apply the interference on f_2 at level T_L+U_M and immediately remove all interference from f_1 . The EUT should immediately attempt transmission on f_1 (but at least 20 ms after the interference on f_2 is applied), verify the transmission only on f_1 . | EUT transmission f_1 | Pass |

7) Random waiting, FCC §15.323(c) (6)

If the selected combined time and spectrum windows are unavailable, the device may either monitor and select different windows or seek to use the same window after waiting an amount of time, randomly chosen from a uniform random distribution between 10 and 150 milliseconds, commencing when the channel becomes available.

Test procedure:

This test is for EUTs that transmit control and signaling channels and that use the provisions of FCC §15.323(c)(6), thus to verify that the EUT (if in deferral) waits for a channel to go clear, then implements a 10 ms to 150 ms holdoff prior to using the channel. FCC §15.323(c)(6) is not restrictive for EUTs that use the LIC and offer 20 or more duplex communications channels, as a combined time and spectrum window cannot become unavailable as there is no threshold limit. Test method according to ANSI C63.17 2013 clause 8.1.3

- a) Restrict operation of the EUT to a single carrier designated f_1 . For TDMA system, further restrict EUT transmission to a single timeslot of the usable timeslots available in the TDMA frame structure and synchronize the interference so as to occur centered within the timeslot.
- b) Activate the EUT with no interference present. The EUT must transmit on f_1 . Then apply CW interference on f_1 . The interference level shall be at $TL + UM$ as appropriate for EUTs that do or do not meet the requirements for using the upper threshold. The EUT must stop transmitting within 30 s.
- c) Cancel the interference. Measure the time interval between the end of the interference transmission and the beginning of transmission by the EUT.
- d) Repeat step b) and step c) 100 times. If the measured time intervals vary uniformly between 10 ms and 150 ms, the EUT passes the test.

Note: This is Not Applicable

8) Monitoring Bandwidth and Reaction Time, FCC §15.323(c) (7)

The monitoring system bandwidth must be equal to or greater than the emission bandwidth of the intended transmission and have a maximum reaction time less than $50 \times \text{SQRT}(1.25/\text{emission bandwidth in MHz})$ microseconds for signals at the applicable threshold level but shall not be required to be less than 50 microseconds

Test procedure:

Measurement method according to ANSI C63.17 2013 clause 7.5

- a) Restrict the EUT to a single transmit carrier frequency f_1 , and verify that the EUT can establish a connection with no interference applied on f_1 .
- b) Apply time-synchronized, pulsed interference on f_1 at the pulsed level $TL + UM$, verify that the EUT does not establish a connection when the width of the interference pulse exceeds the largest of $50 \mu\text{s}$ and $50 \sqrt{1.25/B} \mu\text{s}$, where B is the emission bandwidth of the EUT in megahertz.
- c) With the channel interference level 6 dB above $TL + UM$, verify that the EUT does not establish a connection when the width of the interference pulse exceeds the largest of $35 \mu\text{s}$ and $35 \sqrt{1.25/B} \mu\text{s}$, where B is the emission bandwidth of the EUT in megahertz.

| Test Pulse width Equation (μs) | B(bandwidth) (MHz) | Pulse width (μs) | Limit (largest) (μs) |
|---|--------------------|-------------------------------|-----------------------------------|
| $50 (1.25/B)^{1/2}$ | 1.43 | 46.75 | 50 |
| $35 (1.25/B)^{1/2}$ | 1.43 | 32.72 | 35 |

Test result:**1) Monitoring Bandwidth:**

The antenna of the EUT used for monitoring is the same interior antenna that used for transmission, so the monitoring system bandwidth is equal to the emission bandwidth of the intended transmission

2) Reaction Time Test:

| No. | Interference Pulse width (μs) | Reaction of EUT | Observing time (μs) | Result |
|-----|--|-----------------|----------------------------------|--------|
| 1 | $50 \mu\text{s}$ with level $T_L + U_M$ | No transmission | 25.82 | Pass |
| 2 | $35 \mu\text{s}$ with level $T_L + U_M + 6\text{dB}$ | No transmission | 18.82 | Pass |

9) Monitoring Antenna, FCC §15.323(c) (8)

The monitoring system shall use the same antenna used for transmission, or an antenna that yields equivalent reception at that location.

Test procedure:

Measurement method according to ANSI C63.17 2013 paragraph 4

Test result:

The antenna of the EUT used for transmission is the same interior antenna that used for monitoring.

10) Monitoring threshold relaxation, FCC §15.323(c) (9)

Devices that have a power output lower than the maximum permitted under the rules can increase their monitoring detection threshold by one decibel for each one decibel that the transmitter power is below the maximum permitted.

Test procedure:

Measurement method according to ANSI C63.17 2013 paragraph 4

Test result:

This requirement is covered by the results of Least Interfered Channel (LIC) based on FCC §15.323(c)(5).

11) Duplex Connections, FCC §15.323(c) (10)

An initiating device may attempt to establish a duplex connection by monitors both its intended transmit and receive time and spectrum windows. If both the intended transmit and receive time and spectrum windows meet the access criteria, then the initiating device can initiate a transmission in the intended transmit time and spectrum window. If the power detected by the responding device can be decoded as a duplex connection signal from the initiating device, then the responding device may immediately begin transmitting on the receive time and spectrum window monitored by the initiating device.

Test procedure:

This test validates proper operation of an EUT that operates according to the provisions of FCC §15.323(c)(10) using a check of both transmit and receive channels on one end of the link to qualify both ends of the link for transmissions. Test method according to ANSI C63.17 clause 8.3.2 Validation of dual access criteria check for EUTs that implement the upper threshold

- a) Adjust the path loss between the EUT and its companion device such that the received signal to the EUT from the companion device is at least 40 dB above $TL + UM$.
- b) Restrict the EUT and its companion device to operation at a single carrier f_1 for TDMA systems and on f_1 and f_2 and corresponding duplex carriers for FDMA systems. Verify that the EUT and its companion device can establish a connection on a time/spectrum window on the enabled carrier(s). Terminate the connection.
- c) Apply interference to the EUT on the EUT's *transmit* time/spectrum windows at $TL + UM$ per carrier on all time/spectrum windows except for one, which has interference at least 10 dB below TL . Adjust the interference to the EUT on its *receive* time/spectrum windows such that a single time/spectrum window has interference at least 10 dB below TL , and the interference on the other time/spectrum windows is at $TL + UM + 7$ dB. The interference to the companion device should be at least 10 dB below TL on all active time/spectrum windows. The interference-free *receive* time/spectrum window must not be the duplex mate of the interference-free *transmit* time/spectrum window.
- d) Cause the EUT to attempt to establish a connection. The connection should be made on the interference-free *receive* time/spectrum window and its duplex mate. Otherwise, the EUT fails the test.
- e) If a connection exists, terminate it. Reduce the interference on the EUT's *receive* time/spectrum windows to a level of $TL + UM$ per carrier on all time/spectrum windows except for one, which has interference at least 10 dB below TL . Raise the interference on the EUT's *transmit* time/spectrum windows to a level of $TL + UM + 7$ dB, maintaining one time/spectrum window with interference at least 10 dB below TL . The interference to the companion device should be at least 10 dB below TL on

all active time/spectrum windows. Again, the interference-free *transmit* and *receive* time/spectrum windows should not constitute a duplex pair if the system designates a specific duplex pairing for time/spectrum windows.

- f) Cause the EUT to attempt to establish a connection. The connection should be made on the interference-free *transmit* time/spectrum window and its duplex mate. Otherwise, the system fails the test.

Test result:

| Interference (Refer to ANSI C63.17 §8.3.2) | Reaction of EUT | Results |
|--|--|---------|
| a) Only a single carrier f_1 for EUT TDMA systems and on f_1 and f_2 and corresponding duplex carriers for FDMA systems. | EUT can transmit | Pass |
| b) All Tx windows with level TL+UM except one & Rx windows with level TL+UM+7dB except one, which are not the duplex mate. | Connected on the target Rx window and its duplex mate. | Pass |
| c) All Tx windows with level TL+UM+7dB except one & Rx windows with level TL+UM except one, which are not duplex mate. | Connected on the target Tx window and its duplex mate. | Pass |
| d) All Tx & Rx windows with level TU+UM, except one for Tx window & one for Rx window, which are not duplex mate. | No connection possible | Pass |

12) Alternative monitoring interval, FCC §15.323(c) (11)

An initiating device that is prevented from monitoring during its intended transmit window due to monitoring system blocking from the transmissions of a co-located (within one meter) transmitter of the same system, may monitor the portions of the time and spectrum windows in which they intend to receive over a period of at least 10 milliseconds. The monitored time and spectrum window must total at least 50 percent of the 10 millisecond frame interval and the monitored spectrum must be within 1.25 MHz of the center frequency of channel(s) already occupied by that device or co-located co-operating devices. If the access criteria is met for the intended receive time and spectrum window under the above conditions, then transmission in the intended transmit window by the initiating device may commence.

Test procedure:

This test validates the ability of the EUT to distinguish between same-system and other-system interference for purposes of satisfying the requirement of 47CFR15.323(c) (11). Test method according to ANSI C63.17 2013 clause 8.4

- Adjust the path loss between the EUT and its companion device such that the received signal to the EUT from the companion device is at least 30 dB above TL .
- Restrict the EUT and its companion device to operation at a single carrier f_1 for TDMA systems and on f_1 and f_2 and corresponding duplex carriers for FDMA systems. Verify that the EUT and its companion device can establish a connection.
- Apply interference at $TL + UM$ per carrier to the EUT on all *transmit* time/spectrum windows on the enabled carrier(s). The interference must use the same physical layer parameters (modulation, frame format, etc.) as the EUT transmissions, but with a system identifier different from that used by the EUT and the companion device. Ensure that the interference level at the companion device is at least 10 dB below TL . Apply no interference to the *receive* time/spectrum windows on the enabled carriers.
- Cause the EUT to attempt to establish a connection. If a connection is established, the test fails.

Test result:

| Interference (Refer to ANSI C63.17 §8.4) | Reaction of EUT | Results |
|---|------------------------------|---------|
| a) Only a single carrier f_1 for EUT TDMA systems and on f_1 and f_2 and corresponding duplex carriers for FDMA systems. | EUT can transmit | Pass |
| b) Apply interference with same parameters as EUT transmissions on all Tx windows with level TL+UM on the enabled carrier(s) and no interference on the Rx windows on the enabled carriers. | No connection is established | Pass |

13) Fair Access, FCC §15.323(c) (12)

The provisions of FCC §15.323 (c) (10) or (11) shall not be used to extend the range of spectrum occupied over space or time for the purpose of denying fair access to spectrum to other devices.

Test result:

The manufacturer declares that this device does not use any mechanisms as provided by FCC §15.323(c)(10) or (11) to extend the range of spectrum occupied over space or time for the purpose of denying fair access to spectrum to other device.

14) Frame Repetition Stability Frame Period and Jitter, FCC §15.323 (e)

The frame period (a set of consecutive time slots in which the position of each time slot can be identified by reference to a synchronizing source) of an intentional radiator operating in these sub-bands shall be 20 milliseconds or 10 milliseconds/X where X is a positive whole number. Each device that implements time division for the purposes of maintaining a duplex connection on a given frequency carrier shall maintain a frame repetition rate with a frequency stability of at least 50 parts per million (ppm). Each device which further divides access in time in order to support multiple communication links on a given frequency carrier shall maintain a frame repetition rate with a frequency stability of at least 10 ppm. The jitter (time-related, abrupt, spurious variations in the duration of the frame interval) introduced at the two ends of such a communication link shall not exceed 25 microseconds for any two consecutive transmissions. Transmissions shall be continuous in every time and spectrum window during the frame period defined for the device.

Test procedure:

Measurement method according to ANSI C63.17 2013 clause 6.2.2, 6.2.3

Test result:

Frame Period and Jitter:

| Max. pos. Jitter (µs) | Max. neg. Jitter (µs) | Frame period (ms) | Limit | |
|-----------------------|-----------------------|-------------------|-------------------|-------------|
| | | | Frame Period (ms) | Jitter (µs) |
| 0.08 | -0.08 | 10.12 | 20 or 10/X | 0.12 |

Note: X is a positive whole number.

******* END OF REPORT *******