



**Test report no. : 189931-4**

**Item tested : RTX4024**

**Type of equipment : UPCS Wireless Relay Station**

**FCC ID : T7HR4024**

**Client : RTX Products Hong Kong Ltd.**

**FCC Part 15, subpart D**

Isosynchronous UPCS Device  
1920 - 1930 MHz

**Industry Canada RSS-213, Issue 2**

2 GHz Licence-exempt Personal  
Communications Service Devices  
(LE-PCS)

**30 March 2012**

**Authorized by :** .....

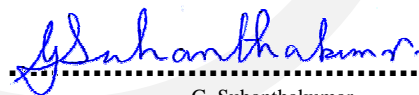
A blue ink signature of G. Suhanthakumar, written in a cursive style, positioned above a dotted line.

G. Suhanthakumar  
Technical Vericator

**CONTENTS**

**1 GENERAL INFORMATION ..... 3**

1.1 Testhouse Info ..... 3

1.2 Client Information ..... 3

1.3 Responsible Manufacturer (if other than client) ..... 3

**2 TEST INFORMATION ..... 4**

2.1 Tested Item ..... 4

2.2 Description of Tested Device ..... 4

2.3 Exposure Evaluation ..... 4

2.4 Test Environment ..... 5

2.5 Test Period ..... 5

2.6 Test Engineer(s) ..... 5

2.7 Test Equipment ..... 5

2.8 Other Comments ..... 5

**3 TEST REPORT SUMMARY ..... 6**

3.1 General ..... 6

3.2 Test Summary ..... 7

**4 TEST RESULTS ..... 8**

4.1 Power Line Conducted Emissions ..... 8

4.2 Coordination with fixed microwave ..... 10

4.3 Digital Modulation Techniques ..... 10

4.4 Labeling Requirements ..... 10

4.5 Antenna Requirement ..... 11

4.6 Channel Frequencies ..... 11

4.7 Automatic Discontinuation of Transmission ..... 12

4.8 Peak Power Output ..... 13

4.9 Emission Bandwidth *B* ..... 18

4.10 Power Spectral Density ..... 21

4.11 In-Band Unwanted Emissions, Conducted ..... 24

4.12 Out-of-band Emissions, Conducted ..... 26

4.13 Carrier Frequency Stability ..... 30

4.14 Frame Repetition Stability ..... 31

4.15 Frame Period and Jitter ..... 31

4.16 Monitoring Threshold, Least Interfered Channel ..... 33

4.17 Threshold Monitoring Bandwidth ..... 35

4.18 Reaction Time and Monitoring Interval ..... 36

4.19 Time and Spectrum Window Access Procedure ..... 39

4.20 Acknowledgements and Transmission Duration ..... 42

4.21 Dual Access Criteria Check ..... 44

4.22 Alternative Monitoring Interval ..... 49

**5 TEST SETUPS ..... 50**

5.1 Frequency Measurements ..... 50

5.2 Timing Measurements ..... 50

5.3 Conducted Emission Test ..... 50

5.4 Power Line Conducted Emissions Test ..... 51

5.5 Monitoring Tests ..... 51

5.6 Radiated Emissions Test, Fully Anechoic Chamber ..... 52

**6 TEST EQUIPMENT USED ..... 53**

## 1 GENERAL INFORMATION

### 1.1 Testhouse Info

Name : Nemko AS  
Address : Nemko Kjeller  
Instituttveien 6  
N-2007 Kjeller, NORWAY  
Telephone : +47 64 84 57 00  
Fax : +47 64 84 57 05  
E-mail: comlab@nemko.com  
FCC test firm registration # : 994405  
IC OATS registration # : 2040D-1  
Total Number of Pages: 53

### 1.2 Client Information

Name : RTX Products Hong Kong Ltd.  
Address : 11/F, CAC Tower, 165 Hoi Bun Road, Kwun Tong, Kowloon, Hong Kong, P.R. China

**Contact:**

Name : Ted Chong  
Telephone : +852 248 73718  
E-mail : TED@rtx.hk

### 1.3 Responsible Manufacturer (if other than client)

Same as client.

## 2 Test Information

### 2.1 Tested Item

Name :	RTX
Model name :	RTX4024; RTX4024a
FCC ID :	T7HR4024
Industry Canada ID :	4979B-R4024
Serial number :	/
Hardware identity and/or version:	V3
Software identity and/or version :	111115-TA
Tested to IC Radio Standard (RSS) :	RSS-213 Issue 2, RSS-GEN Issue 3
Test Site IC Reg. Number :	IC 2040D-1
Frequency Range :	1921.536 – 1928.448 MHz
Number of Channels :	5 RF Channels, 5x12 = 60 TDMA Duplex Channels
Type of Modulation :	Digital (Gaussian Frequency Shift Keying)
Peak Output Power :	98 mW (Conducted)
Antenna Connector :	RTX4024: None RTX4024a: SMB
Number of Antennas :	2 Internal Antennas, and SMB Connector on RTX4024A
Antenna Diversity Supported :	Yes
Desktop Charger :	N/A
Power Supply :	AC Adaptor Model: S008CM0550060

### 2.2 Description of Tested Device

The EUT is a DECT Wireless Relay Station (WRS) and is a responding device as described in ANSI C63.17 and it is designed to operate together with a DECT portable parts (i.e. a handset), which is the initiating device.

The WRS works by retransmitting the data from the handset to the base in the next DECT frame, and vice versa with the response from the base to the handset. The WRS has its own unique ID and will only work with base stations it has previously been registered to.

The WRS will not transmit at all if it does not see the Base it has been registered to.

The WRS decodes the signal it receives and retransmits only the data, the RF signal transmitted from the WRS is on a different timeslot and is completely independent of the input signal received by the WRS, except that it is on the same RF Carrier and contains the same data.

### 2.3 Exposure Evaluation

The EUT is designed to be fixed to a wall etc. and the user manual contains text that it shall be mounted with a separation distance of at least 20cm from any persons. For the purposes of exposure evaluation this EUT is a fixed device. MPE Calculation at 20cm satisfying FCC requirements is submitted as a separate document.

The EUT is exempted from RF Exposure Evaluation to Industry Canada requirements since the output power complies with the power levels of section 2.5.2 of RSS-102 Issue 4.

## 2.4 Test Environment

Temperature:	20.9 – 21.8 °C
Relative humidity:	33 – 43 %
Normal test voltage:	120 V AC

The values are the limit registered during the test period.

## 2.5 Test Period

Item received date:	2011-11-17
Test period :	from 2011-11-24 to 2012-02-10

## 2.6 Test Engineer(s)

Frode Sveinsen

## 2.7 Test Equipment

See list of test equipment in clause 6.

## 2.8 Other Comments

The Monitoring and Time and Spectrum Window Access tests were performed with Test Set-Up 6 (Ref. clause 5). A clock signal from the companion device was used to synchronize the Pulse Pattern Generator and the Spectrum Analyzer to the start of the DECT time window. The EUT was limited by administrative commands to operate on only two frequency carriers. For the tests where the EUT was required to operate on only one frequency carrier, one carrier was blocked by applying a CW interfering signal from RF Generator 3. The Pulse Pattern Generator was used to apply time synchronized interference to time windows where this was required.

Since the EUT was programmed to operate on only two RF carriers, it was only necessary with two RF generators for the monitoring tests, however a third generator was applied for the tests that required specific time slots to be blocked.

The tested EUT supports both normal DECT slot length and the DECT Long slot, long slot is a DECT slot that is longer than the normal DECT slot (also called Full Slot) and is used for speech connections where a higher bit-rate than 32kbps is needed. When long slot is used the number of available system access channels are 30 or less, this means that the requirement for using the Least Interfered Channel Procedure 15.323(c)(5) is no longer fulfilled and that the EUT must use the Lower Threshold.

This EUT supports Least Interfered Channel procedure (LIC) when full slot is used, the Monitoring and Time and Spectrum Window Access tests were conducted as specified for EUTs that support LIC procedure.

All tests except Antenna Gain and Power-Line Conducted Emissions were performed in conducted mode with a temporary antenna connector.

The companion devices for the monitoring tests were Base station RTX8660 (FCC ID: T7HX8660, IC: 4979B-X8660) and Handset RTX8630 (FCC ID: T7HRTX8630, IC: 4979B-RTX8630).

### 3 TEST REPORT SUMMARY

#### 3.1 General

Manufacturer: RTX Products Hong Kong Ltd.  
Model No.: RTX4024

All measurements are traceable to national standards.

The tests were conducted on a sample of the equipment for the purpose of demonstrating compliance with FCC CFR47 Part 15D for Isochronous UPCS Devices and Industry Canada RSS-213 Issue 2 / RSS-GEN Issue 3.

All tests were conducted in accordance with ANSI C63.4-2009 and ANSI C63.17-2006. Antenna Gain tests were made in a 3m fully-anechoic chamber.

A description of the test facility is on file with the FCC and Industry Canada.

- |   |   |
|---|---|
| <input checked="" type="checkbox"/> New Submission  | <input checked="" type="checkbox"/> Production Unit |
| <input type="checkbox"/> Class II Permissive Change | <input type="checkbox"/> Pre-production Unit        |
| <b>PUB</b> Equipment Code                           | <input type="checkbox"/> Family Listing             |

**THIS TEST REPORT APPLIES ONLY TO THE ITEM(S) AND CONFIGURATIONS TESTED.**

**Deviations from, additions to, or exclusions from the test specifications are described in "Summary of Test Data".**



**TEST REPORT NO: 189931-4**

TESTED BY : Frode Sveinsen  
Frode Sveinsen, Chief Engineer

DATE: 10 February 2012

Nemko Group authorizes the above named company to reproduce this report provided it is reproduced in its entirety and for use by the company's employees only. Any reproduction of parts of this report requires approval in writing from Nemko Group.

Any use which a third party makes of this report, or any reliance on or decisions to be made based on it, are the responsibility of such third parties. Nemko Group accepts no responsibility for damages suffered by any third party as a result of decisions made or actions based on this report.

### 3.2 Test Summary

Name of test	FCC CFR 47 Paragraph #	IC RSS-213 Paragraph #	Verdict
Coordination with fixed microwave	15.307(b)	N/A	Complies
Digital Modulation Techniques	15.319(b)	6.1	Complies
Labeling requirements	15.19(a)(3)	3 RSS-GEN 5.2	Complies
Antenna Requirement	15.317, 15.203	RSS-GEN 7.1.2	Complies
Power Line Conducted Emission	15.107(a) 15.207(a)	6.3 RSS-GEN 7.2.2	Complies
Emission Bandwidth	15.323(a)	6.4	Complies
In-band emissions	15.323(d)	6.7.2	Complies
Out-of-band emissions	15.323(d)	6.7.1	Complies
Output Power and Antenna Gain	15.319(c)(e), 15.31(e)	6.5 and 4.1(e)	Complies
Power Spectral Density	15.319(d)	4.3.2.1	Complies
Automatic discontinuation of transmission	15.319(f)	4.3.4(a)	Complies
Carrier frequency stability	15.323(f)	6.2	Complies
Frame repetition stability	15.323(e)	4.3.4(c)	Complies
Frame period and jitter	15.323(e)	4.3.4(c)	Complies
Monitoring threshold, Least interfered channel	15.323(c)(2);(5); (9)	4.3.4(b)	Complies
Monitoring of intended transmit window and maximum reaction time	15.323(c)(1)	4.3.4(b)	Complies
Threshold monitoring bandwidth	15.323(c)(7)	4.3.4(b)	Complies
Reaction time and monitoring interval	15.323(c)(1);(5); (7)	4.3.4(b)	Complies
Access criteria test interval	15.323(c)(4);(6)	4.3.4(b)	Complies
Access Criteria functional test	15.323(c)(4);(6)	4.3.4(b)	Complies
Acknowledgements	15.323(c)(4)	4.3.4(b)	Complies
Transmission duration	15.323(c)(3)	4.3.4(b)	Complies
Dual access criteria	15.323(c)(10)	4.3.4(b)	Complies
Alterative monitoring interval	15.323(c)(10);(11)	4.3.4(b)	N/A <sup>1</sup>
Spurious Emissions (Radiated)	15.319(g) 15.109(a) 15.209(a)	4.3.3 RSS-GEN 7.2.3	N/A <sup>2</sup>

<sup>1</sup> The client declares that the tested equipment does not implement this provision

<sup>2</sup> Not required if the Conducted Out-of-Band Emissions test is Passed

## 4 TEST RESULTS

### 4.1 Power Line Conducted Emissions

Para. No.: 15.207 (a)

Test Performed By: G. Suhantakumar	Date of Test: 25 Nov 2011
------------------------------------	---------------------------

Measurement procedure: ANSI C63.4-2009 using 50  $\mu$ H/50 ohms LISN.

Test Results: Complies

Measurement Data: See attached graph, (Peak detector).

Highest measured value (L1 and N):

Frequency [MHz]	Level [dBuV]	Limit [dBuV]	Margin [dB]	Det	Position	Verdict [Pass/Fail]
0.150000	25.20	56.00	30.80	AV	L1	Pass
0.195000	23.50	53.80	30.30	AV	N	Pass
0.415000	28.00	47.50	19.50	AV	L1	Pass
0.440000	21.70	47.10	25.40	AV	N	Pass
0.775000	16.10	46.00	29.90	AV	N	Pass
1.645000	13.80	46.00	32.20	AV	L1	Pass
3.265000	13.20	46.00	32.80	AV	L1	Pass



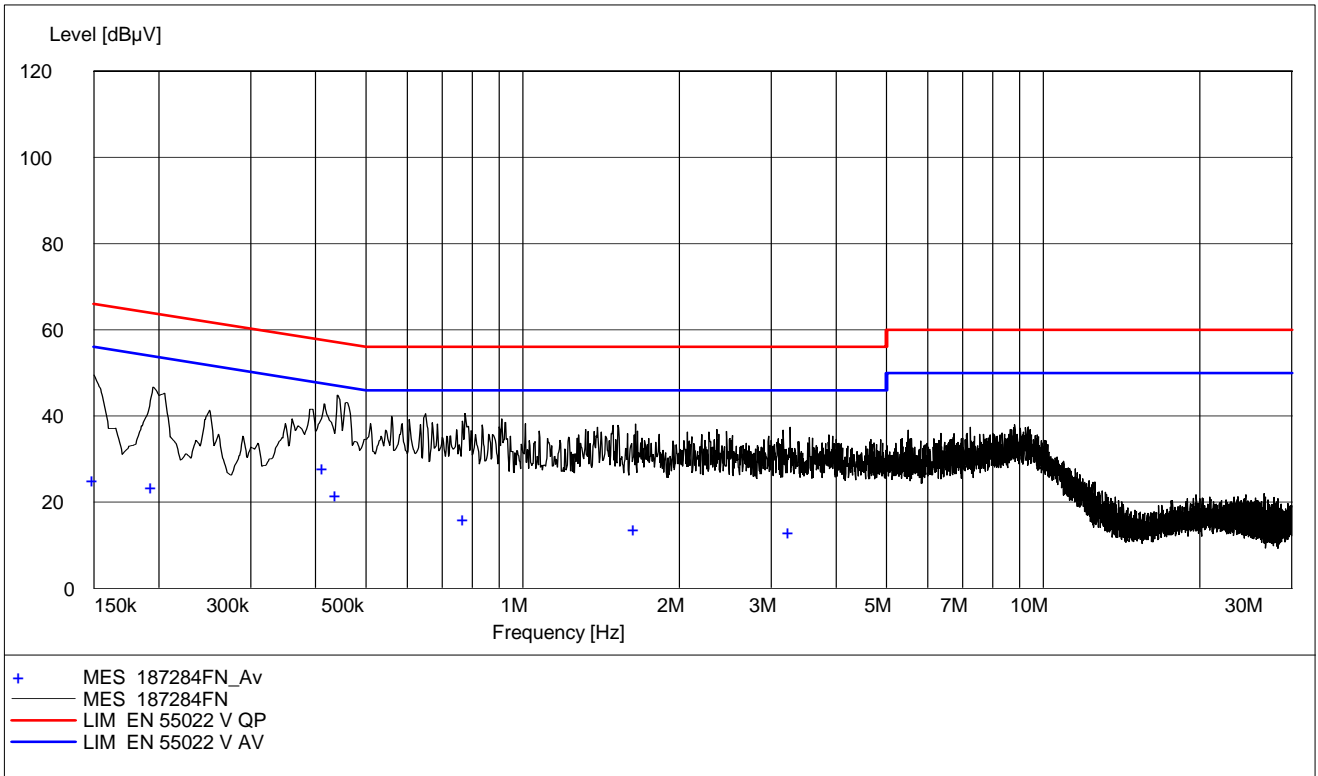

**Phase L1 and N, 120V AC, Peak Detector**

## 4.2 Coordination with fixed microwave

The affidavit from UTAM, Inc. is included in the documentation supplied by the applicant:

Yes

No

### Requirement, FCC 15.307 (b):

Each application for certification of equipment operating under the provisions of this Subpart must be accompanied by an affidavit from UTAM, Inc. certifying that the applicant is a participating member of UTAM, Inc. In the event a grantee fails to fulfill the obligations attendant to participation in UTAM, Inc., the Commission may invoke administrative sanctions as necessary to preclude continued marketing and installation of devices covered by the grant of certification, including but not limited to revoking certification.

## 4.3 Digital Modulation Techniques

The EUT uses Multi Carrier / Time Division Multiple Access / Time Division Duplex and Digital GFSK modulation. For further details see the operational description provided by the applicant.

### Requirement, FCC 15.319(b):

All transmissions must use only digital modulation techniques.

## 4.4 Labeling Requirements

See separate documents showing the label design and the placement of the label on the EUT.

### Requirements FCC 15.19

The FCC Identifier shall be displayed on the label, and the device(s) shall bear the following statement in a conspicuous location on the device or in the user manual if the device is too small:

*This device complies with Part 15 of the FCC Rules. Operation is subject to the following two conditions: (1) this device may not cause harmful interference, and (2) this device must accept any interference received, including interference that may cause undesired operation.*

The label itself shall be of a permanent type, not a paper label, and shall last the lifetime of the equipment.

#### 4.5 Antenna Requirement

Does the EUT have detachable antenna(s)?  Yes  No<sup>1</sup>

If detachable, is the antenna connector(s) non-standard?  Yes  No

The model RTX4024a have a SMB antenna connector in addition to the two integral antennas, the model RTX4024 have only internal antennas.

The conducted tests were performed on a sample with a temporary antenna connector.

**Requirement: FCC 15.203, 15.204, 15.317.**

#### 4.6 Channel Frequencies

UPCS CHANNEL	FREQUENCY (MHz)
Upper Band Edge	1930.000
0 (Highest)	1928.448
1	1926.720
2	1924.992
3	1923.264
4 (Lowest)	1921.536
Lower Band Edge	1920.000

**Requirement: FCC 15.303 (d), (g)**

Within 1920 -1930 MHz band for isochronous devices.

#### 4.7 Automatic Discontinuation of Transmission

Does the EUT transmit Control and Signaling Information?	<input checked="" type="checkbox"/> YES	<input type="checkbox"/> NO
TYPE OF EUT :	<input checked="" type="checkbox"/> INITIATING DEVICE	<input checked="" type="checkbox"/> RESPONDING DEVICE

The following tests simulate the reaction of the EUT in case of either absence of information to transmit or operational failure after a connection with the companion device is established.

Number	Test	EUT Reaction	Verdict
1	Power removed from EUT	C	Pass
2	Switch Off EUT	N/A	Pass
3	Hook-On by EUT	N/A	Pass
4	Power removed from Companion device (Handset)	C	Pass
5	Switch Off Companion Device (Handset)	C	Pass
6	Hook-On by Companion Device (Handset)	C	Pass
7	Power removed from Companion device (Base)	A	Pass
8	Switch Off Companion Device (Base)	N/A	Pass
9	Hook-On by Companion Device (Base)	N/A	Pass

- A - Connection breakdown, Cease of all transmissions
- B - Connection breakdown, EUT transmits control and signaling information
- C - Connection breakdown, Companion Device transmits control and signaling information
- N/A - Not Applicable (EUT and Base does not have On/Off switch and cannot perform Hook-On)

#### Requirements, FCC 15.319(f)

The device shall automatically discontinue transmission in case of either absence of information to transmit or operational failure. These provisions are not intended to preclude transmission of control and signaling information or use of repetitive codes used by certain digital technologies to complete frame or burst intervals.

## 4.8 Peak Power Output

### Test Method:

ANSI C63.17, clause 6.1.2.

### Test Results: Complies

### Measurement Data:

#### Maximum Conducted Output Power

Channel No.	Frequency (MHz)	Maximum Conducted Output Power (dBm)	Maximum Radiated Output Power (dBm)	Maximum Antenna Gain (dBi)
4	1921.536	19.9	20.4	+0.5
2	1924.992	19.8	20.3	+0.5
0	1928.448	19.8	20.3	+0.5

### Substitution:

Frequency MHz	Measured value dBm	Subst. Gen. (incl. corr.) dBm	Attenuator and Cable dB	Gain Subst. Antenna dB	Result dBm
1921.536	19.4	26.1	-13.9	8.3	20.4
1924.992	19.3	26.0	-13.9	8.3	20.3
1928.448	19.3	26.0	-13.9	8.3	20.3

**Result = Subst.Gen. + Attenuator + Cable + Antenna Gain**

Antenna Gain values above are valid for the integral antennas, for the external antenna on RTX4024A see datasheet.

For this test it was also checked that input voltage variation of 85 and 115% of nominal value did not have any effect on the measured output power, neither radiated nor conducted.

### Limit:

Conducted:  $100 \mu\text{W} \times \text{SQRT}(B)$  where  $B$  is the measured Emission Bandwidth in Hz

FCC 15.319(c)(e): 21.55 dBm (142 mW)

RSS-213, Issue 2: 20.45 dBm (111 mW)

The antenna gain is below 3 dBi, no reduction in transmit power is necessary.

### Requirements, FCC 15.319(c)(e), RSS-213, Issue 2

Peak transmit power shall not exceed 100 microwatts multiplied by the square root of the emission bandwidth in Hertz.

The peak transmit power shall be reduced by the amount in decibels that the maximum directional gain of the antenna exceeds 3 dBi.

### Conducted Peak Output Power

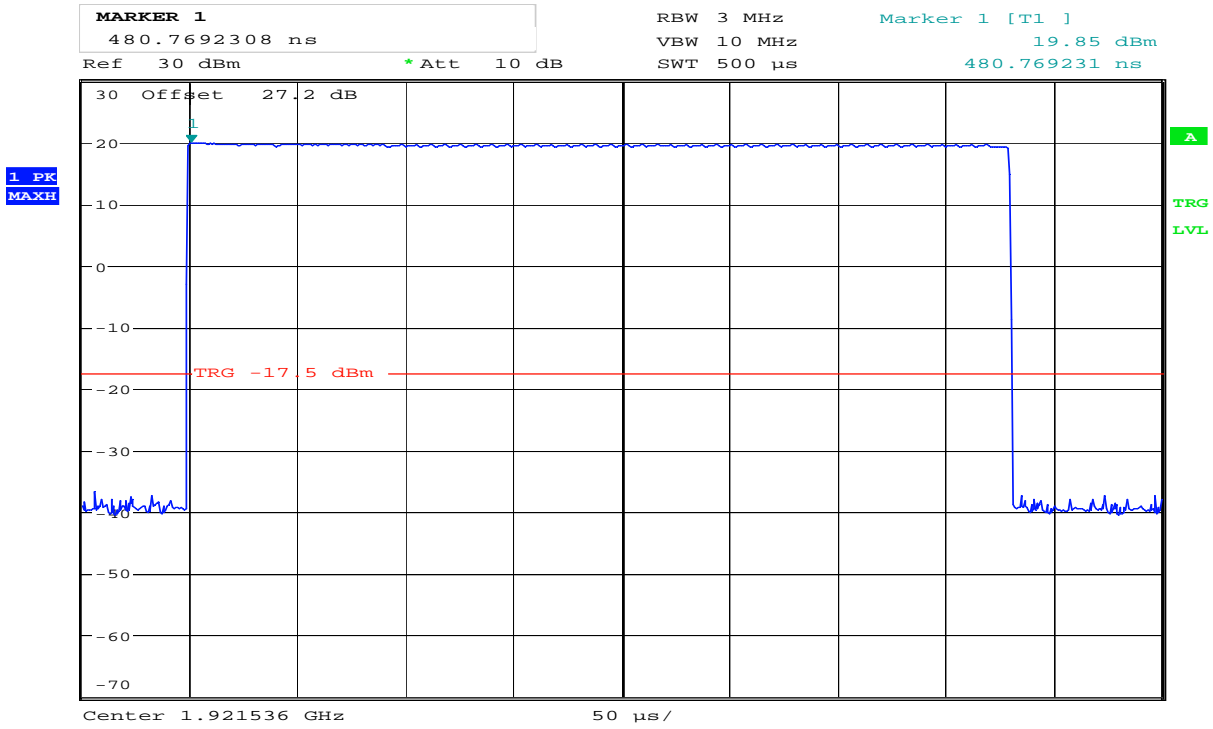

Date: 25.NOV.2011 13:44:22

### Lower Channel

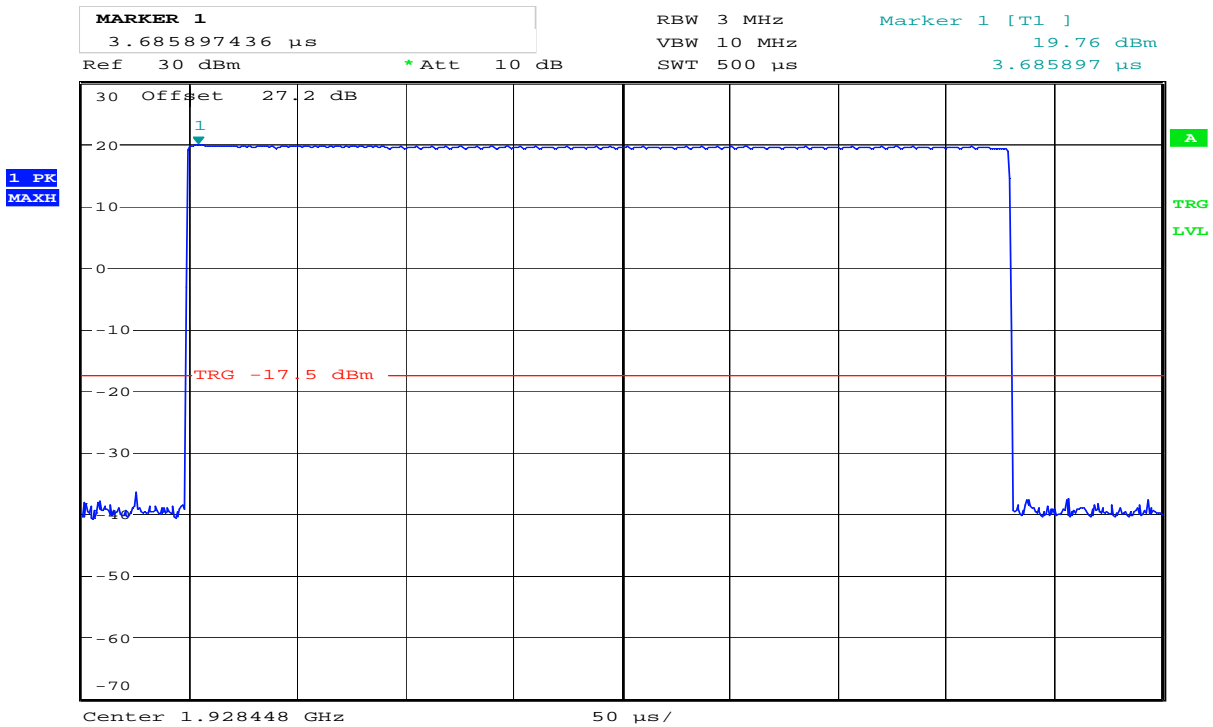

Date: 25.NOV.2011 13:45:09

### Upper Channel

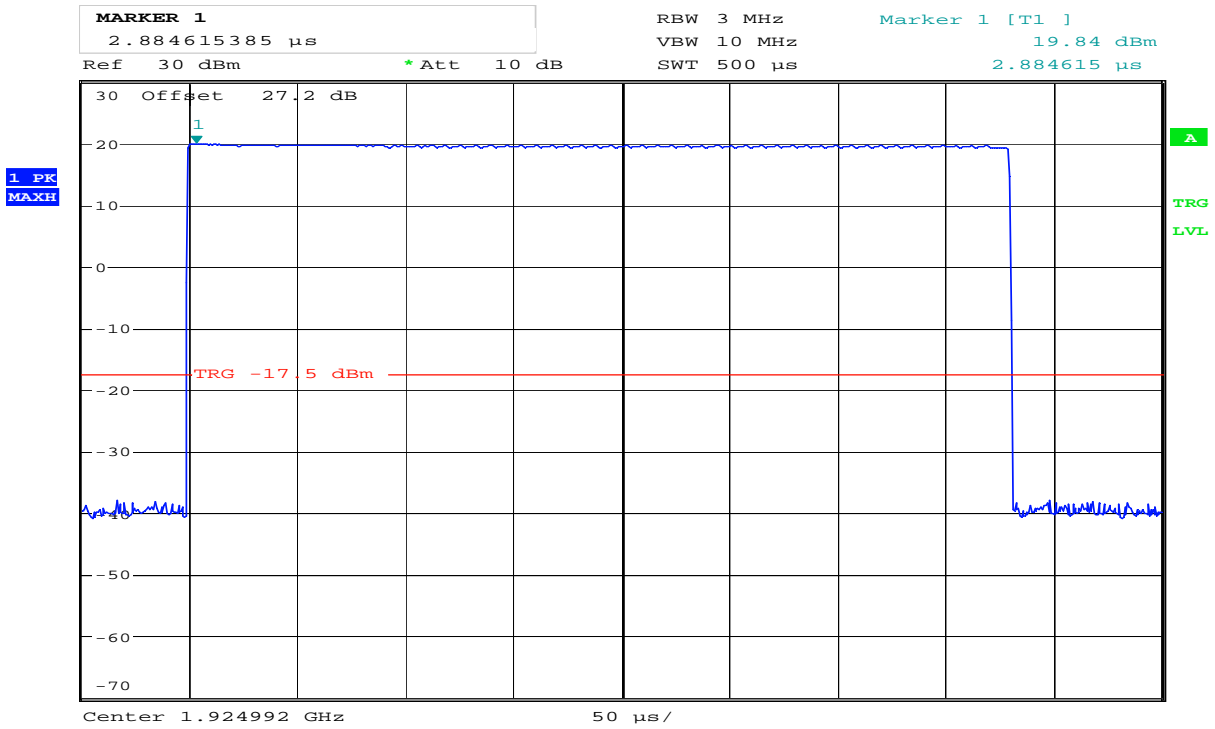

Date: 25.NOV.2011 13:44:48

**Middle Channel**

**Radiated Peak Output Power**

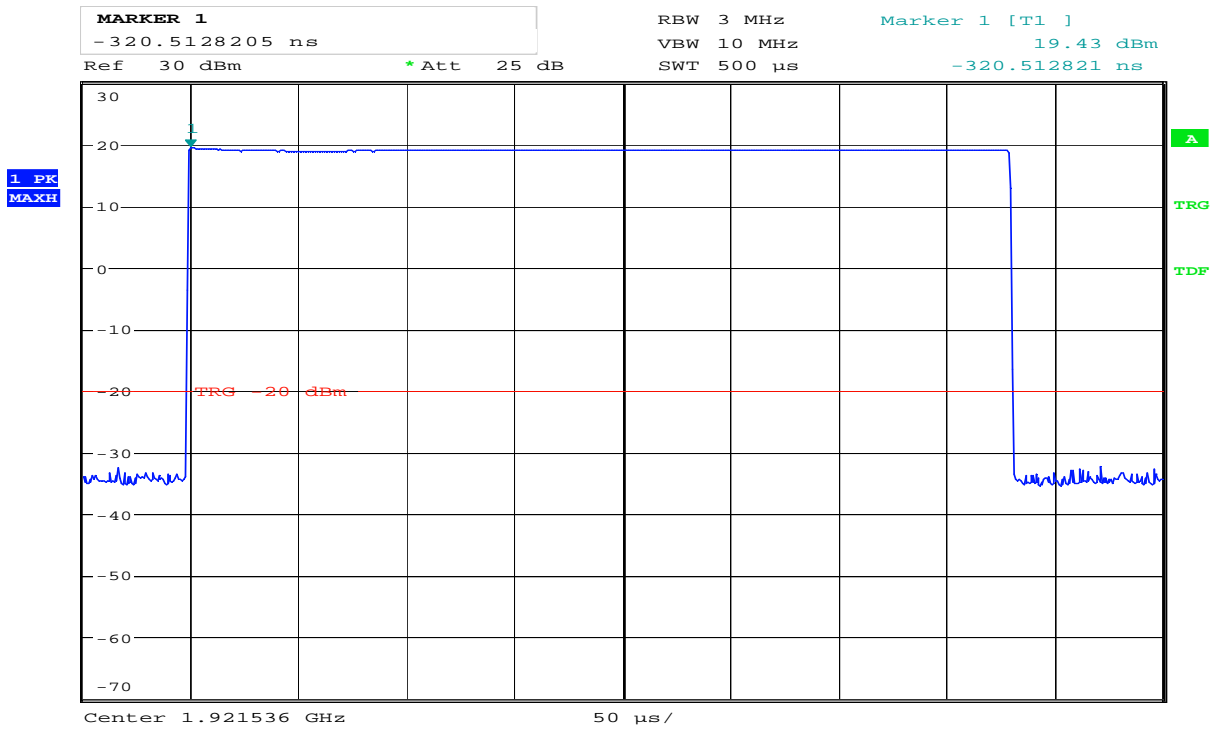

Date: 29.NOV.2011 12:14:16

**Lower Channel (Max: Ant 1, VP)**

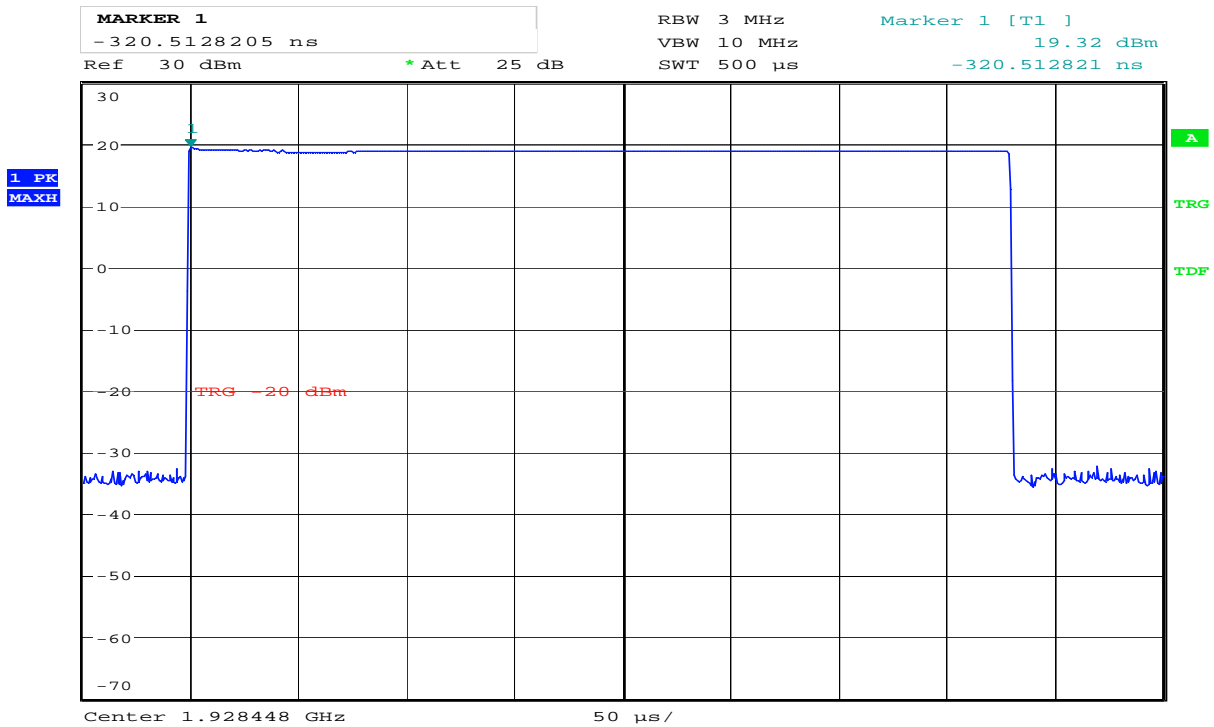

Date: 29.NOV.2011 12:13:38

**Upper Channel (Max: Ant 1, VP)**



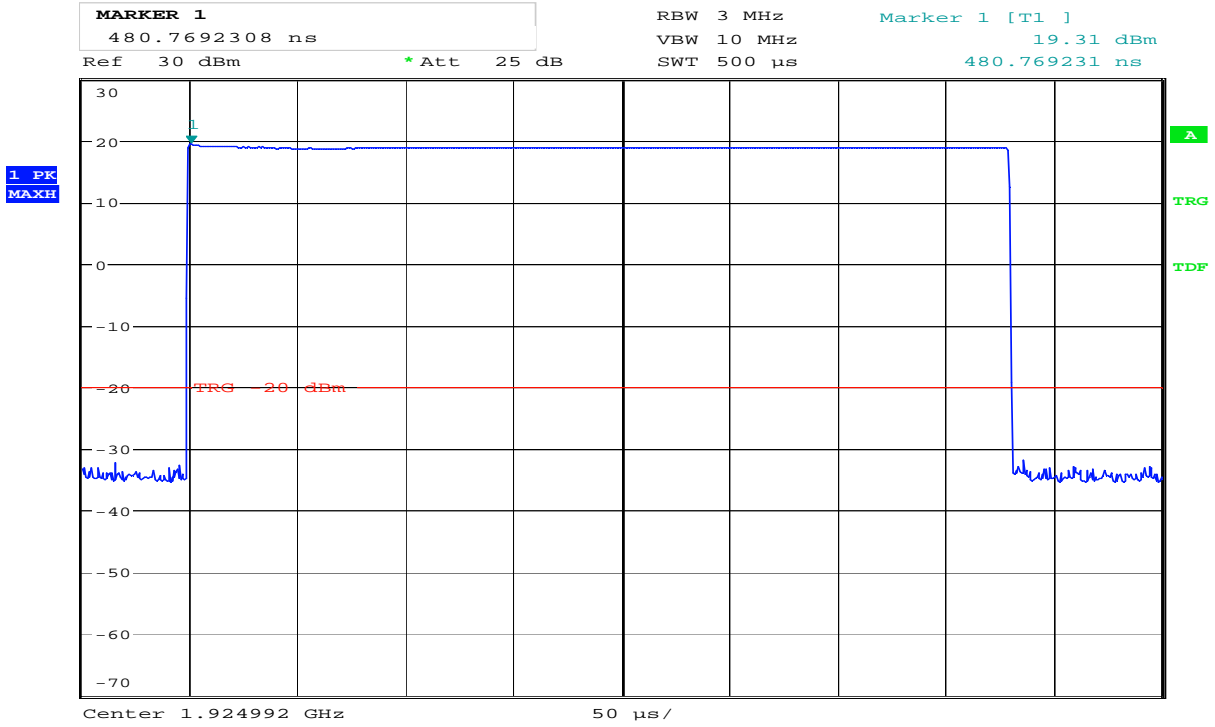

Date: 29.NOV.2011 12:14:54

**Middle Channel (Max: Ant 1, VP)**

#### 4.9 Emission Bandwidth *B*

**Test Method:**

ANSI C63.17, clause 6.1.3.

**Test Results: Complies**

**Measurement Data:**

Channel No.	Frequency (MHz)	26 dB Bandwidth <i>B</i> (kHz)
4	1921.536	2040.0
0	1928.448	2040.0

Channel No.	Frequency (MHz)	99% Bandwidth (kHz)
2	1924.992	1230.0

Channel No.	Frequency (MHz)	6 dB Bandwidth (kHz)
4	1921.536	N/A
0	1928.448	N/A

Channel No.	Frequency (MHz)	12 dB Bandwidth (kHz)
4	1921.536	N/A
0	1928.448	N/A

**Requirements, FCC 15.323(a)**

The 26 dB Bandwidth *B* shall be larger than 50 kHz and less than 2.5 MHz.

**Requirements, RSS-213 Issue 2, clause 6.4**

The 20 dB Bandwidth shall be larger than 50 kHz and less than 2.5 MHz.

No requirements for 6 and 12 dB Bandwidth, these values are only used for testing Monitoring Bandwidth if the Simple Compliance test fails (ANSI C63.17, clause 7.4).



**DELTA MARKER 2**  
 -2.04 MHz  
 Ref 20 dBm \*Att 20 dB

\*RBW 10 kHz Delta 2 [T1 ]  
 VBW 30 kHz -0.70 dB  
 SWT 50 ms -2.040000000 MHz

1 PK  
 MAXH

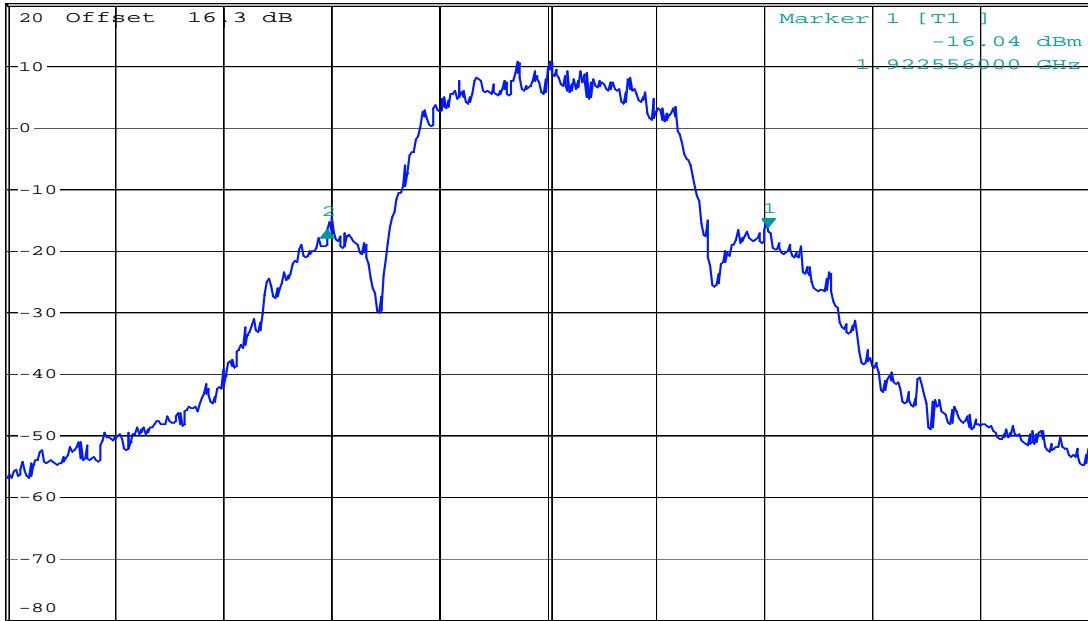

Center 1.921536 GHz 500 kHz/ Span 5 MHz

Date: 24.NOV.2011 12:34:50

**Emission Bandwidth B, Lower Channel**



**DELTA MARKER 2**  
 -2.04 MHz  
 Ref 20 dBm \*Att 20 dB

\*RBW 10 kHz Delta 2 [T1 ]  
 VBW 30 kHz 1.04 dB  
 SWT 50 ms -2.040000000 MHz

1 PK  
 MAXH

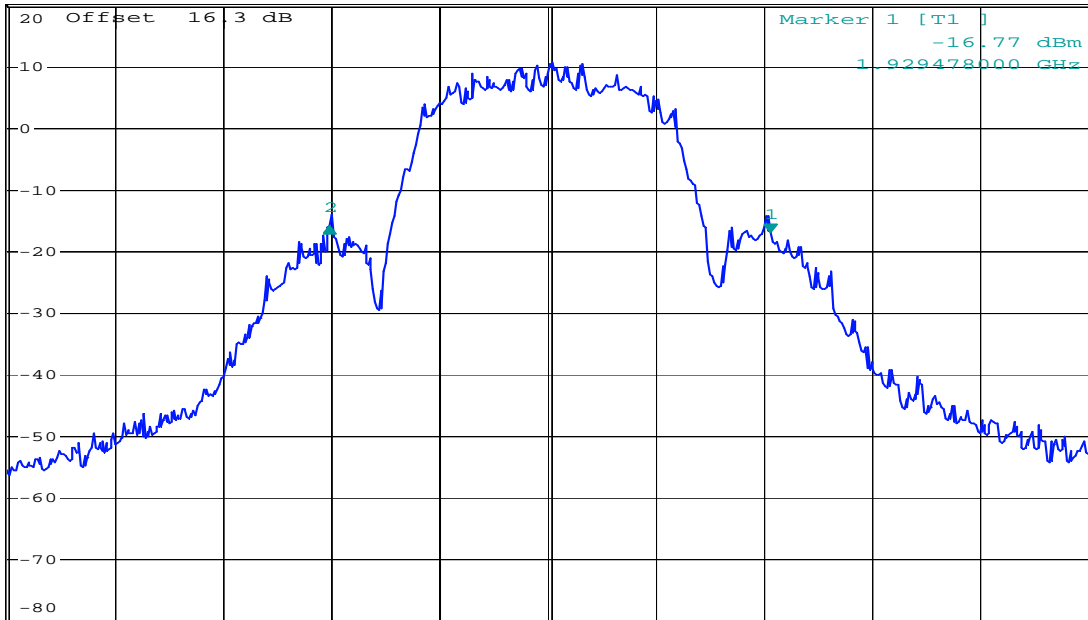

Center 1.928448 GHz 500 kHz/ Span 5 MHz

Date: 24.NOV.2011 12:32:15

**Emission Bandwidth B, Upper Channel**



MARKER 1  
 1.925012 GHz  
 Ref 20 dBm \*Att 20 dB

\*RBW 10 kHz Marker 1 [T1 ]  
 VBW 30 kHz 10.83 dBm  
 SWT 50 ms 1.925012000 GHz

1 PK  
 MAKE

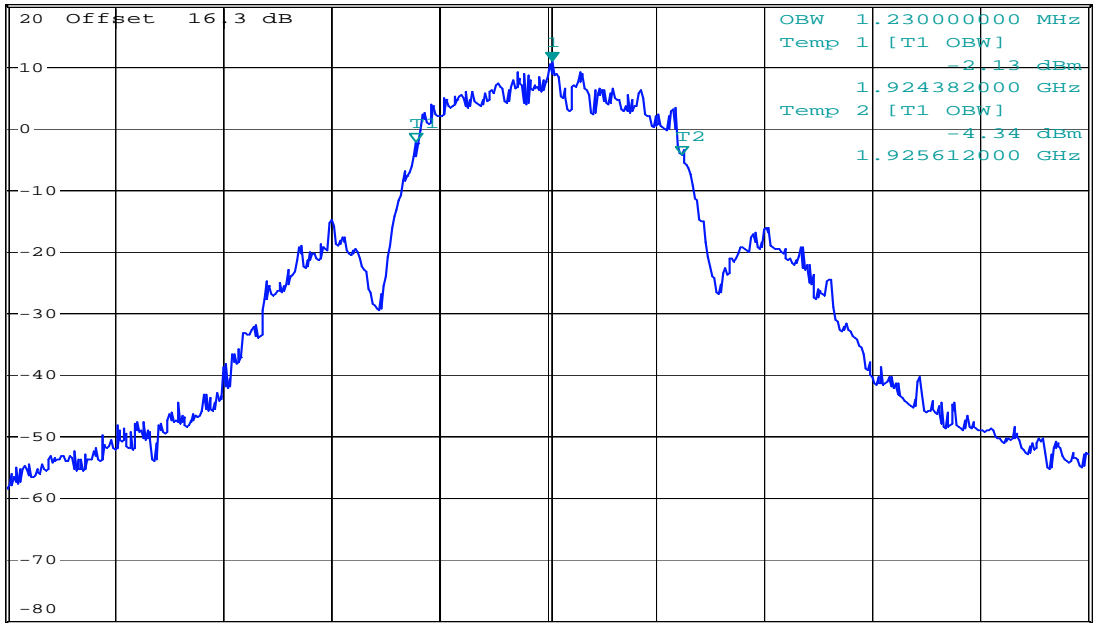

Center 1.924992 GHz 500 kHz/ Span 5 MHz

Date: 24.NOV.2011 12:26:28

**99% Bandwidth, Middle Channel**

#### 4.10 Power Spectral Density

**Test Method:**

ANSI C63.17, clause 6.1.5.

**Test Results: Complies**

**Measurement Data:**

Channel No.	Frequency (MHz)	Power Spectral Density (dBm)
4	1921.536	+1.9
0	1928.448	-3.9

Averaged over 1000 sweeps.

**Requirements, FCC 15.319(d)**

The Power Spectral Density shall be less than 3 mW (4.77 dBm) when averaged over at least 100 sweeps.

## Power Spectral Density

### Lower Channel:

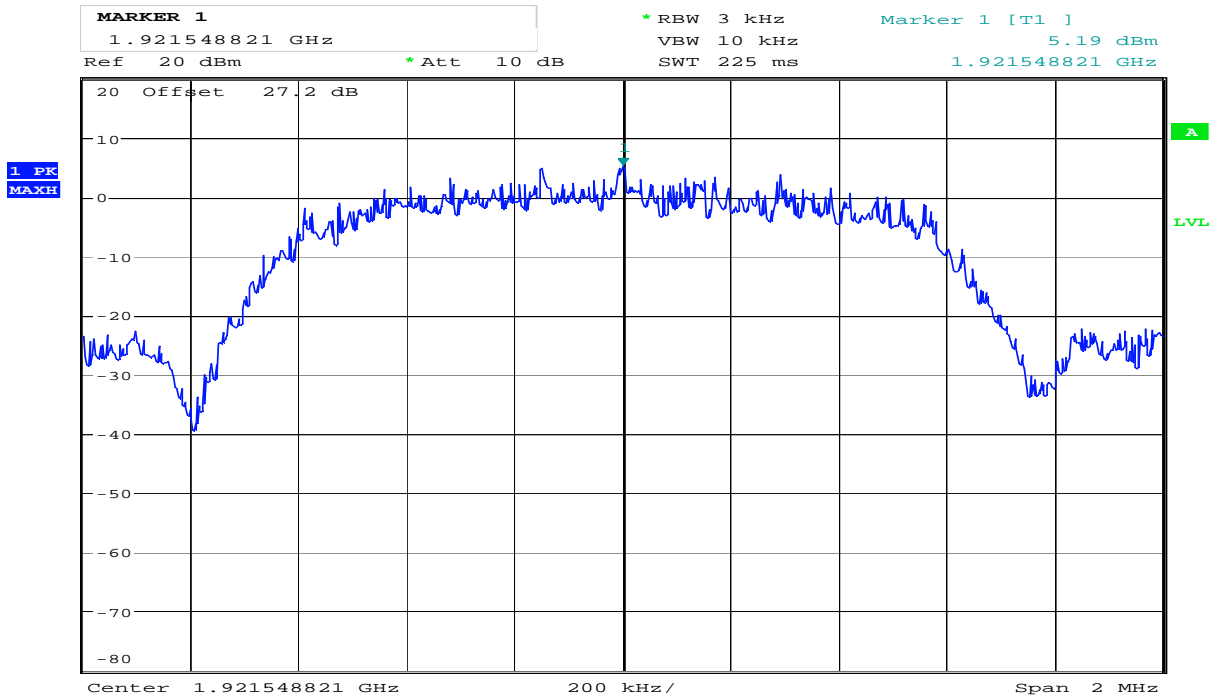

Date: 25.NOV.2011 14:09:28

### Overview

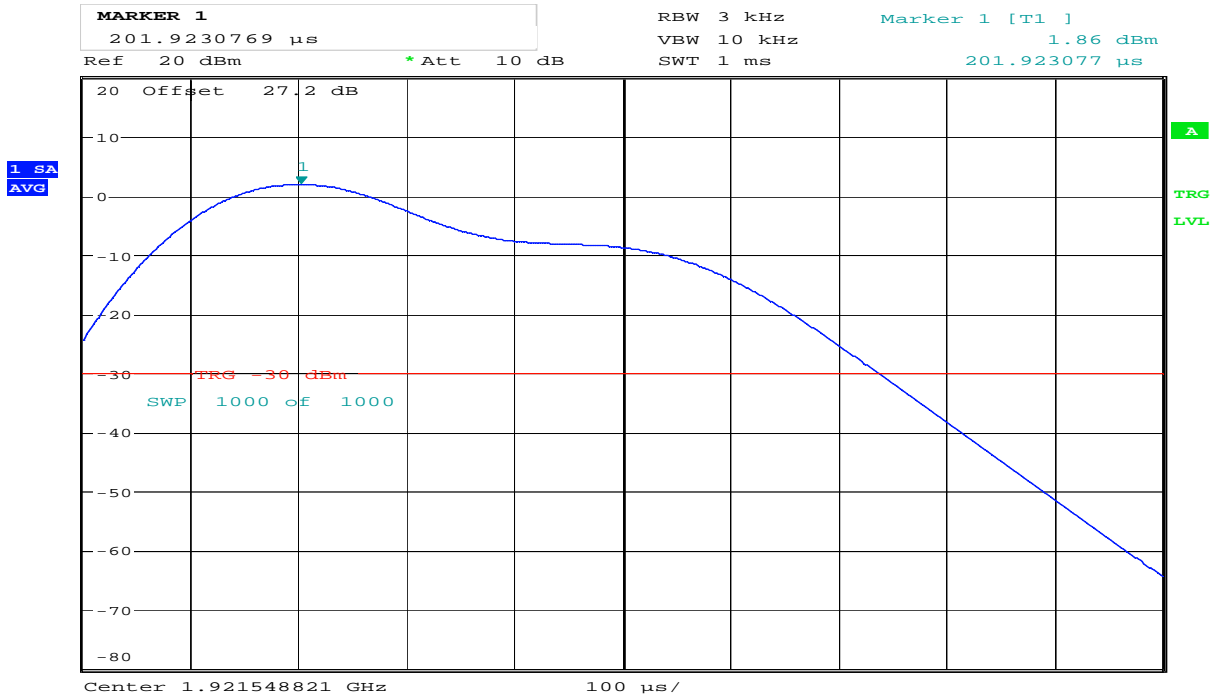

Date: 25.NOV.2011 14:10:40

### Averaged, 1000 Sweeps

### Upper Channel:

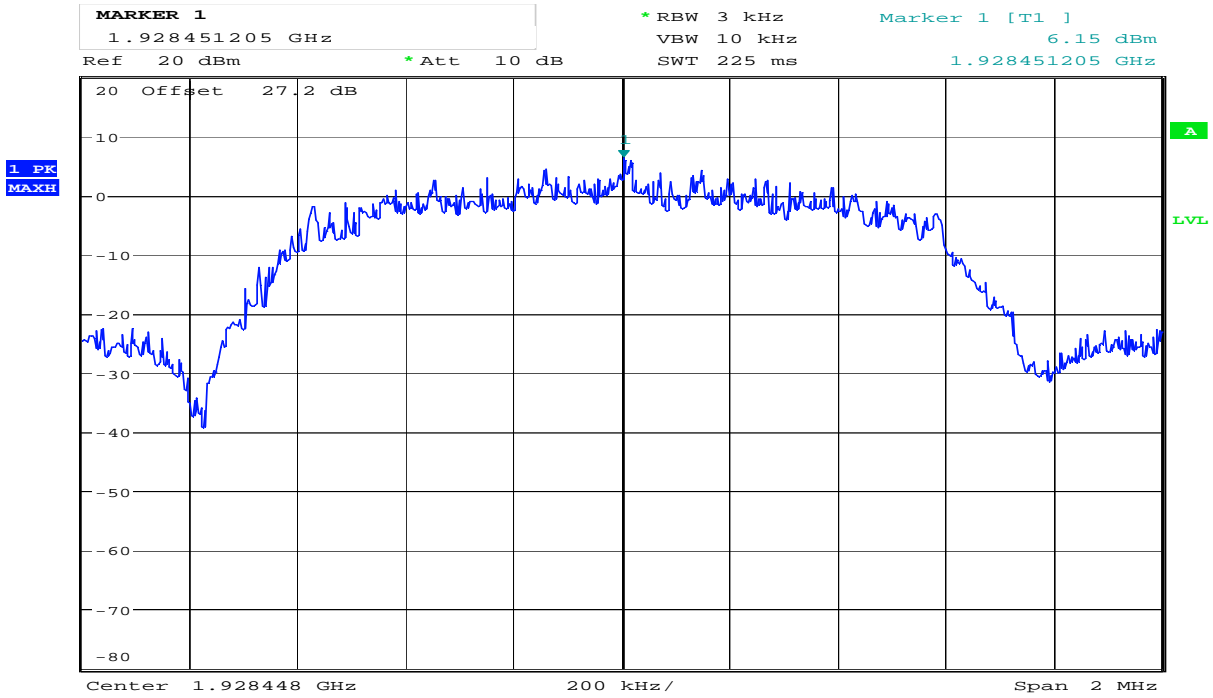

Date: 25.NOV.2011 13:47:48

### Overview

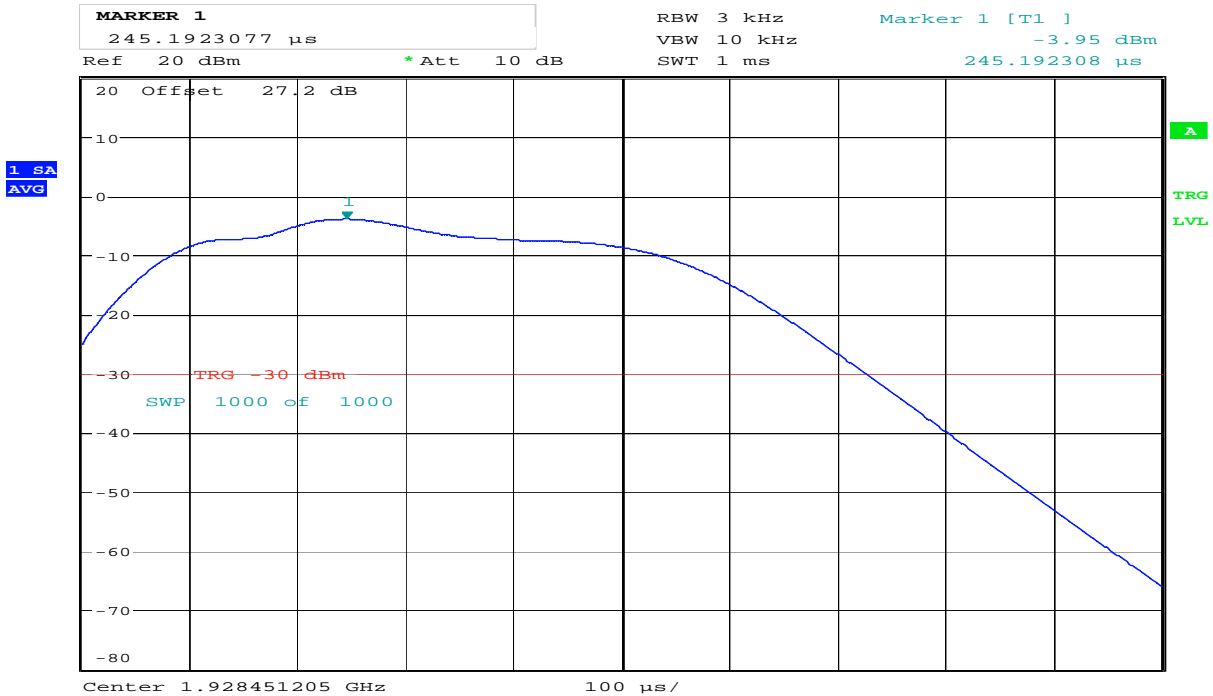

Date: 25.NOV.2011 13:53:41

### Averaged, 1000 Sweeps

## 4.11 In-Band Unwanted Emissions, Conducted

### Test Method:

ANSI C63.17, clause 6.1.6.1.

### Test Results: Complies

### Measurement Data:

See plots.

### Requirements, FCC 15.323(d):

$B < f \leq 2B$ : less than or equal to 30 dB below max. permitted peak power level

$2B < f \leq 3B$ : less than or equal to 50 dB below max. permitted peak power level

$3B < f \leq$  UPCS Band Edge : less than or equal to 60 dB below max. permitted peak power level

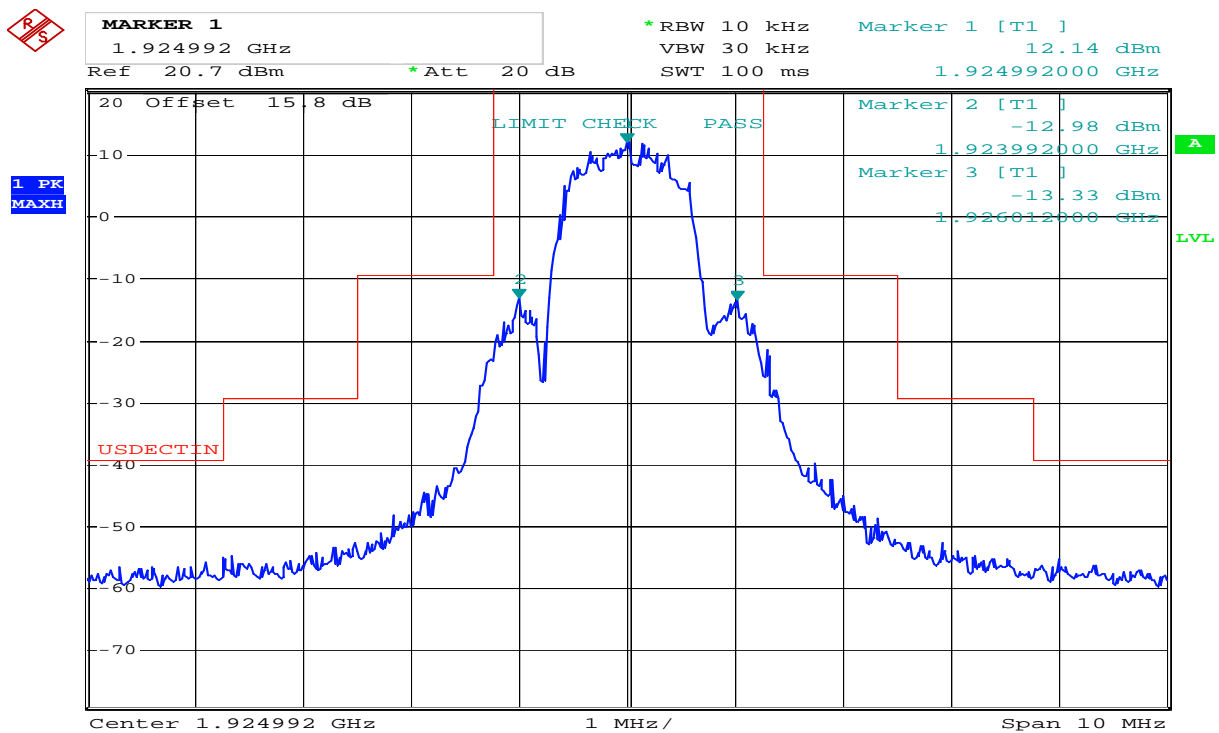

Date: 24.NOV.2011 15:07:42

### Middle Channel



**In-Band Unwanted Emissions, Conducted**

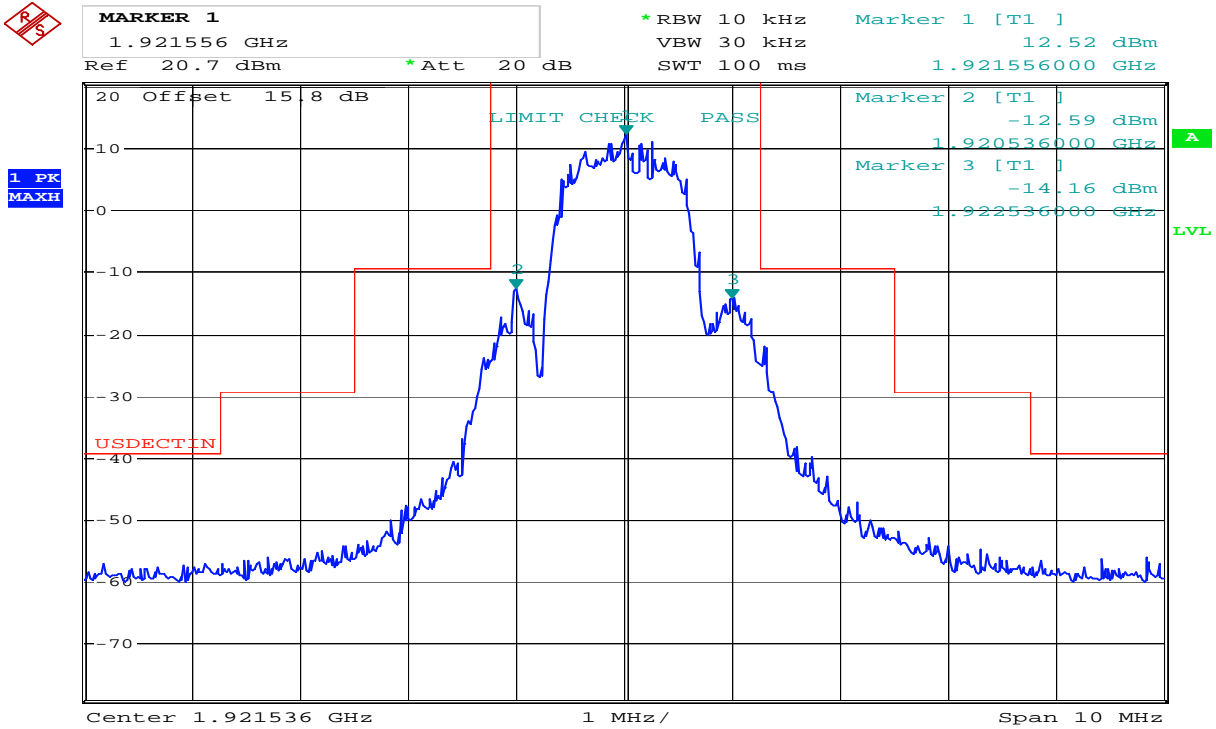

Date: 24.NOV.2011 15:10:47

**Lower Channel**

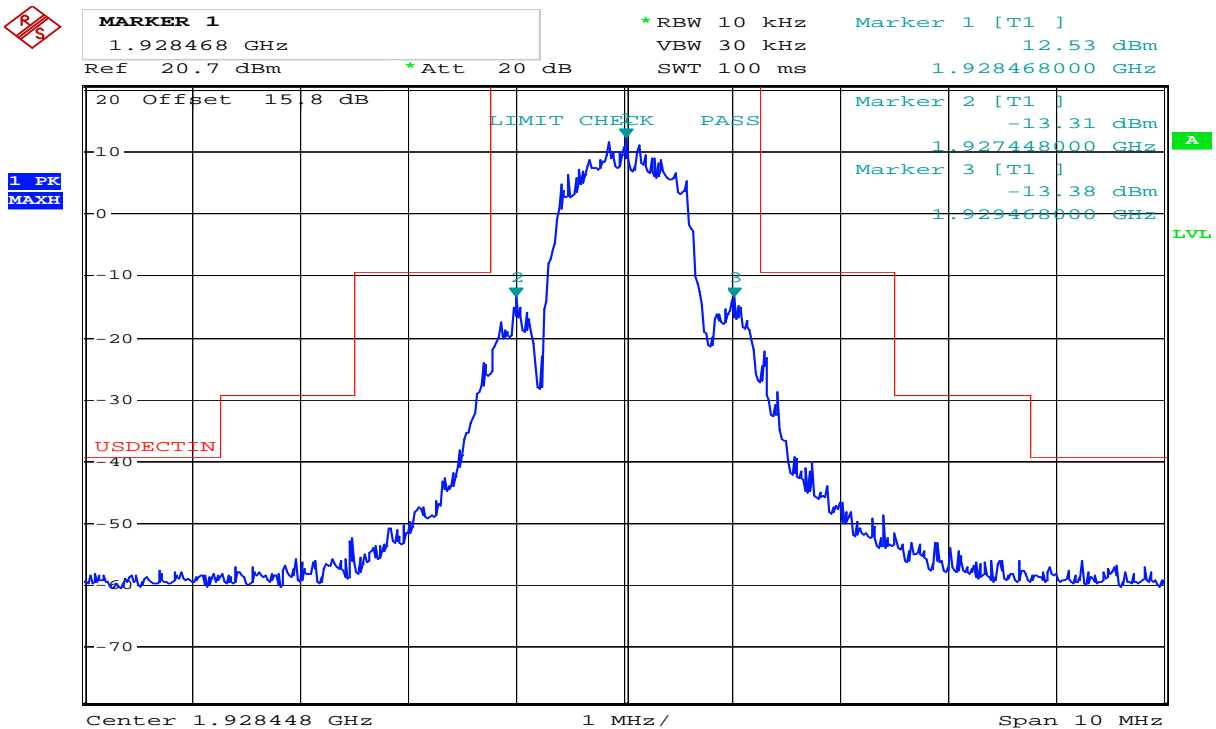

Date: 24.NOV.2011 15:09:11

**Upper Channel**

## 4.12 Out-of-band Emissions, Conducted

### Test Method:

ANSI C63.17, clause 6.1.6.2.

### Test Results: Complies

### Measurement Data:

See plots.

### Requirements, FCC 15.323(d):

$f \leq 1.25\text{MHz}$  outside UPCS band :  $\leq -9.5\text{dBm}$   
 $1.25\text{MHz} \leq f \leq 2.5\text{MHz}$  outside UPCS band :  $\leq -29.5\text{ dBm}$   
 $f \geq 2.5\text{MHz}$  outside UPCS band :  $\leq -39.5\text{ dBm}$

## Out-of-Band Emissions, Conducted

### Lower Channel:

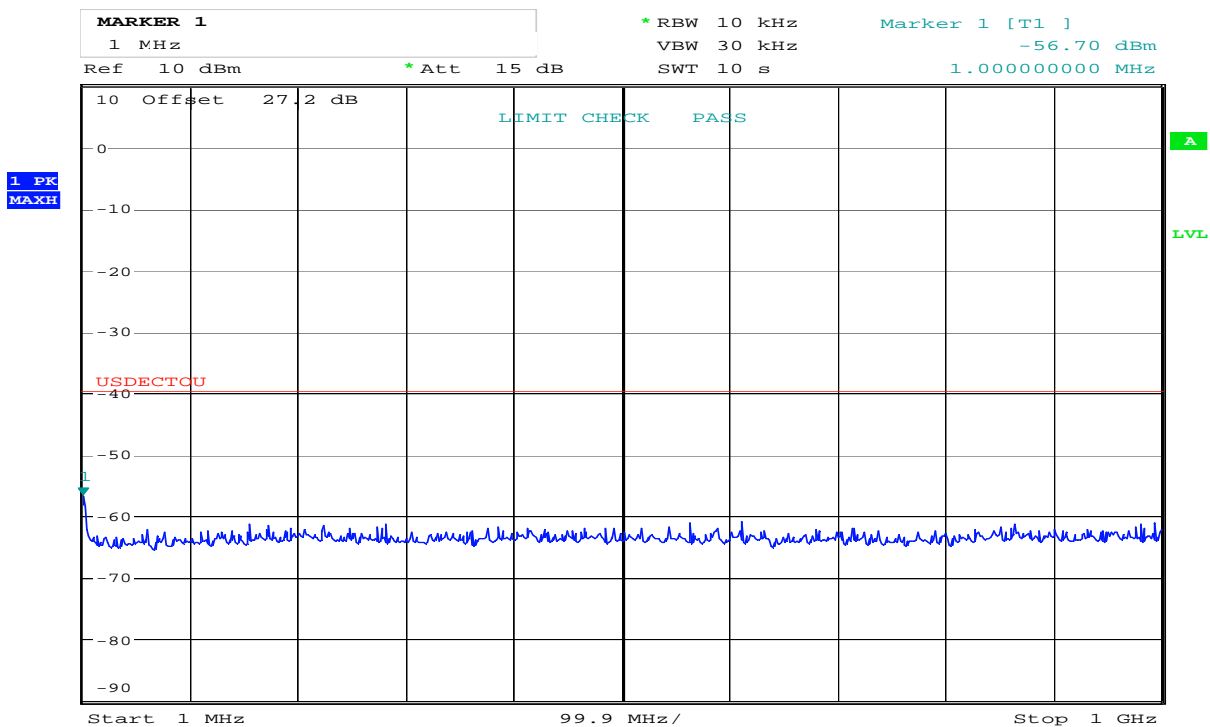

Date: 25.NOV.2011 14:39:44

## Out-of-Band Emissions, Conducted

### Lower Channel:

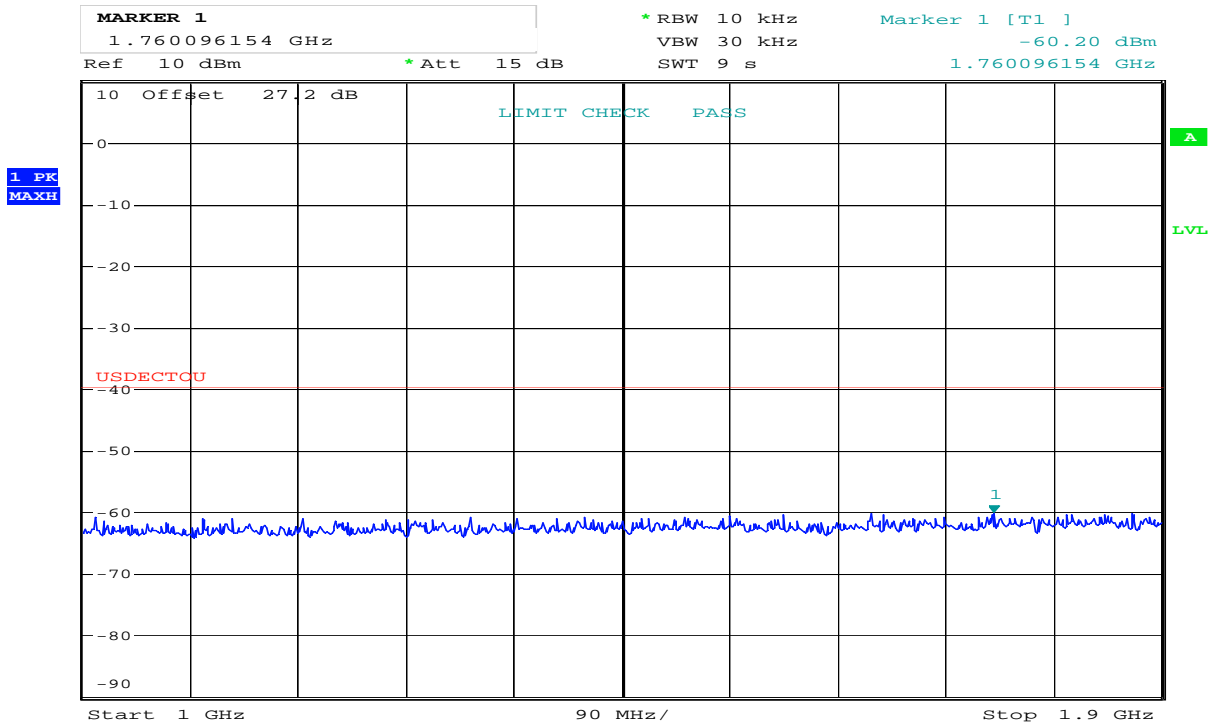

Date: 25.NOV.2011 14:41:08

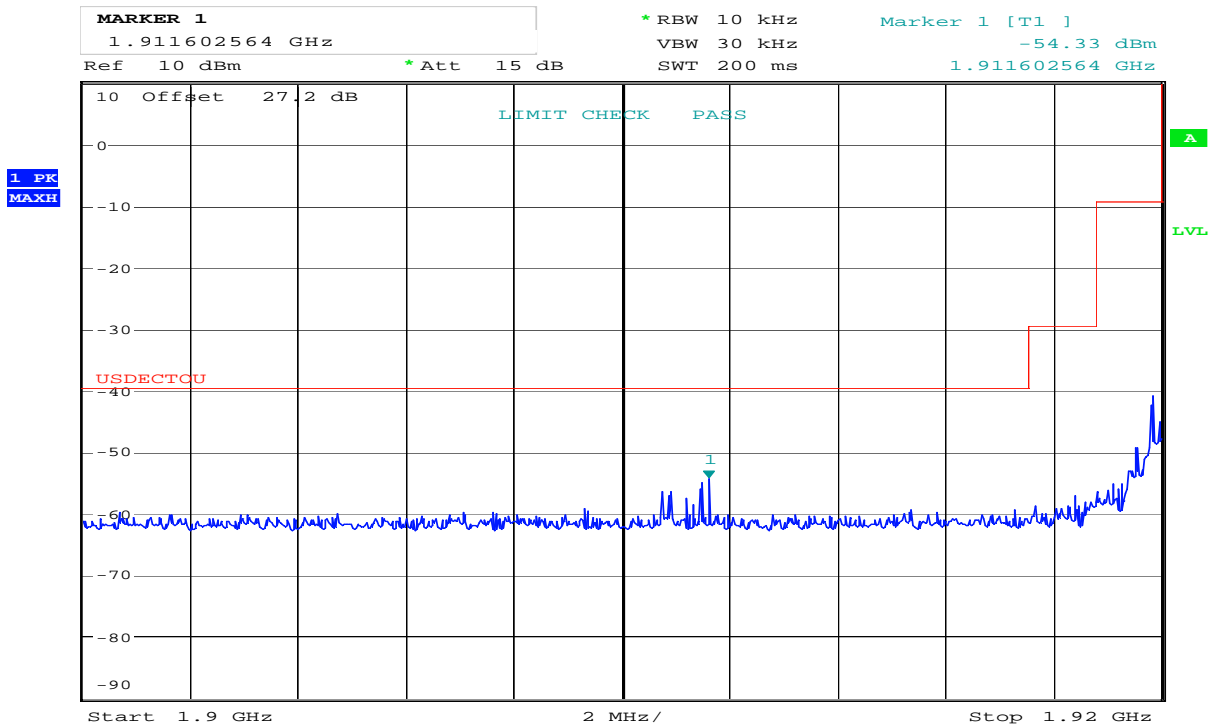

Date: 25.NOV.2011 14:38:13

## Out-of-Band Emissions, Conducted

### Upper Channel:

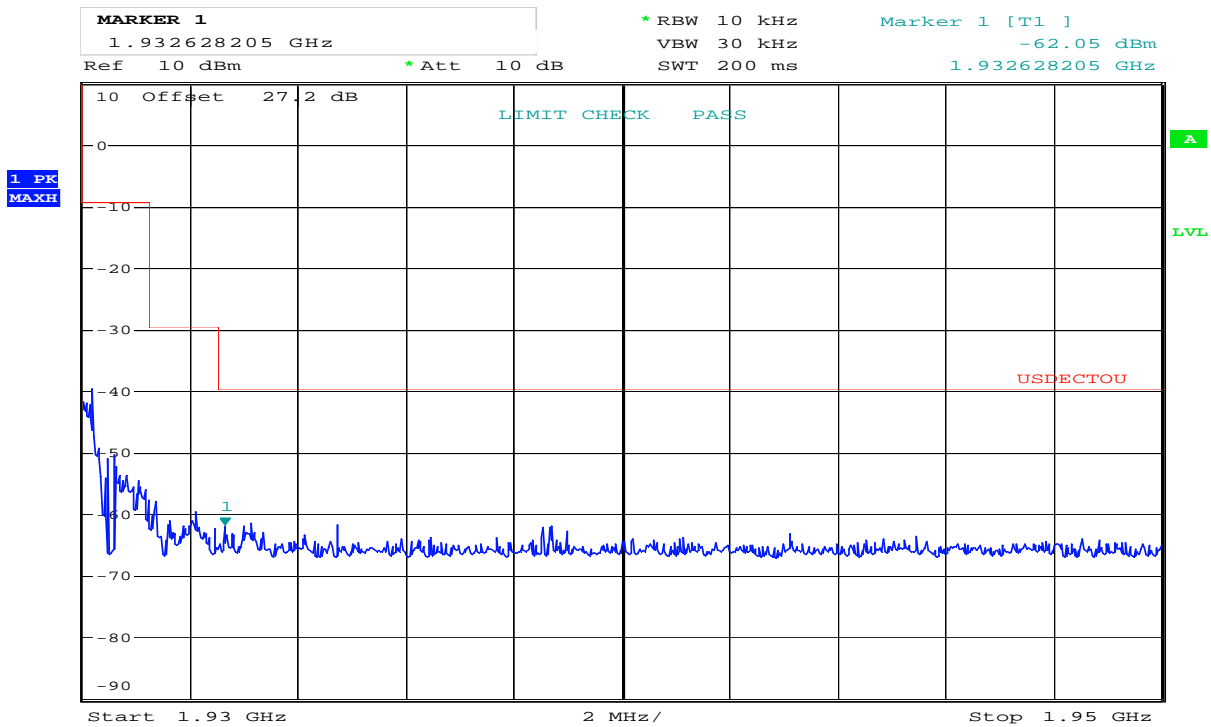

Date: 25.NOV.2011 14:13:23

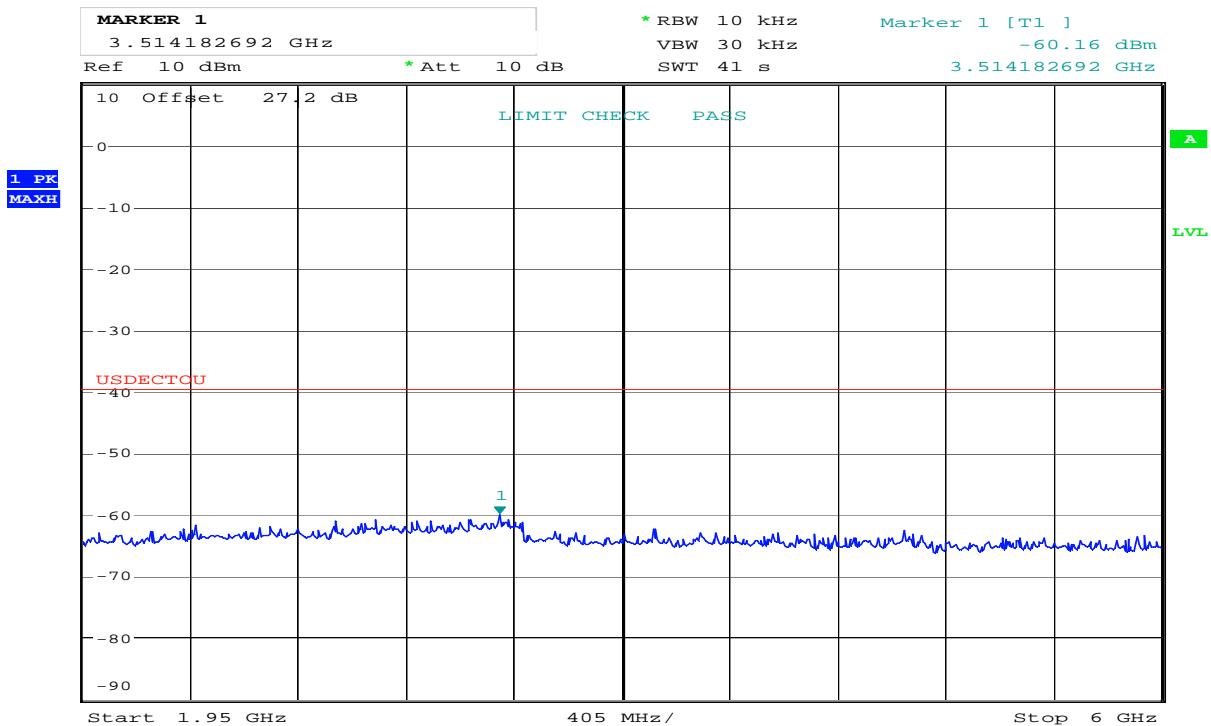

Date: 25.NOV.2011 14:19:25

## Out-of-Band Emissions, Conducted

### Upper Channel:

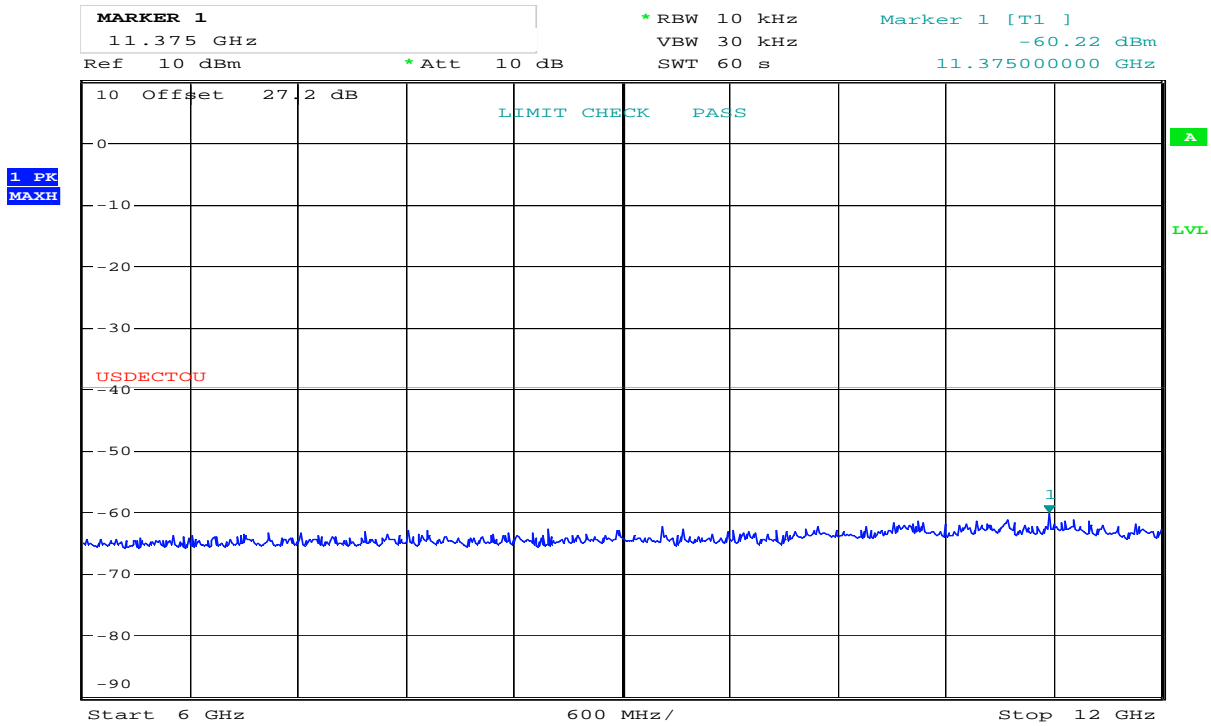

Date: 25.NOV.2011 14:24:21

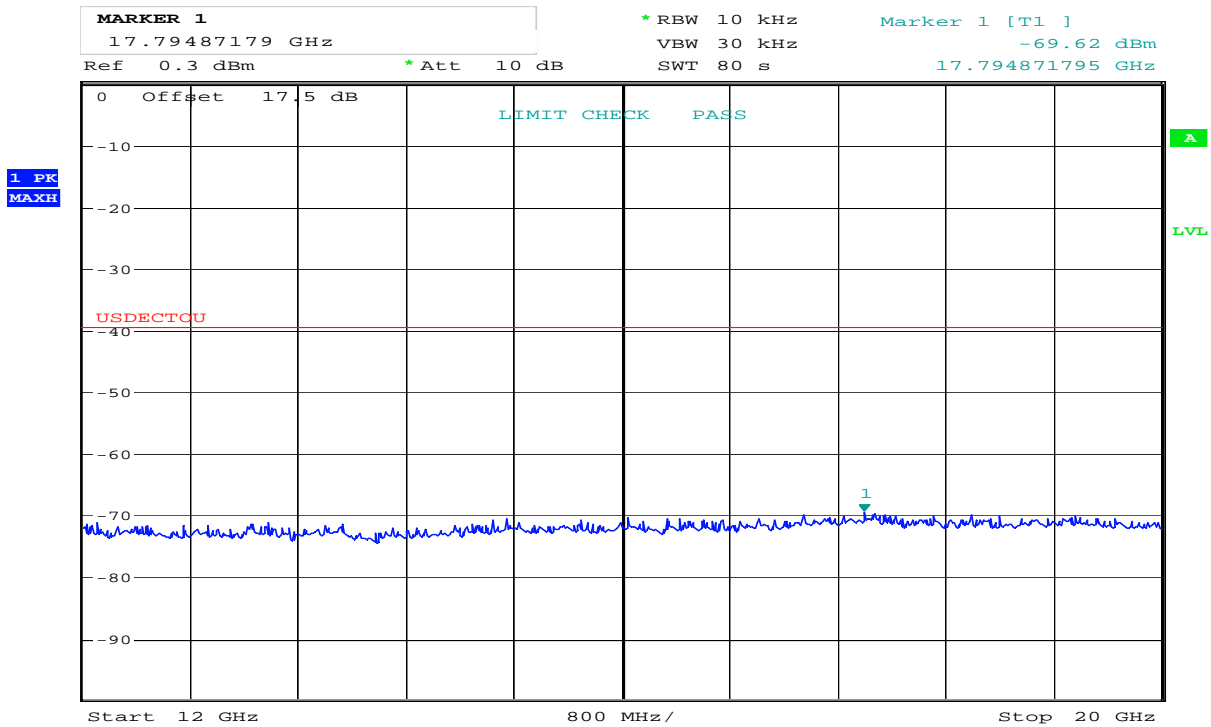

Date: 25.NOV.2011 14:33:23

### 4.13 Carrier Frequency Stability

**Test Method:**

ANSI C63.17, clause 6.2.1.

**Test Results: Complies**

**Measurement Data:**

The Frequency Stability is measured with the CMD60. The CMD60 was logged by a computer programmed to get new readings as fast as possible (about 3 readings per second) over the noted time period or number of readings. The peak-to-peak difference was recorded and the mean value and deviation in ppm was calculated.

The Carrier Frequency Stability over Power Supply Voltage and over Temperature is measured with a Frequency Domain Analyzer in histogram mode.

**Carrier Frequency Stability over Time at Nominal Temperature**

Average Mean Carrier Frequency (MHz)	Max. Diff. (kHz)	Mean. Diff. (kHz)	Max. Dev. (ppm)	Limit
1924.992540	1.997	0.540	0.76	±10 ppm

Deviation ppm = ((Diff. - Mean Diff) / Mean Carrier Freq.) x 10<sup>6</sup>

Deviation (ppm) is calculated from 3000 readings.

**Frequency Stability over Power Supply Voltage at Nominal Temperature**

Voltage	Measured Carrier Frequency (MHz)	Difference (kHz)	Deviation (ppm)	Limit
V <sub>nom</sub>	1924.984639	0	0	±10 ppm
85% of V <sub>nom</sub>	1924.984666	0.0	0.0	
115% of V <sub>nom</sub>	1924.984687	0.0	0.0	

Deviation ppm = ((Mean – Measured Frequency) / Mean) x 10<sup>6</sup>

**Frequency Stability over Temperature**

Temperature	Measured Carrier Frequency (MHz)	Difference (kHz)	Deviation (ppm)	Limit
T = +20 °C	1924.984706	0	0	±10 ppm
T = -20 °C	1924.984842	0.1	0.1	
T = +50 °C	1924.984706	0.0	0.0	

Deviation ppm = ((Mean – Measured Frequency) / Mean) x 10<sup>6</sup>

#### 4.14 Frame Repetition Stability

**Test Method:**

ANSI C63.17, clause 6.2.2.

**Test Results: Complies**

**Measurement Data:**

The envelope of the RF signal from the EUT is detected with a Crystal Detector and the mean and standard deviation of the frame repetition frequency is then gated over 100 frames and measured with a Frequency Domain Analyzer. The frame repetition stability is 3 times the standard deviation.

Carrier Frequency (MHz)	Mean (Hz)	Standard Deviation (Hz)	Frame Repetition Stability (ppm)
1924.992	100.00002	0.000001	0.043

**Limit:**

Frame Repetition Stability	±10 ppm (TDMA)
----------------------------	----------------

Ref. FCC 15.323(e), ANSI C63.17, clause 6.2.2

#### 4.15 Frame Period and Jitter

**Test Method:**

ANSI C63.17, clause 6.2.3.

**Test Results: Complies**

**Measurement Data:**

Carrier Frequency (MHz)	Frame Period (ms)	Max Jitter (µs)	3xStandard Deviation of Jitter (µs)
1924.992	10.000	-0.093	-0.030

Max Jitter = (1/ (Frame period + Pk-Pk/2)) - (1/Frame Period), when Pk-Pk and Frame Period are in Hz

3xSt.Dev.Jitter = 3x (1/(Frame Period + St.Dev) – 1/St.Dev) x 10<sup>6</sup>

**Limit:**

Frame Period	20 or 10 ms
Max Jitter	25 µs
3 times St.Dev of Jitter	12.5 µs

Ref. FCC 15.323(e), ANSI C63.17, clause 6.2.3

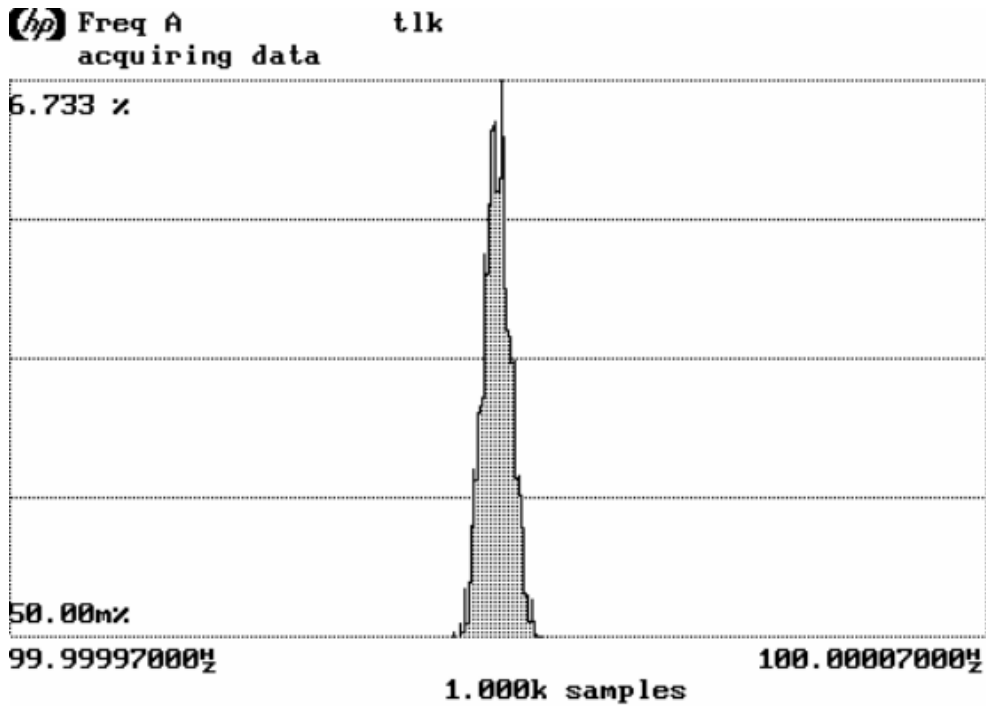

Mean      100.0000198634Hz                      1/Mean    10.000ms  
 Pk-Pk     9.13μHz    Std Dev    1.4257μHz

Frame Repetition Stability, Gated over 100 Frames

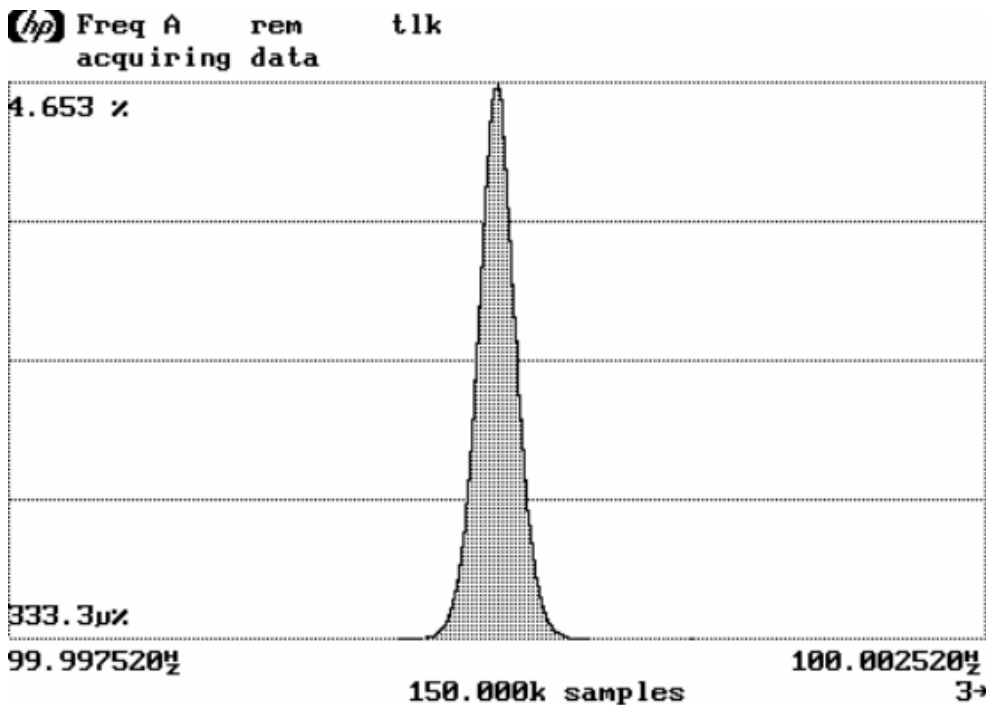

Mean      100.000019906Hz                      1/Mean    10.000ms  
 Pk-Pk     1.860mHz    Std Dev    99.729μHz

Frame Period and Jitter



#### 4.16 Monitoring Threshold, Least Interfered Channel

##### Monitoring Threshold Limits:

Lower Threshold:

$$T_L = 15 \log B - 184 + 30 - P_{EUT} \quad (\text{dBm})$$

Upper Threshold:

$$T_U = 15 \log B - 184 + 50 - P_{EUT} \quad (\text{dBm})$$

$B$  is measured Emission Bandwidth in Hz  
 $P_{EUT}$  is measured Transmitter Power in dBm

Calculated values:

	FCC 15.323	RSS-213, Issue 2
Lower Threshold	-79.2 dBm	-82.5 dBm
Upper Threshold	-59.2 dBm	-62.5 dBm

The Lower Threshold is applicable for systems which have defined less than 40 duplex system access channels. The Upper Threshold is applicable for systems with more than 40 duplex system access channels and that implements the Least Interfered Channel Procedure (LIC).

The tested EUT has less than 40 system access channels when long slot is used.

##### Measurement Procedure:

The Upper or Lower Threshold is found by the procedure defined in ANSI C63.17 clause 7.3.1 or 7.3.2.

The test in 7.3.1 a) was performed with the long slot. The Measured Lower Threshold is the level where the EUT and the Companion Device was first able to establish a long slot connection.

Least Interfered Channel Procedure NOT used:	
Lower Threshold	-86.0 dBm
Least Interfered Channel Procedure:	
Upper Threshold	-59.5 dBm

##### Least Interfered Channel (LIC) Procedure Test, FCC 15.323(b), (c)(2) and (c)(5)

ANSI C63.17 clause 7.3.3 ref.	Observation	Verdict
b) $f_1 T_L + 13 \text{ dB}$ , $f_2$ at $T_L + 6 \text{ dB}$	Transmission always on $f_2$	Pass
c) $f_1 T_L + 6 \text{ dB}$ , $f_2$ at $T_L + 13 \text{ dB}$	Transmission always on $f_1$	Pass
d) $f_1 T_L + 7 \text{ dB}$ , $f_2$ at $T_L$	Transmission always on $f_2$	Pass
e) $f_1 T_L$ , $f_2$ at $T_L + 7 \text{ dB}$	Transmission always on $f_1$	Pass

**Selected Channel Confirmation, FCC 15.323(c)(1) and (5)**

ANSI C63.17 clause 7.3.4	Observation	Verdict
b) Shall <b>not</b> transmit on $f_1$	EUT transmits on $f_2$	<b>Pass</b>
d) Shall <b>not</b> transmit on $f_2$	EUT transmits on $f_1$	<b>Pass</b>

**Limits:**

	FCC 15.323	RSS-213, Issue 2
Lower Threshold + 6 dB margin	-73.2 dBm	-76.5 dBm
Upper Threshold + 6 dB margin	-53.2 dBm	-56.5 dBm

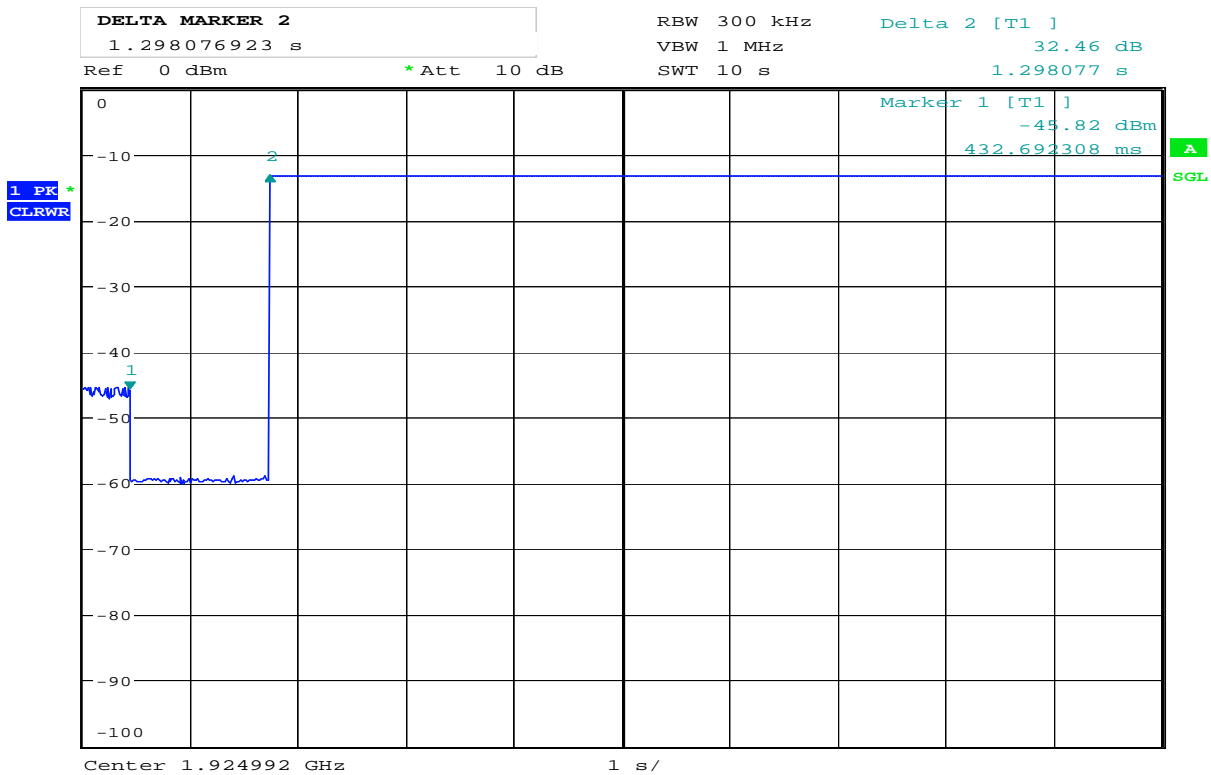

Date: 28.NOV.2011 17:23:28

**7.3.4 Selected Channel Confirmation, Connection 1.3s After Interferer Removed**

#### 4.17 Threshold Monitoring Bandwidth

This test is only required if a dedicated monitoring receiver is used. However, if the test is not carried out the manufacturer shall declare and provide proper evidence that the monitoring is made through the radio receiver used for communication.

**Measurement Procedure:**

Simple Compliance Test, ANSI C63.17, clause 7.4.1

More Detailed Test, ANSI C63.17, clause 7.4.2

The test is passed if **either** the Simple Compliance Test or the More Detailed test is passed.

During this test the spectrum analyzer is observed visually to see if the EUT transmits or not.

**Test Results:**

Test performed	Observation	Verdict
Simple Compliance test, at $\pm 30\%$ of $B$	No transmissions	Pass
More Detailed Test, at -6 dB points	N/A	N/A
More Detailed Test, at -12 dB points	N/A	N/A

The more detailed test must be pass at both the -6 and -12 dB points if the Simple Compliance test fails.

**Comment:** The Simple Compliance Test was performed with the level at  $T_U + U_M + 10$  dB to check that the EUT did not transmit at all. It was also checked that the EUT could not set up a long-slot connection when the Interferer level was set to  $T_L + U_M + 10$  dB.

The tested EUT uses the same receiver for monitoring and communication, this test is therefore not required. However the test has been performed nonetheless and the test is passed.

**Limits, FCC 15.323(c)(7):**

The monitoring system bandwidth must be equal to or greater than the emission bandwidth of the intended transmission.

## 4.18 Reaction Time and Monitoring Interval

### Measurement Procedure

ANSI C63.17, clause 7.5

### Test results:

By administrative commands and out-of-operating region interference, the EUT is restricted to operate on a single carrier frequency.

Time-synchronized pulsed interference was then applied on the carrier at pulsed levels  $T_U + U_M$  to check that the EUT does not transmit at all, and  $T_L + U_M$  to check that a long-slot connection could not be established. The level was raised 6 dB for part d) with 35  $\mu$ s pulses.

The pulses are synchronized with the EUT timeslots and applied centered within all timeslots.

Pulse Width, ref. to ANSI C63.17 clause 7.5	Observation	Verdict
c) > largest of 50 $\mu$ s and $50 \cdot \text{SQRT}(1.25/B)$	No transmissions	Pass
d) > largest of 35 $\mu$ s and $35 \cdot \text{SQRT}(1.25/B)$ , and with interference level raised 6 dB	No transmissions	Pass

**Comment:** Since  $B$  is larger than 1.25 MHz the test was performed with pulse lengths of 50  $\mu$ s and 35  $\mu$ s.

### Limits, FCC 15.323(c)(1), (5) and (7)

The maximum reaction time must be less than  $50 \cdot \text{SQRT}(1.25/\text{emission bandwidth in MHz})$  microseconds for signals at the applicable threshold level but shall not be required to be less than 50 microseconds.

If a signal is detected that is 6 dB or more above the applicable threshold level, the maximum reaction time shall be  $35 \cdot \text{SQRT}(1.25/\text{emission bandwidth in MHz})$  microseconds but shall not be required to be less than 35 microseconds.

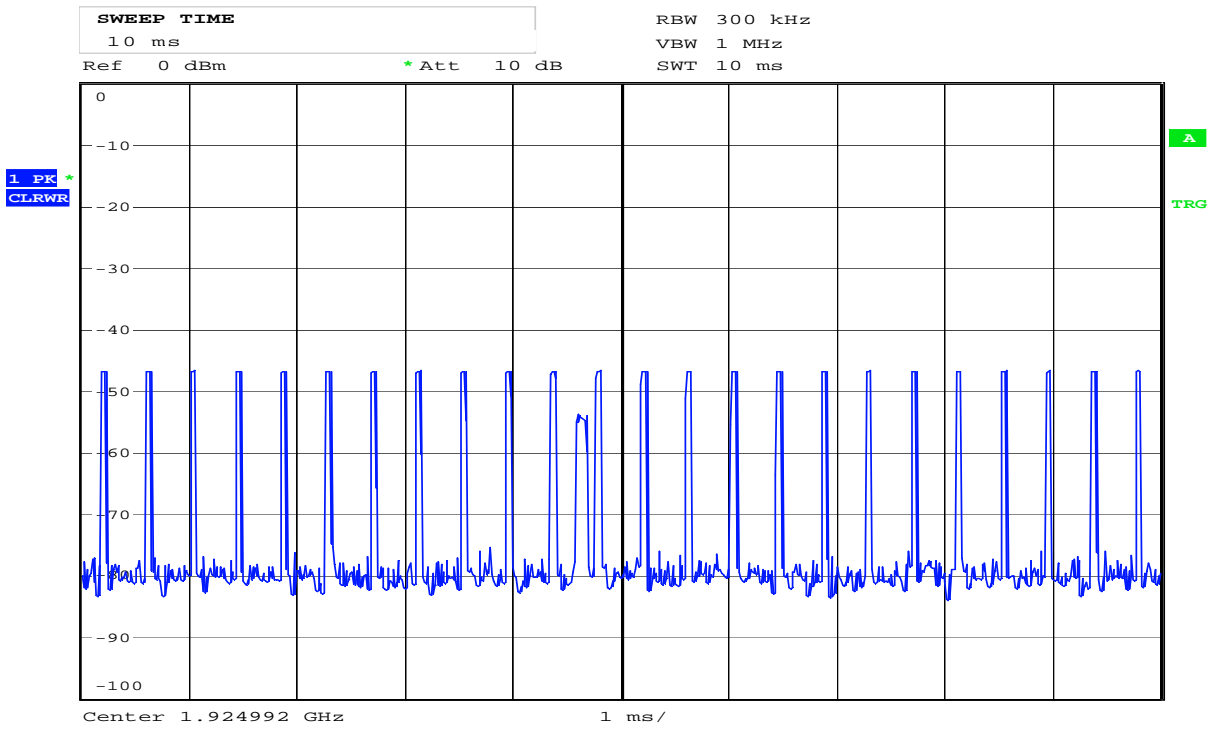

Date: 28.NOV.2011 17:37:25

**50 µs Pulses, Full Slot**

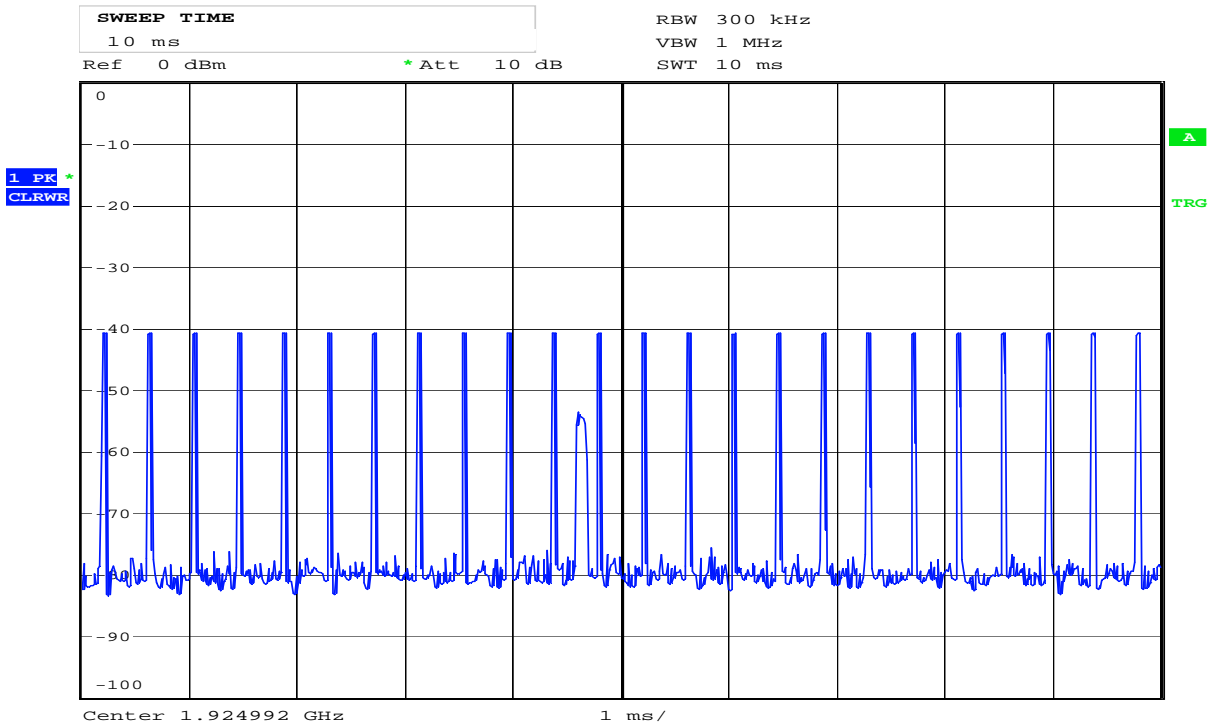

Date: 28.NOV.2011 17:36:01

**35 µs Pulses, Full Slot**

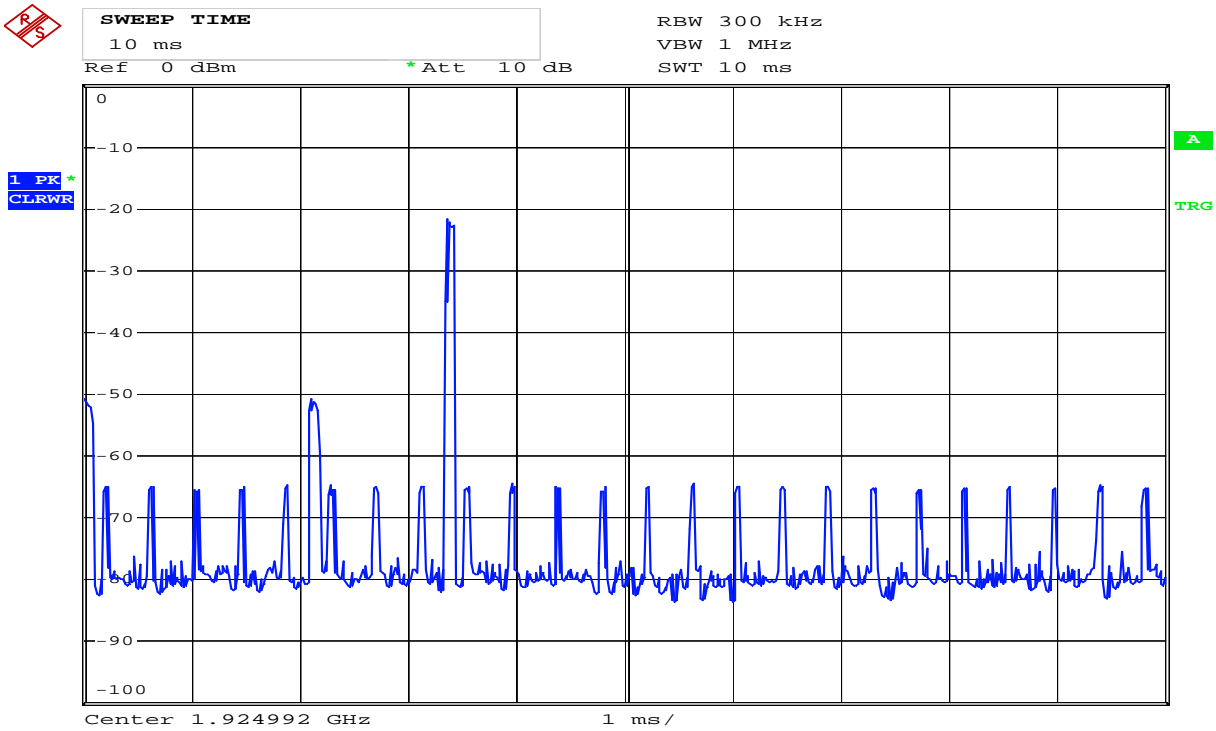

Date: 10.FEB.2012 11:04:55

**50 µs Pulses, Long Slot**

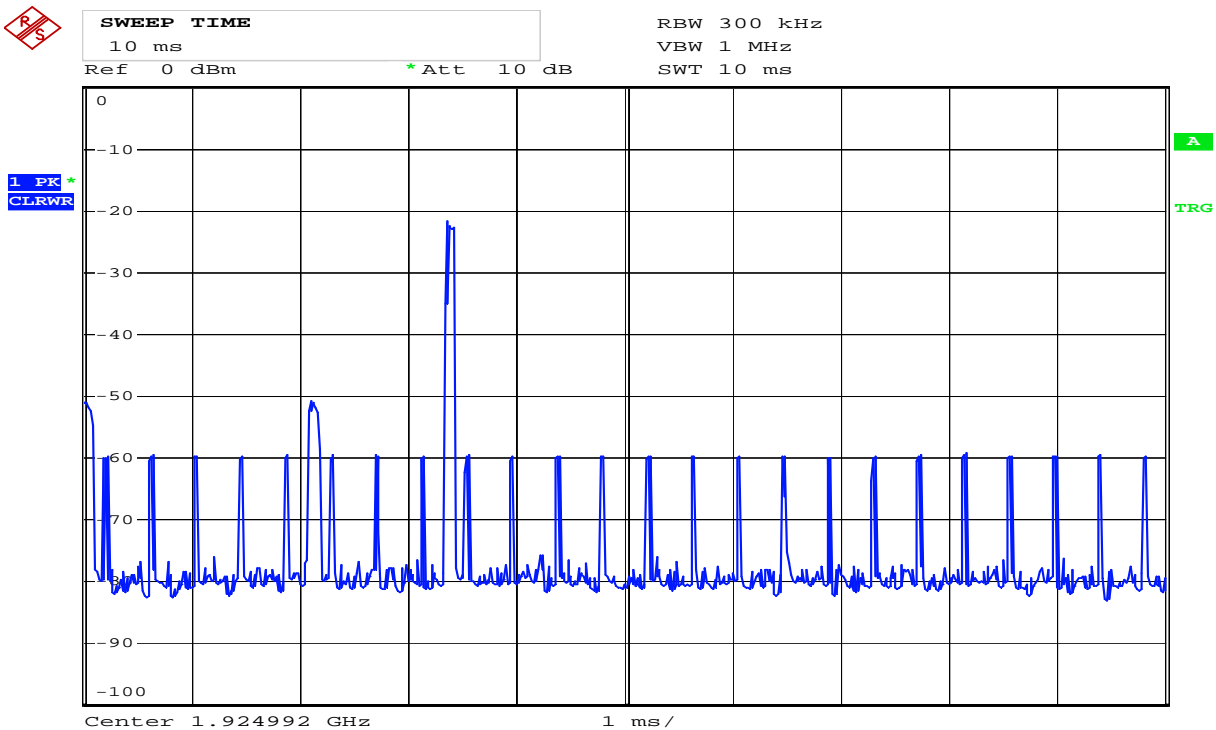

Date: 10.FEB.2012 11:06:35

**35 µs Pulses, Long Slot**

#### 4.19 Time and Spectrum Window Access Procedure

This requirement is only for EUTs which transmit unacknowledged control and signaling information.

**Measurement Procedure:**

Timing for EUTs using control and signaling channel type transmissions: ANSI C63.17, clause 8.1

**Test results:**

Access Criteria, ref. to ANSI C63.17 clause 8.1.1	Observation	Verdict
b) Check that the EUT transmits on the interference free time-slot	EUT transmits on the interference free time-slot	Pass
b) The EUT must terminate or pause in its repetitive transmission of the control and signalling channel on the open channel to repeat the access criteria not less frequently than every 30 s	Transmission paused every 1.3 s	Pass

If FCC 15.323(c)(6) option, **If Random Waiting Interval is NOT implemented**

Access Criteria, ref. to ANSI C63.17 clause 8.1.2	Observation	Verdict
b) Check that the EUT changes to an interference-free slot when interference is introduced on the time slot in use	EUT changes to the interference-free time-slot, and stays there	Pass

If FCC 15.323(c)(6) option, **Only if Random Waiting Interval is implemented**

Access Criteria, ref. to ANSI C63.17 clause 8.1.3	Observation	Verdict
b-d) Check that the EUT uses random waiting interval before continuing transmission on an interfered time slot	N/A	N/A

Comment: The tested EUT does not support the Random Waiting Interval option.

**Limits:**

**FCC 15.323(c)(4):**

Once access to specific combined time and spectrum windows is obtained an acknowledgement from a system participant must be received by the initiating transmitter within one second or transmission must cease. Periodic acknowledgements must be received at least every 30 seconds or transmission must cease. Channels used exclusively for control and signaling information may transmit continuously for 30 seconds without receiving an acknowledgement, at which time the access criteria must be repeated.

**FCC 15.323(c)(6):**

If the selected combined time and spectrum windows are unavailable, the device may either monitor and select different windows or seek to use the same windows after waiting an amount of time, randomly chosen from a uniform random distribution between 10 and 150 milliseconds, commencing when the channel becomes available

### Access Criteria Check

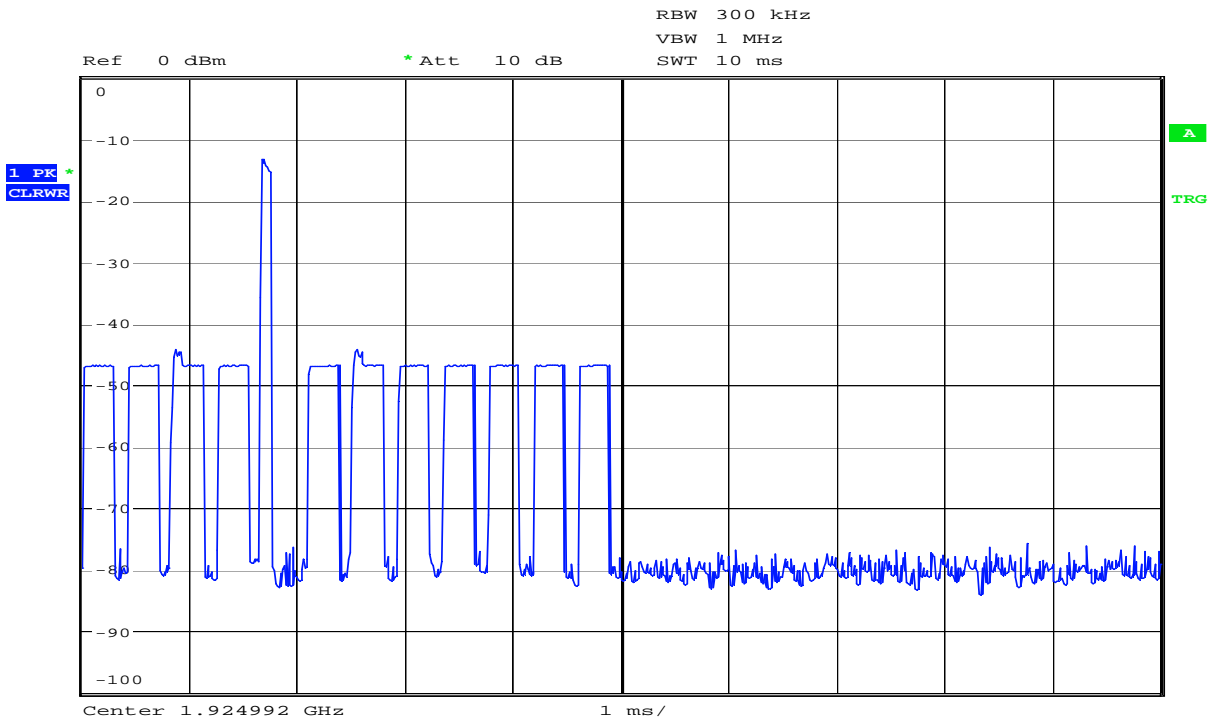

Date: 28.NOV.2011 17:57:21

#### 8.1.1a) EUT Transmits on Unblocked Slot



### Access Criteria Check

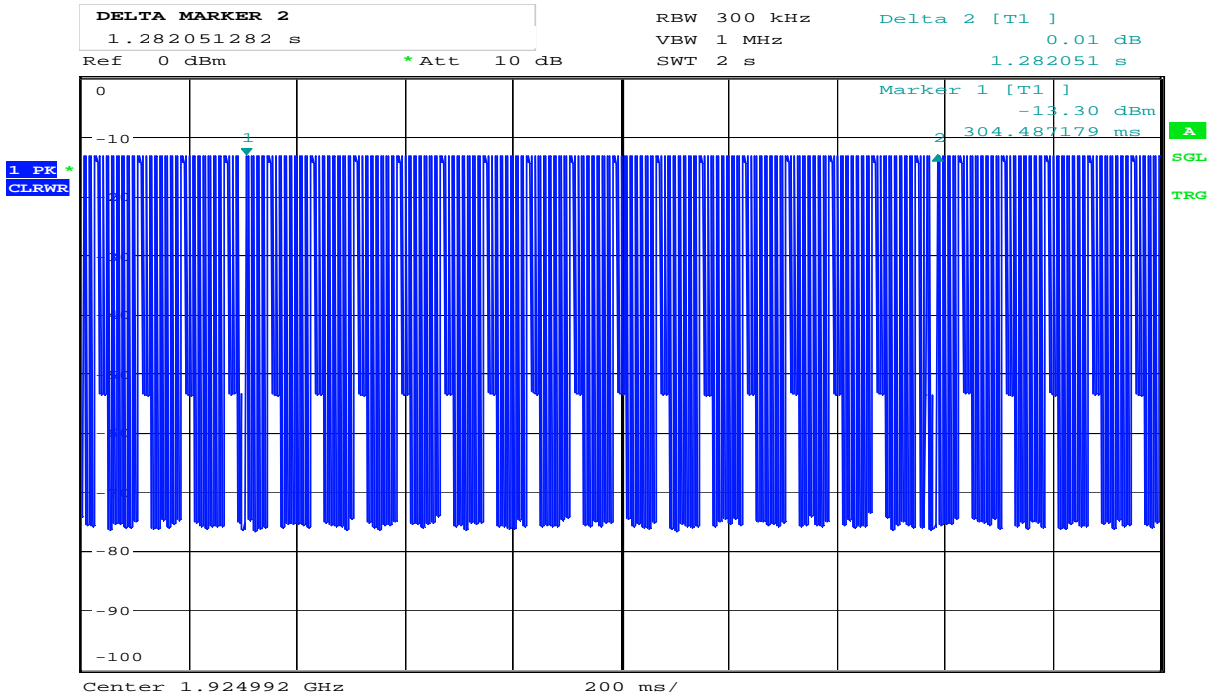

Date: 28.NOV.2011 17:46:25

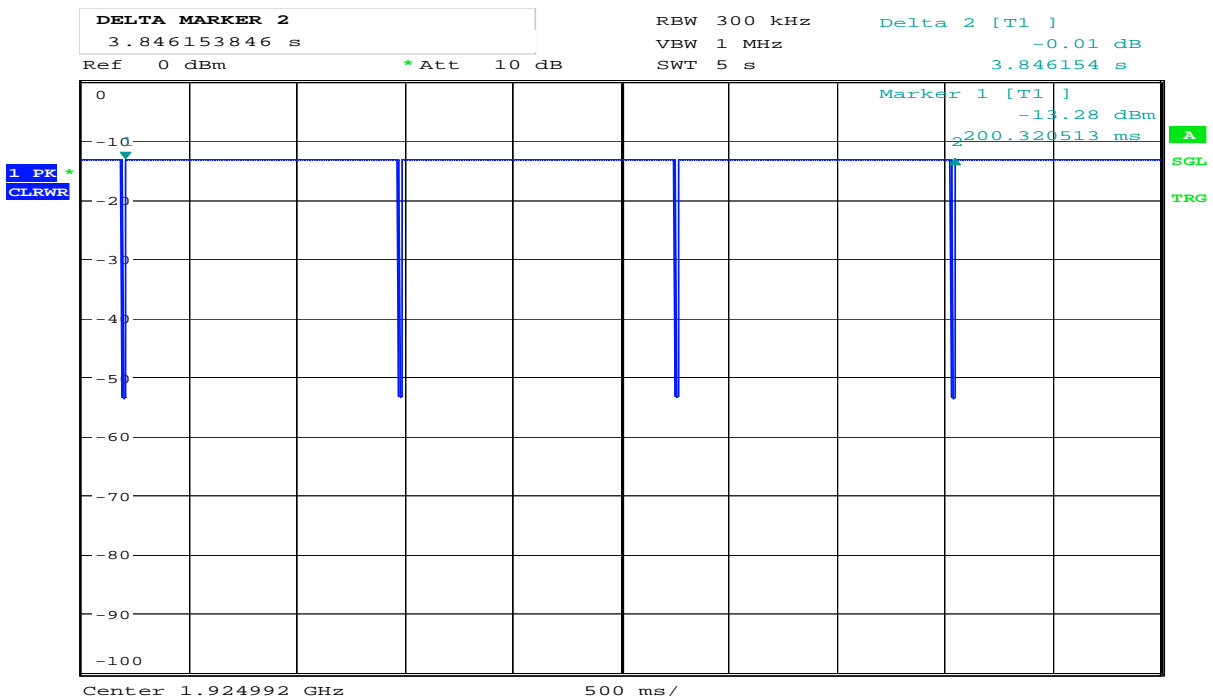

Date: 28.NOV.2011 17:47:09

### 8.1.1b) Access Criteria check Interval

## 4.20 Acknowledgements and Transmission Duration

### Measurement Procedure:

Acknowledgements: ANSI C63.17, clause 8.2.1

Transmission Duration: ANSI C63.17, clause 8.2.2

During the test **Initial transmission without acknowledgements** the signal from the EUT to the companion device is blocked by circulators in addition to the tunable attenuator.

The test **Transmission time after loss of acknowledgements** is performed by cutting-off the signal from the companion device by a RF switch and measuring the time until the EUT stops transmitting.

The **Transmission Duration** test is performed by monitoring the slot in use and measuring the time until the EUT changes to a different slot.

### Test Results:

#### Acknowledgements

Test ref. to ANSI C63.17 clause 8.2.1	Observation	Verdict
a) Initial transmission without acknowledgements	0.36 sec	Pass
c) Transmission time after loss of acknowledgements	5.0 sec	Pass

#### Transmission Duration

Test ref. to ANSI C63.17 clause 8.2.2	Observation	Verdict
b) Transmission duration on same time and frequency window	3.0 hour	Pass

Comment: /

### Limits, FCC 15.323(c)(3) and (4)

Occupation of the same combined time and spectrum windows by a device or group of cooperating devices continuously over a period of time longer than 8 hours is not permitted without repeating the access criteria.

Once access to specific combined time and spectrum windows is obtained an acknowledgement from a system participant must be received by the initiating transmitter within one second or transmission must cease.

Periodic acknowledgements must be received at least every 30 seconds or transmission must cease. Channels used exclusively for control and signaling information may transmit continuously for 30 seconds without receiving an acknowledgement, at which time the access criteria must be repeated.

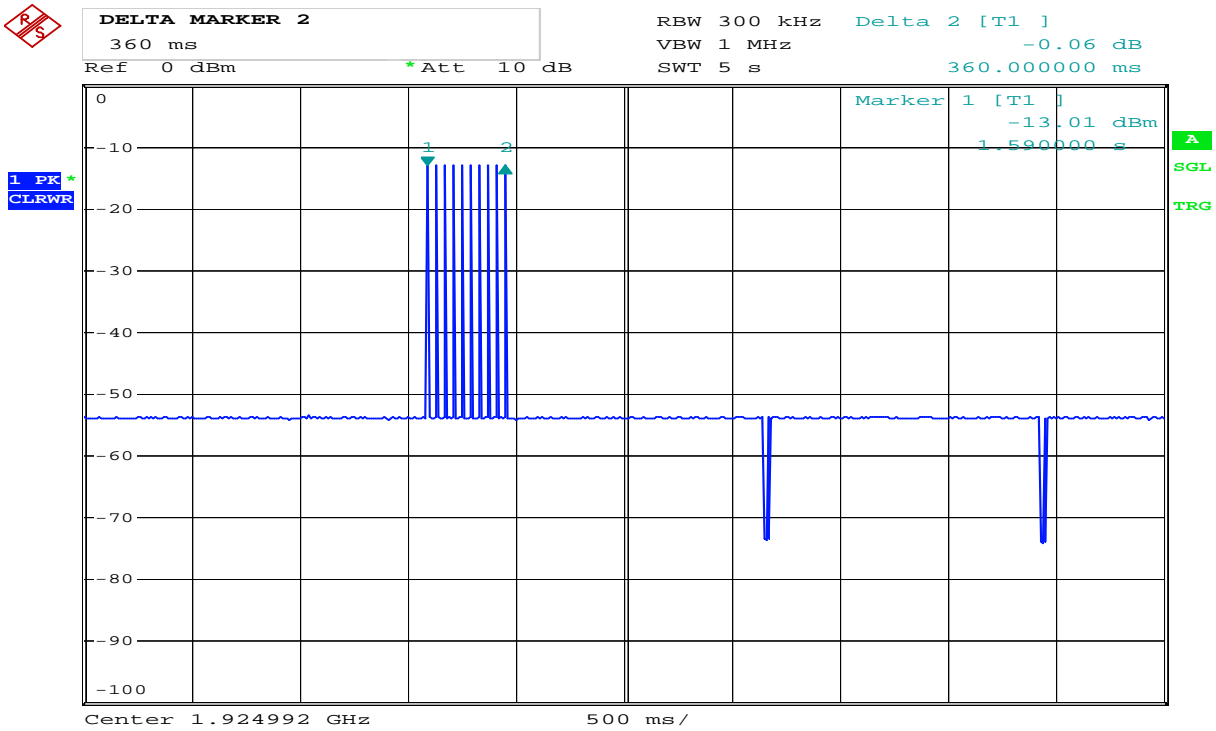

Date: 30.NOV.2011 13:20:34

### 8.2.1a) Transmission Without Initial Acknowledgement

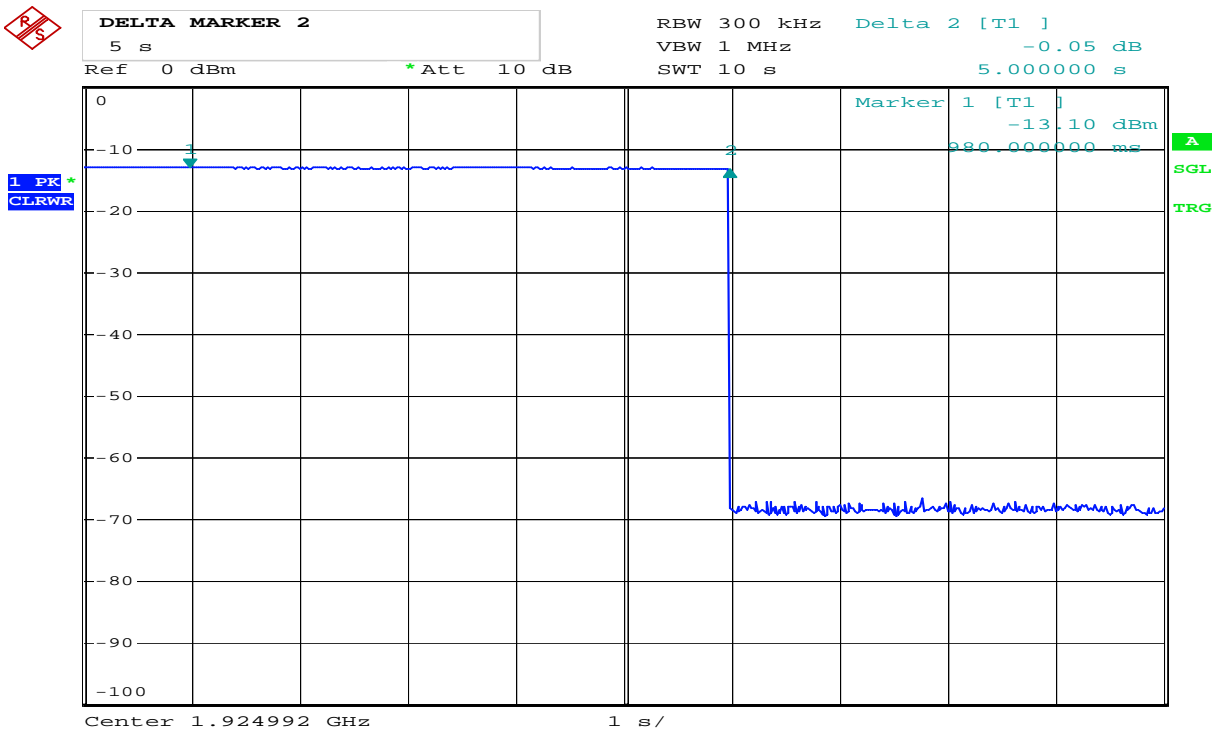

Date: 30.NOV.2011 13:27:47

### 8.2.1c) Transmission Time After Loss of Acknowledgement

## 4.21 Dual Access Criteria Check

### Measurement Procedure:

EUTs that does not implement the Upper Threshold: ANSI C63.17, clause 8.3.1

EUTs that implement the Upper Threshold: ANSI C63.17, clause 8.3.2

This test is required for equipment that uses the access criteria in FCC 15.323(c)(10).

### Test Results:

#### EUTs that do NOT Implement the Upper Threshold:

Test ref. to ANSI C63.17 clause 8.3.1	Observation	Verdict
b) EUT is restricted to a single carrier $f_i$ for TDMA systems. The Test is Pass if EUT can transmit	EUT can transmit	Pass
c) d) No transmissions on interference-free <b>receive</b> time/spectrum window. All transmit slots blocked.	EUT does not set up a link to the Base station	Pass
e) f) No transmission on interference-free <b>transmit</b> time/spectrum window. All receive slots blocked.	EUT does not set up a link to the Base station	Pass

Comment: Tests above were performed with long slot. See plots.

#### EUTs that Implements the Upper Threshold:

Test ref. to ANSI C63.17 clause 8.3.2	Observation	Verdict
b) EUT is restricted to a single carrier $f_i$ for TDMA systems. The Test is Pass if EUT can transmit	EUT can transmit	Pass
c) d) Transmission on interference-free <b>receive</b> time/spectrum window	EUT transmits on interference free <b>receive</b> slot	Pass
e) f) Transmission on interference-free <b>transmit</b> time/spectrum window	EUT transmits on interference free <b>transmit</b> slot	Pass
g) Transmission not possible on any time/spectrum window	No connection possible	Pass

Comment: See plots.

### Limits, FCC 15.323(c)(10)

An initiating device may attempt to establish a duplex connection by monitoring both its intended transmit and receive time and spectrum windows. If both the intended transmit and receive time and spectrum windows meet the access criteria, then the initiating device can initiate a transmission in the intended transmit time and spectrum window. If the power detected by the responding device can be decoded as a duplex connection signal from the initiating device, then the responding device may immediately begin transmitting on the receive time and spectrum window monitored by the initiating device.

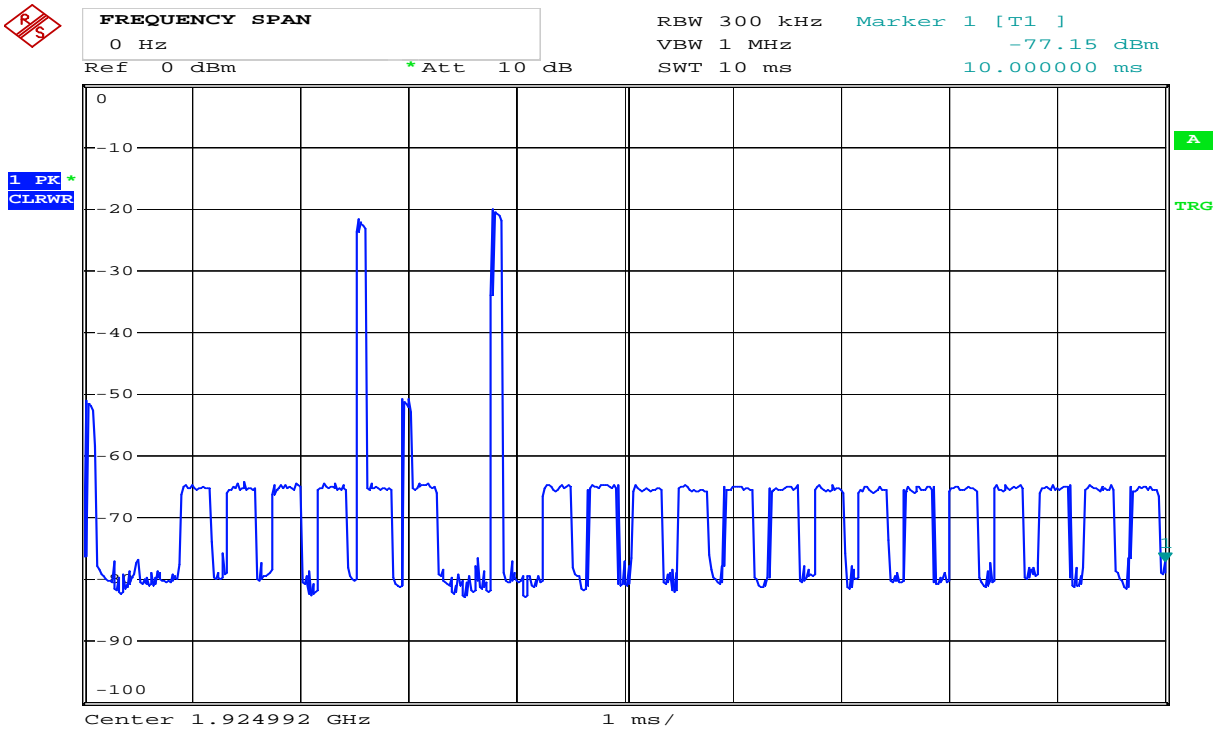

Date: 10.FEB.2012 12:03:17

**8.3.1c) No transmissions, all TRANSMIT slots blocked**

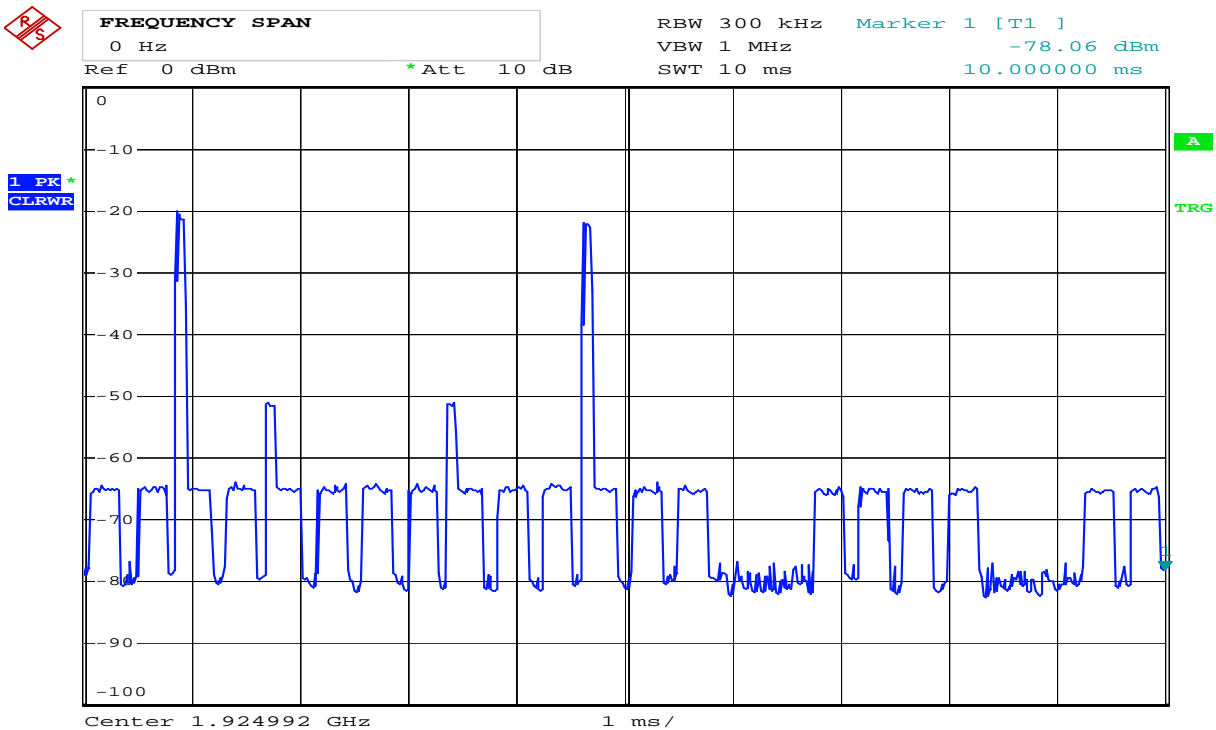

Date: 10.FEB.2012 12:05:09

**8.3.1e) No transmissions, all RECEIVE slots blocked**

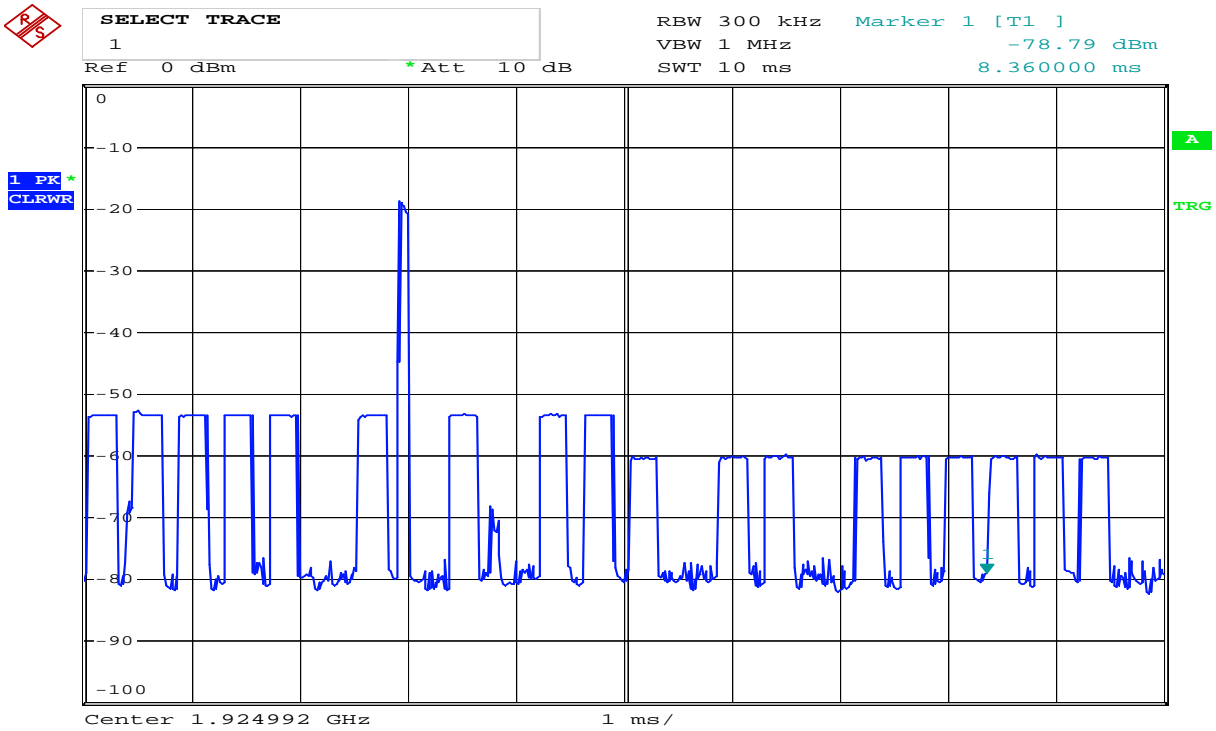

Date: 30.NOV.2011 15:09:23

**8.3.2c) EUT Transmits on Interference Free RECEIVE Slot, BEFORE**

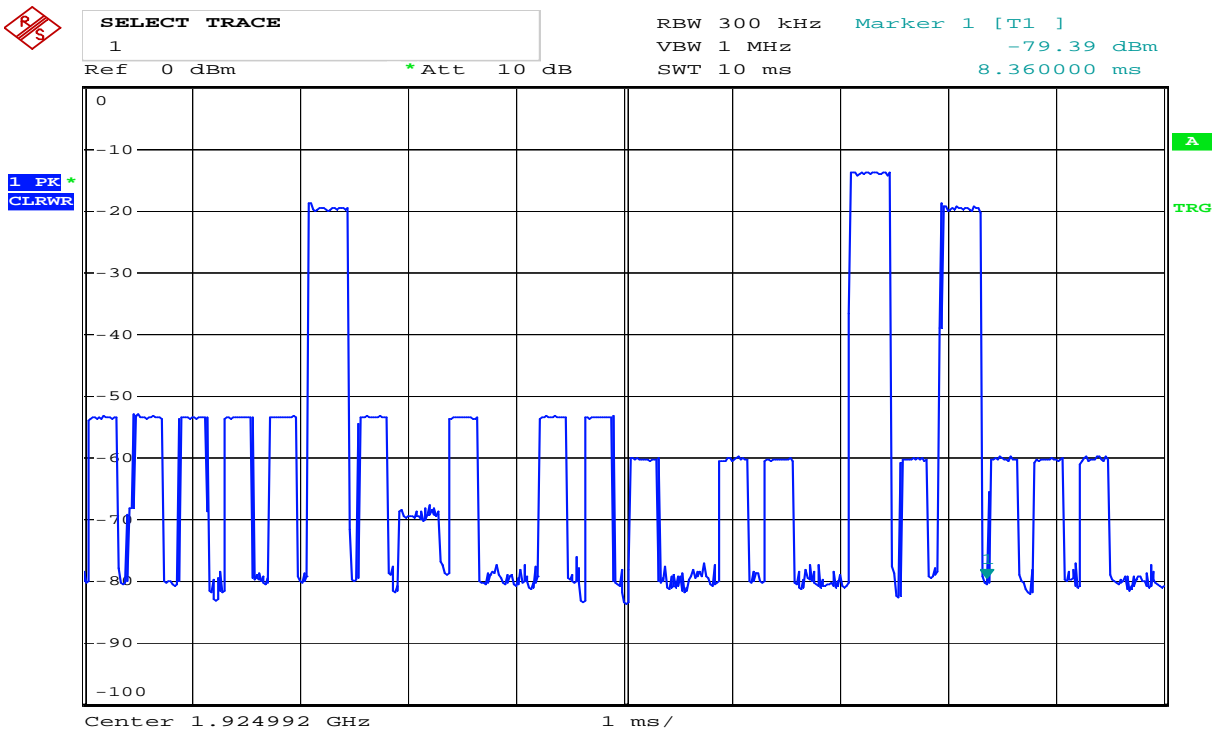

Date: 30.NOV.2011 15:09:49

**8.3.2c) EUT Transmits on Interference Free RECEIVE Slot, AFTER**

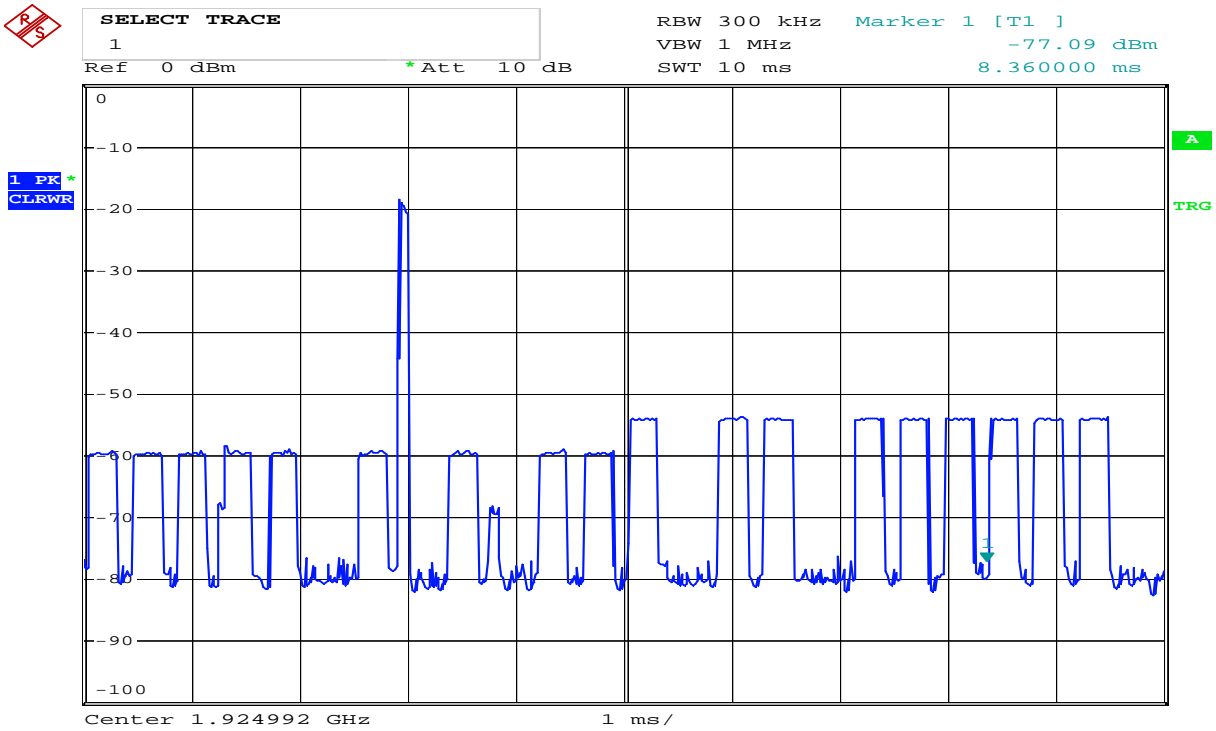

Date: 30.NOV.2011 15:05:01

**8.3.2e) EUT Transmits on Interference Free TRANSMIT Slot, BEFORE**

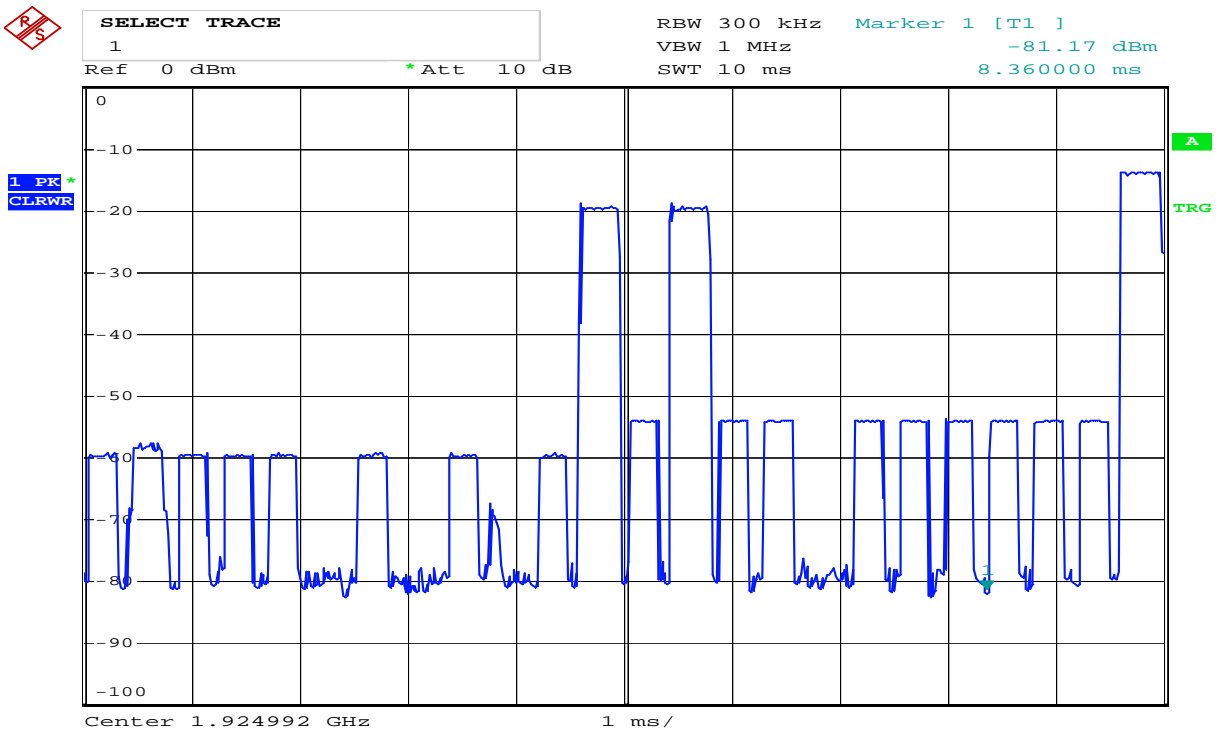

Date: 30.NOV.2011 15:05:16

**8.3.2e) EUT Transmits on Interference Free TRANSMIT Slot, AFTER**



SELECT TRACE  
1  
Ref 0 dBm \*Att 10 dB

RBW 300 kHz Marker 1 [T1 ]  
VBW 1 MHz -80.17 dBm  
SWT 10 ms 8.360000 ms

1 PK \*  
CLRWR

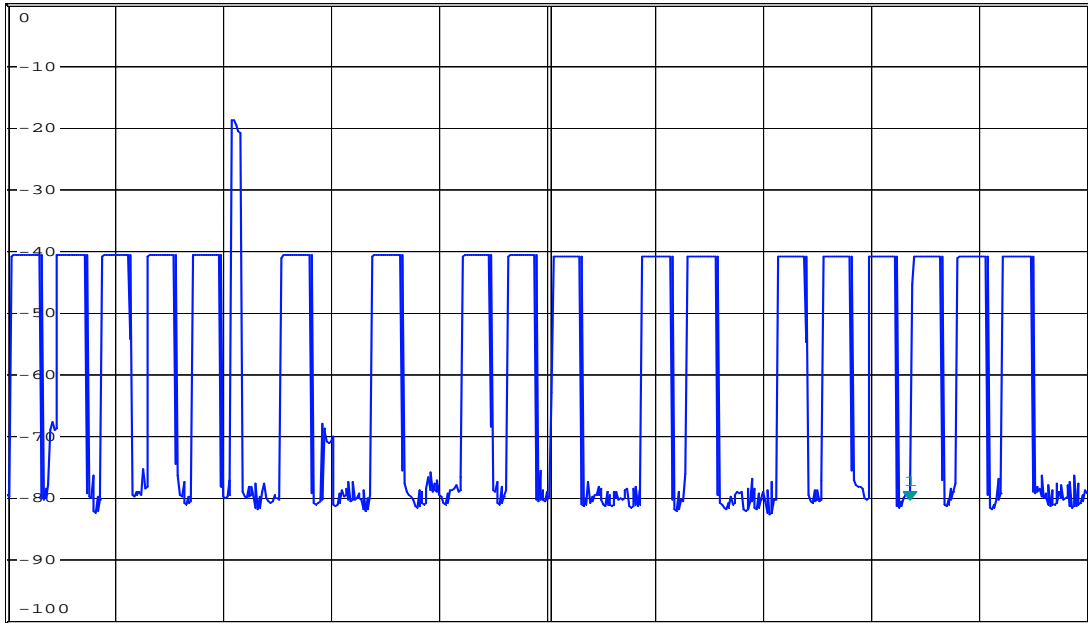

Center 1.924992 GHz 1 ms/

Date: 30.NOV.2011 15:10:49

**8.3.2g) No Connection**



#### 4.22 Alternative Monitoring Interval

Test procedure described in ANSI C63.17 clause 8.4.

This test is required if the EUT implements the provisions of FCC 15.323(c)(11).

**Test result:**

Not Tested. The tested EUT does not implement this provision. See manufacturers' declaration.

## 5 Test Setups

### 5.1 Frequency Measurements



Test equipment included: 5, 9, 28

#### Test Set-up 1

This setup is used for measuring Carrier frequency stability at normal and extreme temperatures.

The EUT was in loopback-mode and was controlled with the CMD60 for this test. The modulation pattern was set to 01010101...

### 5.2 Timing Measurements

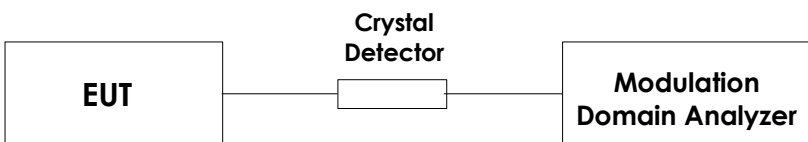

Test equipment included: 5, 7, 9, 28

#### Test Set-up 2

This setup is used for measuring Frame repetition stability, Frame period and Jitter.

The EUT was in loopback-mode and was controlled with the CMD60 for this test. The modulation pattern was set to 01010101...

### 5.3 Conducted Emission Test

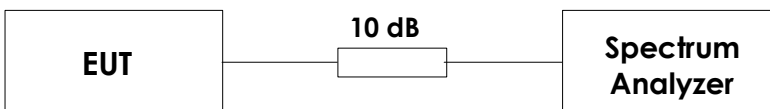

Test equipment included: 1, 7, 26, 28

#### Test Set-up 3

This setup is used for all conducted emission tests.

The EUT was in loopback-mode and was controlled with the CMD60 for this test. The modulation pattern was set to Pseudo-Random bit sequence to simulate normal speech.

## 5.4 Power Line Conducted Emissions Test

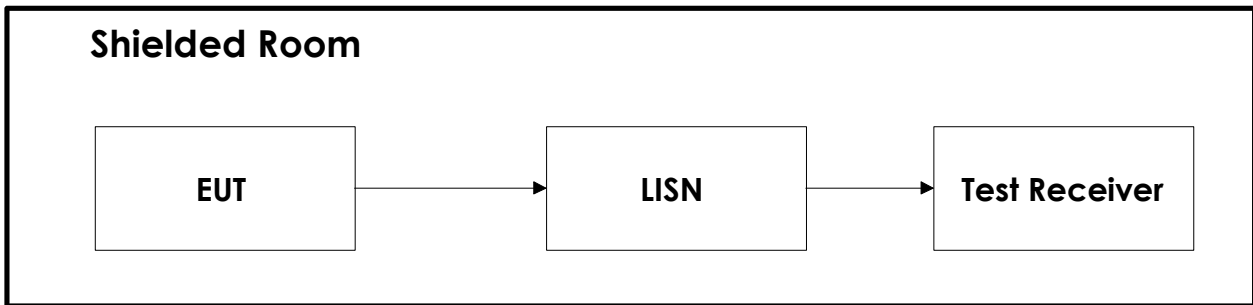

Test equipment: 8, 17, 18, 22, 27

### Test Set-Up 5

## 5.5 Monitoring Tests

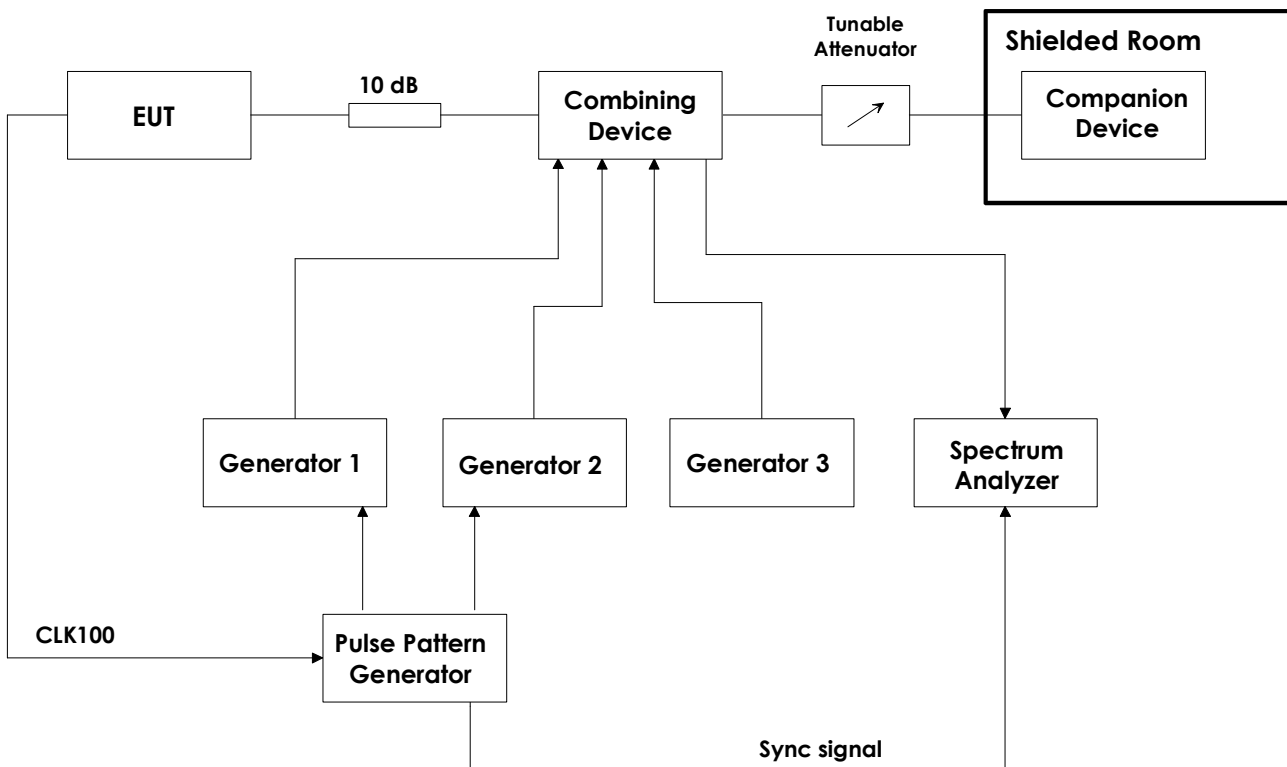

Test equipment: 1, 2, 3, 4, 6, 9, 10, 11, 12, 13, 14, 15, 19, 23, 24, 25, 26

### Test Set-Up 6

This test setup is used for all Monitoring and Time and Spectrum Access Procedure tests. The path loss from the signal generators to the EUT is measured with a power meter before the testing is started.

The CLK100 is used to synchronize the Pulse-/ Pattern generator to the start of the DECT frame, this signal always comes from the base station. If the EUT is a DECT Portable Part (i.e. a handset) the CLK100 signal will come from the Companion Device.

The sync signal to the Spectrum Analyzer is the CLK100 signal that is regenerated in the Pulse-/ Pattern Generator, this is used to synchronize the Spectrum Analyzer to the DECT frame when in zero span. The Pulse-/ Pattern Generator is used for tests that require time synchronized pulses or blocking of specific time slots.

## 5.6 Radiated Emissions Test, Fully Anechoic Chamber

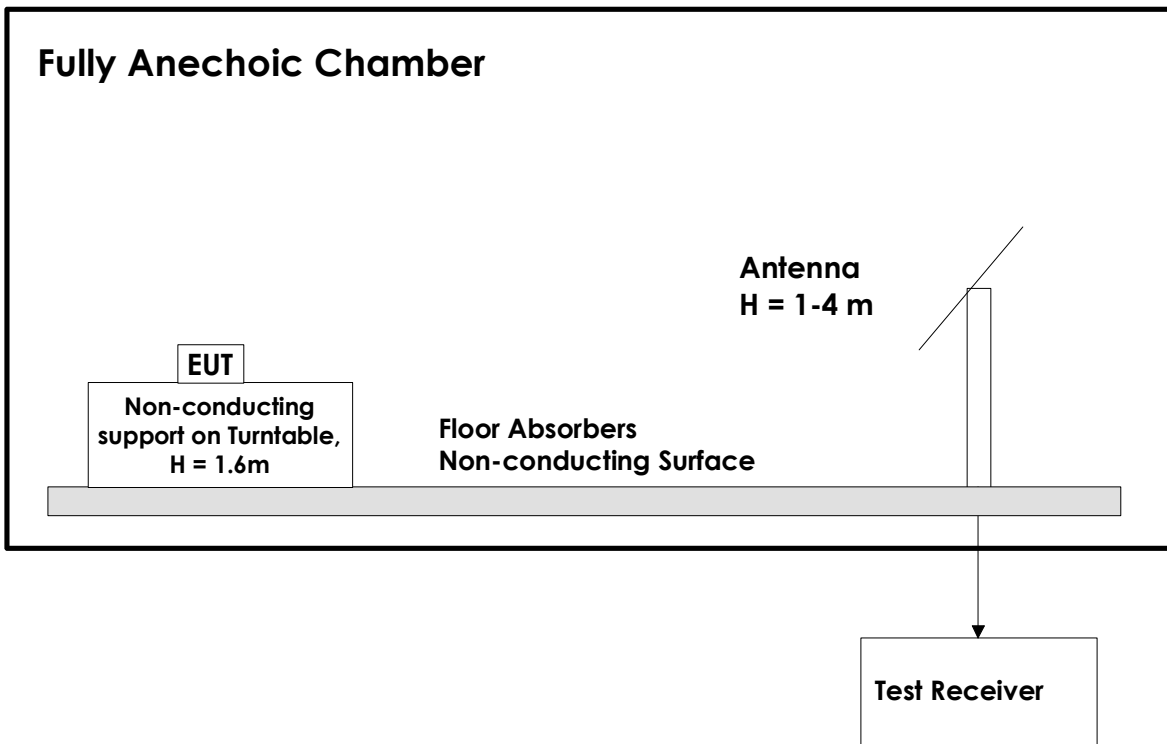

Test equipment: 1, 16, 19, 21, 22, 28, 29, 30

### Test Set-Up 7

This test setup is used for measuring radiated output power. The measurements are performed in a 3m Fully Anechoic Chamber with a Spectrum Analyzer and Horn Antenna, a preamplifier may be used after the antenna. The measuring distance is 3m.

## 6 Test Equipment Used

To facilitate inclusion on each page of the test equipment used for related tests, each item of test equipment and ancillaries are identified (numbered) by the Testhouse.

No.	Model number	Description	Manufacturer	Ref. no.	Cal. date	Cal. Due
1	FSU26	Spectrum Analyzer	Rohde & Schwarz	LR 1504	2011.11.03	2013.11.03
2	SME03	Signal generator	Rohde & Schwarz	LR 1238	2011.04.11	2013.04.11
3	SMIQ03B	Signal generator	Rohde & Schwarz	LR 1516	2010.04.21	2012.04.21
4	SMP22	Signal generator	Rohde & Schwarz	LR 1287	Cal b4 use	
5	53310A	Modulation Domain Analyzer	Hewlett Packard	LR 1483	Cal b4 use	
6	81104A	Pulse-/ Pattern Generator	Agilent	LR 1502	2011.04.12	2012.04.12
7	8470B	Crystal Detector	Hewlett Packard	LR 1207	N/A	
8	ESHS10	Measuring Receiver	Rohde & Schwarz	N- 3528	2011-06	2012-06
9	6810.17B	Attenuator	Suhner	LR1212	2010.09.15	2012.09.15
10	745-69	Step Attenuator	Narda	LR 1442	2011.10.19	2013.10.19
11	WE 1506A	Power Splitter	Weinchel	LR 244	Cal b4 use	
12	WE 1506A	Power Splitter	Weinchel	LR 245	Cal b4 use	
13	H-9	Hybrid	Anzac	LR 86	Cal b4 use	
14	H-9	Hybrid	Anzac	LR 257	Cal b4 use	
15	S212DS	RF Switch	Narda	LR 1244	N/A	
16	3115	Double Ridged Horn Antenna	EMCO	LR 1226	N/A	
17	ESH3-Z5	Two Line V-Network	Rohde & Schwarz	LR 1076	2011.11.03	2013.11.03
18	80S	Signal Generator	Powertron	LT 502	Cal b4 use	
19	6812B	AC Power Source	Agilent	LR 1515	2011.04.13	2012.04.13
20	FSP30	Spectrum Analyzer	Rohde & Schwarz	LR 1551	2011-03	2012-2
21	JS4	Pre-Amplifier	Miteq	LR 1552	2011.09.28	2012.09.28
22	Model 87 V	Multimeter	Fluke	LR 1600	2010.12.15	2012.12.15
23	87H35-1	Circulator	Racal-MESL	s.no.: 140	N/A	
24	87H35-1	Circulator	Racal-MESL	s.no.: 141	N/A	
25	87H35-1	Circulator	Racal-MESL	s.no.: 142	N/A	
26	U2000A	USB Power Sensor	Agilent	LR 1523	2011.03.26	2012.03.26
27	ESH3-Z2	Pulse Limiter	Rohde & Schwarz	LR 1074	2010.03.03	2012.03.03
28	CMD60	DECT Tester	Rohde & Schwarz	LR 1335	2010.06.09	2012.06.09
29	Model 7200	Signal generator	Gigatronics	LR 1188	2010.11.02	2012.11.02
30	3115	Double Ridged Horn Antenna	EMCO	LR 1330	2010.08.05	2013.08.05