

FCC PART 15D
MEASUREMENT AND TEST REPORT

For

RTX Hong Kong Ltd.

8/F Corporation Square, 8 Lam Lok Street, Kowloon Bay, Hong Kong

FCC ID: T7HCT8830

Report Type: Original Report	Product Type: DECT and BT IP65 handset
Test Engineer: <u>Gardon Zhang</u>	<i>Gardon Zhang</i>
Report Number: <u>RSZ140610006-00A</u>	
Report Date: <u>2014-08-04</u>	
Reviewed By: <u>Jimmy Xiao</u> RF Engineer	<i>Jimmy Xiao</i>
Prepared By:	Bay Area Compliance Laboratories Corp. (Shenzhen) 6/F, the 3rd Phase of WanLi Industrial Building ShiHua Road, FuTian Free Trade Zone Shenzhen, Guangdong, China Tel: +86-755-33320018 Fax: +86-755-33320008 www.baclcorp.com.cn

Note: This test report is prepared for the customer shown above and for the equipment described herein. It may not be duplicated or used in part without prior written consent from Bay Area Compliance Laboratories Corp.

TABLE OF CONTENTS

GENERAL INFORMATION.....	4
PRODUCT DESCRIPTION FOR EQUIPMENT UNDER TEST (EUT).....	4
OBJECTIVE.....	4
RELATED SUBMITTAL(S)/GRANT(S).....	4
TEST METHODOLOGY.....	4
TEST FACILITY.....	5
SYSTEM TEST CONFIGURATION.....	6
DESCRIPTION OF TEST CONFIGURATION.....	6
EQUIPMENT MODIFICATIONS.....	6
LOCAL SUPPORT EQUIPMENT LIST AND DETAILS.....	6
EXTERNAL I/O CABLE.....	6
BLOCK DIAGRAM OF TEST SETUP.....	7
SUMMARY OF TEST RESULTS.....	8
FCC §15. 319 (I) & §2.1093 - RF EXPOSURE.....	9
APPLICABLE STANDARD.....	9
FCC§15.317&§15.203 - ANTENNA REQUIREMENT.....	10
APPLICABLE STANDARD.....	10
ANTENNA CONNECTOR CONSTRUCTION.....	10
FCC§15.315 & §15.207 - CONDUCTED EMISSIONS.....	11
APPLICABLE STANDARD.....	11
MEASUREMENT UNCERTAINTY.....	11
EUT SETUP.....	11
EMI TEST RECEIVER SETUP.....	12
TEST PROCEDURE.....	12
TEST EQUIPMENT LIST AND DETAILS.....	12
TEST RESULTS SUMMARY.....	13
TEST DATA.....	13
FCC§15.323 (A) - EMISSION BANDWIDTH.....	16
APPLICABLE STANDARD.....	16
TEST PROCEDURE.....	16
TEST EQUIPMENT LIST AND DETAILS.....	16
TEST DATA.....	17
FCC§15.319 (C) - PEAK TRANSMIT POWER.....	19
APPLICABLE STANDARD.....	19
TEST PROCEDURE.....	19
TEST EQUIPMENT LIST AND DETAILS.....	19
TEST DATA.....	20
FCC§15.319 (D) - POWER SPECTRAL DENSITY.....	22
APPLICABLE STANDARD.....	22
TEST PROCEDURE.....	22
TEST EQUIPMENT LIST AND DETAILS.....	22
TEST DATA.....	22

FCC§15.323 (D) - EMISSION INSIDE AND OUTSIDE THE SUB-BAND.....27

 APPLICABLE STANDARD27

 TEST PROCEDURE27

 TEST EQUIPMENT LIST AND DETAILS.....27

 TEST DATA27

FCC§15.319 (G) - RADIATED EMISSIONS.....37

 APPLICABLE STANDARD37

 MEASUREMENT UNCERTAINTY.....37

 EUT SETUP37

 EMI TEST RECEIVER & SPECTRUM ANALYZER SETUP38

 TEST PROCEDURE38

 TEST EQUIPMENT LIST AND DETAILS.....38

 CORRECTED AMPLITUDE & MARGIN CALCULATION39

 TEST RESULTS SUMMARY39

 TEST DATA39

FCC§15.323 (F) - FREQUENCY STABILITY.....44

 APPLICABLE STANDARD44

 TEST PROCEDURE44

 TEST EQUIPMENT LIST AND DETAILS.....44

 TEST DATA45

FCC§15.323 (C) (E) & §15.319(F) – SPECIFIC REQUIREMENTS FOR UPCS DEVICE.....46

 APPLICABLE STANDARD46

 TEST PROCEDURE46

 TEST EQUIPMENT LIST AND DETAILS.....46

 TEST DATA47

 1) AUTOMATIC DISCONTINUATION OF TRANSMISSION, FCC §15.319(F)47

 2) MONITORING TIME, FCC §15.323(c) (1)47

 3) LOWER MONITORING THRESHOLD, FCC §15.323(c) (2)48

 4) MAXIMUM TRANSMIT PERIOD, FCC §15.323(c) (3)48

 5) SYSTEM ACKNOWLEDGEMENT, FCC §15.323(c) (4)49

 6) LEAST INTERFERED CHANNEL (LIC), FCC §15.323(c) (5)49

 7) RANDOM WAITING, FCC §15.323(c) (6)52

 8) MONITORING BANDWIDTH AND REACTION TIME, FCC §15.323(c) (7)52

 9) MONITORING ANTENNA, FCC §15.323(c) (8)53

 10) MONITORING THRESHOLD RELAXATION, FCC §15.323(c) (9)53

 11) DUPLEX CONNECTIONS, FCC §15.323(c) (10).....54

 12) ALTERNATIVE MONITORING INTERVAL, FCC §15.323(c) (11).....55

 13) FAIR ACCESS, FCC §15.323(c) (12)56

 14) FRAME REPETITION STABILITY FRAME PERIOD AND JITTER, FCC§15.323 (B)56

GENERAL INFORMATION

Product Description for Equipment under Test (EUT)

The *RTX Hong Kong Ltd's* product, model number: *RTX8830 Handset (FCC ID: T7HCT8830)* or the "EUT" in this report was a *DECT and BT IP65 handset*, which was measured approximately: 15.2 cm (L) x 5.0 cm (W) x 4.0 cm (H), rated with input voltage: DC 3.7V battery or DC 5.5V from adapter.

Adapter information: SWITCHING POWER SUPPLY

Model: S008CM0550060

Input: AC 100-240V, 50/60Hz, 250mA

Output: DC5.5V, 600mA

** All measurement and test data in this report was gathered from production sample serial number: 1423000136 (Assigned by applicant). The EUT supplied by the applicant was received on 2014-06-10.*

Objective

This test report was based on the Electromagnetic Interference (EMI) tests performed on the EUT. The EMI measurements were performed according to the measurement procedure described in ANSI C63.17 - 2006 and ANSI C63.4-2009.

The tests were performed in order to determine the compliance of the EUT with FCC Part 15-Subpart D, section 15.203, 15.315, 15.317, 15.319 and 15.323 rules.

Related Submittal(s)/Grant(s)

FCC part 15.247 DSS submission with FCC ID: T7HCT8830.

Test Methodology

All measurements contained in this report were conducted with ANSI C63.17 - 2006, American National Standard for Methods of Measurement of Radio-Noise Emissions from Low-Voltage Electrical and Electronic Equipment in the range of 9 kHz to 40 GHz. All radiated and conducted emissions measurement was performed at Bay Area Compliance Laboratories Corp. (Shenzhen).

The radiated testing was performed at an antenna-to-EUT distance of 3 meters.

Measurement uncertainty with radiated emission is 5.91 dB for 30MHz-1GHz, and 4.92 dB for above 1GHz, 1.95dB for conducted measurement.

Test Facility

The test site used by Bay Area Compliance Laboratories Corp. (Shenzhen) to collect test data is located on the 6/F, the 3rd Phase of WanLi Industrial Building, ShiHua Road, FuTian Free Trade Zone Shenzhen, Guangdong, China.

Test site at Bay Area Compliance Laboratories Corp. (Shenzhen) has been fully described in reports submitted to the Federal Communication Commission (FCC). The details of these reports have been found to be in compliance with the requirements of Section 2.948 of the FCC Rules on December 06, 2010. The facility also complies with the radiated and AC line conducted test site criteria set forth in ANSI C63.4-2009.

The Federal Communications Commission has the reports on file and is listed under FCC Registration No.: 382179. The test site has been approved by the FCC for public use and is listed in the FCC Public Access Link (PAL) database.

SYSTEM TEST CONFIGURATION

Description of Test Configuration

The system was configured for testing in TBR6 mode which is provided by the manufacturer.

Equipment Modifications

No modification was made to the EUT tested.

Local Support Equipment List and Details

Manufacturer	Description	Model	Serial Number
R&S	Digital Radio-Communication Tester	CMD60	829902/026
RTX	CHARGER	8630 Charger	1423000052
RTX	Adapter	S008CM0550060	/

External I/O Cable

Cable Description	Length (m)	From/Port	To
Un-shielding Un-detachable AC Cable	1.2	LISN	Socket
Un-shielding Detectable DC Power Cable	2.0	Charger	Adapter

Block Diagram of Test Setup

For Conducted Emission:

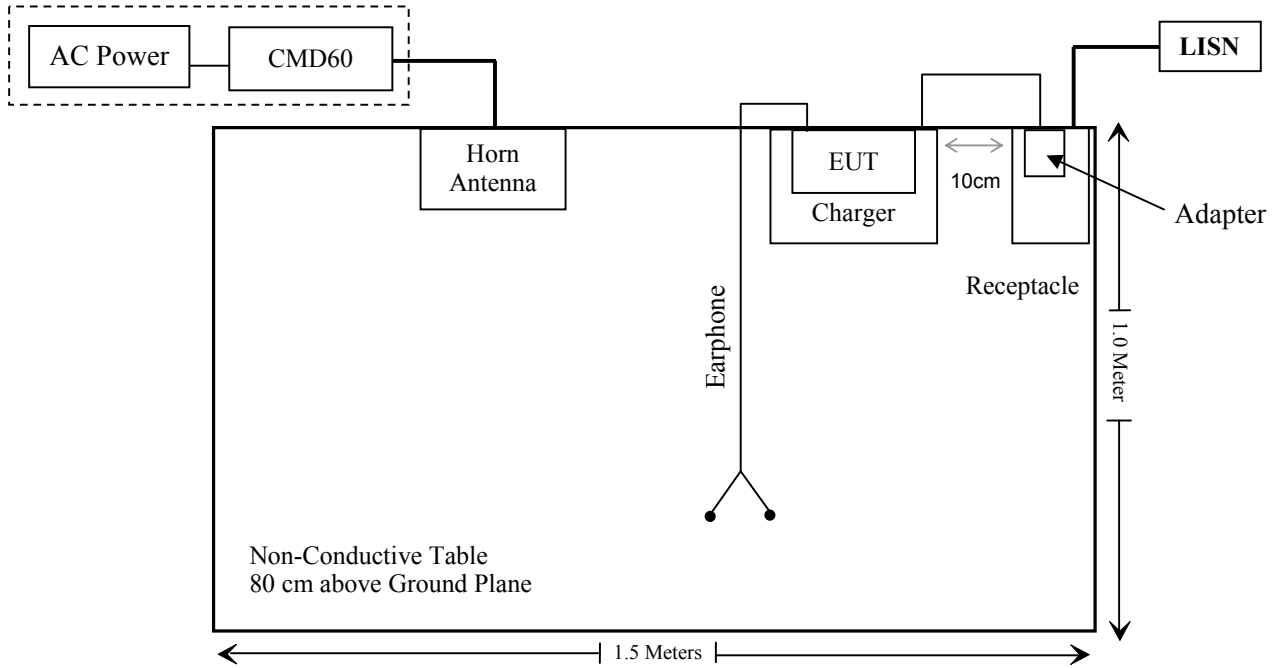

SUMMARY OF TEST RESULTS

FCC Rules	Description of Test	Result
§ 15.319 (i)&2.1093	RF Exposure	Compliance
§ 15.317 § 15.203	Antenna Requirement	Compliance
§ 15.315 § 15.207	Conducted Emission	Compliance
§ 15.323 (a)	Emission Bandwidth	Compliance
§ 15.319 (c)	Peak Transmit Power	Compliance
§ 15.319 (d)	Power Spectral Density	Compliance
§ 15.323 (d)	Emission Inside and Outside the sub-band	Compliance
§ 15.319 (g)	Radiated Emission	Compliance
§ 15.323 (f)	Frequency Stability Handset	Compliance
§ 15.323 (c)(e) § 15.319 (f)	Specific Requirements for UPCS	Compliance

FCC §15. 319 (i) & §2.1093 - RF EXPOSURE

Applicable Standard

According to FCC Part 15.319 (i), Unlicensed PCS devices are subject to the radiofrequency radiation exposure requirements specified in §1.1307(b) and 2.1093 of this chapter, as appropriate. All equipment shall be considered to operate in a “general population/uncontrolled” environment. Applications for equipment authorization of devices operating under this section must contain a statement confirming compliance with these requirements for both fundamental emissions and unwanted emissions. Technical information showing the basis for this statement must be submitted to the Commission upon request.

Result:

Please refer to SAR test report RSZ140610006-20.

FCC§15.317&§15.203 - ANTENNA REQUIREMENT

Applicable Standard

According to FCC § 15.203, an intentional radiator shall be designed to ensure that no antenna other than that furnished by the responsible party shall be used with the device. The use of a permanently attached antenna or of an antenna that uses a unique coupling to the intentional radiator shall be considered sufficient to comply with the provisions of this Section. The manufacturer may design the unit so that a broken antenna can be replaced by the user, but the use of a standard antenna jack or electrical connector is prohibited.

Antenna Connector Construction

The EUT has two monopole antennas arrangement for DECT, which was permanently attached and the gain was 1 dBi, fulfill the requirement of this section. Please refer to the internal photos.

Result: Compliant.

FCC§15.315 & §15.207 - CONDUCTED EMISSIONS

Applicable Standard

FCC§15.315, an unlicensed PCS device that is designed to be connected to the public utility (AC) power line must meet the limits specified in §15.207.

Measurement Uncertainty

Input quantities to be considered for conducted disturbance measurements maybe receiver reading, attenuation of the connection between LISN and receiver, LISN voltage division factor, LISN VDF frequency interpolation and receiver related input quantities, etc.

Based on CISPR 16-4-2:2011, the expended combined standard uncertainty of conducted disturbance test at Bay Area Compliance Laboratories Corp. (Shenzhen) is shown as below. And the uncertainty will not be taken into consideration for the test data recorded in the report

Port	Expanded Measurement uncertainty
AC Mains	3.26 dB (k=2, 95% level of confidence)
CAT 3	3.70 dB (k=2, 95% level of confidence)
CAT 5	3.86 dB (k=2, 95% level of confidence)
CAT 6	4.64 dB (k=2, 95% level of confidence)

EUT Setup

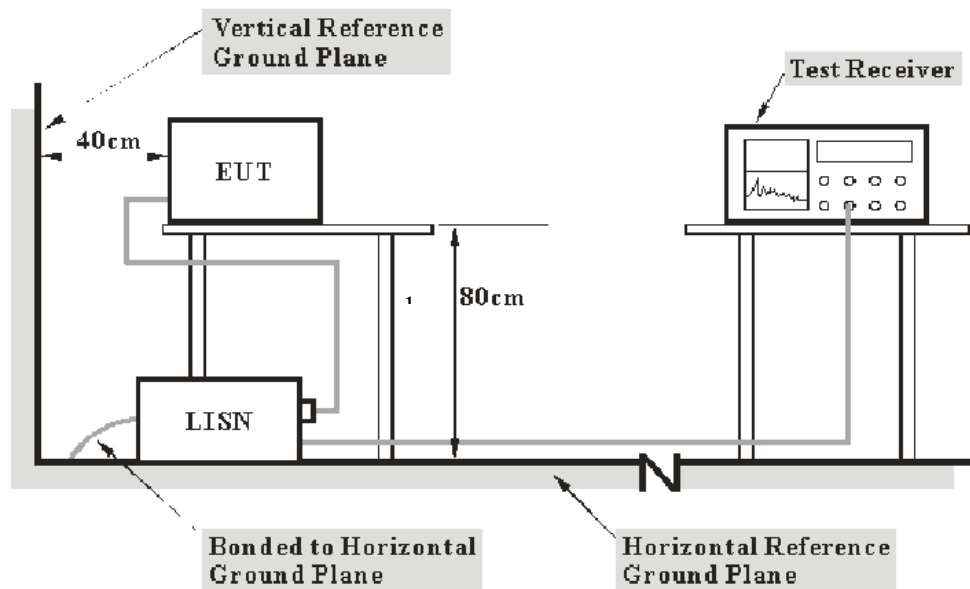

- Note: 1. Support units were connected to second LISN.
 2. Both of LISNs (AMN) 80 cm from EUT and at the least 80 cm from other units and other metal planes support units.

The setup of EUT is according with per ANSI C63.4-2009 measurement procedure. The specification used was with the FCC 15.315 and FCC 15.207 limits.

The external I/O cables were draped along the test table and formed a bundle 30 to 40 cm long in the middle.

The adapter was connected to a 120 VAC/60 Hz power source.

EMI Test Receiver Setup

The EMI test receiver was set to investigate the spectrum from 150 kHz to 30 MHz.

During the conducted emission test, the EMI test receiver was set with the following configurations:

Frequency Range	IF B/W
150 kHz – 30 MHz	9 kHz

Test Procedure

During the conducted emission test, adapter was connected to the outlet of the LISN.

Maximizing procedure was performed on the six (6) highest emissions of the EUT.

All final data was recorded in the Quasi-peak and average detection mode.

Test Equipment List and Details

Manufacturer	Description	Model	Serial Number	Calibration Date	Calibration Due Date
Rohde & Schwarz	EMI Test Receiver	ESCS30	100176	2014-06-17	2015-06-17
Rohde & Schwarz	LISN	ENV216	3560.6650.12-101613-Yb	2014-05-07	2015-05-07
Rohde & Schwarz	Transient Limiter	ESH3Z2	DE25985	2013-10-15	2014-10-15
Rohde & Schwarz	CE Test software	EMC 32	V8.53	-	-

* **Statement of Traceability:** Bay Area Compliance Laboratories Corp. (Shenzhen) attests that all calibrations have been performed in accordance to requirements, traceable to National Primary Standards and International System of Units (SI).

Corrected Factor & Margin Calculation

The Corrected factor is calculated by adding the Outlet Cable Loss, LISN Insertion Loss, Cable Loss and Transient Limiter Attenuation. The basic equation is as follows:

Correction Factor = Outlet Cable Loss + LISN Insertion Loss + Cable Loss + Transient Limiter Attenuation

The “**Margin**” column of the following data tables indicates the degree of compliance with the applicable limit. For example, a margin of 7 dB means the emission is 7 dB below the limit. The equation for margin calculation is as follows:

$$\text{Margin} = \text{Limit} - \text{Corrected Amplitude}$$

Test Results Summary

According to the recorded data in following table, the worst margin reading as bellow:

12.2 dB at 0.380330 MHz in the Line conducted mode

Refer to CISPR16-4-2:2011 and CISPR 16-4-1:2009, the measured level compliance with the limit if

$$L_m + U_{(L_m)} \leq L_{lim} + U_{cispr}$$

In BACL, $U_{(L_m)}$ is less than U_{cispr} , if L_m is less than L_{lim} , it implies that the EUT complies with the limit.

Test Data

Environmental Conditions

Temperature:	30 °C
Relative Humidity:	58 %
ATM Pressure:	101.0 kPa

The testing was performed by Simon Wang on 2014-08-04.

Test mode: Transmitting & Charging

AC 120V/60 Hz, Line

EMI Auto Test L

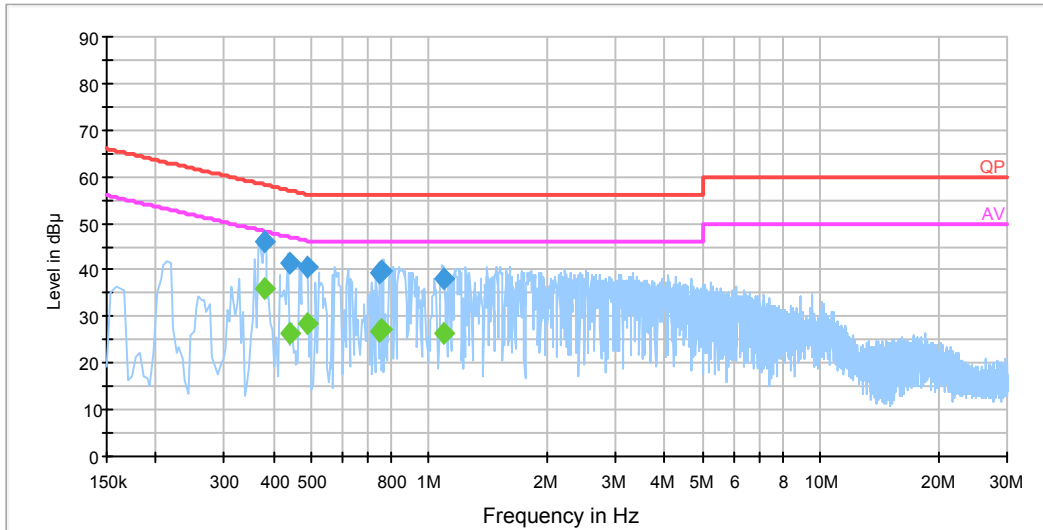

Frequency (MHz)	Corrected Amplitude (dBµV)	Corrected Factor (dB)	Limit (dBµV)	Margin (dB)	Detector (PK/QP/Ave)
0.380330	46.0	19.5	58.3	12.3	QP
0.380330	36.1	19.5	48.3	12.2	Ave.
0.439490	41.3	19.6	57.1	15.8	QP
0.439490	26.5	19.6	47.1	20.6	Ave.
0.490650	40.7	19.6	56.2	15.5	QP
0.490650	28.4	19.6	46.2	17.8	Ave.
0.750690	39.2	19.5	56.0	16.8	QP
0.750690	26.7	19.5	46.0	19.3	Ave.
0.758570	39.9	19.5	56.0	16.1	QP
0.758570	27.4	19.5	46.0	18.6	Ave.
1.085770	38.2	19.5	56.0	17.8	QP
1.085770	26.5	19.5	46.0	19.5	Ave.

AC 120V/60 Hz, Neutral

EMI Auto Test N

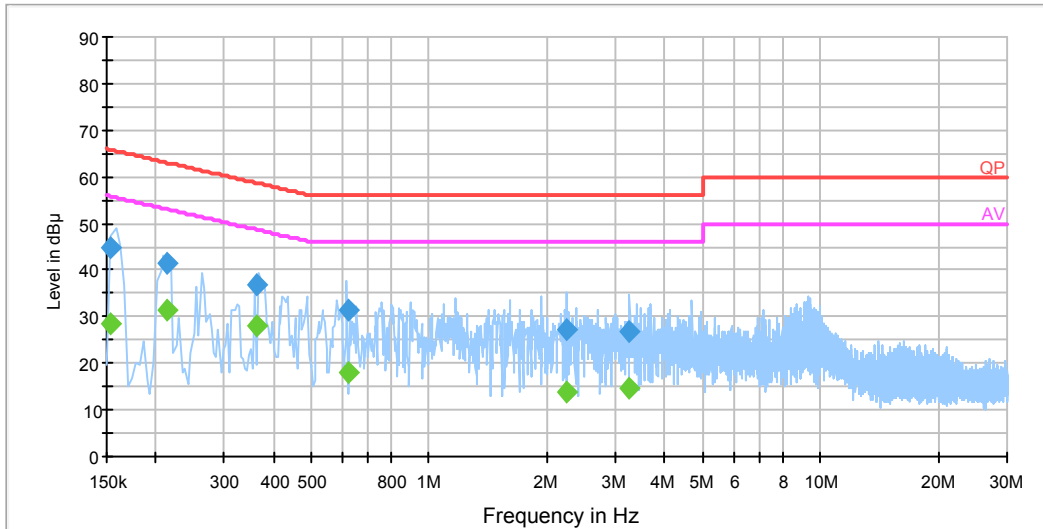

Frequency (MHz)	Corrected Amplitude (dBµV)	Corrected Factor (dB)	Limit (dBµV)	Margin (dB)	Detector (PK/QP/Ave)
0.153500	44.7	19.6	65.8	21.1	QP
0.153500	28.5	19.6	55.8	27.3	Ave.
0.213500	41.4	19.5	63.1	21.7	QP
0.213500	31.6	19.5	53.1	21.5	Ave.
0.364510	36.7	19.5	58.6	21.9	QP
0.364510	28.1	19.5	48.6	20.5	Ave.
0.620730	31.3	19.6	56.0	24.7	QP
0.620730	17.9	19.6	46.0	28.1	Ave.
2.252190	27.2	19.6	56.0	28.8	QP
2.252190	13.8	19.6	46.0	32.2	Ave.
3.261130	27.0	19.7	56.0	29.0	QP
3.261130	14.8	19.7	46.0	31.2	Ave.

Note:

- 1) Correction Factor = LISN VDF (Voltage Division Factor) + Cable Loss + Transient Limiter Attenuation
- 2) Corrected Amplitude = Reading + Correction Factor
- 3) Margin = Limit – Corrected Amplitude

FCC§15.323 (a) - EMISSION BANDWIDTH

Applicable Standard

Operation shall be contained within the 1920–1930 MHz band. The emission bandwidth shall be less than 2.5 MHz and greater than 50 kHz.

The emission bandwidth is measured in accordance with ANSI C63.17 sub-clause 6.1.3 using the setup below:

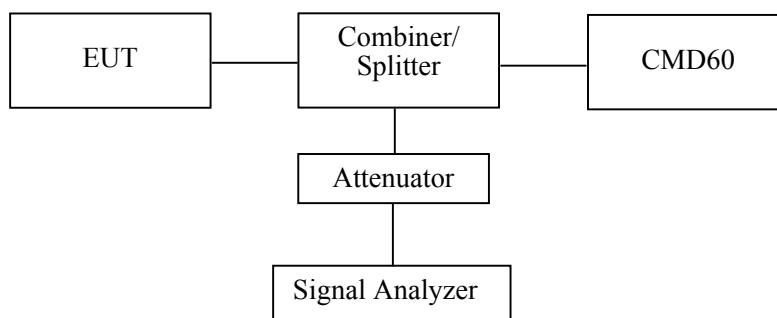

The width, in Hz, of the signal between two points, one below the carrier center frequency and one above the carrier center frequency, that is 26 dB down relative to the maximum level of the modulated carrier. It is based on the use of measurement instrumentation employing a peak detector function with an instrument resolution bandwidth approximately equal to 1% of the emission band-width of the device under measurement. [Extraction from 47 CFR 15, subpart D, 15.303 (C)].

Test Procedure

Using the manufacturer’s information on occupied bandwidth set the spectrum analyzer as follows:

Resolution bandwidth	1.0% of the emission bandwidth (as close as possible)
Video bandwidth	>3 times the resolution bandwidth
Number of sweeps	sufficient to stability the trace
Detection mode	peak detection with maximum hold

Test Equipment List and Details

Manufacturer	Description	Model	Serial Number	Calibration Date	Calibration Due Date
Rohde & Schwarz	EMI Test Receiver	ESR	1316.3003K0 3-101746-zn	2014-06-13	2015-06-13

* **Statement of Traceability:** Bay Area Compliance Laboratories Corp. (Shenzhen) attests that all calibrations have been performed in accordance to requirements that traceable to National Primary Standards and International System of Units (SI).

Test Data

Environmental Conditions

Temperature:	20 °C
Relative Humidity:	51 %
ATM Pressure:	101.0 kPa

The testing was performed by Gardon Zhang on 2014-06-18.

Test mode: Transmitting

Channel	Center Frequency (MHz)	26 dB Emission Bandwidth (MHz)	Limit
Low	1921.536	1.3025	50 kHz < OBW < 2.5 MHz
Middle	1924.992	1.3025	50 kHz < OBW < 2.5 MHz
High	1928.448	1.3025	50 kHz < OBW < 2.5 MHz

Test Result: Compliance. Please refer to the attached plots.

Low Channel

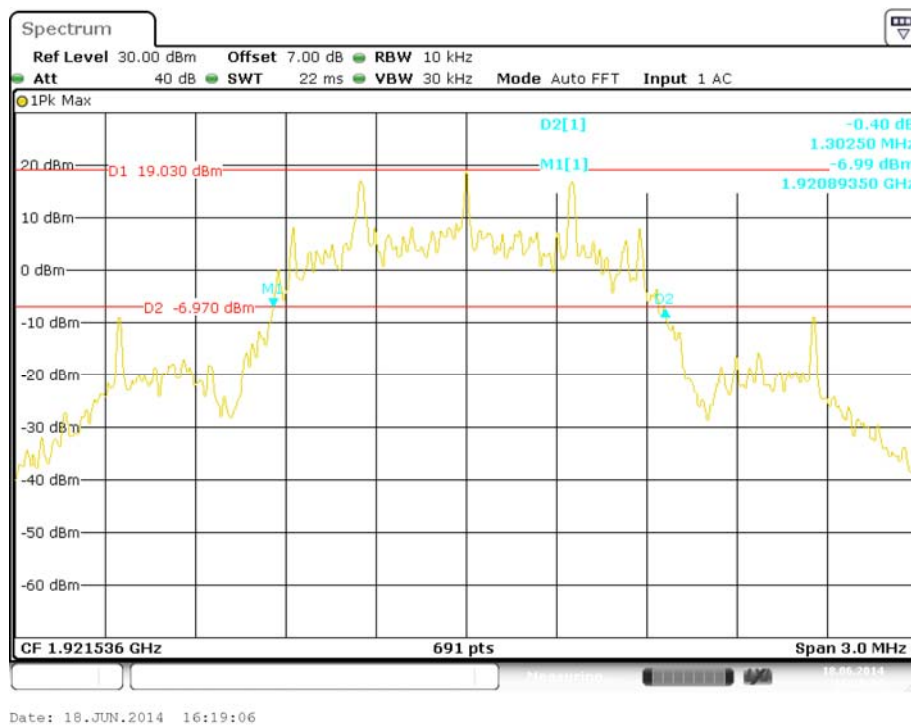

Middle Channel

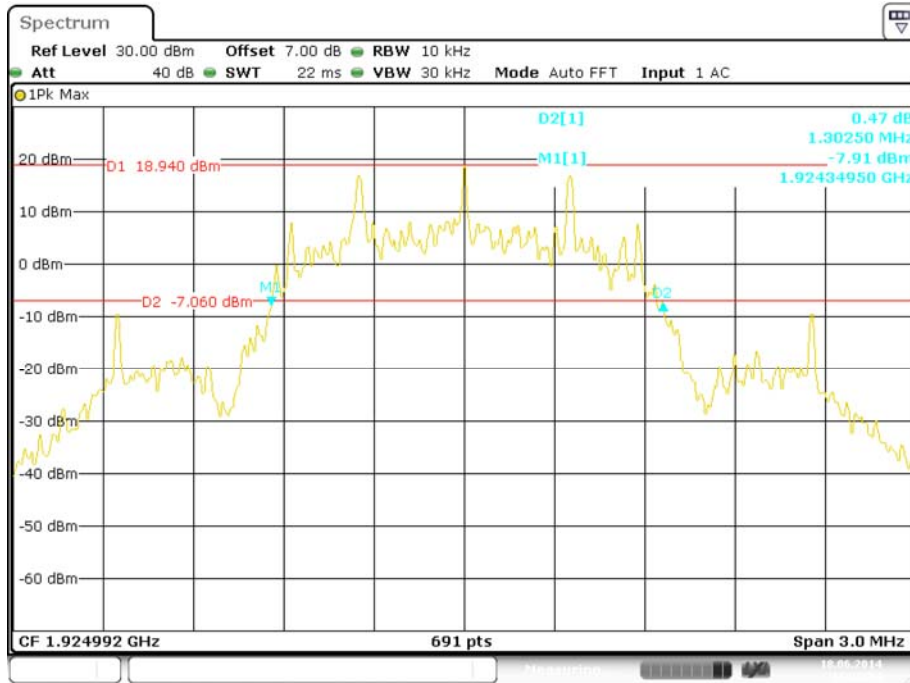

High Channel

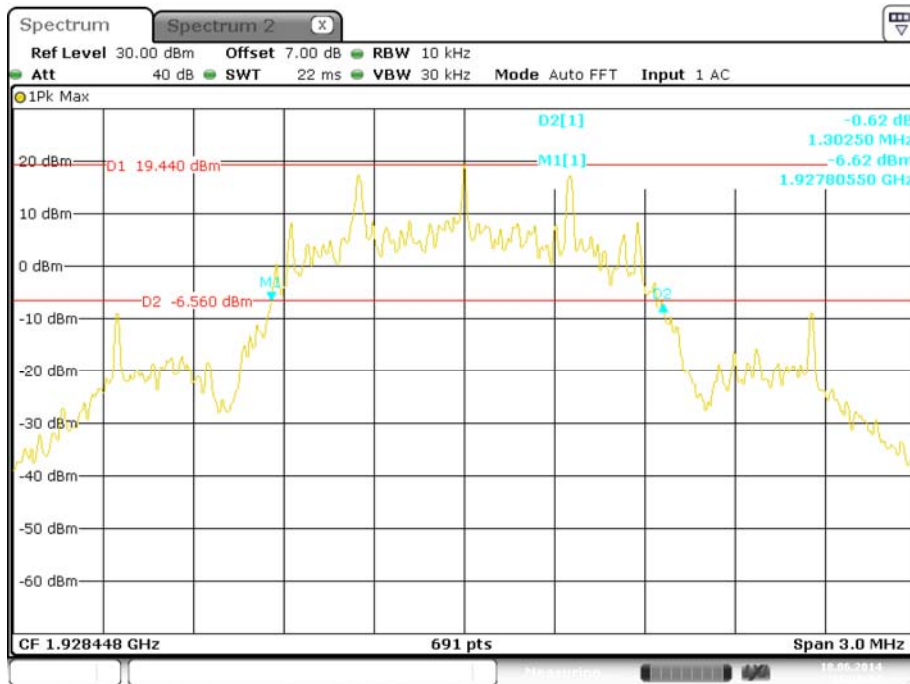

FCC§15.319 (c) - PEAK TRANSMIT POWER

Applicable Standard

The peak power output as measured over an interval of time equal to the frame rate or transmission burst of the device under all conditions of modulation. Usually this parameter is measured as a conducted emission by direct connection of a calibrated test instrument to the equipment under test. If the device cannot be connected directly, alternative techniques acceptable to the Commission may be used [47 CFR 15, subpart D, 15.303].

The peak transmit power is according to ANSI C63.17-2006 §6.1.2

Per FCC Part 15.319 (c) Peak transmit power shall not exceed 100 microwatts multiplied by the square root of the emission bandwidth in hertz. Peak transmit power must be measured over any interval of continuous transmission using instrumentation calibrated in terms of an rms-equivalent voltage. The measurement results shall be properly adjusted for any instrument limitations, such as detector response times, limited resolution bandwidth capability when compared to the emission bandwidth, sensitivity, etc., so as to obtain a true peak measurement for the emission in question over the full bandwidth of the channel.

Calculation of Peak Transmit Power Limit:

$$\text{Peak Transmit Power Limit} = 100\mu\text{W} \times (\text{EBW})^{1/2}$$

EBW is the transmit emission bandwidth in Hz determined in the other test item:

Test Procedure

Using the manufacturer's information on occupied bandwidth set the spectrum analyzer as follows:

RBW	≥ Emission bandwidth
Video bandwidth	≥ RBW
Span	Zero
Center frequency	Nominal center frequency of channels
Amplitude scale	Log (linear may be used if analyzer has sufficient linear dynamic range and accuracy)
Detection	Peak detection
Trigger	Video
Sweep rate	Sufficiently rapid to permit the transmit pulse to be resolved accurately

Test Equipment List and Details

Manufacturer	Description	Model	Serial Number	Calibration Date	Calibration Due Date
Rohde & Schwarz	EMI Test Receiver	ESR	1316.3003K0 3-101746-zn	2014-06-13	2015-06-13

* **Statement of Traceability:** Bay Area Compliance Laboratories Corp. (Shenzhen) attests that all calibrations have been performed in accordance to requirements that traceable to National Primary Standards and International System of Units (SI).

Test Data

Environmental Conditions

Temperature:	20 °C
Relative Humidity:	51 %
ATM Pressure:	101.0 kPa

The testing was performed by Gardon Zhang on 2014-06-18.

Test Result: Compliance. Please refer to the following plots.

Channel	Frequency (MHz)	Peak Transmit Power (dBm)	Limit (dBm)
Low	1921.536	20.10	20.57
Middle	1924.992	19.90	20.57
High	1928.448	20.42	20.57

EBW_{Low channel} = 1302500 Hz, EBW_{Middle channel} = 1302500 Hz, EBW_{High channel} = 1302500 Hz
 Peak Transmit Power Limit = $100(\text{EBW})^{1/2} \mu\text{W}$

Low Channel

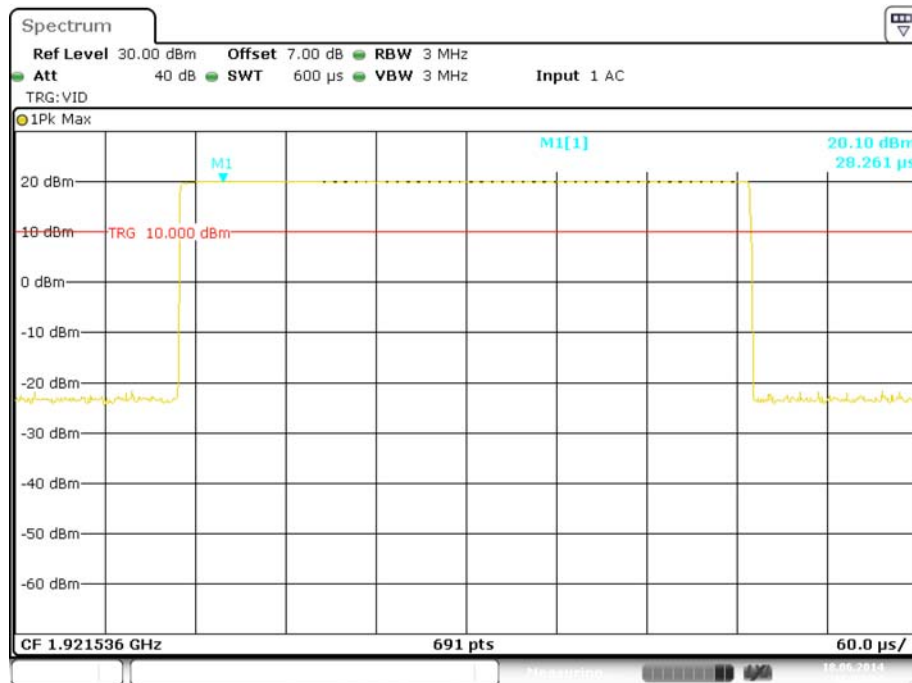

Date: 18.JUN.2014 15:57:39

Middle Channel

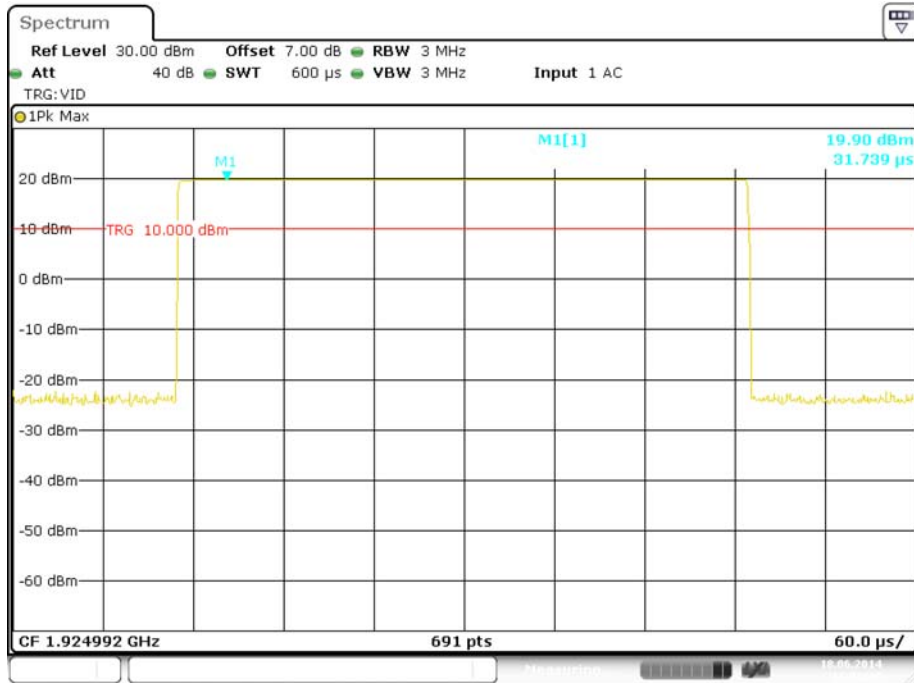

Date: 18.JUN.2014 16:01:40

High Channel

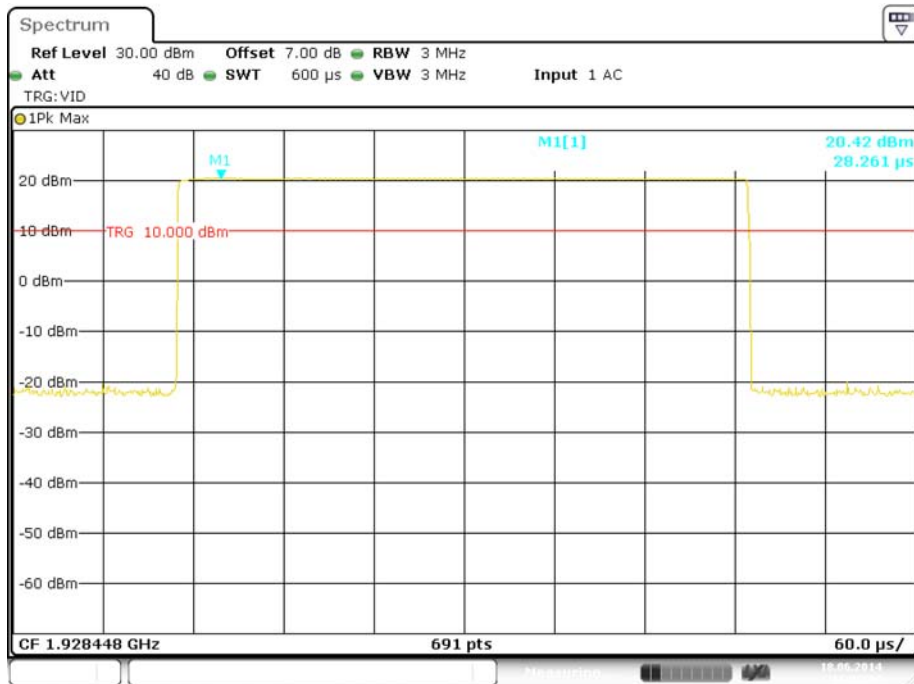

Date: 18.JUN.2014 16:03:06

FCC§15.319 (d) - POWER SPECTRAL DENSITY

Applicable Standard

The average pulse energy in a 3 kHz bandwidth is divided by the pulse duration.

The power spectral density shall not exceed 3mW in any 3 kHz bandwidth as measured with a spectrum analyzer having a resolution bandwidth of 3 kHz.

The power spectral density is measured in accordance with ANSI C63.17.2006 Clause 6.1.5.

Test Procedure

Using the manufacturer's information on occupied bandwidth set the spectrum analyzer as follows:

RBW	3 kHz
Video bandwidth	$\geq 3 \times \text{RBW}$
Span	Zero span at frequency with the maximum level (frequency determined in 6.1.3 if the same type of signal (continuous versus burst) was used in 6.1.3)
Center frequency	Spectral peak as determined in 6.1.3
Sweep time	For burst signals, sufficient to include essentially all of the maximum length burst at the output of a 3 kHz filter (e.g., maximum input burst duration plus 600 μs). For continuous signals, 20 ms.
Amplitude scale	Log power
Detection	Sample detection and averaged for a minimum of 100 sweeps
Trigger	External or internal

Test Equipment List and Details

Manufacturer	Description	Model	Serial Number	Calibration Date	Calibration Due Date
Rohde & Schwarz	EMI Test Receiver	ESR	1316.3003K0 3-101746-zn	2014-06-13	2015-06-13

* **Statement of Traceability:** Bay Area Compliance Laboratories Corp. (Shenzhen) attests that all calibrations have been performed in accordance to requirements that traceable to National Primary Standards and International System of Units (SI).

Test Data

Environmental Conditions

Temperature:	27 °C
Relative Humidity:	56 %
ATM Pressure:	101.0 kPa

The testing was performed by Gardon Zhang on 2014-06-19.

Test mode: Transmitting

Test Result: Compliance. Please refer to following tables and plots

Channel	Frequency (MHz)	Power Spectral Density		Limit (mW/3kHz)	Result
		(dBm/3kHz)	(mW/3kHz)		
Low	1921.536	-9.08	0.1236	3	Pass
Middle	1924.992	-9.13	0.1222	3	Pass
High	1928.448	-8.56	0.1393	3	Pass

Low Channel

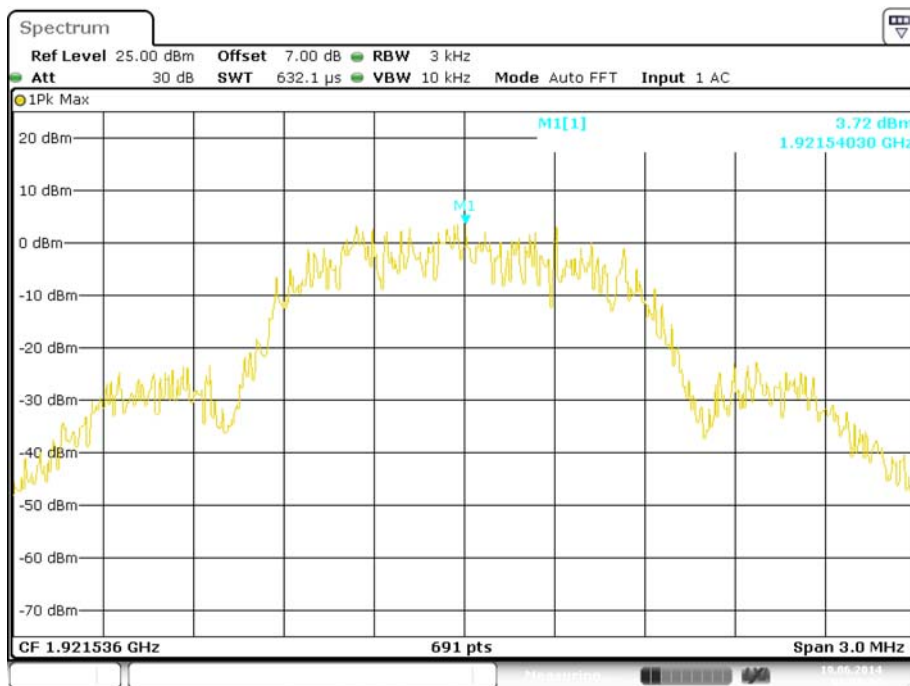

Date: 19.JUN.2014 08:59:40

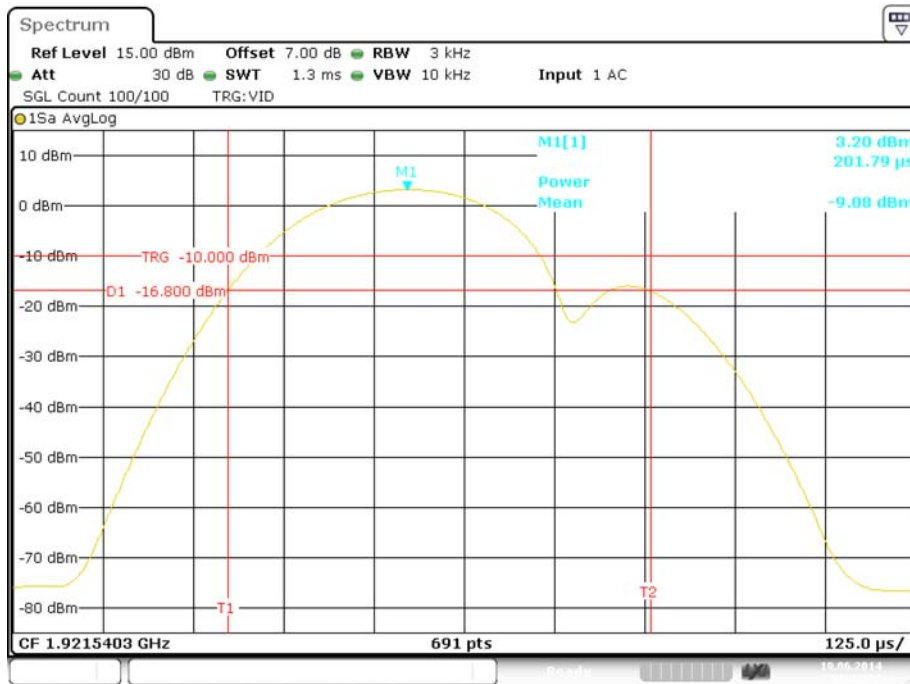

Date: 19.JUN.2014 09:13:03

Middle Channel

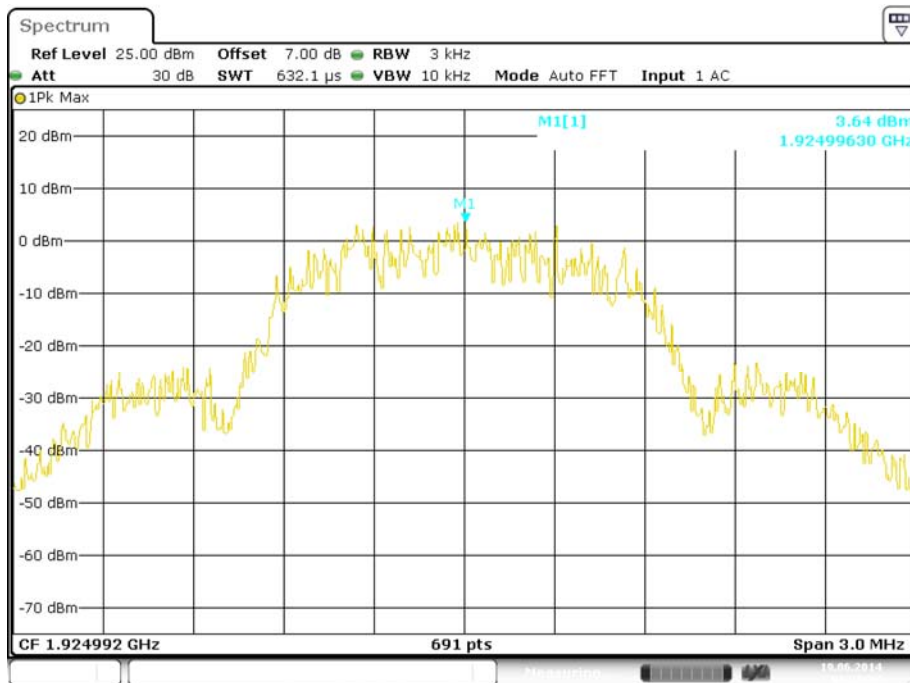

Date: 19.JUN.2014 09:16:59

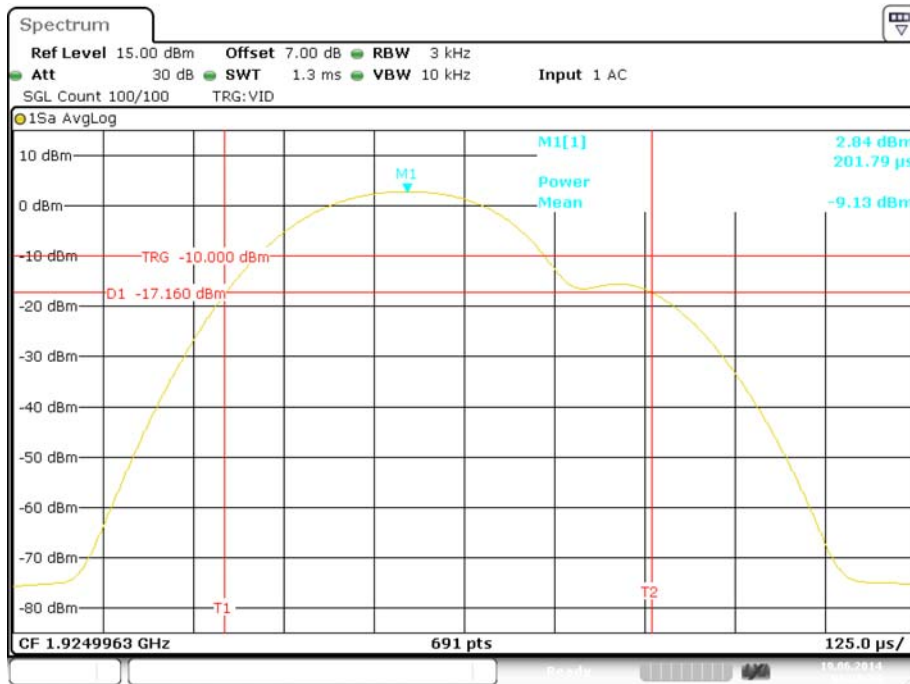

Date: 19.JUN.2014 09:20:24

High Channel

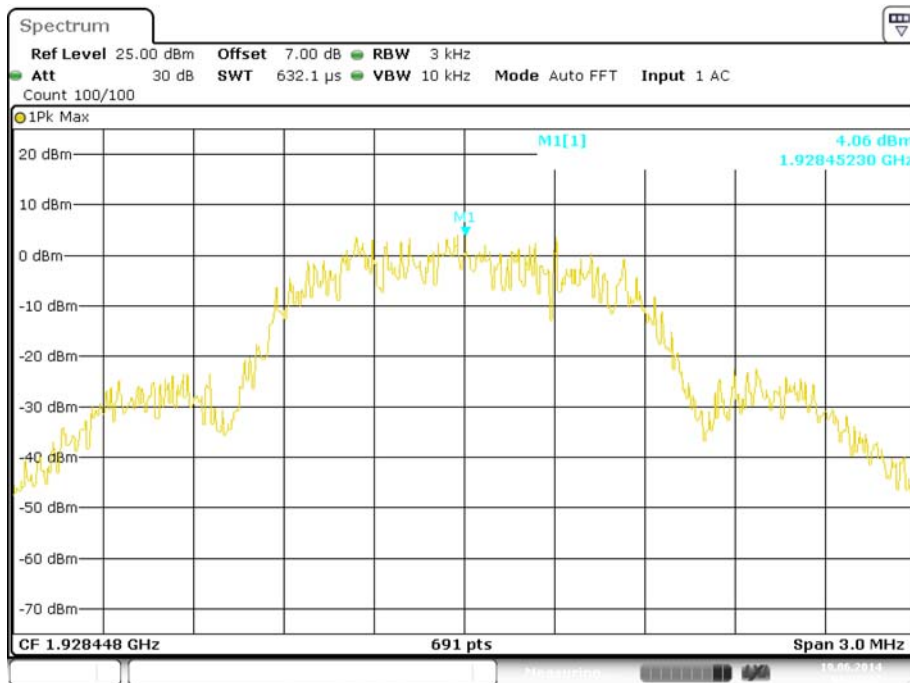

Date: 19.JUN.2014 09:22:13

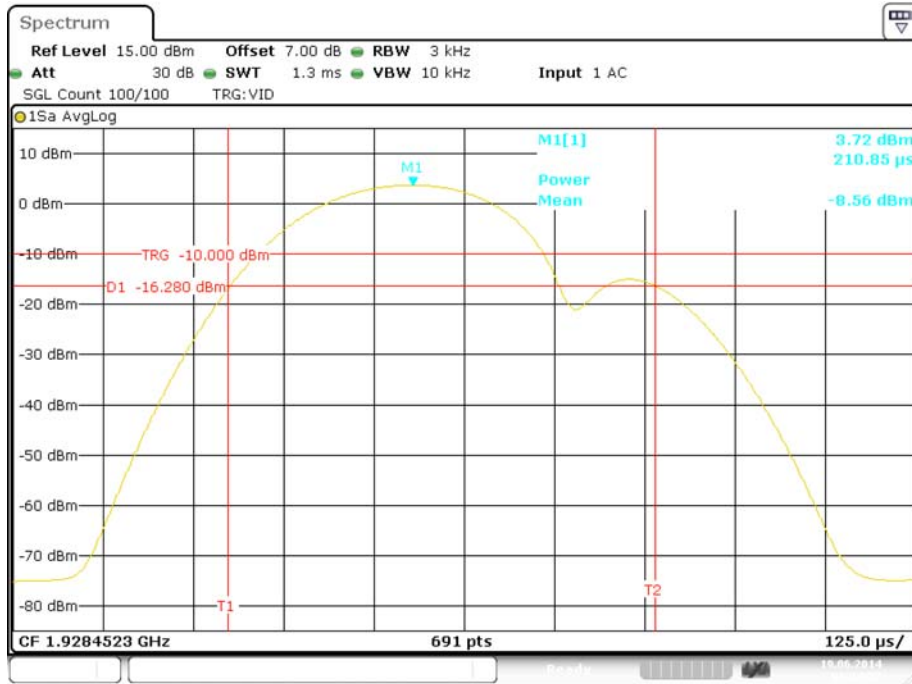

Date: 19.JUN.2014 09:24:37

FCC§15.323 (d) - EMISSION INSIDE AND OUTSIDE THE SUB-BAND

Applicable Standard

Emissions inside the sub-band must comply with the following emission mask:

1. In the bands between 1B and 2B measured from the center of the emission bandwidth the total power emitted by the device shall be at least 30 dB below the transmit power permitted for that device;
2. in the bands between 2B and 3B measured from the center of the emission bandwidth the total power emitted by an intentional radiator shall be at least 50 dB below the transmit power permitted for that radiator;
3. in the bands between 3B and the sub-band edge the total power emitted by an intentional radiator in the measurement bandwidth shall be at least 60 dB below the transmit power permitted for that radiator.

Where B = emission bandwidth

Emission Outside the sub-band shall be attenuated below a reference power of 112 mw (20.5 dBm) as follows:

1. 30 dB between the sub-band and 1.25 MHz above or below the sub-band;
2. 50 dB between 1.25 and 2.5 MHz above or below the sub-band;
3. 60 dB at 2.5 MHz or greater above or below the sub-band.

Test Procedure

According to ANSI C63.17.2006 Clause 6.1.6.

Test Equipment List and Details

Manufacturer	Description	Model	Serial Number	Calibration Date	Calibration Due Date
Rohde & Schwarz	Signal Analyzer	FSIQ26	8386001028	2013-11-12	2014-11-12
Rohde & Schwarz	EMI Test Receiver	ESR	1316.3003K0 3-101746-zn	2014-06-13	2015-06-13

* **Statement of Traceability:** Bay Area Compliance Laboratories Corp. (Shenzhen) attests that all calibrations have been performed in accordance to requirements that traceable to National Primary Standards and International System of Units (SI).

Test Data

Environmental Conditions

Temperature:	27 °C
Relative Humidity:	56 %
ATM Pressure:	101.0 kPa

The testing was performed by Gardon Zhang on 2014-06-19.

Test mode: Transmitting

Test Result: Compliance. Please refer to following tables and plots

Low Channel (Unwanted Emission inside the Sub-band)



Middle Channel (Unwanted Emission inside the Sub-band)



High Channel (Unwanted Emission inside the Sub-band)



Date: 18.JUN.2014 17:31:47

Low Channel (Unwanted Emission outside the Sub-band)

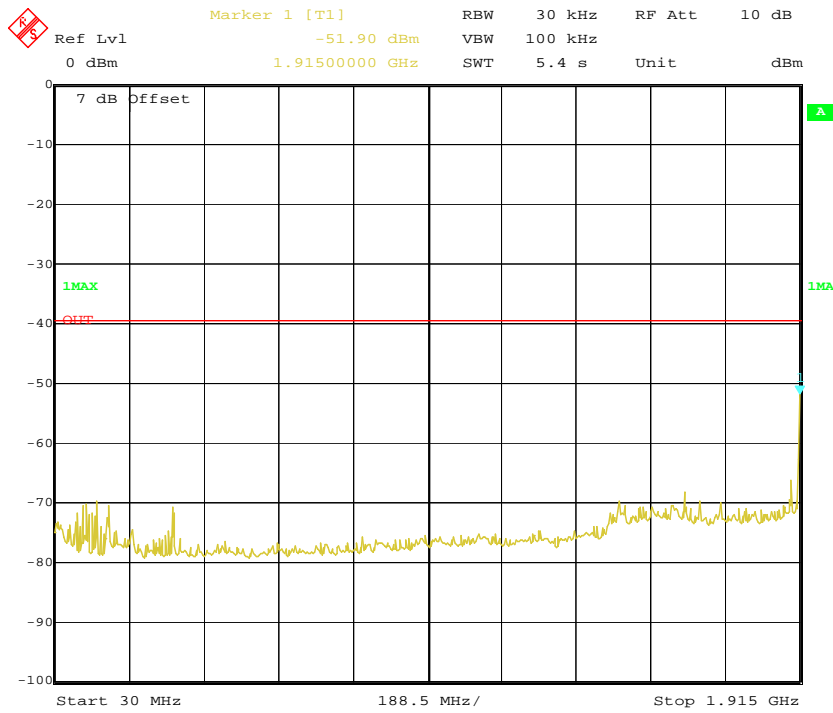

Date: 19.JUN.2014 10:13:24

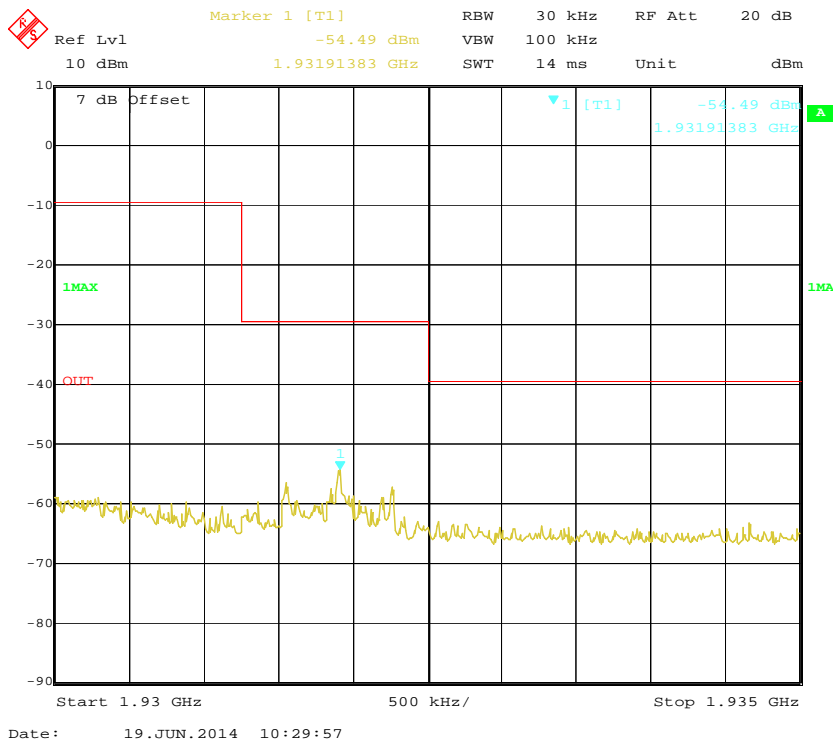
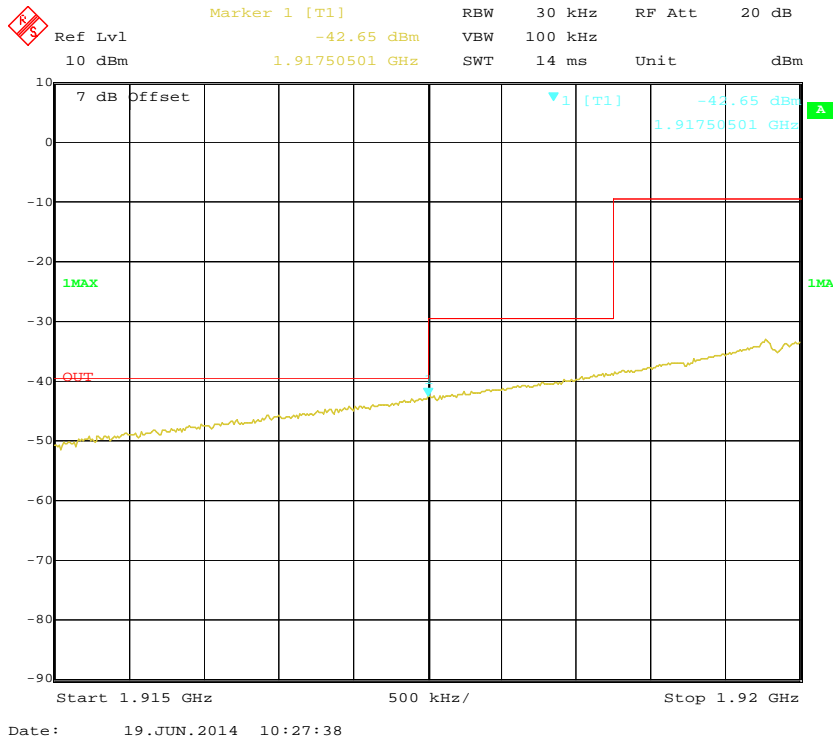

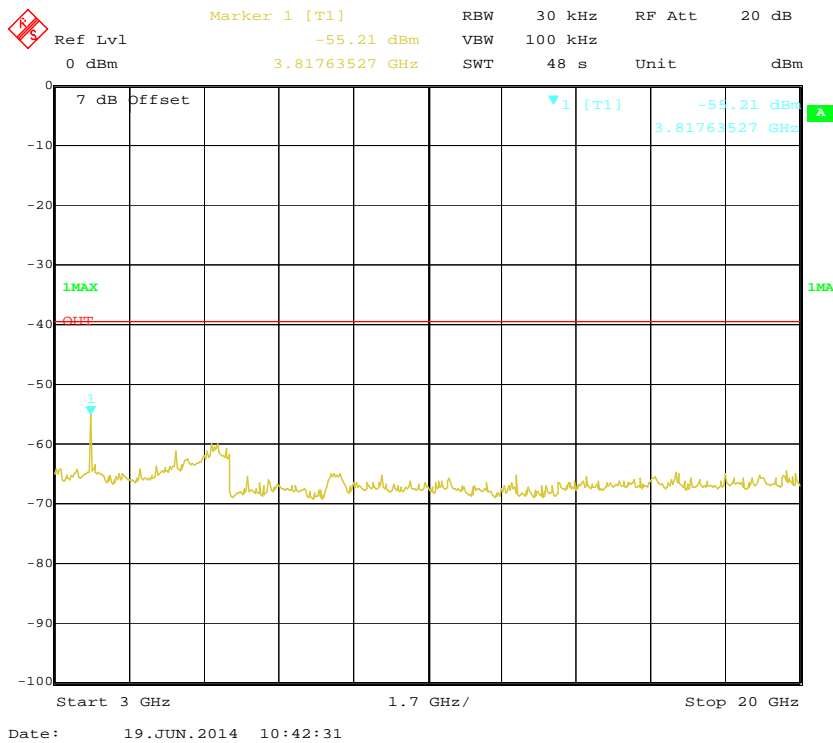
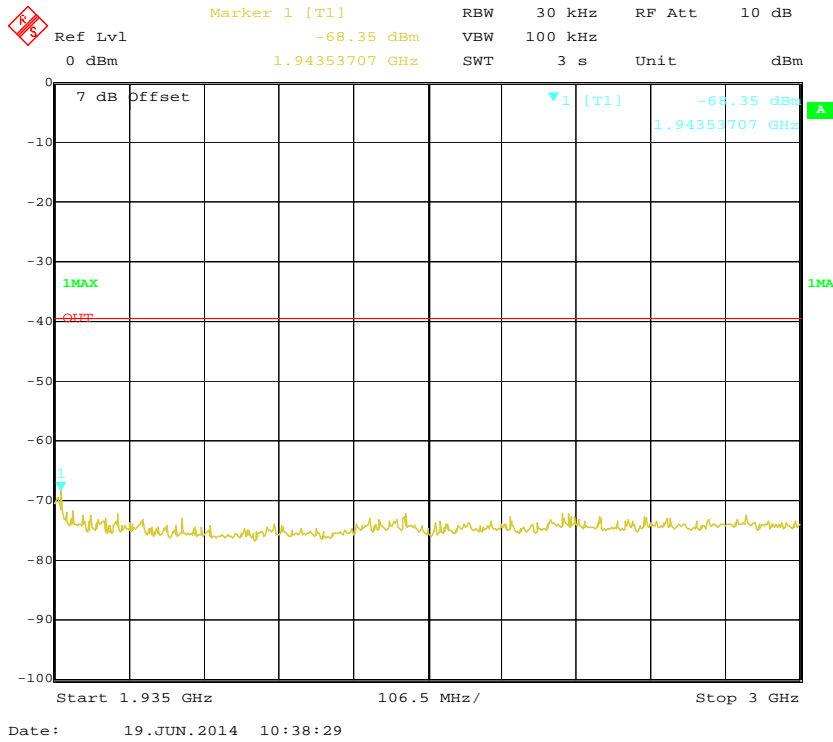

Middle Channel (Unwanted Emission outside the Sub-band)

Marker 1 [T1]
RBW 30 kHz
RF Att 10 dB
Ref Lvl -55.36 dBm
VBW 100 kHz
0 dBm
1.91500000 GHz
SWT 5.4 s
Unit dBm

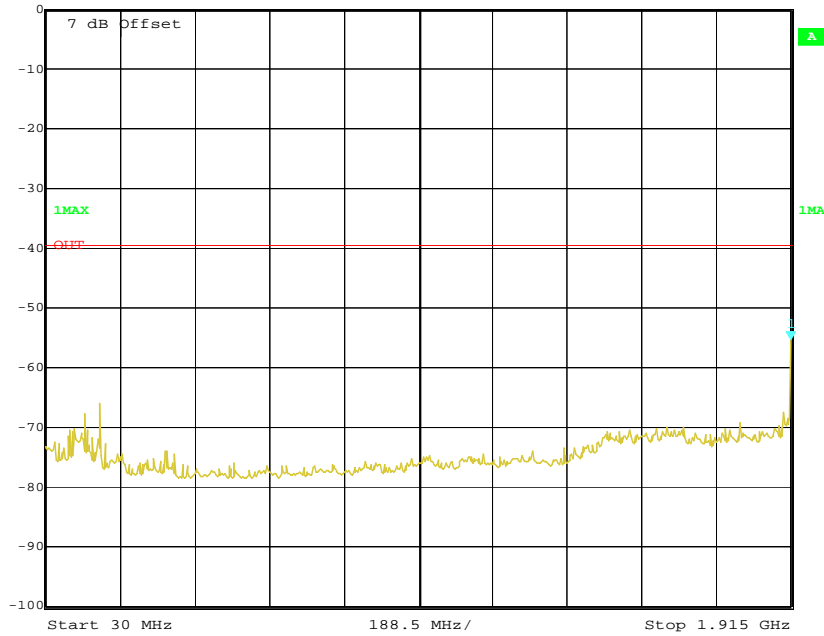

Date: 19.JUN.2014 10:16:04

Marker 1 [T1]
RBW 30 kHz
RF Att 20 dB
Ref Lvl -45.88 dBm
VBW 100 kHz
10 dBm
1.91998998 GHz
SWT 14 ms
Unit dBm

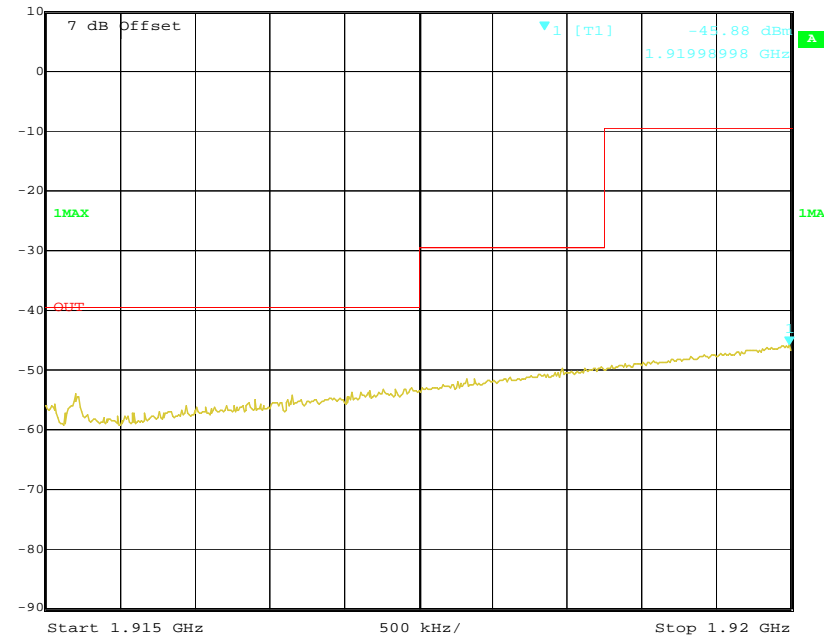

Date: 19.JUN.2014 10:24:49

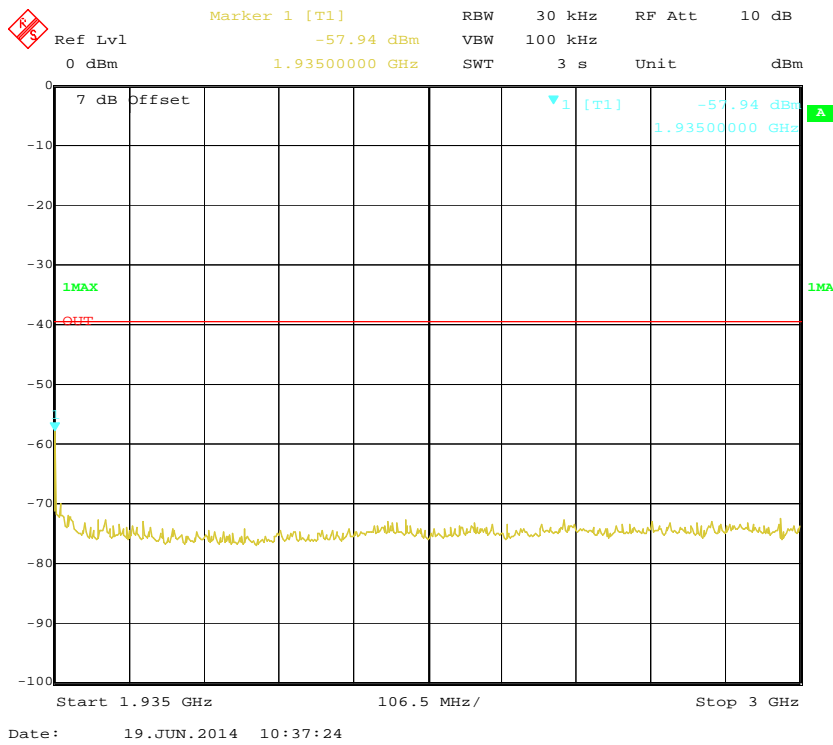
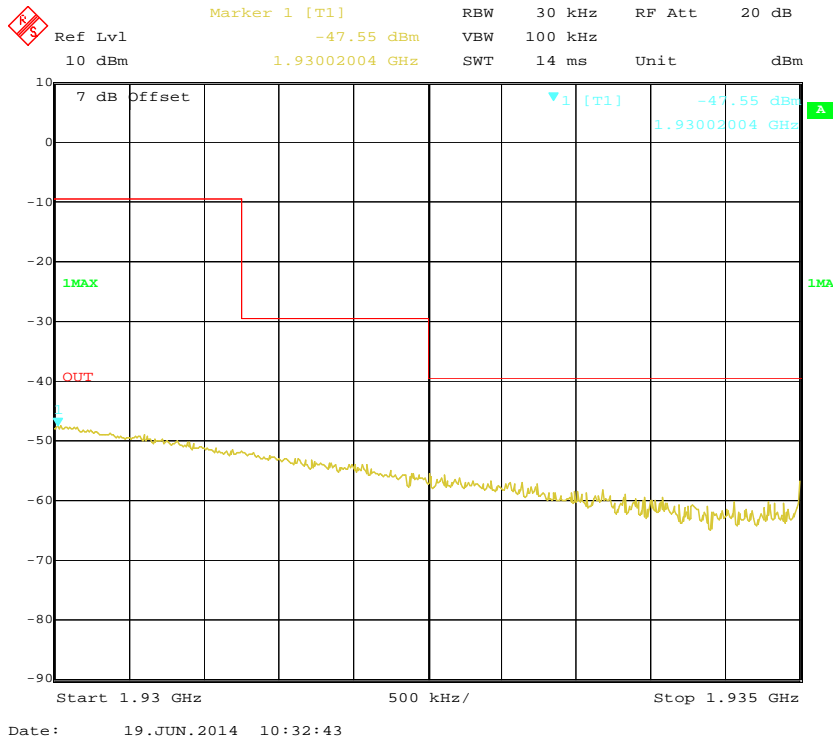

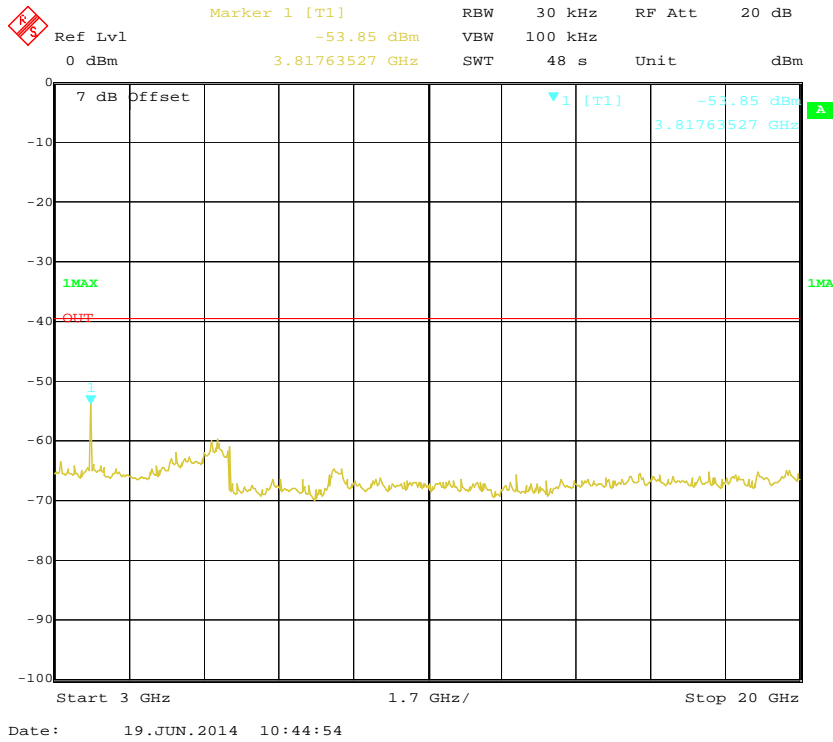

High Channel (Unwanted Emission outside the Sub-band)

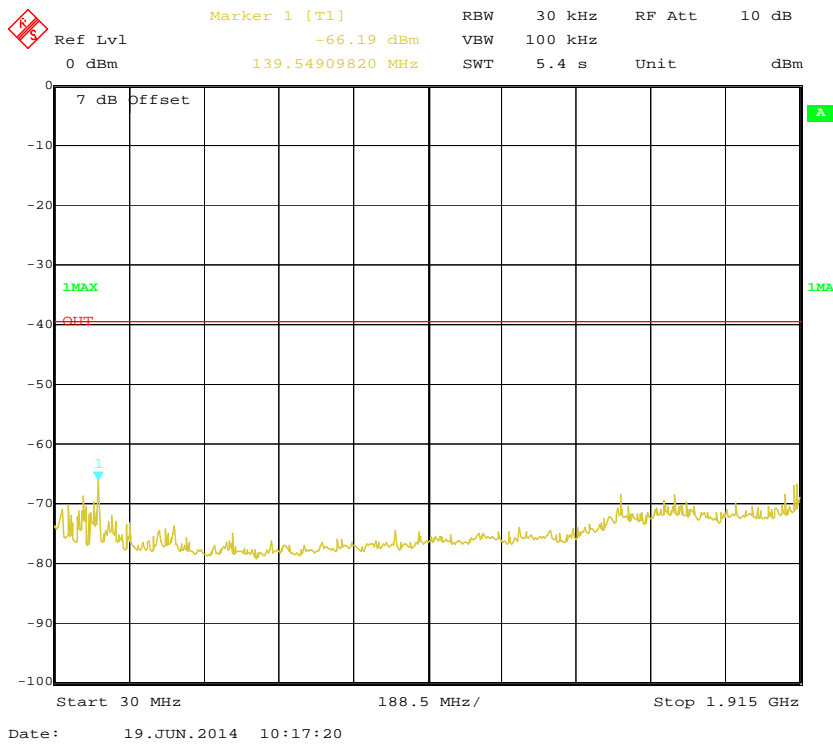

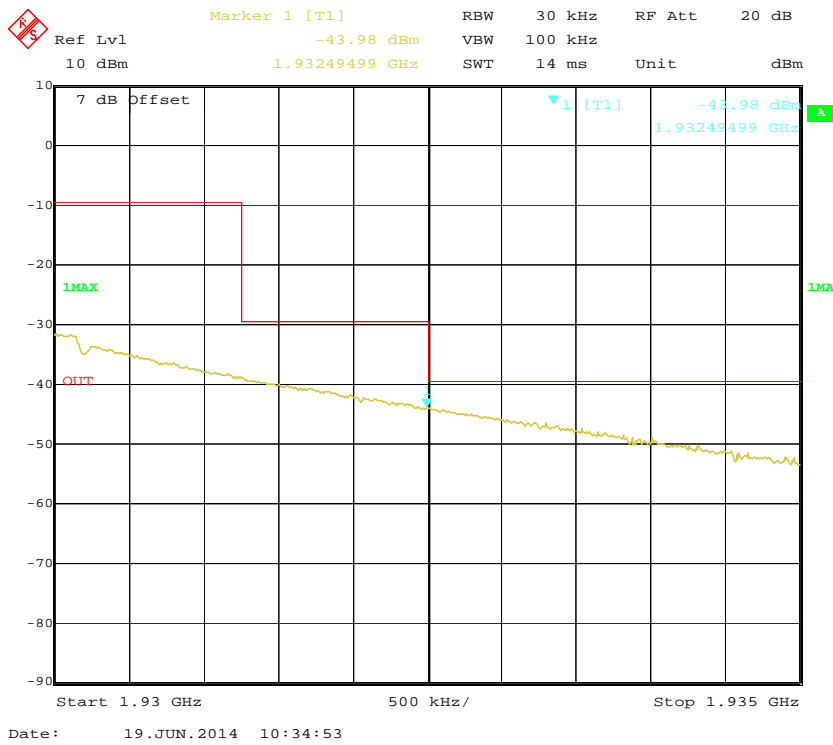
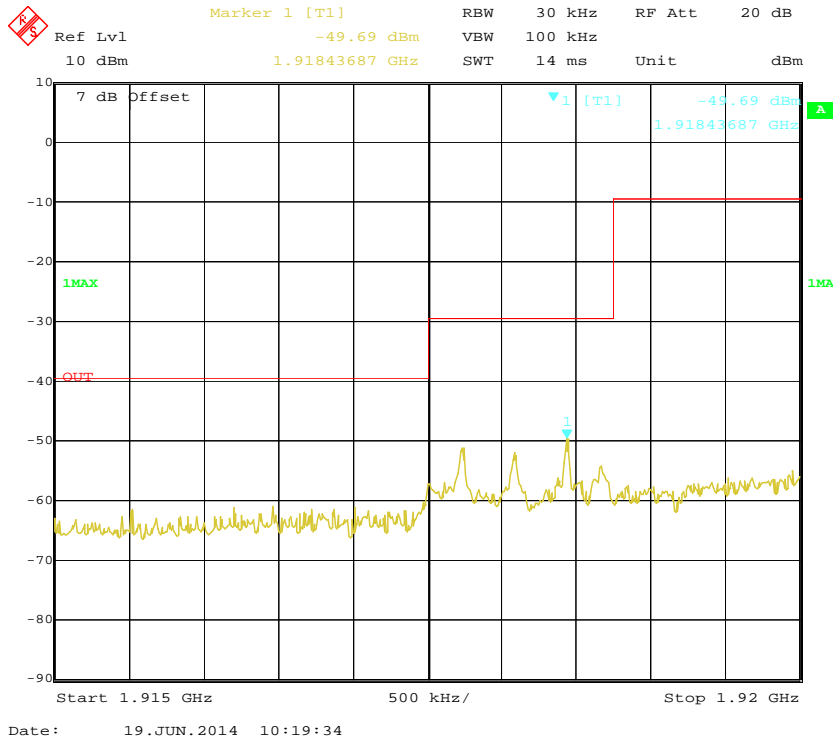

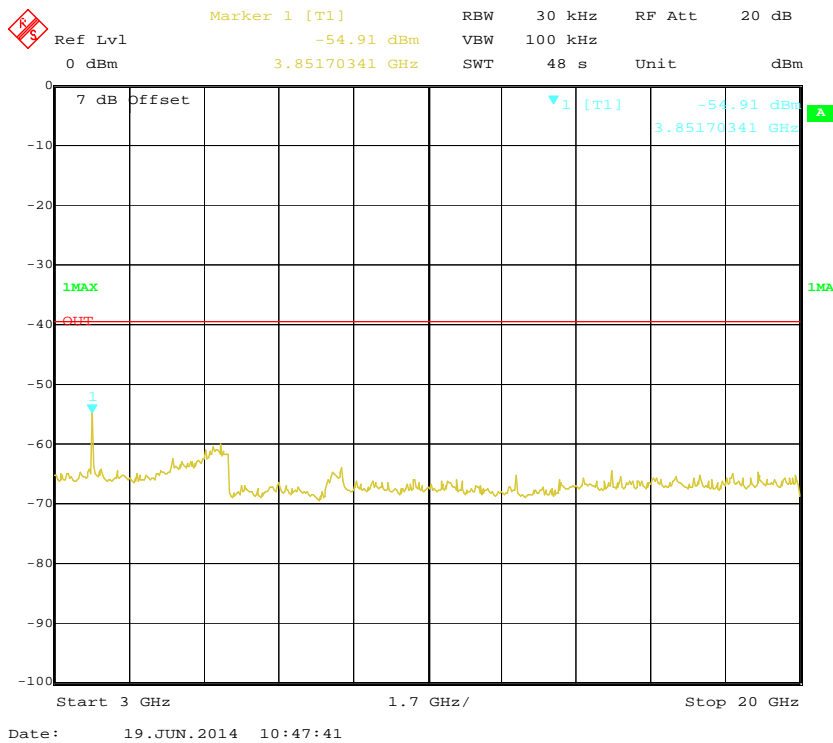
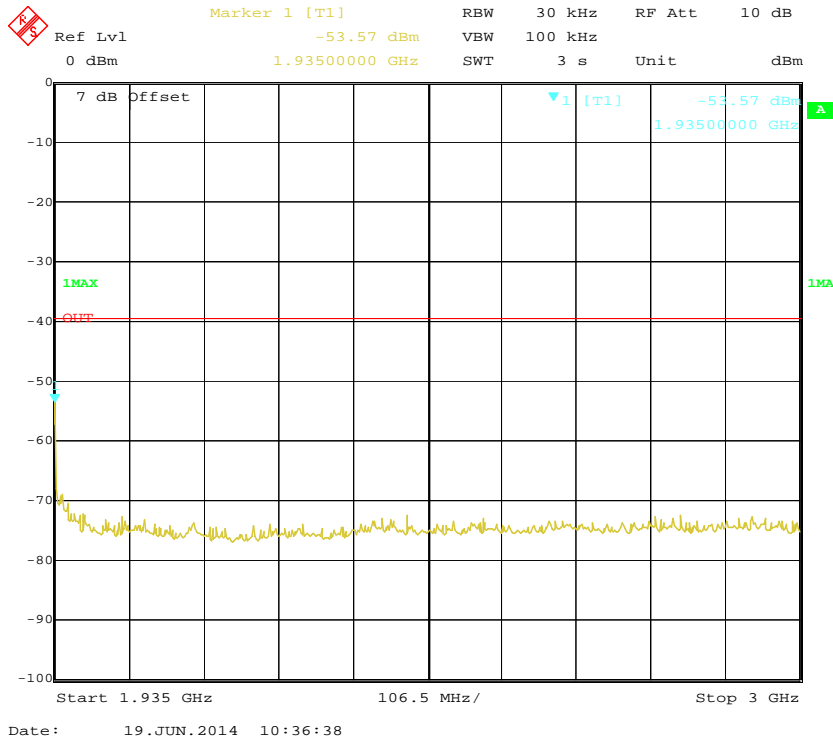

FCC§15.319 (g) - RADIATED EMISSIONS

Applicable Standard

According to FCC§15.319(g), notwithstanding other technical requirements specified in this subpart, attenuation of emissions below the general emission limits in §15.209 is not required.

Measurement Uncertainty

Input quantities to be considered for conducted disturbance measurements may be receiver reading, attenuation of the connection between AMN/ISN and receiver, AMN/ISN voltage division factor, AMN/ISN VDF frequency interpolation and receiver related input quantities, etc.

Based on CISPR 16-4-2:2011, the expanded combined standard uncertainty of radiation emissions at Bay Area Compliance Laboratories Corp. (Shenzhen) is 5.91 dB for 30MHz-1GHz, and 4.92 dB for above 1GHz. And this uncertainty will not be taken into consideration for the test data recorded in the report.

EUT Setup

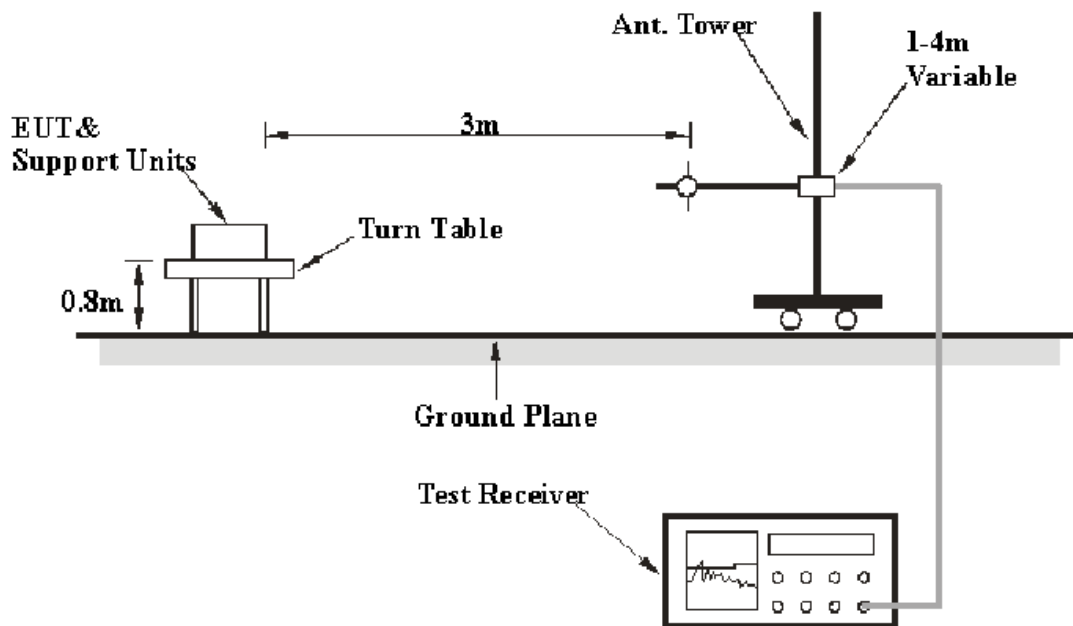

The radiated emission tests were performed in the 3 meters test site, using the setup accordance with the ANSI C63.17 - 2006. The specification used was the FCC 15§ 15.319(g).

The external I/O cables were draped along the test table and formed a bundle 30 to 40 cm long in the middle.

EMI Test Receiver & Spectrum Analyzer Setup

The system was investigated from 30 MHz to 20 GHz.

During the radiated emission test, the EMI test receiver & Spectrum Analyzer Setup were set with the following configurations:

Frequency Range	RBW	Video B/W	IF B/W	Detector
30MHz – 1000 MHz	100 kHz	300 kHz	120 kHz	QP
Above 1 GHz	1 MHz	3 MHz	/	PK

Test Procedure

Maximizing procedure was performed on the highest emissions to ensure that the EUT complied with all installation combinations.

Data was recorded in Quasi-peak detection mode for frequency range of 30 MHz-1 GHz and peak and Average detection modes for frequencies above 1 GHz.

Test Equipment List and Details

Manufacturer	Description	Model	Serial Number	Calibration Date	Calibration Due Date
HP	Amplifier	8447E	1937A01046	2013-09-30	2014-09-30
Rohde & Schwarz	EMI Test Receiver	ESCI	101122	2013-09-17	2014-09-17
Sunol Sciences	Broadband Antenna	JB1	A040904-2	2011-11-28	2014-11-27
Mini	Amplifier	ZVA-183-S+	5969001149	2014-04-23	2015-04-23
A.H. System	Horn Antenna	SAS-200/571	135	2012-02-11	2015-02-10
Rohde & Schwarz	Signal Analyzer	FSIQ26	8386001028	2013-11-12	2014-11-12
the electro-Mechanics Co.	Horn Antenna	3116	9510-2270	2013-10-14	2016-10-13
DUCOMMUN	Pre-amplifier	ALN-22093530-01	991373-01	2013-08-03	2014-08-03
Rohde & Schwarz	Test software	EMC 32	V9.10	-	-

* **Statement of Traceability:** Bay Area Compliance Laboratories Corp. (Shenzhen) attests that all calibrations have been performed in accordance to requirements that traceable to National Primary Standards and International System of Units (SI).

Corrected Amplitude & Margin Calculation

The Corrected Amplitude is calculated by adding the Antenna Factor and Cable Loss, and subtracting the Amplifier Gain from the Meter Reading. The basic equation is as follows:

$$\text{Corrected Amplitude} = \text{Meter Reading} + \text{Antenna Factor} + \text{Cable Loss} - \text{Amplifier Gain}$$

The “**Margin**” column of the following data tables indicates the degree of compliance with the applicable limit. For example, a margin of 7dB means the emission is 7dB below the maximum limit. The equation for margin calculation is as follows:

$$\text{Margin} = \text{Limit} - \text{Corrected Amplitude}$$

Test Results Summary

According to the data in the following table, the EUT complied with the FCC Part 15.319 (g), with the worst margin reading of:

18.61 dB at 7699.97 MHz in the Vertical polarization

Refer to CISPR16-4-2:2011 and CISPR 16-4-1:2009, the measured level is in compliance with the limit if

$$L_m + U_{(L_m)} \leq L_{lim} + U_{cispr}$$

In BA CL., $U_{(L_m)}$ is less than $+ U_{cispr}$, if L_m is less than L_{lim} , it implies that the EUT complies with the limit.

Test Data

Environmental Conditions

Temperature:	26 °C
Relative Humidity:	51 %
ATM Pressure:	101.0 kPa

**The testing was performed by Gardon Zhang on 2014-07-02.*

Test mode: Transmitting

30 MHz ~ 20 GHz:

Frequency (MHz)	Receiver		Turntable Degree	Rx Antenna		Corrected Factor (dB)	Corrected Amplitude (dBµV/m)	FCC Part 15.319(g)/209/205	
	Reading (dBµV)	Detector (PK/QP/Ave.)		Height (m)	Polar (H/V)			Limit (dBµV/m)	Margin (dB)
Low Channel (1921.536 MHz)									
663.33	30.66	QP	40	1.0	V	-6.3	24.36	46	21.64
1921.536	103.51	PK	287	2.4	H	2.63	106.14	/	/
1921.536	104.60	PK	209	1.5	V	2.63	107.23	/	/
3843.07	41.53	PK	88	1.4	H	9.70	51.23	74	22.77
3843.07	42.76	PK	150	1.1	V	9.70	52.46	74	21.54
5764.61	36.25	PK	3	1.0	H	13.51	49.76	74	24.24
5764.61	37.53	PK	26	1.2	V	13.51	51.04	74	22.96
7686.14	38.56	PK	204	1.8	H	16.01	54.57	74	19.43
7686.14	38.27	PK	168	1.5	V	16.01	54.28	74	19.72
Middle Channel (1924.992 MHz)									
663.33	30.78	QP	42	1.0	V	-6.3	24.48	46	21.52
1924.992	104.70	PK	181	2.1	H	2.63	107.33	/	/
1924.992	105.10	PK	57	2.0	V	2.63	107.73	/	/
3849.98	42.38	PK	240	1.6	H	9.70	52.08	74	21.92
3849.98	42.25	PK	29	1.3	V	9.70	51.95	74	22.05
5774.98	35.25	PK	312	1.8	H	13.51	48.76	74	25.24
5774.98	37.17	PK	191	2.1	V	13.51	50.68	74	23.32
7699.97	38.67	PK	174	2.0	H	16.47	55.14	74	18.86
7699.97	38.92	PK	38	2.3	V	16.47	55.39	74	18.61
High Channel (1928.448 MHz)									
663.33	30.50	QP	39	1.0	V	-6.3	24.20	46	21.80
1928.448	104.94	PK	320	1.3	H	2.63	107.57	/	/
1928.448	104.03	PK	232	2.3	V	2.63	106.66	/	/
3856.90	40.45	PK	321	1.9	H	9.70	50.15	74	23.85
3856.90	43.32	PK	360	1.3	V	9.70	53.02	74	20.98
5785.34	35.03	PK	342	1.6	H	13.87	48.90	74	25.10
5785.34	38.19	PK	314	1.4	V	13.87	52.06	74	21.94
7713.79	37.56	PK	12	1.7	H	16.47	54.03	74	19.97
7713.79	38.84	PK	3	1.6	V	16.47	55.31	74	18.69

Field Strength of Radiated Emission Average							
Frequency (MHz)	Peak Corrected Amplitude. @3m (dBµV/m)	Polar (H/V)	Duty Cycle Factor (dB)	Corrected Amplitude. (dBµV/m)	FCC 15.319/15.205/15.209		Comment
					Limit (dBµV/m)	Margin	
Low Channel (1921.536 MHz)							
1921.536	106.14	H	-28.36	77.78	/	/	Fundamental
1921.536	107.23	V	-28.36	78.87	/	/	Fundamental
3843.07	51.23	H	-28.36	22.87	54	31.13	Harmonic
3843.07	52.46	V	-28.36	24.10	54	29.90	Harmonic
5764.61	49.76	H	-28.36	21.40	54	32.60	Harmonic
5764.61	51.04	V	-28.36	22.68	54	31.32	Harmonic
7686.14	54.57	H	-28.36	26.21	54	27.79	Harmonic
7686.14	54.28	V	-28.36	25.92	54	28.08	Harmonic
Middle Channel (1924.992 MHz)							
1924.992	107.33	H	-28.36	78.97	/	/	Fundamental
1924.992	107.73	V	-28.36	79.37	/	/	Fundamental
3849.98	52.08	H	-28.36	23.72	54	30.28	Harmonic
3849.98	51.95	V	-28.36	23.59	54	30.41	Harmonic
5774.98	48.76	H	-28.36	20.40	54	33.60	Harmonic
5774.98	50.68	V	-28.36	22.32	54	31.68	Harmonic
7699.97	55.14	H	-28.36	26.78	54	27.22	Harmonic
7699.97	55.39	V	-28.36	27.03	54	26.97	Harmonic
High Channel (1928.448 MHz)							
1928.448	107.57	H	-28.36	79.21	/	/	Fundamental
1928.448	106.66	V	-28.36	78.30	/	/	Fundamental
3856.90	50.15	H	-28.36	21.79	54	32.21	Harmonic
3856.90	53.02	V	-28.36	24.66	54	29.34	Harmonic
5785.34	48.90	H	-28.36	20.54	54	33.46	Harmonic
5785.34	52.06	V	-28.36	23.70	54	30.30	Harmonic
7713.79	54.03	H	-28.36	25.67	54	28.33	Harmonic
7713.79	55.31	V	-28.36	26.95	54	27.05	Harmonic

Note:

Corrected Amplitude = Corrected Factor + Reading

Corrected Factor = Antenna Factor (Rx) + Cable Loss – Amplifier Factor

Margin = Limit - Corrected Amplitude

Duty Cycle = Ton/Tp*100%, Ton = 383.478µs, Tp = 10.0443 ms

Duty Cycle Factor = 20lg (Duty Cycle) = -28.36

Average = PK + 20*lg(Duty Cycle)

T_{on}

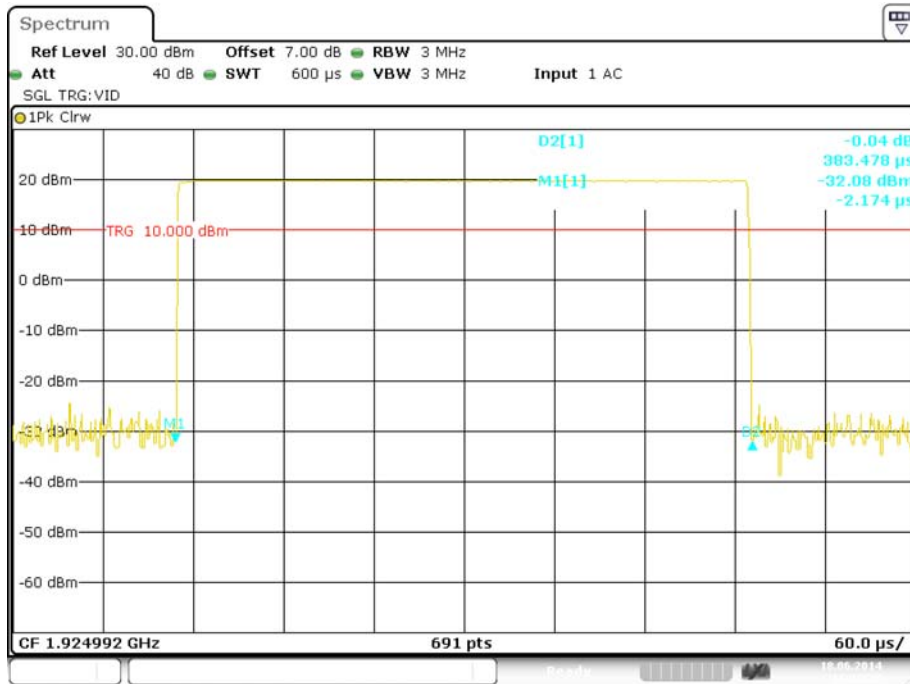

Date: 18.JUN.2014 16:12:25

T_p

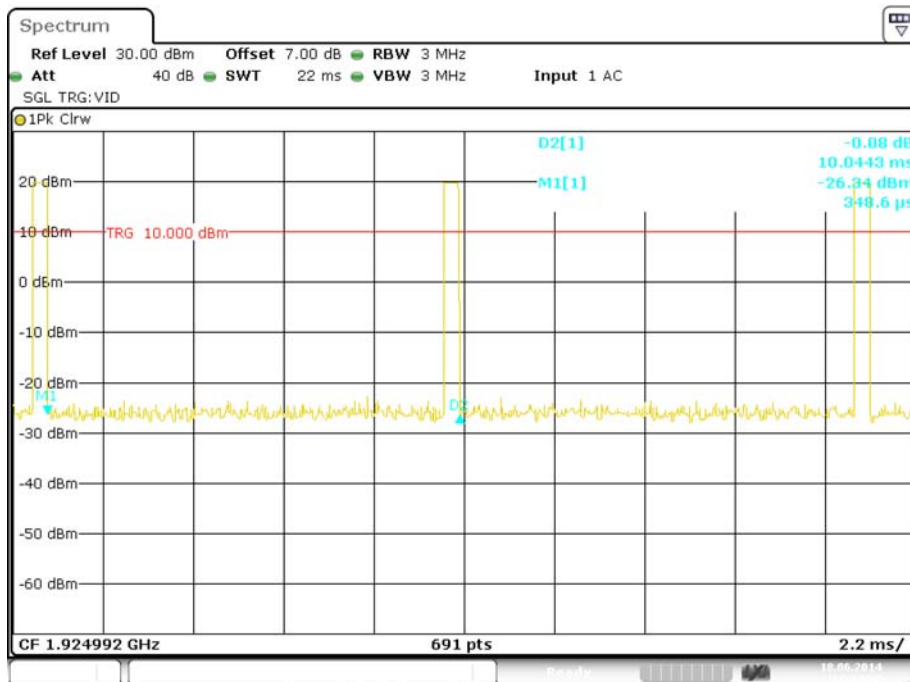

Date: 18.JUN.2014 16:14:05

Duty Cycle (100ms)

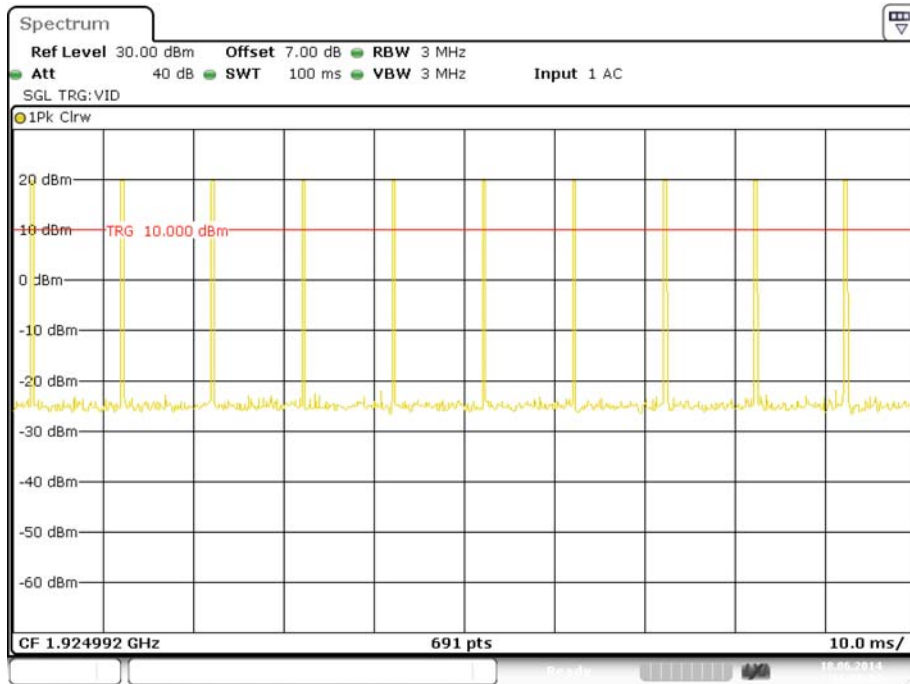

Date: 18 JUN 2014 16:09:26

FCC§15.323 (f) - FREQUENCY STABILITY

Applicable Standard

Per §15.323(f), the frequency stability of the carrier frequency of the intentional radiator shall be maintained within ± 10 ppm over 1 hour or the interval between channel access monitoring, whichever is shorter. The frequency stability shall be maintained over a temperature variation of -20°C to $+50^{\circ}\text{C}$ at normal supply voltage, and over a variation in the primary supply voltage of 85 percent to 115 percent of the rated supply voltage at a temperature of 20°C . For equipment that is capable only of operating from a battery, the frequency stability tests shall be performed using a new battery without any further requirement to vary supply voltage

Test Procedure

This procedure should be carried out for each of the following test cases:

Temperature	Supply Voltage
20°C	85-115% or new batteries
-20°C	Normal
$+50^{\circ}\text{C}$	Normal

^a Use the lowest temperature at which the EUT is specified to operate if it is above -20°C .

During test, the equipment shall be placed in the boxes and set the temperature to the specified requirement until the thermal balance has been reached.

Using the mean carrier frequency at 20°C and at nominal supply voltage as the reference, the mean carrier frequency shall be maintained within ± 10 ppm at the two extreme temperatures (or as declared by the manufacturer) and at normal temperature (typically 20°C) at the two extreme supply voltages. This test does not apply to a EUT that is capable only of operating from a battery.

Test Equipment List and Details

Manufacturer	Description	Model	Serial Number	Calibration Date	Calibration Due Date
ESPEC	Temperature & Humidity Chamber	EL-10KA	09107726	2013-11-01	2014-11-01
Rohde & Schwarz	Signal Analyzer	FSIQ26	8386001028	2013-11-12	2014-11-12

* **Statement of Traceability:** Bay Area Compliance Laboratories Corp. (Shenzhen) attests that all calibrations have been performed in accordance to requirements that traceable to National Primary Standards and International System of Units (SI).

Test Data**Environmental Conditions**

Temperature:	29 °C
Relative Humidity:	53 %
ATM Pressure:	101.0 kPa

The testing was performed by Gardon Zhang on 2014-07-25.

Test mode: Transmitting

Test Result: Compliance.

Temperature (°C)	Voltage (V_{DC})	Channel Frequency (MHz)	Measured Frequency Offset (kHz)	Measured Frequency Offset (ppm)	Limit (ppm)
-20	3.7	1924.992	1.4	0.727	±10
20	3.7	1924.992	1.7	0.883	±10
50	3.7	1924.992	1.6	0.831	±10

FCC§15.323 (c) (e) & §15.319(f) – SPECIFIC REQUIREMENTS FOR UPCS DEVICE

Applicable Standard

FCC§15.323(c)(e) & §15.319(f) Specific Requirements for UPCS device.
ANSI C63.17 2006 §6.2 Frequency and time stability and §7.Monitoring tests and §8.Time and spectrum window access procedure.

Test Procedure

Measurement method according to ANSI C63.17 2006

Test configuration as below

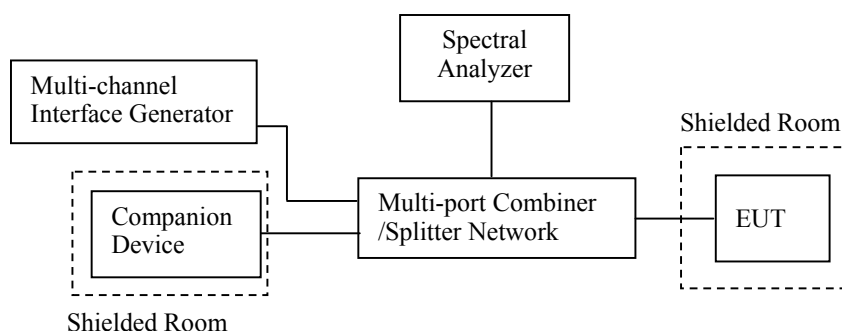

Test Equipment List and Details

Manufacturer	Description	Model	Serial Number	Calibration Date	Calibration Due Date
Sunol Sciences	Horn Antenna	DRH-118	A052304	2011-12-01	2014-11-30
HP	Signal Generator	8648C	3426A01345	2014-05-09	2015-05-09
Rohde & Schwarz	EMI Test Receiver	ESCI	101122	2013-09-25	2014-09-25
R & S	Digital Radio-Communication Tester	CMD60	829902/026	2014-06-09	2015-06-09
R & S	Vector Signal Generator	SMU200A	GB40051862	2014-03-16	2015-03-15

* **Statement of Traceability:** Bay Area Compliance Laboratories Corp. (Shenzhen) attests that all calibrations have been performed in accordance to requirements, traceable to traceable to National Primary Standards and International System of Units (SI).

Test Data**Environmental Conditions**

Temperature:	20 °C
Relative Humidity:	50 %
ATM Pressure:	100.1 kPa

The testing was performed by Gardon Zhang on 2014-07-25.

Test Result: Compliance, please see the below data

1) Automatic Discontinuation of Transmission, FCC §15.319(f)

The device shall automatically discontinue transmission in case of either absence of information to transmit or operational failure. The provisions in this section are not intended to preclude transmission of control and signaling information or use of repetitive codes used by certain digital technologies to complete frame or burst intervals.

Test result:

The following tests were performed after a connection had been established with handset.

Test condition	Reaction of EUT	Pass/Fail
Battery removed from EUT	Connection break down	Pass

2) Monitoring Time, FCC §15.323(c) (1)

Immediately prior to initiating transmission, devices must monitor the combined time and spectrum window in which they intend to transmit. For a period of at least 10 milliseconds for systems designed to use a 10 milliseconds or shorter frame period or at least 20 milliseconds for systems designed to use a 20 milliseconds frame period

Test procedure:

Measurement method is in according to ANSI C63.17 2006 clause 7.3.4. RF signal generators apply uniform CW interference on all system carriers except two carriers (designated f_1 and f_2), each at level $T_U + U_M$. EUT can only transmit on these two carriers.

Test result:

This requirement is covered by the results of Least Interfered Channel (LIC) based on FCC §15.323 (c) (5).

3) Lower Monitoring Threshold, FCC §15.323(c) (2)

The monitoring threshold must not be more than 30 dB above the thermal noise power for a bandwidth equivalent to the emission bandwidth used by the device.

Test procedure:

Measurement method according to ANSI C63.17 2006 clause 7.3.1

Test result:

Not applicable because the EUT has more 40 defined duplex system access channels and meet the provision of the Least Interfered Channel (LIC) based on FCC §15.323(c) (5).

4) Maximum Transmit Period, FCC §15.323(c) (3)

If no signal above the threshold level is detected, transmission may commence and continue with the same emission bandwidth in the monitored time and spectrum windows without further monitoring. However, occupation of the same combined time and spectrum windows by a device or group of cooperating devices continuously over a period of time longer than 8 hours is not permitted without repeating the access criteria.

Test procedure:

Measurement method according to ANSI C63.17 2006 clause 8.2.2

The test procedure is as follows:

- a) Activate the EUT and initiate a communication channel with the companion device, and start a timer or frame counter.
- b) The centre frequency of spectrum analyzer was set to the carrier frequency and SPAN was set to ZERO. The spectrum analyzer was used to monitor the time and spectrum window of the communication channel.
- c) Stop the timer at the end of the EUT transmission on the current time and frequency window (measure the time until the EUT changes to a different slot).

Test result:

Measured Maximum Transmission Time (Minutes)	Limit (Minutes)	Results
273	480	Pass

5) System Acknowledgement, FCC §15.323(c) (4)

Once access to specific combined time and spectrum windows is obtained an acknowledgment from a system participant must be received by the initiating transmitter within one second or transmission must cease.

Periodic acknowledgments must be received at least every 30 seconds or transmission must cease. Channels used exclusively for control and signaling information may transmit continuously for 30 seconds without receiving an acknowledgment, at which time the access criteria must be repeated.

Test procedure:

Measurement method according to ANSI C63.17 2006 clause 8.1.1, 8.2.1

During testing initial transmission without acknowledgement, the signal from the EUT to the companion device is blocked by the circulator.

The test of the transmission time after loss of acknowledgements is performed by cutting off the signal from the companion device by a RF switch and measuring the time until the EUT stops transmitting.

Test result:

Test	Time taken (second)	Limit (second)	Result
Initial Connection acknowledgement	0.32	1	Pass
Change of access criteria for control information	N/A	30	N/A
Transmission cease time after loss of acknowledgement	1.8	30	Pass

Note: N/A=Not Applicable

6) Least Interfered Channel (LIC), FCC §15.323(c) (5)

If access to spectrum is not available as determined by the above, and a minimum of 40 duplex system access channels are defined for the system, the time and spectrum windows with the lowest power level below a monitoring threshold of 50 dB above the thermal noise power determined for the emission bandwidth may be accessed.

A device utilizing the provisions of this paragraph (5) must have monitored all access channels defined for its system within the last 10 seconds and must verify, within the 20 milliseconds (40 milliseconds for devices designed to use a 20 millisecond frame period) immediately preceding actual channel access, that the detected power of the selected time and spectrum windows is no higher than the previously detected value.

The power measurement resolution bandwidth for this comparison must be accurate to within 6 dB.

No device or group of cooperating devices located within 1 metre of each other shall during any frame period occupy more than 6 MHz of aggregate bandwidth, or alternatively, more than one third of the time and spectrum windows defined by the system.

Calculation of monitoring threshold limits for isochroous devices:

Lower threshold: $T_L = -174 + 10\text{Log}_{10}B + M_u + P_{MAX} - P_{EUT}$ (dBm)

Upper threshold: $T_U = -174 + 10\text{Log}_{10}B + M_u + P_{MAX} - P_{EUT}$ (dBm)

Where: B=Emission bandwidth (Hz)

M_u = dB the threshold may exceed thermal noise (30 for T_L & 50 for T_U)

$P_{MAX} = 5\text{Log}_{10}B - 10$ (dBm)

P_{EUT} = Transmitted power (dBm)

Calculated thresholds:

Monitor Threshold	B(MHz)	M _U (dB)	P _{MAX} (dBm)	P _{EUT} (dBm)	Threshold (dBm)
T _L	1.3025	30	20.57	20.42	-82.70
T _U	1.3025	50	20.57	20.42	-62.70

Note: 1. The upper threshold is applicable as the EUT utilizes more than 40 duplex system channels

Test procedure:

Measurement method according to ANSI C63.17 clause 7.3.2, 7.3.3, 7.3.4

C63.17 clause 7.3.2, Upper monitoring threshold for LIC:

The multi-carrier interference generator apply uniform CW interference to the EUT on all system carriers each at level $TU + UM + 10$ dB. Lower the interference uniformly on all carriers until the EUT can transmit. The interference level shall be lower than or equal to the threshold limit $TU + UM$.

C63.17 clause 7.3.3, LIC procedure test:

- a) Allow EUT transmission on only two carrier frequencies, which will be designated f_1 and f_2 .
- b) Apply interference to the EUT on f_1 at a level of $TL + UM + 7$ dB and on f_2 at a level of $TL + UM$. Initiate transmission. The EUT should transmit on f_2 . Terminate the connection. Repeat five times. If the EUT transmits once on f_1 , the test failed.
- c) Apply interference to the EUT on f_1 at a level of $TL + UM$ and on f_2 at a level of $TL + UM + 7$ dB. Initiate transmission. The EUT should transmit on f_1 . Terminate the connection. Repeat five times. If the EUT transmits once on f_2 , the test failed.
- d) Apply interference to the EUT on f_1 at a level of $TL + UM + 1$ dB and on f_2 at a level of $TL + UM - 6$ dB. Initiate transmission. If the EUT transmits on f_2 , terminate the connection. Repeat five times. If the EUT transmits once on f_1 , the test failed.
- e) Apply interference to the EUT on f_1 at a level of $TL + UM - 6$ dB and on f_2 at a level of $TL + UM + 1$ dB. Initiate transmission. If the EUT transmits on f_1 , terminate the connection. Repeat five times. If the EUT transmits once on f_2 , the test failed.

C63.17 clause 7.3.4, Selected channel confirmation:

- a) Allow EUT transmission on only two carrier frequencies, which will be designated f_1 and f_2 . Set the interference level to the EUT on f_1 to a level of $TU + UM$, and let there be no interference applied on f_2 .
- b) Initiate transmission and verify that the EUT transmits on f_2 . If a connection was made, terminate it.
- c) Apply interference on f_2 at a level of $TU + UM$, in-band, and immediately remove all interference from f_1 and immediately (but not sooner than 20 ms after the interference on f_2 is applied) cause the EUT to attempt transmission. The EUT should now transmit on f_1 , if it transmits.
- d) If the EUT transmits on f_2 , it fails.

Test result:**1) Upper monitoring threshold:**

Monitor threshold	Measured Threshold Level	Limit (dBm)	Results
Lower Threshold (dBm)	N/A	-76.70	N/A
Upper Threshold (dBm)	-63.64	-56.70	Pass

Note: N/A=Not Applicable

2) LIC procedure test:

Interference (Refer to ANSI C63.17 clause 7.3.3)	Reaction of EUT	Results
a) Apply the interference on f_1 at level $T_L+U_M+7\text{dB}$ and the interference on f_2 at level T_L+U_M . Initiate transmission and verify the transmission only on f_2 . Repeat 5 times.	EUT transmits on f_2	Pass
b) Apply the interference on f_1 at level T_L+U_M and the interference on f_2 at level $T_L+U_M+7\text{dB}$. Initiate transmission and verify the transmission only on f_1 . Repeat 5 times.	EUT transmits on f_1	Pass
c) Apply the interference on f_1 at level $T_L+U_M+1\text{dB}$ the interference on f_2 at level $T_L+U_M-6\text{dB}$. Initiate transmission and verify the transmission only on f_2 . Repeat 5 times.	EUT transmits on f_2	Pass
d) Apply the interference on f_1 at level $T_L+U_M-6\text{dB}$ and the interference on f_2 at level $T_L+U_M+1\text{dB}$. Initiate transmission and verify the transmission only on f_1 . Repeat 5 times.	EUT transmits on f_1	Pass

3) Selected channel confirmation:

Interference (Refer to ANSI C63.17 clause 7.3.4)	Reaction of EUT	Results
a) Apply the interference on f_1 at level T_U+U_M and no interference on f_2 . Initiate transmission and verify the transmission only on f_2 . Then terminate it.	EUT transmits on f_2	Pass
b) Apply the interference on f_2 at level T_L+U_M and immediately remove all interference from f_1 . The EUT should immediately attempt transmission on f_1 (but at least 20 ms after the interference on f_2 is applied), verify the transmission only on f_1 .	EUT transmission f_1	Pass

7) Random waiting, FCC §15.323(c) (6)

If the selected combined time and spectrum windows are unavailable, the device may either monitor and select different windows or seek to use the same window after waiting an amount of time, randomly chosen from a uniform random distribution between 10 and 150 milliseconds, commencing when the channel becomes available.

Test procedure:

This test is for EUTs that transmit control and signaling channels and that use the provisions of FCC §15.323(c)(6), thus to verify that the EUT (if in deferral) waits for a channel to go clear, then implements a 10 ms to 150 ms holdoff prior to using the channel. Test method according to ANSI C63.17 2006 clause 8.1.3

- a) Restrict operation of the EUT to a single carrier designated f_1 . For TDMA system, further restrict EUT transmission to a single timeslot of the usable timeslots available in the TDMA frame structure and synchronize the interference so as to occur centered within the timeslot.
- b) Activate the EUT with no interference present. The EUT must transmit on f_1 . Then apply CW interference on f_1 . The interference level shall be at $TU + UM$ or $TL + UM$ as appropriate for EUTs that do or do not meet the requirements for using the upper threshold. The EUT must stop transmitting within 30 s.
- c) Cancel the interference. Measure the time interval between the end of the interference transmission and the beginning of transmission by the EUT.
- d) Repeat step b) and step c) 100 times. If the measured time intervals vary uniformly between 10 ms and 150 ms, the EUT passes the test.

Test result:

Pass

8) Monitoring Bandwidth and Reaction Time, FCC §15.323(c) (7)

The monitoring system bandwidth must be equal to or greater than the emission bandwidth of the intended transmission and have a maximum reaction time less than $50 \times \text{SQRT}(1.25/\text{emission bandwidth in MHz})$ microseconds for signals at the applicable threshold level but shall not be required to be less than 50 microseconds

Test procedure:

Measurement method according to ANSI C63.17 2006 clause 7.5

- a) Restrict the EUT to a single transmit carrier frequency f_1 , and verify that the EUT can establish a connection with no interference applied on f_1 .
- b) Apply time-synchronized, pulsed interference on f_1 at the pulsed level $TU + UM$ or $TL + UM$, verify that the EUT does not establish a connection when the width of the interference pulse exceeds the largest of 50 μs and $50 \sqrt{1.25/B}$ μs , where B is the emission bandwidth of the EUT in megahertz.
- c) With the channel interference level 6 dB above $TU + UM$ or $TL + UM$, verify that the EUT does not establish a connection when the width of the interference pulse exceeds the largest of 35 μs and $35 \sqrt{1.25/B}$ μs , where B is the emission bandwidth of the EUT in megahertz.

Test Pulse width Equation (μs)	B(bandwidth) (MHz)	Pulse width (μs)	Limit (largest) (μs)
$50 (1.25/B)^{1/2}$	1.3025	48.98	50
$35 (1.25/B)^{1/2}$	1.3025	34.29	35

Test result:**1) Monitoring Bandwidth:**

The antenna of the EUT used for monitoring is the same interior antenna that used for transmission, so the monitoring system bandwidth is equal to the emission bandwidth of the intended transmission

2) Reaction Time Test:

No.	Interference Pulse width (μs)	Reaction of EUT	Result
1	50 μs with level T_U+U_M	No transmission	Pass
2	35 μs with level $T_U+U_M+6\text{dB}$	No transmission	Pass

9) Monitoring Antenna, FCC §15.323(c) (8)

The monitoring system shall use the same antenna used for transmission, or an antenna that yields equivalent reception at that location.

Test procedure:

Measurement method according to ANSI C63.17 2006 paragraph 4

Test result:

The antenna of the EUT used for transmission is the same interior antenna that used for monitoring.

10) Monitoring threshold relaxation, FCC §15.323(c) (9)

Devices that have a power output lower than the maximum permitted under the rules can increase their monitoring detection threshold by one decibel for each one decibel that the transmitter power is below the maximum permitted.

Test procedure:

Measurement method according to ANSI C63.17 2006 paragraph 4

Test result:

This requirement is covered by the results of Least Interfered Channel (LIC) based on FCC §15.323(c)(5).

11) Duplex Connections, FCC §15.323(c) (10)

An initiating device may attempt to establish a duplex connection by monitors both its intended transmit and receive time and spectrum windows. If both the intended transmit and receive time and spectrum windows meet the access criteria, then the initiating device can initiate a transmission in the intended transmit time and spectrum window. If the power detected by the responding device can be decoded as a duplex connection signal from the initiating device, then the responding device may immediately begin transmitting on the receive time and spectrum window monitored by the initiating device.

Test procedure:

This test validates proper operation of an EUT that operates according to the provisions of FCC §15.323(c)(10) using a check of both transmit and receive channels on one end of the link to qualify both ends of the link for transmissions. Test method according to ANSI C63.17 clause 8.3.2 Validation of dual access criteria check for EUTs that implement the upper threshold

- a) Adjust the path loss between the EUT and its companion device such that the received signal to the EUT from the companion device is at least 40 dB above $TL + UM$.
- b) Restrict the EUT and its companion device to operation at a single carrier f_1 for TDMA systems and on f_1 and f_2 and corresponding duplex carriers for FDMA systems. Verify that the EUT and its companion device can establish a connection on a time/spectrum window on the enabled carrier(s). Terminate the connection.
- c) Apply interference to the EUT on the EUT's *transmit* time/spectrum windows at $TL + UM$ per carrier on all time/spectrum windows except for one, which has interference at least 10 dB below TL . Adjust the interference to the EUT on its *receive* time/spectrum windows such that a single time/spectrum window has interference at least 10 dB below TL , and the interference on the other time/spectrum windows is at $TL + UM + 7$ dB. The interference to the companion device should be at least 10 dB below TL on all active time/spectrum windows. The interference-free *receive* time/spectrum window must not be the duplex mate of the interference-free *transmit* time/spectrum window.
- c) Cause the EUT to attempt to establish a connection. The connection should be made on the interference-free *receive* time/spectrum window and its duplex mate. Otherwise, the EUT fails the test.
- e) If a connection exists, terminate it. Reduce the interference on the EUT's *receive* time/spectrum windows to a level of $TL + UM$ per carrier on all time/spectrum windows except for one, which has interference at least 10 dB below TL . Raise the interference on the EUT's *transmit* time/spectrum windows to a level of $TL + UM + 7$ dB, maintaining one time/spectrum window with interference at least 10 dB below TL . The interference to the companion device should be at least 10 dB below TL on all active time/spectrum windows. Again, the interference-free *transmit* and *receive* time/spectrum windows should not constitute a duplex pair if the system designates a specific duplex pairing for time/spectrum windows.
- e) Cause the EUT to attempt to establish a connection. The connection should be made on the interference-free *transmit* time/spectrum window and its duplex mate. Otherwise, the system fails the test.

g) Terminate the connection and raise the interference to the EUT on all of the EUT’s *transmit* and *receive* time/spectrum windows to $TU + UM$ per carrier on all time/spectrum windows except for a single *transmit* time/spectrum window and a single *receive* time/spectrum window, which shall have interference at least 10 dB below TL . The low-interference *transmit* and *receive* time/spectrum windows shall not constitute a duplex pair. Adjust the path loss between the EUT and its companion device such that the received signal to the EUT from the companion device is at least 30 dB above TU . Cause the EUT to attempt to establish a connection. If a connection is established, the test fails.

Test result:

Interference (Refer to ANSI C63.17 § 8.3.2)	Reaction of EUT	Results
a) Only a single carrier $f1$ for EUT TDMA systems and on $f1$ and $f2$ and corresponding duplex carriers for FDMA systems.	EUT can transmit	Pass
b) All Tx windows with level $TL+UM$ except one & Rx windows with level $TL+UM+7dB$ except one, which are not the duplex mate.	Connected on the target Rx window and its duplex mate.	Pass
c) All Tx windows with level $TL+UM+7dB$ except one & Rx windows with level $TL+UM$ except one, which are not duplex mate.	Connected on the target Tx window and its duplex mate.	Pass
d) All Tx & Rx windows with level $TU+UM$, except one for Tx window & one for Rx window, which are not duplex mate.	No connection possible	Pass

12) Alternative monitoring interval, FCC §15.323(c) (11)

An initiating device that is prevented from monitoring during its intended transmit window due to monitoring system blocking from the transmissions of a co-located (within one meter) transmitter of the same system, may monitor the portions of the time and spectrum windows in which they intend to receive over a period of at least 10 milliseconds. The monitored time and spectrum window must total at least 50 percent of the 10 millisecond frame interval and the monitored spectrum must be within 1.25 MHz of the center frequency of channel(s) already occupied by that device or co-located co-operating devices. If the access criteria is met for the intended receive time and spectrum window under the above conditions, then transmission in the intended transmit window by the initiating device may commence.

Test procedure:

This test validates the ability of the EUT to distinguish between same-system and other-system interference for purposes of satisfying the requirement of 47CFR15.323(c) (11). Test method according to ANSI C63.17 2006 clause 8.4

- a) Adjust the path loss between the EUT and its companion device such that the received signal to the EUT from the companion device is at least 30 dB above TL .
- b) Restrict the EUT and its companion device to operation at a single carrier $f1$ for TDMA systems and on $f1$ and $f2$ and corresponding duplex carriers for FDMA systems. Verify that the EUT and its companion device can establish a connection.
- c) Apply interference at $TU + UM$ per carrier to the EUT on all *transmit* time/spectrum windows on the enabled carrier(s). The interference must use the same physical layer parameters (modulation, frame format, etc.) as the EUT transmissions, but with a system identifier different from that used by the EUT and the companion device. Ensure that the interference level at the companion device is at least 10 dB below TL . Apply no interference to the *receive* time/spectrum windows on the enabled carriers.
- d) Cause the EUT to attempt to establish a connection. If a connection is established, the test fails.

Test result:

Interference (Refer to ANSI C63.17 § 8.4)	Reaction of EUT	Results
a) Only a single carrier f_1 for EUT TDMA systems and on f_1 and f_2 and corresponding duplex carriers for FDMA systems.	EUT can transmit	Pass
b) Apply interference with same parameters as EUT transmissions on all Tx windows with level TU+UM on the enabled carrier(s) and no interference on the Rx windows on the enabled carriers.	No connection is established	Pass

13) Fair Access, FCC §15.323(c) (12)

The provisions of FCC §15.323 (c) (10) or (11) shall not be used to extend the range of spectrum occupied over space or time for the purpose of denying fair access to spectrum to other devices.

Test result:

The manufacturer declares that this device does not use any mechanisms as provided by FCC §15.323(c)(10) or (11) to extend the range of spectrum occupied over space or time for the purpose of denying fair access to spectrum to other device.

14) Frame Repetition Stability Frame Period and Jitter, FCC§15.323 (b)

The frame period (a set of consecutive time slots in which the position of each time slot can be identified by reference to a synchronizing source) of an intentional radiator operating in these sub-bands shall be 20 milliseconds or 10 milliseconds/X where X is a positive whole number.

Test procedure:

Measurement method according to ANSI C63.17 2006 clause 6.2.2, 6.2.3

Test result:

Frame Repetition Stability:

Frame Repetition Stability (ppm)	Limit (ppm)	Result (Pass/Fail)
0.91	10	Pass

Frame Period and Jitter:

Max. pos. Jitter (us)	Max. neg. Jitter (us)	Frame period (ms)	Limit	
			Frame Period (ms)	Jitter (us)
0.05	-0.06	8.4	20 or 10/X	0.24

Note: X is a positive whole number.

******* END OF REPORT *******