



# RADIO TEST REPORT

Report No.: STS2111002W03

Issued for

RTX HONG KONG LTD

8TH FL CORPORATION SQUARE, 8 LAM LOK ST., KOW-  
LOON BAY, HK.

<b>Product Name:</b>	RTX8436 DECT Handset
<b>Brand Name:</b>	RTX
<b>Model Name:</b>	RTX8436
<b>Series Model:</b>	N/A
<b>FCC ID:</b>	T7HCT8436
<b>Test Standard:</b>	Title 47 of the CFR, Part 15 Subpart D

Any reproduction of this document must be done in full. No single part of this document may be reproduced without permission from STS, All Test Data Presented in this report is only applicable to presented Test sample.

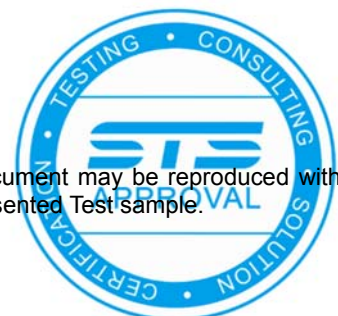



TEST RESULT CERTIFICATION

Applicant's Name : RTX HONG KONG LTD
Address : 8TH FL CORPORATION SQUARE, 8 LAM LOK ST., KOWLOON BAY, HK.
Manufacturer's Name : RTX HONG KONG LTD
Address : 8TH FL CORPORATION SQUARE, 8 LAM LOK ST., KOWLOON BAY, HK.

Product Description

Product Name : RTX8436 DECT Handset
Brand Name : RTX
Model Name : RTX8436
Series Model : N/A

Test Standards : Title 47 of the CFR, Part 15. Subpart D

Test procedure : ANSI C63.17-2013

This device described above has been tested by STS and the test results show that the equipment under test (EUT) is in compliance with the FCC requirements. And it is applicable only to the tested sample identified in the report.

This report shall not be reproduced except in full, without the written approval of STS, this document only be altered or revised by STS, personal only, and shall be noted in the revision of the document.

Date of Test :
Date of receipt of test item : 02 Nov. 2021
Date of performance of tests : 02 Nov. 2021 ~ 17 Nov. 2021
Date of Issue : 17 Nov. 2021
Test Result : Pass

Testing Engineer : [Signature] (Chris Chen)
Technical Manager : [Signature] (Sean she)
Authorized Signatory : [Signature] (Vita Li)





<b>TABLE OF CONTENTS</b>	<b>Page</b>
<b>SUMMARY OF TEST RESULTS</b>	<b>5</b>
<b>1 INTRODUCTION</b>	<b>7</b>
1.1 TEST FACTORY	7
1.2 MEASUREMENT UNCERTAINTY	7
<b>2 PRODUCT INFORMATION</b>	<b>8</b>
<b>3 TEST CONFIGURATION OF EQUIPMENT UNDER TEST</b>	<b>9</b>
3.1 DESCRIPTION OF NECESSARY ACCESSORIES AND SUPPORT UNITS	9
3.2 SYSTEM TEST CONFIGURATION	10
<b>4 MEASUREMENT INSTRUMENTS</b>	<b>11</b>
<b>5 TEST ITEMS</b>	<b>13</b>
5.1 ANTENNA REQUIREMENT	13
5.2 MODULATION TECHNIQUES	13
5.3 EMISSION BANDWIDTH	14
5.4 PEAK TRANSMIT POWER	19
5.5 POWER SPECTRAL DENSITY	24
5.6 POWER ADJUSTMENT FOR ANTENNA GAIN	27
5.7 AUTOMATICALLY DISCONTINUE TRANSMISSION	28
5.8 SYSTEM ACKNOWLEDGE-MENT TEST	29
5.9 MONITORING THRESHOLD	30
5.10 DURATION OF TRANSMISSION	31
5.11 SELECTED CHANNEL CONFIRMATION, POWER ACCURACY, SEGMENT OCCUPANCY	32
5.12 RANDOM WAITING	34
5.13 MONITORING REQUIREMENTS	35
5.14 MONITORING ANTENNA	36
5.15 DUPLEX CONNECTIONS	36
5.16 ALTERNATIVE MONITORING INTERVAL FOR CO-LOCATED DEVICES	37
5.17 FAIR ACCESS	37
5.18 SPURIOUS EMISSIONS	38
5.19 FRAME PERIOD	46
5.20 FREQUENCY STABILITY	47
5.21 CONDUCTED EMISSION MEASUREMENT	49
5.22 RADIATED SPURIOUS EMISSION	53



**Revision History**

Rev.	Issue Date	Report NO.	Effect Page	Contents
00	17 Nov. 2021	STS2111002W03	ALL	Initial Issue





**SUMMARY OF TEST RESULTS**

Test procedures according to the technical standards:

The following tests were conducted on a sample of the equipment for the purpose of demonstrating compliance with Part 15 Subpart D.

Requirement	FCC Part	Test Procedure	Result
Emission Bandwidth	15.323 (a)	6.1.3	Compliant
Labeling Requirements	15.19(a)(3)	--	Compliant
Conducted Emissions	15.315 & 15.207	ANSI C63.4	Compliant
Antenna Requirements	15.317 & 15.203	Declaration	Compliant
Use digital modulation	15.319 (b)	6.1.4	Compliant
Peak transmit power	15.319 (c)	6.1.2	Compliant
Power spectral density	15.319 (d)	6.1.5	Compliant
Power adjustment for antenna gain	15.319 (e)	4.3.1	Compliant
Automatically discontinue transmission	15.319 (f)	--	Compliant
Spurious emissions conducted	15.323 (d) (1) & 15.323 (d) (2)	6.1.6	Compliant
RF Exposure	15.319 (i) & 1.1307(b), 2.1091 and 2.1093	ANSI/IEEE C95.1	Compliant (The test data please refer to RF exposure report)
Monitoring time	15.323 (c)(1)	7.3.4	Compliant
Monitoring threshold	15.323 (c)(2)	7.3	Compliant
Duration of transmission	15.323 (c)(3)	8.2.2	Not Applicable
System acknowledgment test	15.323(c)(4)	8.2.1	Compliant
Channel confirmation, Power accuracy, Segment occupancy	15.323 (c)(5)	7.3.3 & 7.3.4	Compliant
Random waiting	15.323 (c)(6)	8.1.3	Not Applicable



Monitoring bandwidth	15.323 (c)(7)	7.4	Compliant
Monitoring reaction time	15.323 (c)(1 )	7.5	Compliant
Monitoring antenna	15.323 (c)(8)	4	Compliant
Monitoring threshold relaxation	15.323 (c)(9)	4	Compliant
Duplex connections	15.323 (c)(10)	8.3	Not Applicable
Alternate monitoring interval	15.323 (c)(11)	8.4	Not Applicable
Fair access	15.323 (c)(12)	Declaration	Not Applicable
Frame period	15.323 (e)	6.2.2 & 6.2.3	Compliant
Frequency stability	15.323 (f)	6.2.1	Compliant
Radiated Out of Band Emissions	15.319 (g), 15.309 (b) & FCC Part 15 Subpart B, 15.109 and 15.209	--	Compliant



## 1 INTRODUCTION

### 1.1 TEST FACTORY

SHENZHEN STS TEST SERVICES CO., LTD

Add. : A 1/F, Building B, Zhuoke Science Park, No.190 Chongqing Road, HepingShequ, Fuyong Sub-District, Bao'an District, Shenzhen, Guang Dong, China

FCC test Firm Registration Number: 625569

IC test Firm Registration Number: 12108A

A2LA Certificate No.: 4338.01

### 1.2 MEASUREMENT UNCERTAINTY

The reported uncertainty of measurement  $y \pm U$ , where expanded uncertainty  $U$  is based on a standard uncertainty multiplied by a coverage factor of  $k=2$ , providing a level of confidence of approximately 95 %.

No.	Item	Uncertainty
1	RF output power, conducted	$\pm 0.68\text{dB}$
2	Unwanted Emissions, conducted	$\pm 2.988\text{dB}$
3	All emissions, radiated 30-1GHz	$\pm 5.6\text{dB}$
4	All emissions, radiated 1G-6GHz	$\pm 5.5\text{dB}$
5	All emissions, radiated >6G	$\pm 5.8\text{dB}$
6	Conducted Emission (9KHz-150KHz)	$\pm 3.37\text{dB}$
7	Conducted Emission (150KHz-30MHz)	$\pm 3.83\text{dB}$



## 2 PRODUCT INFORMATION

Product Name	RTX8436 DECT Handset
Brand Name	RTX
Model Name	RTX8436
Series Model	N/A
Product Differences	N/A
Hardware version number	V2
Software version number	V0700
EUT Frequency Ranges	1921.536-1928.448MHz
Type of Modulations	PP64Z
Number of Channels	5 CH. Please see Note 2.
Antenna Type	PCB Antenna
Antenna Gain	ANT 1: 1dBi ANT 2: 1dBi
Battery	Model: BP1709/A Rated Voltage: 3.7V Capacity: 1100mAh
Adapter	Multi plug: Model: S008ACM0500100 Input: AC 100-240V 50/60Hz 0.3A Output: DC 5.0V 1.0A 5.0W US plug: Model: S005CAU0500100 Input: AC 100-240V 50/60Hz 200mA Output: DC 5.0V 1000mA
Work Temperature	-15°C to 50°C

## Note:

1. ANT 1 and ANT 2 cannot transmit simultaneously.
2. Pre-test P32Z and PP64Z, only the worst mode PP64Z was recorded in this report.
3. Channel list:

Channel	Frequency (MHz)	Channel	Frequency (MHz)	Channel	Frequency (MHz)
04	1921.536	03	1923.264	02	1924.992
01	1926.720	00	1928.448	--	--





3 TEST CONFIGURATION OF EQUIPMENT UNDER TEST

Radiated Spurious Emission Test



Conducted Emission Test

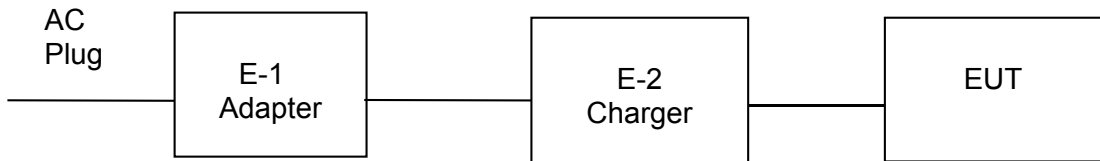

3.1 DESCRIPTION OF NECESSARY ACCESSORIES AND SUPPORT UNITS

The EUT has been tested as an independent unit together with other necessary accessories or support units. The following support units or accessories were used to form a representative test configuration during the tests.

Necessary accessories

Item	Equipment	Mfr/Brand	Model/Type No.	Length	Note
/	Adapter	N/A	Multi Plug: S008ACM0500100 US Plug: S005CAU0500100	N/A	N/A
/	Battery	Tianmao	BP1709/A	N/A	N/A
/	RTX8436 Charger	RTX	N/A	190cm	Un-shielded

Support units

Item	Equipment	Mfr/Brand	Model/Type No.	Length	Note
N/A	N/A	N/A	N/A	N/A	N/A

Note:

- (1) For detachable type I/O cable should be specified the length in cm in 『Length』 column.

### 3.2 SYSTEM TEST CONFIGURATION

Figure 1:



Figure 2:

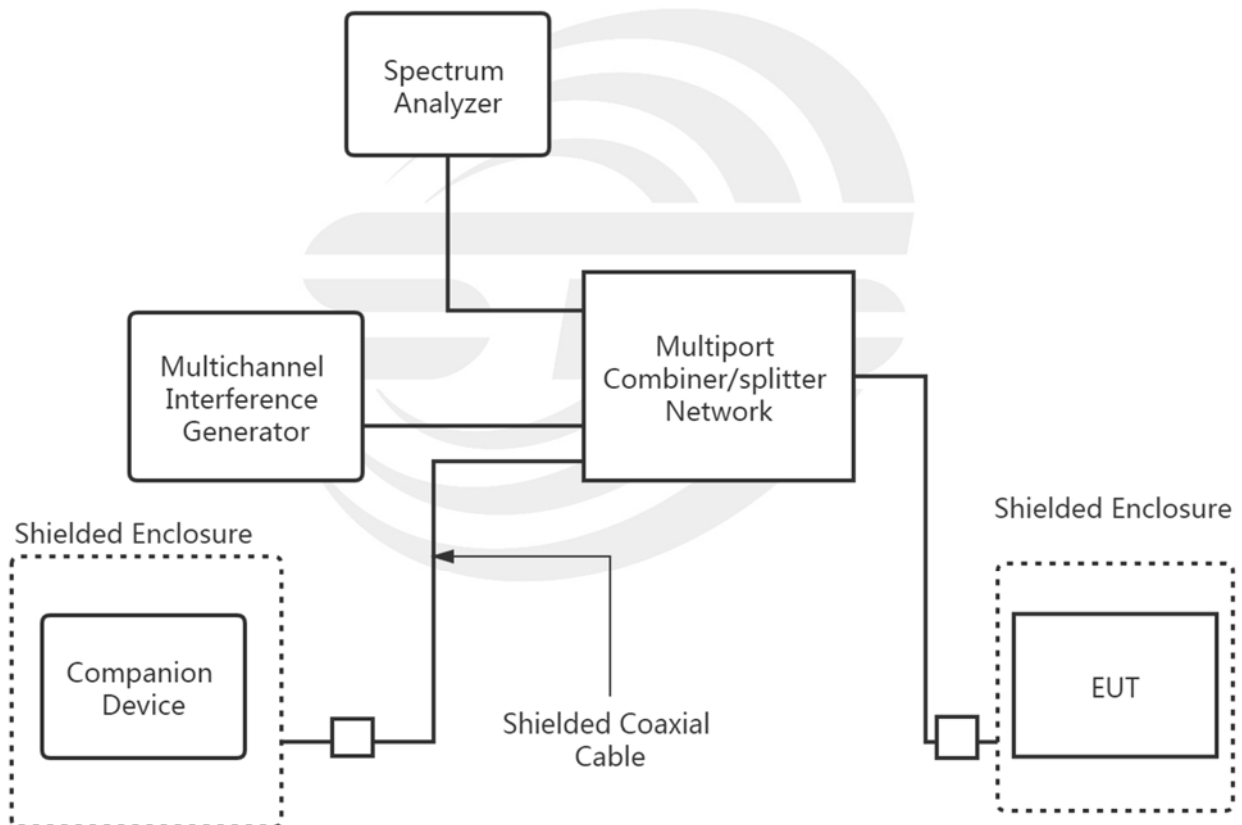



## 4 MEASUREMENT INSTRUMENTS

## Radiation Test equipment

Kind of Equipment	Manufacturer	Type No.	Serial No.	Last calibration	Calibrated until
Active loop Antenna	ZHINAN	ZN30900C	16035	2021.04.11	2023.04.10
Bilog Antenna	TESEQ	CBL6111D	34678	2020.10.12	2022.10.11
Horn Antenna	SCHWARZBECK	BBHA 9120D	02014	2021.10.11	2023.10.10
Pre-Amplifier(0.1M-3GHz)	EM	EM330	060665	2021.10.08	2022.10.07
Pre-Amplifier (1G-18GHz)	SKET	LNPA-01018G-45	SK2018080901	2021.09.30	2022.09.29
Test Receiver	R&S	ESCI	101427	2021.09.30	2022.09.29
Signal Analyzer	R&S	FSV 40-N	101823	2021.09.30	2022.09.29
Temperature & Humidity	HH660	Mieo	N/A	2021.10.09	2022.10.08
Turn table	EM	SC100_1	60531	N/A	N/A
Antenna mast	EM	SC100	N/A	N/A	N/A
AC Power Source	APC	KDF-11010G	F214050035	N.C.R	N.C.R
Test SW	FARAD	EZ-EMC(Ver.STSLAB-03A1 RE)			

## Conduction Test equipment

Kind of Equipment	Manufacturer	Type No.	Serial No.	Last calibration	Calibrated until
Test Receiver	R&S	ESCI	101427	2021.09.30	2022.09.29
LISN	R&S	ENV216	101242	2021.09.30	2022.09.29
LISN	EMCO	3810/2NM	23625	2021.09.30	2022.09.29
Temperature & Humidity	HH660	Mieo	N/A	2021.10.09	2022.10.08
Test SW	FARAD	EZ-EMC(Ver.STSLAB-03A1 RE)			



## RF Connected Test

Kind of Equipment	Manufacturer	Type No.	Serial No.	Last calibration	Calibrated until
Signal Analyzer	Agilent	N9020A	MY51110105	2021.03.04	2022.03.03
Signal Generator	Agilent	N5182A	MY46240556	2021.09.30	2022.09.29
RF Test Platform for DECT	RTX	RTX 2012 HS	1138-6122	2021.03.04	2022.03.03
Temperature & Humidity	HH660	Mieo	N/A	2021.10.09	2022.10.08
Temperature & Humidity test chamber	Safety test	AG80L	171200018	2021.03.04	2022.03.03
Programmable power supply	Agilent	E3642A	MY40002025	2021.10.08	2022.10.07
Attenuator	HP	8494B	DC-18G	2021.04.28	2022.04.27
AC Power Source	APC	KDF-11010G	F214050035	N.C.R	N.C.R
Test SW	FARAD	EZ-EMC(Ver.STSLAB-03A1 RE)			

Equipment with a calibration date of "NCR" shown in this list was not used to make direct calibrated measurements.



## 5 TEST ITEMS

### 5.1 ANTENNA REQUIREMENT

#### TEST OVERVIEW

§ 15.203: An intentional radiator shall be designed to ensure that no antenna other than that furnished by the responsible party shall be used with the device. The use of a permanently attached antenna or of an antenna that uses a unique coupling to the intentional radiator shall be considered sufficient to comply with the provisions of this section. The manufacturer may design the unit so that a broken antenna can be replaced by the user, but the use of a standard antenna jack or electrical connector is prohibited.

The structure and application of the EUT were analyzed to determine compliance with Section 15.203 of the Rules. Section 15.203 states that the subject device must meet at least one of the following criteria:

- a.) Antenna must be permanently attached to the unit.
- b.) Antenna must use a unique type of connector to attach to the EUT.
- c.) Unit must be professionally installed. Installer shall be responsible for verifying that the correct antenna is employed with the unit.

#### TEST RESULT

The EUT as tested is compliant the criteria of §15.203. The antenna is permanently attached to the unit.

### 5.2 MODULATION TECHNIQUES

#### TEST REQUIREMENT

All transmissions must use only digital modulation techniques.

#### TEST PROCEDURES

Attestation of manufacturer supported by reference to relevant DECT specifications.

#### ATTESTATION

This device is compliant with the DECT standards described in European Standards EN 300 175-2 and EN 300 175-3. DECT transmissions are MC/TDMA/TDD (Multi carrier / Time Division Multiple Access / Time Division Duplex) using Digital GFSK modulation. For further details see operational description or relevant portions of the DECT standards.

#### TEST RESULTS

The EUT as tested is compliant the criteria of §15.319(b).



### 5.3 EMISSION BANDWIDTH

#### TEST OVERVIEW

§ 15.323(a): For purposes of this subpart the emission bandwidth shall be determined by measuring the width of the signal between two points, one below the carrier center frequency and one above the carrier center frequency, that are 26 dB down relative to the maximum level of the modulated carrier. Compliance with the emissions limits is based on the use of measurement instrumentation employing a peak detector function with an instrument resolutions bandwidth approximately equal to 1.0 percent of the emission bandwidth of the device under measurement.

#### TEST PROCEDURE

Operation shall be contained within the 1920-1930 MHz band. The emission bandwidth shall be less than 2.5 MHz. The power level shall be as specified in §15.319(c), but in no event shall the emission bandwidth be less than 50 kHz.

#### TEST SETUP

The test setup is shown in section 3.2 figure 1.

#### TEST RESULTS

The Eut was compliant with this requirement.

ANT 1

Channel	26dB BW(MHz)	99% BW(MHz)	Limit
Low	1.419	1.2237	<2.5MHz
Mid	1.427	1.2166	
High	1.419	1.2444	
AVG	1.421667	1.228233	

ANT 2

Channel	26dB BW(MHz)	99% BW(MHz)	Limit
Low	1.430	1.2187	<2.5MHz
Mid	1.419	1.2214	
High	1.431	1.2225	
AVG	1.426667	1.220867	



ANT 1

Plot 1. Emission Bandwidth, Channel 4 @ 1921.536 MHz

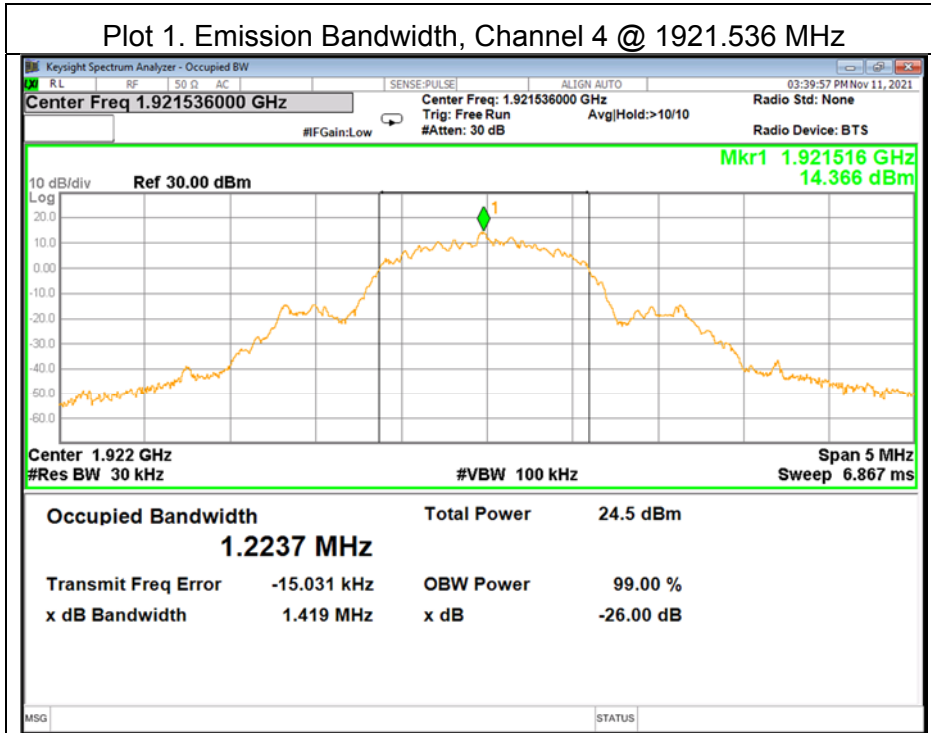

Plot 2. Emission Bandwidth, Channel 2 @ 1924.992 MHz

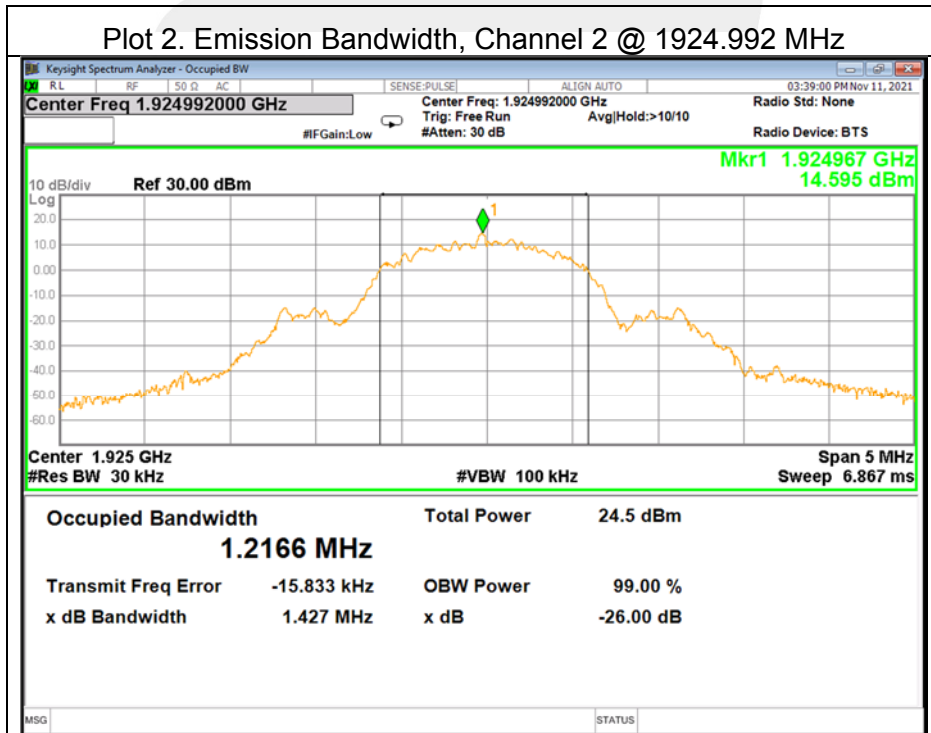



Plot 3. Emission Bandwidth, Channel 0 @ 1928.448 MHz

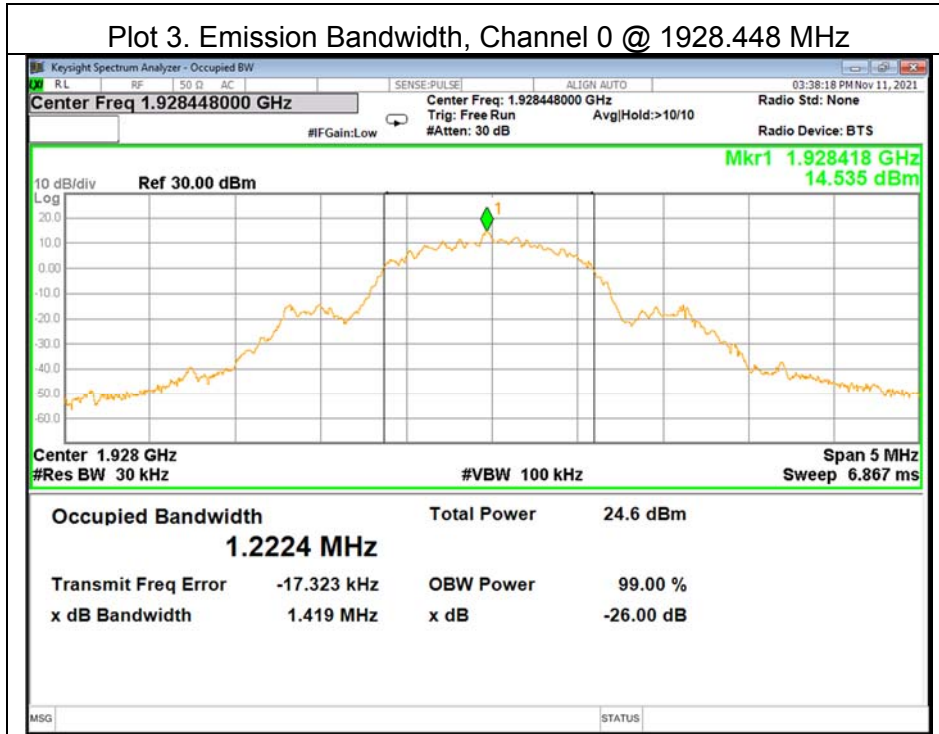





ANT 2

Plot 1. Emission Bandwidth, Channel 4 @ 1921.536 MHz

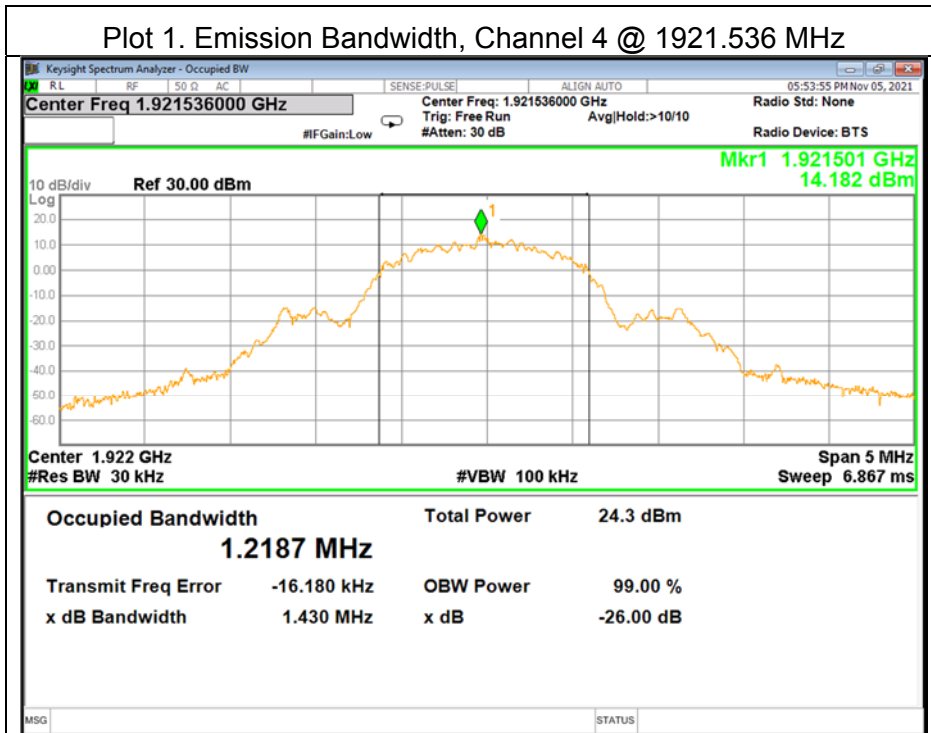

Plot 2. Emission Bandwidth, Channel 2 @ 1924.992 MHz

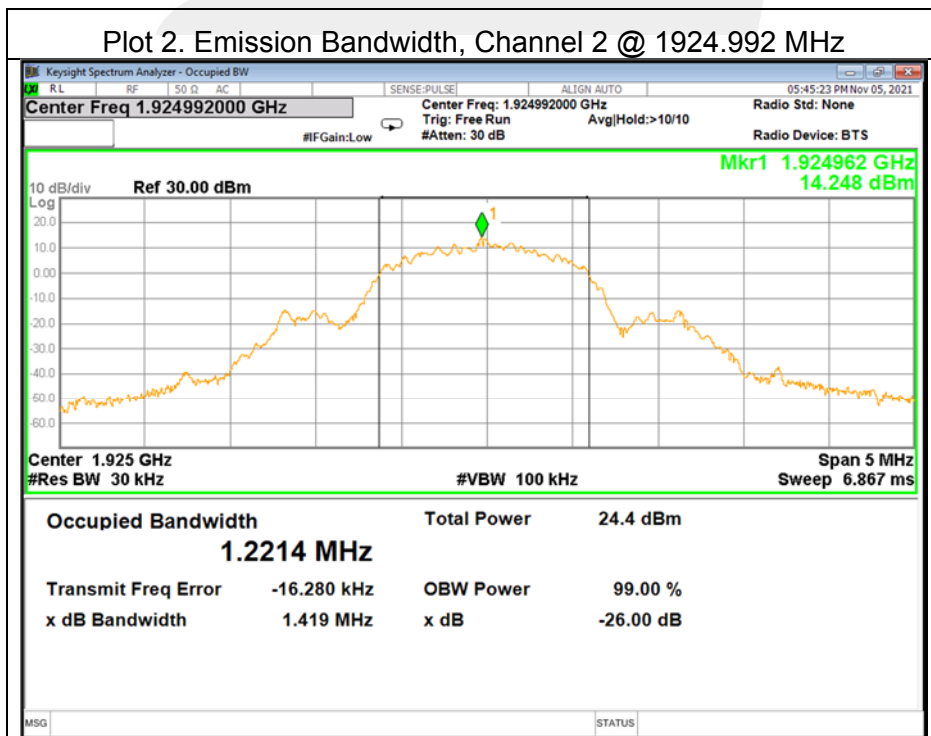



Plot 3. Emission Bandwidth, Channel 0 @ 1928.448 MHz

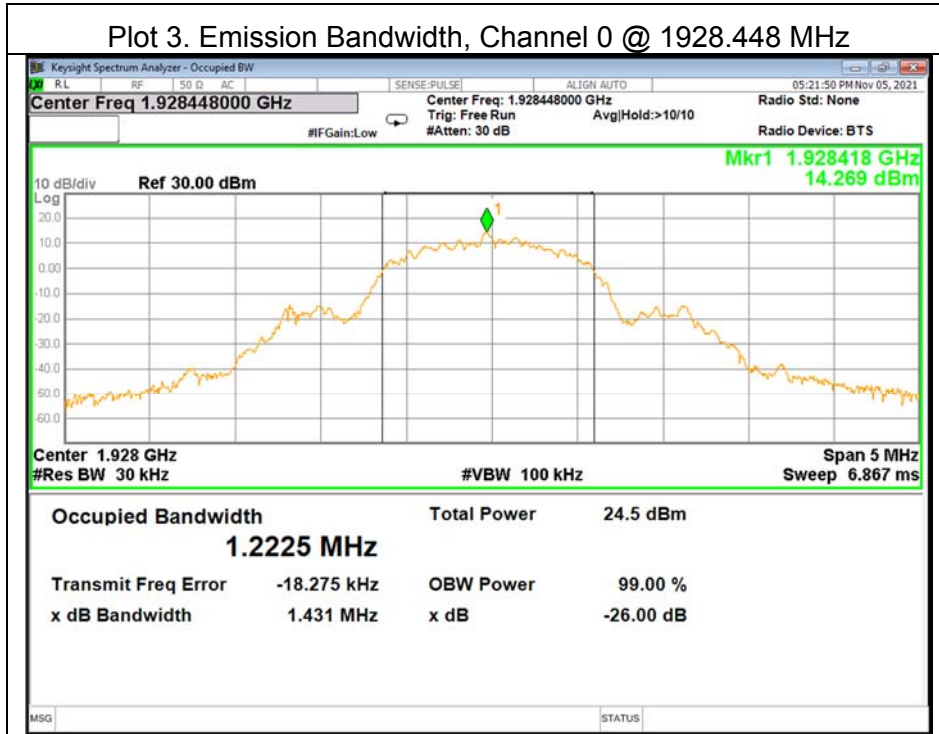



## 5.4 PEAK TRANSMIT POWER

### TEST OVERVIEW

§15.319(c): The peak transmit power shall not exceed 100 microwatts multiplied by the square root of the emission bandwidth in hertz. Peak transmit power must be measured over any interval of continuous transmission using instrumentation calibrated in terms of an rms equivalent voltage. The measurement results shall be properly adjusted for any instrument limitations, such as detector response times, limited resolution bandwidth capability when compared to the emission bandwidth, sensitivity, etc., so as to obtain a true peak measurement for the emission in question over the full bandwidth of the channel.

### TEST PROCEDURE

Testing to ANSI C63.17-2013 Clause 6.1.2, which provides the test methodology for this provision. The EUT is controlled from a personal computer and set into continuous transmission mode.

### TEST SETUP

The test setup is shown in section 3.2 figure 1.

### TEST RESULTS

ANT 1				
Carrier Channel	Frequency (MHz)	Measured Peak Output Power (dBm)	Limit (uw)	Limit (dbm)
Low	1921.536	19.75	119122	20.76
Mid	1924.992	20.09	119457	20.77
High	1928.448	20.09	119122	20.76
EBWLow Channel=	1419000			Hz
EBWMid Channel=	1427000			Hz
EBWHigh Channel=	1419000			Hz
Note:Peak Transmitter Power Limit=100 (EBW) 1/2 $\mu$ W				

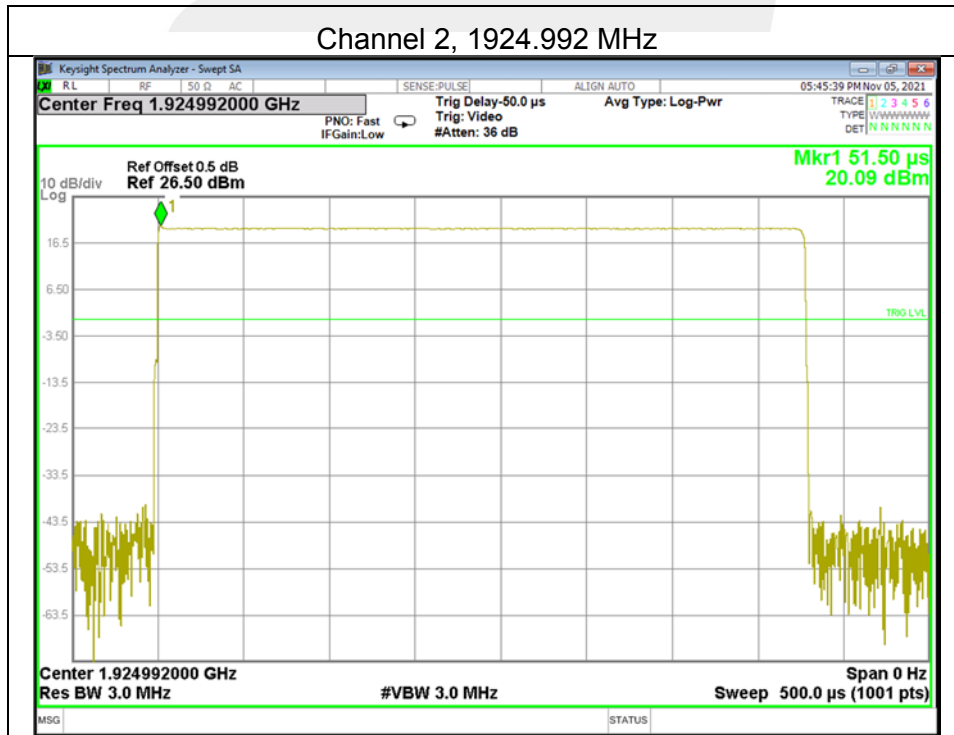
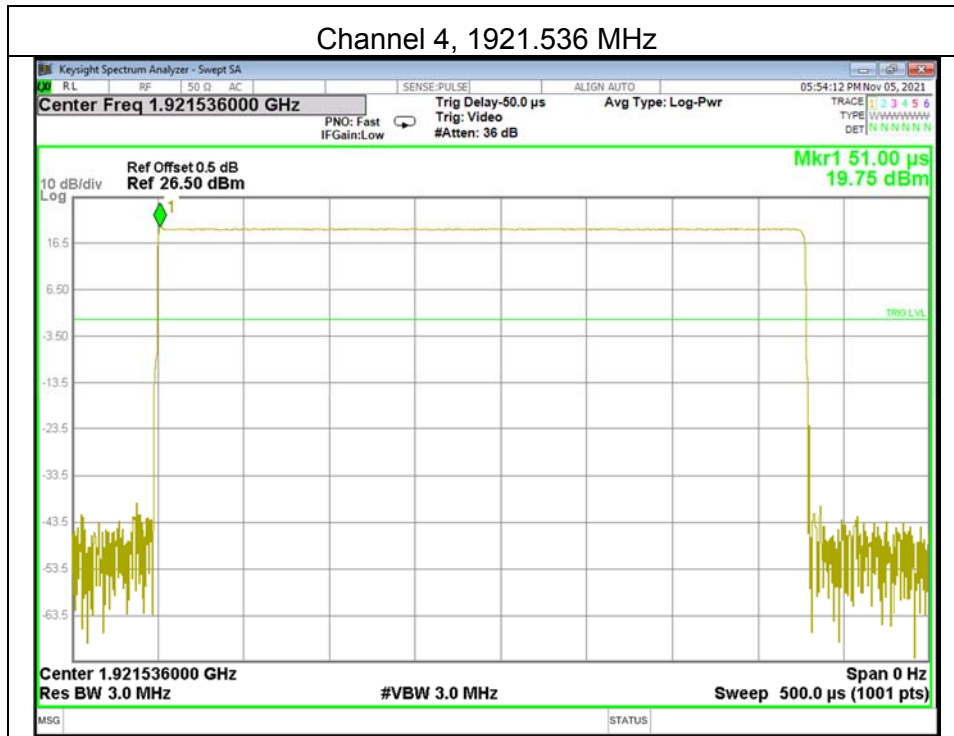

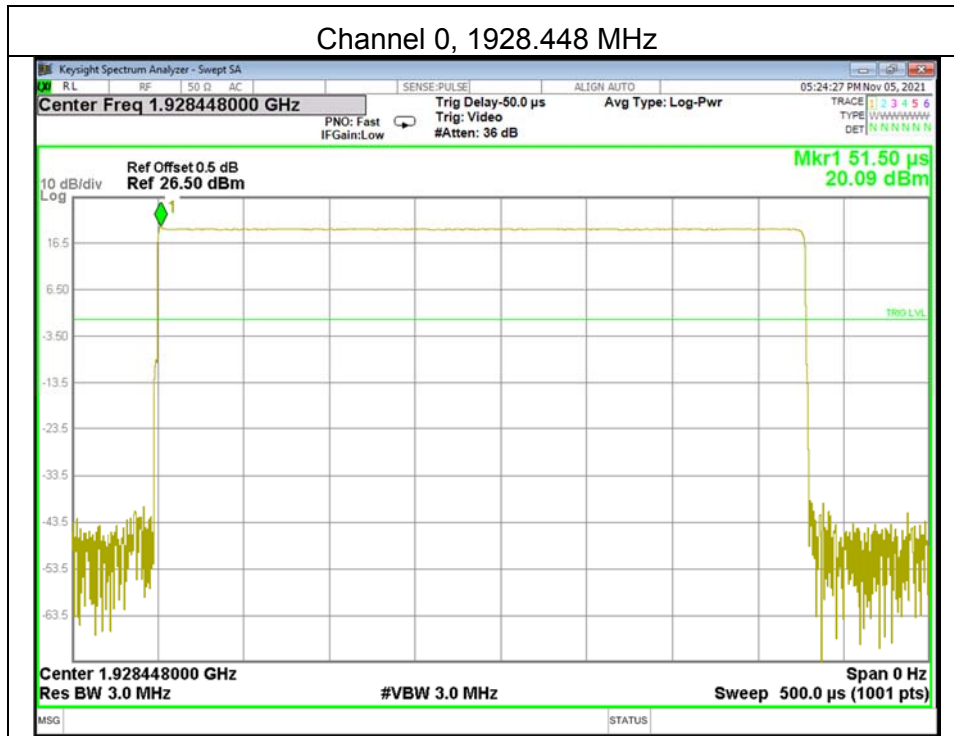



ANT 2

Carrier Channel	Frequency (MHz)	Measured Peak Output Power (dBm )	Limit ( uw )	Limit ( dbm )
Low	1921.536	19.86	119583	20.78
Mid	1924.992	20.42	119122	20.76
High	1928.448	20.40	119624	20.78
EBWLow Channel=		1430000		Hz
EBWMid Channel=		1419000		Hz
EBWHigh Channel=		1431000		Hz
Note:Peak Transmitter Power Limit=100 (EBW) 1/2 μ W				

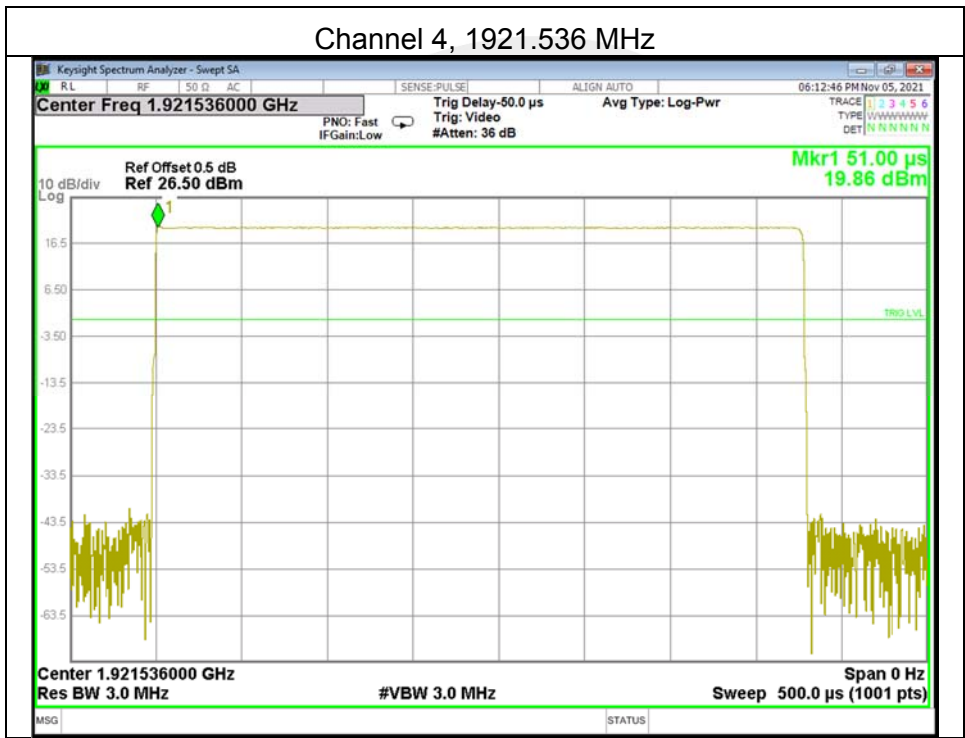

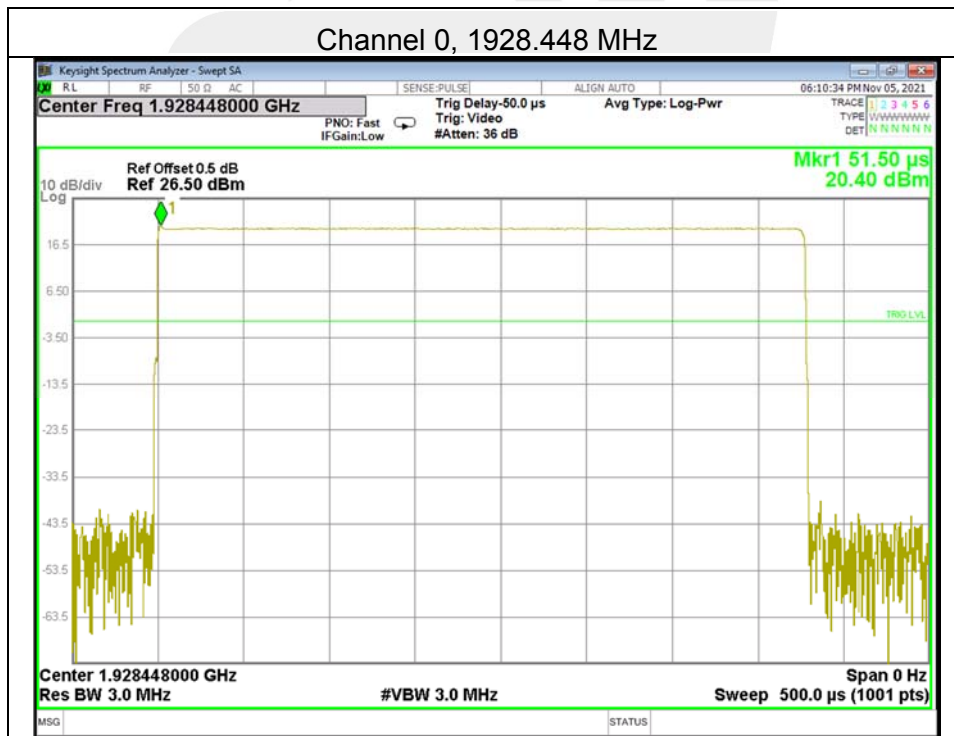
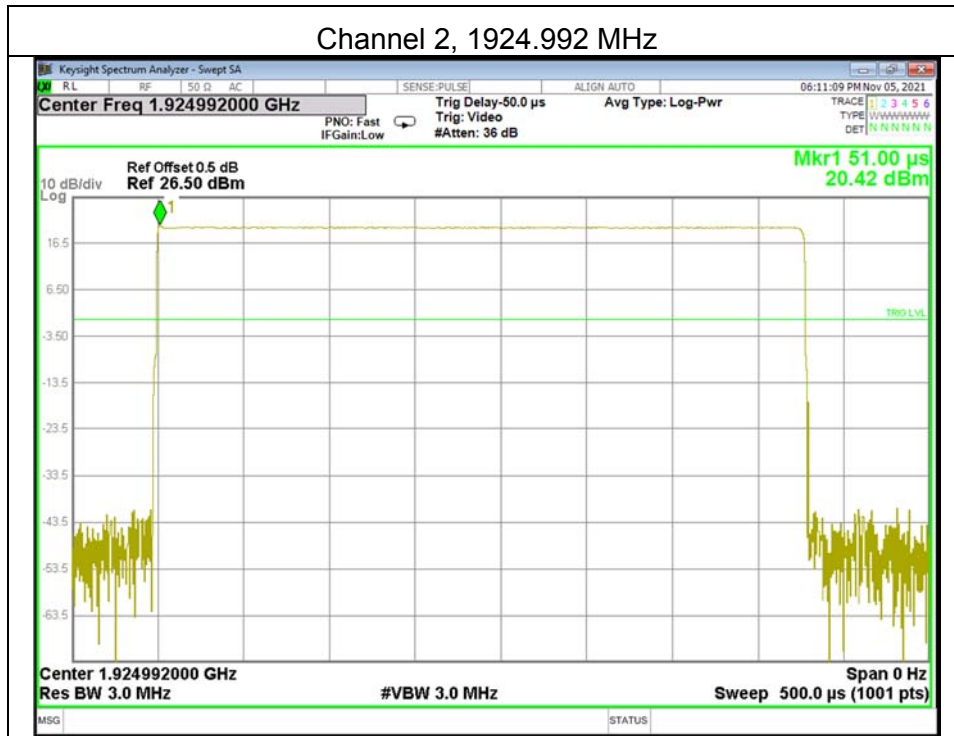



## 5.5 POWER SPECTRAL DENSITY TEST OVERVIEW

§15.319(d): Power spectral density shall not exceed 3 milliwatts in any 3 kHz bandwidth as measured with a spectrum analyzer having a resolution bandwidth of 3 kHz.

### TEST PROCEDURE

Testing to ANSI C63.17-2013 Clause 6.1.5, which provides the test methodology for this provision.

### TEST SETUP

The test setup is shown in section 3.2 figure 1.

### TEST RESULTS

Note: Both ANT 1 and ANT 2 have been tested, the worst case is ANT 2, and only shown the worst case in this report.

#### ANT 2

Carrier Channel	Frequency (MHz)	Measured Peak Power Spectral Density (dBm)	Limit(mw)	Limit(dBm)
Low(4)	1921.536	-0.50	3	4.77
Mid(2)	1924.992	-0.54		
High(0)	1928.448	-0.83		



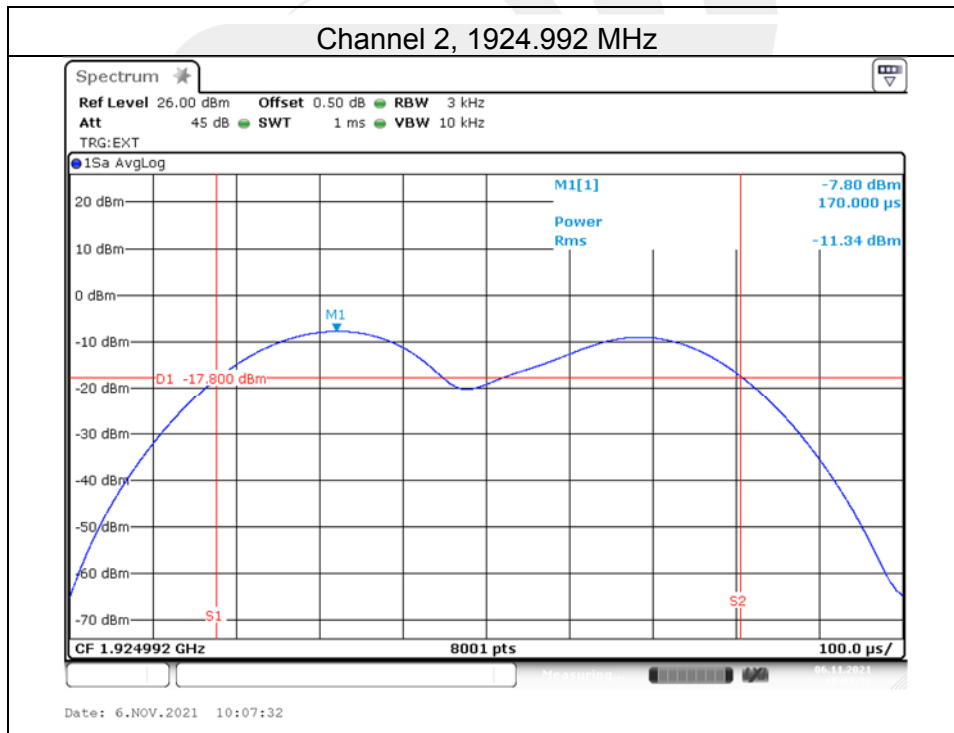
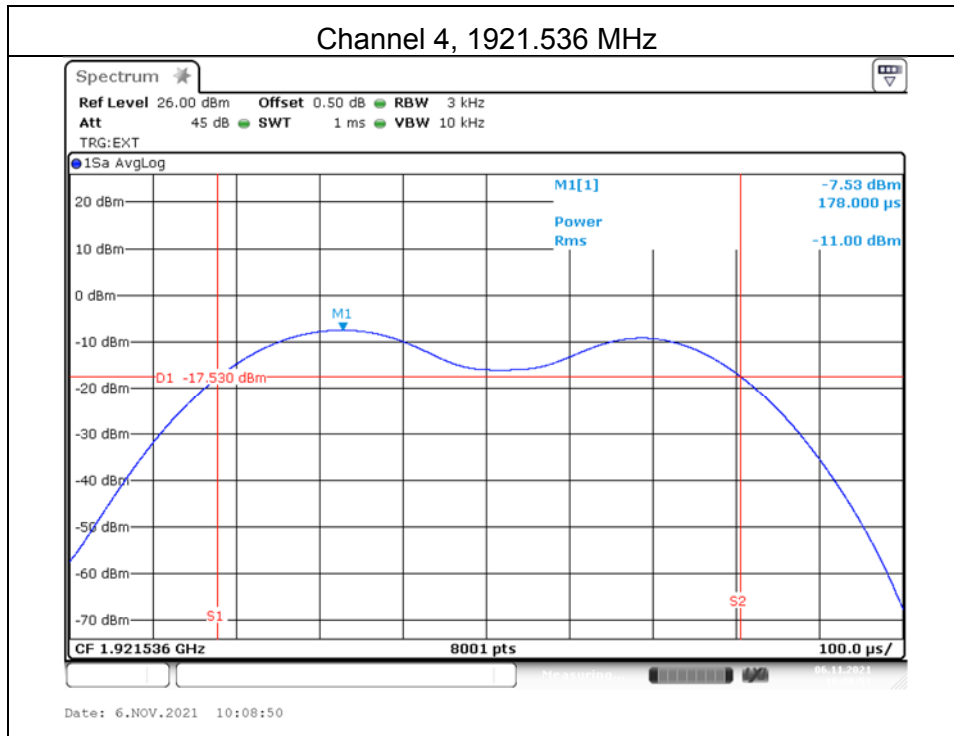

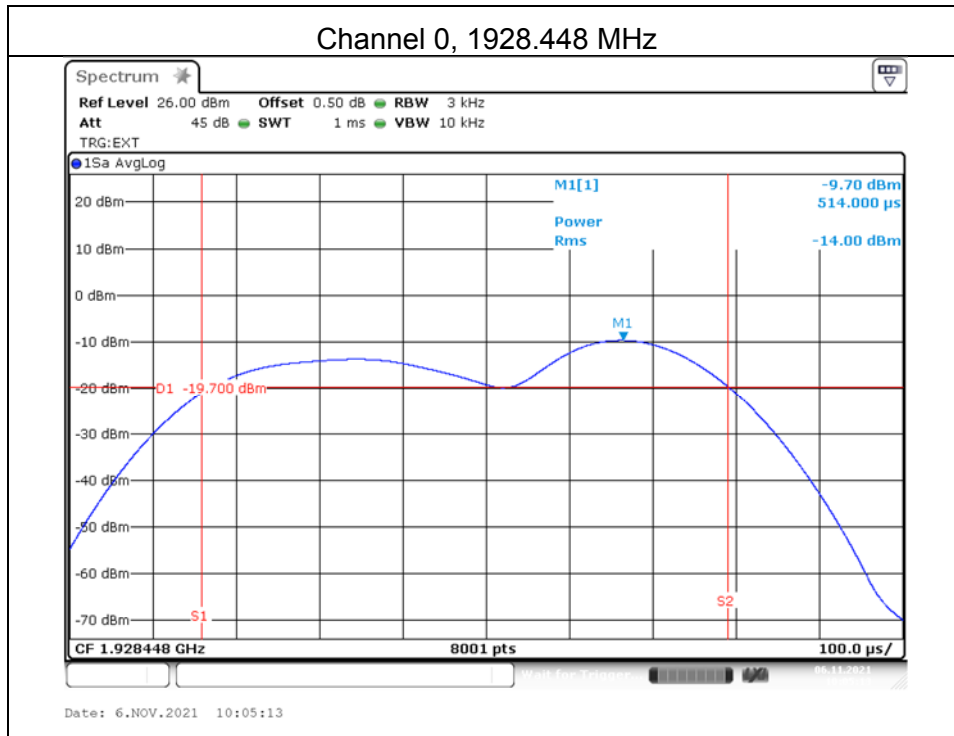



## 5.6 POWER ADJUSTMENT FOR ANTENNA GAIN

### TEST OVERVIEW

§15.319(e): The peak transmit power shall be reduced by the amount in decibels that the maximum directional gain of the antenna exceeds 3 dBi.

### TEST PROCEDURE

Testing to ANSI C63.17-2013 Clause 4.3.1, which provides the test methodology for this provision.

### TEST RESULT

Equipment Employs a 1 dBi Antenna. Max output power allowed with this gain by the EUT is 20.42dBm.

The Max output power does not need to be reduced.

The Output Power complies with the Power Adjustment for Antenna Gain requirements of §15.319(e).





## 5.7 AUTOMATICALLY DISCONTINUE TRANSMISSION

### OVERVIEW

§15.319(f): The device shall automatically discontinue transmission in case of either absence of information to transmit or operational failure. These provisions are not intended to preclude transmission of control and signaling information or use of repetitive codes used by certain digital technologies to complete frame or burst intervals.

### TEST RESULTS

	Test	Reaction of EUT	Result
1	Remove Power from Companion Device	A	Pass
2	Switch off the companion device	A	Pass
3	Terminate call at the companion device	NA1	Pass
4	Switch off the EUT	NA2	Pass
5	Terminate call at the EUT	NA3	Pass

A - Connection was terminated and transmission ceased.

B - Connection was terminated but the EUT transmits control or signaling information.

C - Connection was terminated but the companion device transmits control or signaling information.

NA 1 - Companion Device does not have an on/off switch for terminate call.

NA 2 - EUT does not have an on/off switch.

NA 3 – EUT does not have a switch for terminate call.



## 5.8 SYSTEM ACKNOWLEDGE-MENT TEST

### TEST OVERVIEW

§ 15.323(c)(4): Once access to specific combined time and spectrum windows is obtained an acknowledgment from a system participant must be received by the initiating transmitter within one second or transmission must cease. Periodic acknowledgments must be received at least every 30 seconds or transmission must cease. Channels used exclusively for control and signaling information may transmit continuously for 30 seconds without receiving an acknowledgment, at which time the access criteria must be repeated.

### TEST PROCEDURE

Measurement method according to ANSI C63.17 2013 clause 8.2.1

During testing initial transmission without acknowledgement, the signal from the EUT to the companion device is blocked by the circulator.

The test of the transmission time after loss of acknowledgements is performed by cutting off the signal from the companion device by a RF switch and measuring the time until the EUT stops transmitting.

### TEST SETUP

The test setup is shown in section 3.2 figure 2.

### TEST RESULTS

Note: Both ANT 1 and ANT 2 have been tested, the worst case is ANT 2, and only shown the worst case in this report.

#### ANT 2

Test	Time taken (second)	Limit (second)	Result
Initial Connection acknowledgement	0.81	1	Pass
Change of access criteria for control information	N/A	30	N/A
Transmission cease time after loss of acknowledgement	4.04	30	Pass



## 5.9 MONITORING THRESHOLD

### TEST OVERVIEW

§15.323 (c)(2). The monitoring threshold must not be more than 30 dB above the thermal noise power for a bandwidth equivalent to the emission bandwidth used by the device.

§15.323 (c)(9). Devices that have a power output lower than the maximum permitted under this sub-part may increase their monitoring detection threshold by one decibel for each one decibel that the transmitter power is below the maximum permitted.

### TEST PROCEDURE

Testing to ANSI C63.17-2013 Clause 7.3, which provides the test methodology for this provision. The Clause states that the lower threshold is for devices that do not use the LIC procedure. The equation for the lower monitoring threshold is given in ANSI C63.17 Clause 4.3.4.

### TEST SETUP

The test setup is shown in section 3.2 figure 2.

### TEST RESULTS

Note: Both ANT 1 and ANT 2 have been tested, the worst case is ANT 2, and only shown the worst case in this report.

ANT 2		
Upper Threshold		
B	1426667	MHz
Mu	50	dB
Peut	20.40	dBm
TU	-62.085	dBm
Lower Threshold		
B	1426667	MHz
MI	30	dB
Peut	19.86	dBm
TL	-81.545	dBm

### ATTESTATION

The sensor will go into hibernation after a few minutes. It is not possible to keep a connection running very long. Therefore, this requirement is not applicable.



5.10 DURATION OF TRANSMISSION  
TEST OVERVIEW

§15.323 (c)(3) If no signal above the threshold level is detected, transmission may commence and continue with the same emission bandwidth in the monitored time and spectrum windows without further monitoring. However, occupation of the same combined time and spectrum windows by a device or group of cooperating devices continuously over a period of time longer than 8 hours is not permitted without repeating the access criteria.

TEST PROCEDURE

Testing to ANSI C63.17-2013 Clause 4, which provides the test methodology for this provision. A communication link is established between BS and MS in a conducted mode and in a room without other US DECT devices to prevent influence from other transmissions. According to FCC Part 15.323(c)(3), the access criteria have to be verified at least every 8 hours. The following test is performed:

TEST SETUP

The test setup is shown in section 3.2 figure 2.

TEST RESULT

Note: Both ANT 1 and ANT 2 have been tested, the worst case is ANT 2, and only shown the worst case in this report.

ANT 2

Test ref. to ANSI C63.17:2013 clause 8.2.2	Observation result(H)	Limit(H)	Verdict
Transmission duration on same time and frequency window	0.27	8	Pass

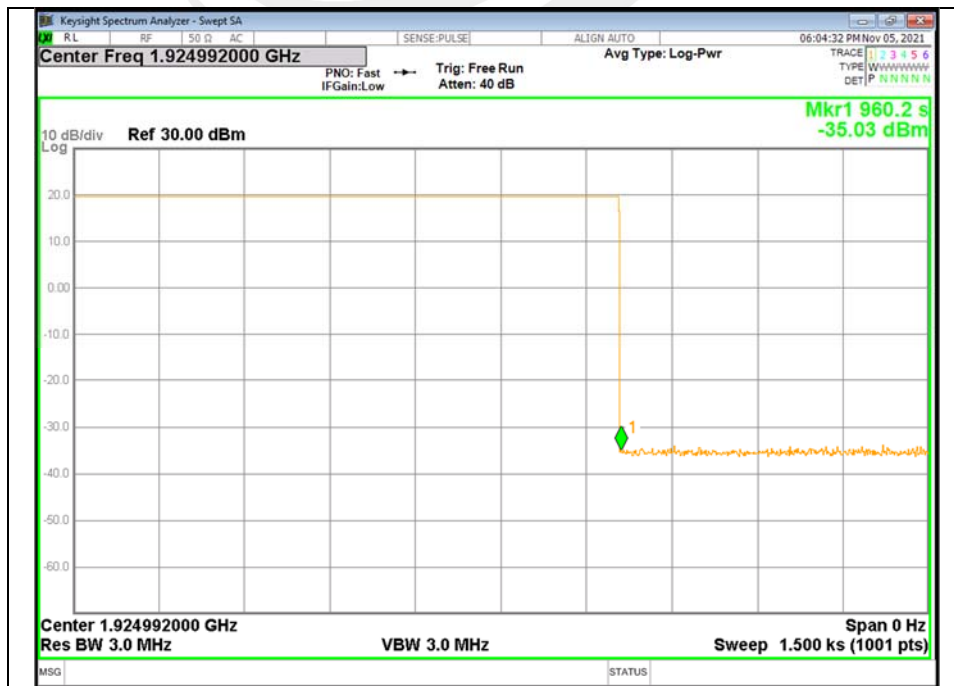



5.11 SELECTED CHANNEL CONFIRMATION, POWER ACCURACY, SEGMENT OCCUPANCY TEST OVERVIEW

§15.323 (c)(5) If access to spectrum is not available as determined by the above, and a minimum of 40 duplex system access channels are defined for the system, the time and spectrum windows with the lowest power level below a monitoring threshold of 50 dB above the thermal noise power determined for the emission bandwidth may be accessed. A device utilizing the provisions of this paragraph must have monitored all access channels defined for its system within the last 10 seconds and must verify, within the 20 milliseconds (40 milliseconds for devices designed to use a 20 milliseconds frame period) immediately preceding actual channel access that the detected power of the selected time and spectrum windows is no higher than the previously detected value. The power measurement resolution for this comparison must be accurate to within 6 dB. No device or group of co-operating devices located within 1 meter of each other shall during any frame period occupy more than 6 MHz of aggregate bandwidth, or alternatively, more than one third of the time and spectrum windows defined by the system.

TEST PROCEDURE

Testing to ANSI C63.17-2013 Clause 7.3.2. & 7.3.3, which provides the test methodology for this provision. The current product offers 12 duplex channels per frequency channel and therefore 12x5=60 duplex channels in total. Hence Part §15.323(c)(5) applies. The equation for the upper monitoring threshold is given in ANSI C63.17 Clause 4.3.3. Max measured interference level (dBm) = -85.02 dBm

TEST SETUP

The test setup is shown in section 3.2 figure 2.

MONITORING LIMIT THRESHOLD

The EUT's monitoring limit threshold power at the monitoring antenna terminals shall be less than a maximum, shown in Equation (3):

T\_L ≤ (-174 + 10logB + M\_L + P\_MAX - P\_EUT) dBm

M\_L is a level specified by the manufacturer and is the maximum amount in decibels by which the limiting threshold may exceed thermal noise for an EUT transmitting the maximum allowed power.

Calculation of monitoring threshold limits for isochroous devices:

Lower threshold: T\_L = -174 + 10log\_10 B + M\_L + P\_MAX - P\_EUT (dBm)

Where: B= Emission bandwidth (Hz)

M\_L = dB the threshold may exceed thermal noise (30 for T\_L)

P\_MAX = 5Log\_10 B - 10 (dBm)

P\_EUT = Transmitted power (dBm)

Table with 6 columns: Monitor Threshold, B(MHz), M\_L(dB), P\_MAX(dBm), P\_EUT(dBm), Threshold(dBm). Row 1: Lower threshold, 1.426667, 30, 20.77, 20.40, -82.085

Note: 1. The upper threshold is applicable as the EUT utilizes more than 20 duplex system channels





## TEST RESULTS

### 1) LIC procedure test:

Interference (Refer to ANSI C63.17 clause 7.3.3)	Reaction fo EUT	Results
a) Apply the interference on $f_1$ at level $T_L+U_M+7\text{dB}$ and the interference on $f_2$ at level $T_L+U_M$ . Initiate transmission and verify the transmission only on $f_2$ . Repeat 5 times.	EUT transmits on $f_2$	Pass
b) Apply the interference on $f_1$ at level $T_L+U_M$ and the interference on $f_2$ at level $T_L+U_M+7\text{dB}$ . Initiate transmission and verify the transmission only on $f_1$ . Repeat 5 times.	EUT transmits on $f_1$	Pass
c) Apply the interference on $f_1$ at level $T_L+U_M+1\text{dB}$ and the interference on $f_2$ at level $T_L+U_M-6\text{dB}$ . Initiate transmission and verify the transmission only on $f_2$ . Repeat 5 times.	EUT transmits on $f_2$	Pass
d) Apply the interference on $f_1$ at level $T_L+U_M-6\text{dB}$ and the interference on $f_2$ at level $T_L+U_M+1\text{dB}$ . Initiate transmission and verify the transmission only on $f_2$ . Repeat 5 times.	EUT transmits on $f_1$	Pass

### 2) Selected channel confirmation:

Interference (Refer to ANSI C63.17 clause 7.3.4)	Reaction fo EUT	Results
a) Apply the interference on $f_1$ at level $T_L+U_M$ and no interference on $f_2$ . Initiate transmission and verify the transmission only on $f_2$ . Then terminate it.	EUT transmits on $f_2$	Pass
b) Apply the interference on $f_2$ at level $T_L+U_M$ and immediately remove all interference from $f_1$ . The EUT should immediately attempt transmission $f_1$ (but at least 20ms after the interference on $f_2$ is applied), verify the transmission only on $f_1$ .	EUT transmits on $f_1$	Pass



## 5.12 RANDOM WAITING

### TEST CRITERIA

§15.323 (c)(6) ) if the selected combined time and spectrum windows are unavailable, the device may either monitor and select different windows or seek to use the same windows after waiting an amount of time, randomly chosen from a uniform random distribution between 10 and 150 milliseconds, commencing when the channel becomes available.

### TEST PROCEDURE

Testing to ANSI C63.17-2013 Clause 8.1.3, which provides the test methodology for this provision.

### ATTESTATION

The Manufacturer declared that this provision is not utilized by the EUT.





## 5.13 MONITORING REQUIREMENTS

### TEST CRITERIA

§15.323 (c)(7) The monitoring system bandwidth must be equal to or greater than the emission bandwidth of the intended transmission and have a maximum reaction time less than  $50 \times \text{SQRT}(1.25/\text{emission bandwidth in MHz})$  microseconds for signals at the applicable threshold level but shall not be required to be less than 50 microseconds. If a signal is detected that is 6 dB or more above the applicable threshold level, the maximum reaction time shall be  $35 \times \text{SQRT}(1.25/\text{emission bandwidth in MHz})$  microseconds but shall not be required to be less than 35 microseconds.

### TEST PROCEDURE

Measurement method according to ANXI C63.17 2013 clause 7.5

- Restrict the EUT to a single transmit carrier frequency  $f_1$ , and verify that the EUT can establish a connection with no interference applied on  $f_1$ .
- Apply time-synchronized, pulsed interference on  $f_1$  at the pulsed level  $TL+UM$ , verify that the EUT does not establish a connection when the width of the interference pulse exceeds the largest of  $50\mu\text{s}$  and  $50 \sqrt{1.25 / B} \mu\text{s}$ , where  $B$  is the emission bandwidth of the EUT in megahertz.
- With the channel interference level 6dB above  $TL+UM$ , verify that the EUT does not establish a connection when the width of the interference pulse exceeds the largest of  $35\mu\text{s}$  and  $35 \sqrt{1.25/B} \mu\text{s}$ , where  $B$  is the emission bandwidth of the EUT in megahertz.

Test pulse width Equation( $\mu\text{s}$ )	B(bandwidth)(MHz)	Pulse width( $\mu\text{s}$ )	Limit(Largest)( $\mu\text{s}$ )
$50(1.25/B)^{1/2}$	1.426667	46.80	50
$35(1.25/B)^{1/2}$	1.426667	32.76	35

### TEST SETUP

The test setup is shown in section 3.2 figure 2.

### TEST RESULTS

#### 1) Monitoring Bandwidth:

The antenna of the EUT used for monitoring is the same interior antenna that used for transmission, so the monitoring system bandwidth is equal to the emission bandwidth of the intended transmission.

#### 2) Reaction Time Test:

No.	Interference Pulse width( $\mu\text{s}$ )	Reaction of EUT	Observing time( $\mu\text{s}$ )	Result
1	50 $\mu\text{s}$ with level $T_L+U_m$	No transmission	25.2	Pass
2	35 $\mu\text{s}$ with level $T_L+U_M +6\text{dB}$	No transmission	18.71	Pass



## 5.14 MONITORING ANTENNA

### TEST CRITERIA

§15.323 (c)(8) Transmission is intended to occupy. The following criteria must be met: (8) The monitoring system shall use the same antenna used for transmission, or an antenna that yields equivalent reception at that location.

### TEST PROCEDURE

Testing to ANSI C63.17-2013 Clause 4, which provides the test methodology for this provision.

### ATTESTATION

The EUT uses the same antennas for transmission and reception as for monitoring

## 5.15 DUPLEX CONNECTIONS

### TEST CRITERIA

§15.323 (c)(10) An initiating device may attempt to establish a duplex connection by monitoring both its intended transmit and receive time and spectrum windows. If both the intended transmit and receive time and spectrum windows meet the access criteria, then the initiating device can initiate a transmission in the intended transmit time and spectrum window. If the power detected by the responding device can be decoded as a duplex connection signal from the initiating device, then the responding device may immediately begin transmitting on the receive time and spectrum window monitored by the initiating device.

### TEST PROCEDURE

Testing to ANSI C63.17-2013 Clause 8.3, which provides the test methodology for this provision. The MS is the initiating device and the BS is the companion device.

### TEST RESULTS

The Manufacturer declares that this provision is not utilized by the EUT.



## 5.16 ALTERNATIVE MONITORING INTERVAL FOR CO-LOCATED DEVICES

### TEST CRITERIA

§15.323 (c)(11) an initiating device that is prevented from monitoring during its intended transmit window due to monitoring system blocking from the transmissions of a co-located (within one meter) transmitter of the same system, may monitor the portions of the time and spectrum windows in which they intend to receive over a period of at least 10 milliseconds. The Monitored time and spectrum window must total at least 50 percent of the 10 millisecond frame interval and the monitored spectrum must be within the 1.25 mhz frequency channel(s) already occupied by that device or co-located co-operating devices. If the access criteria is met for the intended receive time and spectrum window under the above conditions, then transmission in The intended transmit window by the initiating device may commence.

### TEST PROCEDURE

Testing to ANSI C63.17-2013 Clause 8.4, which provides the test methodology for this provision. The MS is initiating device and the BS is the companion device.

### TEST RESULTS

The Manufacturer declares that this provision is not utilized by the EUT.

## 5.17 FAIR ACCESS

### TEST CRITERIA

§15.323 (c)(12) The provisions of (c)(10) or (c)(11) of this section shall not be used to extend the range of spectrum occupied over space or time for the purpose of denying fair access to spectrum to other devices.

### TEST PROCEDURE

The manufacturer supplies an attestation.

### ATTESTATION

The manufacturer declares that the EUT does not work in a mode which denies fair access to spectrum for other devices.



## 5.18 SPURIOUS EMISSIONS

### TEST CRITERIA

#### §15.323(d)(1): Out of Band Emissions

Emissions shall be attenuated below a reference power of 112 milliwatts as follows: 30 dB between the band edge and 1.25 MHz above or below the band; 50 dB between 1.25 and 2.5 MHz above or below the band; and 60 dB at 2.5 MHz or greater above or below the band.

#### §15.323(d)(2): In-Band Emissions

Emissions inside the band must comply with the following emission mask: In the bands between 1B and 2B measured from the center of the emission bandwidth, the total power emitted by the device shall be at least 30 dB below the transmit power permitted for that device; in the bands between 2B and 3B measured from the center of the emission bandwidth, the total power emitted by an intentional radiator shall be at least 50 dB below the transmit power permitted for that radiator; in the bands between 3B and the band edge, the total power emitted by an intentional radiator in the measurement bandwidth shall be at least 60 dB below the transmit power permitted for that radiator. "B" is defined as the emission bandwidth of the device in hertz. Compliance with the emission limits is based on the use of measurement instrumentation employing peak detector function with an instrument resolution bandwidth approximately equal to 1.0 percent of the emission bandwidth of the device under measurement.

### TEST PROCEDURE

For both in and out of band emissions the EUT was connected directly to a spectrum analyzer. The RBW of the spectrum analyzer was set to a minimum 1% of the emission band width.

### TEST SETUP

The test setup is shown in section 3.2 figure 1.

### TEST RESULTS

Equipment complies with the Spurious Emission limits of § 15.323(d)(1).

Note: Both ANT 1 and ANT 2 have been tested, the worst case is ANT 2, and only shown the worst case in this report.

#### In-Band Emissions

#### ANT 2

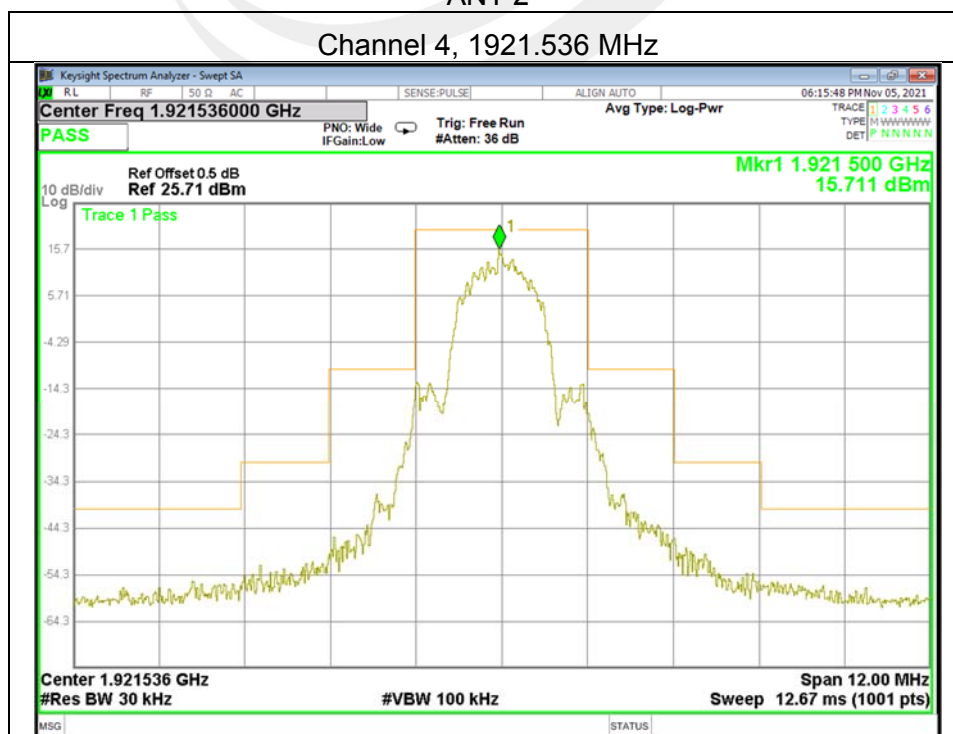

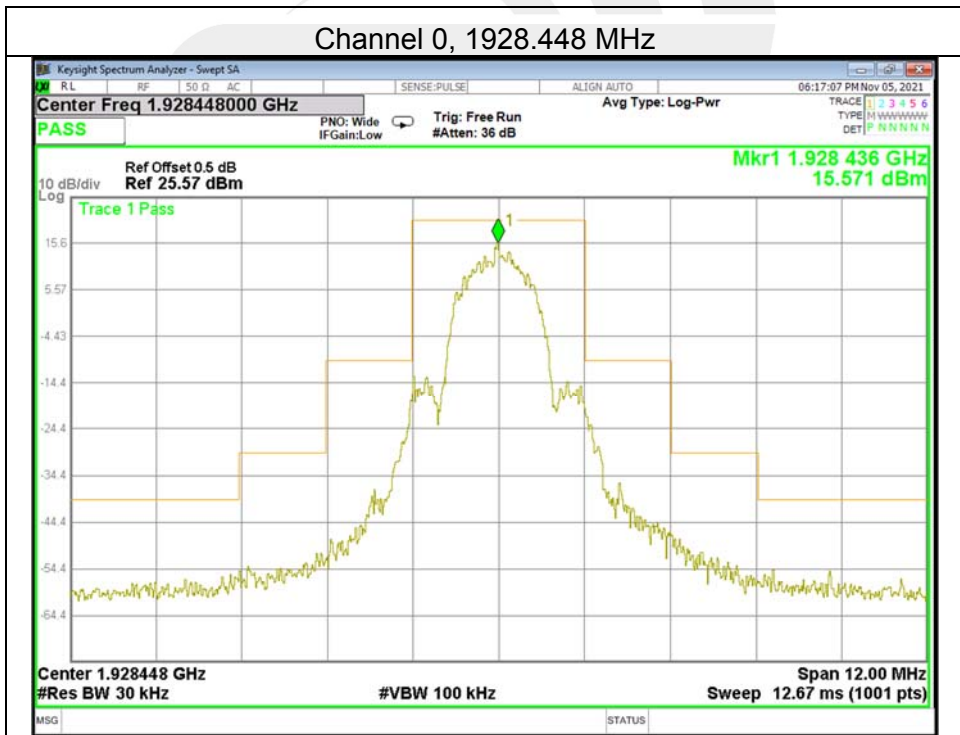
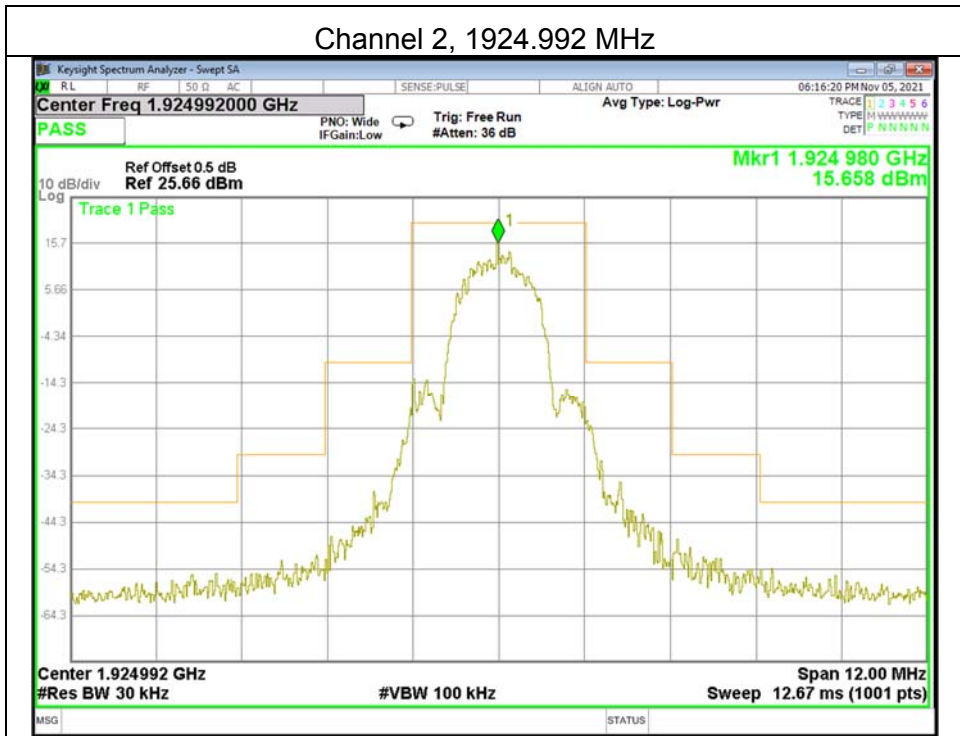





Out of Band Emissions

ANT 2

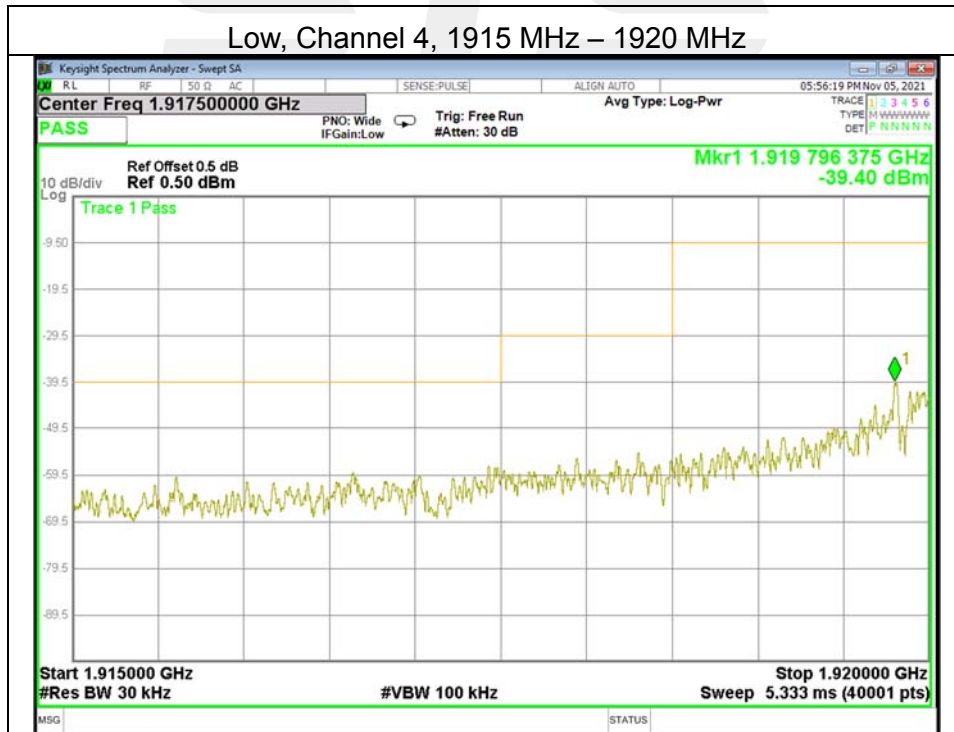
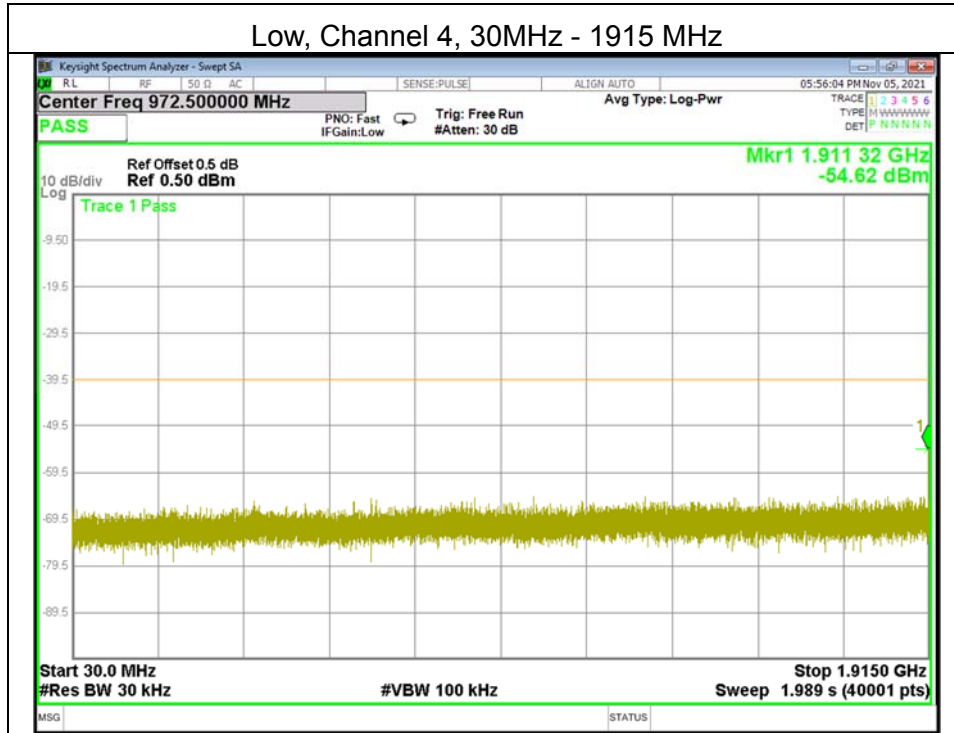



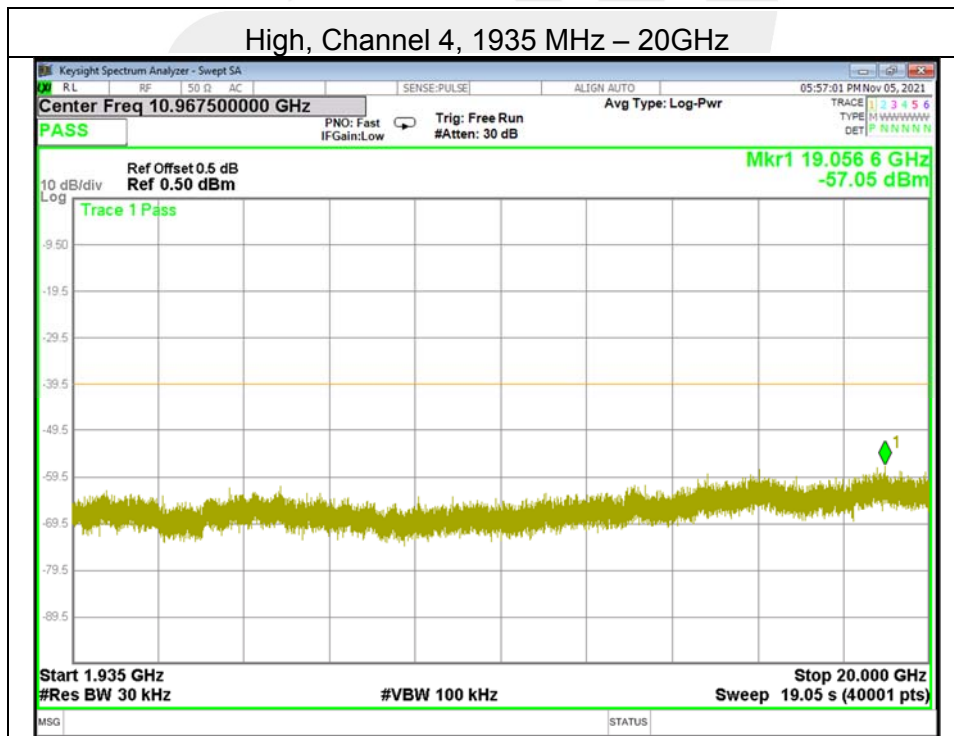
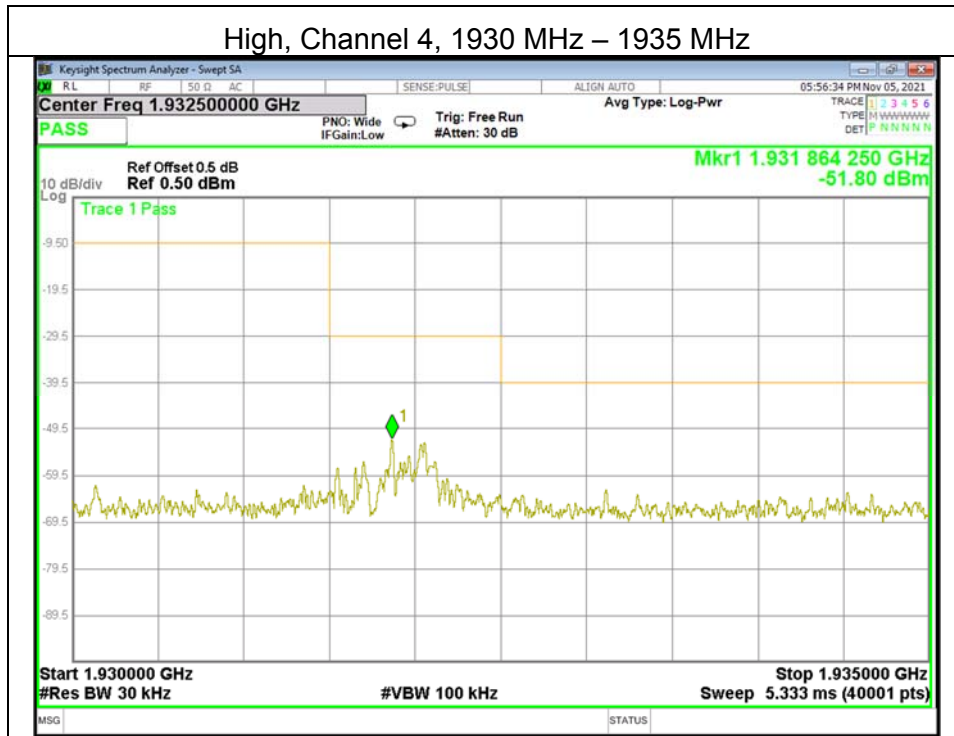

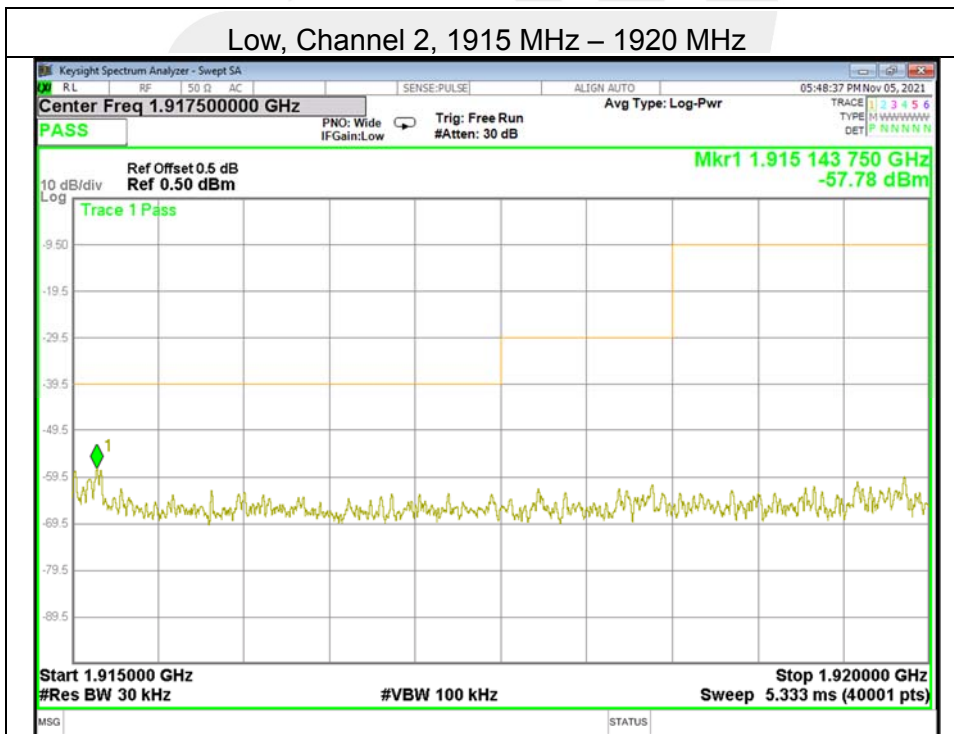
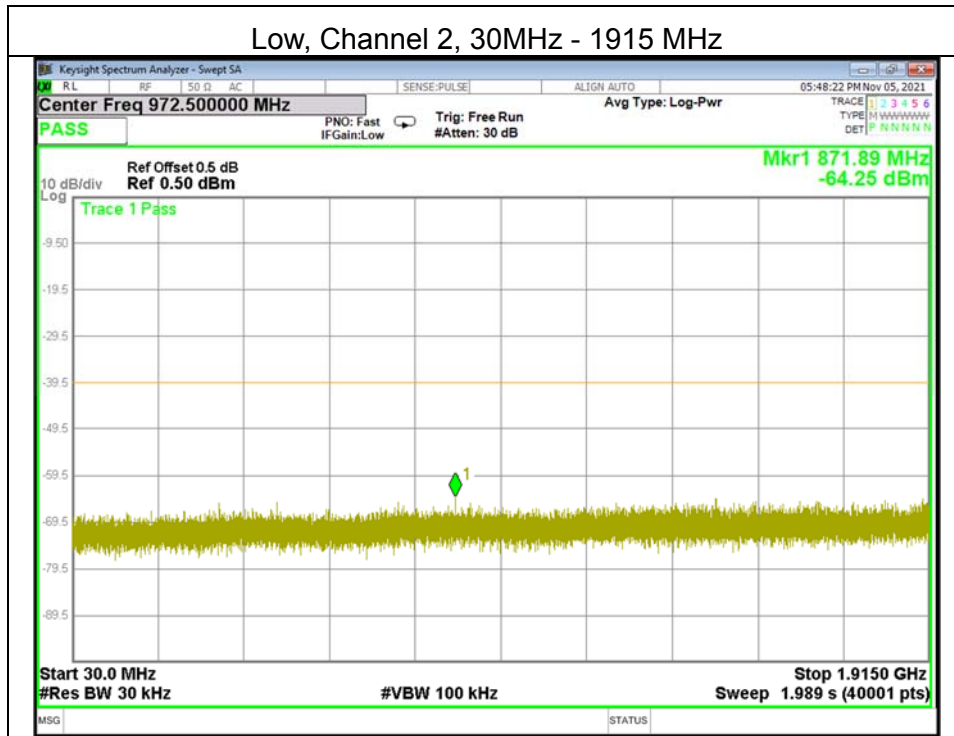

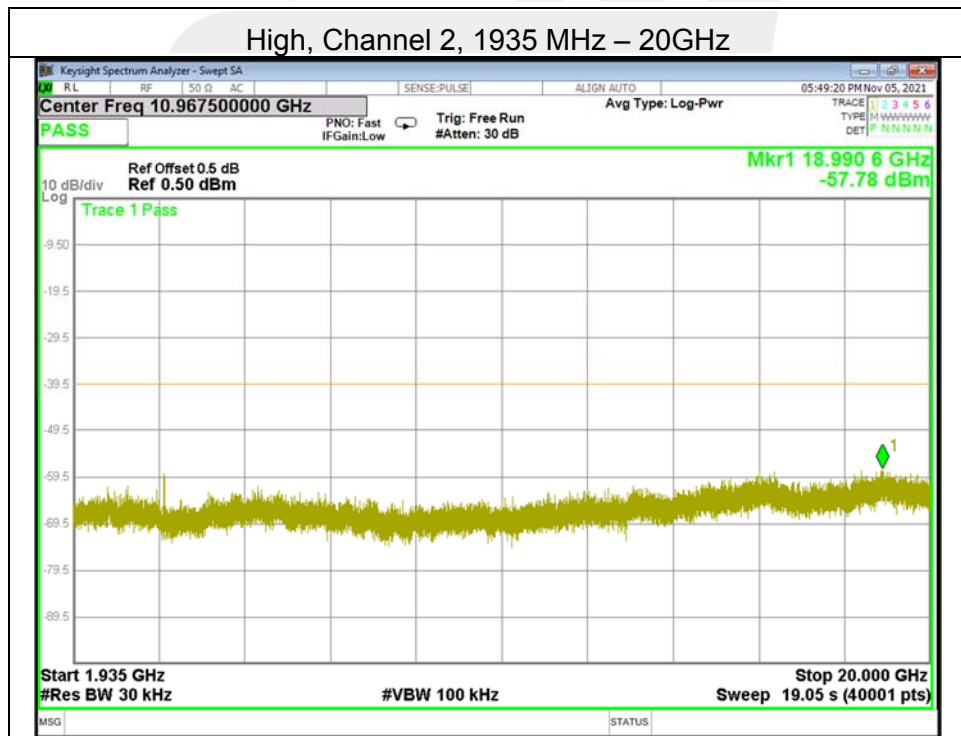
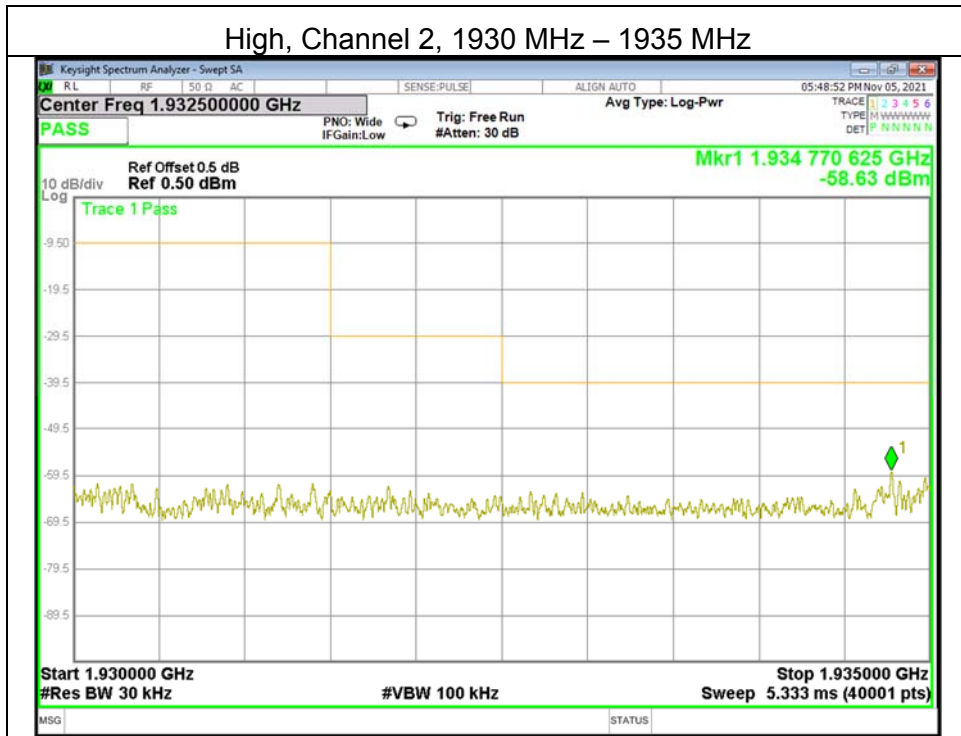

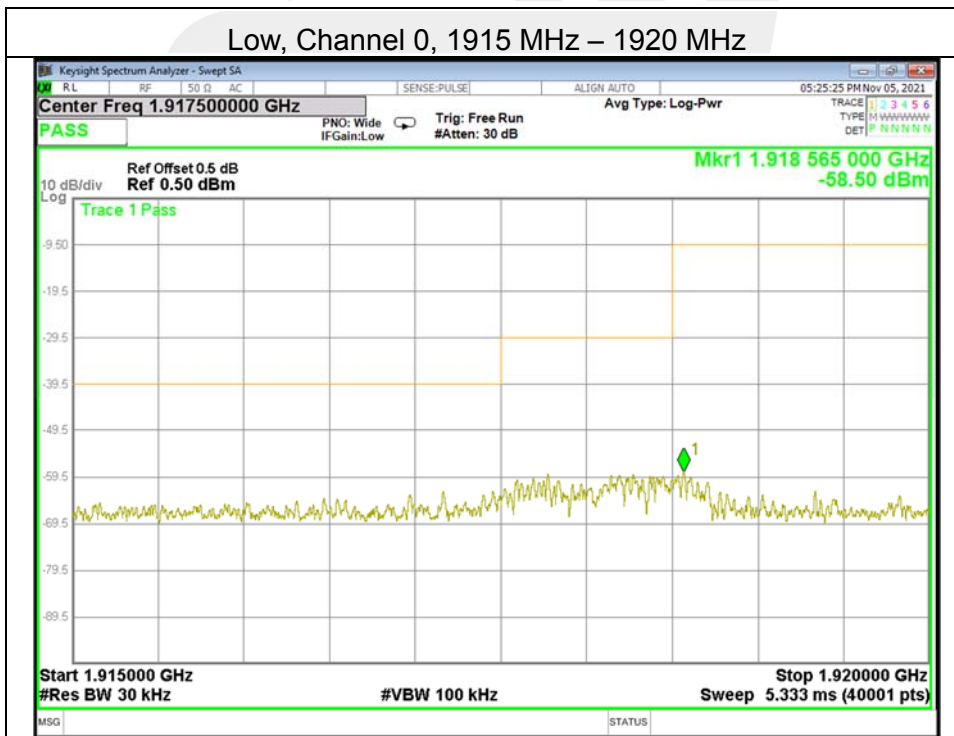
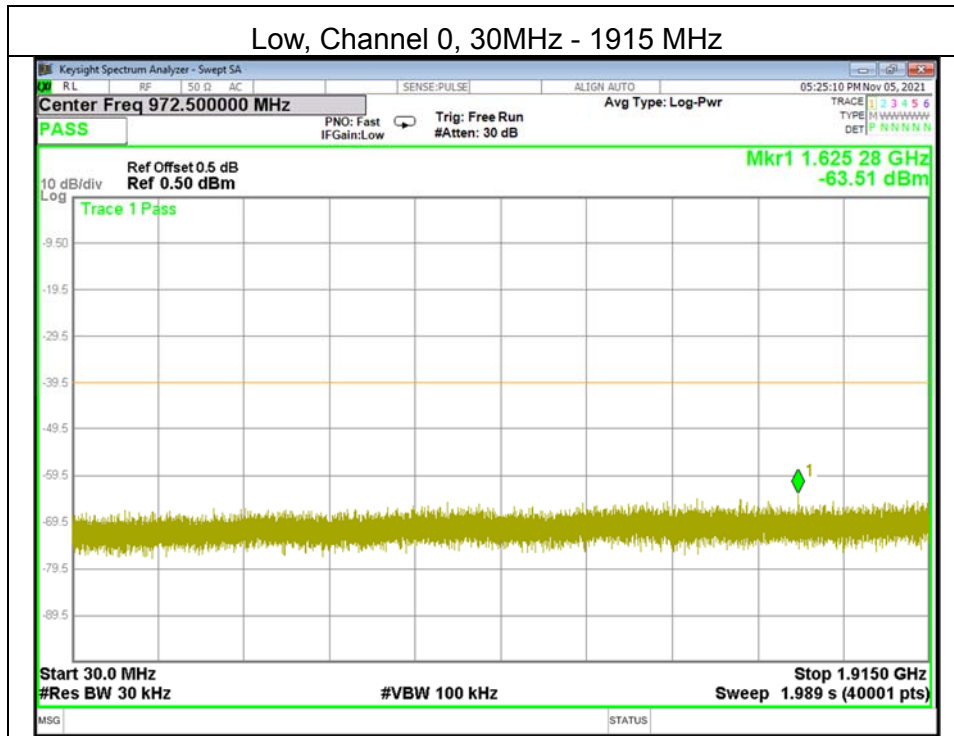

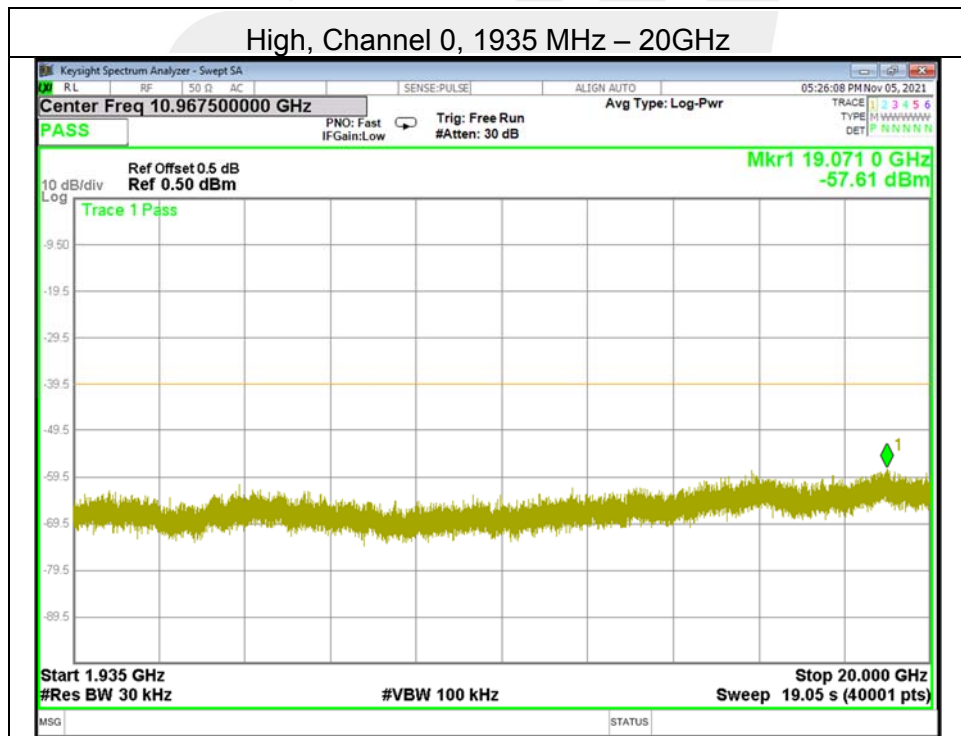
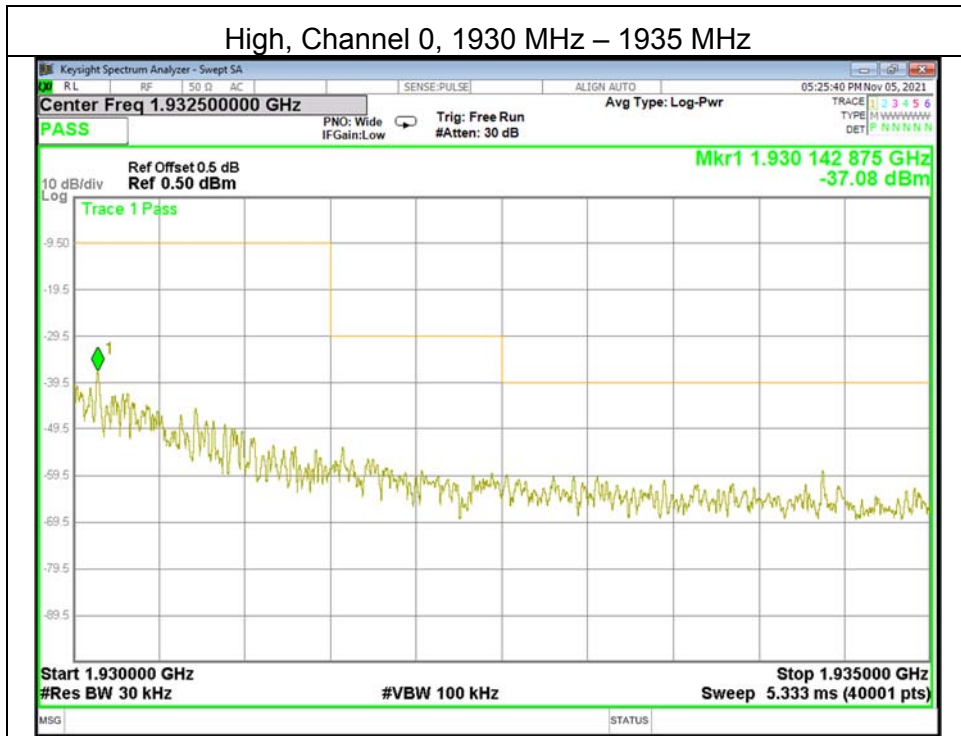



5.19 FRAME PERIOD

TEST CRITERIA

§15.323 (e) The frame period (a set of consecutive time slots in which the position of each time slot can be identified by reference to a synchronizing source) of an intentional radiator operating in these sub-bands shall be 20 milliseconds or 10 milliseconds/X where X is a positive whole number. Each device that implements time division for the purposes of maintaining a duplex connection on a given frequency carrier shall maintain a frame repetition rate with a frequency stability of at least 50 parts per million (ppm). Each device which further divides access in time in order to support multiple communication links on a given frequency carrier shall maintain a frame repetition rate with a frequency stability of at least 10 ppm.

Timing Jitter

§ 15.323 (e) Specific requirements for isochronous devices operating in the 1920–1930 MHz sub-band. The jitter (time-related, abrupt, spurious variations in the duration of the frame interval) introduced at the two ends of such a communication link shall not exceed 25 microseconds for any two consecutive transmissions. Transmissions shall be continuous in every time and spectrum window during the frame period defined for the device.

TEST LIMIT

Frame Period	20 or 10ms
Max Jitter	25 μs
3 times St.Dev of Jitter	12.5 μs

TEST SETUP

The test setup is shown in section 3.2 figure 2.

TEST PROCEDURE

The manufacturer supplies an attestation

TEST RESULTS

The Frame Repetition Stability is measured with the RF Test Platform for DECT. The Frame Repetition Stability is 3 times the standard deviation.

ANT 2

Channel	Standard Deviation(ppm)	Frame Repetition	The limit of Frame Repetition Stability(ppm)	Verdict
Middle	0.6618	1.9854	±10	Pass

Channel	Frame Period(ms)	Max Jitter(μs)	3xStandard Deviation of Jitter(μs)	Limit(μs)		Verdict
				Max Jitter	3 times St.Dev.of Jitter	
Middle	10.0000	-0.5000	1.9854	25	12.5	Pass

Max Jitter= (1/(Frame Period+Pk-Pk)/2)-(1/Frame Period). When Pk-Pk and Frame period are in Hz.

3x St.Dev. Jitter 3 x(1/(Frame Period +St. Dev))-(1/St.Dev)) x10<sup>6</sup>

Both ANT 1 and ANT 2 have been tested, the worst case is ANT 2, and only shown the worst case in this report.





## 5.20 FREQUENCY STABILITY

### TEST CRITERIA

§15.323 (f) The frequency stability of the carrier frequency of the intentional radiator shall be maintained within  $\pm 10$ ppm over 1 hour or the interval between channel access monitoring, whichever is shorter. The frequency stability shall be maintained over a temperature variation of  $-20^{\circ}$  to  $+50^{\circ}$  C at normal supply voltage and over a variation in the primary supply voltage of 85% to 115% of the rated supply voltage at a temperature of 200 C. For equipment that is capable only of operating from a battery, the frequency stability tests shall be performed using a new battery without any further requirement to vary supply voltage.

### TEST PROCEDURE

The EUT was placed in the Environmental Chamber and support equipment are outside the chamber on a table. A CW signal was injected into the EUT at the appropriate RF level. The frequency counter option on the Spectrum Analyzer was used to measure frequency deviations.

The frequency drift was investigated for every  $10^{\circ}$  C increment until the unit is stabilized then recorded the reading in tabular format with the temperature range of  $-20^{\circ}$  to  $+50^{\circ}$  C.

Voltage supplied to EUT is DC 3.7V reference temperature was done at  $20^{\circ}$  C.

### TEST SETUP

The test setup is shown in section 3.2 figure 1.

### TEST RESULTS

The EUT was compliant with this requirement

Note: Both ANT 1 and ANT 2 have been tested, the worst case is ANT 2, and only shown the worst case in this report.

#### ANT 2

(Low Channel)

Reference Frequency (MHz)	Voltage (V)	Temperature ( $^{\circ}$ C)	Frequency (MHz)	Deviation (ppm)	Limit (ppm)
1921.536	3.7	50	1921.52642	4.99	$\pm 10$
		40	1921.52790	4.22	
		30	1921.52697	4.70	
		20	1921.53705	-0.55	
		10	1921.54024	-2.21	
		0	1921.53784	-0.96	
		-10	1921.54498	-4.67	
		-20	1921.54718	-5.82	



(Mid Channel)					
Reference Frequency (MHz)	Voltage (V)	Temperature (°C)	Frequency (MHz)	Deviation (ppm)	Limit (ppm)
1924.992	3.7	50	1924.99797	-3.10	±10
		40	1924.99641	-2.29	
		30	1924.99523	-1.68	
		20	1925.00229	-5.35	
		10	1924.99791	-3.07	
		0	1924.99819	-3.22	
		-10	1924.98552	3.37	
		-20	1924.98407	4.12	

(High Channel)					
Reference Frequency (MHz)	Voltage (V)	Temperature (°C)	Frequency (MHz)	Deviation (ppm)	Limit (ppm)
1928.448	3.7	50	1928.44474	1.69	±10
		40	1928.44241	2.90	
		30	1928.44276	2.72	
		20	1928.43962	4.35	
		10	1928.44763	0.19	
		0	1928.44882	-0.43	
		-10	1928.44994	-1.01	
		-20	1928.44905	-0.54	





## 5.21 CONDUCTED EMISSION MEASUREMENT POWER LINE CONDUCTED EMISSION LIMITS

Operating frequency band. In case the emission fall within the restricted band specified on Part 207(a) limit in the table below has to be followed.

FREQUENCY (MHz)	Conducted Emission limit (dBuV)	
	Quasi-peak	Average
0.15 -0.5	66 - 56 *	56 - 46 *
0.50 -5.0	56.00	46.00
5.0 -30.0	60.00	50.00

Note:

- (1) The tighter limit applies at the band edges.
- (2) The limit of " \* " marked band means the limitation decreases linearly with the logarithm of the frequency in the range.

The following table is the setting of the receiver

Receiver Parameters	Setting
Attenuation	10 dB
Start Frequency	0.15 MHz
Stop Frequency	30 MHz
IF Bandwidth	9 kHz

TEST PROCEDURE

- a. The EUT was 0.8 meters from the horizontal ground plane and 0.4 meters from the vertical ground plane with EUT being connected to the power mains through a line impedance stabilization network (LISN). All other support equipments powered from additional LISN(s). The LISN provide 50 Ohm/ 50uH of coupling impedance for the measuring instrument.
- b. Interconnecting cables that hang closer than 40 cm to the ground plane shall be folded back and forth in the center forming a bundle 30 to 40 cm long.
- c. I/O cables that are not connected to a peripheral shall be bundled in the center. The end of the cable may be terminated, if required, using the correct terminating impedance. The overall length shall not exceed 1 m.
- d. LISN at least 80 cm from nearest part of EUT chassis.
- e. For the actual test configuration, please refer to the related Item –EUT Test Photos.

TEST SETUP

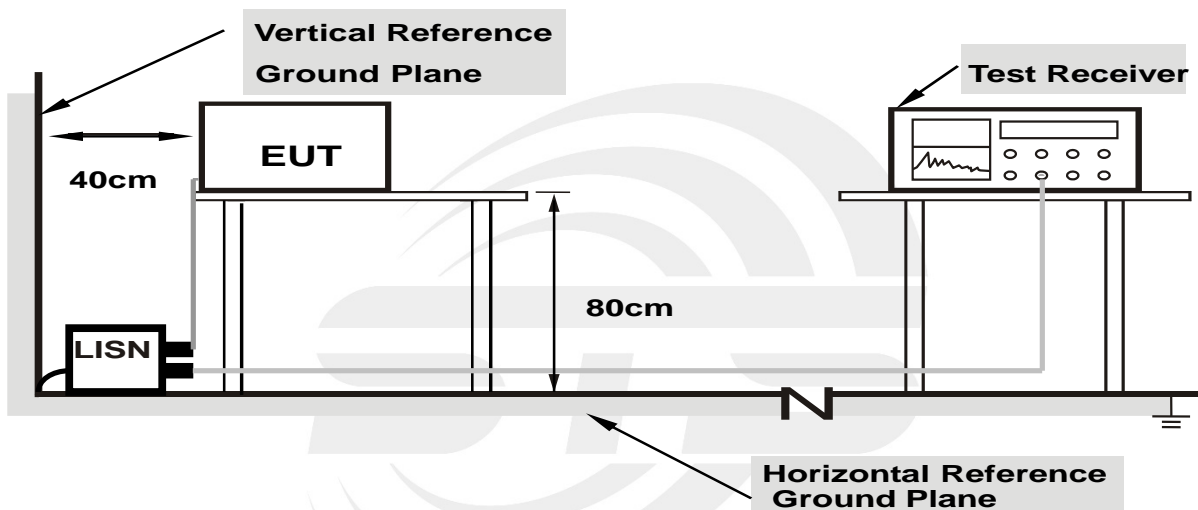

- Note: 1.Support units were connected to second LISN.**  
**2.Both of LISNs (AMN) are 80 cm from EUT and at least 80 cm from other units and other metal planes**

EUT OPERATING CONDITIONS

The EUT was configured for testing in a typical fashion (as a customer would normally use it). The EUT has been programmed to continuously transmit during test. This operating condition was tested and used to collect the included data.



TEST RESULTS

Temperature:	26.7(C)	Relative Humidity:	45%RH
Test Voltage:	AC 120V/60Hz	Phase:	L
Test Mode:	TX Mode		

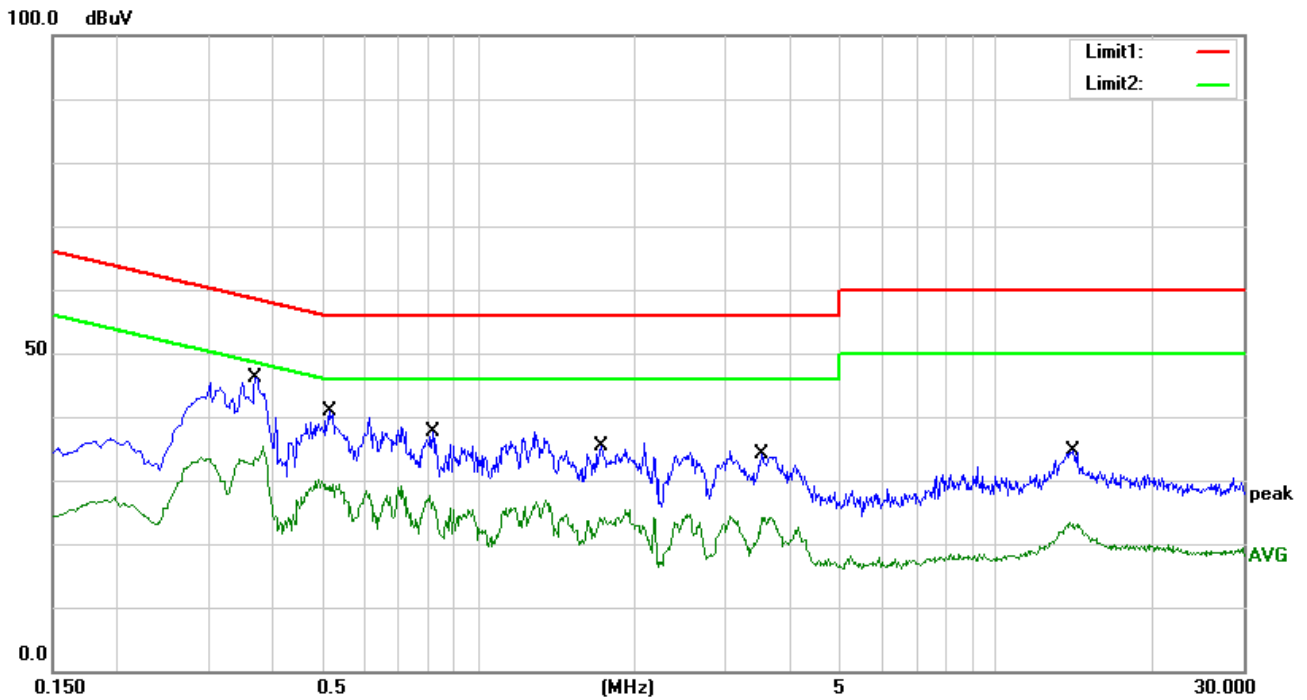

No.	Frequency (MHz)	Reading (dBuV)	Correct Factor(dB)	Result (dBuV)	Limit (dBuV)	Margin (dB)	Remark
1	0.3700	25.57	20.60	46.17	58.50	-12.33	QP
2	0.3700	14.85	20.60	35.45	48.50	-13.05	AVG
3	0.5140	20.30	20.53	40.83	56.00	-15.17	QP
4	0.5140	9.62	20.53	30.15	46.00	-15.85	AVG
5	0.8140	17.31	20.33	37.64	56.00	-18.36	QP
6	0.8140	8.79	20.33	29.12	46.00	-16.88	AVG
7	1.7300	15.04	20.30	35.34	56.00	-20.66	QP
8	1.7300	5.15	20.30	25.45	46.00	-20.55	AVG
9	3.5180	13.71	20.38	34.09	56.00	-21.91	QP
10	3.5180	3.85	20.38	24.23	46.00	-21.77	AVG
11	14.1220	12.90	21.64	34.54	60.00	-25.46	QP
12	14.1220	1.80	21.64	23.44	50.00	-26.56	AVG



Temperature:	24.5(C)	Relative Humidity:	45%RH
Test Voltage:	AC 120V/60Hz	Phase:	N
Test Mode:	TX Mode		

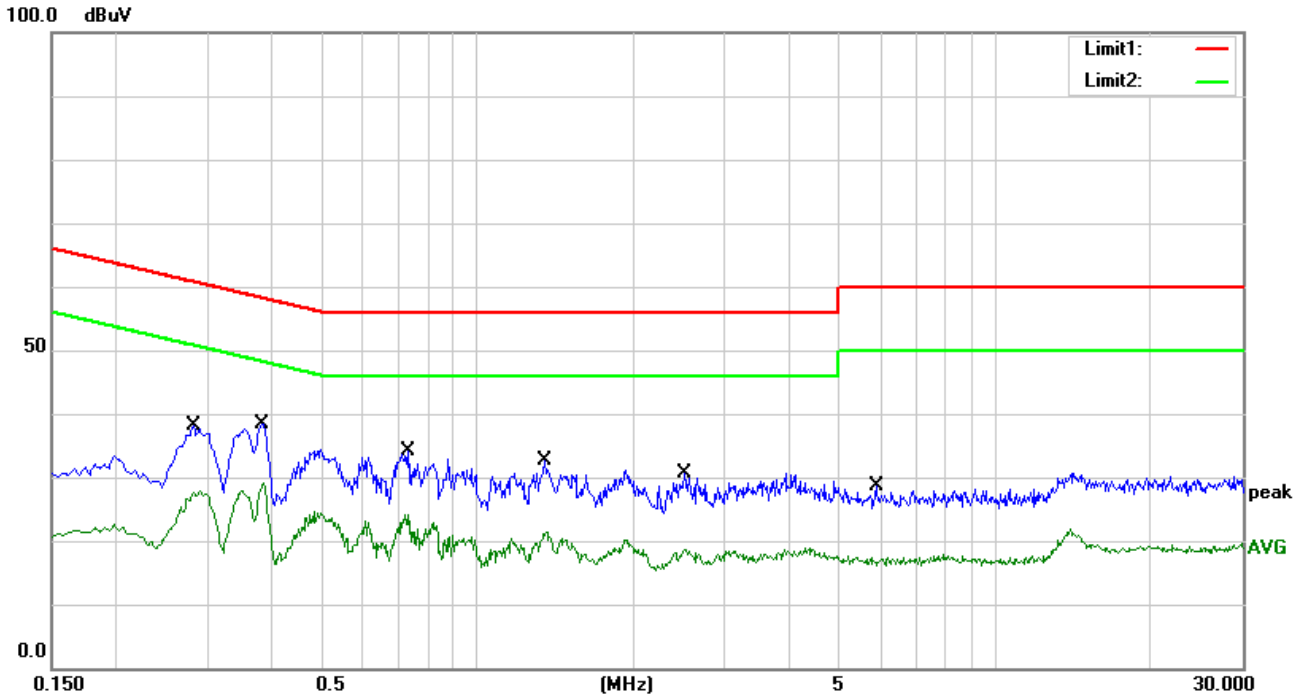

No.	Frequency (MHz)	Reading (dBuV)	Correct Factor(dB)	Result (dBuV)	Limit (dBuV)	Margin (dB)	Remark
1	0.2820	17.43	20.67	38.10	60.76	-22.66	QP
2	0.2820	7.30	20.67	27.97	50.76	-22.79	AVG
3	0.3820	17.89	20.58	38.47	58.24	-19.77	QP
4	0.3820	8.62	20.58	29.20	48.24	-19.04	AVG
5	0.7340	13.86	20.34	34.20	56.00	-21.80	QP
6	0.7340	3.84	20.34	24.18	46.00	-21.82	AVG
7	1.3500	12.25	20.30	32.55	56.00	-23.45	QP
8	1.3500	1.09	20.30	21.39	46.00	-24.61	AVG
9	2.5020	10.25	20.33	30.58	56.00	-25.42	QP
10	2.5020	-1.19	20.33	19.14	46.00	-26.86	AVG
11	5.8900	8.03	20.51	28.54	60.00	-31.46	QP
12	5.8900	-3.03	20.51	17.48	50.00	-32.52	AVG



5.22 RADIATED SPURIOUS EMISSION  
RADIATED EMISSION LIMITS

In any 100 kHz bandwidth outside the operating frequency band. In case the emission fall within the Restricted band specified on Part15.205(a) limit in the table and according to ANSI C63.10-2013 below has to be followed.

LIMITS OF RADIATED EMISSION MEASUREMENT (Frequency Range 9kHz-1000MHz)

Frequencies (MHz)	Field Strength (micровolts/meter)	Measurement Distance (meters)
0.009~0.490	2400/F(KHz)	300
0.490~1.705	24000/F(KHz)	30
1.705~30.0	30	30
30~88	100	3
88~216	150	3
216~960	200	3
Above 960	500	3

LIMITS OF RADIATED EMISSION MEASUREMENT (Above 1000MHz)

FREQUENCY (MHz)	(dBuV/m) (at 3M)	
	PEAK	AVERAGE
Above 1000	74	54

Notes:

- (1) The limit for radiated test was performed according to FCC PART 15C.
- (2) The tighter limit applies at the band edges.
- (3) Emission level (dBuV/m)=20log Emission level (uV/m).

For Radiated Emission

Spectrum Parameter	Setting
Attenuation	Auto
Detector	Peak/AV
Start Frequency	1000 MHz(Peak/AV)
Stop Frequency	10th carrier hamonic(Peak/AV)
RB / VB (emission in restricted band)	1 MHz / 3 MHz

Receiver Parameter	Setting
Start ~ Stop Frequency	9kHz~90kHz / RB 200Hz for PK & AV
Start ~ Stop Frequency	90kHz~110kHz / RB 200Hz for QP
Start ~ Stop Frequency	110kHz~490kHz / RB 200Hz for PK & AV
Start ~ Stop Frequency	490kHz~30MHz / RB 9kHz for QP
Start ~ Stop Frequency	30MHz~1000MHz / RB 120kHz for QP



## TEST PROCEDURE

- a. The measuring distance of at 3 m shall be used for measurements at frequency 0.009MHz up to 1GHz, and above 1GHz.
- b. The EUT was placed on the top of a rotating table 0.8 meters(above 1GHz is 1.5 m) above the ground at a 3 meter anechoic chamber. The table was rotated 360 degrees to determine the position of the highest radiation.
- c. The height of the equipment shall be 0.8 m(above 1GHz is 1.5 m); the height of the test antenna shall vary between 1 m to 4 m. Horizontal and vertical polarizations of the ANT 1re set to make the measurement
- d. The initial step in collecting conducted emission data is a spectrum analyzer peak detector mode pre-scanning the measurement frequency range. Significant peaks are then marked and then Quasi Peak detector mode re-measured.
- e. If the Peak Mode measured value compliance with and lower than Quasi Peak Mode Limit, the EUT shall be deemed to meet QP Limits and then no additional QP Mode measurement performed.
- f. For the actual test configuration, please refer to the related Item –EUT Test Photos.

### Note:

Both horizontal and vertical antenna polarities were tested and performed pretest to three orthogonal axis. The worst case emissions were reported.

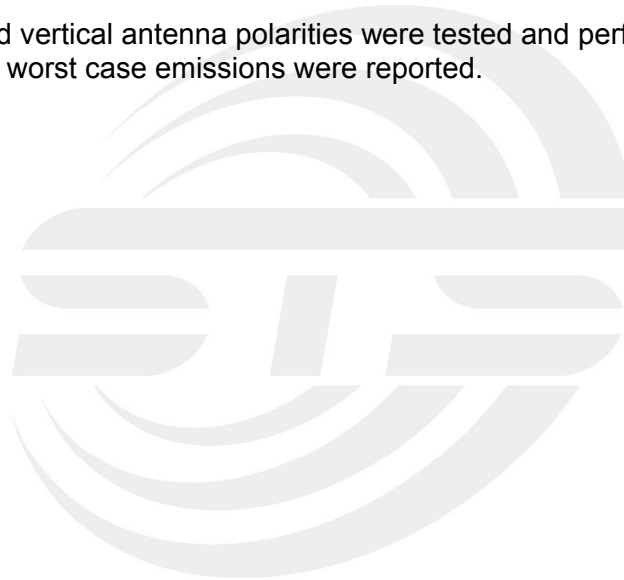

TEST SETUP

(A) Radiated Emission Test-Up Frequency Below 30MHz

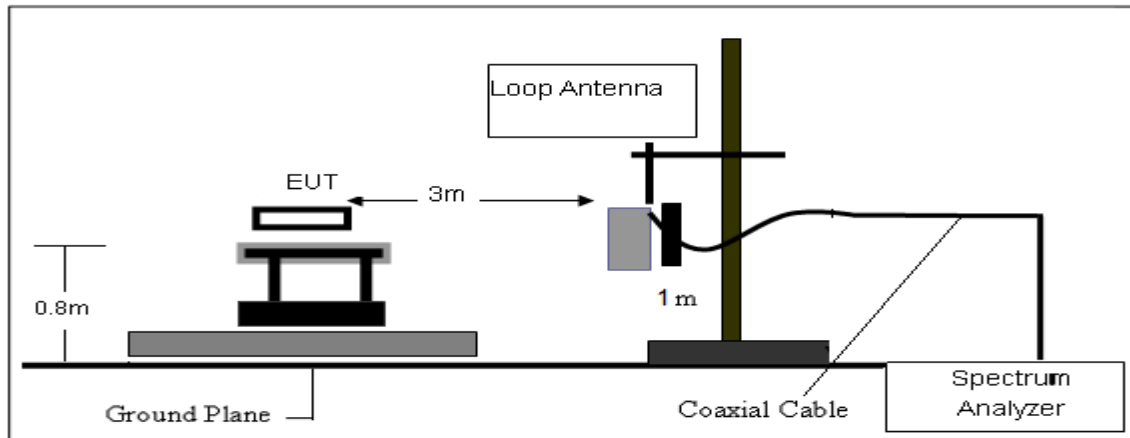

(B) Radiated Emission Test-Up Frequency 30MHz~1GHz

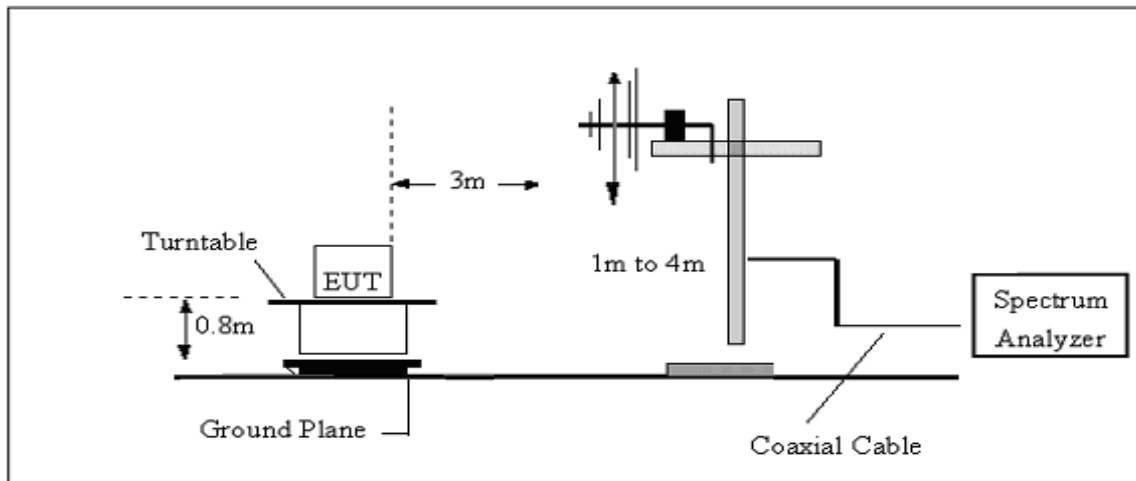

(C) Radiated Emission Test-Up Frequency Above 1GHz

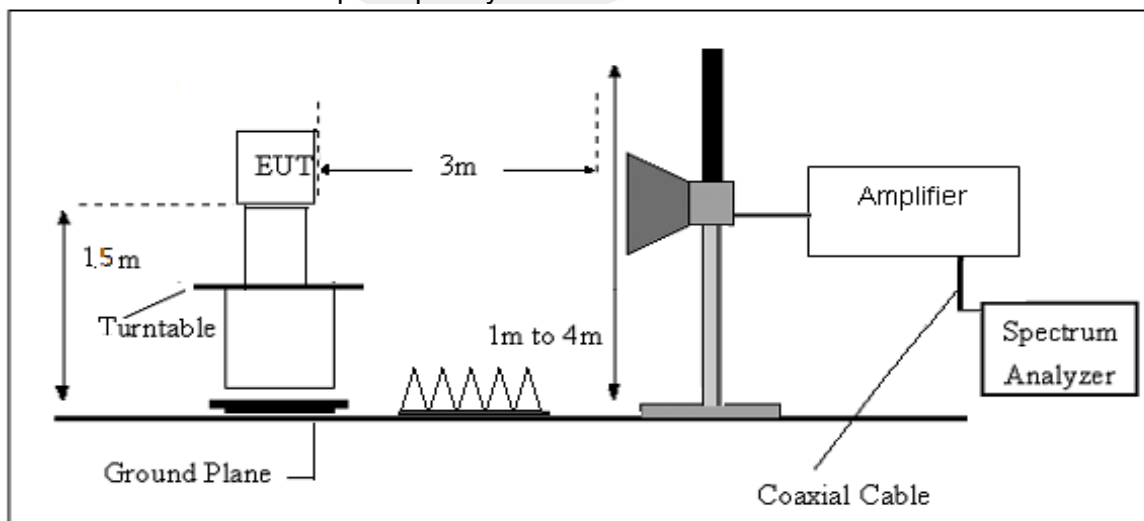

EUT OPERATING CONDITIONS

The EUT tested system was configured as the statements of 2.3 Unless otherwise a special operating condition is specified in the follows during the testing.



## FIELD STRENGTH CALCULATION

The field strength is calculated by adding the Antenna Factor and Cable Factor and subtracting the Amplifier Gain and Duty Cycle Correction Factor (if any) from the measured reading. The basic equation with a sample calculation is as follows:

Margin=PL-PK L or AL- AV L; Margin only shown the worst case.

Where

PR = Peak Reading

AR = Average Reading

PL = Peak Level

AL = Average Level

AF = Antenna Factor

PK L = Peak Limit

AV L = AV Limit

For example

Frequency (MHz)	PR (dB $\mu$ V/m)	AR (dB $\mu$ V/m)	AF (dB)	PL (dB $\mu$ V/m)	AL (dB $\mu$ V/m)	PK L (dB $\mu$ V/m)	AV L (dB $\mu$ V/m)	Margin (dB)
2178	40.23	30.31	9.83	50.06	40.14	74.00	54.00	-13.86

Factor=AF+CL-AG





TEST RESULTS(30MHz – 1GHz)

Temperature:	23.1(C)	Relative Humidity:	60%RH
Test Voltage:	DC 3.7V	Phase:	Horizontal
Test Mode:	TX Mode of ANT 2(Worst Mode)		

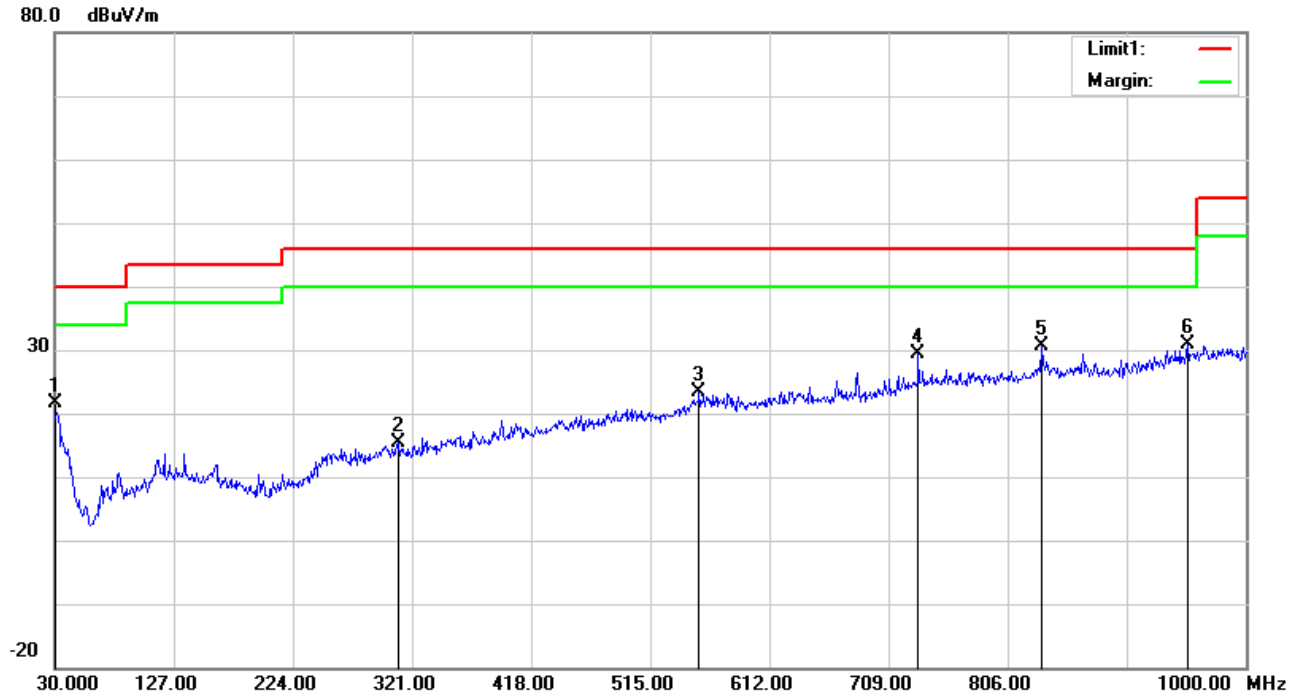

No.	Frequency (MHz)	Reading (dBuV)	Correct Factor(dB/m)	Result (dBuV/m)	Limit (dBuV/m)	Margin (dB)	Remark
1	30.0000	34.45	-12.85	21.60	40.00	-18.40	QP
2	310.3300	29.85	-14.45	15.40	46.00	-30.60	QP
3	554.7700	29.03	-5.63	23.40	46.00	-22.60	QP
4	733.2500	31.81	-2.35	29.46	46.00	-16.54	QP
5	834.1300	31.19	-0.59	30.60	46.00	-15.40	QP
6	952.4700	29.27	1.63	30.90	46.00	-15.10	QP



Temperature:	23.1(C)	Relative Humidity:	60%RH
Test Voltage:	AC 120V/60Hz	Phase:	Vertical
Test Mode:	TX Mode of ANT 2(Worst Mode)		

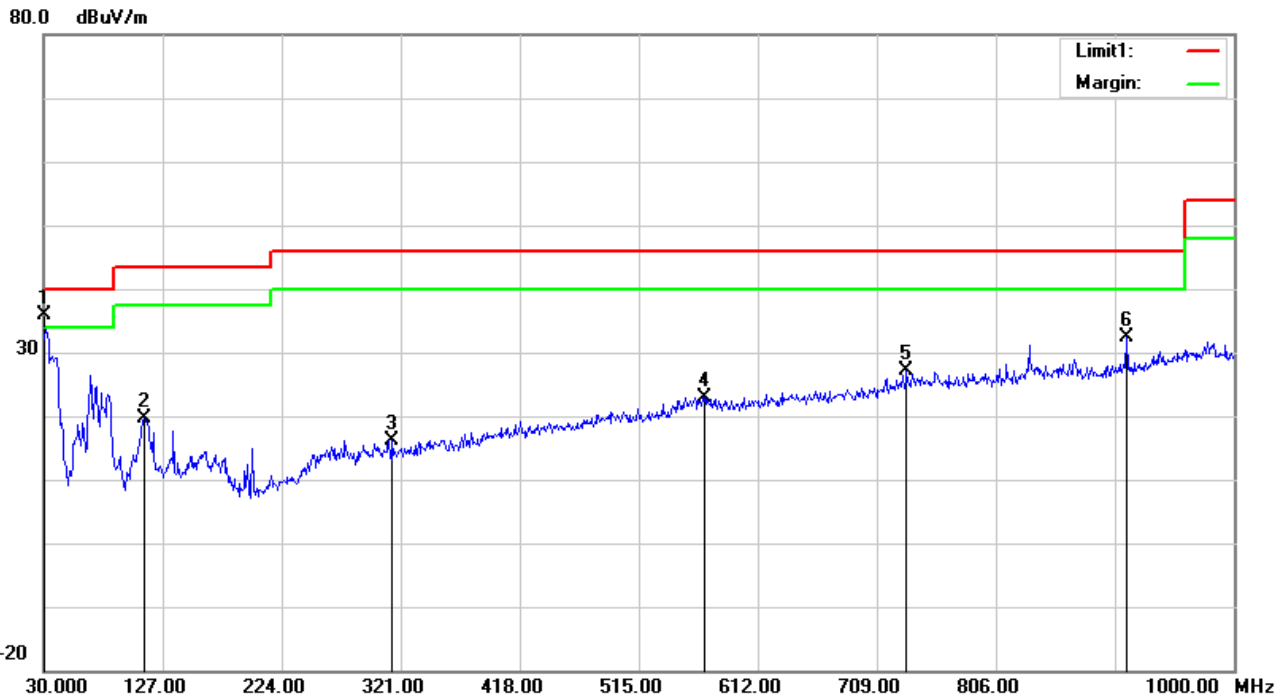

No.	Frequency (MHz)	Reading (dBuV)	Correct Factor(dB/m)	Result (dBuV/m)	Limit (dBuV/m)	Margin (dB)	Remark
1	30.0000	48.62	-12.85	35.77	40.00	-4.23	QP
2	111.4800	38.66	-18.92	19.74	43.50	-23.76	QP
3	314.2100	30.37	-14.26	16.11	46.00	-29.89	QP
4	568.3500	28.44	-5.58	22.86	46.00	-23.14	QP
5	733.2500	29.38	-2.35	27.03	46.00	-18.97	QP
6	912.7000	32.52	-0.14	32.38	46.00	-13.62	QP



TEST RESULTS(Above 1GHz)

Note: Both ANT 1 and ANT 2 have been tested, the worst case is ANT 2, and only shown the worst case in this report.

GFSK-Low-ANT 2

Horizontal

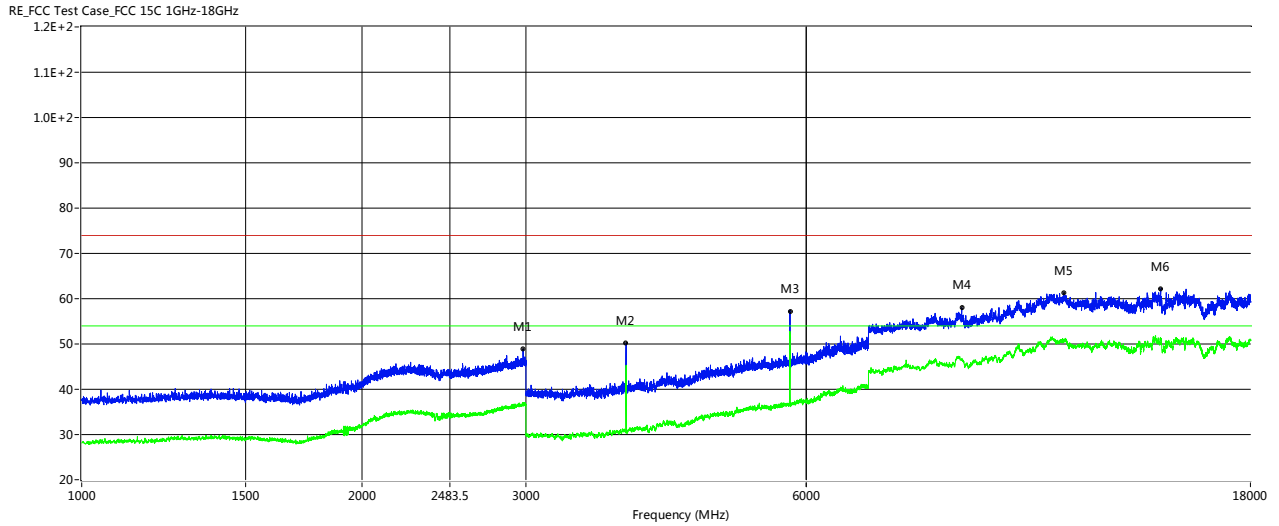

Frequency (MHz)	Peak Level (dBuV/m)	Q-peak Level (dBuV/m)	Average Level (dBuV/m)	Factor (dB)	PK Limit (dBuV/m)	QP Limit (dBuV/m)	AV Limit (dBuV/m)	Over Limit (dB)	ANT	Verdict
2979.500	48.91	--	36.76	6.02	74.0	--	54.0	-17.24	Horizontal	Pass
3843.000	50.24	--	45.30	-10.95	74.0	--	54.0	-8.70	Horizontal	Pass
5766.000	55.99	--	49.59	-3.93	74.0	--	54.0	-4.41	Horizontal	Pass
8815.000	58.01	--	46.73	4.76	74.0	--	54.0	-7.27	Horizontal	Pass
11342.250	61.31	--	50.55	9.62	74.0	--	54.0	-3.45	Horizontal	Pass
14422.250	62.23	--	50.10	11.16	74.0	--	54.0	-3.90	Horizontal	Pass



Vertical

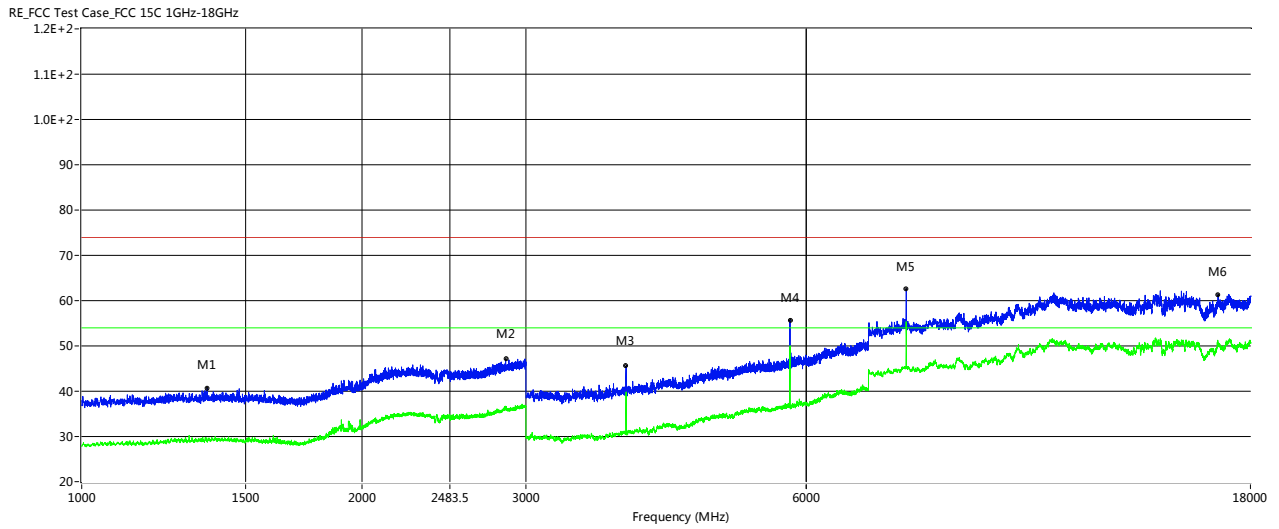

Frequency (MHz)	Peak Level (dBuV/m)	Q-peak Level (dBuV/m)	Average Level (dBuV/m)	Factor (dB)	PK Limit (dBuV/m)	QP Limit (dBuV/m)	AV Limit (dBuV/m)	Over Limit (dB)	ANT	Verdict
1364.000	40.67	--	28.95	-0.76	74.0	--	54.0	-25.05	Vertical	Pass
2853.500	47.11	--	35.94	5.61	74.0	--	54.0	-18.06	Vertical	Pass
3843.000	45.61	--	39.84	-10.95	74.0	--	54.0	-14.16	Vertical	Pass
5766.000	55.62	--	50.03	-3.93	74.0	--	54.0	-3.97	Vertical	Pass
7687.500	62.60	--	50.76	4.06	74.0	--	54.0	-3.24	Vertical	Pass
16619.500	61.38	--	50.34	10.09	74.0	--	54.0	-3.66	Vertical	Pass



### GFSK-Mid-ANT 2 Horizontal

RE\_FCC Test Case\_FCC 15C 1GHz-18GHz

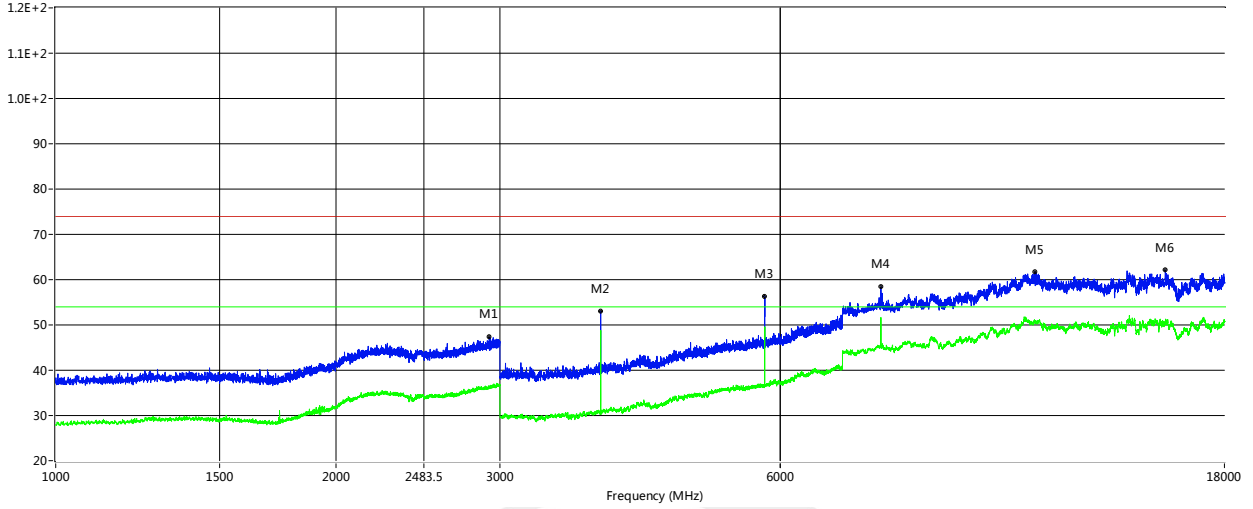

Frequency (MHz)	Peak Level (dBuV/m)	Q-peak Level (dBuV/m)	Average Level (dBuV/m)	Factor (dB)	PK Limit (dBuV/m)	QP Limit (dBuV/m)	AV Limit (dBuV/m)	Over Limit (dB)	ANT	Verdict
2922.000	47.39	--	36.14	5.74	74.0	--	54.0	-17.86	Horizontal	Pass
3849.000	52.96	--	46.21	-10.92	74.0	--	54.0	-7.79	Horizontal	Pass
5774.000	56.37	--	47.83	-3.91	74.0	--	54.0	-6.17	Horizontal	Pass
7698.500	57.48	--	48.56	4.17	74.0	--	54.0	-5.44	Horizontal	Pass
11265.250	61.78	--	50.42	9.55	74.0	--	54.0	-3.58	Horizontal	Pass
15555.250	62.15	--	50.71	10.76	74.0	--	54.0	-3.29	Horizontal	Pass



Vertical

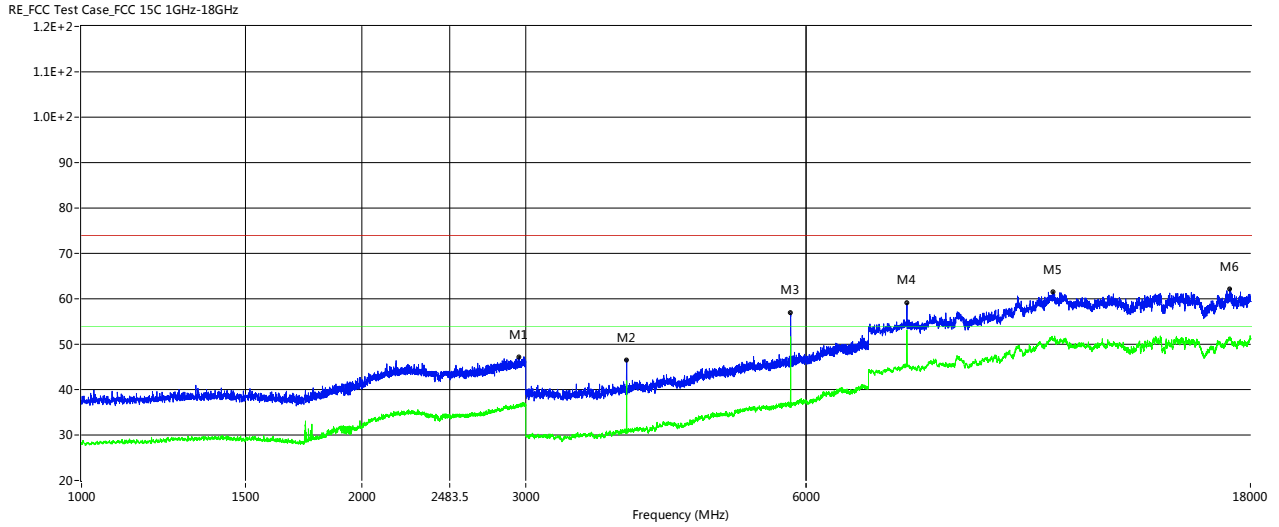

Frequency (MHz)	Peak Level (dBuV/m)	Q-peak Level (dBuV/m)	Average Level (dBuV/m)	Factor (dB)	PK Limit (dBuV/m)	QP Limit (dBuV/m)	AV Limit (dBuV/m)	Over Limit (dB)	ANT	Verdict
2952.000	47.15	--	36.28	5.90	74.0	--	54.0	-17.72	Vertical	Pass
3850.000	46.63	--	41.94	-10.92	74.0	--	54.0	-12.06	Vertical	Pass
5776.000	56.86	--	49.60	-3.91	74.0	--	54.0	-4.40	Vertical	Pass
7698.500	59.02	--	50.93	4.17	74.0	--	54.0	-3.07	Vertical	Pass
11050.750	61.44	--	50.18	9.95	74.0	--	54.0	-3.82	Vertical	Pass
17100.750	62.20	--	50.21	10.48	74.0	--	54.0	-3.79	Vertical	Pass



### GFSK-High-ANT 2 Horizontal

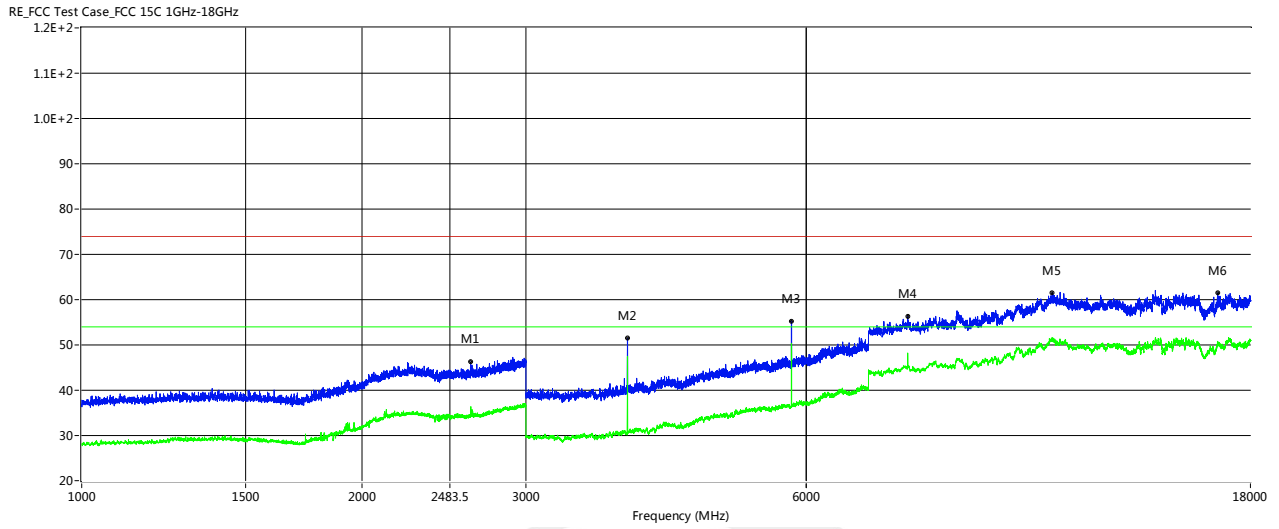

Frequency (MHz)	Peak Level (dBuV/m)	Q-peak Level (dBuV/m)	Average Level (dBuV/m)	Factor (dB)	PK Limit (dBuV/m)	QP Limit (dBuV/m)	AV Limit (dBuV/m)	Over Limit (dB)	ANT	Verdict
2616.000	46.24	--	34.28	4.17	74.0	--	54.0	-19.72	Horizontal	Pass
3857.000	51.53	--	47.48	-10.89	74.0	--	54.0	-6.52	Horizontal	Pass
5785.000	55.30	--	50.30	-3.90	74.0	--	54.0	-3.70	Horizontal	Pass
7712.250	56.33	--	48.23	4.10	74.0	--	54.0	-5.77	Horizontal	Pass
11031.500	61.63	--	50.37	10.05	74.0	--	54.0	-3.63	Horizontal	Pass
16605.750	61.49	--	50.81	10.16	74.0	--	54.0	-3.19	Horizontal	Pass



Vertical

RE\_FCC Test Case\_FCC 15C 1GHz-18GHz

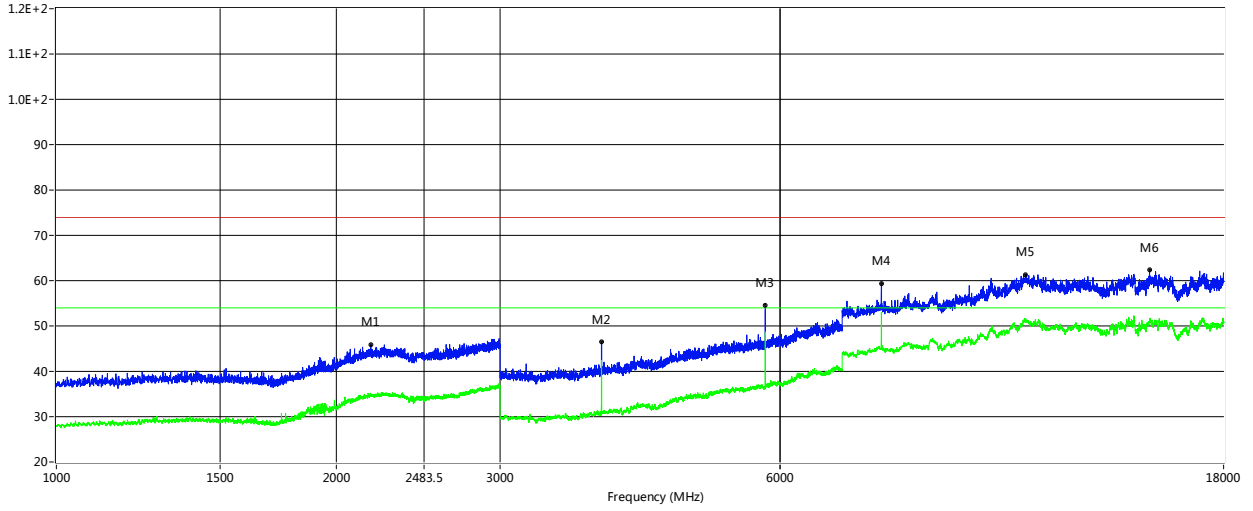

Frequency (MHz)	Peak Level (dBuV/m)	Q-peak Level (dBuV/m)	Average Level (dBuV/m)	Factor (dB)	PK Limit (dBuV/m)	QP Limit (dBuV/m)	AV Limit (dBuV/m)	Over Limit (dB)	ANT	Verdict
2178.000	45.91	--	35.08	4.34	74.0	--	54.0	-18.92	Vertical	Pass
3856.000	46.60	--	42.42	-10.90	74.0	--	54.0	-11.58	Vertical	Pass
5786.000	54.46	--	48.71	-3.89	74.0	--	54.0	-5.29	Vertical	Pass
7712.250	59.36	--	50.98	4.10	74.0	--	54.0	-3.02	Vertical	Pass
11028.750	61.39	--	50.05	10.06	74.0	--	54.0	-3.95	Vertical	Pass
14986.000	62.47	--	50.23	10.33	74.0	--	54.0	-3.77	Vertical	Pass





## APENDIX B PHOTOS OF TEST SETUP

Note: See test photos in setup photo document for the actual connections between Product and support equipment.

※※※※※ END OF THE REPORT ※※※※※

