

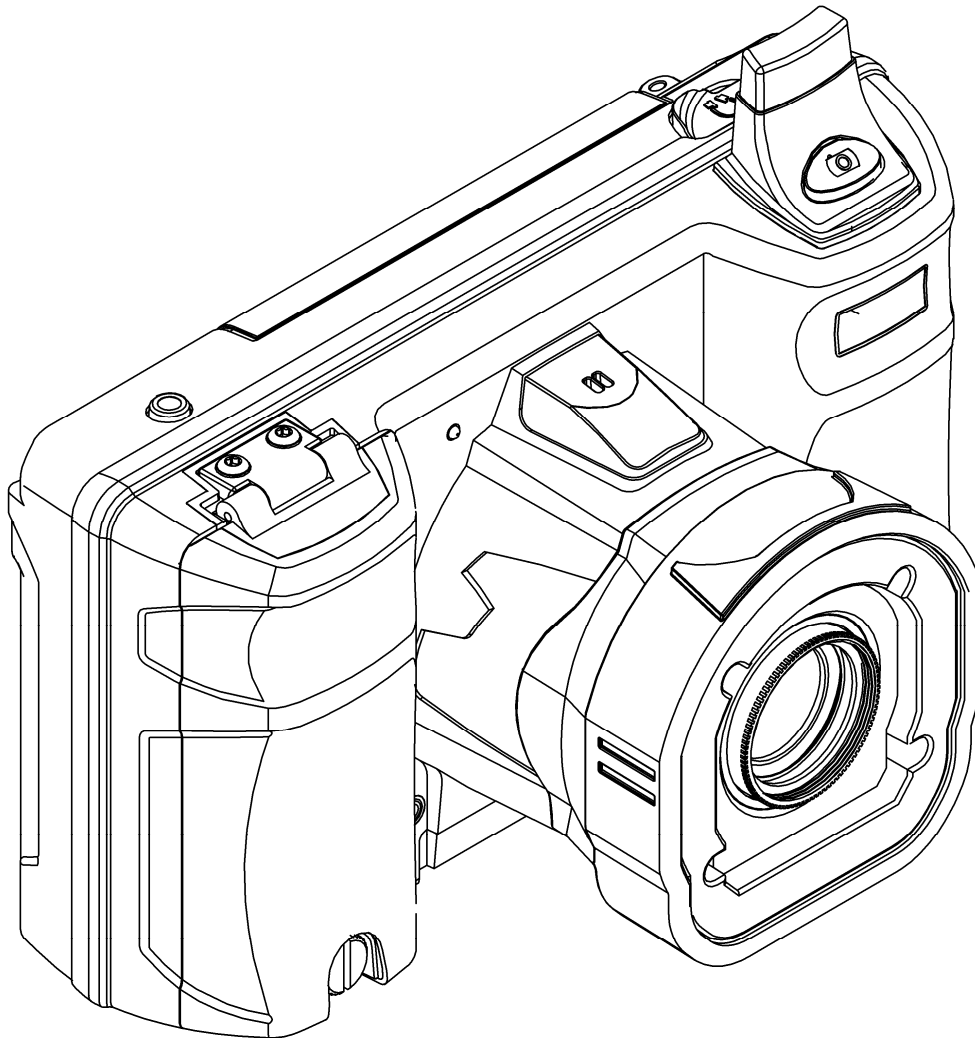

MCD2000 User Manual

Version **3.1**



**LibreStream n_sight MCD2000
User Manual
Doc #: 400097-00
July 2008**

Information in this document is subject to change without notice. Reproduction in any manner whatsoever without the written permission of LibreStream is strictly forbidden.

Copyright © 2006 – 2008
LibreStream Technologies,
Incorporated.
All rights reserved.

Name of LibreStream Software:
MCD

Copyright Notice:
Copyright 2004 – 2008 LibreStream Technologies Incorporated. All Rights Reserved.

Patents Notice: Patents pending in Canada, the United States and other countries.

Trademark Notice: LibreStream, the LibreStream logo, n_sight, the n_sight logo and MCD are either registered trademarks or trademarks of LibreStream Technologies Incorporated in Canada, the United States and/or other countries. All other trademarks are the property of their respective owners.

Table of Contents

1. The n_sight MCD2000	1
1.1. About This Guide	1
1.2. What's in the Box	1
1.3. Parts of the MCD	2
2. MCD Basic Operation	6
2.1. Charging the Battery	6
2.2. Inserting or Replacing the Battery	6
2.3. Calibrating the Integrated Touch Panel	7
2.4. Turning Power On or Off	8
2.5. Logging On & Off	10
2.6. Inserting and Removing an SD Memory Card	11
3. Answering & Initiating Calls	12
3.1. Network Access	12
3.2. Answering an Incoming Call	12
3.3. Initiating (Starting) a Call	12
3.4. Ending a Call	13
3.5. VoIP Telephone Communication	13
4. Accessories	14
4.1. I/O Cover	14
4.2. Power Plug	14
4.3. I/O Sled	15
5. Audio/Video (AV) Functions	16
5.1. Turning the Video Stream On or Off	16
5.2. Setting the Subject Audio Source	16
5.3. Using S-video	16
5.4. Turning the Illumination Ring On or Off	17
5.5. Adjusting Zoom Levels	17
5.6. Focusing	17
5.7. Telestration (Drawing Lines on the Viewfinder)	17
5.8. Capturing Still Images	19
5.9. Sharing Images	19
5.10. Recording and Playing Videos	19
5.11. Streaming a Video Recording	21
6. Viewfinder Features & Display Modes	22
6.1. Controlling the Viewfinder Mode	22
7. Menus	25
7.1. Stream Setup	25
7.2. Checking Status	26
7.3. Viewing Local Contacts	27
7.4. Managing Files	28
7.5. Configuration	30
8. Icons	32

9.	Maintaining the MCD.....	34
9.1.	General Recommendations.....	34
9.2.	Display/Touch Screen.....	34
9.3.	Optics.....	34
9.4.	Ergonomic Recommendations.....	34
10.	Technical Specifications.....	35
11.	Safety & Regulatory Information.....	36
12.	LibreStream Limited Warranty Agreement.....	37
13.	End User License Agreement.....	38

1. The n_sight MCD2000

The n_sight system provides mobile real-time video conferencing for locations that are usually not accessible with standard video conferencing equipment. This includes locations such as test labs, health care facilities, factory floors, service departments, remote suppliers, inspection areas, customer facilities, and other remote work team locations.

This manual describes the n_sight Mobile Collaboration Device (MCD). An Operator at a remote site uses the n_sight MCD to communicate with a Client user over a network.

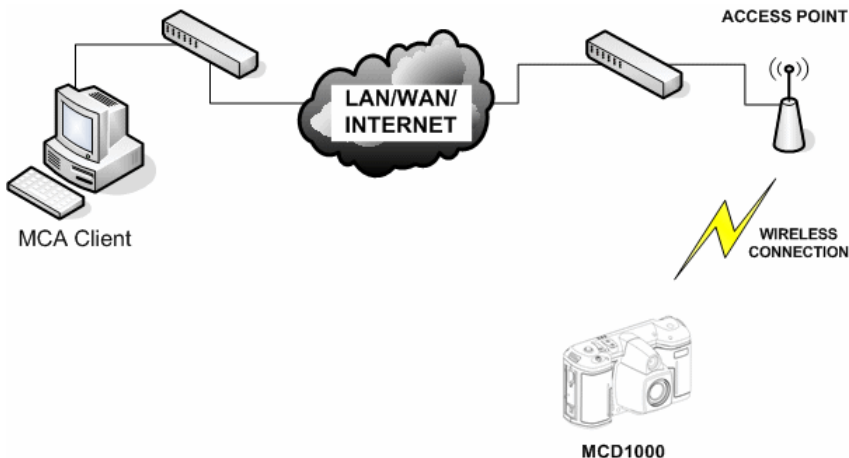

The MCD allows both the Operator and the Client user to:

- Converse just as they would on a mobile telephone.
- View and listen to streaming audio/video output in real time.
- Stream audio and video recordings to the MCD in real time.
- Capture and save snapshot images.
- Share snapshot images between the MCA and MCD.
- Record and play back video.
- Adjust the controls (e.g., zoom, focus, draw on the screen).

The MCD allows technical experts and remote operators to jointly view, consult, diagnose and resolve issues by sending high-resolution video, sound and still images through streaming multimedia from the onsite MCD to a Mobile Collaboration Application (MCA) on an office workstation.

1.1. About This Guide

This guide describes how to use the n_sight MCD on a system that has already been set up and configured. For information on MCD configuration, maintenance and network or other infrastructure setup, please consult the n_sight System Administration Manual. For information on the MCA software client application, consult the MCA User Manual.

1.2. What's in the Box

The MCD2000 n_sight Mobile Collaboration Device

- External power adapter
- Stylus with screwdriver (2 – includes a spare)

- Rechargeable 2400 mAH Li-Ion battery pack
- Wrist strap
- I/O cover
- Power plug
- Lens cover
- Quick Start Guide
- CD of user manuals, end user license, copyright, and MCA software
- Safety and regulatory information

For information on additional accessories or for updated n_sight MCD documentation, consult the LibreStream website at <http://www.LibreStream.com/>.

1.3. Parts of the MCD

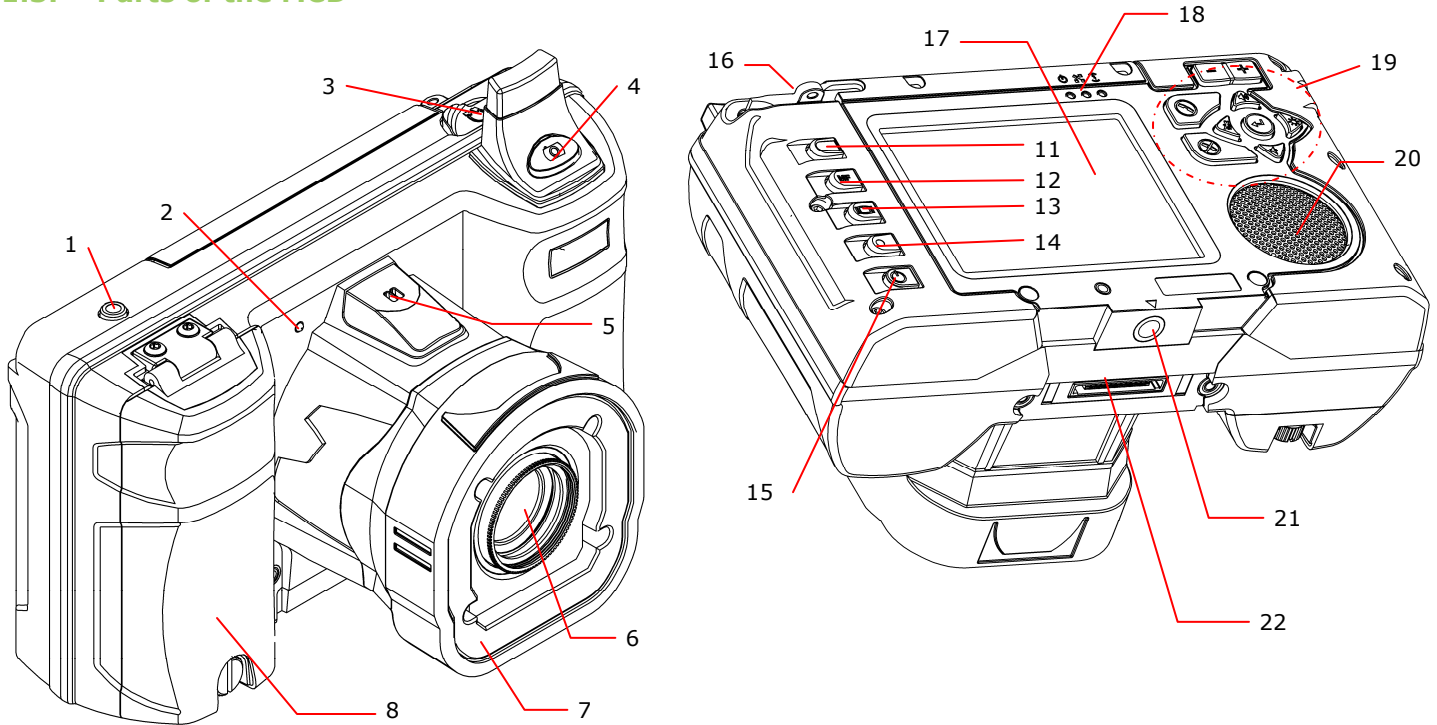

- 1 - Streaming on/off
- 2 - Streaming indicator (red = streaming on)
- 3 - Headset connector
- 4 - Still image capture

- 5 - Microphone
- 6 - Camera lens
- 7 - Illumination ring
- 8 - Battery door (SD memory card slot inside)

- 11 - Function (blue pad)
- 12 - Manual focus
- 13 - Display
- 14 - Record (red dot)
- 15 - Power button
- 16 - Stylus with screwdriver

- 17 - Viewfinder
- 18 - LED indicators
- 19 - Navigation pad
- 20 - Speaker
- 21 - Tripod mount
- 22 - I/O connector

1.3.1. Control Buttons

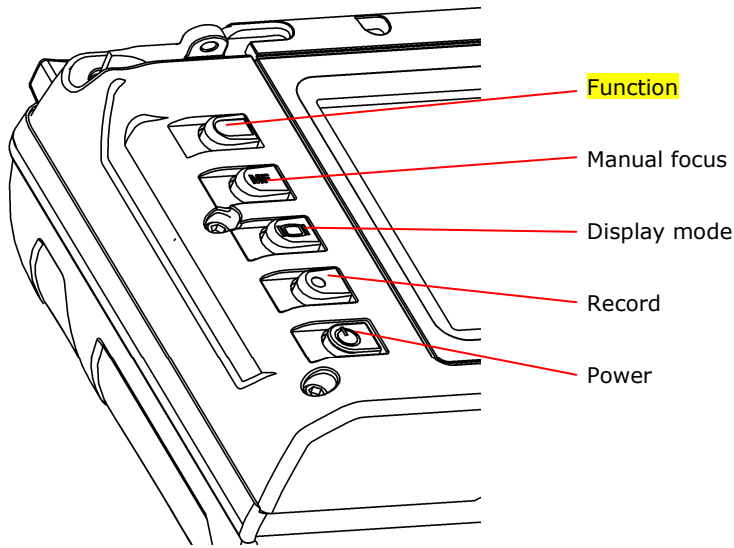

Button	Function
Function	Holding this button allows the use of the control buttons of the Navigation Pad while navigating a menu on the Viewfinder.
Manual Focus	Use this button to set the focus manually or to resume automatic focusing. It works in combination with the Zoom buttons. See <i>Focusing</i> on page 17 for more information.
Display Mode	This button cycles through the MCD's multiple display modes. See <i>Viewfinder Features & Display Modes</i> , on page 22 for more information.
Record	Press this button to start/stop recording to a local Secure Digital (SD) memory card.
Power	<p>This button controls On/Off/Standby modes. See <i>Turning Power On or Off</i> on page 8 for more information.</p> <p>If MCD status is... Power button function</p> <p>Off Press and release the button to turn power on.</p> <p>On Press and release the button to go to Standby mode.</p> <p>Standby Press and release the button to enter Power On mode.</p> <p>On or Standby Press and hold the button for two seconds to turn the unit off. A shutdown message appears.</p>

1.3.2. Navigation Pad Buttons

These context-sensitive buttons control audio volume, microphone mute and the illumination ring. They also function as command buttons and directional buttons for the menus.

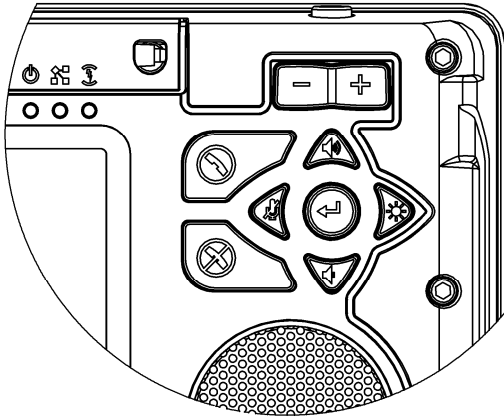

Button	Function	Menu Function
	Start or accept call (Send)	OK or Enter
	End a call or reject an incoming call invitation	Cancel
	Increase volume	Up arrow
	Microphone mute	Left arrow
	Decrease volume	Down arrow
	Front illumination light normal/macro/off	Right arrow
	Enter	Accept



Note: To use the functions of the Navigation Pad (e.g., Microphone mute) while navigating a menu, press and hold the **Function** control button, then press the navigation button.

1.3.3. Zoom/Manual Focus Controls

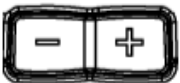
The Zoom buttons are located on the back of the MCD, directly above the Navigation Pad. These allow the Operator to set zoom levels on the camera or to set focus manually (see page 17).



1.3.4. Indicators

Indicator	Name	Explanation
	Power mode indicator	Green = On or Standby
	Network indicator	Green = Network available Off = Network unavailable
	Battery/power indicator	Orange = Battery is charging Off = Battery is charged or power is not connected
	Stream/record	Red = streaming/recording on. Off = streaming/recording off
	Network connector	The Ethernet Port (found on the I/O Sled accessory) also includes an LED indicator: Yellow On = a wired network link exists. Yellow Flashing – indicates wired network activity Yellow Off = no wired network link The green LED is not used at this time.

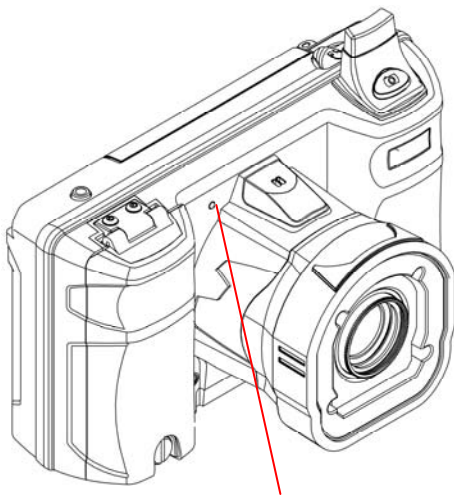

Stream/record indicator

1.3.5. Soft Keys

Some screens contain on-screen keys or buttons, e.g., **Accept** or **Cancel** on a configuration screen. You can select these buttons by tapping the key with your stylus, or by pressing Navigation pad keys.

2. MCD Basic Operation

2.1. Charging the Battery

New batteries should be charged prior to first use. To do this, plug in the external power adaptor and allow the battery to charge until the orange battery indicator extinguishes (up to eight hours). The internal battery charger will shut itself off to prevent overcharging once the battery is fully charged.

Note that the MCD shuts itself off when battery power is low.

- If the unit is on, and an Operator is using it in an active call, a warning message appears so that the Operator has time to plug the MCD in to the external power adaptor, or end the call before the MCD shuts off.
- If the unit is in Standby, it simply shuts itself off.
- If the unit is off, it cannot be started when the battery is low.

To check current battery levels, press the **Display** button once and check the Session information at the bottom of the Viewfinder. See page 22 for more information on Viewfinder and Display modes.

2.2. Inserting or Replacing the Battery

Important: Before using this device for the first time you must install and charge the battery.

1. Open the battery compartment door using the stylus screwdriver.

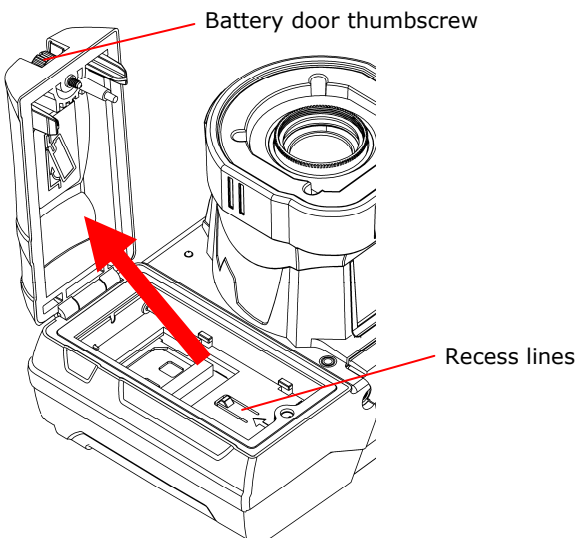

Figure 1

2. Align the contact end of the battery with the small recess lines in the battery compartment, keeping the opposite end of the battery up.

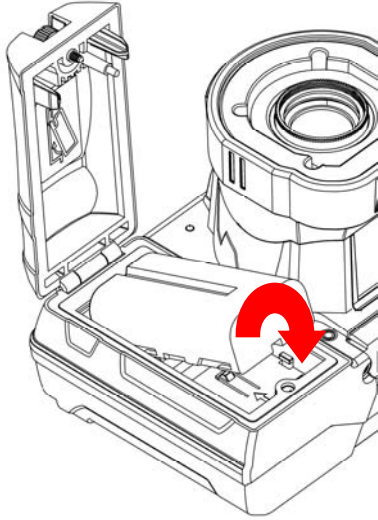

Figure 2

3. Slide the battery upward and rotate downward to place in battery well.

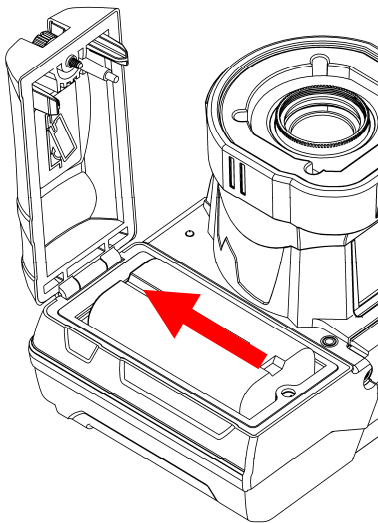

Figure 3

4. When the battery is sitting flat on the compartment floor, slide the battery towards the compartment door until seated.
5. Close the battery compartment and tighten the screw. Note that the door will not close if the battery is not fully inserted, and the camera will not start if the screw is not tight. Connect the external power plug and charge the battery until the orange LED turns off (up to 8 hours).

Note: The device **will not** operate on the external adapter alone. You must have a battery installed.

2.3. Calibrating the Integrated Touch Panel

The Viewfinder display on the back of the MCD includes an integrated touch panel designed for use with the stylus that has been included with the MCD. The Viewfinder touch panel allows control of many MCD features, including menu selection, configuration, text entry (via on screen

keyboard) and on screen button selection. In addition, the touch panel can be used to draw over images and video. See Telestration on page 17.

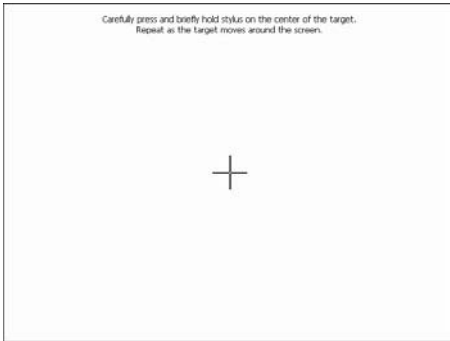

Touch screen calibration

Important: When you are using the Viewfinder screen, always use the stylus provided with the MCD. Do not use other objects, as this could damage the Viewfinder screen. Tap the screen lightly. Do not press hard or strike the screen.

When you first start the MCD, if the touch screen has not been calibrated, the MCD presents a calibration screen. Follow the on-screen instructions to calibrate your touch panel to permit precise control.

2.3.1. Displaying the calibration screen using navigation pad buttons

If the touch screen is incorrectly calibrated to the extent that it can't be used to navigate the menu settings, you can access the screen calibration function using the keypad: simultaneously press and hold the **Up** and **Down** buttons while not pressing the **Enter** button. This will display the touch calibration screen.

2.4. Turning Power On or Off

There are three power modes: On, Off and Standby

2.4.1. Power On Mode

Press and release the **Power** button to turn the MCD on. When you first turn the camera on, you may be required to log in, and a touch panel calibration screen may appear.

When the power is on the Power indicator LED is green.

2.4.2. Power Off Mode

Turning off the MCD automatically logs you out. To turn the MCD Off, press and hold the **Power** button for two seconds.

- If the MCD was on, a message is displayed indicating that the MCD is turning off. If a call was active a prompt appears, asking for confirmation to terminate the call.
- If the MCD was in standby, it immediately switches off.

When the power is off the Power indicator LED is off.

2.4.3. Standby Mode

Standby mode provides longer battery life than Power On mode because it shuts down the display and puts the camera into a low power mode. However, incoming calls may still be received. To enter Standby mode,

first turn the MCD on. Then press and release the **Power** button to enter Standby mode.

If a call was active a prompt is displayed asking for confirmation to terminate the call. A message is displayed indicating that the MCD is entering Standby.

When the MCD is in Standby mode, the Power indicator LED is green. This is the only visible indication that the MCD is in Standby mode and is capable of receiving incoming calls.

To come out of Standby, press the **Power** button or answer an incoming call. If your site requires a log-in, you can answer a call but you must log in again before you can use the MCD to stream video. A log-in screen is presented as soon as you do something that requires it.

The MCD also enters Standby mode automatically after a configurable amount of time. To set the Standby delay:

1. From the standard Viewfinder display window, press and release the **Display** button three times (or until the Main Menu appears).
2. Tap the **Configuration** option with the stylus to display the Configuration screen.
3. Display the *General* tab and set the time in the **Standby Timeout** field. Enter a time of '0' to disable automatic Standby mode.

2.4.4. Resetting the MCD (Soft Reset)

If the MCD becomes non-responsive and you cannot turn it off by pressing the **Power** button for two seconds, a soft reset may be required. To reset the MCD, press and hold both the **Power** and **Display** buttons until the display clears (approximately 10 seconds).

Do not perform a soft reset on the MCD unless it stops responding to normal operations.

CAUTION:

A hard reset can be generated using the reset switch accessible through the access hole located inside the battery compartment.

The hard reset should not be used by non-service personnel because damage to the MCD file system may result.

2.5. Logging On & Off

2.5.1. Logging on

If your site requires a login, you will be prompted with a Login screen, as shown to the right. See your site administrator for user name and password.

If the MCD has not been configured, use the default user name and password.

- User name: *admin*
- Password: *admin*

We strongly recommend that you change the administrator password from the default *admin* as soon as you log in.

To login to the MCD:

1. Tap the **Username** field with the stylus. An on screen keyboard appears.



Keyboard appears when you select a text field. Tap the keys with the stylus to enter text.

To move the onscreen keyboard to a new location on the screen, touch the stylus to the edge of the keyboard image and drag it to a new location.

2. Use the stylus to tap characters on the keyboard to enter them into the **Username** field.
3. Use the same process to enter your password.
4. Tap the **OK** button to finish logging in.

Note: If your site administrator has enabled anonymous login, a **Skip** button is available to bypass the login process.

2.5.2. Logging off

To log out:

1. From the standard Viewfinder display window, press and release the **Display** button three times (or until the Main Menu appears).
2. Select **Signout** from the Main Menu by tapping it with the stylus.

2.6. Inserting and Removing an SD Memory Card

The MCD features an SD memory card slot to support configuration and system upgrades and also to support future capabilities. To insert or replace an SD memory card:

1. Open the battery compartment with the stylus screwdriver, and remove the battery.

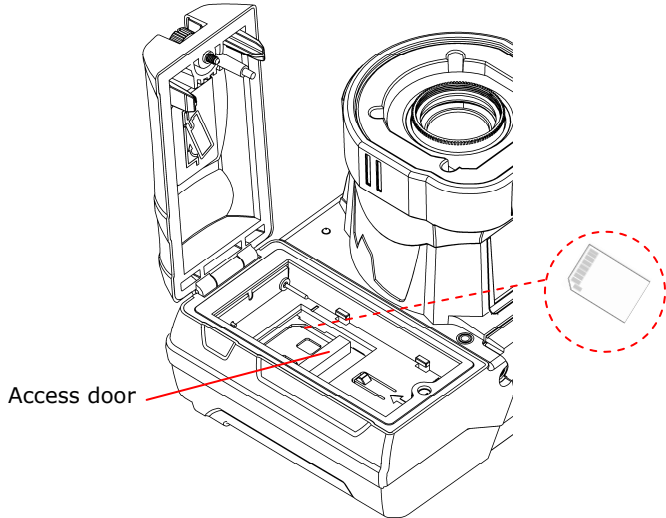

2. If there is already an SD memory card in place, flip open the access door to release it from the slot.
3. Pull the card out. It should slide out easily.
4. Push the card gently in until it clicks into place.
5. Close the access door. Re-insert the battery and close the compartment door.

Note: Do not remove the SD card while recording. This can corrupt the card data.

3. Answering & Initiating Calls

The MCD Operator can either:

- Call an MCA software client user, or
- Answer an incoming call from an MCA software client user.

Use the **Send** and **End** buttons on the Navigation pad to start and end calls, similar to the keys on a mobile phone. Once a call is established, the Operator and Client can collaborate using voice, video, audio, images and annotations.

3.1. Network Access

Before you can answer or initiate a call, you must be able to communicate with the network, either through a direct wired connection, or wireless connection. The Network link indicator, the middle of the three indicators on the top of the MCD, indicates whether or not a Network link exists.

To check current wireless network conditions, you can press the **Display** button once and check the Session information at the bottom of the Viewfinder. Another option is to press the **Display** button three times to display the Main Menu. Tap the **Status** option with the stylus, and then select **Network**. See page 22 for more information on the Viewfinder and Display modes.

3.2. Answering an Incoming Call

To receive incoming calls, the MCD must be on or in standby mode. When a call comes in, the MCD rings like a mobile phone and the Viewfinder displays a dialog box similar to the one shown.

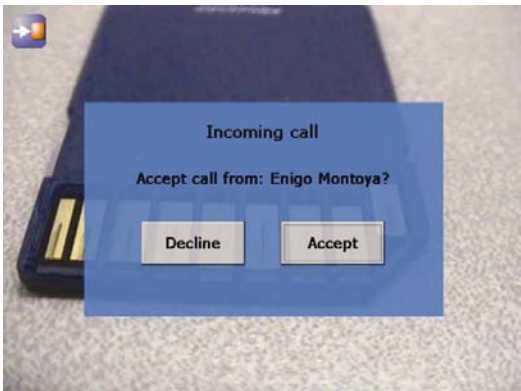

An incoming call displayed on the Viewfinder.

- To accept (answer) the call, tap the **Accept** button or press the MCD **Send** button.
- To refuse the call, tap the **Decline** button, or press the MCD **End** button.

3.3. Initiating (Starting) a Call

To initiate or start a call from an MCD:

1. Press the **Send** button to display a Directory window listing the Clients that this MCD has been set up to contact. This list is maintained by your site's System Administrator.

2. Use the Navigation pad buttons to highlight the Client that you want to call. When you select a name, the Client's destination address appears in the field at the bottom of the window.

If the correct name does not exist, tap the field at the bottom of the window and use the on screen keyboard to enter the address of the Client you need to call. Consult your site administrator for details.

3. When the desired network address is displayed in the **Network address** field, either tap the **Dial** button with the stylus or press the **Send** button to initiate the call.

You will hear the outgoing rings or a busy signal on the MCD just as you would on a mobile phone. When the Client answers the call, the Operator and Client can start talking, just like a mobile phone. If the Client declines the call a message will be displayed indicating the reason.

3.4. Ending a Call

End a call by pressing the **End** button. The Client user can also terminate the call from the MCA application.

3.5. VoIP Telephone Communication

For conversation, the MCD can operate using its built-in microphone and speaker, or a headset:

Speaker phone. If a headset is not attached, the MCD operates as a speaker phone using a built-in omni-directional microphone and speaker.

Headset. If you plug a headset into the headset connector the MCD uses the headset microphone and speaker. This is useful in noisy environments or where privacy is a concern. In this case, Subject Audio continues to use the built-in microphone or external audio line-in, if selected.

Note: Audio-in, S-video, Ethernet and USB are only available on the Sled accessory. For more information on using the Sled, see *Accessories* on page 14.

If the Operator needs to capture particular sounds as part of the video stream (e.g., an odd noise being made by a piece of machinery), you can also set a subject audio source, as described in *Setting the Subject Audio Source* on page 16.

4. Accessories

The MCD2000 comes with an I/O Cover and a Power Plug. The Sled is an optional purchase.

4.1. I/O Cover

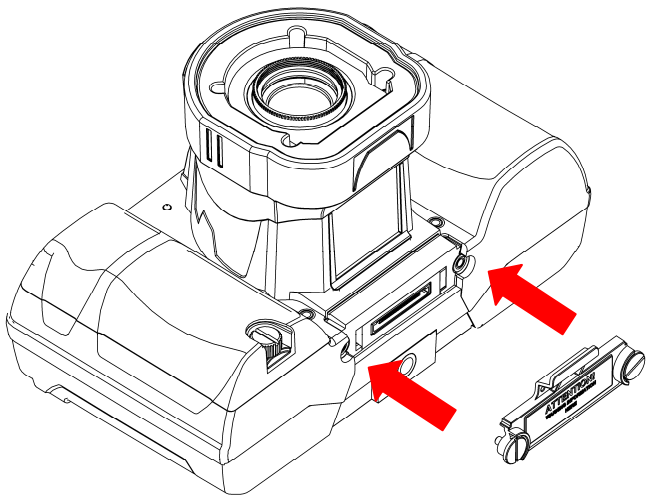

The I/O Cover comes attached to the camera and can be removed using the stylus screwdriver. Remove the cover in order to attach the Power Plug or Sled devices. **Warning for Ex?**

4.2. Power Plug

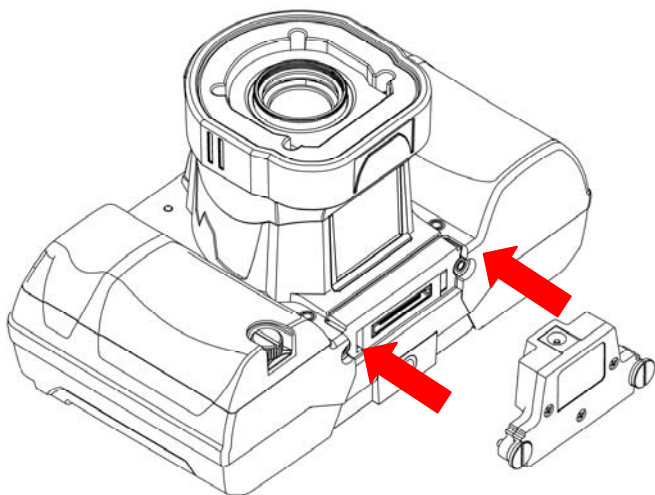

Attach the external Power Plug in order to charge the battery. Remove the I/O Cover, insert the Power Plug into the I/O Connector, and tighten the thumb screws with the stylus screwdriver.

4.3. I/O Sled

The Sled is an optional device that is required in order to use the Audio-in, S-video, Ethernet and USB features of the MCD2000.

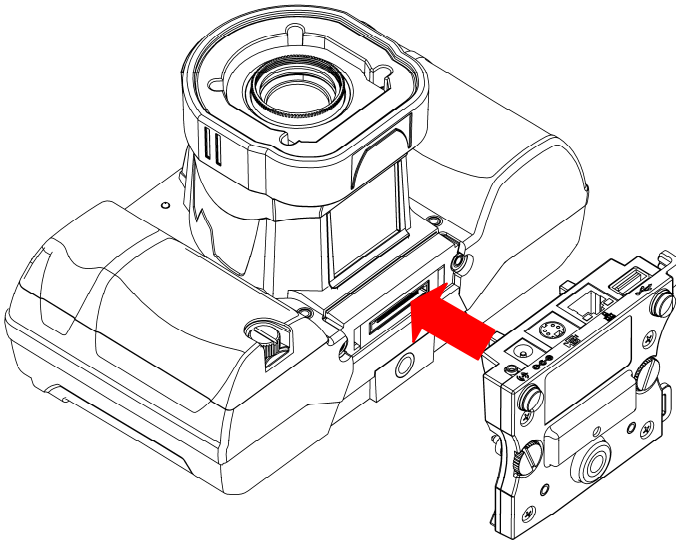

To attach the sled, insert into the I/O connector of the MCD. Tighten the thumb screws with the stylus screwdriver.

The parts of the sled accessory are as follows:

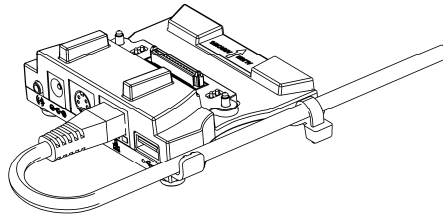

I/O Sled showing cable management

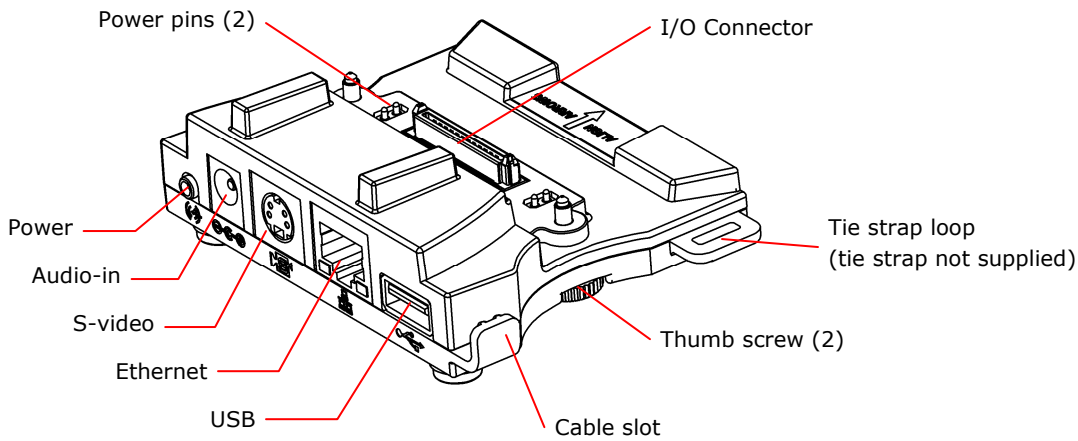

5. Audio/Video (AV) Functions

Once a call is connected, the MCD can send an AV media stream to the MCA software client.

5.1. Turning the Video Stream On or Off

To start streaming real-time video to the MCA software client, press the green **Stream** button on the top of the MCD. Press the **Stream** button again to stop streaming. This does not disconnect the call; the stream can be started and stopped as often as desired within the current call.

This sends a live audio/video media stream from the MCD to the MCA software client. The stream will continue as long as the call is connected (i.e., neither user hangs up the call), or until the Operator or MCA user selects an option to stop streaming.

5.2. Setting the Subject Audio Source

The MCD provides two audio channels: one for subject audio and one for VoIP telephone communication (see page 13).

The Subject audio — the audio being captured and streamed with the video — can be captured by the MCD's built-in microphone or from an audio source connected to the Audio-In port.

Note: Audio-in, S-video, Ethernet and USB are only available on the Sled accessory. For more information on using the Sled, see *Accessories* on page 14.

The Audio-in port can be configured as either microphone or Line-in. This allows the MCD to capture and stream high-quality audio that is time-synchronized with the video. The green **Stream** button also starts and stops streaming of Subject Audio, just as in video streaming described above.

To set which source will act as the Subject Audio Source:

1. From the standard Viewfinder display window, press the **Display** button three times (or until the Main Menu appears).
2. Tap the **Configuration** option with the stylus to display the Configuration screen.
3. Display the *Audio* tab. This tab allows you to control speaker and microphone volume, and to select the Subject Audio Source.

5.3. Using S-video

Note: Audio-in, S-video, Ethernet and USB are only available on the Sled accessory. For more information on using the Sled, see *Accessories* on page 14.

When using an MCD model which has S-video **input/output**, the S-video source must be attached to the MCD and powered before setting the video source to **S-video** in the *Configuration Video* tab. Otherwise, the video stream being sent to the MCA may not synchronize and may not be aligned to the frame. If synchronization does not occur, correct it by setting the MCD's video source to **Internal** and then back to **S-video**. See *Configuration* on page 30 for more information about configuring the MCD video.

5.4. Turning the Illumination Ring On or Off



The light on the front of the MCD can be used to provide extra lighting in dim lighting situations. There are two light settings that trigger a different set of lights on the illumination ring. Use the right cursor pad button to toggle the light settings:

Normal – optimized for distant objects

Macro – optimized for close-ups

Off – turns the light off

Note that if the MCD is displaying a configuration or directory screen, the **Light** button operates as a right arrow key. In this case, press and hold the **Function** control button, then press the right cursor to adjust the light setting.

5.5. Adjusting Zoom Levels

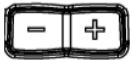

To adjust zoom levels, use the zoom buttons located above the Navigation pad on the back of the MCD.

- To adjust the zoom one step at a time, press and release the **Minus** (-) button (zoom out) or the **Plus** (+) button (zoom in).
- To adjust zoom levels at a faster rate, press and hold the **Minus** or **Plus** button, and release it when the zoom level is where you need it.

The minimum focusing distance changes with the zoom level. As you zoom in, the minimum focus distance moves out. For example, if you are close to an object and zoom in on it, the object will become out of focus if you zoom in too far. The focus adjusts automatically when zooming unless the MCD is in Manual Focus mode. See *Focusing*, next.

If you need to get very close to your subject, set the zoom level to 1x (minimum zoom) and move the MCD until you reach the desired image size. This will ensure that you achieve the best focus.

5.6. Focusing

5.6.1. Automatic Focus

The MCD normally operates in automatic focus mode and will focus on subjects centered in the viewfinder. Focus will continuously update as the distance between the subject and the lens changes or as zoom is adjusted.

There are situations where manual control is desired to fine tune the focus, particularly for objects not centered in the viewfinder. Manual focus control is described in the following section.

Note that zoom and focus controls are available regardless of whether the Viewfinder is currently displayed.

5.6.2. Manual Focus

To set focus manually, the Operator can use the **Plus/Minus** buttons in combination with the **Manual Focus (MF)** button

Manual focus options	
Switch to manual focus and increase or decrease manual focus by one step.	While pressing and holding the MF button, press and release a Plus or Minus button once. When you release the MF button, the MCD remains in manual focus mode, locked at the focus level you

	set.
Switch to manual focus and increase or decrease manual focus at a standard rate.	While pressing and holding the MF button, press and hold a Plus or Minus button until you reach the setting you want. Then release the buttons. When you release the MF button, the MCD remains in manual focus mode, locked at the focus level you set.
Switch from manual focus to automatic focus mode.	Press and release MF (without pressing Plus or Minus).
Set a temporary focus lock.	Press and hold MF (without pressing Plus or Minus). The focus stays locked for as long as you continue to hold the MF button. Automatic focus mode resumes when you release it.

5.7. Telestration (Drawing Lines on the Viewfinder)

Telestration permits the MCD Operator or the MCA software client user to draw freehand lines on a still image or live media stream using the stylus. Telestration markings appear on both the Operator's and the MCA software client display. The system is configured so that lines drawn by the MCD Operator and the MCA software client user appear in different colors.

Tap the Telestration icon to show, hide, or remove existing telestration lines.

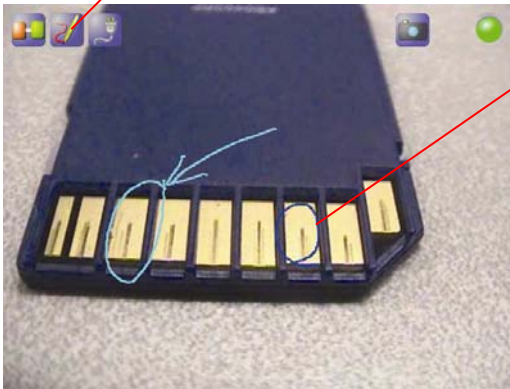

Lines drawn by the Operator appear in a different color from lines drawn by the MCA software client user.

Telestration lines drawn on the Viewfinder.

Telestration is available on the Viewfinder at any time, on both streaming media and still images. It is disabled if the Viewfinder is hidden (e.g. in the configuration or directory screens).

Once telestration lines have been added, an Eraser icon appears in the viewfinder. Tap the **Telestration** icon to display the Telestration menu. Options in the menu allow you to select which telestration lines to show or hide and which lines to erase.

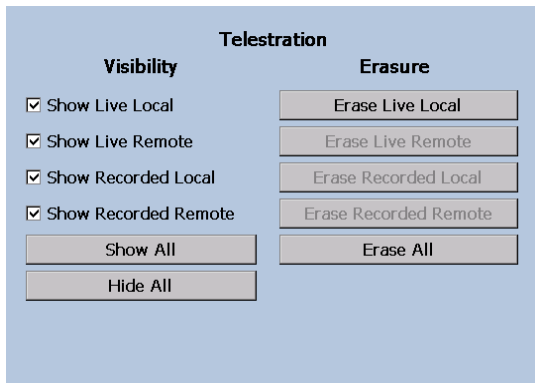

Telestration menu

5.8. Capturing Still Images

To capture a still image, press the **Capture** button on the top of the MCD. (The Capture button behaves like the shutter button on a digital camera.) The captured image is also displayed briefly on the Viewfinder and then cleared. If the MCD is connected to an MCA, the image is sent to the MCA and displayed in the ImageViewer window, but is not shared. Note that if there are telestration lines, these are captured as part of the image.

If **Configuration > General > Freeze video stream when capturing a still image** is set (see page 30), the video stays frozen in the viewfinder and the MCA Call window until the **Capture** button is pressed or you tap on the **Capture** icon. This also occurs when sharing images.

5.9. Sharing Images

The MCD operator and MCA client can collaborate by sharing images with each other while in a call.

To capture and share a new image:

- Press and hold the **Capture** button until the MCD displays "Still image sharing started."

The MCD sends the image to the MCA and saves a copy in the session folder on the SD card.

To end sharing:

- Press the **Capture** button briefly.

To share an existing image:

1. Press the **Display** button repeatedly until the Main menu appears.
2. Tap **File Browser**.
The File Browser window appears.
3. Tap the folder containing the image that you want to share.
Image thumbnails appear in the pane to the right.
4. Select the image you want to share and tap **Share** in lower left pane.
The MCD sends the image to the MCA and saves a copy in the session folder.

5.10. Recording and Playing Videos

The MCD can record video independent of its call state. That is, it can record while connected, disconnected, or calling. The only time that it cannot record is while it is playing back a previously recorded video.

Note: Do not remove the SD card while recording. This can corrupt the card data.

5.10.1. Recording a video

To record a video:

1. Press the **Record** button on the back of the MCD.
The message "Please wait – record is starting" appears briefly. The **Record** icon in the top right of the viewfinder appears when recording starts.
2. To stop recording, press the **Record** button again.
The MCD saves the recording in the location specified in the *General* tab of the Configuration screen. (See *Configuration* on page 30 for more information.) The file name is based on the date and time of the recording.

Video recordings include any telestration lines made during the recording. Telestration lines will appear when you play or stream a video recording, although they will be in different colors.

When you share an image while recording a session, the image appears in the recording.

5.10.2. Playing a video recording

To play back a video that you have just recorded or replay a video:

1. Press the **Display** button on the back of the MCD three times to display the Main menu.
2. Tap **File Playback**.
The Video Playback screen appears.

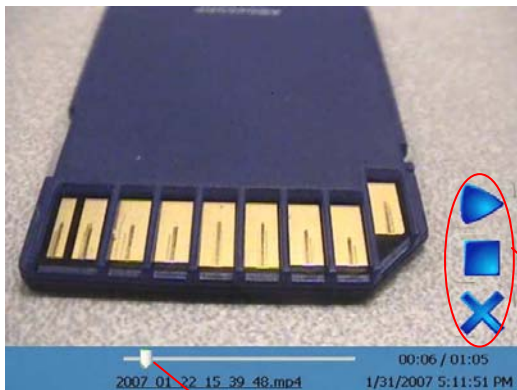





Playback controls

Slide trackbar to advance the video recording.

Video Playback screen.

3. Tap the **Play** icon to start the video.
Playback controls

	Play
	Pause playback

	Stop playback
	Return to viewfinder

The MCD plays the last video recorded or the last video played, whichever is more recent.

To play back a previously recorded video see *Play Videos* on page 20.

For more information on the Main menu, see *Menus* on page 25.

5.11. Streaming a Video Recording

You can stream a video that you have just recorded or replay a video to an MCA. (Note: You cannot stream live video and a recording simultaneously.)

To stream a video that you have just recorded or replay a video:

1. Connect to an MCA.
2. If the MCD is streaming, press the **Streaming** button on the top of the MCD to stop streaming.
3. Press the **Display** button on the back of the MCD three times to display the Main menu.
4. Tap **File Playback**.
The video playback controls appear.
5. Press the **Streaming** button to start streaming and playing the video.
The MCD streams last video recorded or the last video played, whichever is more recent

If you don't want to stream the entire video, you can use the playback track bar, and the **Play** and **Pause** icons to move to the point in the recording where you want to start streaming. When you find the desired place, press the Streaming button.

To stream previously recorded videos, use the File Browser. See *Managing Files* on page 28.

To switch to the File Browser from the Video Playback screen, tap the filename just under the trackbar.

The MCA client can also stream a previously recorded video to the MCD. Playback controls operate the same as when the MCD is streaming the video.

6. Viewfinder Features & Display Modes

The display on the back of the MCD functions as a camera viewfinder. By default, it shows what the lens at the front of the MCD is viewing, but it can also provide status information and menus. Depending on the display mode, the Viewfinder uses a status bar, icons and popup windows to provide information, notifications and prompts as necessary.

Note that status bar information and menus only appear for the MCD Operator. This information does not appear for the MCA client software user who is receiving streamed information.

6.1. Controlling the Viewfinder Mode

To control the Viewfinder mode, press the **Display** button on the back of the MCD. Starting from the Default mode that appears when the MCD first turns on, Operators can press **Display** one or more times to switch the Viewfinder into a different mode, as described below.

Display button	Result
Press and hold	Toggles the display backlight on or power save.
Press and release once	Session information displayed.
Press and release second time	Stream information displayed.
Press and release third time	Main Menu displayed – for configuration and other setup options.
Press and release fourth time	Display returns to default Viewfinder mode.

6.1.1. Turn Viewfinder Backlight On or Power Save

If you are in a call that does not require the Viewfinder backlight, the Operator can press and hold the **Display** button until the backlight dims and enters power-saving mode. Press and hold the button again to turn the backlight back on. Placing the backlight in power save extends run time when operating on battery.

Note: The default backlight level can be set from the MCD configuration screen available from the Main Menu.

6.1.2. Default Viewfinder Mode

This is the default mode that appears when you first turn the camera on. Viewfinder mode maximizes the visible video area by providing as little extraneous screen information as possible. The Status bar area is blank, but icons, pop-up notifications and prompts appear as necessary.



Default Viewfinder mode.

6.1.3. Session Information

Starting from the default viewfinder, press **Display** once to display session information in the Status bar. The Viewfinder shows live camera video and status information as shown at right.

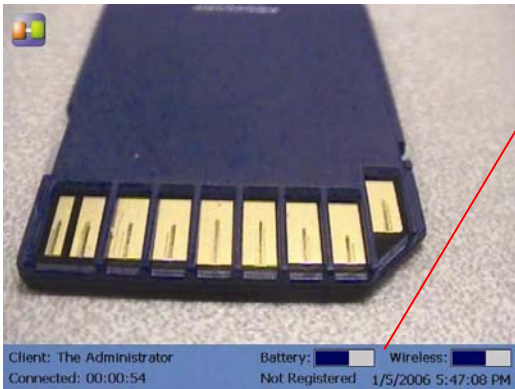

Client Identifier, Connect time, Date/Time, Battery level, Radio signal strength.

Click the Display button once for Session information.

6.1.4. Streaming Status

Starting from the default viewfinder, press **Display** twice to display stream information in the Status bar. The Viewfinder shows live camera video and status information as shown at right.

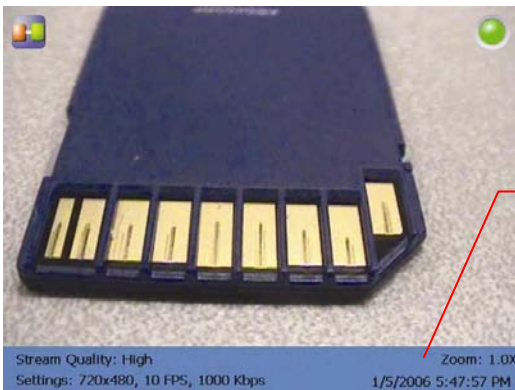

Stream video size, bit rate, FPS (frame rate), quality, Zoom level.

Click the Display button twice for Streaming status information.

6.1.5. Viewfinder Main Menu

Starting from the default viewfinder, press **Display** three times to display the Main Menu. The viewfinder shows live camera video and the menu as shown at right. For more information on the Main Menu and other menu options, see page 25.

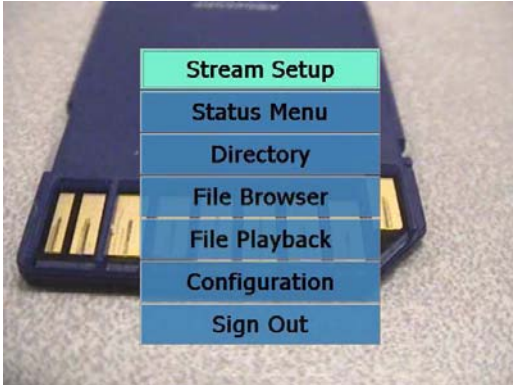

Click the Display button three times to display the Main Menu.

7. Menus

The MCD has a menu system that allows Operators to check and update system settings, view status, access the directory or sign out from the MCD.

Note that system configuration and other setup tasks are usually performed by your site administrator and are described in the System Administration manual.

To display the Main Menu, start from the default viewfinder display, and press the **Display** button three times.

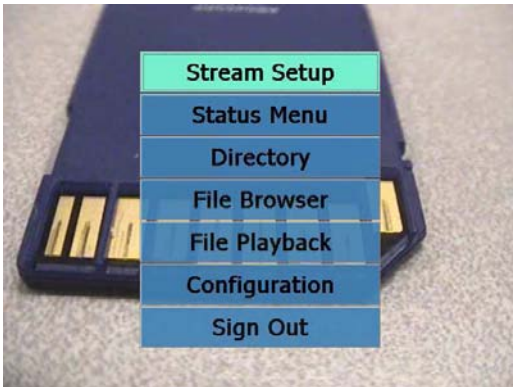

Main Menu on the MCD.

You can display the menus at any time, even while streaming media to a Client user. The person on the receiving end will not see the menus.

7.1. Stream Setup

To check or change streaming setup options:

1. Starting from the default Viewfinder display, press the **Display** button three times to display the Main Menu.
2. From the Main Menu, tap **Stream Setup** to display the streaming options. Three preset configurations are available (defined by your site administrator).



Select a preset option, or select Custom to configure a custom stream.

3. To select a built-in configuration, tap **Low Bandwidth**, **Medium Bandwidth** or **High Bandwidth**, and then select **Accept**.
4. To set up a custom configuration, tap **Custom** and then select **Next >** to display the Custom Stream Configuration window. This allows an

Operator to configure the stream parameters for circumstances where the predefined settings are not adequate.

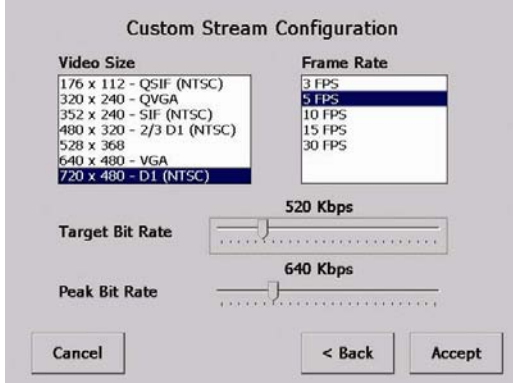

Configuring Custom stream options.

Note: The **Video Size** and **Frame Rate** choices change depending on whether the MCD contains an NTSC or PAL camera.

5. Select your configuration options, and then select **Accept**.

Note: The stream quality can also be selected by the MCA operator.

7.2. Checking Status

The Main Menu offers a number of options for checking status, as shown below.

To view status information:

1. Starting from the default Viewfinder display, press the **Display** button three times to display the Main Menu.
2. From the Main Menu, tap the **Status Menu** option to display a second menu with Status options.

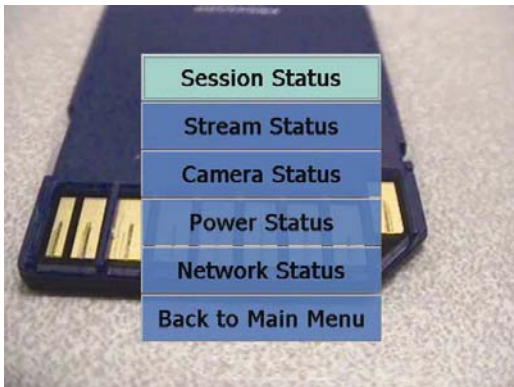

Status options.

3. Tap a status option to view a Status screen for that item. For example, see Power Status below.



Status window for Power.

To dismiss a Status window and return to the Status menu, tap it with the stylus, or click the **Display** button.

4. Contact your system administrator for more information on any particular status item and what it means.

7.3. Viewing Local Contacts

The Local Contacts directory contains a list of names and addresses that can be called from the MCD. To start a call, Operators can display the Local Contacts by tapping **Directory** in the Main Menu, selecting a name and then tapping the **Dial** button on the screen.

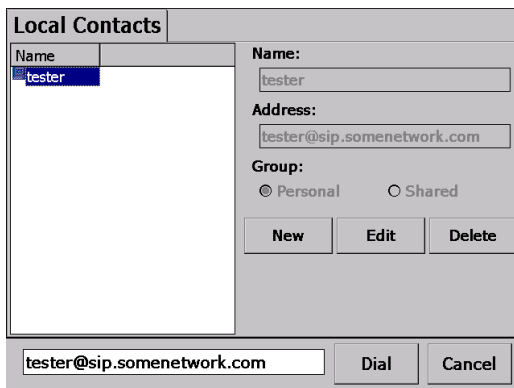

Local Contacts screen

However, the quickest way to access the Local Contacts from the viewfinder is to press the **Send** button, as described on page 12.

If you are logged in as a user with n_sight administrator privileges, you may edit or delete existing contacts or create new ones. Note that these changes are not forwarded to other devices.

7.4. Managing Files

The **File Browser** allows you to organize and play recorded videos.

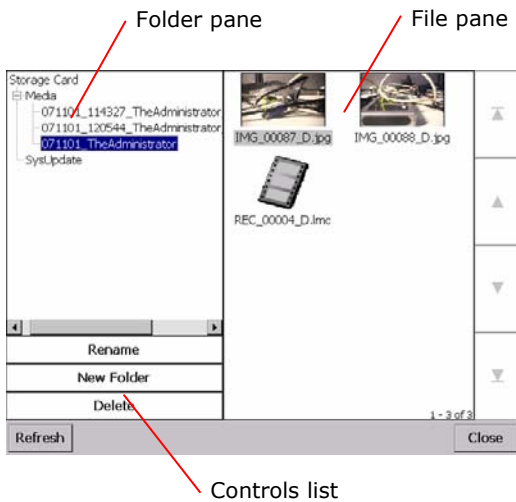

File Browser screen.

The **Folder** pane displays the folders in which video recordings are saved. Use the Scroll bar to browse through long lists of folders.

The **File** pane displays the image snapshots and video recordings saved in the selected folder on the SD card. Use the scroll arrows on the right to browse through long list of files.

The options in the **Controls** list allow you to:

- Rename folders and files
- Create new folders
- Delete folders and files
- Play video recordings
- Display still images
- Share still images
- Format the storage card

Session Folders and File Names

When you capture a snapshot or record a video, the MCD creates a session folder on the SD card in which it saves these files. The name of the folder is based on the date, time, and user names using the convention:

yymmdd_hhmmss_MCAuser_MCDuser

where:

- *yymmdd* is the date of the session
- *hhmmss* is the time that the session started (Present only if connected to an MCA.)
- *MCAuser* is the user name that is logged into the MCA (Present only if connected to an MCA.)
- *MCDuser* is the user name that is logged into the MCD

The snapshot and recording file names are based on their media type, a serial number, the source, and a version number. File names use the convention:



media_serial#_source_version#.extension

where:

- *media* is either IMG for a snapshot or REC for a recording
- *serial#* is a sequential number assigned by the source device
- *source* is either A for MCA or D for MCD
- *version#* is a sequential number that is added if an image has been modified during sharing
- *extension* is either *.jpg* for snapshots or *.lmc* for recordings

File Pane Icons

Files listed in the File Pane are displayed as either image thumbnails or file icons.

Icon	Description
	Image file. Snapshots usually appear as thumbnails but if the MCD cannot display a thumbnail, it displays the Image File icon.
	Video recording file.
	Configuration file. (Files with an .XML extension)

7.4.1. Rename files and folders

To rename a file or folder

1. Select the file or folder you want to rename.
2. Tap **Rename**.
The on screen keyboard appears.
3. Using the stylus, tap the characters on the keyboard to enter a new name.
4. Tap **Rename**.

7.4.2. Play videos

To play a video:

1. Using the Folder and File panes, select the video you want to play.
2. Tap **Play**.
The video playback controls appear. See *Recording and Playing Video* on page 19 for information on using the Video Playback screen.
3. Tap the **Play** icon to start the playback.

Note: When streaming video recordings, the MCD adjusts the current stream parameters to match the frame rate, resolution, bit rate, etc. of the recording.

7.4.3. Display and share images

To display an image file:

1. Using the Folder and File panes, select the image you want to display.

2. Tap **Display**.

The MCD opens the image file.

To end still image display:

1. Press the **Capture** button.

Or

Tap the **Camera** icon at the top of the screen.

The Still Image Details screen appears.

Still Image Details

Filename: 060113_Anonymous\IMG_00000_D.jpg
Date/Time: 1/13/2006 5:53:55 PM
Software: LibreStream Technologies Inc. - Mobile Collaboration Device (MCD)
Author: Anonymous
Title:
GUID: fde054ba-df94-460b-9fe4-99e7a7088b75
Comment:
 Clear still image quick access icon
End Still Image Display

Still Image Details screen

2. Tap **End Still Image Display**.

To share an image:

1. Make a call to an MCA.
2. Open the File Browser.
3. Using the Folder and File panes, select the image you want to share.
4. Tap **Share**.

7.5. Configuration

To check or update MCD configuration options:

1. Starting from the default Viewfinder display, press the **Display** button three times to display the Main Menu.
2. From the Main menu, tap the **Configuration** menu option to display a Configuration window.

Display | Video | Audio | Network | Radio | SIP | Security | SNN ◀ ▶

Auto Login

Service: Local
Username: admin
Password: *****

Anonymous login permitted

Force login when resuming from Standby

Certificates...

Accept Cancel

Tabs on the Configuration window.

From here, follow on-screen instructions to adjust the configuration options as necessary. The table below is provided as an overview. Please

see the System Administration manual for detailed information on MCD configuration.

Tab	Configuration Options Provided
General	Adjust the standby timeout (amount of time before the MCD will switch from On to Standby, if it is idle). Specify the location of saved images and video recordings, and Still Image Capture button mode.
Display	Adjust the brightness of the viewfinder backlight or recalibrate the touch panel.
Video	Adjust the video settings of the camera and select the video source (internal camera or external via S-Video connector).
Audio	Options for controlling volume and mute levels for the speaker. You can set the maximum ring volume (the volume will ramp up to this setting regardless of the overall volume setting of the MCD) and request voice/audio reduced bandwidth usage. This screen can also be used to select the source for subject audio – either the built-in microphone or the Audio line in connector.
Network	This screen allows you to adjust Network settings. Please see the System Administration manual for detailed instructions.
Radio	Options to enable the radio and select radio channels.
SIP	SIP server information necessary for registering this device.
Security	This screen allows you to set default login options and import security certificates.
SNMP	Options to configure the MCD for management by Remote Maintenance Manager (RMM).
Time	Follow on-screen instructions to adjust time and date settings.
Version	MCD version and copyright information. Software updates may also be done from this screen (consult the System Administrator's Guide).
Maintenance	Change user passwords and import contacts and users. (Note that password changes are not forwarded to other devices.)





















8. Icons















Some options or operating conditions cause notification icons to appear on the screen. Many of the icons are touch sensitive — tap the icon with the stylus to view a pop-up message or status screen. For example, tapping the battery warning icon will provide a status screen showing more detailed battery status. Tap the status screen again or press the **Display** button to dismiss the message.



Viewfinder icons provide status information and other notifications.

Standard MCD Icons

Icon	Description	Icon	Description
	Connected to external power		Audio volume increased
	Battery level is critically low or the battery is defective		Audio volume decreased
	Battery fully charged		Audio output muted
	Battery low		Microphone muted
	General alert		Microphone enabled
	Backlight power save		Network connected
	Backlight on		Network disconnected
	Image captured (tap icon or press Capture button to return to live video)		Network error
	Image captured but not displayed (tap icon to display/share the last captured image)		Radio link disconnected
	Call connected		Low radio signal strength

Icon	Description	Icon	Description
	Incoming call invitation		Standby
	Outgoing call request (waiting for remote side to accept)		Stream initializing
	Call disconnected		Media stream active
	Manual focus mode		Media stream is experiencing significant packet loss
	Optical Zoom		Record active
	Illumination is off		Media stream error
	Illumination is on		Telestration icon (tap icon to open the Telestration menu)
	Process successful (e.g. software update complete)		

9. Maintaining the MCD

Follow the guidelines below to ensure the MCD remains in good working order:

9.1. General Recommendations

- Do not expose the MCD to dust, rain or moisture.
- Protect the MCD from temperature extremes (e.g. Do not leave it on an automobile dashboard or on top of a heat source).
- Observe the rated operating and storage environmental specifications.
- The MCD is a precision instrument and must be protected from drop and vibration. Always use the provided wrist lanyard or a neck strap to prevent accidental drop.
- Operate the MCD in a well ventilated area to prevent overheating. Do not block cooling vents. Do not operate the MCD in a closed environment where it can overheat (e.g. a sealed plastic bag).

9.2. Display/Touch Screen

- LCD displays deteriorate when exposed to ultraviolet rays. Do not leave the MCD in direct sunlight or strong ultraviolet rays for extended periods of time.
- If you store the MCD above or below the rated storage temperature, it may cause permanent damage to the display.
- Extended contact with water drops or finger grease may cause discoloration or spots.
- Protect the screen from scratches. Use the supplied stylus or plastic-tipped pens designed for use on a touch screen. Never use a sharp object on the touch screen.
- Tap the screen lightly. Do not press hard or strike the screen.
- Clean the screen with a soft cloth moistened with distilled water. Do not use commercial or household cleaners as they may damage the screen.
- Consider using a replaceable screen protector to help protect against scratches.

9.3. Optics

- If you will be using the MCD in a dusty or dirty environment, it is recommended that the lens be protected with a screw-on lens filter such as a standard 30mm skylight filter.
- Clean the lens with optical lens cleaning cloth and cleaning solution. Do not use general purpose tissue.

9.4. Ergonomic Recommendations

Important: Follow the recommendations below to minimize risk of ergonomic injury.

- Follow the recommendations of your Health and Safety Officer regarding your company's safety policies and procedures.
- Whenever possible, reduce or eliminate repetitive motion.
- Maintain a natural position while operating the equipment.

10. Technical Specifications

SYSTEM ARCHITECTURE

- High performance, multiprocessor architecture optimized for real-time multimedia processing and communications in a handheld form factor
- Microsoft WinCE 5.0
- SIP-based session control
- Windows-based PC Client allowing for easy call initiation and camera control

PHYSICAL CHARACTERISTICS

- Size – 174 (6.85”) mm wide x 96.0 (3.78”) mm high x 87.1 (3.43”) mm deep
- Weight – 720 grams (1.59 pounds)
- Non slip hand grips
- Integrated LED-based illumination
- Integrated water resistant doors for all external connectors

OPTICAL PERFORMANCE

- CCD image sensor – capable of high precision close-up video
- 10x optical zoom, f=4.2 mm (wide) to 42 mm (tele), F1.8 to F2.9
- 10 mm minimum working distance (wide end)
- 1000 mm minimum working distance (tele end)
- 1.5 lx (50 IRE) minimum illumination
- Automatic/manual white balance
- Manual or automatic focus

VIDEO STANDARD

- MPEG-4 Simple Profile @ L3
- Up to 2.5 Mbps
- User selectable resolutions and frame rates up to
- NTSC: D1 (720 x 480) at 30 fps
- PAL: D1 (720 x 576) at 25 fps

USER INTERFACE & FEATURES

- VGA (640 x 480) display/viewfinder
- Integrated touch screen

- User-friendly graphical user interface
- Dedicated call send and end buttons – simple end-user experience much like a mobile telephone
- Still image capture button
- Stream button – video stream can be started and stopped by pushing one button
- Context sensitive cursor pad buttons (includes volume controls, microphone mute, and illumination control)
- Media record to SD card
- Manual focus button
- OSD (On Screen Display) button for easy access to status and other information
- Integrated contacts directory
- End user selectable streaming parameters
- LED indicators for power, stream/record, power/charging, and network link

COLLABORATION FEATURES

- Form factor and software optimized to allow real time voice and video collaboration related to subject matter being captured by the MCD
- Telestration: allowing both the MCD operator and PC operator to draw on top of the video or frozen image – both “ends” of the conversation see the drawing simultaneously
- Remote control of major MCD features – zoom, focus, still image capture, illumination, and stream parameters

AUDIO FEATURES

- Built-in omni-directional microphone for VoIP support
- Built-in microphone or line-in input for capture of subject audio time synchronized with the subject video
- Wired headset support ideal for high noise environments
- Speakerphone with acoustic echo cancellation

- Silence suppression of VoIP communications to minimize network bandwidth utilization
- Dynamic jitter buffer adjusts to changing network conditions to balance low latency with a low voice dropout rate

AUDIO STANDARDS

- VoIP: G.711, GSM
- Subject Audio: G.711, GSM

SECURITY

- User ID and password control
- WLAN Network Authentication:
 - WPA – Enterprise
 - WPA – PSK
 - WPA2
 - WPA2 – PSK
 - Open
 - Shared
- WLAN Data Encryption:
 - WEP
 - TKIP
 - Disabled
- 802.1X Authentication
 - EAP-TLS
 - PEAP

EXTERNAL INTERFACES

- SD/SDHC Memory Card
 - Minimum write speed: 9.0 MB/sec
 - Minimum read speed: 10.0 MB/sec
- S-video
 - Models 200058, 200139 PAL input
 - Models 200024, 200070 NTSC input
 - Model 200071 NTSC output
- External power in
- Headset
 - mono 32 ohm speaker
 - 3.5mm audio jack, 3 conductor, tip mic, ring speaker
- 10/100 Mb Ethernet
- USB Host 2.0, low/full speed
- Audio Line-in
 - 1 Vrms input
 - 2.5 mm audio jack, 2 conductor, tip line-in

COMMUNICATIONS

- IP calls - SIP
- Integrated 802.11 b/g radio
- RJ-45 10/100 Ethernet

POWER

- Rechargeable 2400 mAh Li-Ion battery pack
- External power
 - Input: 12 VDC @ 1A
 - External Power Adapter Specifications:
 - Output Voltage: 12 VDC @ 1.5A
 - Rated Input Voltage: 100 – 240 VAC
 - Input Voltage Range: 90 – 264 VAC
 - Rated Input Frequency: 50 – 60 Hz
 - Input Frequency Range: 47 – 63 Hz

OPERATING ENVIRONMENT

- Temperature:
 - Operating: 0° to 40° C
 - Storage: -20° to 60° C
- Operating humidity: 5 – 80% (non-condensing)

10.1.1. Service Information

If you encounter difficulties with the MCD, contact your corporate technical support department. They will determine whether the problem exists within the network infrastructure or the n_sight equipment and will contact LibreStream Support. See page 45 for LibreStream contact information.

11. Safety & Regulatory Information

General

- Do not attempt to service this equipment. All repairs must be done by an authorized LibreStream service depot.
- Do not block or insert objects into the air vents or other openings in the equipment. Doing so may damage internal components and may cause fire or shock hazards.
- Use only a LibreStream-supplied power adapter with the

equipment. Use of other adapters may cause fire or explosion hazards.

- Operate the external power adapter in a well ventilated area. Do not cover the power adapter with papers or any other items as the adapter may become hot.

Battery

CAUTION!

Risk of explosion if battery is replaced by an incorrect type or installed incorrectly.

- Observe the correct polarity when changing the lithium battery. Install battery according to the manufacturer's product documentation.
- Replace battery only with the same type as recommended by the manufacturer.
- Dispose of used batteries according to the manufacturer's product documentation and local disposal requirements.
- Use only LibreStream-supplied batteries with the MCD. Use of other types may increase the risk of fire or explosion or damage to the equipment.
- Do not store the battery in places where metallic objects may come in contact with the battery terminals (e.g. in a pocket with keys, in a drawer with paper clips, etc.). The resulting short-circuit can cause extremely high temperatures that may damage the battery and cause burns or fires.
- Do not attempt to disassemble the battery. The battery poses a burn hazard if handled improperly. Immediately dispose of a damaged or leaking battery.
- Do not store or leave the MCD or MCD battery near a heat source (e.g. radiator, stove, heater, automobile dashboard, etc.) as the battery may explode or ignite.

Battery Disposal

The MCD2000 uses a Lithium-Ion battery and must be disposed of properly:

- The battery must not be disposed with household or office waste.
- Do not dispose of the battery in a fire as the battery may explode.
- Contact your local waste disposal agency for the address of the nearest battery disposal location.

European Regulatory Information

This product meets the essential health and safety requirements and is in conformity with the relevant EU Directives listed below:

- R&TTE 1999/5/EC
- EU Low Voltage Directive 72/23/EEC
- EU EMC Directive 89/336/EEC

This product has been tested and found to comply with *EN 61000-6-2:1999 Immunity for Industrial Environments*. When in the presence of high levels of radio-frequency electromagnetic fields, the user may notice interference within the audio or video content present on the equipment. If this occurs the user should re-orient the equipment or increase the separation between the equipment and the interfering source. If an external audio headset is being used and is the receiving source of the interference, the user may experience improved performance by using a headset which has been tested and found to comply with *EN 61000-6-2:1999 Immunity for Industrial Environments*.

FCC Class B Notice

This product has been tested and found to comply with the limits for a Class B digital device, pursuant to Part 15 of the FCC Rules. These rules are designed to provide reasonable protection against harmful interference in a residential installation. This product generates, uses, and can radiate radio frequency energy, and if not installed and used in accordance with the instructions, may cause harmful interference with radio communications. However, there is no guarantee that interference will not occur in a particular installation. If the

equipment does cause harmful interference to radio or television reception, which can be determined by turning the equipment on and off, the user is encouraged to try to correct the interference by one or more of the following measures:

- Reorient or relocate the receiving antenna.
- Increase the separation between the equipment and receiver.
- Connect the equipment to an outlet on a circuit different from that to which the receiver is connected.
- Consult the dealer or an experienced radio/TV technician for help.

Caution: Changes or modifications that are not expressly approved by the manufacturer could void the user's authority to operate this equipment.

Industry Canada Class B Notice

This Class B digital apparatus complies with Canadian ICES-003.
Cet appareil numérique de classe B est conforme à la norme NMB-003 du Canada.

Safety Notice

The mobile streaming camera, Model MCD2000 was evaluated to IEC 60950-1:2001, EN60950-1:2001, UL 60950-1:2003 and CSA C22.2 60950-1:2003 standards and found to be in compliance with the standard requirements.



RF Exposure Notice

For body worn operation, this product has been tested and meets RF exposure guidelines when used with an accessory that contains no metal. Use of other accessories may not

ensure compliance with RF exposure guidelines.

This equipment was tested for RF Exposure compliance and meets the requirements with Maximum Peak Spatial-Average SAR_{1g} of 0.01 W/kg. No metallic accessories should be used with this device and multiple devices should not be co-located at a distance of less than 20 cm.

Warning: Changes or modifications not expressly approved by LibreStream Technologies, Inc. could void the user's authority to operate this equipment.

12. LibreStream Limited Warranty Agreement

Hardware: LibreStream warrants to the original purchaser (Buyer) that the hardware Product will be free of defects in workmanship and materials for a period of twelve (12) months from the date of shipment from LibreStream or its designated manufacturer, unless otherwise provided by LibreStream in writing, provided the Product remains unmodified and is operated under normal and proper conditions. The warranty does not extend to persons other than the Buyer who purchased the product in unused condition from LibreStream. Warranty provisions and durations on remanufactured products, and reconditioned or upgraded products, shall be as provided in the particular Product documentation in effect at the time of purchase.

Products may be serviced with parts, components, or subassemblies that originate from returned products and that have been determined to meet applicable specifications for equivalent new material and Products.

The sole obligation of LibreStream for defective hardware Products is limited to repair or replacement (at LibreStream's option) on a "return to

service depot" basis with prior LibreStream authorization. Buyer is responsible for shipment to LibreStream and assumes all costs and risks associated with this transportation; return shipment to Buyer will be at LibreStream's expense. The Product must be returned either in its original packaging or in a similar package affording an equal degree of protection. Buyer shall be responsible for return shipment charges for Product returned where LibreStream determines there is no defect ("No Defect Found"), or for Product returned that LibreStream determines is not eligible for warranty repair. If after investigation LibreStream determines that the reported defect was not covered by warranty, Buyer shall be liable to pay LibreStream, at LibreStream's sole discretion, for the cost of investigating the problem at LibreStream's then prevailing per incident billable rate. No charge will be made to Buyer for replacement parts for warranty repairs. LibreStream is not responsible for any damage to or loss of data or removable data storage media, or the restoration or reinstallation of any software programs or data other than the software, if any, installed by LibreStream during manufacture of the Product.

The above warranty provisions shall not apply to any Product (i) which has been repaired, tampered with, altered or modified, except by LibreStream; (ii) in which the defects or damage to the Product result from normal wear and tear, misuse, negligence, improper storage, water or other liquids, battery leakage, use of parts or accessories not approved or supplied by LibreStream, or failure to perform operator handling and scheduled maintenance instructions supplied by LibreStream; (iii) which has been subjected to unusual physical or electrical stress, abuse, or accident, or forces or exposure beyond normal use within the specified operational and

environmental parameters set forth in the applicable Product specification; or (iv) used with any software, hardware or third party equipment not approved by LibreStream, nor shall the above warranty provisions apply to any expendable or consumable items, such as batteries, supplied with the Product.

Software: Any LibreStream software enclosed or embedded in the hardware Product is warranted in accordance with, and is otherwise subject to, the provisions of the LibreStream End User License Agreement that is applicable to that LibreStream software.

EXCEPT FOR THE WARRANTY OF TITLE AND THE EXPRESS WARRANTIES STATED ABOVE, LIBRESTREAM DISCLAIMS ALL OTHER WARRANTIES OF ANY NATURE OR KIND WHATSOEVER ON HARDWARE PRODUCTS FURNISHED HEREUNDER, INCLUDING ALL IMPLIED WARRANTIES OR CONDITIONS OF MERCHANTABILITY AND FITNESS FOR A PARTICULAR USE. THE REMEDY SET FORTH IN THIS LIMITED WARRANTY AGREEMENT IS THE BUYER'S SOLE AND EXCLUSIVE REMEDY FOR WARRANTY CLAIMS, AND IS EXPRESSLY IN LIEU OF ALL OTHER REMEDIES THAT MAY BE AVAILABLE TO BUYER AT LAW OR IN EQUITY.

13. End User License Agreement

IMPORTANT – PLEASE READ THIS AGREEMENT CAREFULLY.

LIBRESTREAM IS WILLING TO LICENSE THE SOFTWARE TO LICENSEES AND ALLOW LICENSEES TO USE THE SOFTWARE AND LIBRESTREAM PRODUCTS ONLY UPON THE CONDITION THAT EACH LICENSEE ACCEPTS AND AGREES TO BE BOUND BY ALL OF THE TERMS AND CONDITIONS CONTAINED IN THIS AGREEMENT.

FOR ALL INTENTS AND PURPOSES, EACH PERSON WHO DOWNLOADS OR INSTALLS ANY SOFTWARE, OR WHO USES ANY OF THE SOFTWARE OR ANY LIBRESTREAM PRODUCT, IS DEEMED TO BE A LICENSEE, WITH SUCH DOWNLOADING, INSTALLATION AND/OR USE CONSTITUTING IMMEDIATE AND AUTOMATIC ACCEPTANCE OF ALL OF THE TERMS AND CONDITIONS CONTAINED IN THIS AGREEMENT, WHICH WILL BE BINDING ON, AND ENFORCEABLE AGAINST, THAT LICENSEE.

IF ANY POTENTIAL LICENSEE DOES NOT AGREE TO ALL OF THESE TERMS AND CONDITIONS, THEN LIBRESTREAM IS NOT WILLING TO LICENSE ANY OF THE SOFTWARE TO THAT LICENSEE OR TO ALLOW THAT LICENSEE TO USE ANY OF THE SOFTWARE OR ANY LIBRESTREAM PRODUCT. IN SUCH A CASE:

(a) DO NOT DOWNLOAD, INSTALL OR USE ANY SOFTWARE, AND

(b) IF YOU HAVE ALREADY ACQUIRED THE SOFTWARE, RETURN THE SOFTWARE FOR A FULL REFUND OR, IF THE SOFTWARE IS SUPPLIED AS PART OF A LIBRESTREAM PRODUCT, RETURN THAT LIBRESTREAM PRODUCT FOR A FULL REFUND.

1. DEFINITIONS.

1.1 "Agreement" means this End User License Agreement, including any Schedule attached hereto.

1.2 "Computer" means any electronic device that accepts information in digital or similar form and manipulates it for a specific result based on a sequence of instructions.

1.3 "Confidential Information" means (a) the Software and any portions, components or sub-files thereof; (b) the structure, sequence, internal design and organization of the Software and the concepts, methods of operations and ideas disclosed

therein, together with all associated interface information; (c) any trade secrets relating to the Software and/or any LibreStream Product; (d) any tangible items marked "confidential" or with a similar designation by LibreStream or any of its distributors or other representatives or by any Third Party Licensor, and/or any information disclosed visually or verbally and identified by LibreStream or any such distributor or other representative as confidential at the time of disclosure; and (e) the terms and conditions of this Agreement.

1.4 "Intellectual Property" means any patents, patent rights, trademarks, service marks, registered designs, topography and semiconductor mask work rights, applications for any of the foregoing, copyrights, know-how, unregistered design rights, trade secrets and any other similar protected rights in any country.

1.5 "LibreStream" means LibreStream Technologies Inc.

1.6 "LibreStream Product" means any product developed by or for LibreStream that incorporates any of the Software in any manner whatsoever.

1.7 "LibreStream Software" means any software that is proprietary to LibreStream and that is not Third Party Software, and includes in particular the LibreStream software identified in Schedule A hereto.

1.8 "Licensee" means, collectively, each and every person who downloads, installs and/or uses any of the Software and/or any LibreStream Product.

1.9 "party" means each of Licensee and LibreStream, and "parties" means both the Licensee and LibreStream.

1.10 "person" includes an individual, a sole proprietor, a partnership, a corporation, a trust, a syndicate, a joint venture and any other business or legal entity of any nature or kind whatsoever.

1.11 "Purchase Order" means the purchase order or other documentary evidence of any nature or kind whatsoever that is related to this Agreement and that was submitted to and accepted in writing by LibreStream.

1.12 "Software" means, collectively, the LibreStream Software and the Third Party Software, and includes:

(a) all of the contents of the files, disk(s), CD-ROM(s) or other media with which this Agreement is provided or which are installed on any LibreStream Product (including firmware) or which are made available online by LibreStream or any Third Party Licensor including:

(i) all LibreStream or Third Party Licensor computer information or software; and

(ii) any and all related instructional or supplementary documentation in human or machine readable form supplied or otherwise made available by LibreStream or any Third Party Licensor; and

(b) all Upgrades in respect of which Licensee has paid the applicable license, maintenance and/or support fee.

Some of the Software may require activation – Licensees should consult the Purchase Order, the documentation that accompanies the Software and/or the LibreStream website at www.librestream.com for further information in this regard.

1.13 "Third Party Licensors" means, collectively, those third parties who are the respective owners of the Third Party Software, and "Third Party Licensor" means any such third party.

1.14 "Third Party Software" means the software of a person other than LibreStream that is embedded with the LibreStream Software or that is otherwise provided to a Licensee by LibreStream along with the LibreStream Software.

1.15 "Third Party Software License Agreement" means a license

agreement for a particular Third Party Software product, in the form attached to this End User License Agreement as a Schedule or in the form expressly referenced in any such Schedule.

1.16 "Upgrades" means all upgrades, modified versions, updates, additions and copies of any Software (including related documentation) which are provided, installed or made available online or otherwise by LibreStream or any Third Party Licensor.

1.17 "use" or "using" includes accessing, downloading, installing or copying any of the Software or otherwise benefiting from the functionality of any of the Software and/or any LibreStream Product.

2. LIMITED LICENSE.

2.1 Subject to Licensee's strict compliance with the terms and conditions of this Agreement, LibreStream hereby grants to Licensee, during the term of this Agreement, a worldwide, non-transferable, non-exclusive, revocable, royalty-free limited license to use the Software for Licensee's internal business purposes and for no other purpose whatsoever. For greater certainty:

(a) some of the Third Party Software is licensed to Licensee in accordance with the provisions of the Third Party Software License Agreement applicable thereto, which Licensee acknowledges reading and agrees is binding on Licensee;

(b) all of the LibreStream Software and all Third Party Software that is not subject to a Third Party Software License Agreement is licensed to Licensee in accordance with the terms and conditions of this End User License Agreement; and

(c) any default or non-compliance on the part of Licensee or those for whom it is responsible in law with the terms and conditions of this End User License Agreement or with the provisions of any Third Party Software License Agreement shall constitute default and non-compliance by Licensee with this End

User License Agreement and all Third Party Software License Agreements.

2.2 Use of the Software pursuant to this Agreement shall be limited to the single LibreStream Product and to a single Computer as set forth in the applicable Purchase Order and for which Licensee has paid to the LibreStream the required license fee.

2.3 Any use of the Software which is not expressly authorized by this Agreement is strictly prohibited.

Without limiting the generality of the foregoing and notwithstanding any other provision of this Agreement, in no event may Licensee do any of the following or permit any third party to do any of the following:

(a) transfer, assign or sublicense any of its license rights to any other person, or use the Software or any portion thereof on any unauthorized or secondhand LibreStream Product or on any Computer(s) other than the specific Computer(s) on which the Software is licensed to be used - any such transfer, assignment, sublicense or use shall be null and void; or

(b) distribute, license, sublicense, rent, lease or sell the Software or any portion thereof as a standalone product - any such distribution, license, sublicense, rent, lease or sale shall be null and void; or

(c) make error corrections to or otherwise modify or adapt the Software or any portion thereof; or
(d) reverse engineer, decrypt, disassemble or decompile the Software or any portion thereof, or otherwise reduce the Software of any portion thereof to human-readable form, except to the extent otherwise expressly permitted under applicable law notwithstanding this prohibition; or

(e) create any derivative works based upon the Software or any portion thereof or take any actions that would cause the Software or any portion thereof to become subject to the GPL, the LGPL or any other open source license (unless that portion is already expressly subject to the GPL,

the LGPL or any other open source license, as expressly noted in any Third Party Software License Agreement); or

(f) use the Software or any portion thereof to perform services for third parties, whether on a service bureau or time sharing basis or otherwise, without the prior express written consent of LibreStream.

2.4 The Software is licensed, not sold, and is protected by the copyright laws of Canada and other countries and by international treaty provisions. All right, title and interest in and to the Software and any copies thereof, regardless of form or media, shall remain solely with LibreStream or the Third Party Licensors, as the case may be. Except as expressly provided herein, this Agreement does not grant Licensee any rights under any of LibreStream's or any Third Party Licensor's patents, copyrights, trade secrets, trademarks or other Intellectual Property rights. LibreStream and each Third Party Licensor retain all rights not explicitly granted herein.

2.5 Licensee may make such limited copies of the Software as are strictly necessary for backup purposes only, provided that Licensee will not remove, obscure or destroy, and will reproduce on all copies of the Software so made, any LibreStream and any Third Party Licensor names, logos, copyright or other notices, trademarks and other proprietary markings which appear on the Software.

2.6 Licensee is solely responsible for any use by Licensee or by any third party of any password issued to Licensee by LibreStream or any LibreStream distributor or other representative, regardless of whether or not any such third party use was authorized by Licensee.

2.7 Licensee may provide LibreStream or any LibreStream distributor or other representative with suggestions, comments or other feedback regarding Licensee's

evaluation or use of the Software, including but not limited to suggested performance improvements to the Software and/or any LibreStream Product, code enhancements and/or error corrections ("Feedback"). Licensee agrees that any Feedback shall be voluntarily given and that any and all Feedback will immediately and automatically become the property of LibreStream, and that LibreStream shall be entitled to incorporate any Feedback into the Software and/or any LibreStream Product without any compensation or other liability or obligation of any nature or kind whatsoever to Licensee.

3. UPGRADES.

3.1 Notwithstanding any other provision of this Agreement:

- (a) Licensee has no license or other right to use any Upgrade unless Licensee, at the time of acquiring that Upgrade, already holds a valid license to use the Software that is the subject of that Upgrade and has paid to LibreStream the applicable license, maintenance and/or support fee to use that Upgrade; and
- (b) use of Upgrades is limited to the LibreStream Product in respect of which Licensee is the original end user purchaser or lessee and/or to the specific Computer(s) on which the Software is licensed to be used, unless Licensee is otherwise validly licensed to use that Upgrade and complies with Section 3.1(a).

4. AUDIT RIGHTS AND INDEMNITY.

4.1 Licensee shall, within thirty (30) days following Licensee's receipt of written request from LibreStream or any LibreStream distributor or other representative, fully document and certify all uses of the Software that Licensee has made within the period of twelve (12) months prior to the date of receipt of such request. In addition, Licensee shall, upon reasonable advance written notice and during normal business hours, provide access and allow LibreStream or any LibreStream distributor or

other representative to inspect Licensee's books, records and computer systems in order to confirm Licensee's compliance with this Agreement.

4.2 In the event that any such request response or audit determines that Licensee is or was using the Software in a manner that exceeds or exceeded its license rights, Licensee shall immediately pay to LibreStream on demand any amount(s) that are required to rectify such excessive use. This remedy shall be in addition to, and not in lieu of, any other right or remedy that LibreStream may have pursuant to this Agreement or otherwise with respect to such excessive use.

4.3 In the event that any such request response or audit determines that Licensee is otherwise not in compliance with this Agreement, this Agreement shall immediately terminate as contemplated in Section 10.1. Such termination shall be in addition to, and not in lieu of, any other right or remedy that LibreStream may have pursuant to this Agreement or otherwise with respect to such non-compliance.

4.4 Licensee shall indemnify LibreStream and save LibreStream harmless from and against any and all losses, damages, liabilities, costs and expenses (including, without limitation, reasonable attorneys' fees) that arise out of or are attributable in any manner whatsoever to any non-compliance on the part of Licensee or those for whom it is in law responsible with any provision of this Agreement.

5. CONFIDENTIAL INFORMATION. Licensee shall not disclose to any third party, or use for any purpose not expressly permitted herein, any Confidential Information. Licensee agrees to take all reasonable measures to protect the Confidential Information and to prevent unauthorized disclosure thereof, which measures shall be at least as stringent as those measures Licensee takes to protect its own

confidential information of like kind and which shall in no event be less than would be taken by a prudent business person in similar circumstances. Without in any way limiting the foregoing, Licensee shall restrict access to Confidential Information, including the Software, to Licensee employees and individual third party contractors who have executed a written agreement with Licensee sufficient to protect the Confidential Information in accordance with the provisions of this Agreement and who have a "need-to-know" to carry out the licenses granted herein. Notwithstanding the foregoing, all Confidential Information, any and all documents and other tangible material and/or objects containing or representing Confidential Information and any and all copies thereof shall be and always remain the property of LibreStream or the Third Party Licensors, as the case may be.

6. REPRESENTATIONS AND WARRANTIES.

6.1 LibreStream warrants that the LibreStream Software will perform in substantial conformance to the applicable LibreStream published specifications for that LibreStream Software for a period of 12 months from the date of shipment from LibreStream or from the date of downloading by Licensee, whichever is earlier, provided that (a) the LibreStream Software remains unmodified by anyone other than LibreStream; (b) the LibreStream Software is and has always been operated under normal and proper conditions on the authorized LibreStream Product and/or Computer on which that LibreStream Software is licensed to be used; (c) the LibreStream Software has not been used in any manner for which it was not designed; (d) the LibreStream Software has not been used with any unauthorized software, hardware or third party equipment; (e) Licensee is not in breach of this Agreement; and (f) notice of any claim under this limited warranty is

received in writing by LibreStream within the 12 month limited warranty period.

6.2 Licensee's sole and exclusive remedy (at law, in equity or otherwise), and the sole and entire responsibility and liability of LibreStream, with respect to any claim under the limited warranty set forth in Section 6.1 is for LibreStream, at its sole option and discretion, to either (a) use commercially reasonable efforts to bring the non-warranty-compliant LibreStream Software into substantial conformance with its published specifications; or (b) refund to Licensee the purchase price paid for the non-warranty-compliant LibreStream Software.

6.3 NO REPRESENTATION OR WARRANTY OF ANY NATURE OR KIND WHATSOEVER IS PROVIDED BY LIBRESTREAM REGARDING ANY THIRD PARTY SOFTWARE. IF AND TO THE EXTENT THAT ANY THIRD PARTY SOFTWARE LICENSE AGREEMENT IS ATTACHED TO THIS AGREEMENT AS A SCHEDULE OR IS EXPRESSLY REFERENCED IN ANY SCHEDULE TO THIS AGREEMENT, LICENSEES SHOULD CAREFULLY REVIEW ANY SUCH THIRD PARTY SOFTWARE LICENSE AGREEMENT TO DETERMINE WHETHER OR NOT ANY REPRESENTATION OR WARRANTY IS PROVIDED TO LICENSEE IN RESPECT OF THE THIRD PARTY SOFTWARE THAT IS THE SUBJECT OF SUCH THIRD PARTY SOFTWARE LICENSE AGREEMENT. OTHERWISE, ALL THIRD PARTY SOFTWARE IS PROVIDED "AS IS", WITHOUT ANY REPRESENTATION, WARRANTY OR CONDITION OF ANY NATURE OR KIND WHATSOEVER.

6.4 TO THE MAXIMUM EXTENT PERMITTED BY APPLICABLE LAW AND SUBJECT ONLY TO THE LIMITED WARRANTY IN SECTION 6.1 IN THE CASE OF THE LIBRESTREAM SOFTWARE AND TO ANY EXPRESS PROVISION TO THE CONTRARY IN ANY THIRD PARTY SOFTWARE LICENSE AGREEMENT (WHICH SUCH

PROVISION SHALL BE CONFINED TO THE THIRD PARTY SOFTWARE AND THE THIRD PARTY LICENSOR THAT ARE THE SUBJECT OF THAT THIRD PARTY SOFTWARE LICENSE AGREEMENT), LIBRESTREAM AND THE THIRD PARTY LICENSORS EXPRESSLY DISCLAIM ALL OTHER REPRESENTATIONS, WARRANTIES AND CONDITIONS, WHETHER EXPRESS OR IMPLIED, IN FACT OR BY OPERATION OF LAW, STATUTORY OR OTHERWISE, INCLUDING WITHOUT LIMITATION QUIET ENJOYMENT, NON-INFRINGEMENT OF THIRD PARTY INTELLECTUAL PROPERTY RIGHTS AND THE IMPLIED WARRANTIES OR CONDITIONS OF MERCHANTABILITY, MERCHANTABILITY AND FITNESS FOR A PARTICULAR PURPOSE. IN PARTICULAR, NEITHER LIBRESTREAM NOR ANY THIRD PARTY LICENSOR REPRESENTS OR WARRANTS THAT THE FUNCTIONALITY OF THE SOFTWARE WILL SATISFY ANY OR ALL OF LICENSEE'S REQUIREMENTS, THAT THE SOFTWARE WILL WORK IN COMBINATION WITH ANY HARDWARE OR SOFTWARE PRODUCTS PROVIDED BY THIRD PARTIES, THAT THE OPERATION OF THE SOFTWARE WILL BE UNINTERRUPTED OR ERROR FREE, OR THAT ALL ERRORS OR DEFECTS IN THE SOFTWARE WILL BE CORRECTED. SOFTWARE UPDATES, IF ANY, WILL BE PROVIDED AT THE SOLE DISCRETION OF LIBRESTREAM. LICENSEE ACKNOWLEDGES AND AGREES THAT SOFTWARE IN GENERAL IS NOT ERROR-FREE, AND THAT THE EXISTENCE OF MINOR ERRORS OR DEFECTS IN THE SOFTWARE DOES NOT MEAN THAT THE SOFTWARE DOES NOT PERFORM IN SUBSTANTIAL CONFORMANCE WITH ITS APPLICABLE PUBLISHED SPECIFICATIONS. NEITHER LIBRESTREAM NOR ANY THIRD PARTY LICENSOR SHALL BE RESPONSIBLE FOR THE RECONSTRUCTION OF ANY CORRUPTED OR LOST DATA FILES.

6.5 LibreStream reserves the right to at any time provide a limited warranty for any LibreStream Software that is different from the limited warranty set forth in Sections 6.1 and 6.2. The text of any such different limited warranty will be included with that LibreStream Software, regardless of whether that LibreStream Software is embedded in a LibreStream Product, is provided to Licensee on CDROM or is downloaded by Licensee. In the event of any inconsistency between any such other limited warranty and the limited warranty set forth in Sections 6.1 and 6.2, the inconsistency shall be resolved in favor of such other limited warranty.

6.6 LibreStream may also provide a separate limited warranty with respect to the hardware components of a LibreStream Product.

7. NO LIABILITY FOR INDIRECT DAMAGES. REGARDLESS OF THE FORM OF ACTION, WHETHER IN CONTRACT UNDER THIS AGREEMENT OR IN TORT, INCLUDING NEGLIGENCE OR PRODUCTS LIABILITY, AND TO THE MAXIMUM EXTENT PERMITTED BY APPLICABLE LAW, IN NO EVENT SHALL LIBRESTREAM OR ANY THIRD PARTY LICENSOR HAVE ANY LIABILITY FOR ANY INDIRECT, INCIDENTAL, CONSEQUENTIAL, SPECIAL, PUNITIVE OR EXEMPLARY LOSSES OR DAMAGES OF ANY NATURE OR KIND WHATSOEVER, ARISING OUT OF THIS AGREEMENT AND/OR LICENSEE'S USE OF, DELAY IN USING OR INABILITY TO USE THE SOFTWARE, ANY CONFIDENTIAL INFORMATION AND/OR ANY LIBRESTREAM PRODUCT, INCLUDING BUT NOT LIMITED TO LOST OR CORRUPTED DATA OF LICENSEE OR ANY THIRD PARTY, LOST PROFITS OR LOST GOODWILL, BUSINESS INTERRUPTION OR LOSS OF INFORMATION, FAILURE TO REALIZE SAVINGS, OR FOR ANY CLAIM OR DEMAND AGAINST LICENSEE BY ANY THIRD PARTY, EVEN IF LIBRESTREAM OR ANY THIRD PARTY

LICENSOR MAY HAVE BEEN ADVISED OF THE POSSIBILITY OF SUCH LOSSES OR DAMAGES OR EVEN IF SUCH LOSSES OR DAMAGES WERE REASONABLY FORESEEABLE.

8. LIMITED LIABILITY FOR DIRECT DAMAGES. REGARDLESS OF CIRCUMSTANCES AND REGARDLESS OF THE FORM OF ACTION, WHETHER IN CONTRACT UNDER THIS AGREEMENT OR IN TORT, INCLUDING NEGLIGENCE OR PRODUCTS LIABILITY, AND TO THE MAXIMUM EXTENT PERMITTED BY APPLICABLE LAW, THE CUMULATIVE LIABILITY OF LIBRESTREAM AND THE THIRD PARTY LICENSORS FOR LICENSEE'S DIRECT DAMAGES ARISING OUT OF OR RESULTING IN ANY MANNER WHATSOEVER FROM THIS AGREEMENT AND/OR LICENSEE'S USE OF, DELAY IN USING OR INABILITY TO USE THE SOFTWARE, ANY CONFIDENTIAL INFORMATION AND/OR ANY LIBRESTREAM PRODUCT, INCLUDING WITHOUT LIMITATION ANY UNCURED MATERIAL DEFAULT, BREACH OR FAILURE ON THE PART OF LIBRESTREAM OR ANY THIRD PARTY LICENSOR UNDER THIS AGREEMENT, SHALL IN NO EVENT EXCEED THE GREATER OF THE LICENSE FEE INITIALLY PAID BY LICENSEE FOR THE SOFTWARE OR ONE DOLLAR (\$1.00), IN CANADIAN CURRENCY.

9. FUNDAMENTAL UNDERSTANDING REGARDING RISK ALLOCATION. LICENSEE ACKNOWLEDGES AND AGREES THAT THE FEES PAYABLE BY LICENSEE PURSUANT TO THIS AGREEMENT OR ANY PURCHASE ORDER HAVE BEEN DETERMINED BY LIBRESTREAM BASED UPON A SPECIFIC RISK ALLOCATION BETWEEN LIBRESTREAM AND THE THIRD PARTY LICENSORS, ON THE ONE HAND, AND LICENSEE, ON THE OTHER HAND, AND THAT LIBRESTREAM WOULD NOT HAVE ACCEPTED ANY PURCHASE ORDER THAT RELATES TO LICENSEE AND WOULD NOT HAVE LICENSED THE SOFTWARE TO LICENSEE PURSUANT TO THIS AGREEMENT IN THE

ABSENCE OF SECTIONS 6, 7 AND 8. LICENSEE FURTHER ACKNOWLEDGES AND AGREES THAT THESE SECTIONS SHALL APPLY NOTWITHSTANDING ANY FAILURE OF ESSENTIAL PURPOSE OF ANY LIMITED REMEDY. IN JURISDICTIONS THAT PROHIBIT EXCLUSION OF LIABILITY OR LIMITATION OF IMPLIED WARRANTIES, SECTIONS 6, 7 AND 8 MAY BE LIMITED IN THEIR APPLICATION TO LICENSEE AND, DEPENDING ON LOCAL LAW, LICENSEE MAY HAVE OTHER SPECIFIC LEGAL RIGHTS.

10. TERM AND TERMINATION.

10.1 The licenses granted pursuant to this Agreement are perpetual unless terminated earlier as specified herein. Licensee may terminate the licenses and this Agreement at any time upon the provision of written notice to LibreStream. Without prejudice to any other right or remedy which may be available to LibreStream, the licenses and this Agreement shall immediately terminate without the necessity of any notice from LibreStream in the event that Licensee:

- (a) fails to comply with any provision of this Agreement; or
- (b) makes any voluntary arrangement with its creditors for the general settlement of its debts or becomes subject to the supervision of a bankruptcy tribunal; or
- (c) has an order made against it, or passes a resolution, for its winding-up, or has a lien holder take possession of, or has a receiver or similar officer appointed over, all or substantially all of its property or assets.

10.2 Upon termination of this Agreement for any reason, Licensee agrees to immediately cease use of, and to return or destroy, at LibreStream's sole option, the Software and any other Confidential Information in Licensee's possession, custody or control, together with all copies, including but not limited to deletion of the foregoing from the

Computer and any other computer on which the Software or any portion thereof may have been installed, and to certify such return or destruction in writing.

10.3 Notwithstanding anything to the contrary contained herein, the bold faced and capitalized wording at the beginning of this Agreement and Sections 2.1(c), 2.3, 2.4, 2.6, 2.7, 4, 5, 6, 7, 8, 9, 10, 11, 12 and 13 (and the relevant definitions in Section 1) shall survive any termination of this Agreement for any reason whatsoever.

11. EXPORT. Some of the Software and Confidential Information is subject to United States export control laws and regulations, and some or all of the Software may be subject to export or import regulations in other countries as well. Licensee agrees that it will not export, re-export, transfer or import any of the Software, any of the Confidential Information or any LibreStream Product in violation of any applicable laws or regulations of the United States or any other country. Licensee is responsible for obtaining any licenses or authorizations required to export, re-export, transfer or import all or any portion of the Software and Confidential Information or any LibreStream Product.

12. GOVERNMENT DEPARTMENTS. In the event that Licensee is a governmental entity, only the department(s) or agency(s) specifically licensed in the Purchase Order to use the Software shall have the right to use the Software. Governmental departments or agencies not so specifically licensed must have a separate license and must pay additional license fees.

13. GENERAL PROVISIONS.

13.1 Licensee shall not assign or otherwise transfer this Agreement or any of its rights and/or obligations hereunder, whether in whole or in part, including by operation of law, without the prior express written consent of LibreStream.

13.2 Licensee hereby acknowledges that its breach of this Agreement may cause irreparable harm and significant injury to LibreStream and/or one or more of the Third Party Licensors in an amount that may be difficult to ascertain and for which a remedy at law may be inadequate. Accordingly, Licensee agrees that, in addition to any other rights and remedies it may have, LibreStream shall have the right to seek injunctive relief in any court of competent jurisdiction to enforce Licensee's obligations under this Agreement.

13.3 This Agreement shall be construed and governed by the laws in force in the province of Manitoba, excluding its conflict of laws rules. The parties consent to the jurisdiction of all the courts in Manitoba, and agree that, except for requests for injunctive relief pursuant to Section 13.2, venue shall lie exclusively in Manitoba. **THE PARTIES EXCLUDE IN ITS ENTIRETY THE APPLICATION TO THIS AGREEMENT OF THE UNITED NATIONS CONVENTION ON CONTRACTS FOR THE INTERNATIONAL SALE OF GOODS.**

13.4 When any notice is required or authorized hereunder, such notice shall be given in writing by recognized delivery service or personal delivery addressed to the other party. Notices shall be sent to Licensee at the address set forth in the Purchase Order and to LibreStream at Suite 110, 895 Waverley Street, Winnipeg, Manitoba, Canada R3T 5P4. Either party may change its address for notice hereunder by providing the other party with ten (10) days written notice thereof. Notices shall be effective upon receipt by the recipient.

13.5 The original of this Agreement has been written in the English language, and the governing language of this Agreement shall be English. Licensee hereby waives and agrees not to assert any right to have this Agreement written in the

language of Licensee's place of residence.

13.6 A waiver of any default hereunder or of any of the terms or conditions of this Agreement shall not be deemed to be a continuing waiver or a waiver of any other default or of any other term or condition, but shall apply solely to the instance to which such waiver is directed. The exercise of any right or remedy provided in this Agreement shall be without prejudice to the right to exercise any other right or remedy provided at law or in equity.

13.7 In the event any provision of this Agreement is found to be invalid, illegal or unenforceable, the validity, legality and enforceability of the remaining provisions shall not in any way be affected or impaired, and a valid, legal and enforceable provision of similar intent and effect shall be substituted for such invalid, illegal or unenforceable provision.

13.8 This Agreement constitutes the entire agreement between the parties with respect to the license of the Software and the other subject matter of this Agreement, and supersedes and terminates all other prior and/or contemporaneous verbal and/or written agreements and understandings with respect thereto. No modifications to this Agreement shall be enforceable except when in writing and signed by an authorized signatory of the party to be bound thereby. Without limiting the generality of the foregoing, the terms and conditions of any purchase order or other document submitted by Licensee to LibreStream or to any LibreStream distributor or other representative shall not be binding on LibreStream unless definitively accepted in writing by LibreStream.

13.9 THIS AGREEMENT SHALL IMMEDIATELY AND AUTOMATICALLY BE EFFECTIVE AND ENFORCEABLE UPON ANY DOWNLOADING OR INSTALLATION OF ANY OF THE SOFTWARE OR UPON ANY USE OF ANY OF THE SOFTWARE OR ANY LIBRESTREAM PRODUCT. It shall not

be a requirement to the effectiveness and enforceability of this Agreement that any Licensee or LibreStream execute this Agreement.

SCHEDULE A – LIBRESTREAM SOFTWARE AND LIBRESTREAM NOTICES

Name of LibreStream Software:
MCD

Copyright Notice: Copyright 2004–2008 LibreStream Technologies Incorporated. All Rights Reserved.

Patents Notice: Patents pending in Canada, the United States and other countries.

Trademark Notice: LibreStream, the LibreStream logo, n_sight, the n_sight logo and MCD are either registered trademarks or trademarks of LibreStream Technologies Incorporated in Canada, the United States and/or other countries. All other trademarks are the property of their respective owners.

SCHEDULE B – THIRD PARTY SOFTWARE AND THIRD PARTY LICENSOR NOTICES

1. Third Party Software – LIVE MEDIA Third Party Licensor – Live Networks, Inc.

Live Networks Inc.:

Copyright (c) 1996-2005, Live Networks, Inc. All rights reserved

This library is free software; you can redistribute it and/or modify it under the terms of the GNU Lesser General Public License as published by the Free Software Foundation; either version 2.1 of the License, or (at your option) any later version. (See <<http://www.gnu.org/copyleft/lesser.html>>.)

This library is distributed in the hope that it will be useful, but WITHOUT ANY WARRANTY; without even the implied warranty of MERCHANTABILITY or FITNESS FOR A PARTICULAR PURPOSE. See the

GNU Lesser General Public License for more details.

You should have received a copy of the GNU Lesser General Public License along with this library; if not, write to the Free Software Foundation, Inc., 59 Temple Place, Suite 330, Boston, MA 02111-1307 USA

A copy of the GNU Lesser General Public License is provided on the product CD in the 'licenses' folder. In accordance with section (4) of the GNU General Public License, copies of Live Networks source code and Librestream modified Live Networks code will be provided upon request from Librestream. To obtain the source code on a CD, please send USD\$10 for shipping and handling to: Customer Services LibreStream Technologies Inc. Suite 110, 895 Waverley Street Winnipeg, Manitoba Canada R3T 5P4

2. Third Party Software – DAS BOOT Third Party Licensor – U-Boot

#

(C) Copyright 2000 - 2004

Wolfgang Denk, DENX Software Engineering, wd@denx.de.

#

This program is free software; you can redistribute it and/or

modify it under the terms of the GNU General Public License as

published by the Free Software Foundation; either version 2 of

the License, or (at your option) any later version.

#

This program is distributed in the hope that it will be useful,

but WITHOUT ANY WARRANTY; without even the implied warranty of

MERCHANTABILITY or FITNESS FOR A PARTICULAR PURPOSE. See the

GNU General Public License for more details.

#

You should have received a copy of the GNU General Public License

along with this program; if not, write to the Free Software

Foundation, Inc., 59 Temple Place, Suite 330, Boston,

MA 02111-1307 USA

#

A copy of the GNU General Public License is provided on the product CD in the 'licenses' folder and may also be available at

<<http://www.gnu.org/copyleft/gpl.html>>. In accordance with section (3)

of the GNU General Public License, copies of Das U-boot source code and

Librestream modified Das U-boot code will be provided upon request

from Librestream. To obtain the source code on a CD, please send USD\$10 for shipping and handling to:

Customer Services

LibreStream Technologies Inc.

Suite 110, 895 Waverley Street

Winnipeg, Manitoba

Canada R3T 5P4

3. Third Party Software – Alchemy AU1200 BSP

Third Party Licensor – Raza Microelectronics, Inc.

Copyright (c) Raza Microelectronics Inc. All rights reserved. Alchemy and Au1200 are trademarks of Raza Microelectronics Inc.

The following notice is required regarding the MPEG-4 MAE enabled codec:

This software module was originally developed by Microsoft Corporation and also edited by multiple parties in the course of development of the MPEG-4 Video (ISO/IEC 14496-2). This software module is an implementation of a part of one or more MPEG-4 Video tools as specified by MPEG-4 Video. ISO/IEC gives users of MPEG-4 Video free license to this software module or modifications thereof for use in hardware or

software products claiming conformance to the MPEG-4 Video. Those intending to use this software module in hardware or software products are advised that its use may infringe existing patents. The current developer of this software module and his/her company, the subsequent editors and their companies, and ISO/IEC, have no liability for use of this software module or modifications thereof in an implementation. Copyright is not released for non MPEG-4 Video conforming products. Microsoft Corporation and the other originators of this software retain full right to use the code for their own purpose, assign or donate the code to a third party and to inhibit third parties from using the code for non ISO/IEC 14496 conforming products. This copyright notice must be included in all copies or derivative works.

4. Third Party Software – MPEG-4 Visual Standard

Third Party Licensor – MPEG LA, L.L.C.

Notices:

THIS PRODUCT IS LICENSED UNDER THE MPEG-4 VISUAL PATENT PORTFOLIO LICENSE FOR THE PERSONAL AND NON-COMMERCIAL USE OF A CONSUMER FOR (i) ENCODING VIDEO IN COMPLIANCE WITH THE MPEG-4 VISUAL STANDARD ("MPEG-4 VIDEO") AND/OR (ii) DECODING MPEG-4 VIDEO THAT WAS ENCODED BY A CONSUMER ENGAGED IN A PERSONAL AND NON-COMMERCIAL ACTIVITY AND/OR WAS OBTAINED FROM A VIDEO PROVIDER LICENSED BY MPEG LA TO PROVIDE MPEG-4 VIDEO. NO LICENSE IS GRANTED OR SHALL BE IMPLIED FOR ANY OTHER USE. ADDITIONAL INFORMATION INCLUDING THAT RELATING TO PROMOTIONAL, INTERNAL AND COMMERCIAL USES AND LICENSING MAY BE OBTAINED FROM MPEG LA, LLC. SEE [HTTP://WWW.MPEGLA.COM](http://WWW.MPEGLA.COM).

ALL OTHER THIRD PARTY SOFTWARE INCLUDED IN THE SOFTWARE IS LICENSED TO LICENSEE IN ACCORDANCE WITH THE TERMS AND CONDITIONS OF THE END USER LICENSE AGREEMENT TO WHICH THIS SCHEDULE B IS ATTACHED.

LibreStream Contact Information

Website www.LibreStream.com

Head Office

LibreStream Technologies, Inc.

895 Waverley St., Suite 110
Winnipeg, Manitoba
Canada, R3T 5P4

General Inquiries:

Email information@LibreStream.com

Phone (204) 487-0612

Fax (204) 487-0914

Support:

Email support@LibreStream.com

Phone (800) 849-5507

Fax (204) 487-0914

