

BV04.EPS

Figure 66. OTDR Connected with Launch and Tail Cords

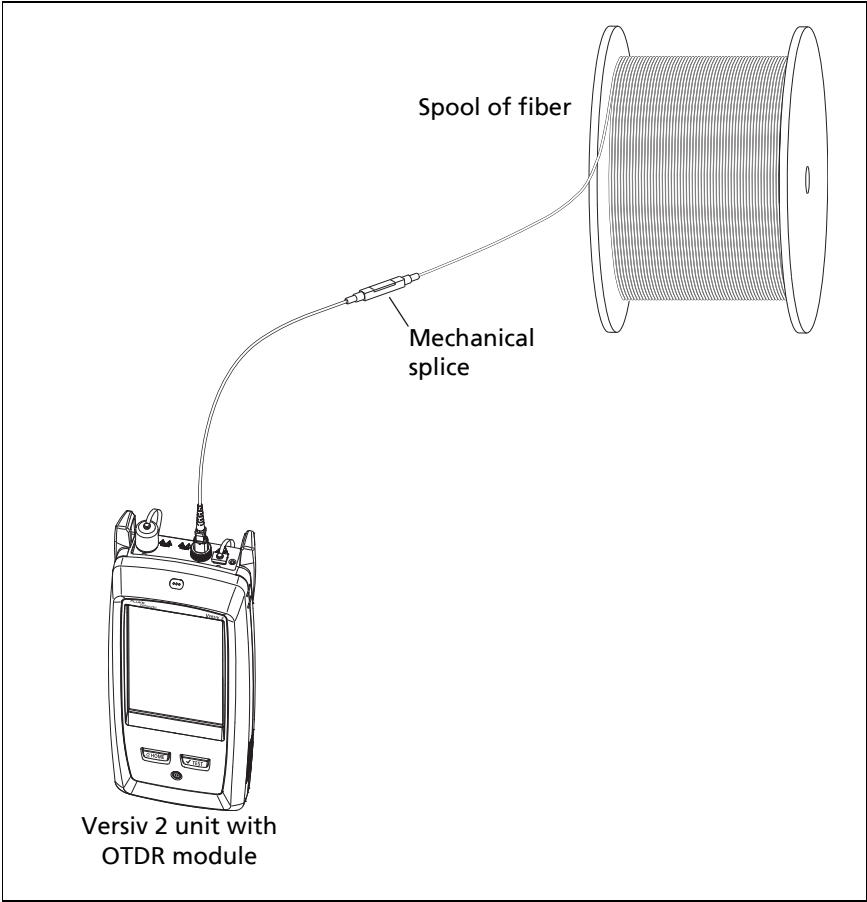

BV05.EPS

Figure 67. OTDR Connected to a Spool of Fiber

OTDR Results

Notes

The tester shows measurements with ">" or "<" when the actual value is possibly more or less than the value shown. For example, this can occur for hidden events or for measurements that are out of the range of the tester.

*When a test is completed, the type of screen the tester shows first (**EventMap**, **TABLE**, or **TRACE**) is the type you looked at last.*

EventMap

Notes

The EventMap combines the results for all wavelengths used for the test. If an event on the EventMap does not show on the event table or OTDR trace, change the wavelength on the OTDR screen.

The EventMap does not show ghosts.

See Figures 68 and 69.

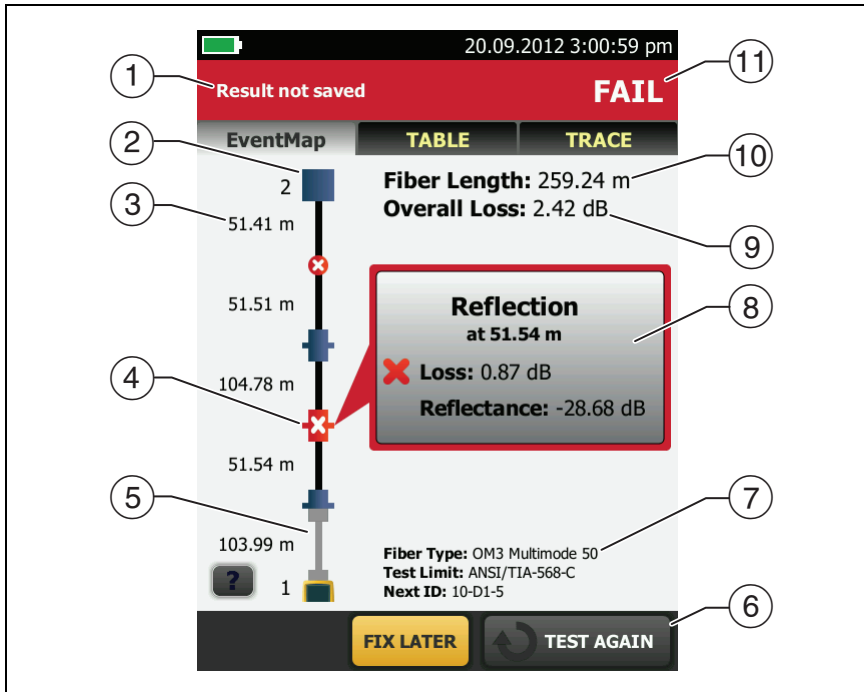

GPU11.EPS

Figure 68. EventMap Example 1

- ① The ID for the results. If **Auto Save** is off, **Result not saved** shows.
- ② The end of the fiber.
- ③ The length of the fiber segment between two events.
- ④ A reflective event:
 - : A reflective event, which is usually a connector. Measurements for the event are all within the test limits.
 - ❌: One or more measurements for the event exceeds the limit.
- ⑤ ■: Launch and tail cords and their connectors show in gray. The map shows these if **Launch Compensation** is on and the cords are connected.

: The arrow icon shows when there are more events that do not show on the screen. To see the events, tap the icon or scroll the map.

- ⑥ When more than one button shows at the bottom of the screen, the tester highlights one in yellow to recommend which one to tap. See “Buttons to Do Tests and Save Results” on page 17.
- ⑦ The fiber type and test limit the tester used for the test, and the ID the tester will use for the next results that you save.
- ⑧ When a test is completed, the window shows information for the event that has the worst measurement. The information windows show the worst results of the wavelengths used for the test.

If the window border is green, the measurements for the event do not exceed the limits.

If the window border is red, a measurement exceeds the limits.

If the window border is blue, the tester does not give a pass or fail result to the event because it cannot do a full analysis of the event. This occurs for **OTDR Port**, **Hidden**, and **End** events. This occurs for all events if you use the **Document Only** test limit because **Document Only** does not have values for limits.

When you use a test limit that has a reflectance limit, **Hidden** events show a fail status if their reflectance exceeds the limit.

: The measurement exceeds the limit.

: The measurement is within the limit.

To see details for the event, tap the window.

To see information for another event, tap another icon on the map.

Note

Events before the launch cord connector and after the tail cord connector do not have a pass or fail status.

- ⑨ **Overall Loss:** The loss of the cabling. This does not include the OTDR connection and the loss of the last event. If **Launch Compensation** is on, the overall loss includes the launch and tail connectors, but not the launch and tail fibers.

If you did the test at two wavelengths, the tester shows the highest loss of the two wavelengths.

N/A shows for the **Overall Loss** if the tester cannot measure the loss. This can occur when events are too close together or when there is a large reflective event near the end of the fiber.

- ⑩ **Fiber Length:** The length of the fiber. The units show in meters (**m**) or feet (**ft**). If **Launch Compensation** is on, the length does not include the length of the launch and tail cords.

- ⑪ **PASS/FAIL:** The overall result for the fiber.

- **PASS:** All measurements are within the test limits.
- **FAIL:** One or more measurements exceed the limit.

Refer to Figure 69:

- ① Length of the tail cord (top) and launch cord (bottom).
- ② A loss event, such as a splice or bend:

: Measurements for the event are all within the test limits.

: One or more measurements for the event exceeds the limit.

- ③ : The event is hidden by a previous event.

The map shows a dotted line around hidden events and the event that causes them to be hidden. The tester combines the loss of all the events that are in the dotted line. To see the combined loss, tap the event that causes the hidden event (④). The tester does not show loss measurements for hidden events.

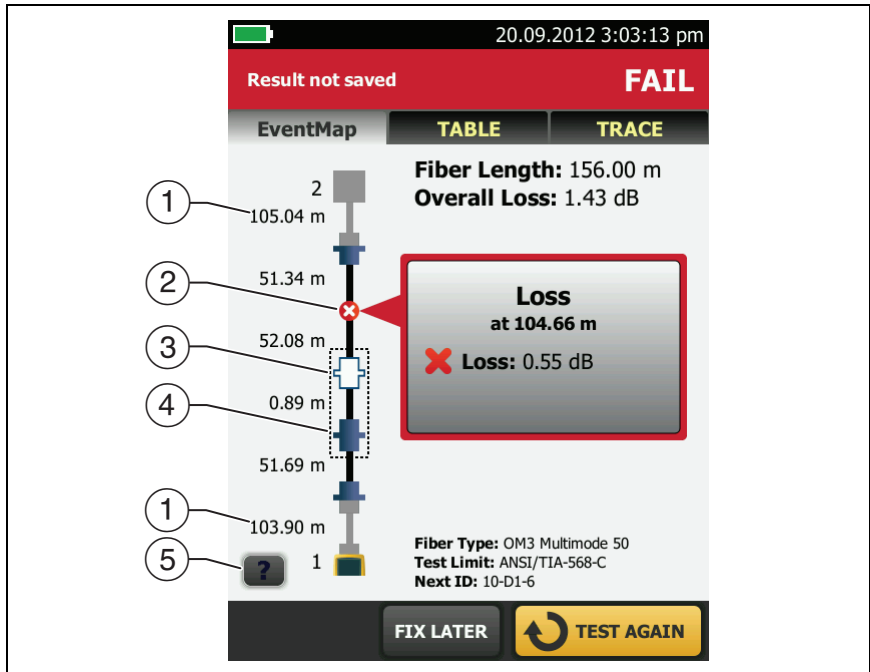

GPU22.EPS

Figure 69. EventMap Example 2

: The event is hidden by a previous event. The reflectance of the event exceeds the limit. This icon shows only when the test limit has a limit for reflectance.

- ④ The cause of the hidden event. In this example, the cause is a connector on a short patch cord. The loss of the second connector is hidden in the attenuation dead zone of the first connector.
- ⑤ Tap  to see information about the selected event.



Event Table

The event table shows a list of the events on the fiber. To see the event table, tap **TABLE** on the OTDR results screen. Figure 70 shows an example of an event table.

- ① To see details for an event, tap the event in the table. Scroll the table if necessary to see all the events.
 - **(ft)** or **(m)**: The distance to the event
 - **LOSS**: The loss of the event.
 - **REFLECT**: The reflectance of the event.
 - **TYPE**: The event type.

Note

*The **OTDR Port** and **End** events always show **N/A** for loss because backscatter measurements are not available on both sides of those events.*

- ② Tap  to see help for this screen.
- ③ **OVERALL**: Tap this button to see overall measurements of length, loss, and optical return loss for the fiber.
- ④ When more than one button shows at the bottom of the screen, the tester highlights one in yellow to recommend which one to tap. See “Buttons to Do Tests and Save Results” on page 17.
- ⑤ If the tester made measurements at two wavelengths, tap the arrow buttons to see results for the other wavelength. Possibly, some events show only at one wavelength.
- ⑥  : The measurement is within the limit.

 : The measurement exceeds the limit.

 : The tester does not give a pass or fail result to the event. This occurs for **OTDR Port**, **Hidden**, and **End** events. This occurs for all events if you use the **Document Only** test limit because **Document Only** does not have values for limits.

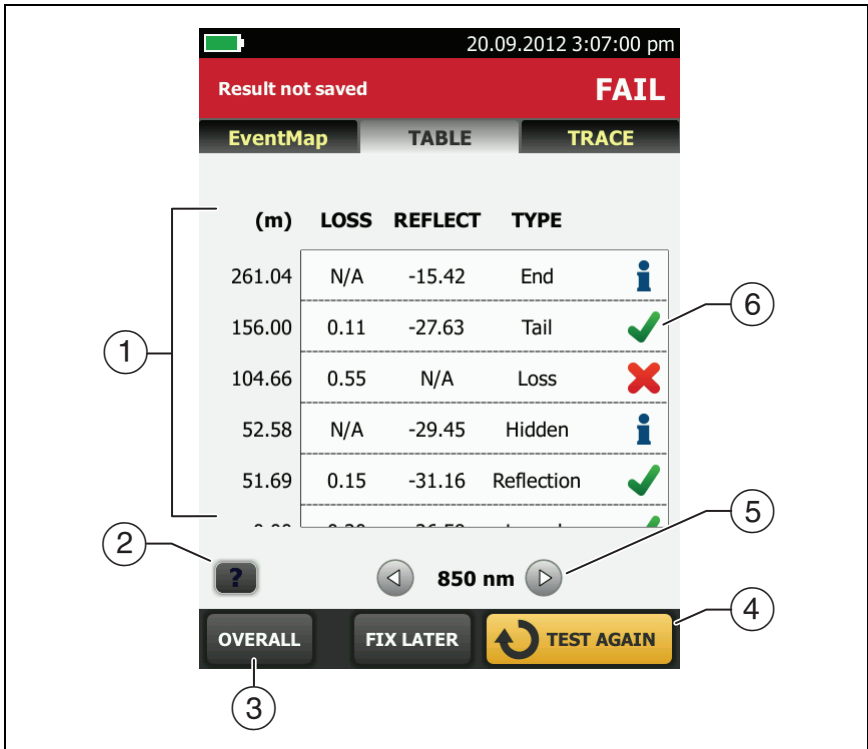

GPU12.EPS

Figure 70. Event Table

When you use a test limit that has a reflectance limit, **Hidden** events show a **FAIL** status if their reflectance exceeds the limit.

To see details for an event, such as limits for measurements and the **SEGMENT ATTENUATION** coefficient, tap the event in the table.

OTDR Trace

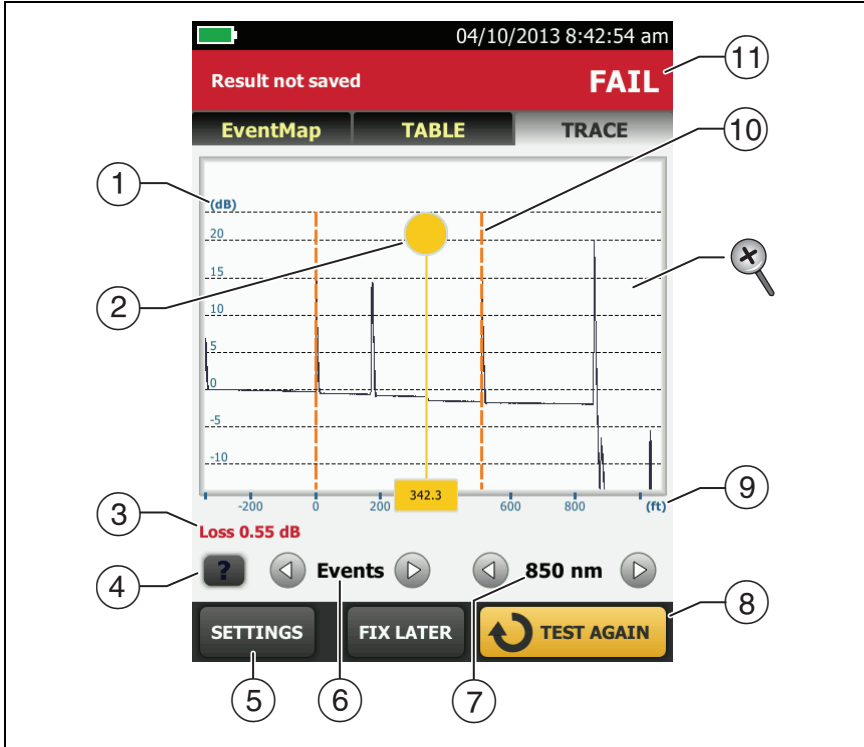

To see the OTDR trace, tap **TRACE** on the OTDR results screen. Figure 71 shows an example of an OTDR trace.



GPU14.EPS

Figure 71. OTDR Trace

- ① The decibel scale shows the level of backscatter. The tester sets the backscatter level at the start of the trace to approximately 0 dB.
- ② The measurement cursor. To measure loss and distance, tap the yellow circle so that **MARK** shows, drag the cursor to the start of the measurement, tap **MARK**, then drag the cursor to the end of the measurement.

- ③ When the cursor is on an event, this area shows the event type. The text is green if the event passed, red if the event failed, or black if there is no limit for measurements. The event type does not show after you tap **MARK** to use the measurement cursor.
 - ④ Tap  to see help for this screen.
 - ⑤ Tap **SETTINGS** to see the settings the tester used for the OTDR test. The tester saves the settings with the result.
 - ⑥ Tap  or  to move the cursor to another event.
 - ⑦ The wavelength the tester used for the test. If the tester used more than one wavelength, tap  or  to see the other wavelength. Possibly, some events show only at one wavelength. You can select wavelengths on the **TEST SETUP** screen.
 - ⑧ When more than one button shows at the bottom of the screen, the tester highlights one in yellow to recommend which one to tap. See “Buttons to Do Tests and Save Results” on page 17.
 - ⑨ The distance scale shows the distance along the fiber.
 - ⑩ Markers for the end of the launch cord and the beginning of the tail cord are orange, dashed lines.
 - ⑪ **PASS**: All measurements were within the limits.
FAIL: One or more measurements exceeded its limit.
-  To zoom in and out, use the pinch, reverse-pinch, and double-tap gestures on the touchscreen. You can also use the zoom controls to change the magnification on the distance and decibels scales independently. See Figure 3 on page 16.

The FaultMap Test

The FaultMap test helps you record the connections in a fiber link and identify bad connections. It can show short patch cords and find connections that have high reflectance. The FaultMap test gives you these results:

- Shows a map of the connectors in the link that possibly do not show on the OTDR EventMap. The map includes connectors that are hidden in the dead zones made by previous events. The FaultMap test shows patch cords as short as 0.5 m for lengths < 2 km.
- Shows connections that are poor because they have high reflectance (> -35 dB).

Reflective events that are apparently not connectors do not show on the FaultMap diagram. Loss events are also not shown.

The FaultMap test finds events that have a reflectance larger than approximately -50 dB on multimode fiber and -60 dB on singlemode fiber. (More negative values mean less reflectance and a better connection. For example, a connector with a reflectance of -40 dB is better than one with -35 dB.)

Notes

Since the FaultMap test finds only reflections, do not use it to look for fusion splices or angled physical contact (APC) connectors.

*FaultMap results do not include a **PASS/FAIL** status. The results are only for your documentation of the link.*

FaultMap tests on singlemode fiber usually take more time than OTDR tests. The test uses very narrow pulses on singlemode fiber to make the smallest event dead zones possible, and does more analysis on the reflections in the link.

How to Do the FaultMap Test

Notes

The FaultMap test does not use the launch compensation settings.

The FaultMap test uses the wavelength that gives the best results.

Figure 72 shows the equipment for the FaultMap test.

- 1 Clean and inspect the connectors on the launch and tail cords or patch cords and the link to be tested.
- 2 Connect the launch cord to the OTDR port and the link to be tested, as shown in Figure 73. Connect a tail cord to the far end of the link if necessary.

Or, you can use a patch cord that is 1 m long at minimum to connect the tester to the link. To see results for the far-end connector, connect a tail cord or patch cord (>1 m) to the far end of the link.

- 3 On the home screen, tap the test setup panel.
- 4 On the **CHANGE TEST** screen, tap the button next to the **FaultMap** test, then tap **USE SELECTED**. If a FaultMap test is not available, tap **NEW TEST** to add one to the project.
- 5 Tap **TEST** or press **TEST**.

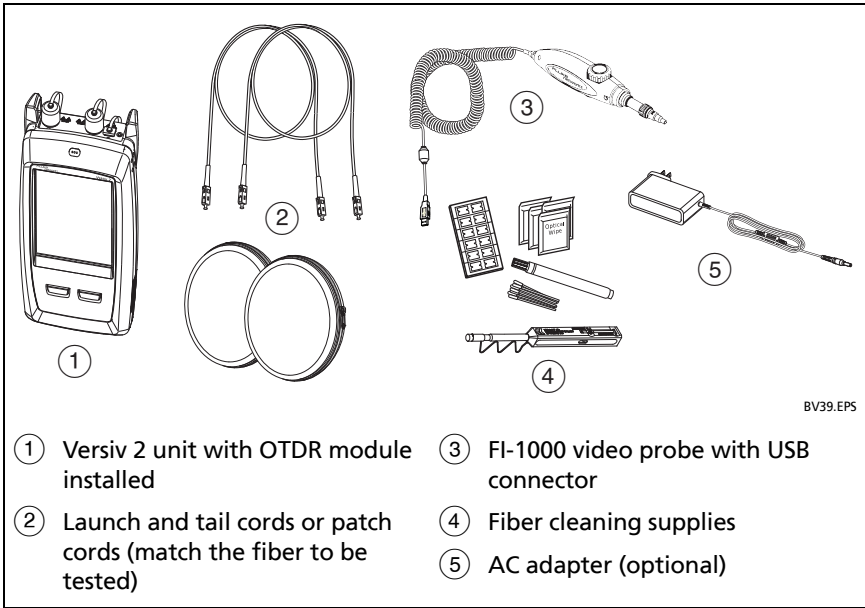
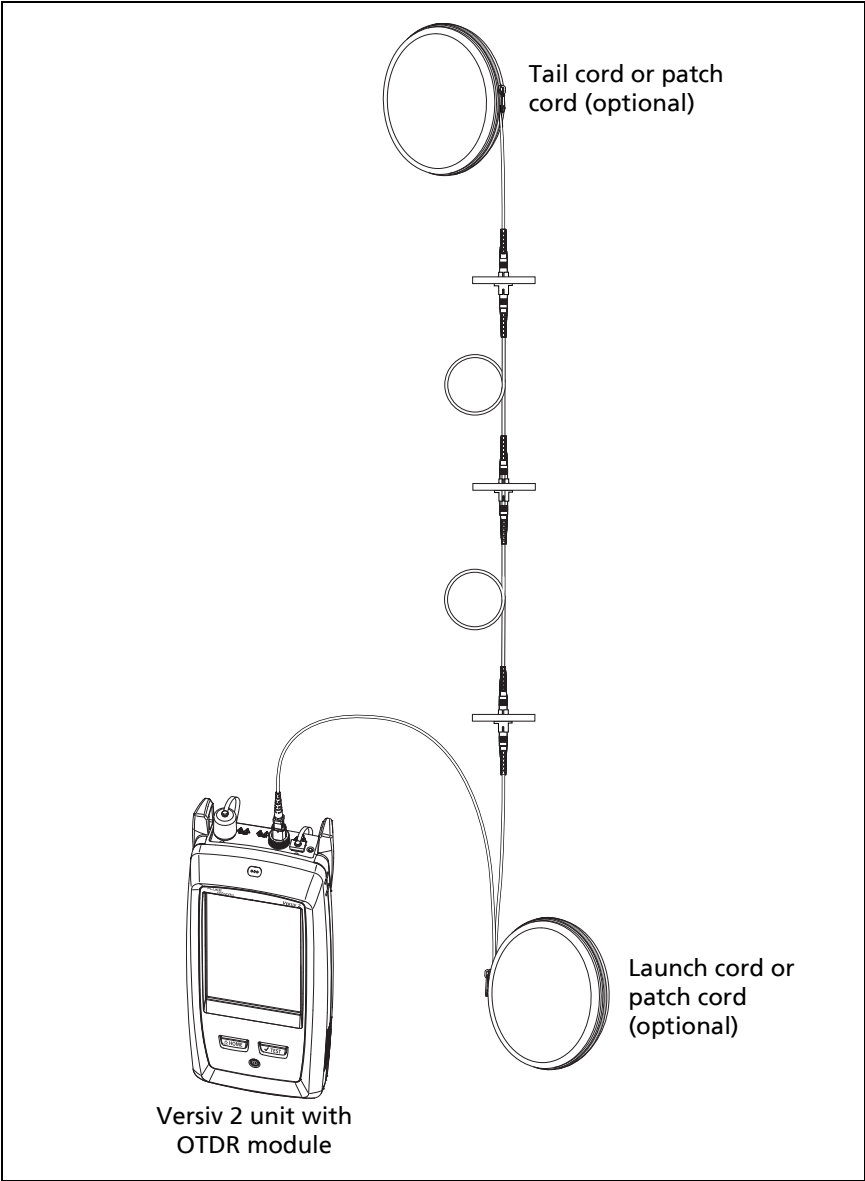

Figure 72. Equipment for FaultMap Tests



BV41.EPS

Figure 73. FaultMap Test Connections

FaultMap Screen

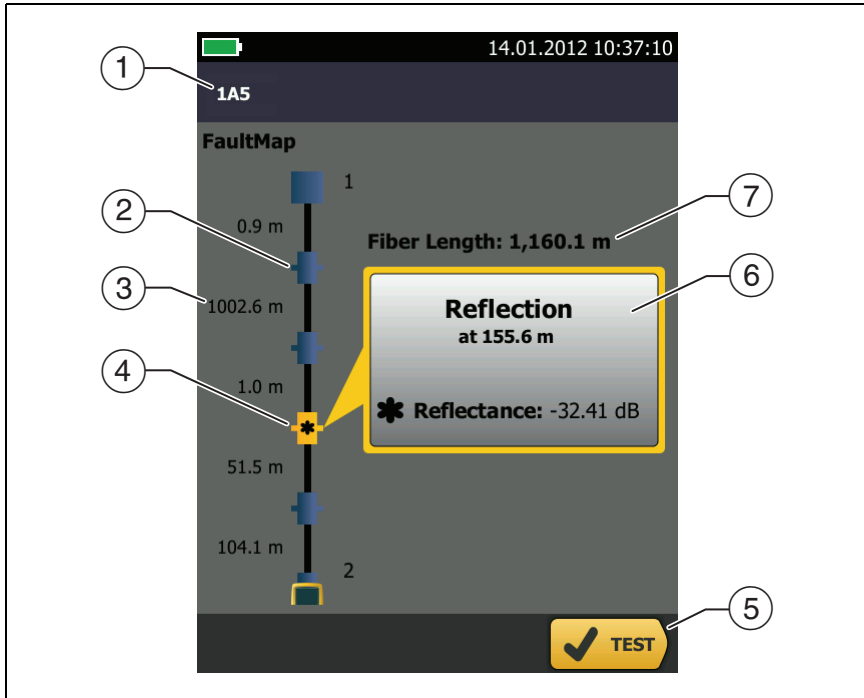





Figure 74. FaultMap Screen

GPU15.EPS

Note

The FaultMap test does not use the launch compensation settings. The results show the launch and tail cords and their connectors in the same colors as other cords and connectors.

- ① The ID for the results. If **Auto Save** is off, **Result not saved** shows.
- ② : An event that has a reflectance smaller than -35 dB.
- ③ The length of the fiber segment between two events.

- ④ : An event that has a reflectance larger than -35 dB. It is possibly a connector that is dirty, poorly polished, scratched, cracked, misaligned, unseated, worn, or the wrong type.
- : The arrow icon shows when there are more events that do not show on the screen. To see the events, tap the icon or scroll the screen.
- ⑤ When more than one button shows at the bottom of the screen, the tester highlights one in yellow to recommend which one to tap. See “Buttons to Do Tests and Save Results” on page 17.
- ⑥ If the window is blue, the reflectance of the event is smaller than -35 dB. If the window is orange, the reflectance is larger than -35 dB.
- To see the window for another event, tap another icon on the fiber.
- ⑦ **Fiber Length:** The length of the fiber. This includes the lengths of the launch and tail cords, if you used them.

The SmartLoop Test

The SmartLoop test lets you connect the far ends of the two fibers in a link and do one OTDR test to get separate results for each fiber.

You use a launch cord to connect the fibers together at the far end of the link. When you do the SmartLoop test, the tester uses the launch compensation settings to remove the effects of the loopback cord and its connectors.

The Auto and Manual settings for the SmartLoop test operate the same as for the OTDR test. See Table 7 on page 157.

Figure 75 shows the equipment for the SmartLoop test.

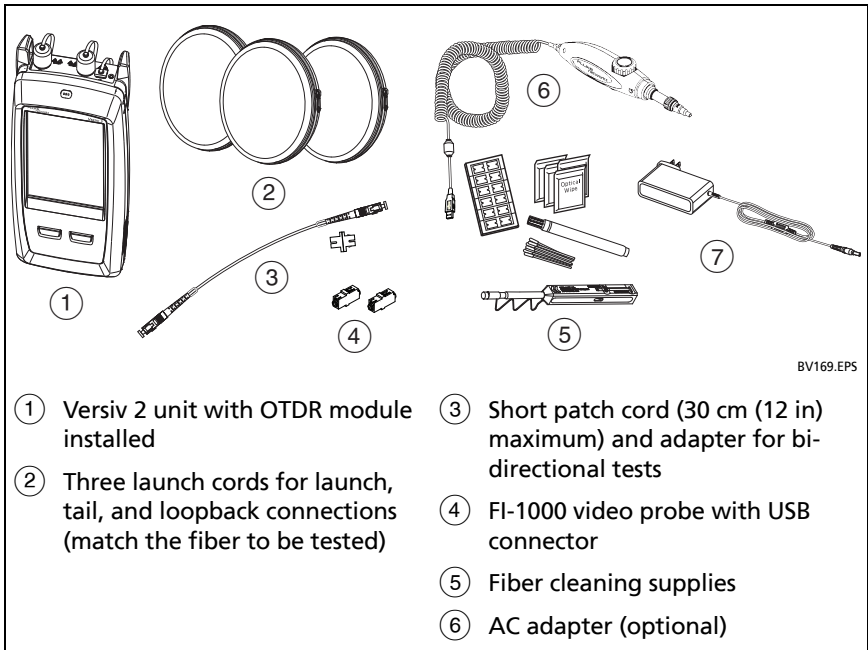

Figure 75. Equipment for SmartLoop Tests

How To Do an Auto SmartLoop Test

Set up the launch compensation function

- 1 On the home screen, tap the test setup panel.
- 2 On the **CHANGE TEST** screen, tap the button next to the Auto SmartLoop test, then tap **USE SELECTED**.

If an Auto SmartLoop test is not available, tap **NEW TEST** to add one to the project. Select settings as necessary on the **TEST SETUP** screen. See “Settings for OTDR Tests” on page 157.

- 3 Select three launch cords that have the same type of fiber as the fiber you will test.
- 4 On the home screen, tap the **TOOLS** icon, then tap **Set Launch Compensation**.
- 5 On the **SET LAUNCH METHOD** screen tap **SmartLoop**.
- 6 Clean and inspect the OTDR port and connectors on the three launch cords.
- 7 Make the connections shown in Figure 76.
- 8 Tap **SET**.
- 9 When the **SET LAUNCH COMP** screen shows, make sure the tester shows the correct distances for the end of the launch cord and the start of the tail cord.

Note

*If the fibers have APC connectors, the tester possibly will not find the correct launch and tail events. If this occurs, do the compensation again and select **Manual Entry** to enter the lengths of the cords manually.*

- 10 Tap **SAVE**.

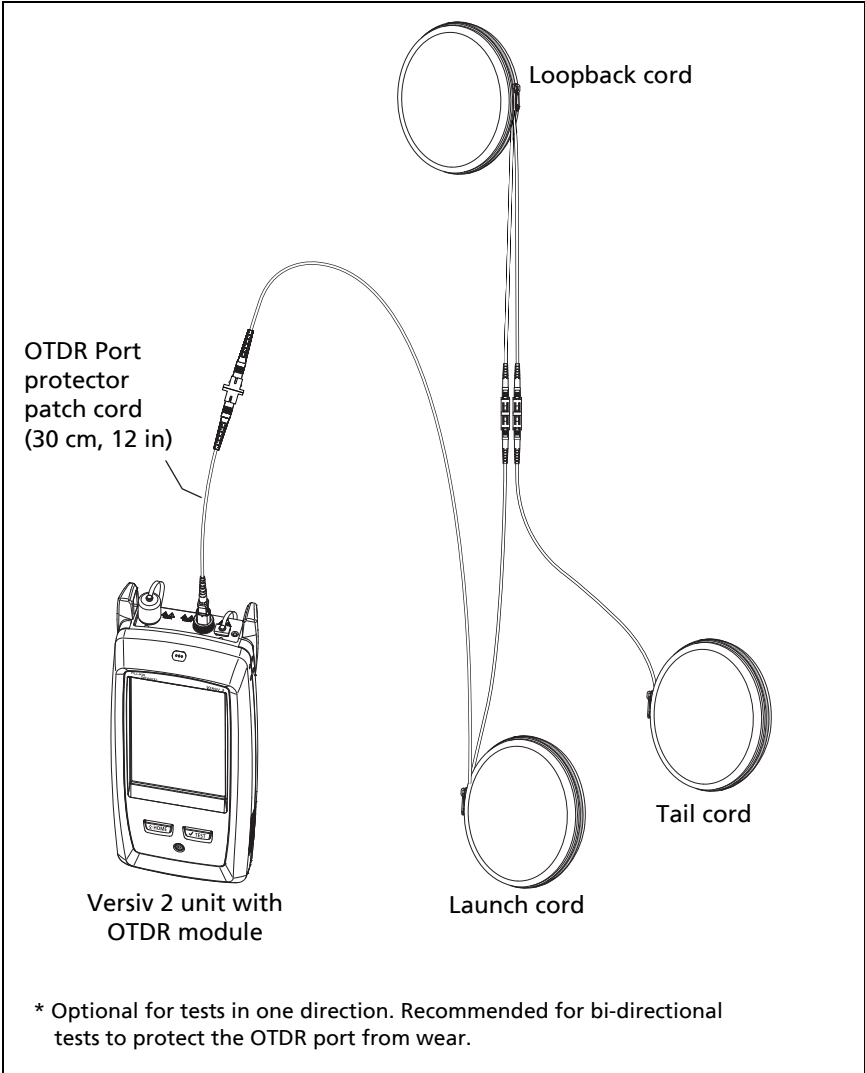

BV170.EPS

Figure 76. SmartLoop Launch Compensation Connections

Do the SmartLoop test

- 1 Make the connections shown in Figure 77.
- 2 On the home screen, make sure the IDs for the fibers are correct. The tester uses the **Fiber A** ID for the fiber connected to the launch cord.
- 3 Tap **TEST** or press .

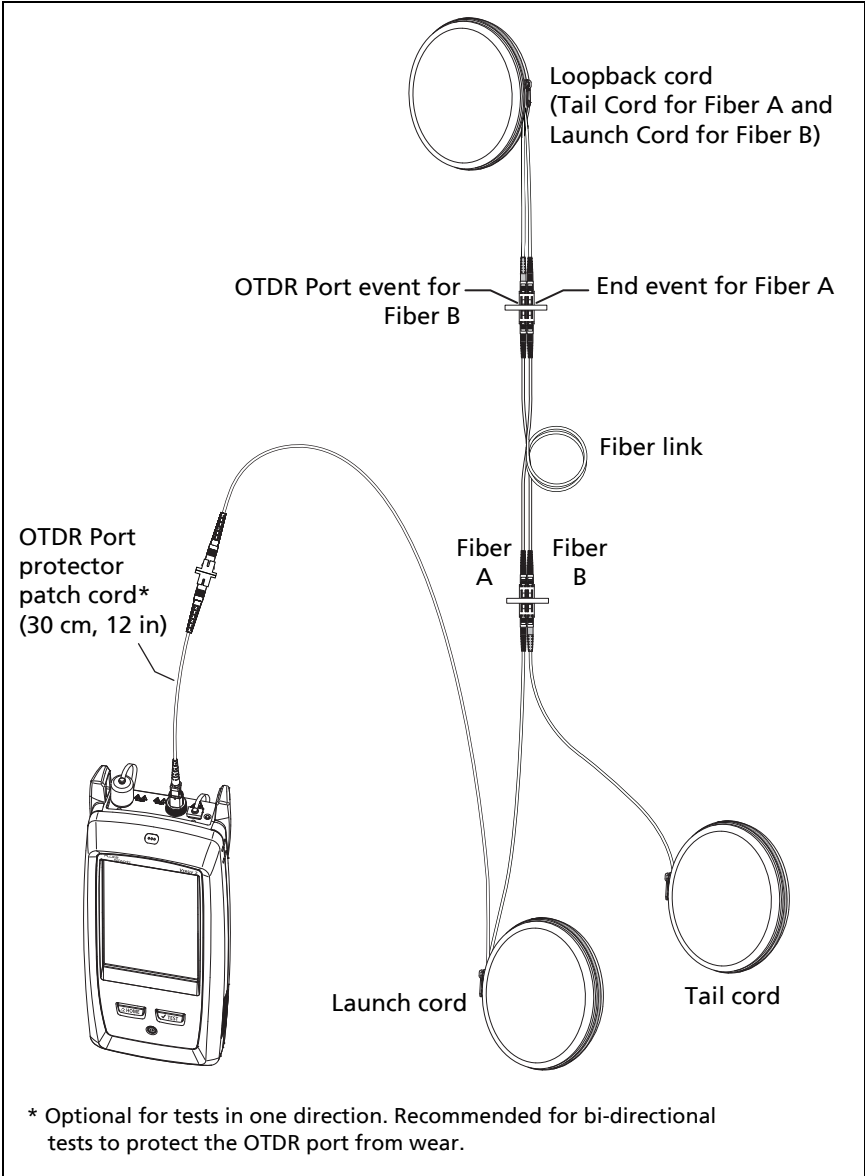

BV171.EPS

Figure 77. SmartLoop Test Connections

SmartLoop Results

The tester shows the SmartLoop results on two sets of **EventMap**, **TABLE**, and **TRACE** screens, one for each fiber in the link. See Figure 78.

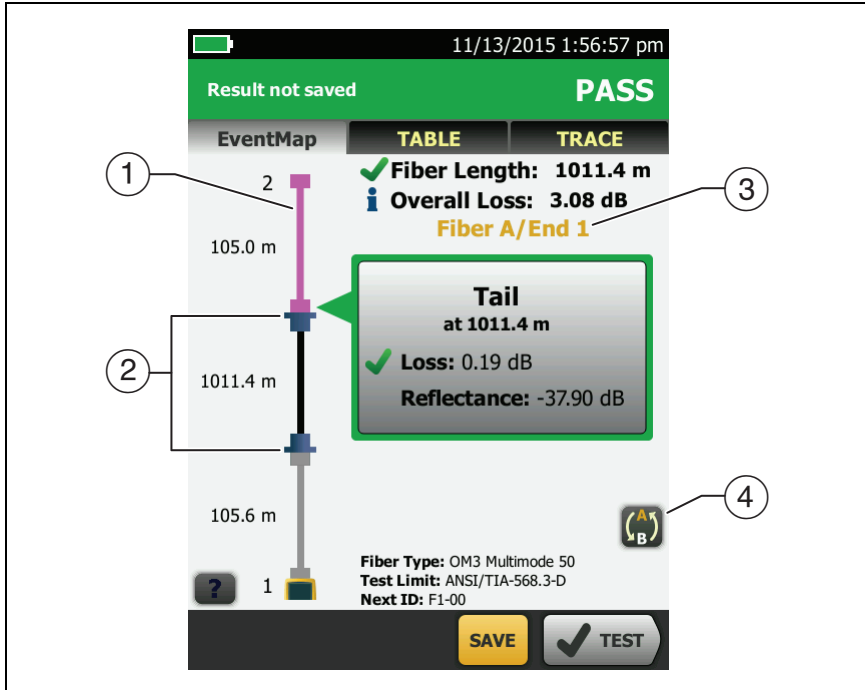

GPU172.EPS

Figure 78. EventMap from a SmartLoop Test

- ① The purple fiber is the loopback cord.
- ② The fiber between the launch cord and the loopback cord is the fiber on one side of the link.
- ③ **Fiber A** is the side of the link connected to the OTDR at **End 1**.
- ④ To switch between results for fibers A and B, tap  on the EventMap screen.

Note

When you save SmartLoop results, the tester saves the results in two records, one for each fiber in the link.

Bi-Directional SmartLoop Tests

OTDR tests from both ends of a fiber can give different results because some properties of fiber and fiber components can cause differences in the loss measurements in each direction.

For example, the loss of an event is the difference between the backscatter levels before and after the event. If a segment after a connector or splice has a higher backscatter value than the segment before, the tester shows different values of loss for the connector or splice from the two directions.

For splices, which have very little loss, the difference in the backscatter of the two fibers can cause an apparent gain in power across the splice in one direction.

For this and other reasons, bi-directional averages of connector and splice loss in both directions are more accurate than measurements from one direction.

The bi-directional SmartLoop test gives you bi-directional OTDR results for both fibers in a link. The tester also automatically calculates averages of the two results and includes the averaged values in the test record.

How to Do a Bi-Directional SmartLoop Test

Set up the launch compensation function

- 1 On the home screen, tap the test setup panel, make sure the correct SmartLoop test is selected on the **CHANGE TEST** screen, then tap **EDIT**.

(continued)

If an Auto SmartLoop test is not available, tap **NEW TEST** to add one to the project. Select settings as necessary on the **TEST SETUP** screen. See "Settings for OTDR Tests" on page 157.

- 2 On the **TEST SETUP** screen, in the **Bi-Directional** panel, tap the control to make it show **On**, then tap **SAVE**.
- 3 On the **CHANGE TEST** screen, tap **USE SELECTED**. Select three launch cords that have the same type of fiber as the fiber you will test.
- 4 On the home screen, tap the **TOOLS** icon, then tap **Set Launch Compensation**.
- 5 On the **SET LAUNCH METHOD** screen tap **SmartLoop**.
- 6 Clean and inspect the OTDR port and connectors on the three launch cords.
- 7 Make the connections shown in Figure 76 on page 187.
- 8 Tap **SET**.
- 9 When the **SET LAUNCH COMP** screen shows, make sure the tester shows the correct distances for the end of the launch cord and the start of the tail cord.

Note

*If the fibers have APC connectors, the tester possibly will not find the correct launch and tail events. If this occurs, do the compensation again and select **Manual Entry** to enter the lengths of the cords manually.*

- 10 Tap **SAVE**.

Do the SmartLoop test

- 1 On the home screen, make sure the IDs for the fibers are correct. The tester uses the **Fiber A** ID for the fiber connected to the launch cord at the start of the test.
- 2 Make the connections for **End 1** as shown in Figure 79.

Note

To decrease the wear on the OTDR connector and help keep it clean, use the OTDR port protector (30 cm, 12 in) patch cord provided to connect the OTDR to the launch and tail cords for bi-directional SmartLoop tests.

To reduce the effect of the port protector patch cord on results, do not use a cord longer than 50 cm (20 in).

- 3 Tap **TEST** or press .
- 4 Halfway through the test, the tester tells you to connect the tail cord to the OTDR port. Make the connections for **End 2** as shown in Figure 79, then tap **DONE**.

The tester automatically calculates bi-directional averages of loss measurements and includes the averaged values in the test record.

Caution

Switch the launch and tail connections at the end of the short patch cord. If you switch the connectors at the patch panel, you will possibly get less accurate results for those connections during the second half of the test.

- 5 If **Auto Save** is on, the tester uses the next two IDs to save the results for the two fibers.

If **Auto Save** is off, and you tap **SAVE** or **FIX LATER**, the **SAVE RESULTS** screen shows the next two IDs available. You can change the IDs if necessary.

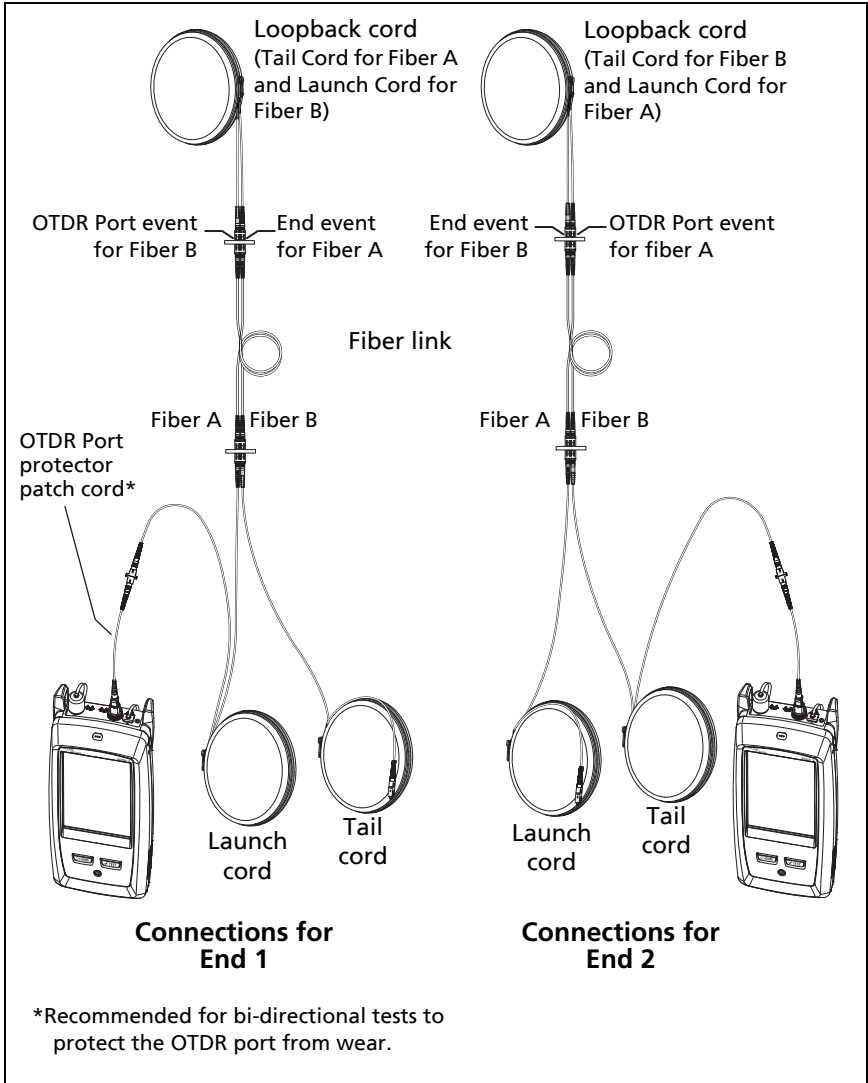

BV176.EPS

Figure 79. SmartLoop Test Connections for a Bi-Directional Test

Averaged Bi-Directional Results

Note

Unless otherwise noted, this section applies to bi-directional results from SmartLoop tests and bi-directional OTDR tests on single fibers.

Figure 80 shows an **EventMap** with averaged results from a bi-directional SmartLoop test.

For averaged results, the tester shows the **EventMap** and the event **TABLE** tabs, but not the **OTDR** tab. The averaged results do not include **Ghost** events.

- For **Hidden** events, the tester calculates the average loss of the event that causes the hidden event, then divides that loss among the events inside the dotted lines. For example, if the average loss of an event is 0.24 dB, and the event causes one event to be hidden, then the average results show 0.12 dB for the event and 0.12 dB for the hidden event.
- For these measurements, the averaged results show the larger or the worst of the two results:
 - Distance between events: larger distance is shown
 - Reflectance: worst value is shown (for example, -30 dB is worse than -40 dB). The reflectance measurements from the unconnected ends are not used in the averaged results.
 - Segment length: larger value is shown
 - Segment attenuation: larger value is shown
 - Fiber length: larger value is shown
 - Overall loss: average value is shown
 - Optical return loss: worse value is shown (for example, 30 dB is worse than 40 dB)
- The **Port Connection Quality** in the averaged results is the rating from End 1.

- The tester does not calculate averaged results in some situations, for example if a launch, tail, or loopback cord was not detected or if the distance to the end was not the same in both directions.

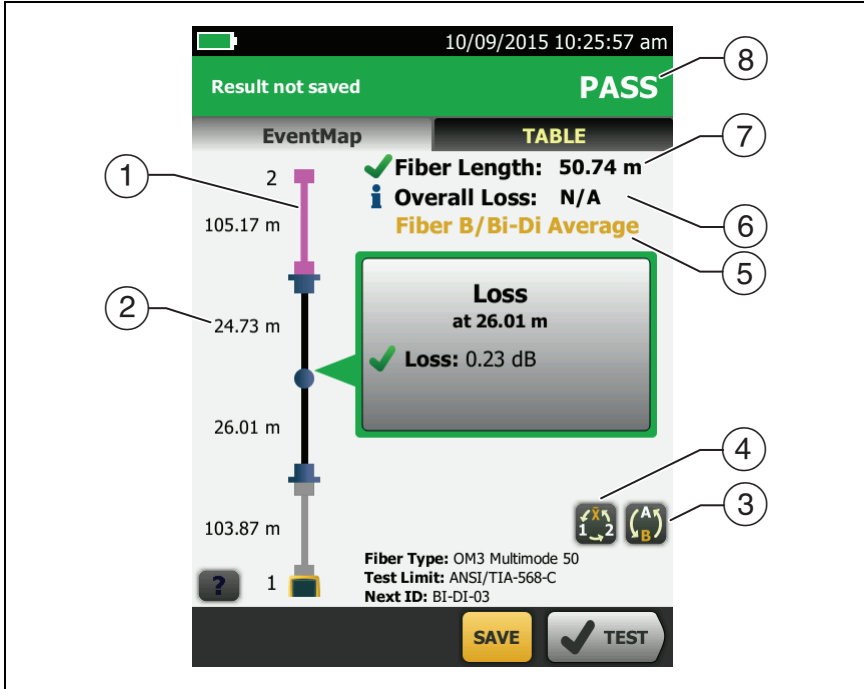

GPU197.EPS

Figure 80. EventMap for Averaged, Bi-Directional SmartLoop Results

- ① The purple fiber is the loopback cord.
- ② The longest segment length of the two directions.
- ③  Tap this button to see the results for the other fiber (A or B).

Touch  for 3 seconds to see a summary of the results from ends 1 and 2 on fibers A and B. To see the EventMap for a result in the list, tap the result.

- ④  This button shows with bi-directional SmartLoop results and bi-directional OTDR results from single fibers. Tap this button to see results from each direction (**End 1** or **End 2**) or the averaged results (\bar{X}).
- ⑤ This line shows which results are on the display. Use the selection buttons (④ and ⑤) to see other results.
- ⑥ **Overall Loss:** The average loss of the two directions.
- ⑦ **Fiber Length:** The longest length of the two directions.
- ⑧ **PASS/FAIL:** The overall result for the fibers.
- **PASS:** The averaged results passed. It is possible for one or both directions to have **FAIL** results, while the overall result is **PASS**.
 - **FAIL:** The averaged results failed.

Note

*The tester does not use the bi-directional average results in the calculation for the % **Tested** that shows on the home screen.*

Chapter 8: Use the Visual Fault Locator

Visual Fault Locator Applications

The CertiFiber Pro and OptiFiber Pro modules include a visual fault locator that sends a red light down the fiber. The red light shows at the end of the fiber and at breaks, cracks, and sharp bends along the fiber.

The VFL also helps you quickly verify the continuity of fibers, identify connectors, and find faults along fibers and in connectors.

The VFL helps you do these tasks:

- Quickly verify the continuity of fibers.
- Identify the polarity of duplex connections.
- Identify connections in patch panels.
- See breaks and bad splices. These faults cause the fiber to emit red light.
- See high-loss bends. If you can see the light from the VFL at a bend in a fiber, the bend is too sharp.
- See connectors that have damaged fibers inside. A damaged fiber inside a connector causes a red light in the connector.
- Increase the quality of mechanical splices and pre-polished connectors: Before you seal the splice or connector, adjust the fiber alignment for the minimum amount of light where the fibers touch. (Refer to the instructions from the manufacturer when you make splices and connectors.)

How to Use the VFL

Figure 81 shows the equipment for tests with the visual fault locator.

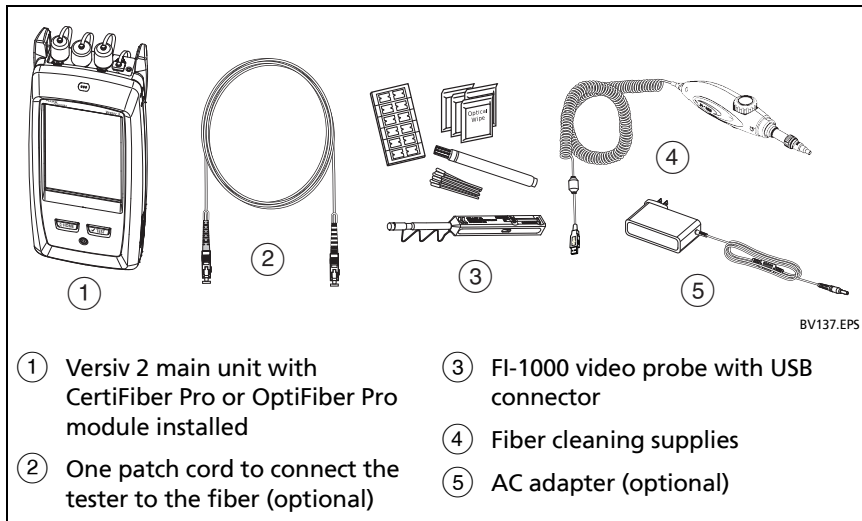

Figure 81. Equipment for Visual Fault Locator Tests

To use the visual fault locator

Note

You can connect the visual fault locator to connectors that have 2.5 mm ferrules (SC, ST, or FC). To connect to other ferrule sizes, use a test reference cord with the correct connector at one end and a SC, ST, or FC connector at the tester end.

- 1 Clean and inspect the connectors on the patch cord, if used, and the fiber to be tested.
- 2 Connect the fiber directly to the VFL port or use the patch cord to connect to the port.
- 3 Use the VFL button to turn on the visual fault locator (refer to Figure 82).

Or, on the home screen tap **TOOLS**, then tap **Visual Fault Locator (VFL)**. You can tap the **PULSE/OFF/CW** (continuous wave) button on the screen to change the modes of the VFL, or use the button as shown in Figure 82.

- 4 Look for the red light as shown in Figure 82.
- 5 To see the light that comes out of a connector, hold a white paper in front of the fiber connector.

Notes

The fiber connector at the VFL and the fiber near the connector can emit red light when there are no faults there because the light is strong at the VFL output.

The light from the VFL is possibly not visible through dark-colored fiber jackets.

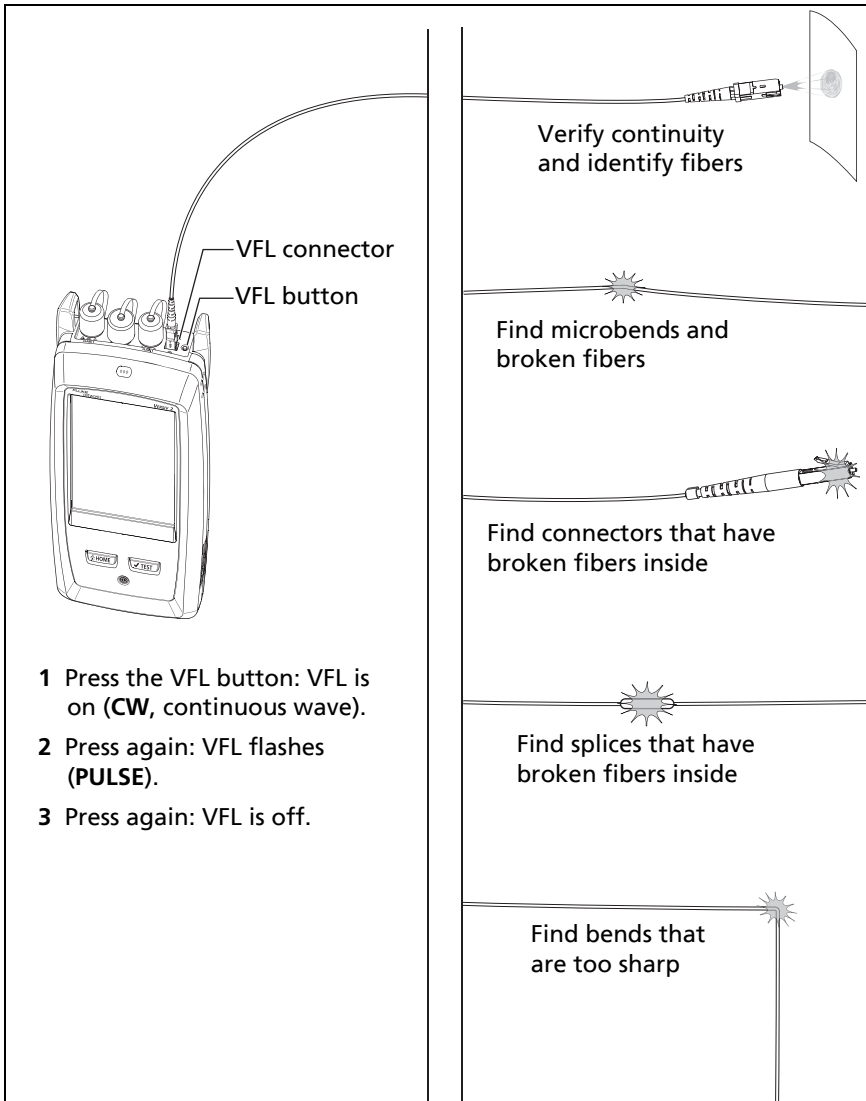

Figure 82. How to Use the Visual Fault Locator

Chapter 9: Monitor Optical Power

You can use the CertiFiber Pro main tester to monitor and save measurements of optical power and loss, and you can use the main or remote tester and as an optical power source. You can use the main tester's power or loss meter and its light source at the same time.

How to Monitor Power and Loss

The power meter lets you monitor the optical power supplied by a source such as an optical network interface card or optical test equipment. You can do these tasks:

- Monitor minimum and maximum power levels in **dBm** (decibels per milliwatt), **mW** (milliwatts), **µW** (microwatts), or **nW** (nanowatts).
- Monitor power loss compared to a reference level.
- **Auto CertiFiber Pro** and **Auto SimpliFiber Pro** modes let you monitor power and loss at two wavelengths when you use a CertiFiber™ Pro or SimpliFiber® Pro source.
- Save power and loss measurements for two wavelengths in one record.

Figure 83 shows the equipment for meter measurements.

Notes

*It is not necessary to select a **Fiber Type** or **Test Limit** when you monitor power or loss. These tests do not have **PASS/FAIL** results.*

Power and loss measurements from sources that transmit network data can change as the data rate changes.

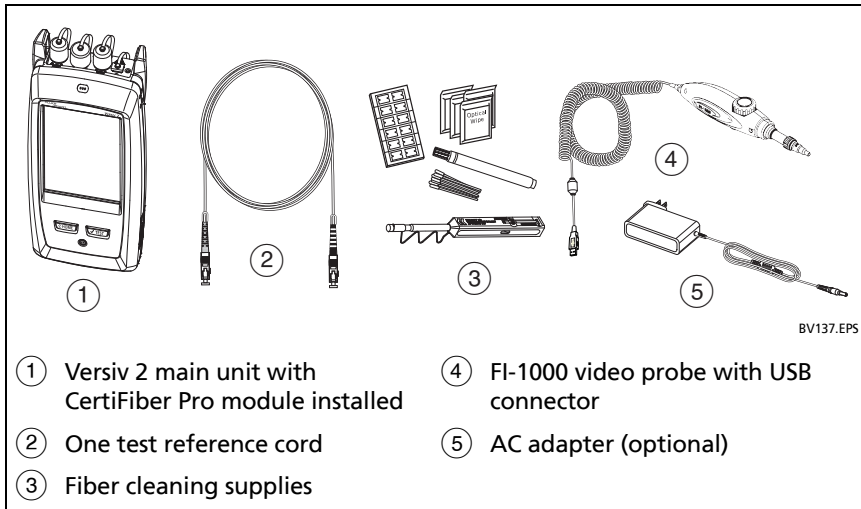

Figure 83. Equipment for Power Meter Measurements

To monitor power

- 1 Clean and inspect the tester's input port and the connectors on the source and test reference cord.
- 2 Connect the tester to the source, as shown in Figure 84.
- 3 Turn on the source. On a CertiFiber Pro module, hold down the button adjacent to the VFL port for 3 seconds.
- 4 On the home screen, tap **TOOLS**, then tap **Power Meter / Light Source**.
- 5 The default mode for the power meter is **Auto CertiFiber Pro**. If the source is not a CertiFiber Pro tester, tap λ to select the correct mode.

Figure 85 shows the power meter and its controls.

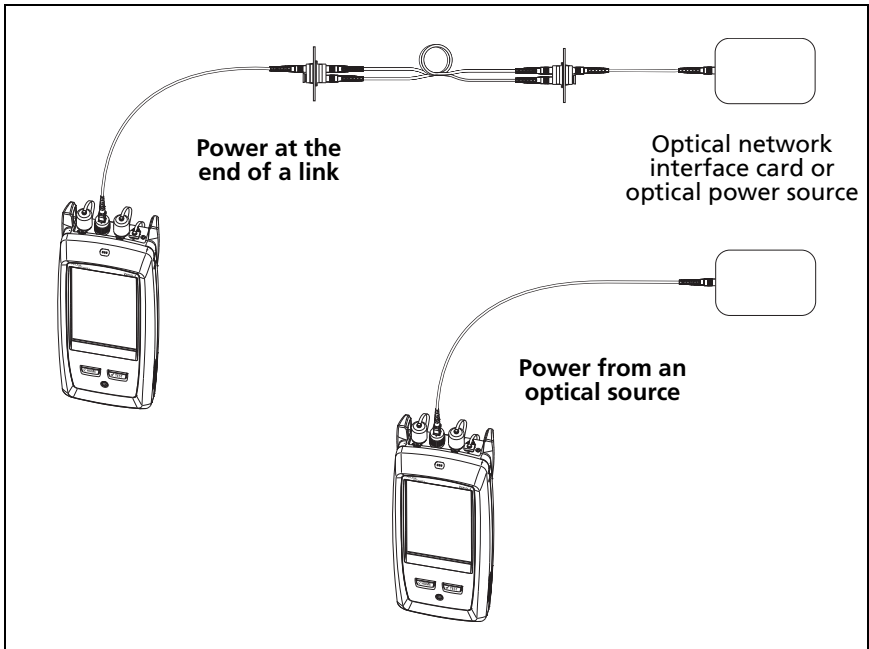

Figure 84. Connections to Monitor Power and Loss

BV138.EPS

To monitor loss

On the **POWER METER / LIGHT SOURCE** screen, tap **REF** to use the present power level as a reference. The meters show the difference between the reference power levels and the measured power levels.

To save the power and loss measurements

- 1 On the **POWER METER / LIGHT SOURCE** screen, tap **SAVE**.
- 2 On the **SAVE RESULT** screen, select **End 1** or **End 2**, make sure the **Cable ID** and **End** name are correct, then tap **SAVE**. Saved power meter results show these icons for **End 1** and **End 2**: **PM2** **PM1**

The tester saves the present, minimum, maximum, and reference power and loss measurements for both wavelengths in one record.

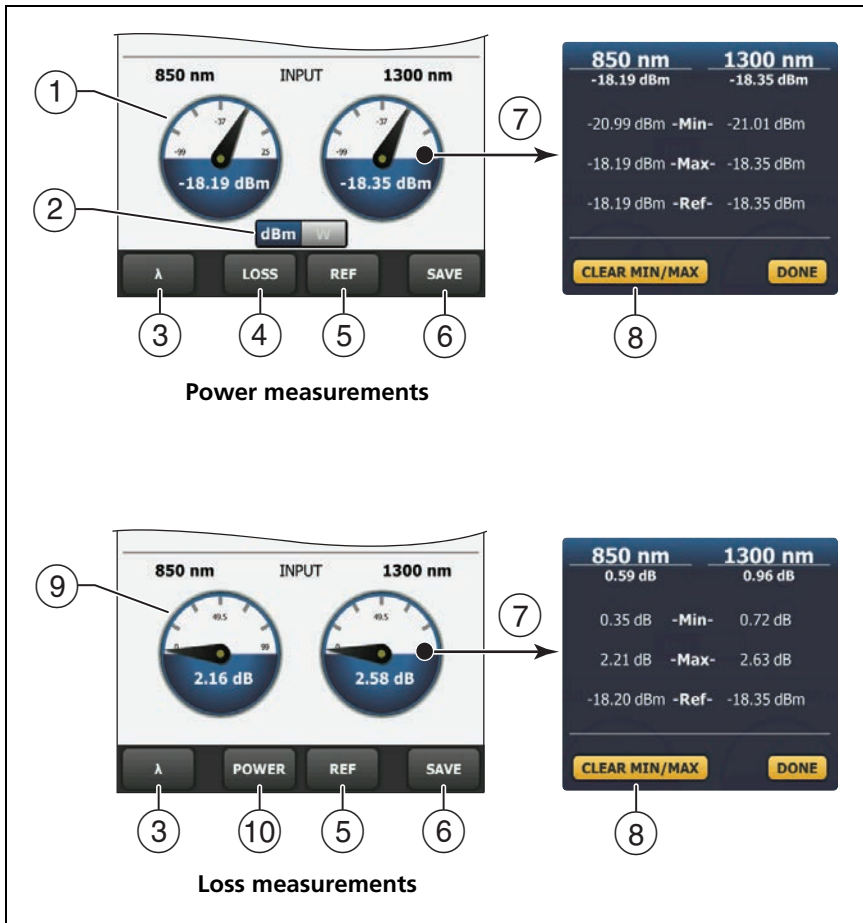

GPU126.EPS

Figure 85. Power Meter Measurements and Controls

- ① The meters show the power levels received on the input port.
- ② This control shows when the meters measure absolute power. Tap the control to see the power measurement in **dBm** (decibels per milliwatt), **mW** (milliwatts), **μW** (microwatts), or **nW** (nanowatts).

- ③ To select a wavelength for the power meter, tap λ .
Use the **Auto CertiFiber Pro** and **Auto SimpliFiber Pro** modes only with a CertiFiber Pro or SimpliFiber Pro source. In these modes, the tester reads the wavelength identifiers transmitted by the source to know when to measure power at each wavelength.
- ④ To monitor power loss (⑨), tap **LOSS** or **REF**.
- ⑤ When you tap **REF**, the tester saves the present measurements as reference levels and the meters show power loss (⑨).
- ⑥ To save the power and loss measurements, tap **SAVE**.
- ⑦ To see the present, minimum, maximum, and reference power or loss levels, tap a meter.
- ⑧ To set the minimum and maximum values to zero, tap **CLEAR MIN/MAX** in the **Min/Max/Ref** window.
- ⑨ When you tap **LOSS** or **REF**, the meters show power loss. The loss is the difference between the reference power levels and the measured power levels.
- ⑩ To monitor absolute power, tap **POWER**.

How to Control the Light Source

When you do tests in Far End Source mode, you use the button on the module to turn on the remote's light source manually. You can also turn on the main tester's light source manually and use the main tester as an optical source.

Use the Display to Control the Main Tester's Light Source

- 1 Clean and inspect all connectors you will use.
- 2 Connect the tester's output port to the power meter.
If your tester has a CertiFiber Pro Quad module installed, make sure you connect the fiber to the correct output port.
- 3 On the home screen tap **TOOLS**, tap **Power Meter / Light Source**, then select settings for the source. See Figure 86.

Use the Module's Button to Control the Light Source

The button next to the VFL port puts the output port in auto wavelength mode. In this mode, the port transmits both wavelengths (850 nm and 1300 nm or 1310 nm and 1550 nm). The signal includes identifiers that tell the meter when to measure power at each wavelength. Use this mode only with a CertiFiber Pro or SimpliFiber Pro power meter.

Note

The remote source always operates in auto wavelength mode.

- 1 Clean and inspect all connectors you will use.
- 2 Connect the tester's output port to the power meter.
If your tester has a CertiFiber Pro Quad module installed, make sure you connect the fiber to the correct output port.
- 3 Hold down the button adjacent to the VFL port for 3 seconds.
On CertiFiber Pro Quad modules, to turn on the singlemode source, press the button again.
On a main tester used as a source, you can use the **POWER METER / LIGHT SOURCE** screen to select different settings for the source. See Figure 86.

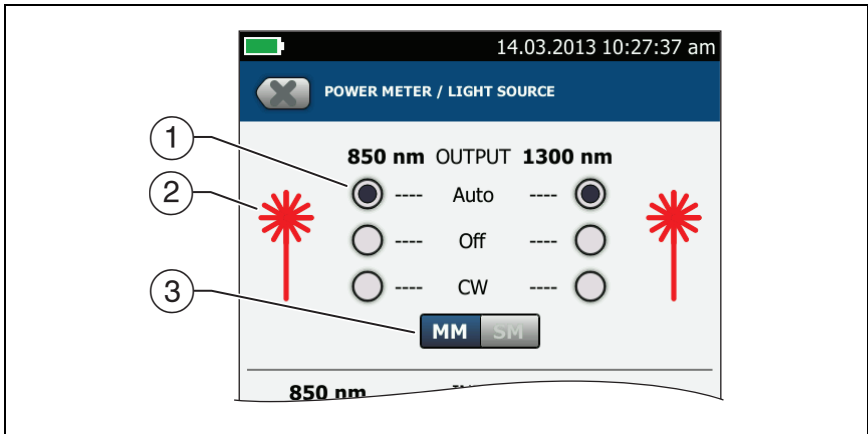

GPU127.EPS

Figure 86. Light Source Controls for the Main Tester

- ① Use the buttons to control the output port when you use the main tester as a light source:
 - **Auto:** In this mode, the output port transmits both wavelengths. The signal includes identifiers that tell a CertiFiber Pro or SimpliFiber Pro power meter when to measure power at each wavelength. Use this mode only with a CertiFiber Pro or SimpliFiber Pro power meter.
 - **Off:** The output port does not transmit the selected wavelength.
 - **CW:** The output port transmits a continuous signal at one wavelength. Use this mode if the power meter is not a CertiFiber Pro or SimpliFiber Pro meter.
- ② The laser icon is red when the output port transmits the wavelength adjacent to the icon.
- ③ When the tester has a CertiFiber Pro Quad module installed, use this control to select multimode or singlemode wavelengths

Chapter 10: Manage Test Results

View Saved Results

On the home screen, tap the **RESULTS** icon. The **RESULTS** screen shows the results in the active project. See Figure 87.

To view results saved on a USB flash drive, connect the drive, then tap **RESULTS, TRANSFER, USB Flash Drive, Import**. See “Manage Results on a Flash Drive” on page 218.

To organize results and make reports you can give to customers, use LinkWare PC software.

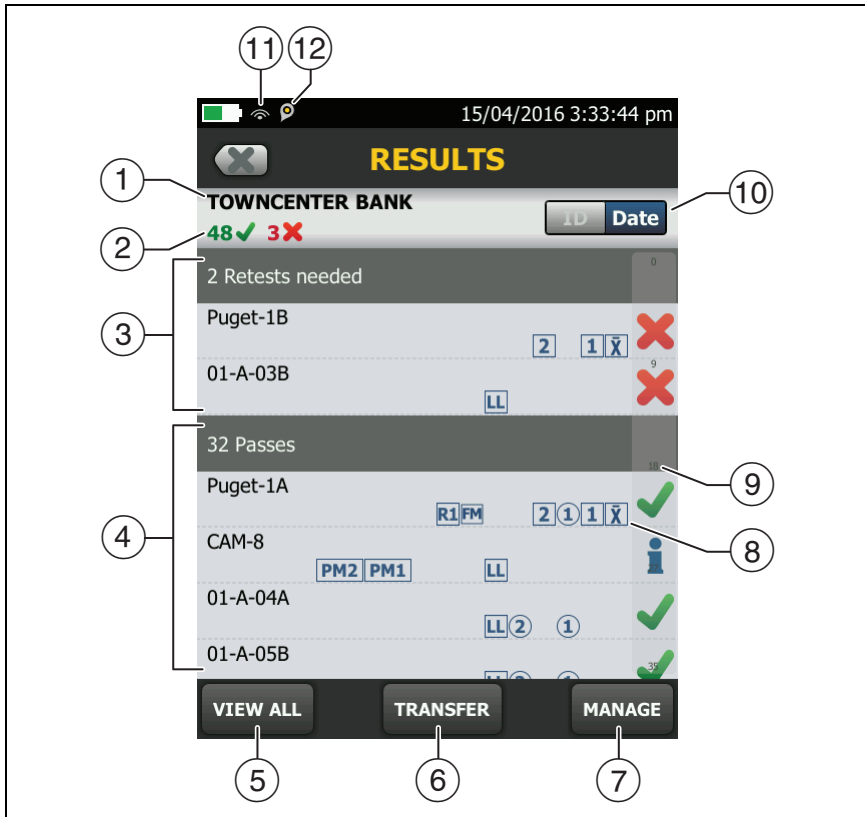

HEJ24.EPS



Figure 87. RESULTS Screen

- ① The name of the active project.
- ② : The number of results that passed. This includes individual results for each ID and tests that have an result.
- : The number of results that failed. This includes individual results for each ID.

: The number of DSX CableAnalyzer results that have **PASS*** results. **PASS*** results have measurements within the range of accuracy uncertainty for the tester. See “PASS*/FAIL* Results” on page 51.

Note

IDs can contain multiple results. So, these numbers can be more than the number of IDs saved.

- ③ The cable IDs that have **FAIL** results and must be tested again. Because some IDs can have one or more tests that failed, the number at the top of this screen (②) can be more than the number of retests needed.
- ④ The cable IDs that have an overall **PASS** or  result. Because some IDs can have one or more tests that passed or have an  status, the number at the top of this screen (②) can be more than the number of passes.

IDs that start with “TRC” are from verification tests on fiber test reference cords. These IDs show the date and time of the test.

- ⑤ Tap **VIEW ALL** to see a summary of the results in all the projects in the tester.
- ⑥ **TRANSFER** lets you export or import results to or from a flash drive and delete results on the flash drive.
- ⑦ **MANAGE** lets you move results to a different project, rename results, or delete results that are in the tester.
- ⑧ The icons show the types of fiber test results that the result contains:

No icon: DSX CableAnalyzer results from copper cabling.

 Loss/length results from a CertiFiber Pro OLTS module.

 OptiFiber Pro OTDR results from End 2 and End 1. The result can be from an **Auto**, **Manual**, **SmartLoop**, or **DataCenter OTDR** test.



 Averaged results from a bi-directional OTDR test.

 Power meter results from End 2 and End 1 from a CertiFiber Pro OLTS module.

 FiberInspector results from End 2 and End 1.

 FaultMap results from an OptiFiber Pro OTDR module.

 Real Time Trace results from End 2 and End 1 from an OptiFiber Pro OTDR module.

- ⑨ The scroll bar shows when the list of results is long. To use the scroll bar, tap on the bar or slide your fingertip on the bar. For example, to see the 12th result in the list, tap on “12” in the scroll bar. When you slide your fingertip on the bar, the number of the result you can see is next to your fingertip.
- ⑩ Tap the **ID/Date** control to sort the results by cable ID or by date. When you sort by ID, the results show in ascending order. When you sort by date, the latest result is at the top of the list.
- ⑪ These icons show when you connect the tester to a network to use Fluke Networks cloud services (see Chapter 12):
 -  The tester is connected to a wireless network.
 -  The tester is connected to a wired network.
- ⑫  The asset management icon shows when the owner of a LinkWare Live account has enabled the asset management service on the tester. See “About the Asset Management Service” on page 238.

How to Add a Result to a Saved Result

You can save the results from different tests in one cable ID. For example, you can save CertiFiber Pro results and FiberInspector results together in one ID.

When you add results, these settings used to get the results must agree with the settings in the saved result:

- Test limit
- Fiber categories (singlemode/multimode, core size, category)
- Index of refraction (makes a warning you can override)

If the settings do not agree, the tester shows a warning.

To add results for a different End setting

- 1 Do the test, then tap **SAVE**.
- 2 On the **SAVE RESULT** screen, select **End 1** or **End 2**, make sure the **Cable ID** and **End** name are correct, then tap **SAVE**.

To add results from a different test

- 1 On the home screen, tap the test setup panel.
- 2 On the **CHANGE TEST** screen, tap the button next to a test, then tap **USE SELECTED**.
 - If the ID set has a **Last ID**, the home screen shows the first ID in the set that does not have results for the test you selected.
 - If the ID set does not have a **Last ID**, tap the **Next ID** panel, tap the **Next ID** box on the **CHANGE ID** screen, enter the first ID for the set of saved results, then on the **CHANGE ID** screen, tap **DONE**.
- 3 Tap **TEST** or press **TEST**, then save the result.

How to Replace a Saved Result that Failed

To use the same test settings that were used for the saved result

- 1 On the home screen, tap the **RESULTS** icon.
- 2 On the **RESULTS** screen, tap a result that failed.
- 3 Tap **TEST AGAIN**.
- 4 When the test is completed, and if **Auto Save** is on, the tester asks you if you want to overwrite the results. Tap **Yes**.

If **Auto Save** is off, tap **FIX LATER** (if the test failed) or **SAVE** (if the test passed) to save the result.

To replace a result with a result that uses different test settings

- 1 Turn off **Auto Save**.
- 2 Make sure that the home screen shows the project that contains the result you want to replace.
- 3 Select the necessary test settings.
- 4 Do the test, tap **FIX LATER** (if the test failed) or **SAVE** (if the test passed), then enter the ID of the saved result.
- 5 The tester asks you if you want to overwrite the results. Tap **Yes**.

Delete, Rename, and Move Results

Before you delete, rename, or move results, select the project that contains the results and go to the **MANAGE RESULTS** screen:

- 1 On the home screen, tap the **RESULTS** icon. The **RESULTS** screen shows the results in the active project.
- 2 To see the results in another project, tap **VIEW ALL**, then tap a project.
- 3 Tap **MANAGE** to see the **MANAGE RESULTS** screen.

To delete results

- 1 On the **MANAGE RESULTS** screen, select the results you want to delete.
To select all the tests that failed or all the tests that passed, tap **Select All Retests** or **Select All Passes**.
- 2 Tap **DELETE**, then tap **DELETE** in the confirmation dialog.

To rename results

- 1 On the **MANAGE RESULTS** screen, select one result to rename.
- 2 Tap **RENAME**.
- 3 Enter a new name, then tap **DONE**.

To move results to a different project

- 1 On the **MANAGE RESULTS** screen, select the results you want to move.
- 2 Tap **MOVE**.
 - To move the results to a project shown in the list, tap the project name, then tap **MOVE** in the confirmation dialog.
 - To make a new project and move the results to the new project, tap **NEW PROJECT**, enter a project name, tap **DONE**, then tap **MOVE** in the confirmation dialog.

Note

When you move results to a different project, that project becomes the active project.

Manage Results on a Flash Drive

You can export or import results to or from a flash drive, and delete results on the flash drive.

To export or import project settings along with results, see “Manage Projects on a Flash Drive” on page 228.

Caution

- **Do not remove the USB flash drive while the LED on the drive flashes. Doing so can corrupt the data on the drive.**
- **You can lose a USB flash drive, cause damage to it, or accidentally erase the contents of the drive. Thus, Fluke Networks recommends that you save no more than one day of test results on a flash drive.**

Note

The tester reads only USB drives that use the FAT format.

- 1 Connect a USB flash drive to the type A USB port. The tester makes a bell sound when it detects the drive.
- 2 On the home screen, tap the **RESULTS** icon, then tap **TRANSFER**.
- 3 On the **TRANSFER RESULTS** screen, tap **USB Flash Drive**, then tap a function:
 - **Export:** On the **EXPORT RESULTS** screen, select **New** or **All**, select the project that contains the results you want to export to the flash drive, then tap **EXPORT**.

New: Export only results that do not have the same IDs as results that are already on the flash drive.

All: Export all the results from all projects in the tester.

Note

Cable IDs are case-sensitive. For example, the tester saves result with the names “A0” and “a0” in two different records.

- **Import:** On the **IMPORT RESULTS** screen select the project that contains the results you want to import from the flash drive, then tap **IMPORT**.
- **Delete:** On the **DELETE RESULTS** screen select the project that contains the results you want to delete on the flash drive, then tap **DELETE**.

Upload Results to a PC

Note

To upload results to the cloud for transfer to a PC, use the LinkWare Live web application. See Chapter 12.

To upload results to a PC from the tester or a flash drive, use LinkWare PC software.

- 1 Install the latest version of LinkWare PC software on the PC.
- 2 Turn on the tester and start LinkWare PC on the PC.
- 3 Use the USB cable supplied to connect the Micro-AB USB port on the tester to a type A USB port on the PC. See Figure 88.
Or connect a USB flash drive to the PC.
- 4 On the LinkWare PC toolbar, click , then select a product, or select **Test Files (.tst)** to upload from a flash drive.
- 5 In the **Import** dialog box in LinkWare PC, select options for the location and the number of results to import.

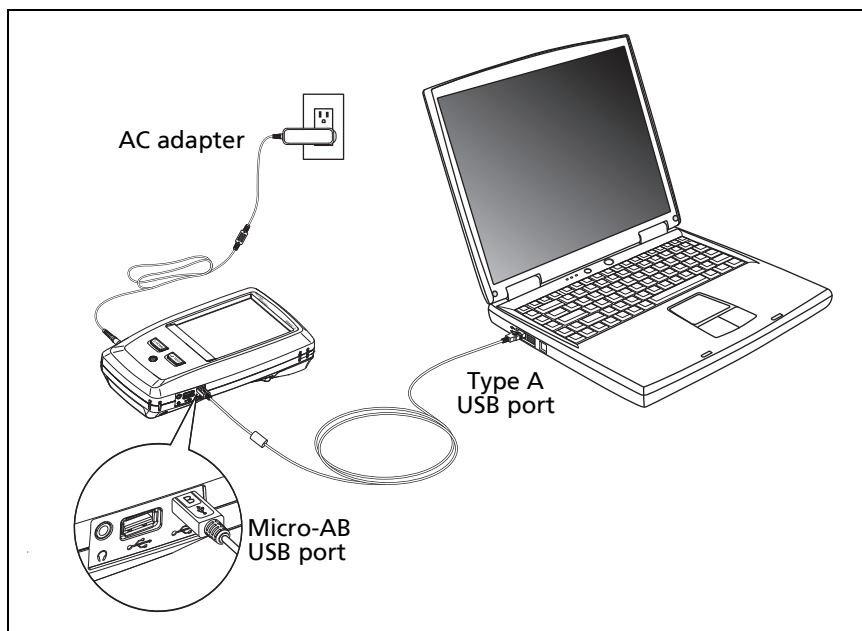

Figure 88. How to Connect the Tester to a PC

BV46.EPS

View the Memory Status

To see the memory status

On the home screen, tap the **TOOLS** icon, then tap **Memory Status**.

The **MEMORY STATUS** screen shows these values:

- The percentage of memory available
- The number of test records that are saved
- The number of .id files that have been downloaded to the tester from LinkWare PC software
- The memory space taken by other files, such as the databases for projects and test limits

Chapter 11: Use Projects

Why Use Projects?

The tester's ProjX™ management system lets you set up projects that help you monitor the status of a job and make sure that your work agrees with the requirements of the job.

You can use a project to do these tasks:

- Specify the tests that are necessary for a job.
- Specify settings for tests.
- Specify an operator for the job.
- Make sets of sequential IDs to use as names for test results.
- Automatically save test results with IDs from a set.
- Add the results from other necessary tests to each saved result in the project.
- See which IDs do not have results for a specified test.
- See what percentage of a job is completed.
- See how many links passed and how many failed.
- Keep the test results from a job in one place for easy access.

When you use a project, you can do tests and use IDs that are not specified in the project if necessary. You can also easily change the settings in a project if necessary.

Notes

It is not necessary to install a module to set up a project for the module. The tester keeps all settings in the main Versiv 2 unit.

To manage projects in the cloud, use the LinkWare Live web application. See Chapter 12.

Set Up a Project

Refer to the **PROJECT** screen in Figure 89 on page 223.

- 1 On the home screen, tap the **PROJECT** panel, tap **CHANGE PROJECT**, then tap **NEW PROJECT**.
- 2 On the **NEW PROJECT** screen, enter a name for the project, then tap **DONE**.
- 3 On the **PROJECT** screen, tap the **Operator** panel to enter an operator name for the project.
- 4 On the **PROJECT** screen, tap the **NEW TEST** button to enter the tests and test settings necessary for the project.
- 5 On the **PROJECT** screen, tap the **NEW ID SET** button to make one or more sets of cable IDs for the project. See the **CABLE ID SETUP** screen in Figure 90 on page 226.
- 6 On the **PROJECT** screen, tap **DONE**.

The PROJECT Screen

To start a new project, tap the **PROJECT** panel on the screen. Figure 89 shows the **PROJECT** screen and describes the items you enter to make a project.

- ① The name of the project. See also item ⑨.
- ② **Operator**: The name of the person who will do the tests for the project. For each operator you can also enter the email address that the operator will use as an ID to sign in to LinkWare Live.
- ③ The date range for the results in the project.
- ④ **Results**: A summary of the test results in the project:

: The number of tests that failed.

: The number of tests that passed.





GPU08.EPS

Figure 89. PROJECT Screen

: The number of DSX CableAnalyzer results that have **PASS*** results. **PASS*** results have measurements within the range of accuracy uncertainty for the tester. See “PASS*/FAIL* Results” on page 51.

- ⑤ **Test Setup:** The tests that are available in the project.
To add a test to the project, tap **NEW TEST**.
- ⑥ **Cable ID Sets:** The sets of IDs the tester can use for the names of test results. Each ID set is for either copper or fiber cable.
To add a set of IDs to the project, tap **NEW ID SET**. See Figure 90.

- ⑦ To use a different project, tap **CHANGE PROJECT**, then tap a project.
To make a new project, tap **CHANGE PROJECT**, then tap **NEW PROJECT**.
- ⑧ **TRANSFER** lets you export or import projects to or from a flash drive and delete projects on the flash drive. The project data includes all project settings and test results.
- ⑨ **MANAGE** lets you rename, copy, or delete a project that is in the tester.
- ⑩ To delete the test setup or ID set, tap . To copy the test setup or ID set so you can edit it to make a new one, tap .

Notes

If you delete an imported ID set from a project, the ID set is still available in the tester. To delete imported ID sets from the tester, use LinkWare PC software.

*A project must have at least one **Test Setup** and one **Cable ID** set. If you delete them all, the tester makes a default **Test Setup** and **Cable ID** set.*

The CABLE ID SETUP Screen

To see the **CABLE ID SETUP** screen, tap the **PROJECT** panel on the home screen, then tap **NEW ID SET** on the **PROJECT** screen. See Figure 90 on page 226.

Each project can have up to 5000 IDs. If an ID set does not have a **Last ID**, the tester counts the set as one ID. An ID can have a maximum of 60 characters. Symbols, such as the asterisk, and accented characters do not increment.

About Next ID Sets

If you do not enter a **Last ID** when you make an ID set, the tester uses the **First ID** as the **Next ID**. The tester increments the Next ID each time you save a result.

- Numbers increment sequentially:
1, 2, 3, 4, 5, 6, 7, 8, 9, 10, 11, 12, ... 99, 100, 101...
- Letters increment through the English alphabet:
A, B, C, D, ... Z, AA, AB, AC, AD, ... AZ, BA, BB, BC...
- Numbers and letters do not cause each other to increment:
1Y, 1Z, 1AA, 1AB, ... 1ZZ, 1AAA, 1AAB...
- The tester does not increment symbols or accented characters.

When you use a **Next ID** set, the set under **IDs Untested** on the **CHANGE ID** screen shows only the next ID. To save the next test with a different ID, tap the **Next ID:** panel, then enter a different ID.

Each project can have one **Next ID** set. You can use the **Next ID** set for copper or fiber results.

If your project has only a **Next ID** set, the tester cannot calculate the percentage of the project that is completed, so the **% Tested** value does not show on the home screen.

If your project has both a **Next ID** set and sets with first and last IDs, the **% Tested** value includes tests you saved with **Next ID**. For example, if you have one **Next ID** set and one set with 10 IDs, and you save 10 results with next IDs, the **% Tested** shows 50% (10 saved results divided by 20 IDs).

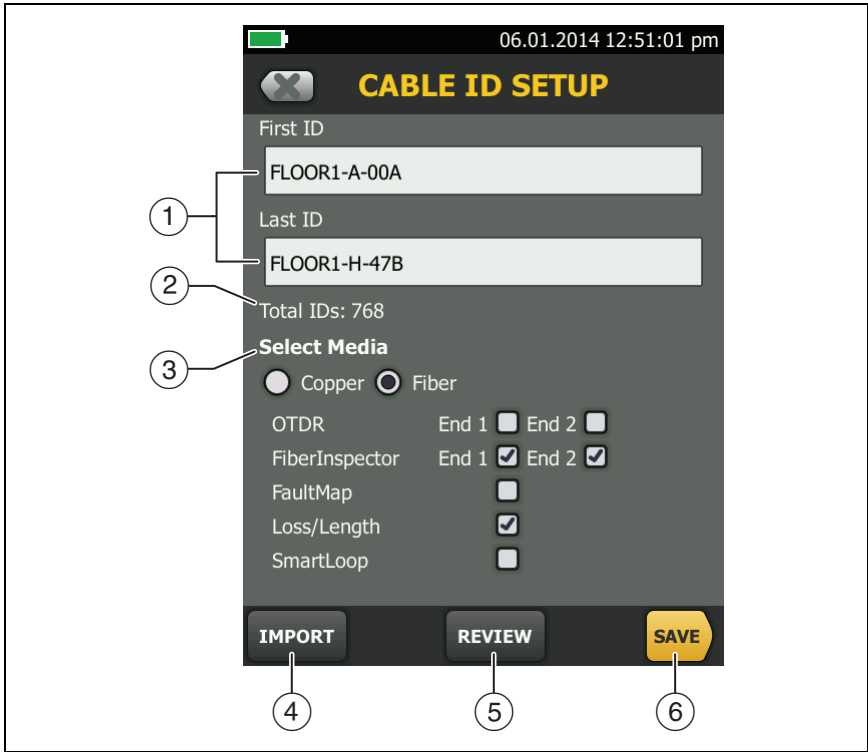

GPU09.EPS

**Figure 90. CABLE ID SETUP Screen
(after you enter the first and last IDs)**

- ① **First ID and Last ID:** The first and last IDs in a set of sequential IDs. If you do not enter a **Last ID** when you make an ID set, the tester will increment the **First ID** to make subsequent IDs.

Note

The tester does not increment symbols or accented characters.

When you use an ID set that does not have a **Last ID**, the set under **IDs Untested** on the **CHANGE ID** screen shows only the next ID.

- ② **Total IDs:** The number of IDs in the set. This section does not show for ID sets that do not have a **Last ID**.
- ③ **Select Media:** Select **Copper** to use the ID set for test results from copper cable.

Select **Fiber** and one or more fiber tests to use the ID set for test results from fiber cable.

For example, you can specify that you must do a **Loss Length** and a **FiberInspector** test for each ID. After you do both tests for all the IDs in the set, the tester shows **100% Tested** on the home screen. If no IDs include FiberInspector results, the tester shows **50%**. To see the IDs that need FiberInspector results, select a **FiberInspector** test in the project, then look at the list under **FiberInspector IDs Untested** on the **CHANGE ID** screen

Notes

*You can use an ID set only for results from the media type you selected under **Select Media**.*

*The **Select Media** section does not show for ID sets that do not have a **Last ID**. You can use these ID sets for copper or fiber results.*

- ④ Tap **IMPORT** to use an ID set that you downloaded to the tester from LinkWare PC software.
- ⑤ Tap **REVIEW** to see the **CABLE ID REVIEW** screen, which shows the ID set and the total number of IDs.

Note

*The **REVIEW** button does not show if you do not enter a **Last ID**.*

- ⑥ **SAVE:** To save the ID set, tap **SAVE**.

Manage Projects on a Flash Drive

You can export or import projects to or from a flash drive, and delete projects on the flash drive. The project data includes all project settings, test results, and ID sets.

Caution

- **Do not remove the USB flash drive while the LED on the drive flashes. Doing so can corrupt the data on the drive.**
- **You can lose a USB flash drive, cause damage to it, or accidentally erase the contents of the drive. Thus, Fluke Networks recommends that you save no more than one day of test results on a flash drive.**

Note

The tester reads only USB drives that use the FAT format.

- 1 Connect a USB flash drive to the type A USB port. The tester makes a bell sound when it detects the drive.
- 2 On the home screen, tap the **PROJECT** panel.
- 3 On the **PROJECT** screen, tap **TRANSFER**.
- 4 On the **TRANSFER PROJECTS** screen, select a function:
 - **Export:** On the **EXPORT PROJECTS** screen, select the projects you want to export to the flash drive, then tap **EXPORT**.
 - **Import:** On the **IMPORT PROJECTS** screen select the projects you want to import from the flash drive, then tap **IMPORT**.
 - **Delete:** On the **DELETE PROJECTS** screen select the projects you want to delete on the flash drive, then tap **DELETE**.

Copy Project Settings to Other Testers

To copy the settings in a project to other Versiv testers, use the **Read Project Setups** and **Write Project Setups** utilities in LinkWare PC software. You can use LinkWare PC to read project settings from a tester or from a project you exported to a flash drive.

Chapter 12: Sync Projects with LinkWare™ Live

The LinkWare Live web application lets you manage your projects from a desktop or mobile device.

Sign Up for a LinkWare Live Account

- 1 Go to www.linkwarelive.com/signin.
- 2 If you already have a LinkWare Live account, enter your email address and password on the LinkWare Live **Sign In** page.
- 3 If you do not have a LinkWare Live account, click **New user? Sign up now!**. Enter the information for your account, then click **CREATE ACCOUNT**.
Fluke Networks sends you an email with a LinkWare Live activation code.
- 4 Open the email, copy the activation code, click the LinkWare Live activation link in the email, paste the activation code into the box in the activation window, then click **ACTIVATE**.
- 5 The LinkWare Live **Sign In** page shows again. Enter your email address and password, then click **SIGN IN**.

How to See the Tester's MAC Address

Some networks require users to register their device's MAC address before they can connect to the network.

There are two MAC addresses: one for the wired port and one for the Wi-Fi adapter.

To see the tester's or Wi-Fi adapter's MAC address

- 1 On the home screen tap **TOOLS**, then tap **Network**.
- 2 On the **NETWORK** screen, tap the **Wired** or **Wi-Fi** panel. The MAC addresses shows at the top of the **WIRED** and **WI-FI PORT** screens.

Use LinkWare Live Through a Wired Ethernet Network

- 1 Use an appropriate cable to connect the tester's RJ45 Ethernet port to an active network port. If the cable is good and the port is active, the LEDs on the tester's port will come on.
- 2 On the home screen, make sure the **Operator** name is correct. The tester uses the email address associated with the operator name as the ID when you sign in to LinkWare Live.

If no address is associated with the name, or if you enter a different address on the **LWL SIGN IN** screen, the tester associates the name with the address you enter.

- 3 On the home screen, tap the **SYNC** icon.
- 4 When the tester connects to the network, the wired network connection icon shows at the top of the screen: 
- 5 On the **LWL SIGN IN** screen, if necessary, enter the ID and password for your LinkWare Live account, then tap **SIGN IN**.
- 6 If you use other people's LinkWare Live accounts, the **ORGANIZATION** screen shows. Tap the organization you want to use.

- 7 On the **SYNC PROJECTS** screen (Figure 91 on page 235), select the projects you want to sync, then tap **SYNC**.

Use LinkWare Live Through a Wi-Fi Ethernet Network

The tester can use wireless network channels 1 through 11.

- 1 On the home screen, make sure the **Operator** name is correct. The tester uses the email address associated with the operator name as the ID when you sign in to LinkWare Live.

If no address is associated with the name, or if you enter a different address on the **LWL SIGN IN** screen, the tester associates the name with the address you enter.

- 2 On the home screen, tap the **SYNC** icon.
- 3 Select a wireless network if necessary.

If the network settings are not correct, the tester shows the **NETWORK** screen and a message about the necessary settings.

- a. To change the settings, tap the **Wi-Fi** panel.
- b. To test the settings, go back to the **WI-FI PORT** screen, then tap **CONNECT**.

When the tester connects to the network, the Wi-Fi network connection icon shows at the top of the screen:



- c. Go back to the **TRANSFER RESULTS** screen, then tap the **LinkWare Live** panel.
- 4 On the **LWL SIGN IN** screen, if necessary, enter the ID and password for your LinkWare Live account, then tap **SIGN IN**.
 - 5 Enter a user name and password for the network, if necessary.

-continued-

- 6 If you use other people's LinkWare Live accounts, the **ORGANIZATION** screen shows. Tap the organization you want to use.
- 7 On the **SYNC PROJECTS** screen (Figure 91), select the projects you want to sync, then tap **SYNC**.

See Figure 91:

- ① Projects in the **On this tester** section are possibly also in LinkWare Live. You can upload results from these projects to LinkWare Live.

If the project in LinkWare Live has test settings or cable IDs that are different from those in the tester, you can download the new settings to the tester.

By default, the active project is selected to sync.

- ② Projects in the **Available only on LinkWare Live** section have project settings you can download to the tester.

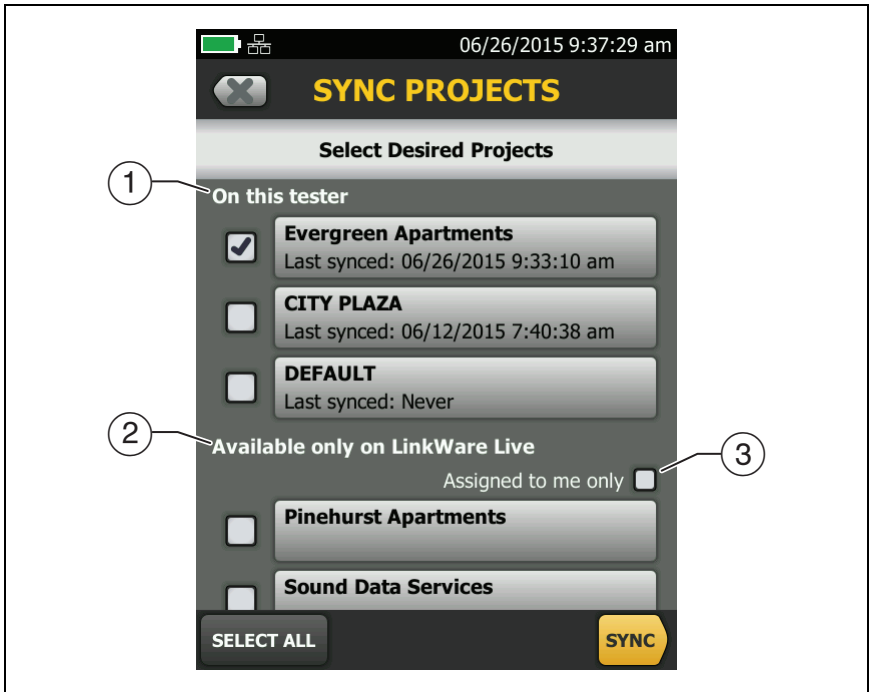

GPU190.EPS

Figure 91. SYNC PROJECTS Screen

If you download these projects, only test settings and cable IDs are downloaded. Any test results saved in the project in LinkWare Live are not downloaded.

- ③ If you select **Assigned to me only**, you will see only projects that are assigned to you in the project settings in LinkWare Live.

Change the Network Settings

It is not usually necessary to change the wired or Wi-Fi network settings before you try to make a connection. But for example if you must use static addressing, you can get to the settings on the **NETWORK** screen.

To get to the network settings

On the home screen, tap **TOOLS**, then tap **Network**, then tap the **Wired** or **Wi-Fi** panel.

To test the settings

Tap **CONNECT** on the **WI-FI PORT** or **WIRED PORT** screen.

Settings for the Wired Port

The tester can use **DHCP** (dynamic host configuration protocol) or **Static** for the address method. Most networks use **DHCP**.

For **Static**, enter an IP address for the tester and the **Subnet Mask**, **Gateway** address, and **DNS1** and **DNS2** addresses for the network. If you are not sure what to enter, speak to the network administrator.

Settings for Wi-Fi

Table 8 shows the Wi-Fi settings.

Table 8. Settings for the Wi-Fi Connection

Setting	Description
Address	Most networks use DHCP.
DHCP address settings	<p>SSID: The tester does a scan for wireless networks and shows a list of available networks. Select the correct SSID.</p> <p>To connect to a hidden network, tap ADD SSID.</p> <p>Security:</p> <ul style="list-style-type: none"> • Authentication: Select the authentication type that the network uses: <ul style="list-style-type: none"> ♦ Open: Security credentials are not necessary. ♦ WEP: Select an encryption method and enter the necessary keys. ♦ WPA/WPA2 Personal: Enter the password for the network. • WPA/WPA2 Enterprise: <ul style="list-style-type: none"> ♦ EAP: Select an EAP type that is appropriate for the authentication server. ♦ User and Password: Enter a user name (login name) and password for the network. ♦ Alternate ID: The tester can use the Alternate ID with some EAP methods to send an empty or anonymous identity while the tester makes a private connection. The tester then uses the private connection to send the User name and Password you entered. <p>The tester can also use the Alternate ID to send the User name and Password to an authentication server in a different realm. In this situation, the Alternate ID can have a format such as anonymous@MyCompany.com or / MyCompany/anonymous.</p>
Static address settings	<p>Enter an IP address for the tester and the Subnet Mask, Gateway address, and DNS1 and DNS2 addresses for the network. If you are not sure what to enter, speak to the network administrator.</p> <p>The Security settings are the same as for the DHCP address settings.</p>

Delete Wi-Fi Settings and Passwords

The tester saves the security settings and passwords for the Wi-Fi connections you use.

To delete all Wi-Fi settings and passwords

On the home screen, tap **TOOLS**, then tap **Network**, tap the **Wi-Fi** panel, then tap **FORGET ALL**.

About the Asset Management Service

LinkWare Live's asset management service lets you see the locations of your Versiv testers in the field. The owner of the LinkWare Live account can enable or disable the service remotely for each Versiv tester.

When this service is enabled on a Versiv tester, the asset management icon () shows on the tester's home screen. When a technician uses the tester to sign in to LinkWare Live, the tester's location shows on a map on LinkWare Live's **ASSETS** page.

Note

You can enable or disable the asset management service only with LinkWare Live. There is no setting on the Versiv tester that enables or disables this service.

Sign Your Tester Out of LinkWare Live

- 1 On the home screen, tap the **TOOLS** icon, then tap **Sign In**.
- 2 On the **LWL SIGN IN** screen, tap **SIGN OUT**.

Or, turn off the tester.

Sign In to LinkWare Live from a Desktop or Mobile Device

- 1 Go to <https://www.linkwarelive.com/signin>.
- 2 Enter your LinkWare Live user name and password, then click **SIGN IN**.

For more information about how to use LinkWare Live, click **HELP** on the LinkWare Live web page.

Import Projects from LinkWare Live into LinkWare PC

- 1 Install the latest version of LinkWare PC software on the PC.
- 2 Turn on the tester and start LinkWare PC on the PC.
- 3 Use the USB cable supplied to connect the Micro-AB USB port on the tester to a type A USB port on the PC.
- 4 On the LinkWare PC toolbar, click .
- 5 Sign in to your LinkWare Live account, then use the LinkWare PC dialog boxes to select and import projects.

Learn More About LinkWare Live

Go to <http://www.flukenetworks.com/linkwarelive>.

Chapter 13: Maintenance

Warning

To prevent possible fire, electric shock, personal injury, or damage to the tester:

- Do not open the case. You cannot repair or replace parts in the case.
- Use only replacement parts that are approved by Fluke Networks.
- If you replace parts that are not specified as replacement parts, the warranty will not apply to the product and you can make the product dangerous to use.
- Use only service centers that are approved by Fluke Networks.

Caution

If you replace electrical parts yourself, the tester will possibly not have the correct calibration and can give incorrect test results. If the calibration is not correct, cable manufacturers can remove their warranty from the cabling you install.

Verify Operation

The tester does a self test when you turn it on. If the tester shows an error or does not turn on, refer to “If the Tester Does Not Operate as Usual” on page 250.

Clean the Tester

To clean the touchscreen, turn off the tester, then use a soft, lint-free cloth that is moist with water or water and a mild detergent.

To clean the case, use a soft cloth that is moist with water or water and a mild detergent.



Do not put the tester or the battery pack in water.



To prevent damage to the touchscreen or the case, do not use solvents or abrasive materials.

When you clean the touchscreen or the case, do not let liquid get under the plastic around the touchscreen.

To clean the optical connectors on a fiber module, see the instructions in Chapter 4.

Clean the FI-1000 Video Probe

To clean the case, use a soft cloth that is moist with a mild detergent.



To prevent damage to the case, do not use solvents or abrasive materials.

To clean the lens, remove the adapter tip, then wipe the lens with an optical-grade cloth that is moist with an optical-grade cleaning solution.

See Information About the Tester

To see information about your tester and attached modules and adapters

On the home screen, tap the **TOOLS** icon, then tap **Version Information**.

To see information about your remote tester

Use DSX or CertiFiber Pro modules and patch cords to connect the main and remote testers together (see Figure 2 on page 14), then tap **REMOTE** on the **Version Information** screen.

Traceable Calibration Period

To make sure that the modules operate within the published specifications for accuracy, have them calibrated at a Fluke Networks authorized service center every 12 months. To get information on factory calibration, contact an authorized Fluke Networks Service Center.

To see when the tester last received a factory calibration, tap the **TOOLS** icon on the home screen, then tap **Version Information**.

Update the Software

New software gives you access to new features and the latest test limits and cable types. Software updates are available on the Fluke Networks website.

You can use a PC to install a software update, or connect an updated main unit to a remote or to another main unit to update those units.

You can also use LinkWare Live to download a software update from the cloud to your main tester, then use the main tester and a USB cable to install the update in the remote.

Use a PC to Update the Software

Caution

To prevent unexpected loss of power, connect the ac adapter to the tester when you update the software.

Note

The software update procedure does not delete the test records, project settings, or user preferences in the tester, but can possibly change the factory-installed cable types or test limits.

- 1 Install the latest version of LinkWare PC software on your PC. LinkWare PC is available on the Fluke Networks website.
- 2 Connect the AC adapter to the tester and connect the Micro-AB USB port on the tester to a type A USB port on the PC. See Figure 92.
- 3 LinkWare PC automatically tells you if new software for the tester is available on the Fluke Networks website, and lets you install the software.

Note

Older versions of LinkWare PC do not start the update procedure automatically. For older versions, you must have the Versiv update file on a disk or USB drive and click  to start the update procedure.

- 4 The tester reboots when the update is completed. To make sure the update was installed correctly, tap the **TOOLS** icon on the home screen, tap **Version Information**, then make sure the correct version shows.
- 5 Do steps 2 through 4 again for the remote. On a remote tester, the LEDs show the progress of the installation.

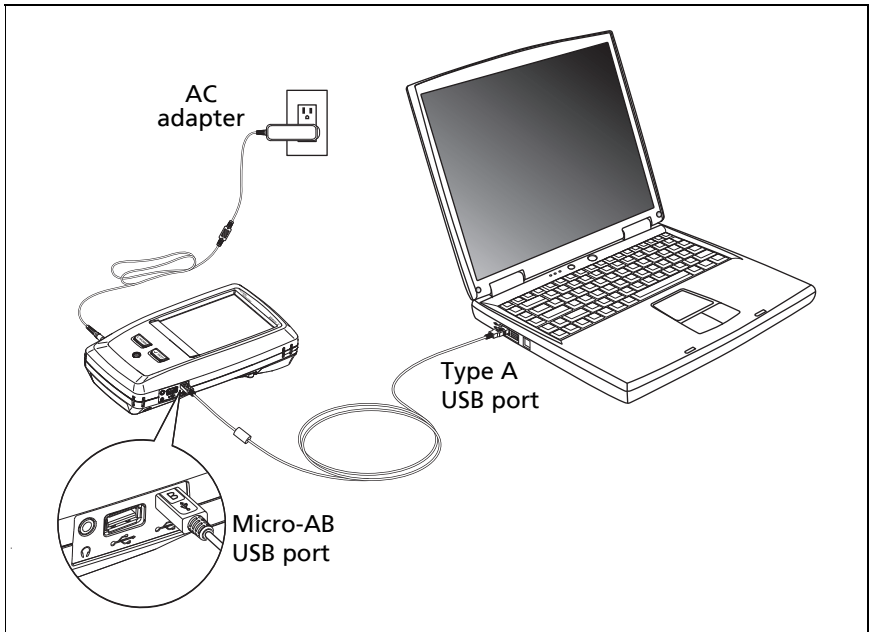

BV46.EPS

Figure 92. How to Connect the Tester to a PC

Use an Updated Main Tester to Update Other Testers

- 1 Turn on both testers and connect the AC adapters to both testers.
- 2 Use the USB cable provided to connect the updated main unit to the remote or to another main. See Figure 93.
- 3 Follow the instructions shown on the display of the updated main unit.

Note

If a remote has newer software than the main unit, the main unit can install the older software in the remote so that you can use the two units together. The remote cannot install the newer software in the main unit.

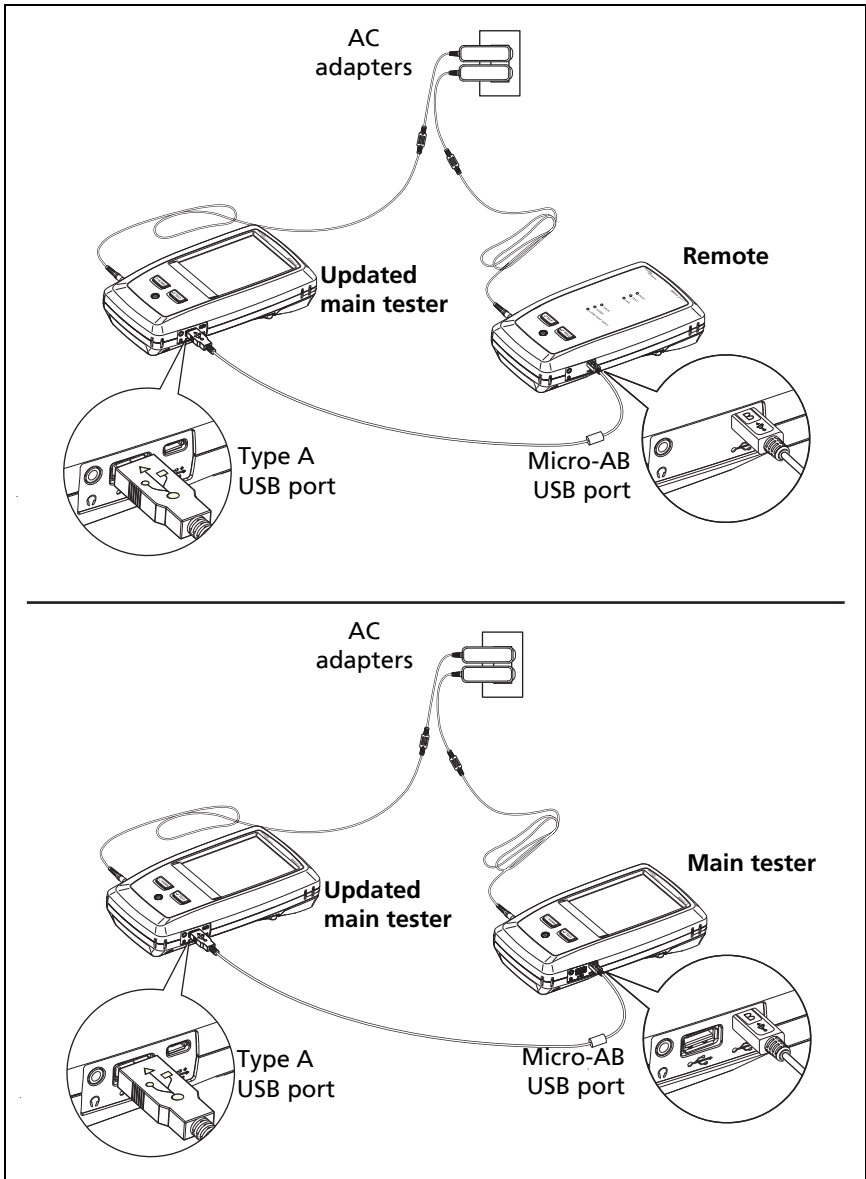

BV116.EPS

Figure 93. How to Connect Units Together to Update the Software

Use LinkWare Live to Update the Software

- 1 For a wired internet connection: Use an appropriate cable to connect the tester's RJ45 Ethernet port to a network port.
- 2 On the home screen, tap the **SYNC** icon.
- 3 For a wireless network, if the network selection screen shows, connect to a network:
 - a. Select a network.
 - b. Enter security information.
 - c. Go back to the previous screen, then tap **CONNECT**.
 - d. Go back to the home screen, then tap **SYNC**.
- 4 On the **LWL SIGN IN** screen, enter the ID and password for your LinkWare Live account, then tap **SIGN IN**.
- 5 If a Versiv software update is available, the tester shows a message. Tap **YES** to install new software in your tester.
- 6 The tester reboots when the update is completed.
- 7 To install the update in a remote or another main tester, use the USB cable provided to connect the updated main tester to the other tester. See Figure 93.
- 8 Follow the instructions shown on the display of the updated main tester.

Update the Software in a Module

To update the software in a module, attach it to a main or remote Versiv unit that has the latest software. The tester automatically installs the software in the module.

Extend the Life of the Battery



To prevent possible fire, electric shock, or personal injury, read the warnings about the rechargeable battery under “Warning ” on page 5.

- Do not frequently let the battery discharge completely.
- Do not keep the battery at temperatures below -20 °C (-4 °F) or above +50 °C (+122 °F) for periods longer than one week.
- Before you put a battery into storage, charge it to approximately 50 % of full charge.

Store the Tester

- Before you store a tester or an extra battery for a long period, charge the battery to approximately 50 % of full charge. The discharge rate of the battery is 5 % to 10 % each month. Check the battery every 4 months and charge it if necessary.
- Keep a battery attached to the tester during storage. If you remove the battery for more than approximately 24 hours, the tester will not keep the correct time and date.
- Storage temperature: -22 °F to +140 °F (-30 °C to +60 °C)

Remove the Battery

Figure 94 shows how to remove the battery.

Notes

If you remove the battery and do not connect the AC adapter, the clock keeps the current date and time for a minimum of 24 hours.

The screw does not come out of the battery door.

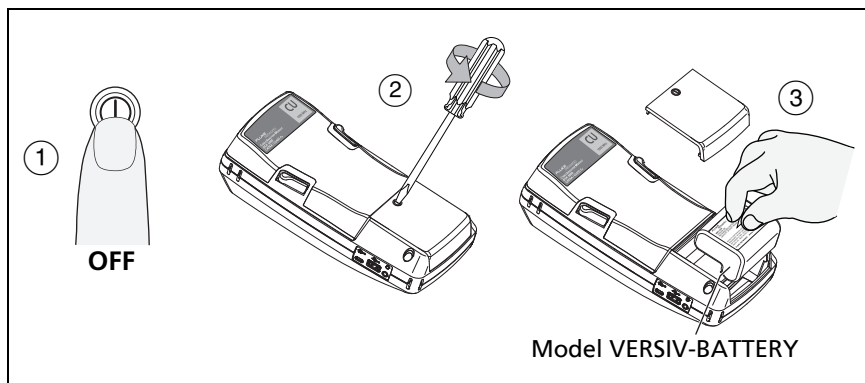

Figure 94. How to Remove the Battery

GPU21.EPS

If the Tester Does Not Operate as Usual

If the tester does not operate as usual or if it shows an unusual message, see Table 9 for possible explanations and solutions to some conditions that can occur.

If the condition continues, contact Fluke Networks for assistance, or search the Fluke Networks Knowledge Base for a solution.

If you contact Fluke Networks, have available the serial number, software and hardware versions, and calibration date for the tester, if possible. To see this information, tap the **TOOLS** icon on the home screen, then tap **Version Information**.

You can also use LinkWare PC software to upload the system log from the tester. This file contains information that can possibly help Fluke Networks find a solution to an unusual problem.

Table 9. Possible Solutions for Unusual Behavior

<p>The touchscreen or the keys do not respond.</p> <p>Press and hold  until the tester turns off. Then turn on the tester. If the problem continues, install the latest version of software in the tester.</p>
<p>The tester will not turn on even though the battery is charged.</p> <p>The safety switch or the fuse in the battery is possibly open. Wait a few seconds, then try again. If the tester does not turn on, the battery is possibly bad and must be replaced. The tester can operate on AC power if the battery does not operate.</p>
<p>Test results appear to be incorrect.</p> <p>The tester possibly has incorrect settings. Make sure you selected the correct cable type and test limit.</p>

Options and Accessories

For a complete list of options and accessories go to the Fluke Networks website at www.flukenetworks.com.

To order options and accessories, contact an authorized Fluke Networks distributor.

Appendix A: Reference Method Names

Industry standards use different names for the three reference methods. Tables A-1 and A-2 show the names used in this manual and by four common standards.

Table A-1. Reference Method Names fore TIA/EIA Standards

Link End Connections Included in Loss Results	Method Name in This Manual	TIA-526-14B (multimode)	TIA/EIA-526-7 (singlemode)
2 connections	1 Jumper	One-Cord Reference Method (was Method B)	Method A.1
1 connection	2 Jumper	Two-Cord Reference Method (was Method A)	Method A.2
None	3 Jumper	Three-Cord Reference Method (was Method C)	Method A.3

Table A-2. Reference Method Names for IEC Standards

Link End Connections Included in Loss Results	Method Name in This Manual	IEC 61280-4-1 (multimode)	IEC 61280-4-2 (singlemode)
2 connections	1 Jumper	One-Cord Reference Method (was Method 2)	One-Cord Reference Method (was Method A1)
1 connection	2 Jumper	Two-Cord Reference Method (was Method 1)	Two-Cord Reference Method (was Method A2)
None	3 Jumper	Three-Cord Reference Method (was Method 3)	Three-Cord Reference Method (was Method A3)

Appendix B: Modified 1 Jumper Reference Method

This Appendix shows modified reference and test connections that give 1 jumper results. Use these connections if you need 1 jumper results, but do not have the correct connector adapters to connect the CertiFiber Pro modules' output ports to the link. This method lets you keep the test reference cords connected to the module's output ports when you connect the modules to the link.

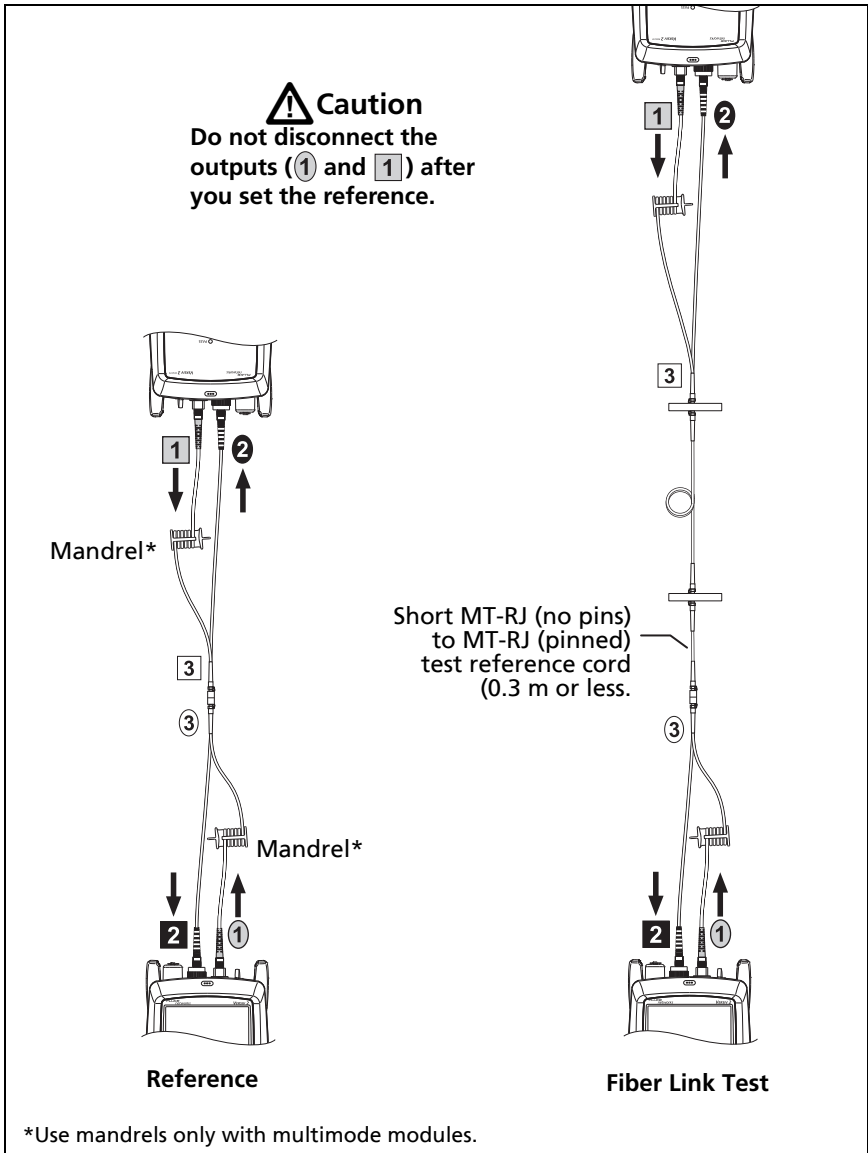

BV139.EPS

Figure B-1. Modified 1 Jumper Reference Method for Smart Remote Mode