



TÜVRheinland®
Precisely Right.

Emissions Test Report

EUT Name: Wireless Multimeter

Model No.: DMM3000 FC

CFR 47 Part 15.247:2013 and RSS-210:2010

Prepared for:

Dave Epperson
Fluke Corporation.
6920 Seaway Blvd.
Everett, WA 98203 U.S.A.
Tel: (425) 446-5928

Prepared by:

TUV Rheinland of North America, Inc.
1279 Quarry Lane, Ste. A
Pleasanton, CA 94566 U.S.A.
Tel: (925) 249-9123
Fax: (925) 249-9124
<http://www.tuv.com/>

Report/Issue Date: March 11, 2014
Report Number: 31460300.001
Project Number: 0000117208
Revision Number: 0

Revisions

Revision No.	Date MM/DD/YYYY	Reason for Change	Author
0	03/11/2014	Original Document	N/A

Statement of Compliance

Manufacturer: Fluke Corporation.
6920 Seaway Blvd.
Everett, WA 98203 U.S.A.
(425) 446-5928

Requester / Applicant: Dave Epperson

Name of Equipment: Wireless Multimeter

Model No. DMM3000 FC

Type of Equipment: Intentional Radiator

Application of Regulations: CFR 47 Part 15.247:2013 and RSS-210:2010

Test Dates: January 15 – February 7, 2014

Guidance Document:

Emissions: ANSI C63.10-2009

Test Methods:

Emissions: ANSI C63.10-2009

The electromagnetic compatibility test and documented data described in this report has been performed and recorded by TUV Rheinland, in accordance with the standards and procedures listed herein. As the responsible authorized agent of the EMC laboratory, I hereby declare that the equipment described above has been shown to be compliant with the EMC requirements of the stated regulations and standards based on these results. If any special accessories and/or modifications were required for compliance, they are listed in the Executive Summary of this report.

This report must not be used to claim product endorsement by A2LA. This report contains data that are not covered by A2LA accreditation. This report shall not be reproduced except in full, without the written authorization of TUV Rheinland of North America.



Jeremy Luong February 28, 2014
Test Engineer Date

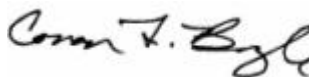

Conan Boyle March 11, 2014
Laboratory Signatory Date



Testing Certificate
#3331.02



US5254

INDUSTRY
CANADA

2932M-1

1	Executive Summary	7
1.1	Scope	7
1.2	Purpose	7
	Summary of Test Results	7
1.3	Special Accessories	8
1.4	Equipment Modifications	8
2	Laboratory Information	9
2.1	Accreditations & Endorsements	9
2.1.1	US Federal Communications Commission	9
2.1.2	NIST / A2LA	9
2.1.3	Canada – Industry Canada	9
2.1.4	Japan – VCCI	9
2.1.5	Acceptance by Mutual Recognition Arrangement	10
2.2	Test Facilities	10
2.2.1	Emission Test Facility	10
2.2.2	Immunity Test Facility	10
2.3	Measurement Uncertainty	11
2.3.1	Sample Calculation – radiated & conducted emissions	11
2.3.2	Measurement Uncertainty	11
	Measurement Uncertainty Immunity	12
2.4	Calibration Traceability	12
3	Product Information	13
3.1	Product Description	13
3.2	Equipment Configuration	13
3.3	Operating Mode	13
3.4	Duty Cycle:	14
3.5	Unique Antenna Connector	14
3.5.1	Results	14
4	Emission Requirements – 2400 MHz to 2483.5 MHz Band	15
4.1	Output Power Requirements	15
4.1.1	Test Method	15
4.1.2	Results	16
4.2	Occupied Bandwidth	20
4.2.1	Test Method	20
4.2.2	Results	21
4.3	Hopping Frequency Requirements	25
4.3.1	Results	25
4.4	Out of Band Emission requirements	33
4.4.1	Results	33

Index of Tables

4.5	Maximum RF Exposure	41
4.5.1	Test Methodology	41
4.5.2	FCC KDB 447498 D01 – General SAR Test Exclusion Guidance	41
4.5.3	EUT Operating Condition	42
4.5.4	Classification	42
4.5.5	SAR Test Exclusion Threshold	42
4.6	Transmitter Spurious Emissions	43
4.6.1	Test Methodology	43
4.6.2	Transmitter Spurious Emission Limit	44
4.6.3	Test Results	44
4.6.4	Sample Calculation	60
4.7	AC Conducted Emissions	61
4.7.1	Test Methodology	61
4.7.2	Deviations	61
4.7.3	Test Results	61
5	Test Equipment Use List	62
5.1	Equipment List	62
6	EMC Test Plan	63
6.1	Introduction	63
6.2	Customer	63
6.3	Product Specification	64
6.4	Configuration (s)	65
6.5	Duty Cycle	66
6.6	Test Specifications	67

Index of Tables

Table 1: Summary of Test Results 7
Table 2: RF Output Power at the Antenna Port – Test Results 16
Table 3: Occupied Bandwidth – Test Results 21
Table 4: Frequency Hopping Requirements 25
Table 5: Band Edge Requirements – Test Results 33
Table 6: Transmit Spurious Emission at Restricted Band Edge Requirements 45
Table 7: Customer Information 63
Table 8: Technical Contact Information 63
Table 9: EUT Specifications 64
Table 10: Description of Sample used for Testing..... 65
Table 11: Description of Test Configuration used for Radiated Measurement. 65
Table 12: Test Specifications 67

1 Executive Summary

1.1 Scope

This report is intended to document the status of conformance with the requirements of the CFR 47 Part 15.247:2013 and RSS-210:2010 based on the results of testing performed from January 15 to February 7, 2014 on the Wireless Multimeter Model DMM3000 FC manufactured by Fluke Corporation. This report only applies to the specific samples tested under the stated test conditions. It is the responsibility of the manufacturer to assure that additional production units of this model are manufactured with identical or EMI equivalent electrical and mechanical components. This report is further intended to document changes and modifications to the EUT throughout its life cycle. All documentation will be included as a supplement.

1.2 Purpose

Testing was performed to evaluate the EMC performance of the EUT in accordance with the applicable requirements, procedures, and criteria defined in the application of regulations and application of standards listed in this report.

Summary of Test Results

Table 1: Summary of Test Results

Test	Test Method ANSI C63.4	Test Parameters	Measured Value	Result
2400 MHz to 2483.5 MHz Band				
Spurious Emission in Transmitted Mode	CFR47 15.209, RSS-GEN Sect.7.2.3	Class B	-4.88 dB	Complied
Restricted Bands of Operation	CFR47 15.205, RSS-210 Sect.2.6	Class B		Complied
AC Power Conducted Emission	CFR47 15.207, RSS-GEN Sect.7.2.2	N/A	Na.	N/A
Occupied Bandwidth	CFR 47 15.247(a1), RSS Gen Sect. 4.4.1	N/A	699.20 kHz (20dB BW) 782.11 kHz (99% BW)	Complied
Channel Separation	CFR47 15.247 (a1), RSS-210 Sect. A.8.1	>25 kHz	1968.60 kHz	Complied
Number of Hopping Channels	CFR47 15.247 (a1), RSS-210 Sect. A.8.1	>15	40 Channels	Complied
Average time occupancy of Channel	CFR47 15.247 (a1), RSS-210 Sect. A.8.1	< 0.4 sec	6.575 mS	Complied
Maximum Transmitted Power	CFR47 15.247 (b1), RSS-210 Sect. A.8.1	<125 mWatts	8.36 mW	Complied
Out of Band Emission	CFR47 15.247 (d), RSS-210 Sect. A.8.5	< -20 dBr	- 30.03 dBr	Complied

Note: Since EUT is portable device where the end user will have the direct contact as handheld device, RF Exposure/SAR requirements are calculated for human extremity parts, and EUT met FCC KDB 447498 SAR exclusion. See Section 4.5 of this report

1.3 Special Accessories

No special accessories were necessary in order to achieve compliance.

1.4 Equipment Modifications

None

2 Laboratory Information

2.1 Accreditations & Endorsements

2.1.1 US Federal Communications Commission



TUV Rheinland of North America at 1279 Quarry Ln, Pleasanton, CA 94566 is recognized by the commission for performing testing services for the general public on a fee basis. These laboratory test facilities have been fully described in reports submitted to and accepted by the FCC (US5254). The laboratory scope of accreditation includes: Title 47 CFR Parts 15, 18, and 90. The accreditation is updated every 3 years.

2.1.2 NIST / A2LA



TUV Rheinland of North America is accredited by the National Voluntary Laboratory Accreditation Program, which is administered under the auspices of the National Institute of Standards and Technology. The laboratory has been assessed and accredited in accordance with ISO Guide 17025:2005 and ISO 9002 (Lab Code Testing Certificate #3331.02). The scope of laboratory accreditation includes emission and immunity testing. The accreditation is updated annually.

2.1.3 Canada – Industry Canada



TUV Rheinland of North America at the 1279 Quarry Ln, Pleasanton, CA 94566 address is accredited by Industry Canada for performing testing services for the general public on a fee basis. This laboratory test facilities have been fully described in reports submitted to and accepted by Industry Canada (File Number 2932M). This reference number is the indication to the Industry Canada Certification Officers that the site meets the requirements of RSS 212, Issue 1 (Provisional). The accreditation is updated every 3 years.

2.1.4 Japan – VCCI



The Voluntary Control Council for Interference by Information Technology Equipment (VCCI) is a group that consists of Information Technology Equipment (ITE) manufacturers and EMC test laboratories. The purpose of the Council is to take voluntary control measures against electromagnetic interference from Information Technology Equipment, and thereby contribute to the development of a socially beneficial and responsible state of affairs in the realm of Information Technology Equipment in Japan. TUV Rheinland of North America at 1279 Quarry Ln, Pleasanton, CA 94566 has been assessed and approved in accordance with the Regulations for Voluntary Control Measures.

VCCI Registration No. for Pleasanton: A-0031

VCCI Registration No. for Santa Clara: A-0032

2.1.5 Acceptance by Mutual Recognition Arrangement



The United States has an established agreement with specific countries under the Asia Pacific Laboratory Accreditation Corporation (APLAC) Mutual Recognition Arrangement. Under this agreement, all TUV Rheinland at 1279 Quarry Ln, Pleasanton, CA 94566 test results and test reports within the scope of the laboratory NIST / A2LA accreditation will be accepted by each member country.

2.2 Test Facilities

All of the test facilities are located at 1279 Quarry Lane, Pleasanton, California 94566, USA. The 2305 Mission College, Santa Clara, 95054, USA location is considered a Pleasanton annex.

2.2.1 Emission Test Facility

The Semi-Anechoic chamber and AC Line Conducted measurement facility used to collect the radiated and conducted data has been constructed in accordance with ANSI C63.7:1992. The site has been measured in accordance with and verified to comply with the theoretical normalized site attenuation requirements of ANSI C63.4-2009, at a test distance of 3 and 5 meters. The site is listed with the FCC and accredited by A2LA (Lab Code Testing Certificate #3331.02). The 3/5-meter semi-anechoic chamber used to collect the radiated data has been verified to comply with the theoretical normalized site attenuation requirements of ANSI C63.4-2009, at a test distance of 3 meter and 5 meters. A report detailing this site can be obtained from TUV Rheinland of North America.

2.2.2 Immunity Test Facility

ESD, EFT, Surge, PQF: These tests are performed in an environmentally controlled room with a 3.7 m x 4.8 m x 3.175 mm thick aluminum floor connected to PE ground.

For ESD testing, tabletop equipment is placed on an insulated mat with a surface resistivity of 10^9 Ohms/square on a 1.6 m x 0.8 m x 0.8 m high non-conductive table with a 3.175 mm aluminum top (Horizontal Coupling Plane). The HCP is connected to the main ground plane via a low impedance ground strap through two 470-k Ω resistors. The Vertical Coupling Plane consists of an aluminum plate 50 cm x 50 cm x 3.175 mm thick. The VCP is connected to the main ground plane via a low impedance ground strap through two 470-k Ω resistors.

For EFT, Surge, PQF, the HCP and VCP are removed.

RF Field Immunity testing is performed in a 7.3m x 4.3m x 4.1m anechoic chamber.

RF Conducted and Magnetic Field Immunity testing is performed on a 4.8m x 3.7m x 3.175mm thick aluminum ground plane.

All test areas allow a minimum distance of 1 meter from the EUT to walls or conducting objects.

2.3 Measurement Uncertainty

Two types of measurement uncertainty are expressed in this report, per *ISO Guide To The Expression Of Uncertainty In Measurement*, 1st Edition, 1995.

The Combined Standard Uncertainty is the standard uncertainty of the result of a measurement when that result is obtained from the values of a number of other quantities; it is equal to the positive square root of the sum of the variances or co-variances of these other quantities, weighted according to how the measurement result varies with changes in these quantities. The term *standard uncertainty* is the result of a measurement expressed as a standard deviation.

2.3.1 Sample Calculation – radiated & conducted emissions

The field strength is calculated by subtracting the Amplifier Gain and adding the Cable Loss and Antenna Correction Factor to the measured reading. The basic equation is as follows:

$$\text{Field Strength (dB}\mu\text{V/m)} = \text{RAW} - \text{AMP} + \text{CBL} + \text{ACF}$$

Where: RAW = Measured level before correction (dB μ V)

AMP = Amplifier Gain (dB)

CBL = Cable Loss (dB)

ACF = Antenna Correction Factor (dB/m)

$$\mu\text{V/m} = 10^{\frac{\text{dB}\mu\text{V/m}}{20}}$$

Sample radiated emissions calculation @ 30 MHz

Measurement +Antenna Factor–Amplifier Gain+Cable loss=Radiated Emissions (dBuV/m)

$$25 \text{ dBuV/m} + 17.5 \text{ dB} - 20 \text{ dB} + 1.0 \text{ dB} = 23.5 \text{ dBuV/m}$$

2.3.2 Measurement Uncertainty

Per CISPR 16-4-2	U _{lab}	U _{cispr}
Radiated Disturbance @ 10 meters		
30 – 1,000 MHz	2.25 dB	4.51 dB
Radiated Disturbance @ 3 meters		
30 – 1,000 MHz	2.26 dB	4.52 dB
1 – 6 GHz	2.12 dB	4.25 dB
6 – 18 GHz	2.47 dB	4.93 dB
Conducted Disturbance @ Mains Terminals		
150 kHz – 30 MHz	1.09 dB	2.18 dB

Disturbance Power		
30 MHz – 300 MHz	3.92 dB	4.3 dB

Voltech PM6000A

The estimated combined standard uncertainty for harmonic current and flicker measurements is $\pm 5.0\%$.	Per CISPR 16-4-2 Methods
--	--------------------------

Measurement Uncertainty Immunity

The estimated combined standard uncertainty for ESD immunity measurements is $\pm 8.2\%$.	Per IEC 61000-4-2
The estimated combined standard uncertainty for radiated immunity measurements is ± 4.10 dB.	Per IEC 61000-4-3
The estimated combined standard uncertainty for conducted immunity measurements with CDN is ± 3.66 dB	Per IEC 61000-4-6
The estimated combined standard uncertainty for power frequency magnetic field immunity is $\pm 11.6\%$.	Per IEC 61000-4-8

Thermo KeyTek EMC Pro

The estimated combined standard uncertainty for EFT fast transient immunity measurements is $\pm 5.84\%$.
The estimated combined standard uncertainty for surge immunity measurements is $\pm 5.84\%$.
The estimated combined standard uncertainty for voltage variation and interruption measurements is $\pm 3.48\%$.

The expanded uncertainty at a level of 95% confidence is obtained by multiplying the combined standard uncertainty by a coverage factor of 2. Compliance criteria are not based on measurement uncertainty.

2.4 Calibration Traceability

All measurement instrumentation is traceable to the National Institute of Standards and Technology (NIST). Measurement method complies with ANSI/NCSL Z540-1-1994 and ISO Standard 17025:2005. Equipment calibration records are kept on file at the test facility.

3 Product Information

3.1 Product Description

The DMM3000 FC is a portable, handheld wireless digital multimeter. The DMM3000 FC multimeter provides all standard basic measurements such as;

- AC and DC Voltage measurements
- Volt/Hertz Ratio
- Resistance Measurements
- Capacitance Measurements
- Continuity Tests
- AC and DC Current Measurements
- Diode Test
- Frequency Measurement

The DMM3000 FC uses low-power 802.15.4 wireless technology to show the remote measurements; up to three 3000 FC Series wireless module meters.

3.2 Equipment Configuration

A description of the equipment configuration is given in the Test Plan Section. The EUT was tested as called for in the test standard and was configured and operated in a manner consistent with test standards. The EUT was programed to rated power and allowed to reach intended operating conditions. The placement of the EUT system components was guided by the test standard and selected to represent typical installation conditions.

In the case of EUT that can operate in more than one configuration, preliminary testing was performed to determine the configuration that produced maximum radiation.

The final configuration was selected to produce the worst case radiation for emissions testing and to place the EUT in the most susceptible state for immunity testing.

3.3 Operating Mode

A description of the operation mode is given in the Test Plan Section. In the case of an EUT that can operate in more than one state, preliminary testing was performed to determine the operating mode that produced maximum radiation.

EUT was programed to operate at > 99% duty for the purpose of testing. This operating mode was selected to produce the worst case radiation for emissions testing and to place the EUT in the most susceptible state for immunity testing.

3.4 Duty Cycle:

Duty Cycle description is provided under test plan in section 11.

3.5 Unique Antenna Connector

An intentional radiator shall be designed to ensure that no antenna other than that furnished by the responsible party shall be used with the device. The use of a permanently attached antenna or of an antenna that uses a unique coupling to the intentional radiator shall be considered sufficient to comply with the provisions of this Section. The manufacturer may design the unit so that a broken antenna can be replaced by the user, but the use of a standard antenna jack or electrical connector is prohibited. This requirement does not apply to carrier current devices or to devices operated under the provisions of CFR47 Parts 15.211, 15.213, 15.217, 15.219, or 15.221.

3.5.1 Results

The Wireless Multimeter has one internal antenna. The antenna is integral part of main PCB.

Antenna Specification:

Manufacturer - Johanson Technology

Part Number – 2450AT45A100

Type - Ceramic Chip

Antenna Gain – 3.0 dBi

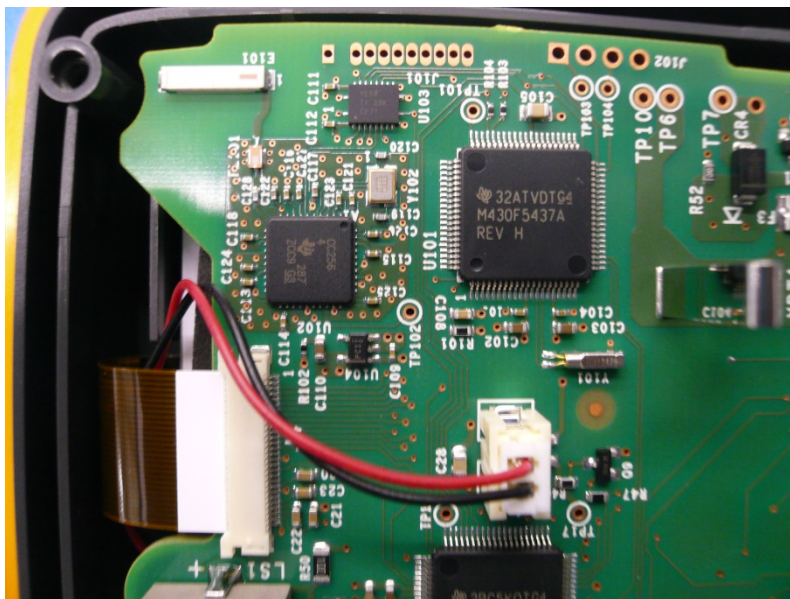

4 Emission Requirements – 2400 MHz to 2483.5 MHz Band

Testing was performed in accordance with CFR 47 Part 15.247:2013 and RSS-210 Annex 8: 2010. These test methods are listed under the laboratory's A2LA Scope of Accreditation. This test measures the levels emanating from the EUT, thus evaluating the potential for the EUT to cause radio frequency interference to other electronic devices. Procedures described in Section 8 of the standard were used.

4.1 Output Power Requirements

The maximum output power requirement is the maximum equivalent isotropic radiated power delivering at the transmitting antenna under specified conditions of measurements in the presence of modulation.

The maximum output power and harmonics shall not exceed CFR47 Part 15.247 (b1) and RSS-210 A.8.1: 2010

Frequency hopping systems in the 2400-2483.5 MHz band: 0.125 watts.

4.1.1 Test Method

The conducted method was used to measure the channel power output according to ANSI C63.10:2009 Section 6.10.3.1. The measurement was performed with modulation per CFR47 Part 15.247 (b 1):2013 and RSS-210 A.8.1. This test was conducted on 3 channels on DMM3000 FC, SN: 26150028. The worst mode result indicated below.

Test Setup:

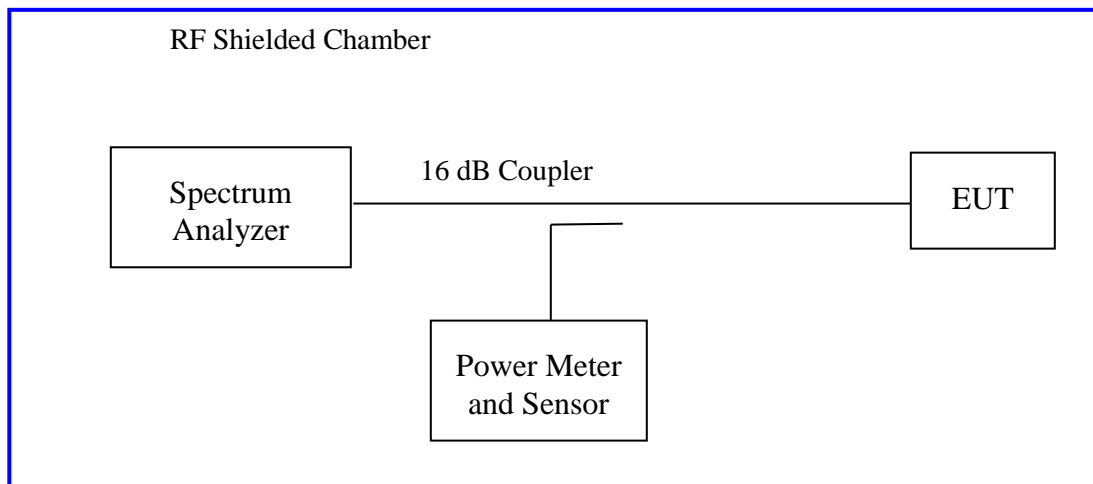

4.1.2 Results

As originally tested, the EUT was found to be compliant to the requirements of the test standard(s).

Table 2: RF Output Power at the Antenna Port – Test Results

Test Conditions: Conducted Measurement, Normal Temperature				
Antenna Type: Chip Antenna		Power Setting: Fixed.		
Max. Antenna Gain: +3.0 dBi		Signal State: Modulated		
Duty Cycle: 100 %		Data Rate: see below		
Ambient Temp.: 23° C		Relative Humidity: 35 %RH		
802.15.1 Mode				
Operating Channel	Limit [dBm]	Power [dBm]	Power [mWatts]	Margin [dB]
2402 MHz	+20.96	9.22	8.36	-11.74
2442 MHz	+20.96	8.31	6.78	-12.65
2480 MHz	+20.96	8.16	6.55	-12.80
Note: EUT has a low duty cycle. EUT was modified to transmit continuously for test purpose. The normal data rate is 1 Mbps. The above measurements did not apply any duty cycle correction factor.				

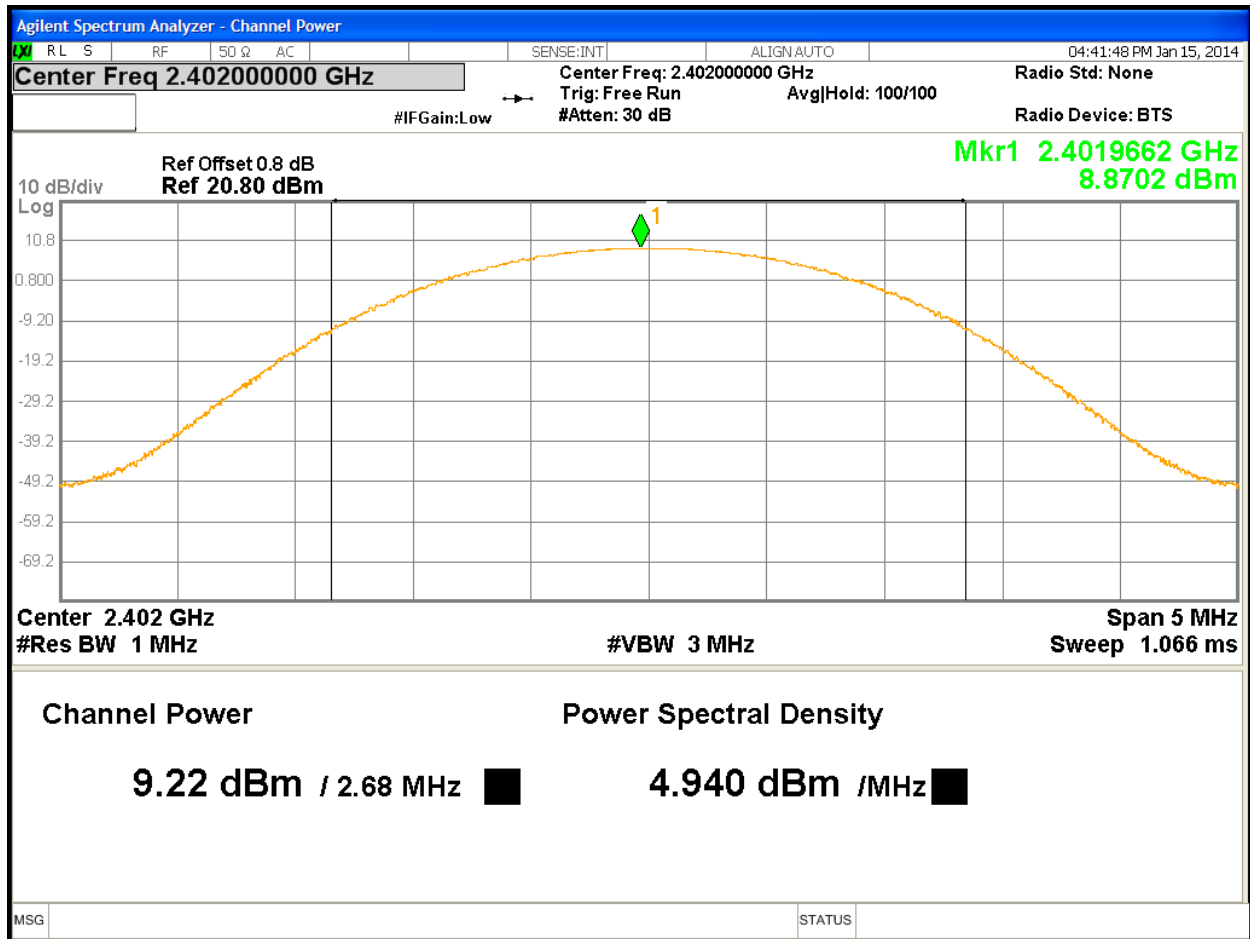

Figure 1: Maximum Transmitted Power, 2402 MHz

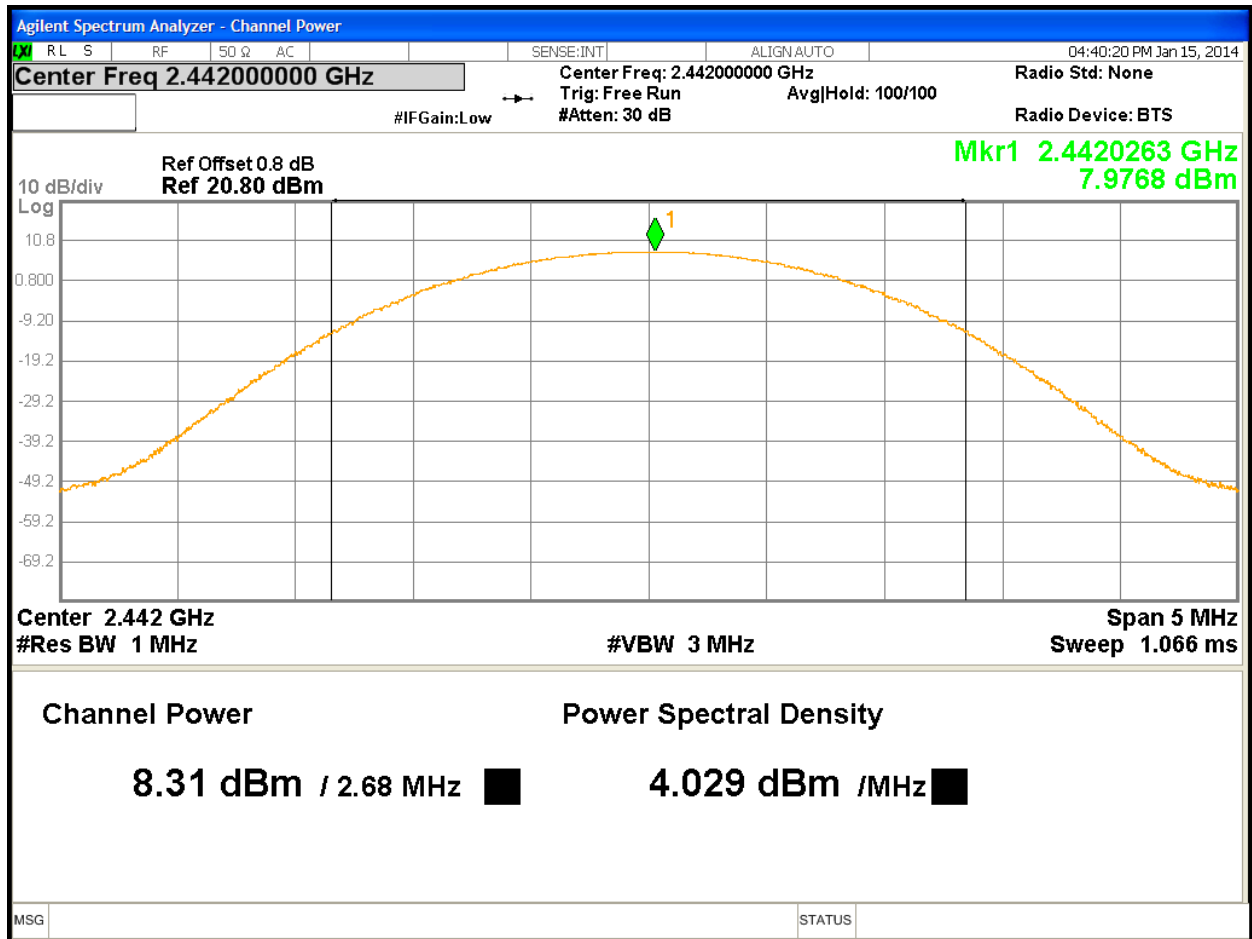

Figure 2: Maximum Transmitted Power, 2442 MHz

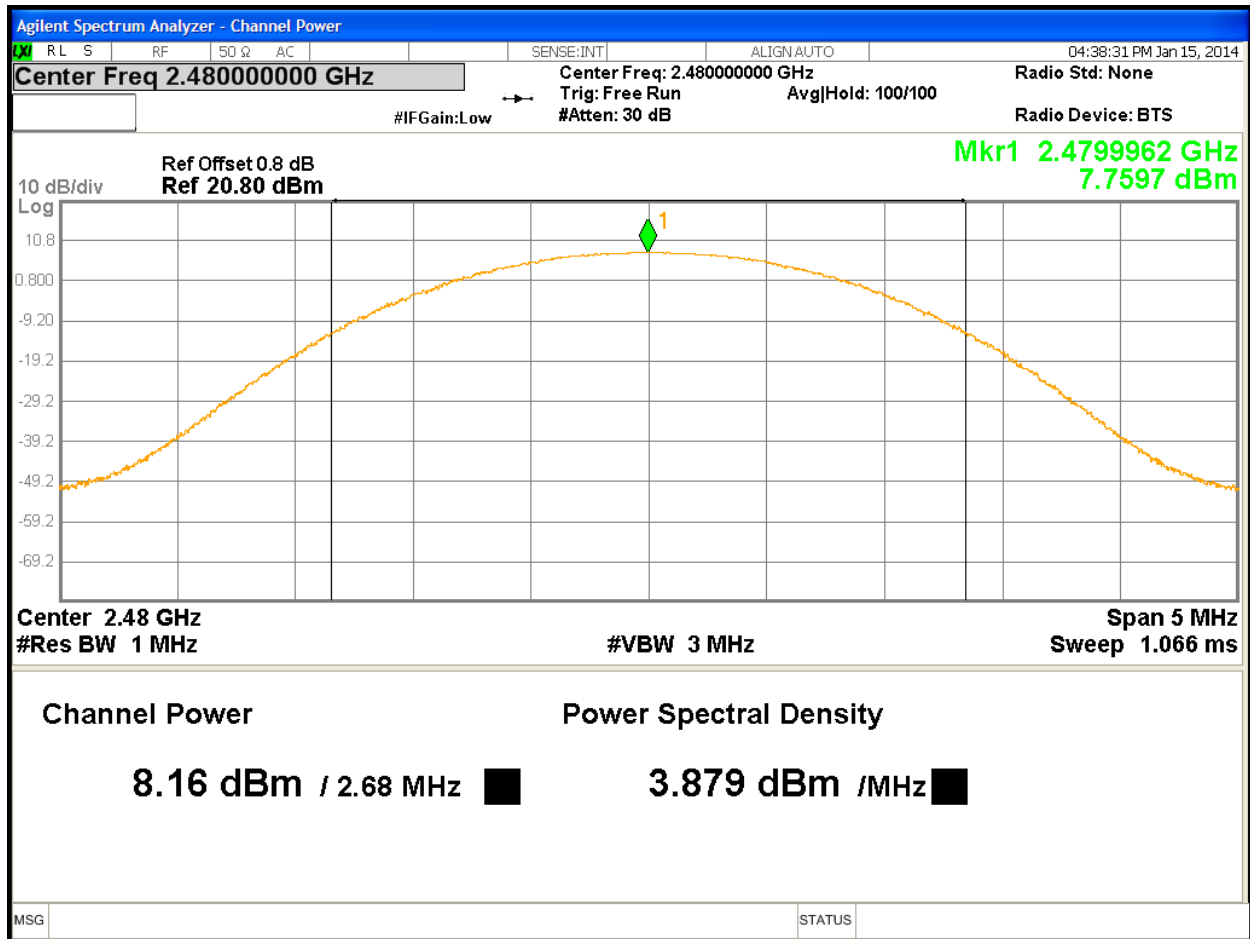

Figure 3: Maximum Transmitted Power, 2480 MHz

4.2 Occupied Bandwidth

The occupied bandwidth is measured at an amplitude level reduced from the reference level by a specified ratio. The reference level is the level of the highest amplitude signal observed from the transmitter at the fundamental frequency.

The 99% bandwidth is the bandwidth in which 99% of the transmitted power occupied.

20 dB bandwidth was performed by coupling the output of the EUT to the input of a spectrum analyzer.

4.2.1 Test Method

The conducted method was used to measure the occupied bandwidth. The measurement was performed with modulation per CFR47 15.247(a) (1) 2013 and RSS Gen Sect. 4.4.1:2010. This test was conducted on 3 channels on DMM3000 FC, SN: 26150028. The worst sample result indicated below.

Test Setup:

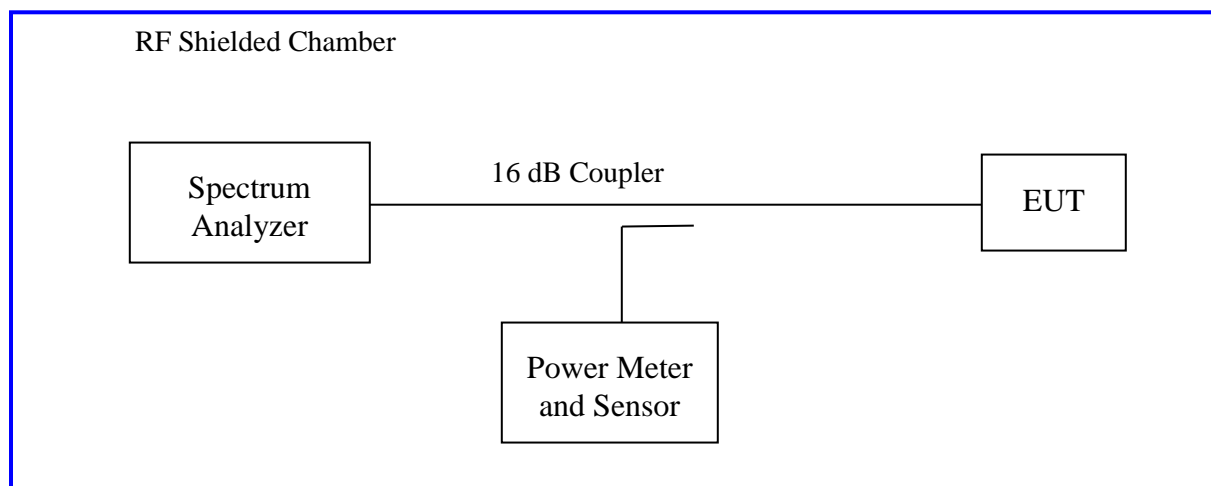

4.2.2 Results

These measurements were used for information only

Table 3: Occupied Bandwidth – Test Results

Test Conditions: Conducted Measurement, Normal Temperature and Voltage only		
Antenna Type: Chip Antenna		Power Setting: Fixed.
Max. Antenna Gain: +3.0 dBi		Signal State: Modulated
Duty Cycle: 100 %		Data Rate: see below
Ambient Temp.: 23° C		Relative Humidity: 35 %RH
Bandwidth (MHz)		
Freq. (MHz)	20dB Bandwidth MHz	99% Bandwidth MHz
2402	0.9182	0.78704
2442	0.7856	0.78416
2480	0.6992	0.782.11
Notes: EUT operated at 1 Mbps.		

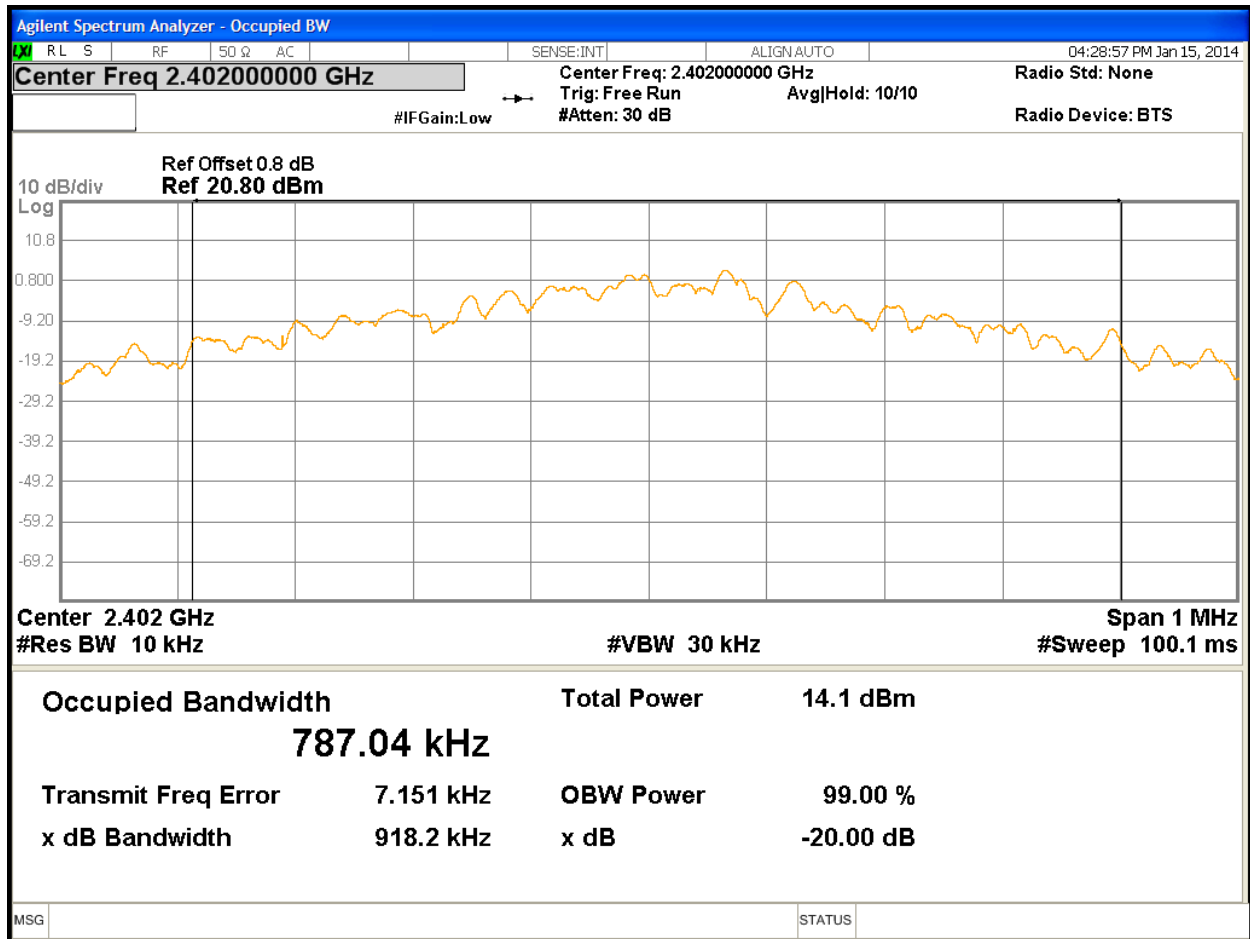

Figure 4: Occupied Bandwidth at 2402 MHz

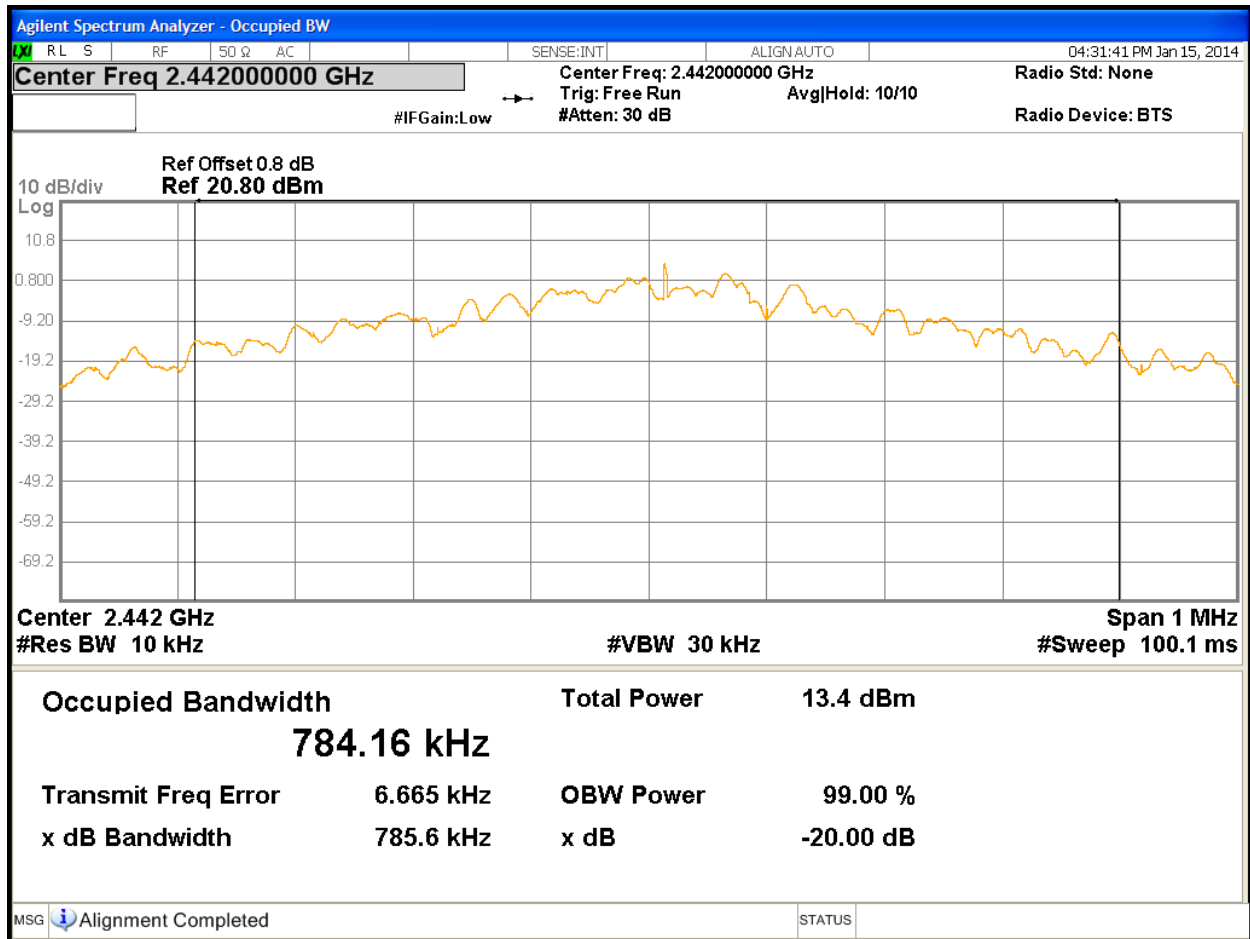

Figure 5: Occupied Bandwidth at 2442 MHz

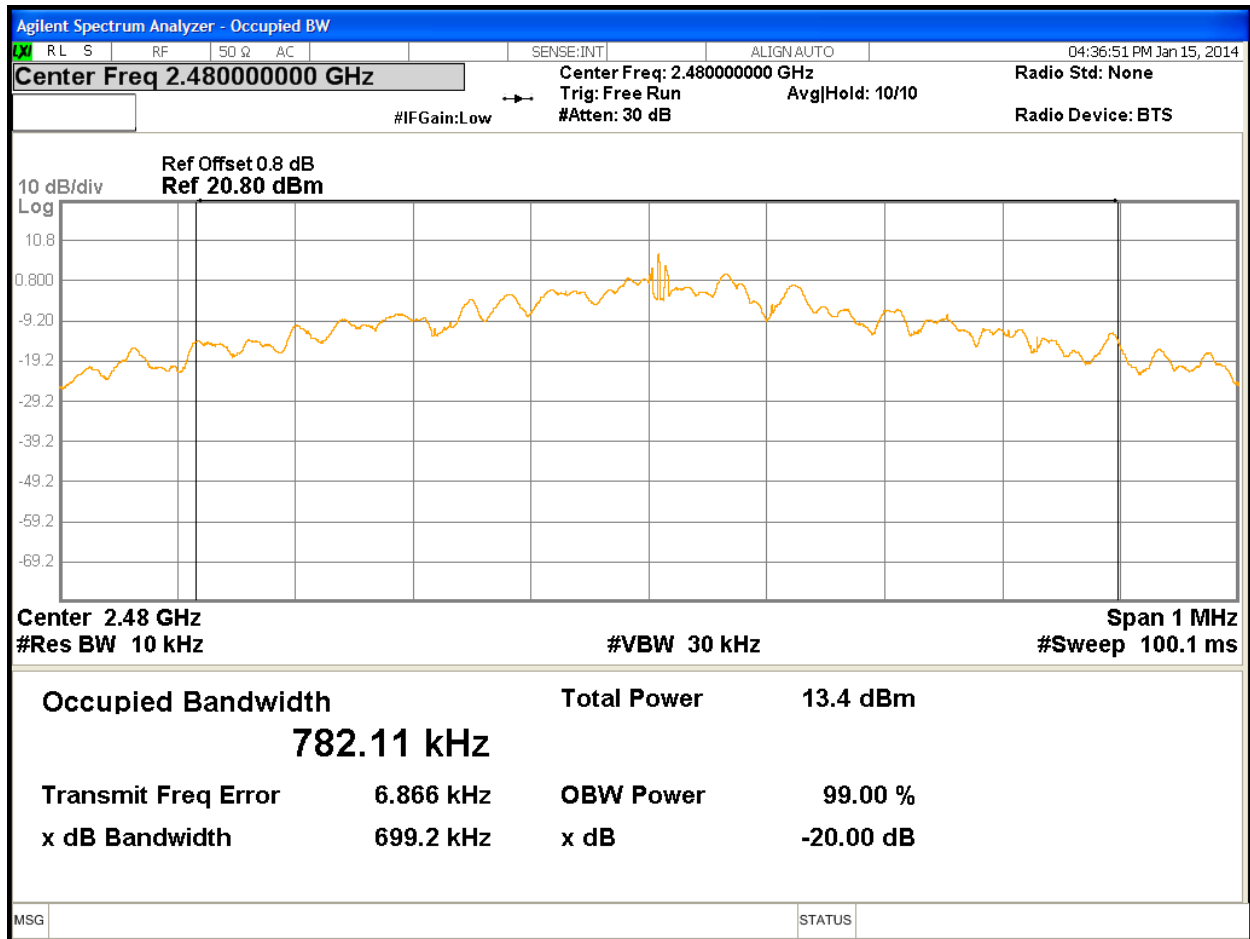

Figure 6: Occupied Bandwidth at 2480 MHz

4.3 Hopping Frequency Requirements

The Frequency Hopping Requirements are applicable to the equipment using Frequency Hopping Spread Spectrum (FHSS) modulation.

Per CFR47 15.247 (a1), RSS-210 Sect.A.8.1.2, frequency hopping systems in the 2400–2483.5 MHz band shall use at least 15 channels. The average time of occupancy on any channel shall not be greater than 0.4 seconds within a period of 0.4 seconds multiplied by the number of hopping channels employed.

Frequency hopping systems shall have hopping channel carrier frequencies separated by a minimum of 25 kHz or the 20 dB bandwidth of the hopping channel, whichever is greater. Alternatively, frequency hopping systems operating in the 2400-2483.5 MHz band may have hopping channel carrier frequencies that are separated by 25 kHz or two-thirds of the 20 dB bandwidth of the hopping channel, whichever is greater, provided the systems operate with an output power no greater than 125 mW.

The setup was identical to RF output power measurement.

4.3.1 Results

As originally tested, the EUT was found to be compliant to the requirements of the test standard(s).

Table 4: Frequency Hopping Requirements

Test Conditions: Conducted Measurement, Normal Temperature and Voltage only				
Antenna Type: Chip Antenna		Power Setting: Fixed.		
Max. Antenna Gain: +3.0 dBi		Signal State: Modulated		
Duty Cycle: 100 %		Data Rate: see below		
Ambient Temp.: 23° C		Relative Humidity: 35 %RH		
Average Occupancy Time				
Pulse Width (ms)	# of Pulses in 1.6s	Ave. Time (ms)	Limit (s)	Result
0.1315	5	6.575	< 0.4	Pass
Comment: Since the dwell time in each channel must less than 0.4 seconds. The total time for dwell all 40 channels is 16 seconds. To determine the average dwell time, the frequency 2404MHz was sampled in 1.6 second, 1/10 th of the total 40 channel dwell time.				

Minimum Channel Separation			
Operating Channel (MHz)	Hopping Separation (kHz)	Two-Third of 20dB Bandwidth Limit (kHz)	Result
2402	1986.10	> 612kHz	Pass
2440	2023.35	> 612kHz	Pass
2480	1968.60	> 612kHz	Pass
Comment: Two-Third of the highest 20dB bandwidth was used.			
Minimum Number of Channels			
Range (2402MHz -2480MHz)	Min. Channel Limit	Result	
40	15	Pass	

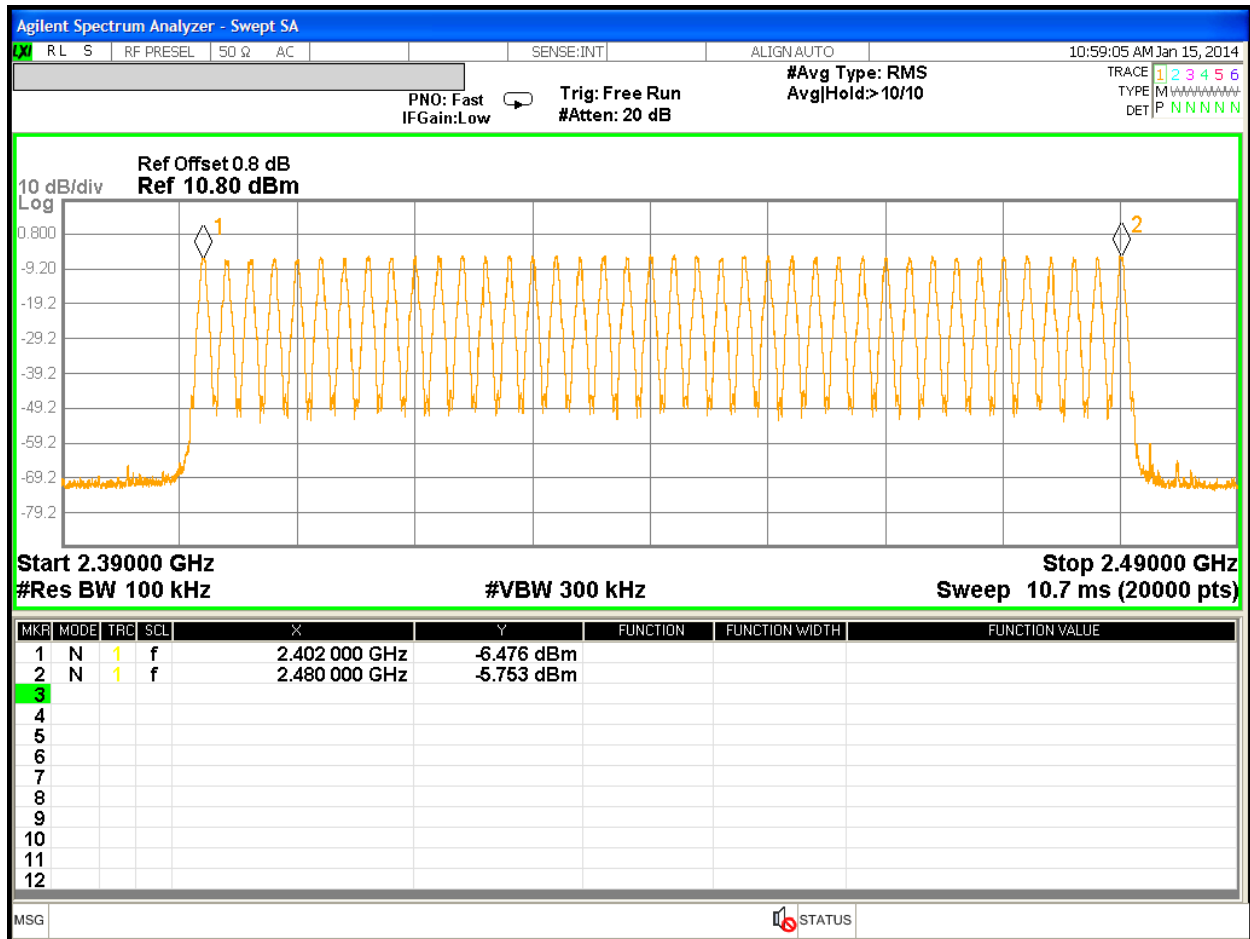

Figure 7: Number of Operating Channels

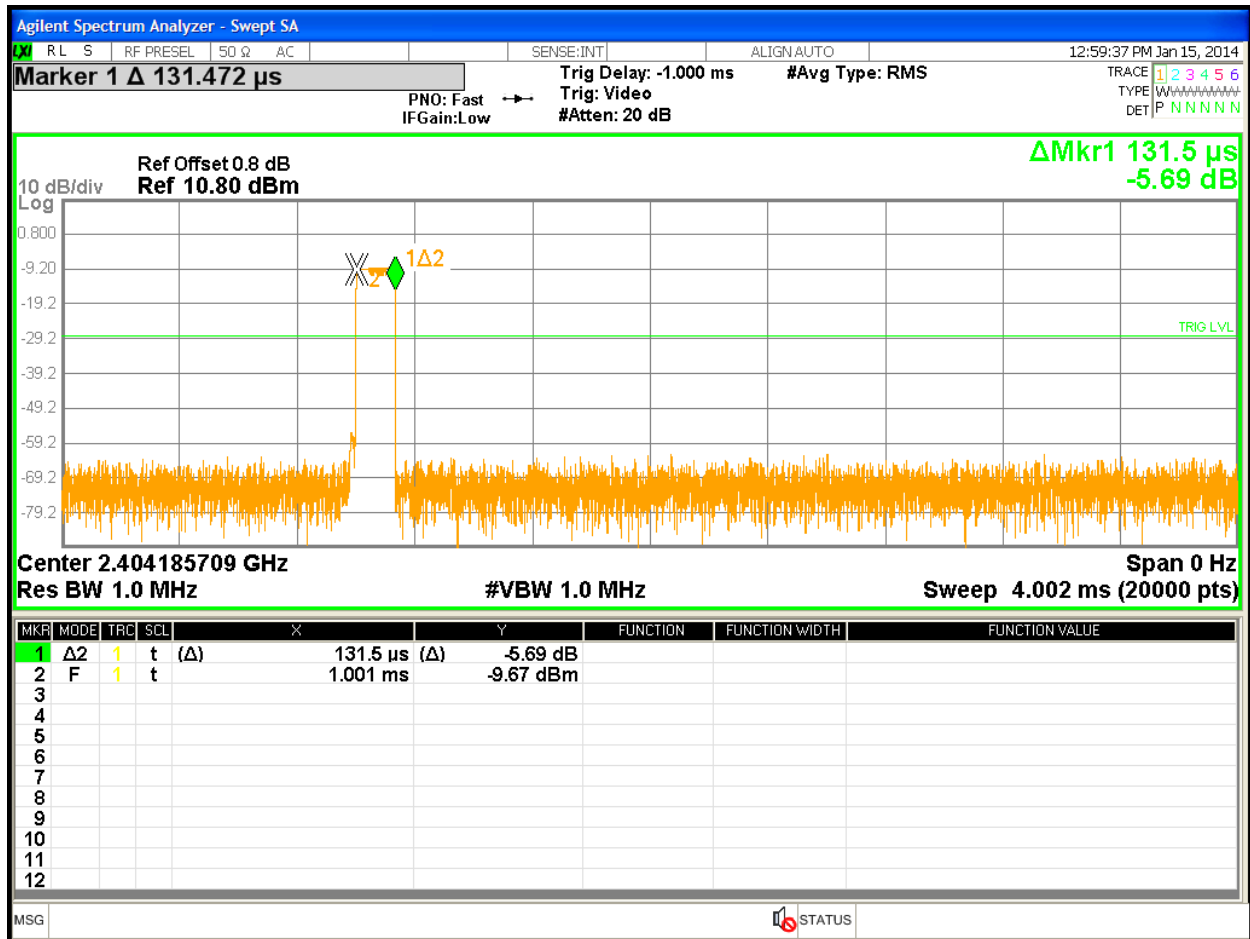

Figure 8: Pulse Width – Channel 2404MHz

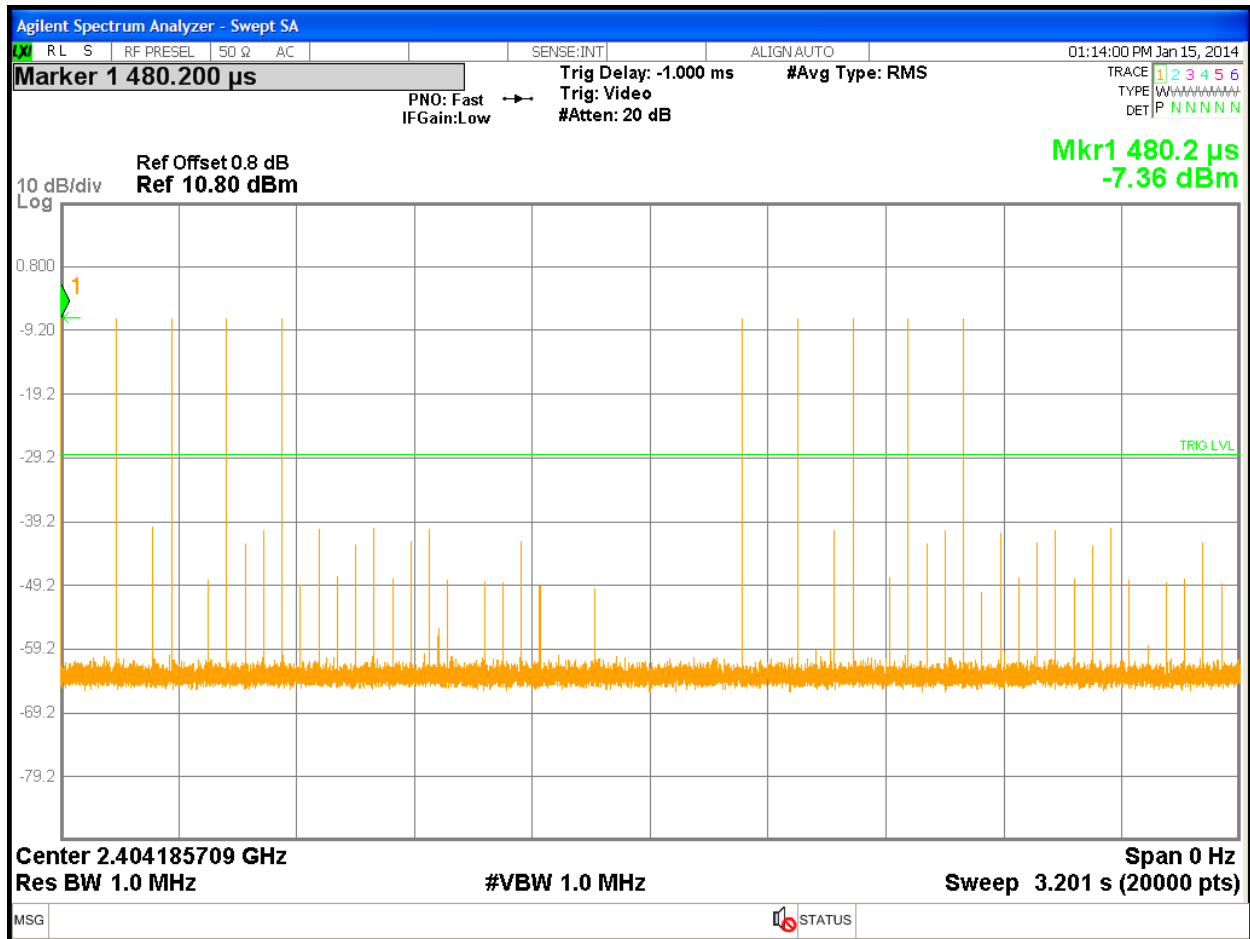

Figure 9: Average Dwell Time for Channel 2404MHz – 10 Pulses

Note: There are 5 pulse in 1.6 seconds.

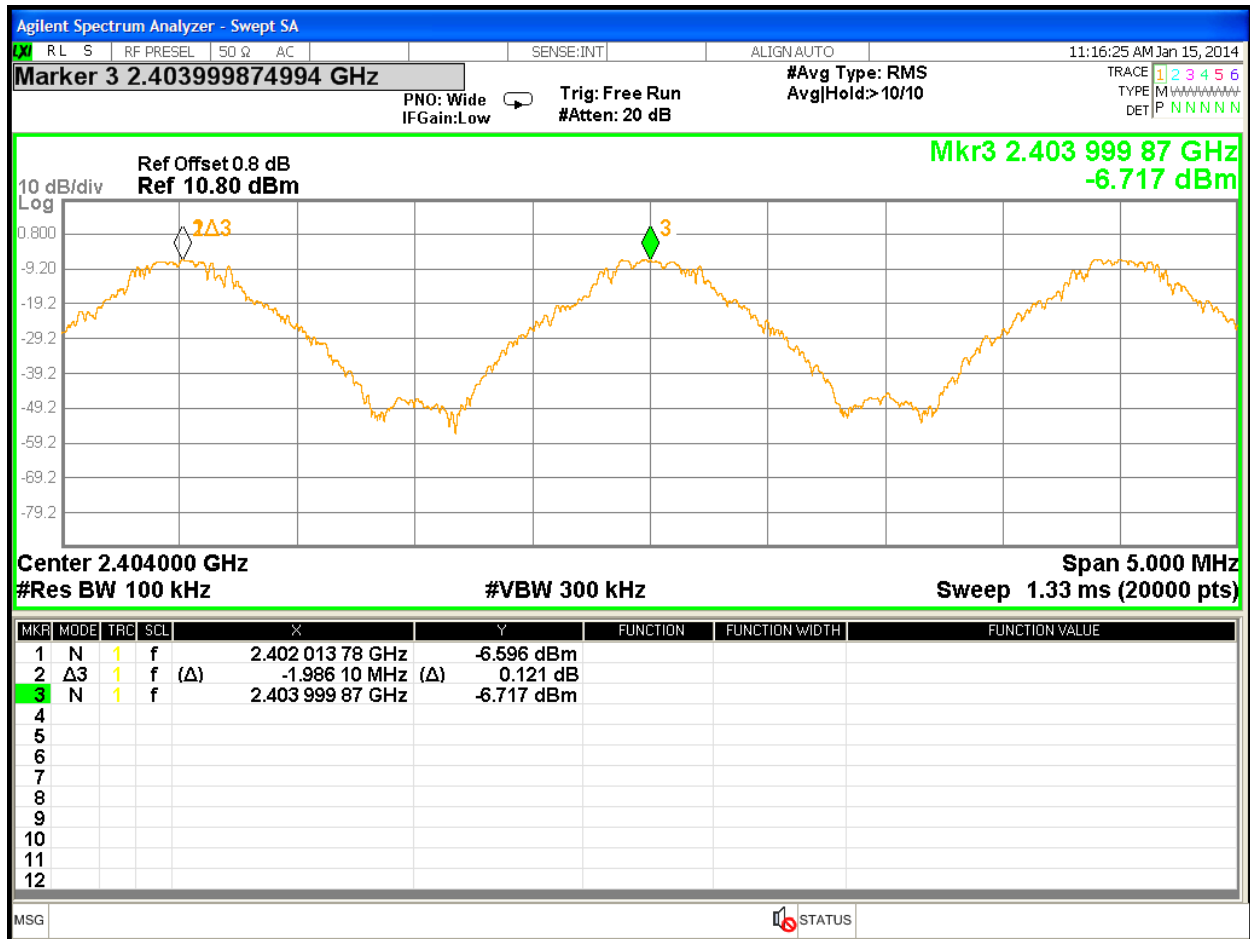

Figure 10: Channel Separation at 2402MHz

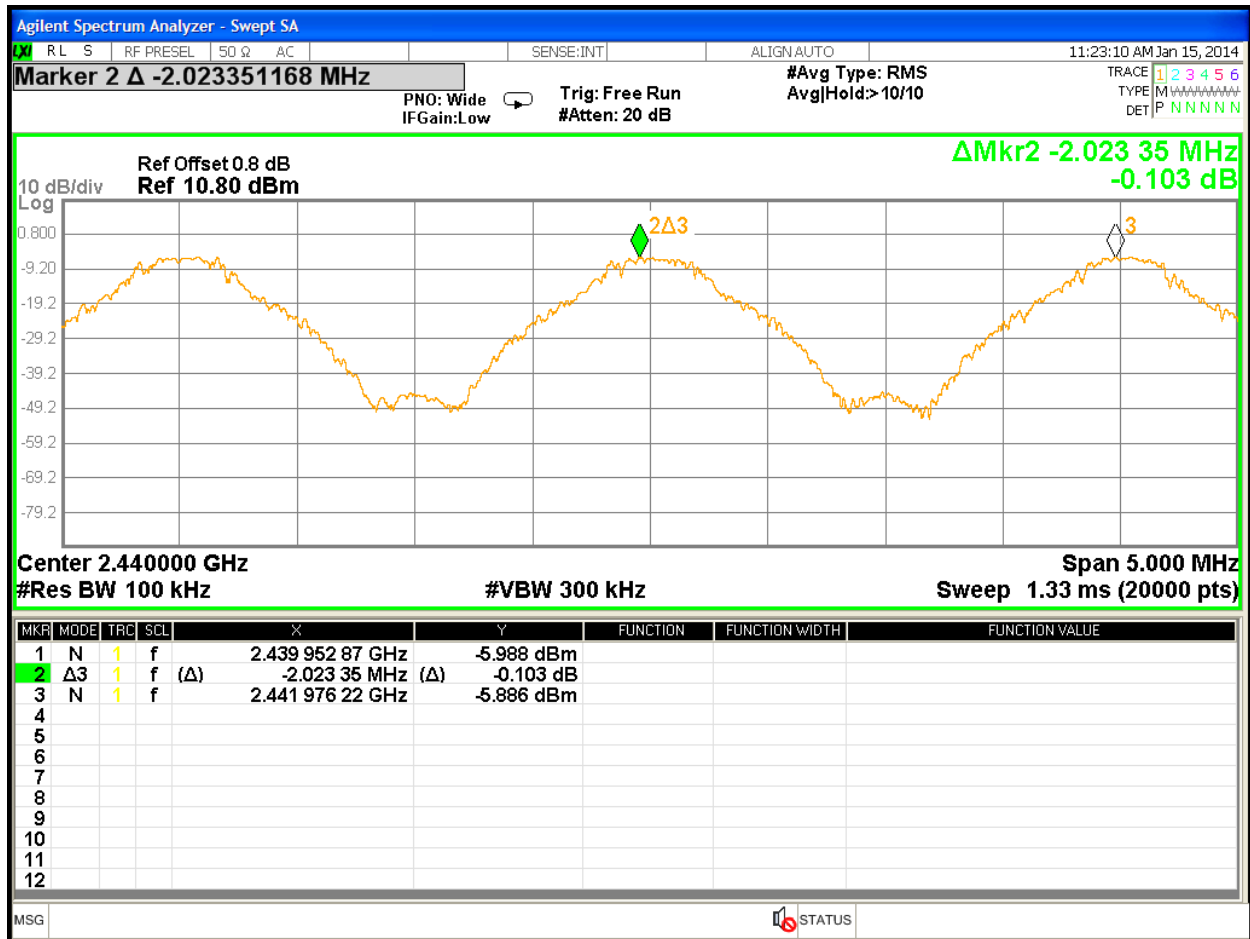

Figure 11: Channel Separation at 2440MHz

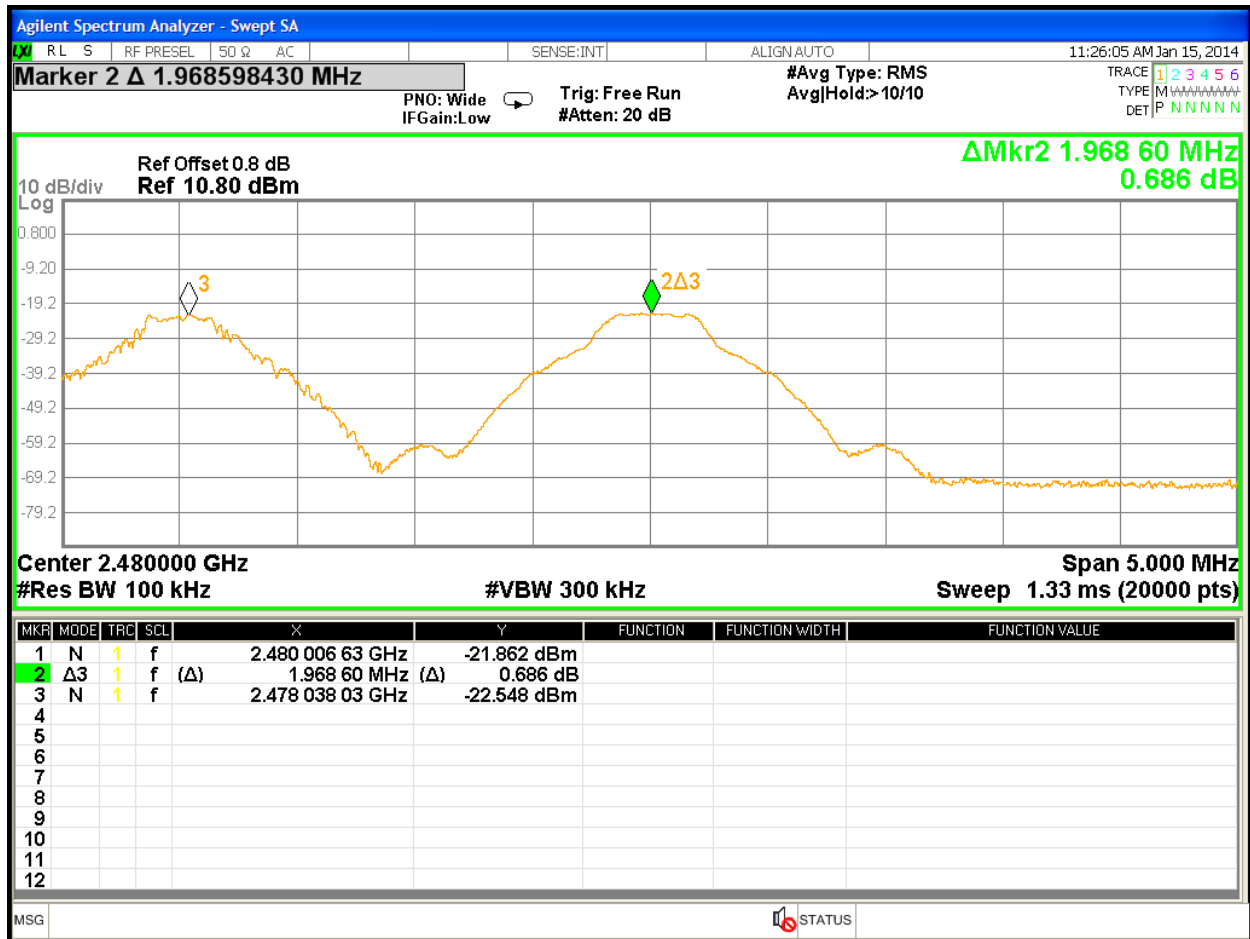

Figure 12: Channel Separation at 2480MHz

4.4 Out of Band Emission requirements

The setup was identical to RF output power measurement. Intentional radiators operating under the alternative provisions to the general emission limits, must be designed to ensure that the 20 dB bandwidth of the emission, or whatever bandwidth may otherwise be specified in the specific rule section under which the equipment operates, is contained within the frequency band designated in the rule section under which the equipment is operated. The requirement to contain the designated bandwidth of the emission within the specified frequency band includes the effects from frequency sweeping, frequency hopping and other modulation techniques that may be employed as well as the frequency stability of the transmitter over expected variations in temperature and supply voltage. If the frequency stability is not specified in the regulations, it is recommended that the fundamental emission be kept within at least the central 80% of the permitted band in order to minimize the possibility of out-of-band operation.

Any frequency outside the band of 2400 MHz to 2483.5 MHz, the power output level must be below 20 dB from the in-band transmitting signal; CFR 47 Part 15.215, 15.247(d) and RSS-210 A8.5

The setup was identical to RF output power measurement.

This test was conducted on 3 channels on DMM3000 FC, SN: 26150028.

4.4.1 Results

As originally tested, the EUT was found to be compliant to the requirements of the test standard(s).

Table 5: Band Edge Requirements – Test Results

Test Conditions: Conducted Measurement, Normal Temperature and Voltage only				
Antenna Type: Chip Antenna		Power Setting: Fixed.		
Max. Antenna Gain: +3.0 dBi		Signal State: Modulated		
Duty Cycle: 100 %		Data Rate: see below		
Ambient Temp.: 23° C		Relative Humidity: 35 %RH		
-20 dBr Band Edge Results				
Operating Freq.	Mode	Limit (dBm)	Measured Value (dBm)	Result
2402 MHz	1Mbps	-11.30	-51.17	Pass
2442 MHz	1Mbps	-12.15	-59.75	Pass
2480 MHz	1Mbps	-12.40	-57.46	Pass
Note: The stated limits for 20 dBr are relative to each individual output per KDB 662911 Method.				

Out of Band Emission				
Operating Freq.	Mode	Limit (dBm)	Measured Value (dBm)	Result
2402 MHz	1Mbps	-11.30	-41.33 @ 7250MHz	Pass
2442 MHz	1Mbps	-12.15	-43.10 @ 7326 MHz	Pass
2480 MHz	1Mbps	-12.40	-44.16 @ 7440 MHz	Pass

Note: The stated limits are relative to each individual output per KDB 662911 Method.

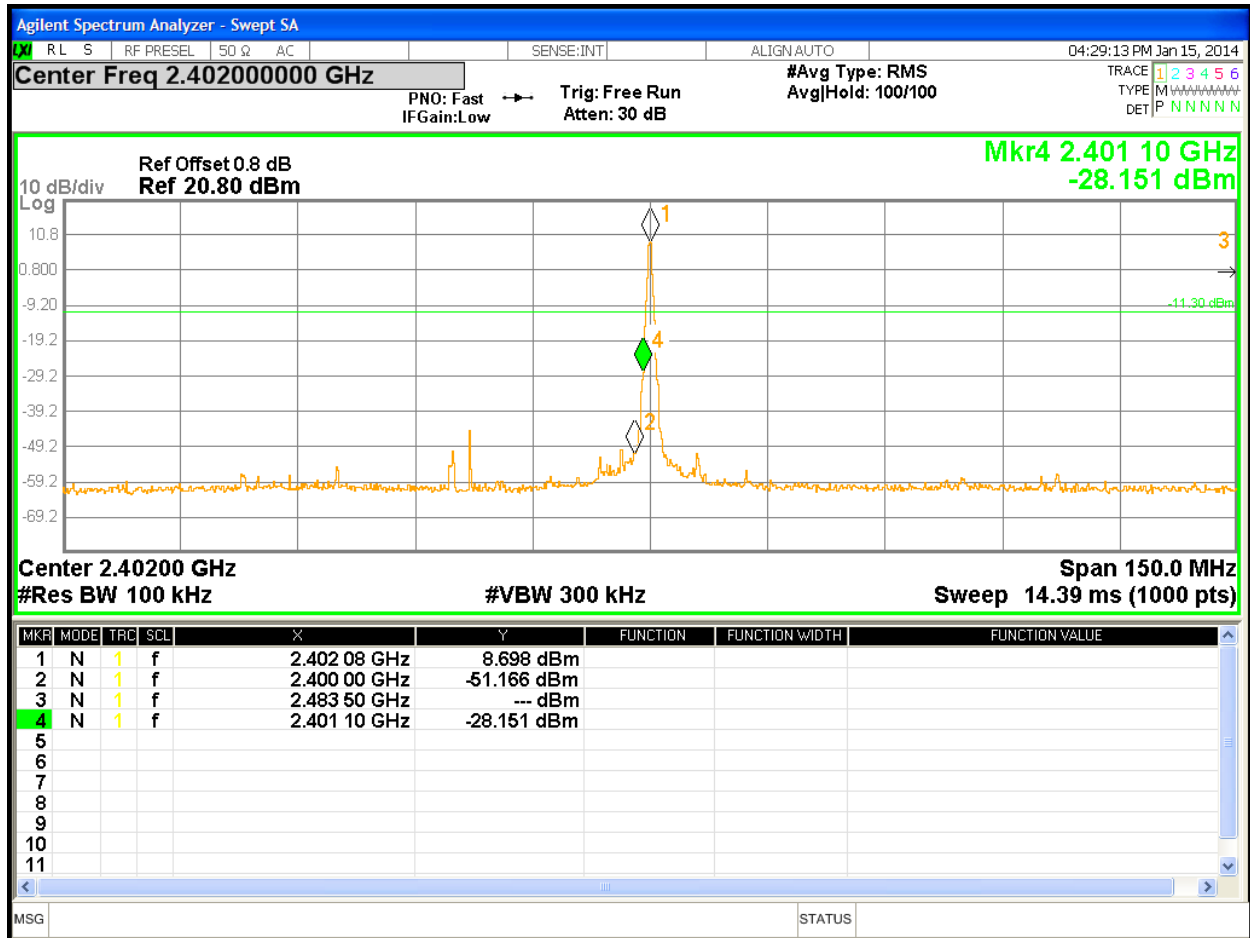

Figure 13: Band Edge Requirements at 2402 MHz

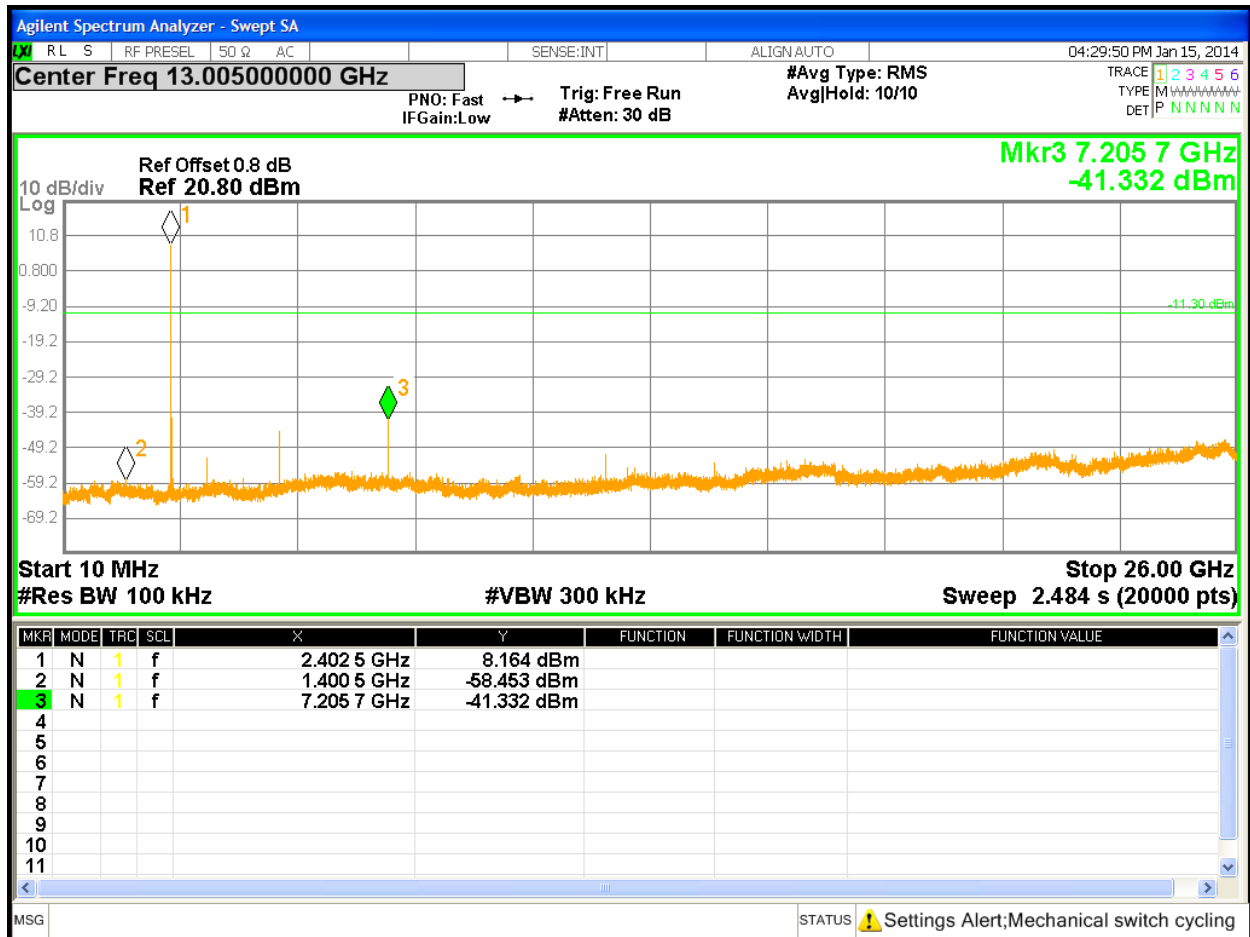

Figure 14: Out of Band Emission Requirements at 2402 MHz

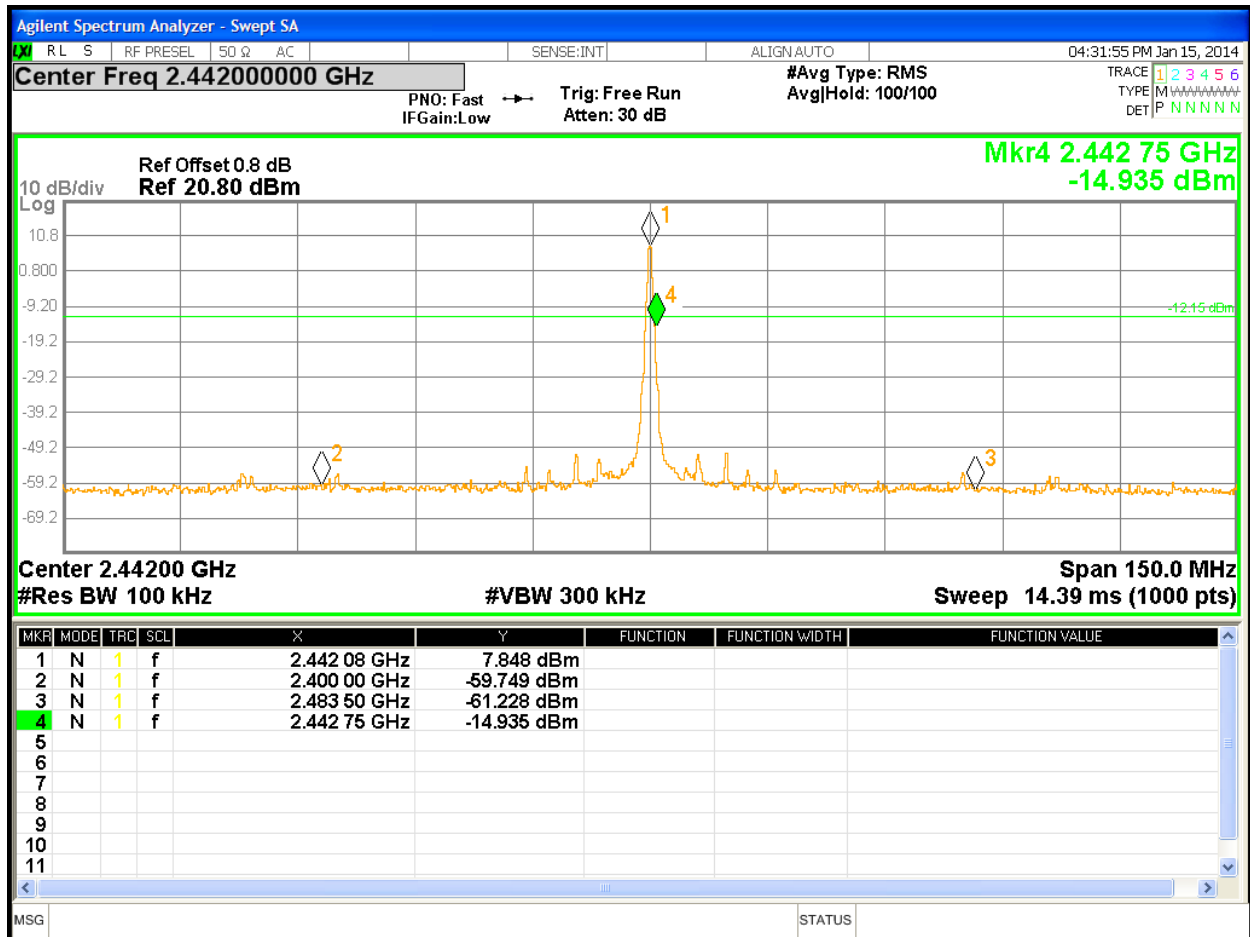

Figure 15: Band Edge Requirements at 2442 MHz

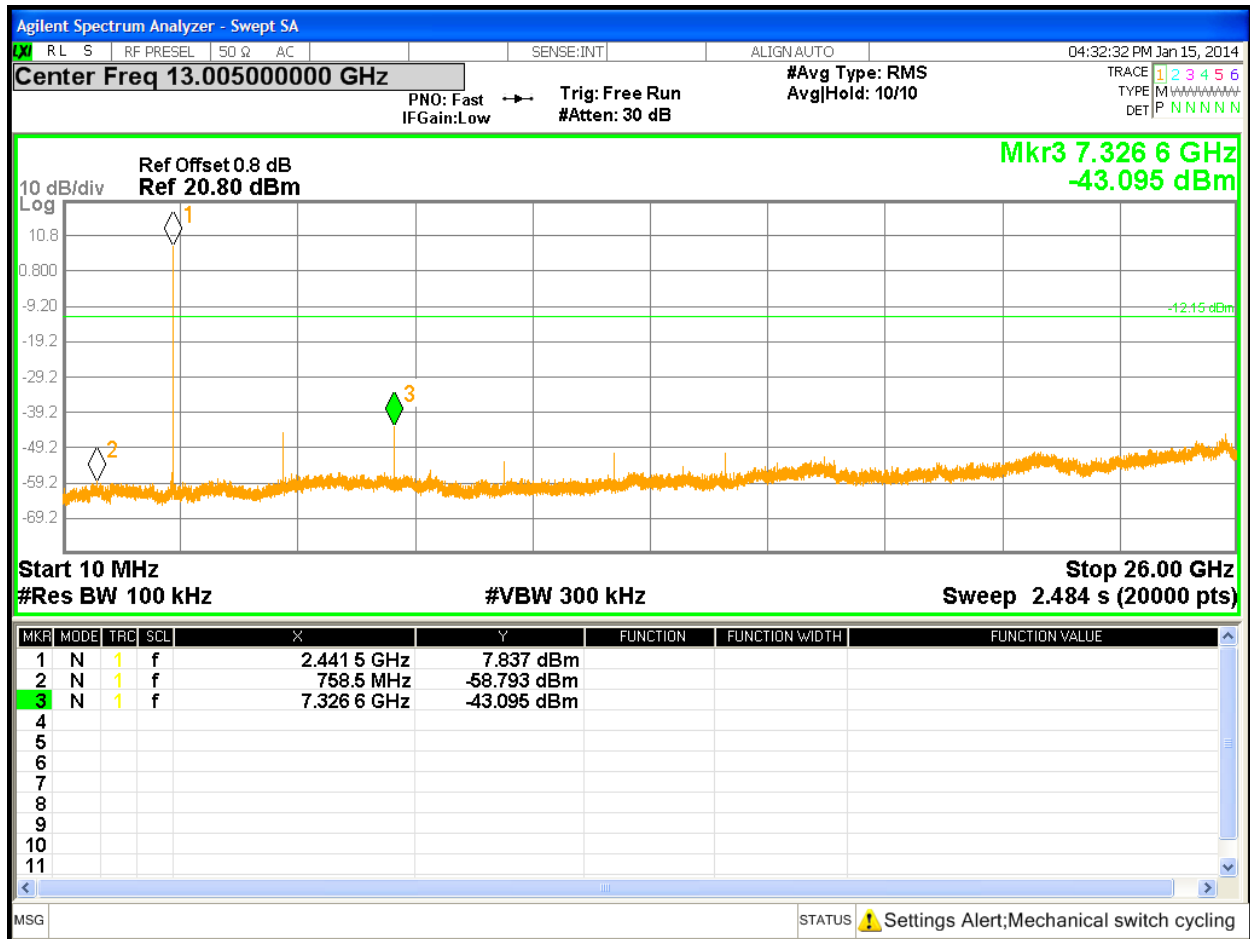

Figure 16: Out of Band Emission Requirements at 2442 MHz

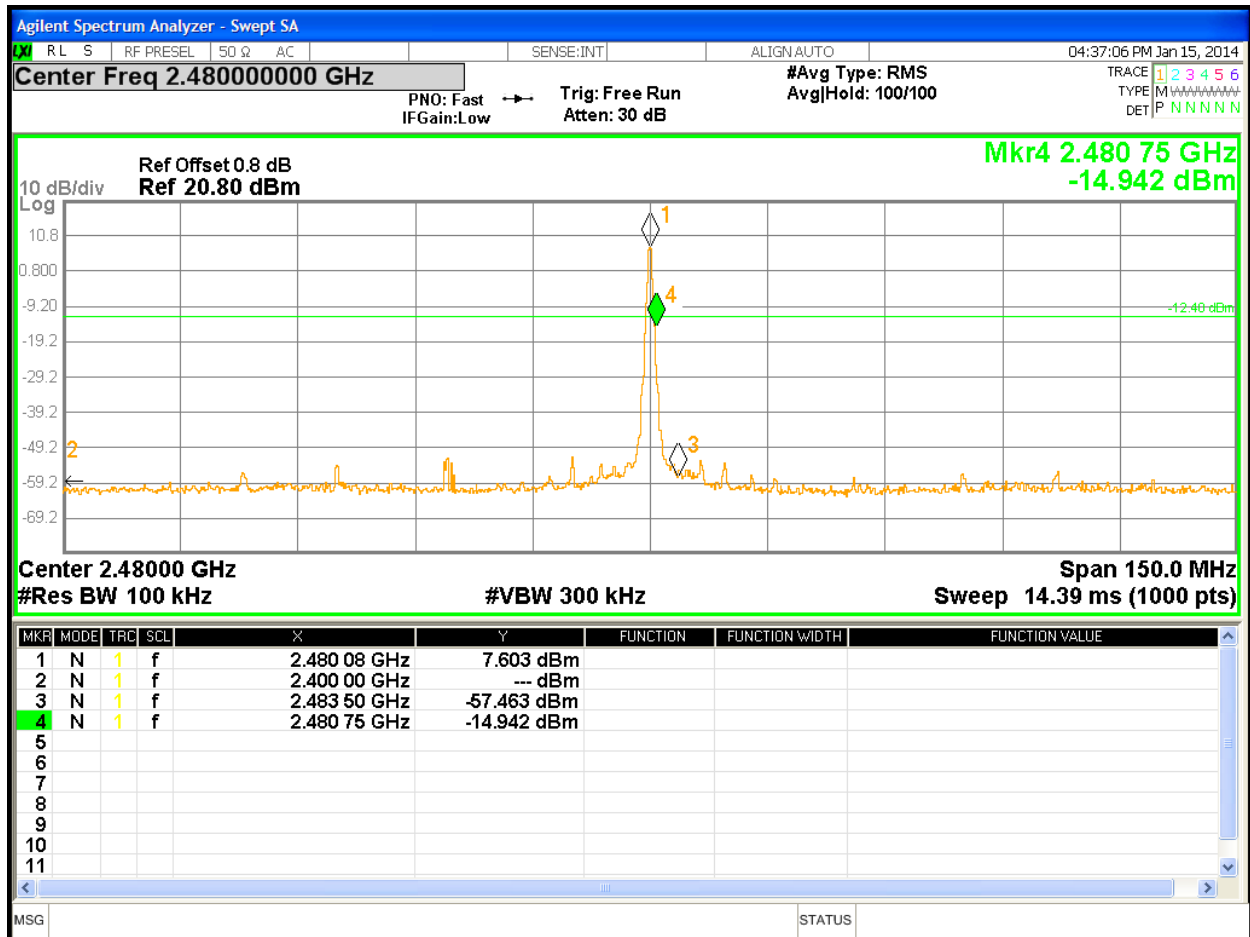

Figure 17: Band Edge Requirements at 2480 MHz

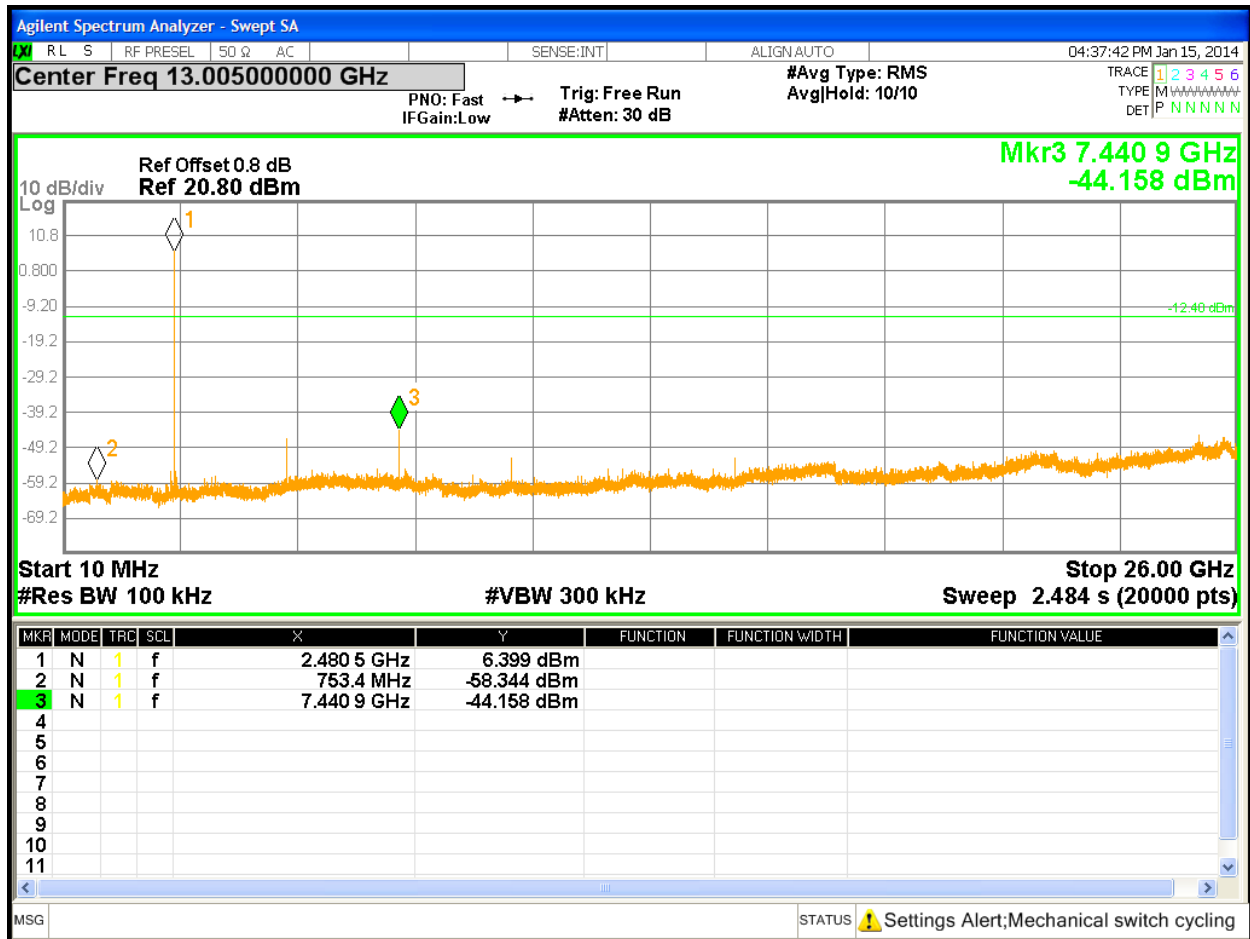

Figure 18: Out of Band Emission Requirements at 2480 MHz

4.5 Maximum RF Exposure

4.5.1 Test Methodology

In this section, we try to prove the safety of radiation harmfulness to the human body for our product. The KDB 447498 D01 General RF Exposure Guidance is followed. The Gain of the antenna used in this calculation is declared by the manufacturer, and the maximum average power input to the antenna is measured. Using the general SAR test exclusion guidance in Section 4.3 of KDB 447498, we show the device meeting the SAR exclusion threshold.

4.5.2 FCC KDB 447498 D01 – General SAR Test Exclusion Guidance

The SAR exclusion threshold conditions are listed:

1) The 1-g and 10-g SAR test exclusion thresholds for 100 MHz to 6 GHz at test separation distances ≤ 50 mm are determined by:

$[(\text{max. power of channel, including tune-up tolerance, mW})/(\text{min. test separation distance, mm})] \cdot [\sqrt{f(\text{GHz})}] \leq 3.0$ for 1-g SAR and ≤ 7.5 for 10-g extremity SAR,16 where

- f(GHz) is the RF channel transmit frequency in GHz
- Power and distance are rounded to the nearest mW and mm before calculation¹⁷
- The result is rounded to one decimal place for comparison

The test exclusions are applicable only when the minimum test separation distance is ≤ 50 mm and for transmission frequencies between 100 MHz and 6 GHz. When the minimum test separation distance is < 5 mm, a distance of 5 mm is applied to determine SAR test exclusion.

2) At 100 MHz to 6 GHz and for test separation distances > 50 mm, the SAR test exclusion threshold is determined according to the following, and as illustrated in Appendix B:18

- a) [Threshold at 50 mm in step 1) + (test separation distance - 50 mm) · (f(MHz)/150)] mW, at 100 MHz to 1500 MHz
- b) [Threshold at 50 mm in step 1) + (test separation distance - 50 mm) · 10] mW at > 1500 MHz and ≤ 6 GHz

3) At frequencies below 100 MHz, the following may be considered for SAR test exclusion, and as illustrated in Appendix C:19

- a) The threshold at the corresponding test separation distance at 100 MHz in step 2) is multiplied by $[1 + \log(100/f(\text{MHz}))]$ for test separation distances > 50 mm and < 200 mm
- b) The threshold determined by the equation in a) for 50 mm and 100 MHz is multiplied by $\frac{1}{2}$ for test separation distances ≤ 50 mm
- c) SAR measurement procedures are not established below 100 MHz. When SAR test exclusion cannot be applied, a KDB inquiry is required to determine SAR evaluation requirements for any test results to be acceptable.

4.5.3 EUT Operating Condition

The software provided by Manufacturer enabled the EUT to transmit data at lowest, middle and highest channel individually.

4.5.4 Classification

The antenna of the product, under normal use condition, is less than 20cm away from the body of the user. This device is classified as a **Portable Device**.

4.5.5 SAR Test Exclusion Threshold

4.5.5.1 Antenna Gain

The transmitting antenna was integrated. The directional antenna gain was 3.0 dBi.

4.5.5.2 SAR Exclusion Threshold Calculation

Mode	Max. Power (dBm)	EIRP (dBm)	Min. Separation Distance (mm)	Cal. Excl. Threshold	1-g SAR Limit	10-g extremity SAR Limit	Result
BLE	9.22	12.22	5	2.633	≤3.0	≤7.5	Exempted

Note:

1. Since EUT can operate at distance less than 50 mm, the minimum distance, 5 mm, was used for calculation per condition #1 of SAR Exclusion Threshold.
2. The maximum output power was taken from Table 2.

4.6 Transmitter Spurious Emissions

Transmitter spurious emissions are emissions outside the frequency range of the equipment when the equipment is in transmitting mode; per requirement of CFR47 15.205, 15.209, 15.247(d), RSS-210 Sect. A.8.5

4.6.1 Test Methodology

4.6.1.1 Preliminary Test

A test program that controls instrumentation and data logging was used to automate the preliminary RF emission test procedure. The frequency range of interest was divided into sub-ranges to yield a frequency resolution of approximately 120 kHz and provide a reading at each frequency for no more than 12° of turntable rotation. For each frequency sub-range the turntable was rotated 360° while peak emission data was recorded and plotted over the frequency range of interest in horizontal and vertical antenna polarization's.

Preliminary emission profile testing was performed inside the anechoic chamber. The EUT was placed on a 1.0m x 1.5m non-conductive table 80cm above the floor. The EUT was positioned as shown in the setup photographs. The receiving antenna was placed at a distance of 3m at a fixed height of 1m. Measurement equipment was located outside of the chamber. A video camera was placed inside the chamber to view the EUT.

4.6.1.2 Final Test

For each frequency measured, the peak emission was maximized by manipulating the receiving antenna from 1 to 4 meters above the ground plane and placing it at the position that produced the maximum signal strength reading. The turntable was then rotated through 360° while observing the peak signal and placing the EUT at the position that produced maximum radiation. The six highest emissions relative to the limit were measured unless such emissions were more than 20 dB below the limit. If less than six emissions are within 20 dB of the limit, than the noise level of the receiver is measured at frequencies where emissions are expected. Multiples of all oscillator and microprocessor frequencies were also checked.

Final testing was performed on an NSA compliant test site. The EUT was placed on a 1.0m x 1.5m non-conductive table 80cm above the ground plane. The placement of EUT and cables were the same as for preliminary testing and is shown in the setup photographs.

The final scans performed on the worst axis, X-Axis, for three operating channels: 2402 MHz, 2442 MHz, and 2480 MHz at 1 Mbit/s.

4.6.1.3 Deviations

None.

4.6.2 Transmitter Spurious Emission Limit

The spurious emissions of the transmitter shall not exceed the values in CFR47 Part 15.205, 15.209:2013 and RSS-210 A1.1.2 2010.

Frequency (MHz)	Field strength (microvolts/meter)	Measurement distance (meters)
0.009-0.490	2400/F (kHz)	300
0.490-1.705	24000/F (kHz)	30
1.705-30.0	30	30
30-88	100 **	3
88-216	150 **	3
216-960	200 **	3
Above 960	500	3

All harmonics and spurious emission which are outside of the restricted band shall be 20 dB below the in-band emission.

4.6.3 Test Results

The final measurement data was taken under the worst case operating modes, configurations, and/or cable positions. It also reflects the results including any modifications and/or special accessories listed in Sections 1.4 and Test Plan.

As originally tested, the EUT was found to be compliant to the requirements of the test standard(s).

Table 6: Transmit Spurious Emission at Restricted Band Edge Requirements

Test Conditions: Radiated Measurement at 3 meters								
Antenna Type: Chip Antenna					Power Setting: Fixed.			
Max. Antenna Gain: +3.0 dBi					Signal State: Modulated			
Duty Cycle: 100 %					Data Rate: see below			
Ambient Temp.: 23° C					Relative Humidity: 38 %RH			
Band Edge Results								
Freq. MHz	Level dBuV/m	Pol. V/H	15.209/15.247 Limit Margin		Detector Pk/QP/Avg	Azimuth degrees	Height meters	Comments
2390	58.26	V	74.00	-15.74	Pk	207	342	TX at 2402 MHz, 1Mbps
2390	37.33	V	54.00	-16.67	Ave	207	342	TX at 2402 MHz, 1Mbps
2390	57.78	H	74.00	-16.22	Pk	185	100	TX at 2402 MHz, 1Mbps
2390	36.64	H	54.00	-17.36	Ave	185	100	TX at 2402 MHz, 1Mbps
2483.5	56.65	V	74.00	-17.35	Pk	133	328	TX at 2480 MHz, 1Mbps
2483.5	38.18	V	54.00	-15.82	Ave	133	328	TX at 2480 MHz, 1Mbps
2483.5	57.71	H	74.00	-16.29	Pk	184	137	TX at 2480 MHz, 1Mbps
2483.5	41.06	H	54.00	-12.94	Ave	184	137	TX at 2480 MHz, 1Mbps

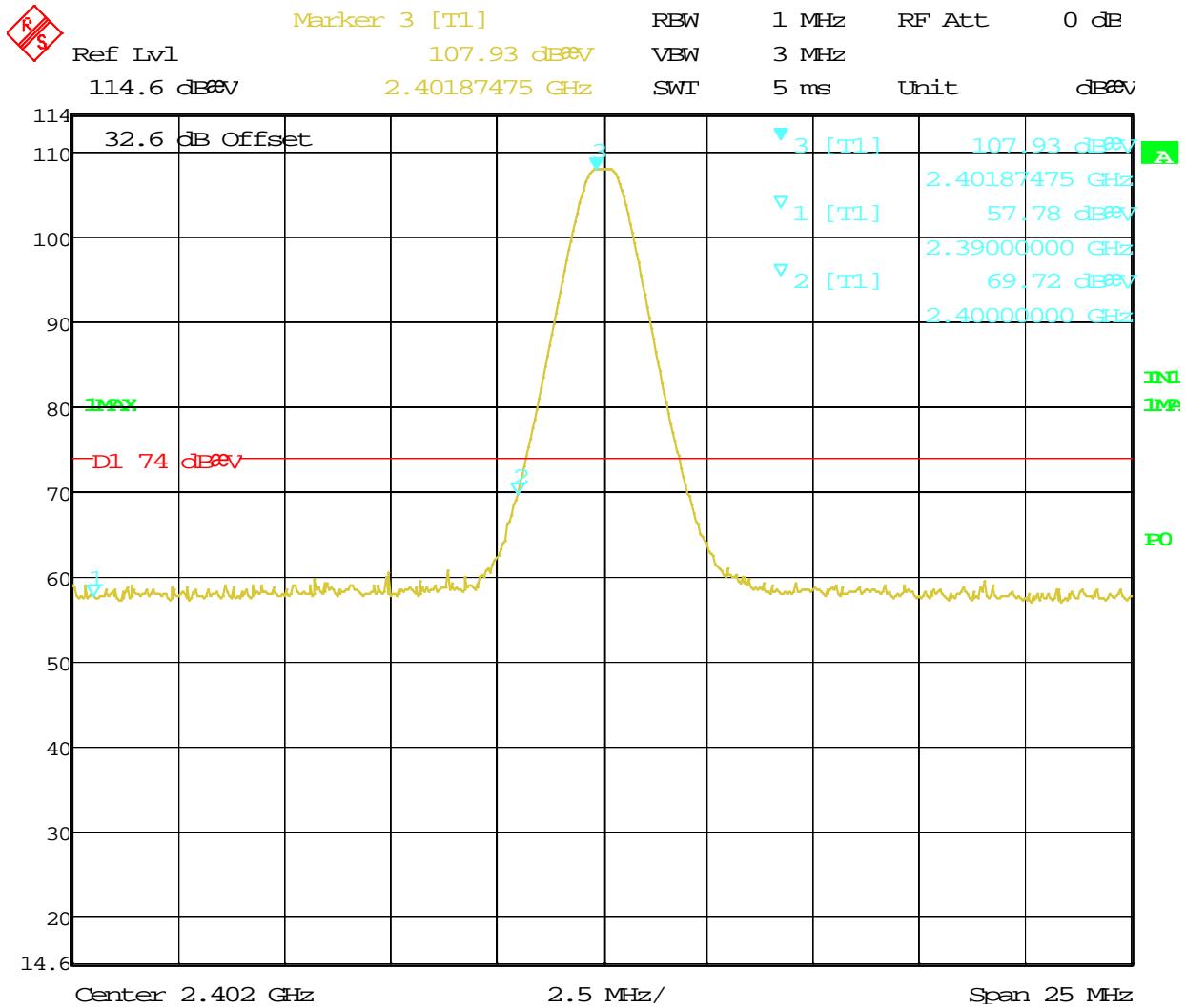

Date: 12.JAN.2014 14:43:45

Figure 19: Radiated Emission at the Edge for Channel 2402 MHz at 1Mbps – Horizontal (Peak)

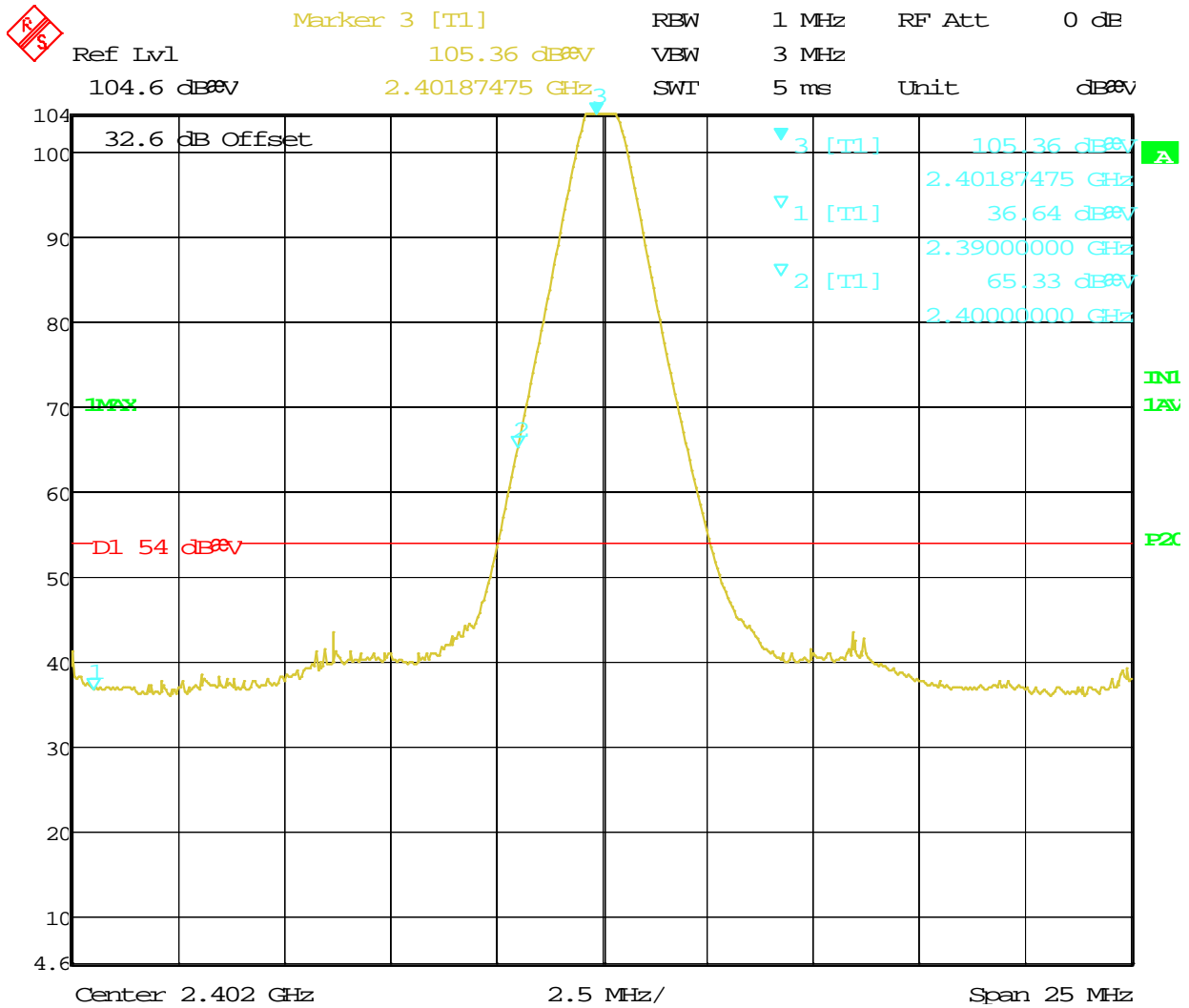
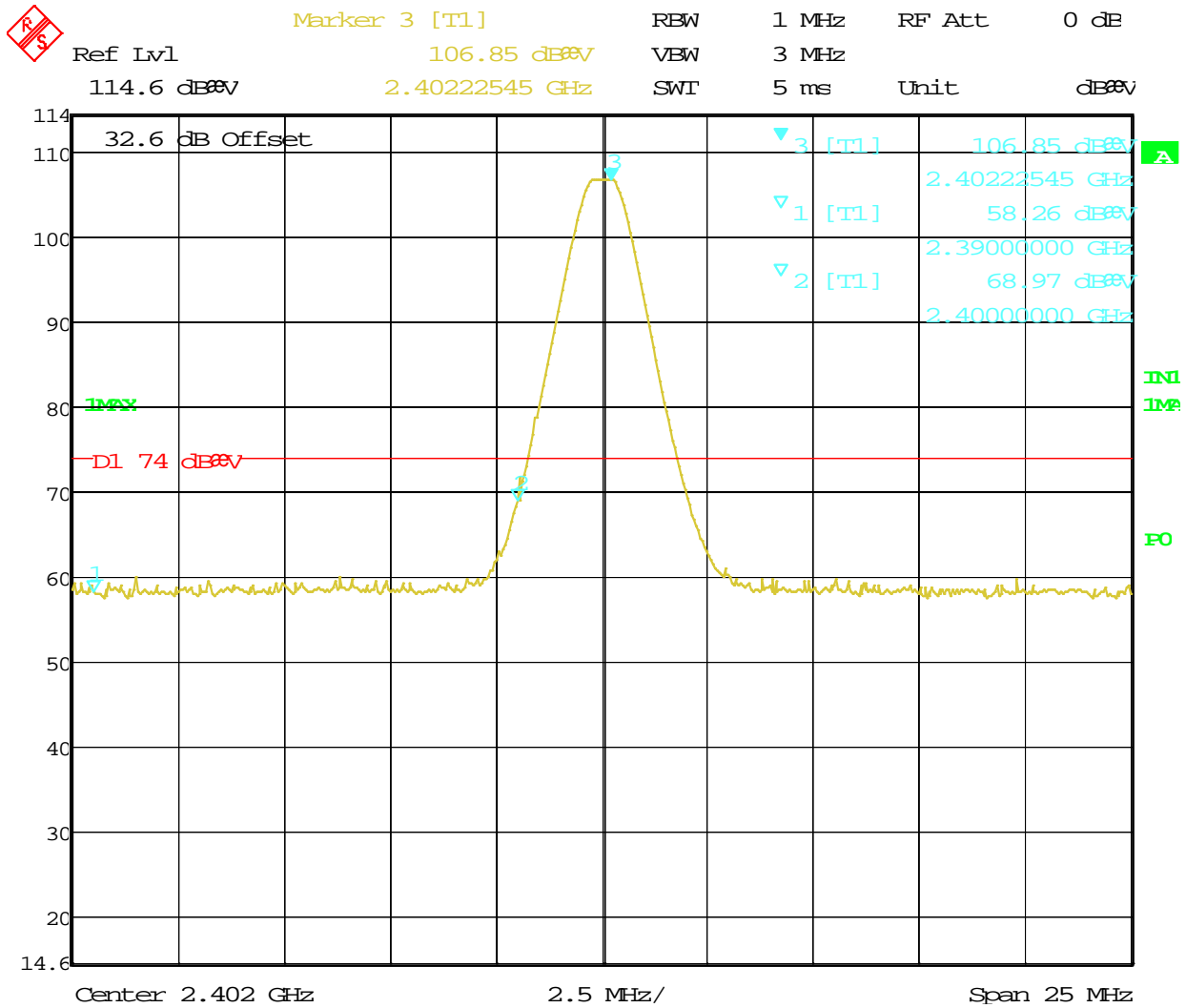
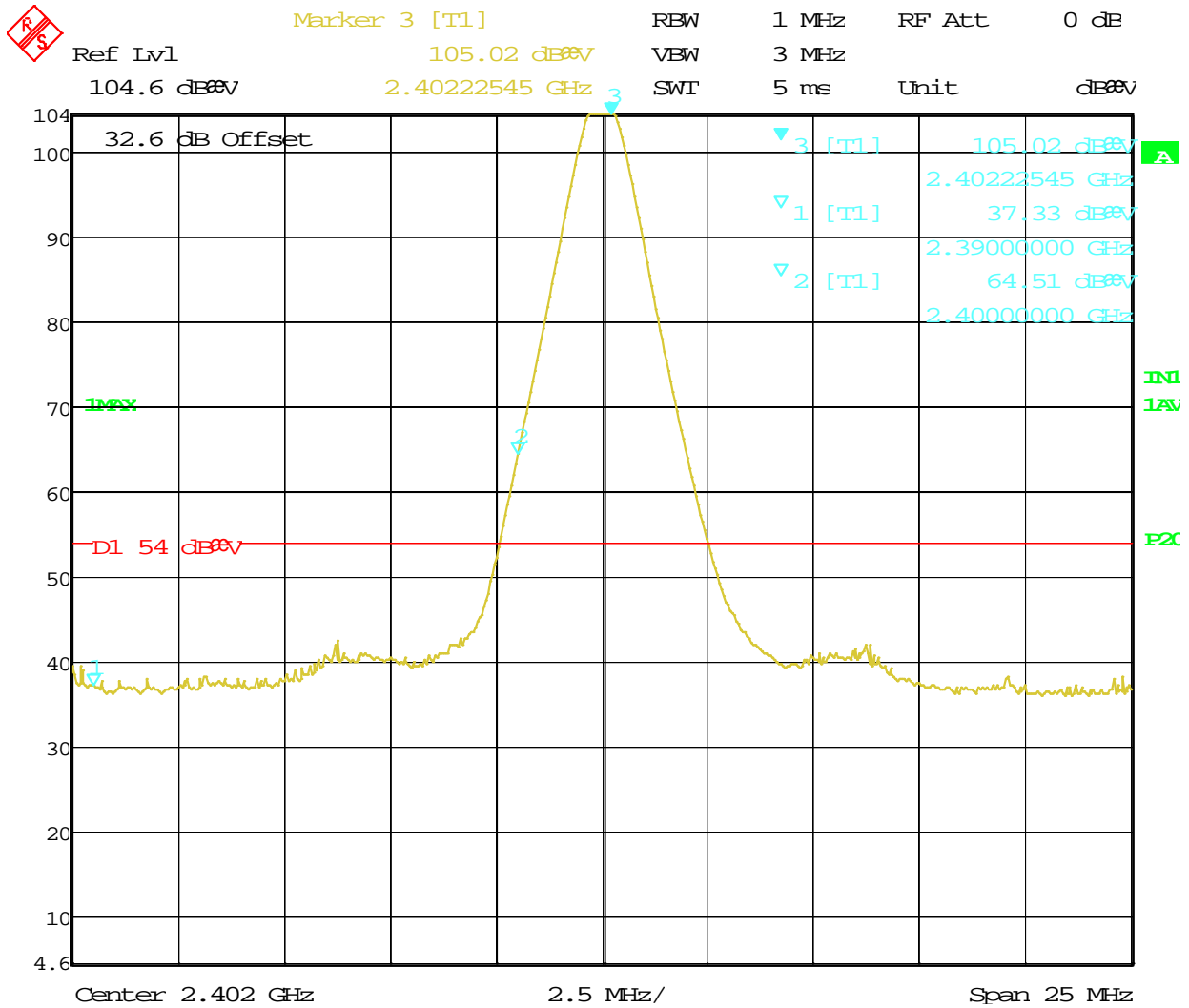

Figure 20: Radiated Emission at the Edge for Channel 2402 MHz at 1Mbps – Horizontal (Avg)



Date: 12.JAN.2014 14:40:09

Figure 21: Radiated Emission at the Edge for Channel 2402 MHz at 1Mbps – Vertical (Pk)



Date: 12.JAN.2014 14:41:12

Figure 22: Radiated Emission at the Edge for Channel 2402 MHz at 1Mbps – Vertical (avg)

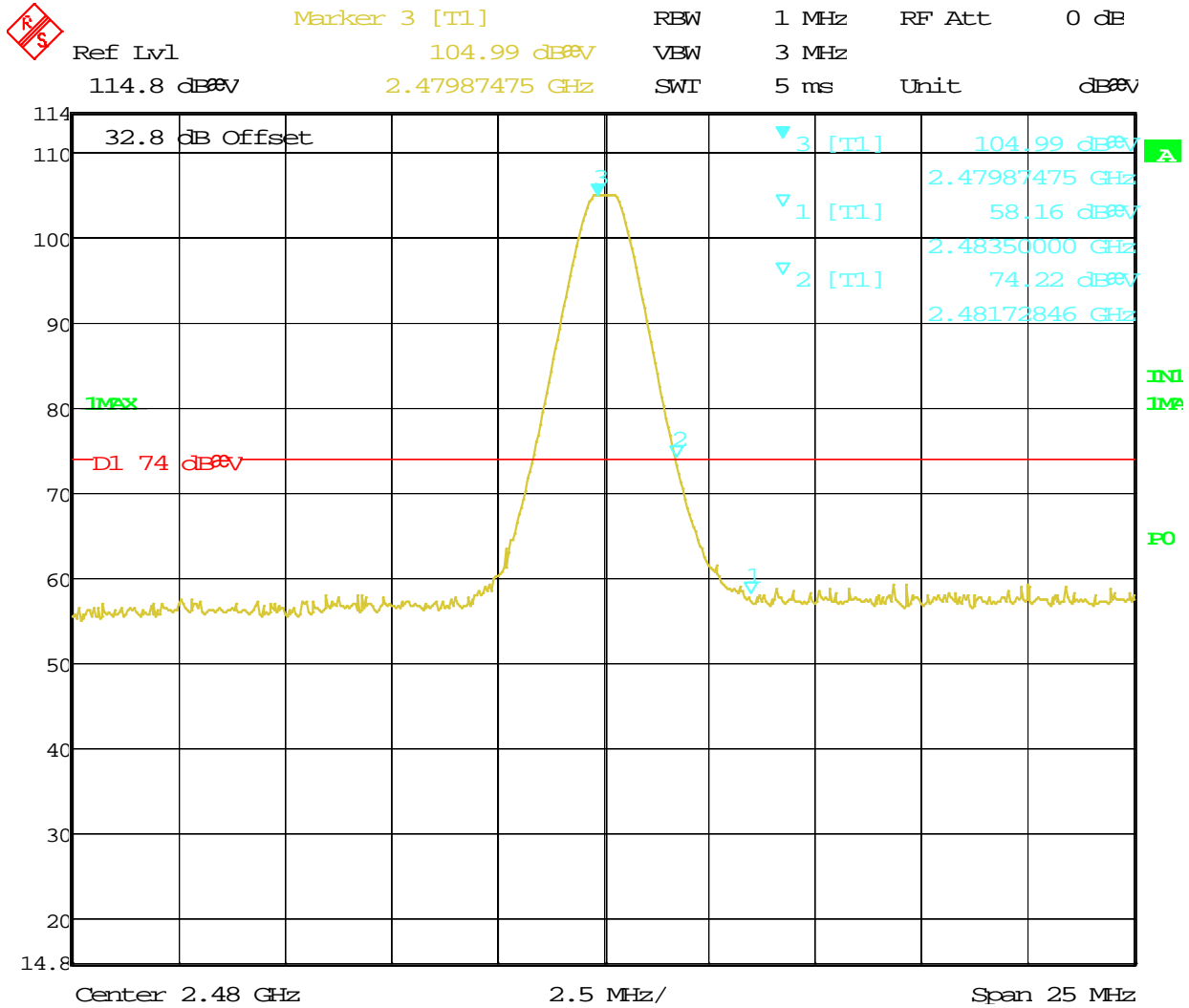

Date: 12.JAN.2014 14:57:46

Figure 23: Radiated Emission at the Edge for Channel 2480 MHz at 1Mbps – Horizontal (Pk)

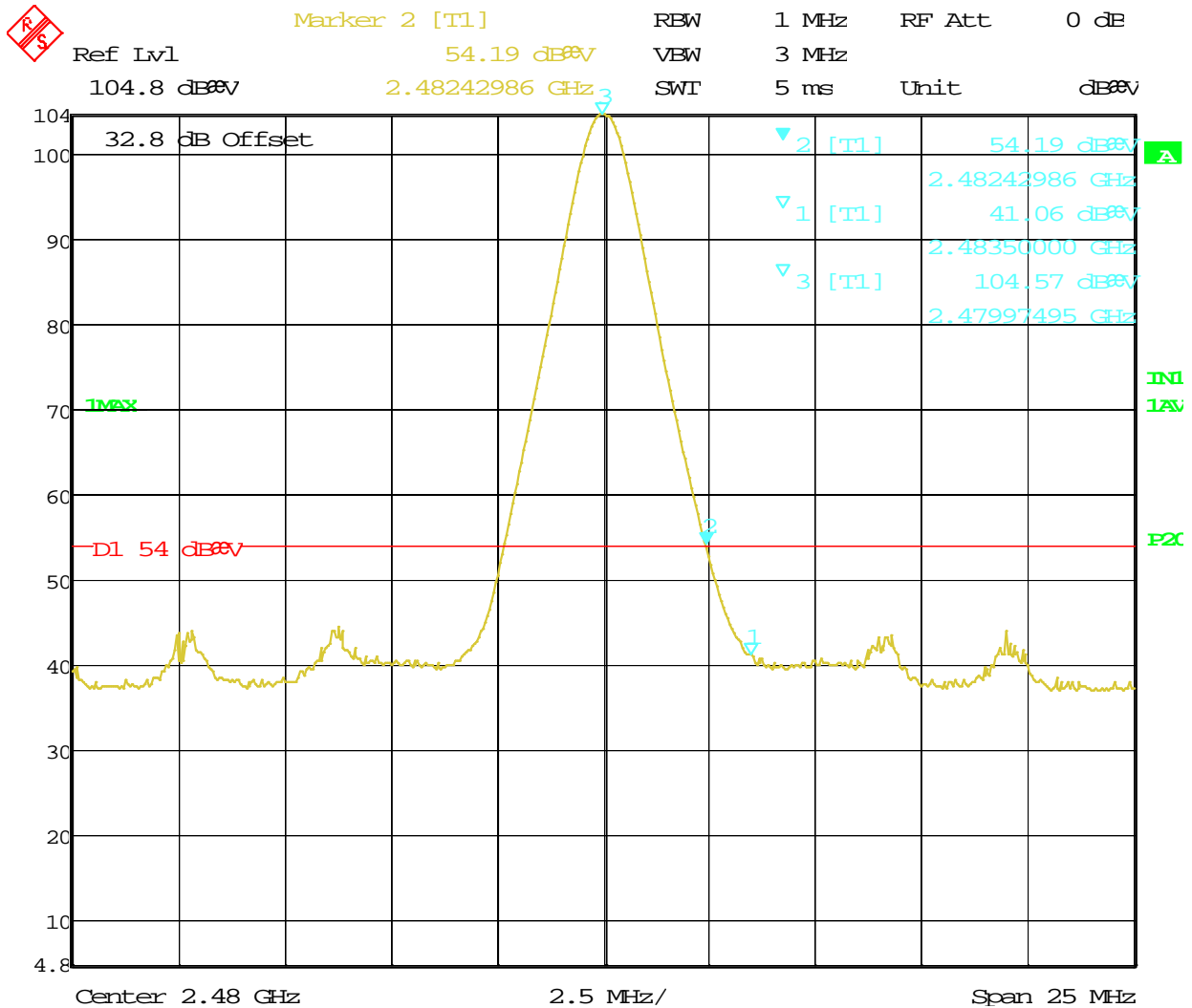

Date: 12.JAN.2014 14:59:03

Figure 24: Radiated Emission at the Edge for Channel 2480 MHz at 1Mbps – Horizontal (Avg)

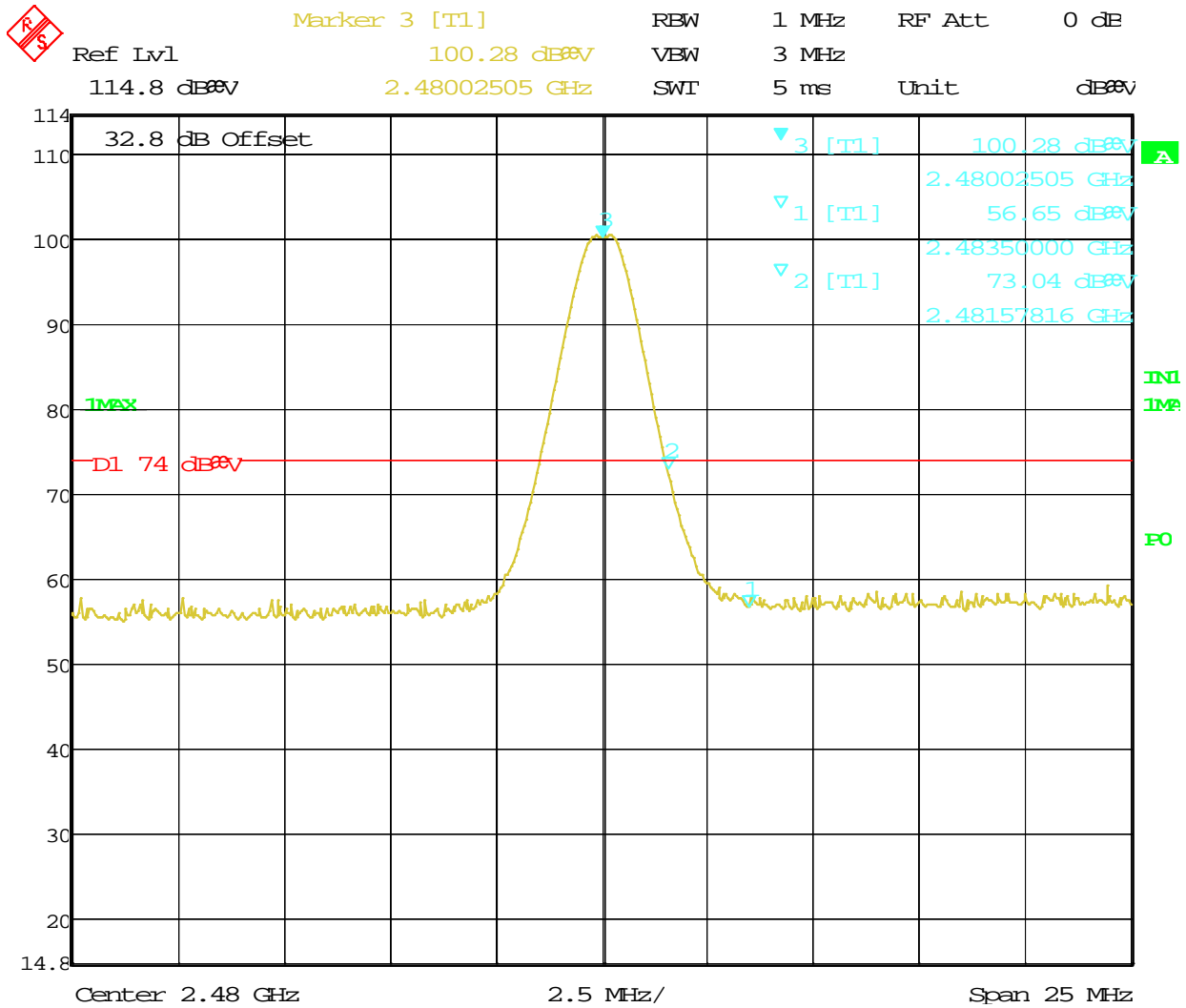

Date: 12.JAN.2014 15:02:20

Figure 25: Radiated Emission at the Edge for Channel 2480 MHz at 1Mbps – Vertical (Pk)

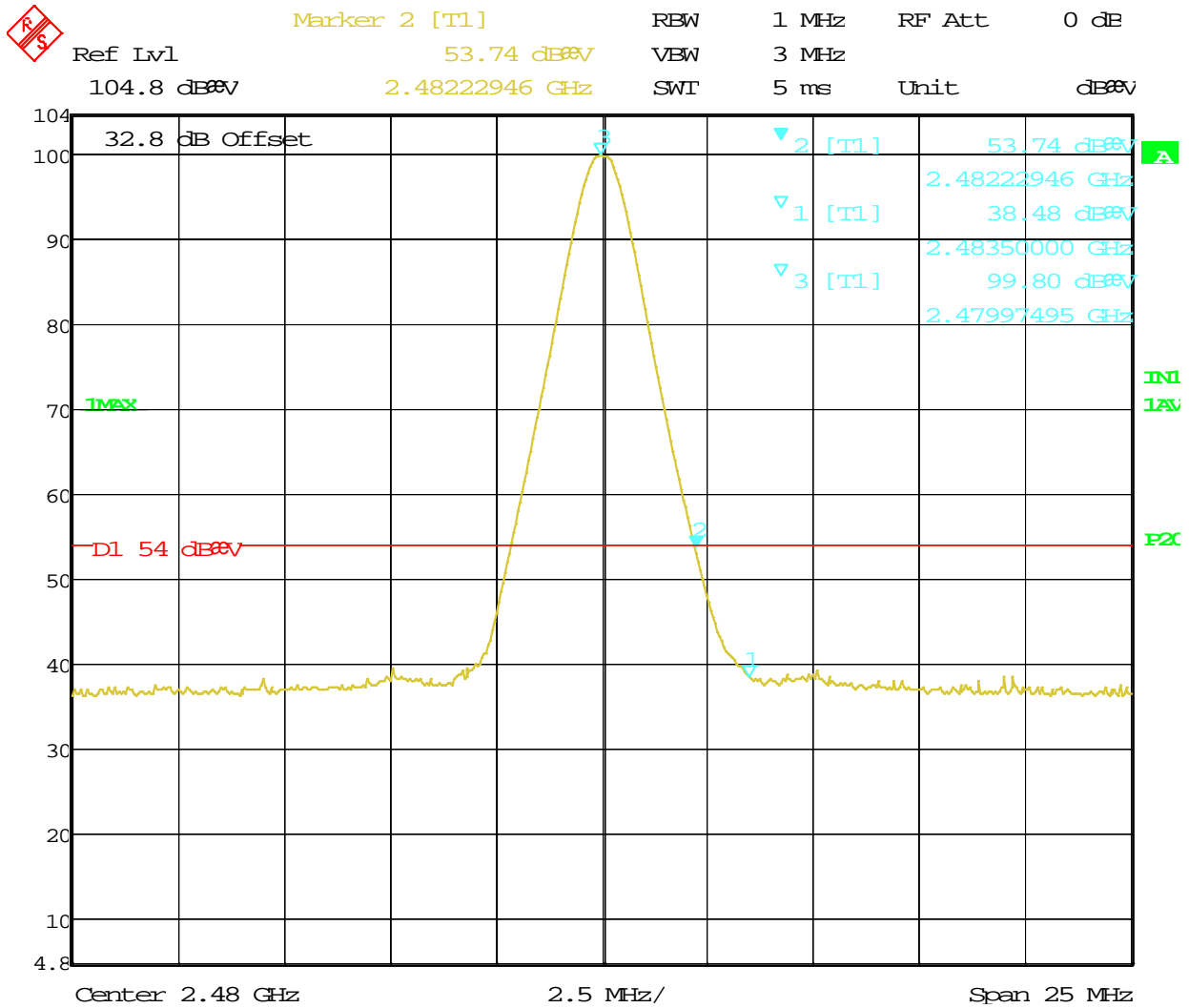

Date: 12.JAN.2014 15:03:02

Figure 26: Radiated Emission at the Edge for Channel 2480 MHz at 1Mbps – Vertical (Avg)

SOP 1 Radiated Emissions						Tracking # 31460300.001 Page 1 of 6					
EUT Name	Wireless Multimeter					Date	February 12, 2014				
EUT Model	DMM3000 FC					Temp / Hum in	23°C / 38%rh				
EUT Serial	26150025					Temp / Hum out	N/A				
EUT Comfit.	Integrated Antenna on X-Axis					Line AC / Freq	4.5 V (batteries)				
Standard	CFR47 Part 15 Subpart C					RBW / VBW	120KHz/300KHz				
Dist/Ant Used	3m /JB3					Performed by	Jeremy Luong				

30 -1000 MHz radiated emission at 2442 MHz											
Freq	Raw	Cable	AF	Level	Detector	Pol	Hgt	Azt	Limit	Margin	Result
MHz	dBuV/m	dB	dB	dBuV/m	QP	-	cm	Deg	dBuV	dB	
33.15	36.94	0.62	-7.94	29.62	QP	V	118	12	40.00	-10.38	Pass
38.68	37.76	0.67	-12.39	26.04	QP	V	110	22	40.00	-13.96	Pass
42.54	35.94	0.71	-15.23	21.42	QP	V	99	64	40.00	-18.58	Pass
51.42	40.18	0.78	-19.40	21.56	QP	V	117	76	40.00	-18.44	Pass
119.99	42.45	1.22	-13.24	30.43	QP	V	102	178	43.50	-13.07	Pass
132.00	37.05	1.29	-13.29	25.05	QP	V	120	166	43.50	-18.45	Pass

Spec Margin = Level – Limit, Level = Raw + Cable + AF ± Uncertainty
 AF= Amp Gain + ANT Factor

Combined Standard Uncertainty $u_c(y) = \pm 3.2$ dB Expanded Uncertainty $U = k u_c(y)$ $k = 2$ for 95% confidence

Note 1. Pre-scan performed on 3 orientations, and the worst case was observed on X-Axis .

SOP 1 Radiated Emissions

Tracking # 31460300.001 Page 2 of 6

EUT Name	Wireless Multimeter	Date	February 12, 2014
EUT Model	DMM3000 FC	Temp / Hum in	23°C / 38%rh
EUT Serial	26150025	Temp / Hum out	N/A
EUT Comfit.	Integrated Antenna on X-Axis	Line AC / Freq	4.5 V (batteries)
Standard	CFR47 Part 15 Subpart C	RBW / VBW	120KHz/300KHz
Dist/Ant Used	3m /JB3	Performed by	Jeremy Luong

30 to 1000 MHz Plots for Transmit Mode at 2442 MHz, 1Mbit/s

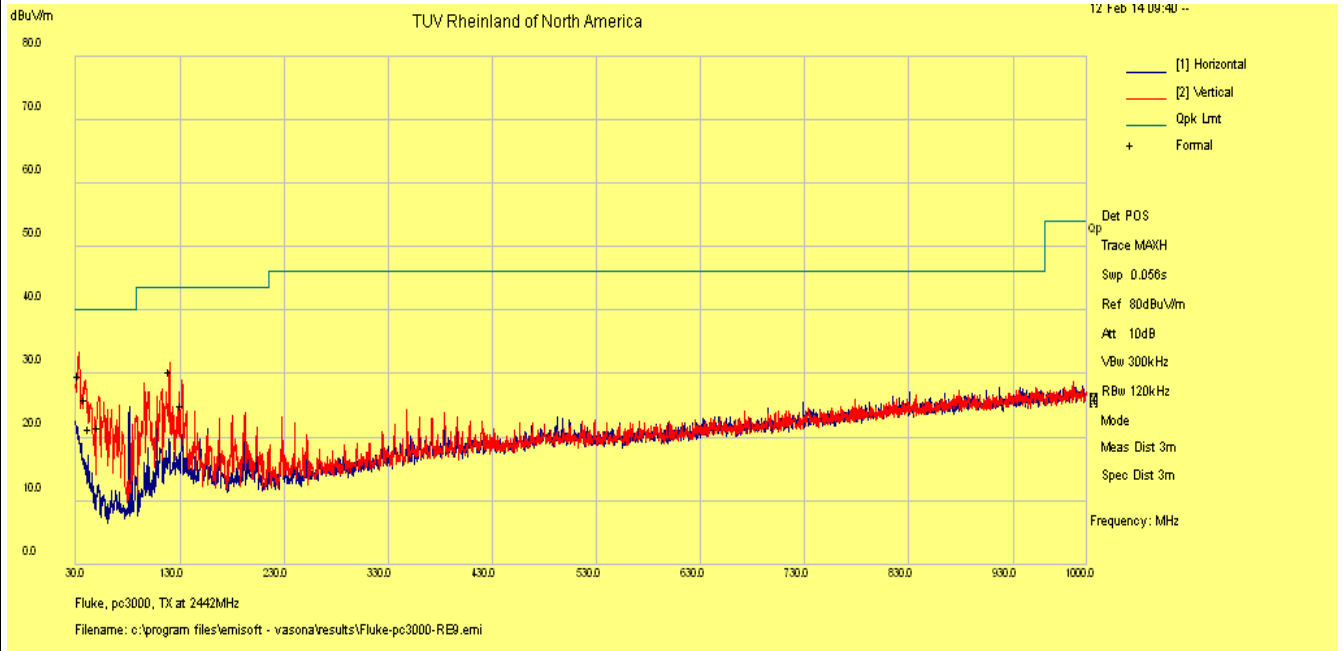

Note: Plot was scanned in the peak mode.

SOP 1 Radiated Emissions				Tracking # 31460300.001 Page 3 of 6			
EUT Name	Wireless Multimeter			Date	February 12, 2014		
EUT Model	DMM3000 FC			Temp / Hum in	22°C / 31%rh		
EUT Serial	26150025			Temp / Hum out	N/A		
EUT Comfit.	Integrated Antenna on X-Axis			Line AC / Freq	4.5 V (batteries)		
Standard	CFR47 Part 15 Subpart C			RBW / VBW	120KHz/300KHz		
Dist/Ant Used	3m – DRH-118 / 1m - RA42-K-F-4B-C			Performed by	Jeremy Luong		

Above 1GHz Radiated Emission at 2402 MHz, 1 Mbps												
Freq MHz	Raw dBuV/m	Cbl dB	AF dB	Duty dB	Level dBuV/m	Det. Pk/Ave	Pol -	Hgt cm	Azt Deg	Limit dBuV	Margin dB	Note -
12010.23	70.32	6.65	-11.52	-20.0	45.45	Pk	H	126	137	54.00	-8.55	Pass*
14413.10	58.87	7.40	-8.74	-20.0	37.53	Pk	H	157	5	54.00	-16.47	Pass*
16813.25	50.61	8.17	-8.13	-20.0	30.65	Pk	H	176	-1	54.00	-23.35	Pass*
4803.76	79.12	4.41	-17.40	-20.0	46.13	Pk	V	322	197	54.00	-7.87	Pass*
7205.65	70.44	5.23	-11.70	-20.0	43.97	Pk	V	318	131	54.00	-10.03	Pass*
9608.85	58.02	5.95	-8.49	-20.0	35.48	Pk	V	317	39	54.00	-18.52	Pass*
19217.65	49.87	8.00	3.60	-20.0	41.47	Pk	H	100	11	64.00	-22.53	Pass*
24021.86	51.32	9.60	2.80	-20.0	43.72	Pk	H	100	353	64.00	-20.28	Pass*

Above 1GHz Radiated Emission at 2442 MHz, 1 Mbps												
Freq MHz	Raw dBuV/m	Cbl dB	AF dB	Duty dB	Level dBuV/m	Det. Pk/Ave	Pol -	Hgt cm	Azt Deg	Limit dBuV	Margin dB	Note -
14653.16	63.20	7.50	-7.32	-20.0	43.38	Pk	H	360	11	54.00	-10.62	Pass*
4883.72	79.52	4.41	-17.16	-20.0	46.77	Pk	V	112	106	54.00	-7.23	Pass*
7325.61	70.76	5.27	-11.26	-20.0	44.77	Pk	V	106	224	54.00	-9.23	Pass*
9768.74	66.74	6.01	-8.58	-20.0	44.17	Pk	V	136	96	54.00	-9.83	Pass*
12209.31	67.21	6.69	-11.62	-20.0	42.28	Pk	V	155	93	54.00	-11.72	Pass*
14653.06	55.87	7.53	-7.30	-20.0	36.10	Pk	V	361	199	54.00	-17.90	Pass*
19537.34	52.31	8.20	3.70	-20.0	44.21	Pk	V	102	6	64.00	-19.79	Pass*

Above 1GHz Radiated Emission at 2480 MHz, 1 Mbps												
Freq MHz	Raw dBuV/m	Cbl dB	AF dB	Duty dB	Level dBuV/m	Det. Pk/Ave	Pol -	Hgt cm	Azt Deg	Limit dBuV	Margin dB	Note -
4959.73	76.18	4.43	-17.10	-20.0	43.51	Pk	H	263	251	54.00	-10.49	Pass*
14881.09	58.23	7.54	-7.47	-20.0	38.30	Pk	H	317	28	54.00	-15.70	Pass*
4960.40	76.04	4.43	-17.10	-20.0	43.37	Pk	V	327	53	54.00	-10.63	Pass*
7439.66	65.37	5.34	-11.08	-20.0	39.63	Pk	V	338	115	54.00	-14.37	Pass*
9919.45	64.28	6.07	-8.49	-20.0	41.86	Pk	V	293	209	54.00	-12.14	Pass*
12399.38	61.73	6.84	-12.04	-20.0	36.53	Pk	V	318	110	54.00	-17.47	Pass*
24802.01	46.27	9.80	3.20	-20.0	57.70	Pk	H	100	38	64.00	-6.30	Pass*
19844.02	51.52	8.30	3.90	-20.0	43.72	Pk	V	100	42	64.00	-20.28	Pass*
22318.98	44.63	9.10	3.50	-20.0	37.23	Pk	V	100	356	64.00	-26.77	Pass*

Spec Margin = Level – Limit, Level = Raw + Cable + AF ± Uncertainty
 AF= Amp Gain + ANT Factor

Combined Standard Uncertainty $u_c(y) = \pm 3.2$ dB Expanded Uncertainty $U = ku_c(y)$ $k = 2$ for 95% confidence

- Note
1. Pre-scan performed on 3 orientations, and the worst case was observed on X-Axis .
 2. EUT has operating maximum duty cycle less than 0.13%.
 3. Since EUT has low duty cycle, maximum reduction of 20 dB was applied to the peak measurements.
 4. All emissions met restricted band limit.

SOP 1 Radiated Emissions

Tracking # 31460300.001 Page 4 of 6

EUT Name	Wireless Multimeter	Date	February 12, 2014
EUT Model	DMM3000 FC	Temp / Hum in	23°C / 31%rh
EUT Serial	26150025	Temp / Hum out	N/A
EUT Config.	Integrated Antenna on X-Axis	Line AC	4.5 V (batteries)
Standard	CFR47 Part 15 Subpart C	RBW / VBW	1 MHz/ 3 MHz
Dist/Ant Used	3m – DRH-118 / 1m - RA42-K-F-4B-C	Performed by	Jeremy Luong

Above 1 GHz Radiated Emission Plot for Transmit Mode at 2402 MHz, 1Mbit/s

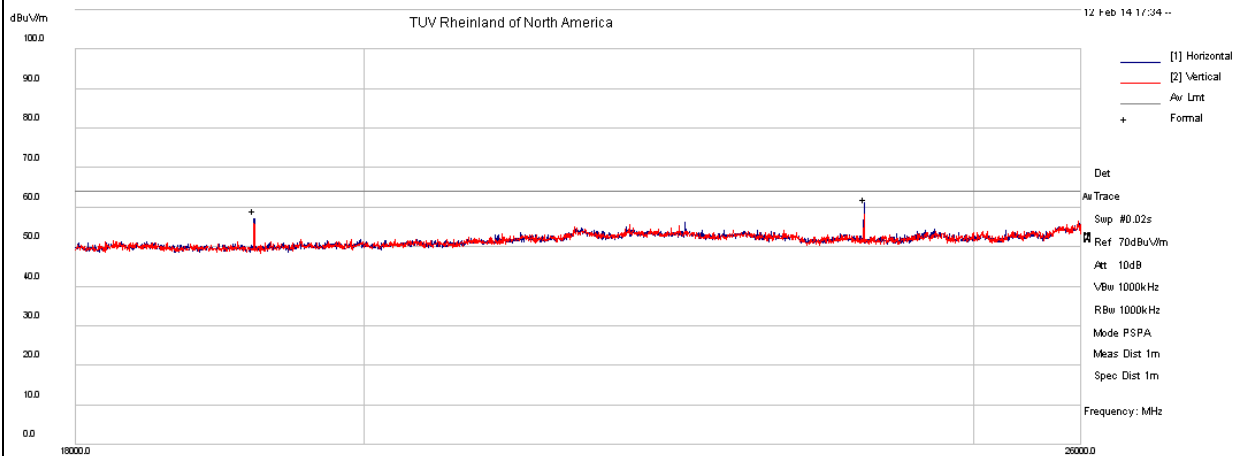
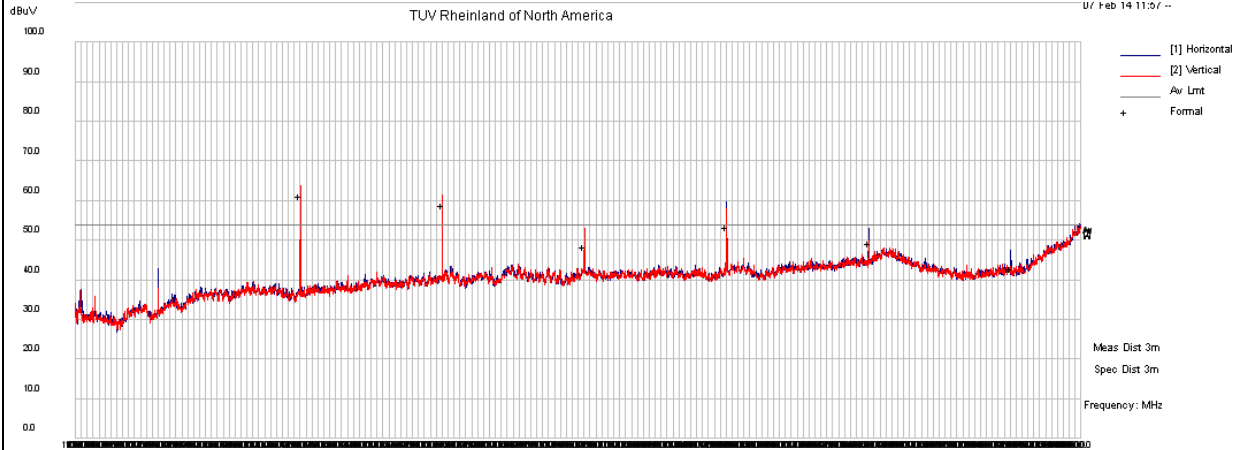

Notes: 1 GHz – 25 GHz was scanned at 1m distance.

SOP 1 Radiated Emissions

Tracking # 31460300.001 Page 5 of 6

EUT Name	Wireless Multimeter	Date	February 12, 2014
EUT Model	DMM3000 FC	Temp / Hum in	23°C / 31%rh
EUT Serial	26150025	Temp / Hum out	N/A
EUT Config.	Integrated Antenna on X-Axis	Line AC	4.5 V (batteries)
Standard	CFR47 Part 15 Subpart C	RBW / VBW	1 MHz/ 3 MHz
Dist/Ant Used	3m – DRH-118 / 1m - RA42-K-F-4B-C	Performed by	Jeremy Luong

Above 1 GHz Radiated Emission Plot for Transmit Mode at 2442 MHz, 1Mbit/s

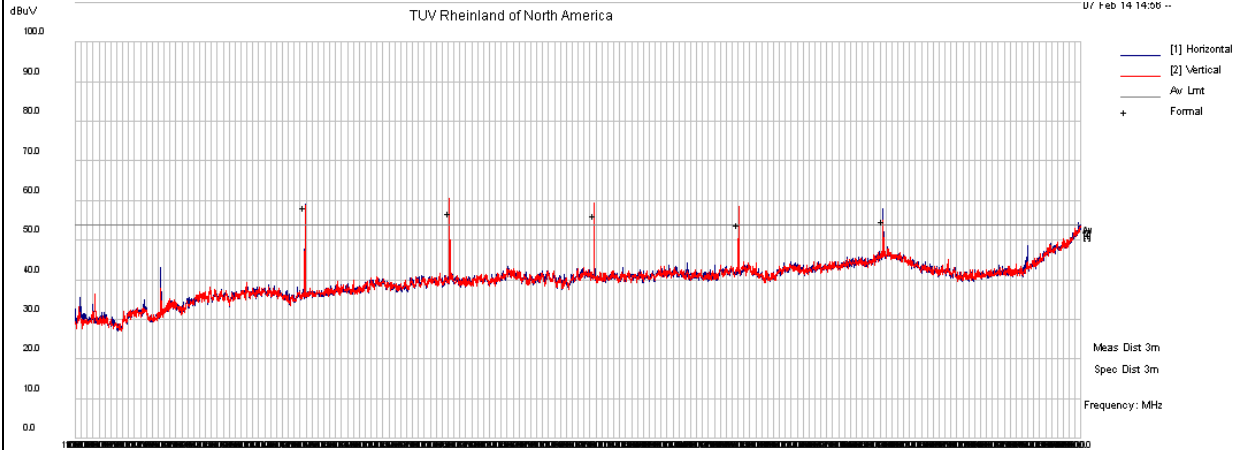

Fluke, DC3000 FC, TX at 2442MHz
 Filename: c:\program files\emisoft - vasona\results\Fluke-DMM3000-RE10.emi

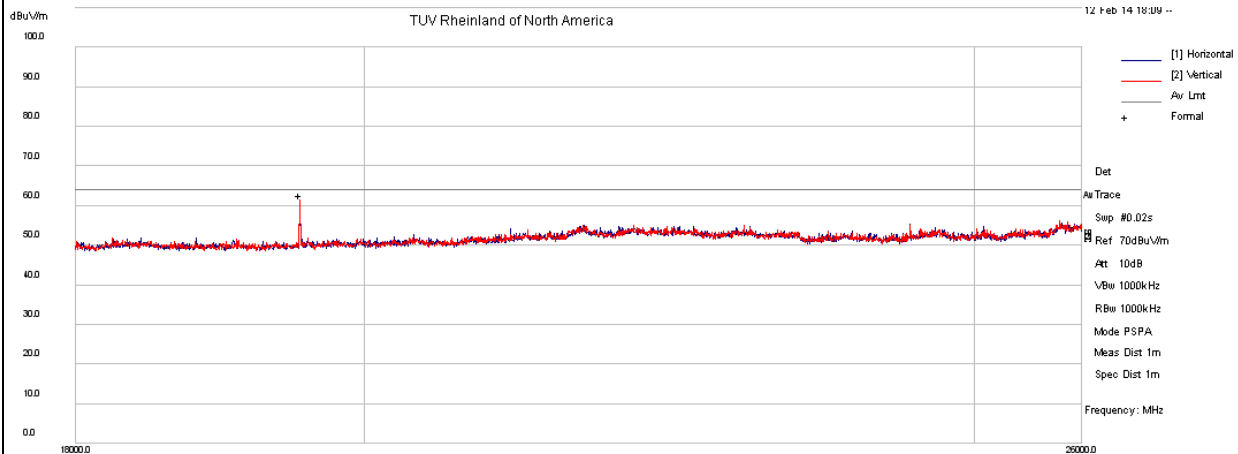

Fluke, DMM3000 FC, TX at 2442 MHz
 Filename: c:\program files\emisoft - vasona\results\Fluke-DMM3000-RE20.emi

Notes: 1 GHz – 25 GHz was scanned at 1m distance.

SOP 1 Radiated Emissions		Tracking # 31460300.001 Page 6 of 6	
EUT Name	Wireless Multimeter	Date	February 11, 2014
EUT Model	DMM3000 FC	Temp / Hum in	23°C / 31%rh
EUT Serial	26150025	Temp / Hum out	N/A
EUT Config.	Integrated Antenna on X-Axis	Line AC	4.5 V (batteries)
Standard	CFR47 Part 15 Subpart C	RBW / VBW	1 MHz/ 3 MHz
Dist/Ant Used	3m – DRH-118 / 1m - RA42-K-F-4B-C	Performed by	Jeremy Luong

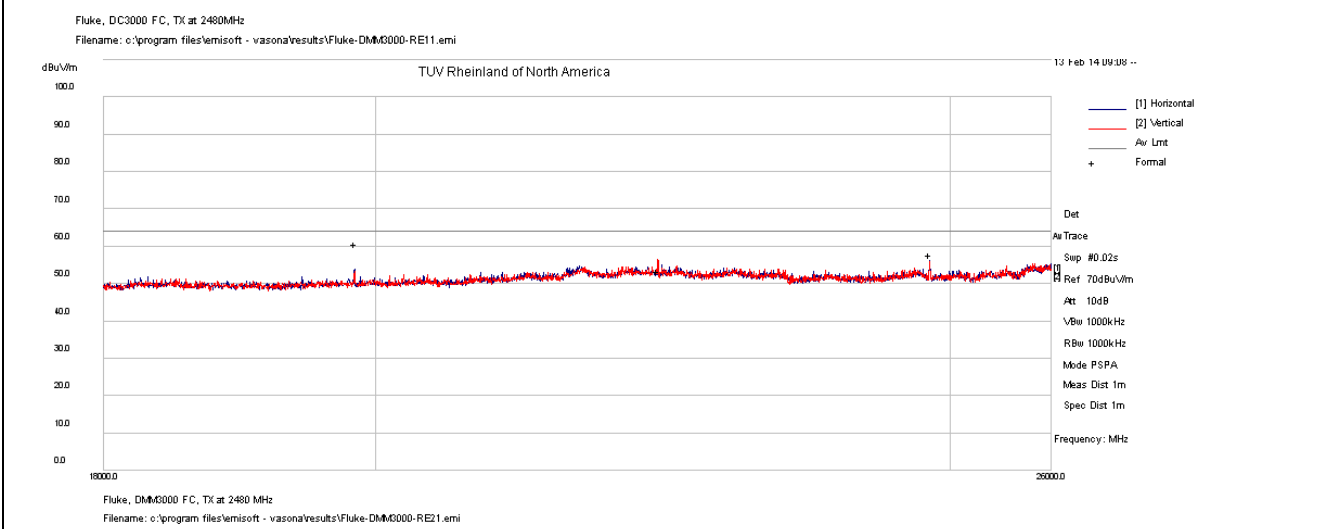
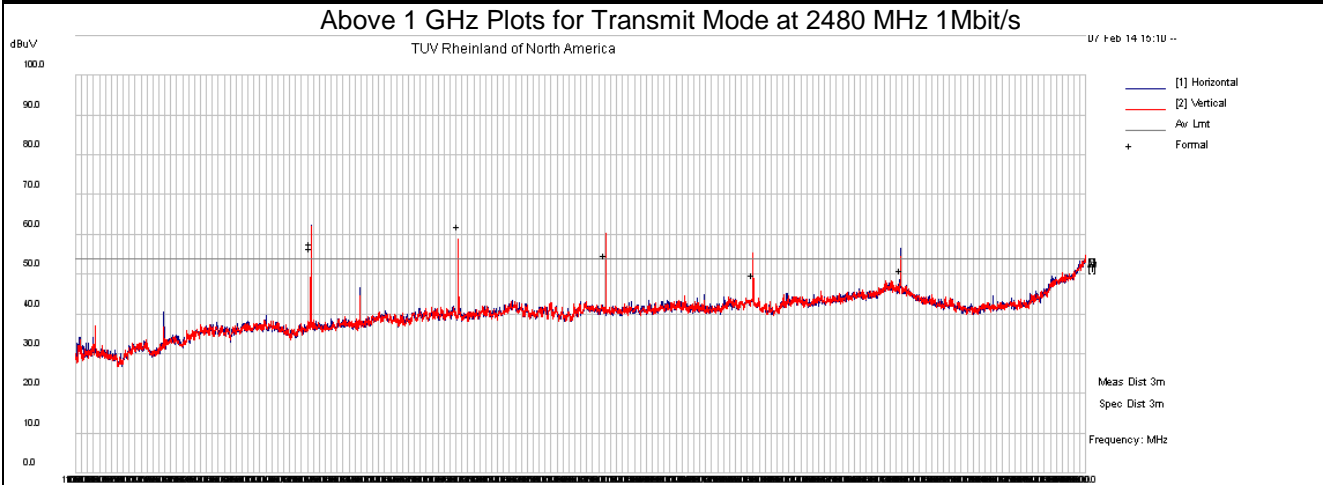

Notes: 1 GHz – 25 GHz was scanned at 1m distance.

4.6.4 Sample Calculation

The field strength is calculated by subtracting the Amplifier Gain and adding the Cable Loss and Antenna Correction Factor to the measured reading. The basic equation is as follows:

$$\text{Field Strength (dB}\mu\text{V/m)} = \text{FIM} - \text{AMP} + \text{CBL} + \text{ACF}$$

Where:

FIM = Field Intensity Meter (dB μ V)

AMP = Amplifier Gain (dB)

CBL = Cable Loss (dB)

ACF = Antenna Correction Factor (dB/m)

$$\mu\text{V/m} = 10^{\frac{\text{dB}\mu\text{V} / \text{m}}{20}}$$

4.7 AC Conducted Emissions

Testing was performed in accordance with ANSI C63.4-2009. These test methods are listed under the laboratory's A2LA Scope of Accreditation.

This test measures the levels emanating from the EUT's AC input port, thus evaluating the potential for the EUT to cause radio frequency interference to other electronic devices.

The AC conducted emissions of equipment under test shall not exceed the values in CFR47 Part 15.207: 2013 and RSS-210: 2010.

4.7.1 Test Methodology

A test program that controls instrumentation and data logging was used to automate the AC Power Line Conducted emission test procedure. The frequency range of interest was divided into sub-ranges such as to yield a frequency resolution of 9 kHz. Each phase and neutral of the AC power line were measured with respect to ground. Measurements were performed using a set of 50 μ H / 50 Ω LISNs.

Testing is either performed in Lab 5. The setup photographs clearly identify which site was used. The vertical ground plane used in the semi-anechoic chamber is a 2m x 2m solid aluminum frame and panel, and it is bonded to the horizontal ground plane.

In the case of tabletop equipment, the EUT is placed on a 1.0m x 1.5m non-conductive table 80cm above the ground plane and 40cm from a vertical ground reference plane. The rear of the EUT was positioned flush with the backside of the table and directly over the LISNs. The power and I/O cables were routed over the edge of the table and bundled approximately 40cm from the ground plane. Support equipment was powered from a separate LISN.

4.7.2 Deviations

There were no deviations from this test methodology.

4.7.3 Test Results

This Test is not applicable since EUT is powered alkaline battery.

5 Test Equipment Use List

5.1 Equipment List

Equipment	Manufacturer	Model #	Serial/Inst #	Last Cal mm/dd/yy	Next Cal mm/dd/yy
Bilog Antenna	Sunol Sciences	JB3	A102606	05/15/2012	05/15/2014
Horn Antenna	Sunol Sciences	DRH-118	A040806	10/05/2012	10/05/2014
Horn Antenna	CMT	RA42-K-F-4B-C	020131-004	06/19/2013	06/19/2014
Spectrum Analyzer	Rohde & Schwarz	FSL6	100169	01/08/2014	02/08/2015
Spectrum Analyzer	Agilent	N9038A	MY52260210	01/08/2014	02/08/2015
Spectrum Analyzer	Rohde Schwarz	ESIB	832427/002	01/08/2014	02/08/2015
Amplifier	Hewlett Packard	8447D	2944A07996	01/07/2014	02/07/2015
Amplifier	Miteq	TTA1800-30-4G	1842452	01/08/2014	02/08/2015
Amplifier	Rhode&Schwarz	TS-PR26	100011	03/05/2013	03/05/2014
Power Meter	Agilent	E4418B	MY45103902	01/09/2014	02/09/2015
Power Sensor	Hewlett Packard	8482A	55-5131	01/09/2014	02/09/2015
Notch Filter	Micro-Tronics	BRM50702	37	01/16/2013	01/16/2015

* Calibration of equipment past due for re-calibration will be performed expeditiously. If any equipment is found to be out of tolerance at that time, affected customers will be notified accordingly.

6 EMC Test Plan

6.1 Introduction

This section provides a description of the Equipment Under Test (EUT), configurations, operating conditions, and performance acceptance criteria. It is an overview of information provided by the manufacturer so that the test laboratory may perform the requested testing.

6.2 Customer

Table 7: Customer Information

Company Name	Fluke Corporation.
Address	6920 Seaway Blvd.
City, State, Zip	Everett, WA 98203
Country	U.S.A.
Phone	(425) 446-5928

Table 8: Technical Contact Information

Name	Dave Epperson
E-mail	dave.epperson@fluke.com
Phone	(425) 446-5928
Fax	(425) 446-4703

6.3 Product Specification

Table 9: EUT Specifications

EUT Specification	
Dimensions	4.75 cm x 9.3 cm x 20.7 cm
Power	EUT is Battery Operated Input Voltage: 4.5 V (3 AA batteries)
Environment	Indoor and Outdoor
Operating Temperature Range:	-10 to +50 degrees C
Multiple Feeds:	<input type="checkbox"/> Yes and how many <input checked="" type="checkbox"/> No
Hardware Version	ELEK-3001 Rev. 004
Part Number	4320983
RF Software Version	None
Operating Mode	802.15.4 - Bluetooth Radio
Transmitter Frequency Band	2.402 GHz to 2.480 GHz
Max. Rated Power Output	10 dBm
Antenna Type	3 dBi integrated chip antenna
Modulation Type	<input type="checkbox"/> AM <input type="checkbox"/> FM <input type="checkbox"/> DSSS <input type="checkbox"/> OFDM <input checked="" type="checkbox"/> Other describe: GFSK
Data Rate	1 Mbps
TX/RX Chain (s)	1
Directional Gain Type	<input checked="" type="checkbox"/> Uncorrelated <input checked="" type="checkbox"/> No Beam-Forming <input type="checkbox"/> Other describe:
Type of Equipment	<input type="checkbox"/> Table Top <input type="checkbox"/> Wall-mount <input type="checkbox"/> Floor standing cabinet <input checked="" type="checkbox"/> Other <i>Portable</i>

6.4 Configuration (s)

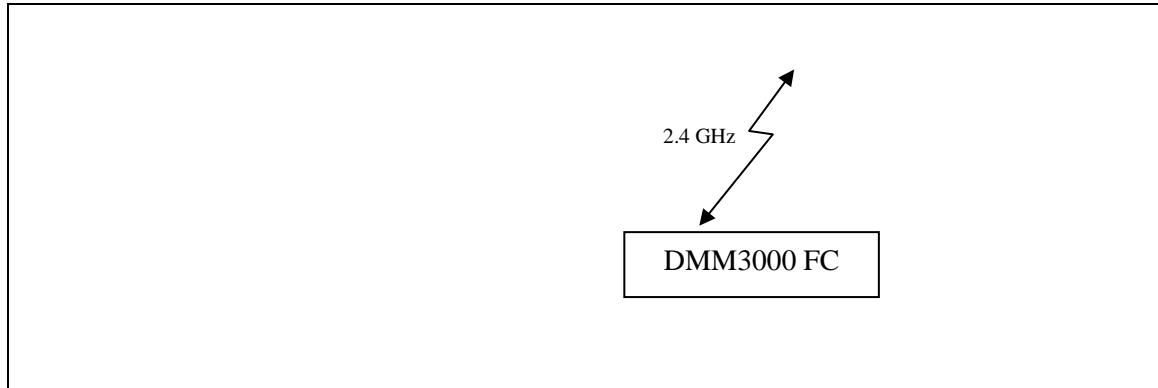

Figure



27 - Block Diagram of EUT Setup

Note: The wireless multimeter was in stand-alone. There was no support device.

Table 10: Description of Sample used for Testing

Device	Serial	RF Connection	CFR 47 Part 15.247
DMM3000 FC	26150025	Chip Antenna	TX Spurious Emission Hopping Parameters
	26150028	Direct via SMA	Output Power Occupied Bandwidth Out of Band Emission

Table 11: Description of Test Configuration used for Radiated Measurement.

Device	Antenna	Mode	Setup Photo (X-Axis)	Setup Photo (Y-Axis)	Setup Photo (Z-Axis)
DMM3000 FC	Integrated	Transmit			

Note: Pre-scans were performed in 3 orthogonal axis, and X-Axis was worst-case.

6.5 Duty Cycle

Fluke declared the DMM3000 FC would have the maximum duty cycle of 0.13%.
The maximum duty cycle correction factor of 20 dB was applied the transmitter spurious emissions.
The measurement plots demonstrate the actual maximum transmission time.

Duty cycle calculation: $133\mu\text{s} / 100\text{ ms} = 0.00133$

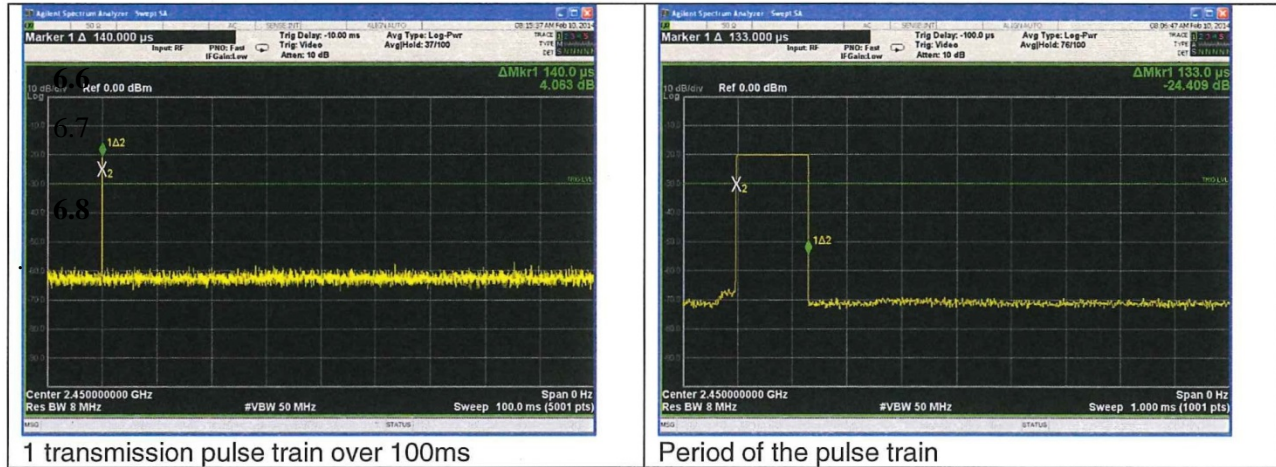

6.6 Test Specifications

Testing requirements

Table 12: Test Specifications

Emissions and Immunity	
Standard	Requirement
CFR 47 Part 15.247:2013	All
RSS-210 Issue 8, 2010	All

END OF REPORT