

# REVOLABS FLX2™

## Wireless Conference System for Voice over IP

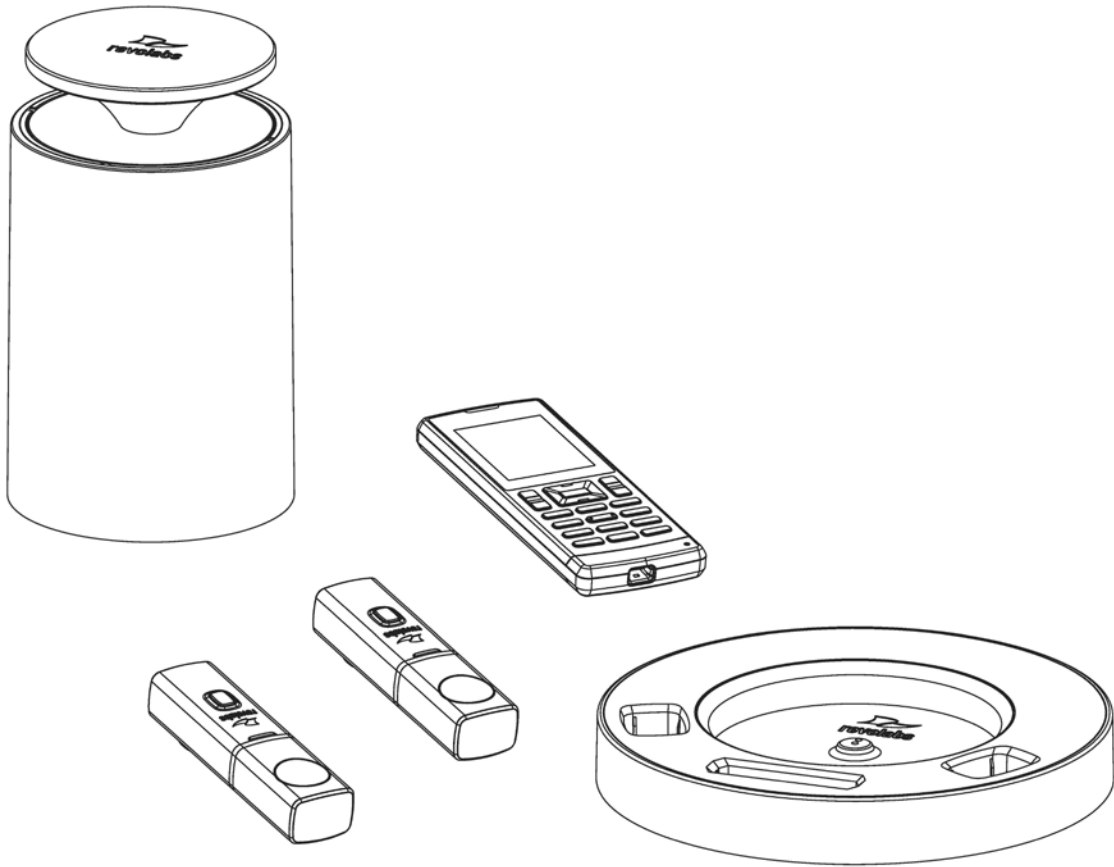

### System Guide

#### Models:

10-FLX2-200-VOIP

10-FLX2-020-VOIP

10-FLX2-002-VOIP

10-FLX2-101-VOIP

10-FLX2-200-DUAL-VOIP

© 2011 - 2015 REVOLABS, INC. All rights reserved. No part of this document may be reproduced in any form or by any means without express written permission from Revolabs, Inc. Product specifications are subject to change without notice.

Revolabs FLX2 System Guide – VOIP  
10-FLX2SYSGUIDEVoIP-EN  
January 2015 (Rev 2.1.3)

## Introduction

Congratulations on your purchase of the Revolabs FLX2™ Wireless Conference Phone. This system utilizes state of the art technology providing high band-width audio and enabling clear, reliable, un-tethered communications with your telephone, PC, mobile device, and video conferencing system.

The Revolabs FLX2 Conferencing Phone allows enhanced freedom for VoIP calls and video conferences by allowing independent locations of the microphones and the speaker used during the call.

The FLX2 Conference Phone utilizes encrypted digital communication for its wireless transport, ensuring highest security for your conversations. The FLX2 Conference Phone is a flexible solution for all your communication needs, allowing it to be used in your VoIP telephone network, for your video conferences, and with your Bluetooth enabled cell phone or computer.

Welcome to the 21<sup>st</sup> century Unified Communications Technology!

Please read this documentation carefully and follow the instructions before using your FLX2 Wireless Conference phone.

## Safety Warnings

- Do not expose any of the FLX2 components to water, moisture, or high humidity.
- Do not expose any of the FLX2 components to extreme high or low temperatures.
- Do not expose any of the FLX2 components to lit candles, cigarettes, cigars, or to open flames, etc.
- Do not drop, throw, or try to bend any of the components, as rough treatment could damage them.
- Do not open the casings of any of the components of the FLX2 Conference Phone
- Do not use any other accessories than Revolabs' originals intended for use with this product. Use of non-original accessories may result in loss of performance, damage to the product, fire, electric shock or injury. The warranty does not cover product failures which have been caused by use of non-original accessories.
- Only use the power adapter provided to connect the components to the electric mains.
- Do not open or try to modify any of the batteries delivered with the FLX2 Conference Phone components. Replace batteries only with Revolabs approved batteries.
- Extreme heat, short circuits, or any attempt to open or modify the batteries might cause them to ignite or explode.

# Contents

Introduction.....	3
Safety Warnings.....	3
Contents.....	4
General Information .....	6
Quick setup for VoIP Conference Calls.....	7
Description.....	10
Unpacking.....	10
Installing FLX2 Components .....	11
FLX2 Base Station .....	11
FLX2 Charger Base.....	12
FLX Dialer .....	13
FLX Speaker .....	14
FLX Microphones .....	15
VoIP configuration .....	16
Managing A Call.....	18
Calling Configurations.....	18
FLX Home Screen .....	19
Placing a VoIP Call .....	21
Answering an Incoming Call .....	21
Declining an Incoming VoIP Call .....	22
Ending a Telephone call .....	23
Calling a Directory Contact.....	23
Active Call Management .....	23
Component behavior in and out of the Charger Base .....	26
Bluetooth.....	27
Activating Bluetooth.....	27
Managing the Device Registry.....	27
Making a call via Bluetooth .....	30
Answering a call via Bluetooth .....	30
Video Conference Collaboration .....	31
Connecting a Video Conference System.....	31
Configuring the Analog Audio .....	31
Making a Video Call.....	31
Mixing the audio signals.....	32
FLX2 System Configuration.....	33
Menu Hierarchy.....	33
Menu Navigation .....	33
Recent Calls .....	34
Contacts .....	36
Audio Control .....	39
Device Status .....	41

System Information .....	41
Home .....	42
Call.....	42
Setup.....	42
<b>Web Interface .....</b>	<b>52</b>
Enabling Web Access .....	52
Connecting to the FLX Web Interface.....	52
Home Page.....	54
User Settings.....	54
Administrator Settings .....	58
<b>Power On/Off the System Components .....</b>	<b>76</b>
<b>Battery Exchange.....</b>	<b>78</b>
Microphones.....	79
Dialer.....	79
Speaker.....	80
<b>Connecting using AUX IN / AUX OUT .....</b>	<b>81</b>
<b>Troubleshooting.....</b>	<b>82</b>
Warning Messages.....	82
Microphone, Speaker, or Dialer not connecting to Base Station .....	83
Microphone, Speaker, or Dialer not paired with Base Station .....	84
LED Indicators.....	84
Reset to Factory Defaults .....	86
<b>Technical Specifications .....</b>	<b>86</b>
Models.....	86
<b>Regulatory Information .....</b>	<b>89</b>
FCC Notice to Users.....	89
Industry Canada Notice to Users .....	90
Restricted use with certain medical devices .....	91
Export Law Assurance.....	91
<b>Limited Warranty and Limitation of Liability.....</b>	<b>93</b>
<b>GPL LICENSED SOFTWARE .....</b>	<b>95</b>
GNU GENERAL PUBLIC LICENSE .....	95
<b>Technical Support.....</b>	<b>101</b>

## General Information

The Revolabs FLX2 Conference Phone includes several components which, in the sum, make up the conferencing phone. The components are the Charger Base, Speaker, Microphones, and Dialer (handset).

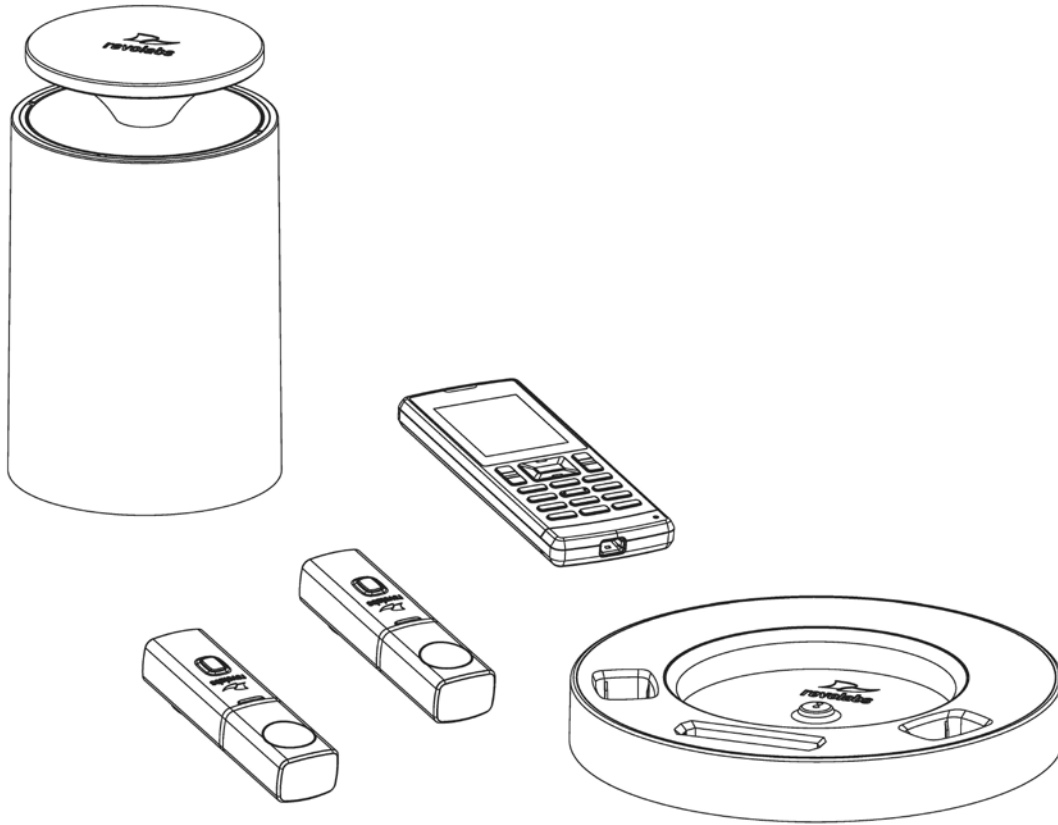

In addition, the Base Station receives the wireless signals from those components and connects to your VoIP network for conference calls, with your video conferencing unit to provide outstanding audio for your video calls, or to your Bluetooth enabled device such as a cell phone or computer.

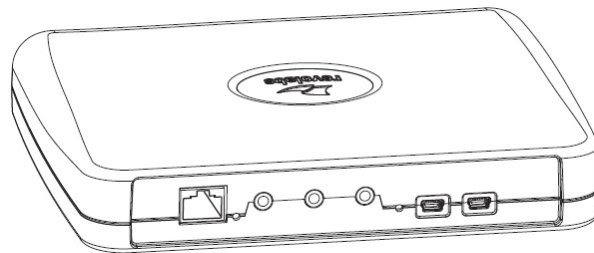

## Quick setup for VoIP Conference Calls

While all components delivered with the Revolabs FLX2 Conference Phone are partially charged, we recommend charging the Speaker, the Microphones, and the Dialer for at least 8 hours or overnight before starting to use the system.

### Connecting the Base Station

Place the Base Station close to the Ethernet outlet you want to use for the conference phone. Connect the Base Station to the network using the provided Ethernet cable. The Base Station is powered using Power over Ethernet (PoE). If the base station does not power up after you connect it to the network outlet, this outlet might not be providing PoE. Please check with your IT department that PoE is available. If your network does not support PoE, Revolabs provides a power injector that can be bought through your reseller, which adds the necessary power to that Ethernet connection.

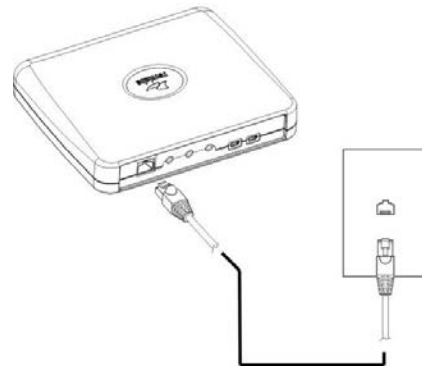

### Connecting the Charger Base

Place the Charger Base at a location where you can easily access the Microphones and the Speaker for your conference calls, e.g. on a side board, a desk, or the conference table. Connect the Charger Base to a power outlet using the provided power supply. Place the Speaker, the Microphones, and the Dialer in the respective openings of the Charger Base to charge them. The Dialer and Speaker will automatically connect to the Base Station after a short time if it is powered up. You will hear a confirmation chime from the Speaker once the system is ready for use. If the Speaker or the Dialer is not powered up, take them out of the Charger Base for a few seconds and put them back in. This will switch on the component.

To switch on the microphones take them out of the charger base. They will automatically power up and connect to the base station.

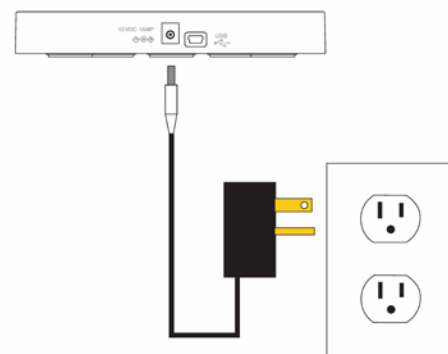

## Phone configuration

Before using the FLX for the first time, you will need to select the system language. The six options are English, Español (Spanish), Français (French), Deutsch (German), Italiano (Italian), and Português (Portuguese). Highlight the language of your choice, and press either “Enter” or “Select” on the Dialer to select it. Once a language is select, the system will use that language for all screen contents. Please ensure that you selected the right one. If the wrong language was selected, it can be changed in the advanced setup menu of the handset (see page 44), however you will have to navigate through the screens using the selected language to get there.

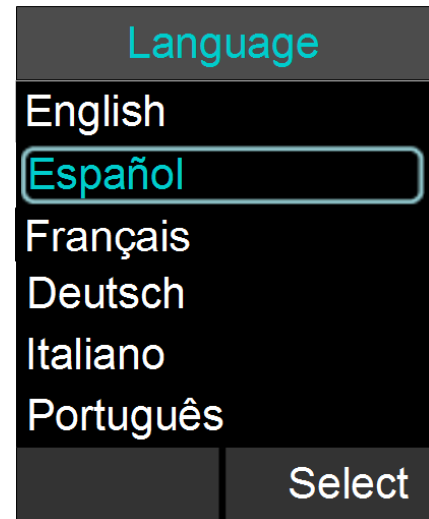

## VoIP configuration

Depending on your switch different settings will be required for your FLX to work in your environment. First of all, the FLX will require an IP address. The IP address can either be obtained from a DHCP server in your network, or be statically set on the phone. The phone is preset to DHCP. If you want to change this, please open the menu on the handset by pressing the right soft key, go to the ‘Setup’ menu, and select ‘Advanced Setup’. You will have to enter a password, which is preset to 7386. Now select ‘Network Settings’. Under ‘IP Settings’ you can set the required network values like IP address, subnet mask, Default Gateway, and DNS servers. You will need to restart the phone for any changes you made in this section to take effect.

If you are using DHCP, you can go to the System Info menu, and select About System. The assigned IP address for the FLX will be shown here. If you configured a VLAN (Virtual LAN) for your voice traffic on your IP network, you need to either enable VLAN on the FLX dialer and provide the VLAN identifier, or select “Automatic”, in which case the FLX will try to determine the VLAN settings of your network at startup.

Independent on how the IP address of your system was assigned, the FLX phone has to be configured to work in your VoIP environment. You will also have to enable the extension (user) you want to use with the FLX on your switch. Please review your switch documentation on information on how to do that. For the minimal setup, in the FLX Handset you will have to provide information on the IP connection to the telephone switch. To do this visit Setup – Advanced Setup – Network Settings – VOIP Settings. Under Registrar, provide the IP address or host name of your IP PBX. Username should be the extension or name under which you want to register this phone on the IP PBX. In Password, provide the password for this username. If no values are provided for ID and Display Name, the Username entry will be used for them. Select ‘Reload Settings’ after you have set the values in the handset, which will restart the base. If further settings are required to connect the FLX phone to your IP PBX, like a Proxy server, please visit the FLX Web Interface as described on page 52. You get to this interface by entering the IP address of the FLX into the web browser of your choice. After you entered the password (7386, unless you changed it in the handset), you can



find the SIP settings under the Administrator tab on the top right. You will find the different SIP settings under SIP Registration, SIP Configuration, Transport, and Media. You have to press 'Save' on every page where you changed an entry to save these changes. If you do not press 'Save', the changes will be lost when you leave that page. Restart the phone once you are finished with your changes.

*Note: For some of the common IP PBXs, Revolabs provides documents on required settings for the FLX and the IP PBX. The documents can be found on the support website at <http://www.revolabs.com/Support/Product-Line/FLX.aspx>.*

Once the FLX is registered with the IP PBX, it will display the ID in the screen and is ready to make and receive phone calls.

### **Making a call**

To make a conference call, take at least one of the Microphones out of the Charger Base, and take the Dialer out of the Charger Base. You can remove all Microphones and the Speaker if you wish, but this is not required. Use the Dialer to enter the number you want to call, including any leading digits your VoIP telephone switch might require. The Speaker and any Microphone that is not in the Charger Base will be active during the call. To finish a conference call, press the red hang-up button on the Dialer.

*NOTE: It is also possible to have a conference call with the microphones in the charger base. However, due to the proximity of microphone and speaker at that time, audio quality might be impacted. The maximum volume of the speaker is limited while the microphones are in the charger base. Microphones that are placed into the charger base are switched off. To use microphones in the charger base for phone calls they first have to be switched on. You do this by pressing the button on the microphone while it is in the charger. The microphone will start in a muted state. Once it starts blinking red, unmute it by pressing the mute button once again. Microphones in the charger base never transmit audio to the AUX OUT connector. If any microphone is active outside of the charger base, microphones in the charger base cannot be activated (unmuted) for the call.*

To make a call using the Dialer as a handset, make sure that all Microphones are in the Charger Base before starting to dial the number. At this point, only the Dialer will be used for the call. To end the call, press the red hang-up button on the Dialer.

At any time during a call you can toggle between handset and conference phone mode using the buttons on the Dialer.

To answer a call using the conference phone, simply remove one or more Microphones from the Charger Base when the Speaker rings. If a microphone is already out of the

charger base when an incoming call comes in, pressing the button on the microphone will answer the call in conference phone mode. You can also use the Dialer to answer the call by pressing the green call button on the handset. If all microphones are in the charger at this time, the call will be answered using the handset mode. If at least one microphone is switched on and not in the charger base, this will answer the call in Conference phone mode.

## Description

The Revolabs FLX2™ Wireless Conference Phone is a unique marriage of innovative technology and ergonomic design, allowing for an unparalleled experience when making telephone calls, video conference calls, or using it with your Bluetooth enabled cell phone or computer to make speaker phone calls.

The technology used allows the Microphones, the Dialer, and the Speaker to co-exist with other wireless products such as wireless LANs (802.11b&g) without interference.

The Revolabs FLX2 Conference Phone includes digital encryption technology to ensure secure wireless communications between the Microphones, Speaker and the Base Station.

## Unpacking

Your Revolabs FLX2™ Conference Phone package contains the following items. When unpacking the system be sure to take inventory of all parts to ensure that nothing is missing. If parts are missing, please contact your retailer.

- FLX2 Base Station
- FLX2 Charger Base
- FLX Speaker
- FLX Dialer
- 2 FLX Microphones
- 1 12-15V AC adapter for the Charger Base
- Ethernet cable
- Quick Setup Guide
- Quick User Guide

The 10-FLX2-200-DUAL-VOIP additionally includes:

- A second FLX2 Charger Base
- A second FLX Speaker
- A second 12-15V AC adapter for the Charger Base

## Installing FLX2 Components

The Revolabs FLX2™ System is comprised of several components that work together to provide you with a great wireless conferencing system. These components must be setup correctly for optimal performance of the system.

### FLX2 Base Station

The Base Station is the wireless receiver and sender of the audio stream from the Microphones and to the Speaker, as well as to the Dialer. It features the ability to connect two Revolabs FLX Microphones and one Speaker wirelessly.

The Base Station is designed to optimize audio and video conferencing by providing consistent audio input from all participants.

The FLX2 VoIP Base Station is shown in rear panel view below. It is equipped with an Ethernet/power connection, two mini-USB ports for firmware updates, and analog audio input/output connections for video conferencing collaboration or for recording.

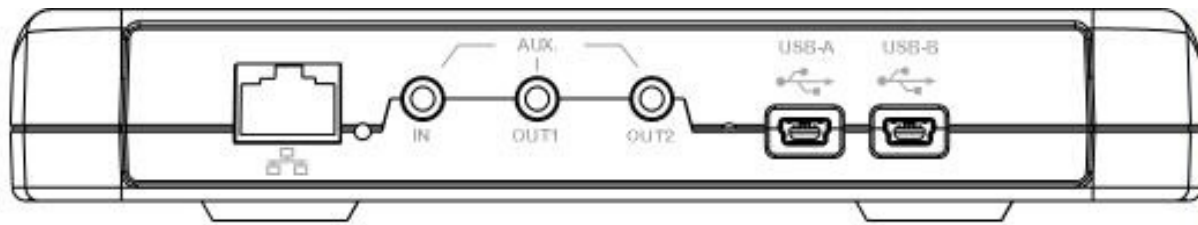

***NOTE: The Base Station comes equipped with the necessary cables and power supplies to perform a VoIP conference call. Other types of conference calls performed with FLX2 may require additional cables that are not part of the delivery.***

## FLX2 Charger Base

The FLX2 Charger Base, shown below, provides charging capabilities for all battery operated system components, including the Dialer, the Speaker, and the Microphones, by allowing them to charge in one simple and organized location.

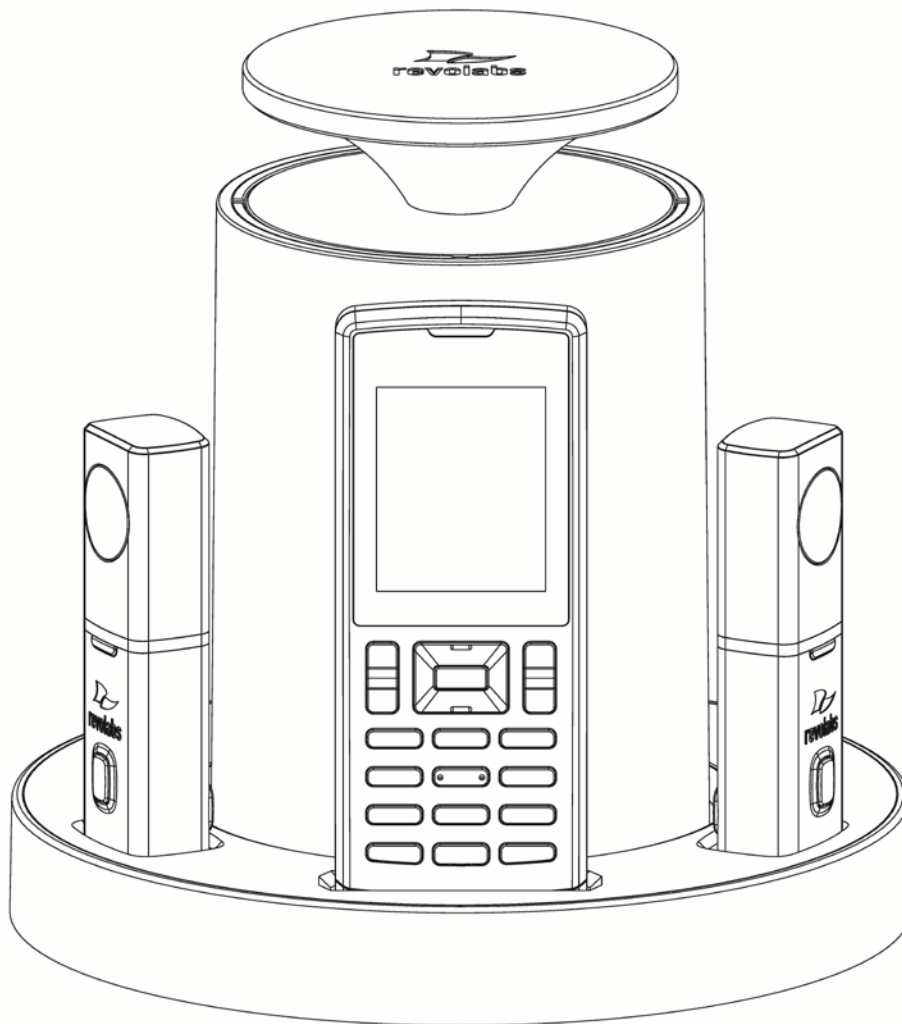

The FLX2 Charger Base is not required while in a conference call, however it can maintain the charge of the FLX Speaker and FLX Dialer while a call is in progress. The Charger Base is equipped with a DC power connection and a mini-USB connection for firmware updates to the Dialer.

## FLX Dialer

The FLX Dialer equips the user with an intuitive and interactive tool for configuring and operating the FLX System.

The Dialer is not only used to make and answer conference calls, but it is also used for configuring the system settings, having a call using the handset, and monitoring the system components.

The FLX Dialer, shown below, is composed of several parts such as a color LCD screen, a compilation of buttons, and a microphone and handset speaker.

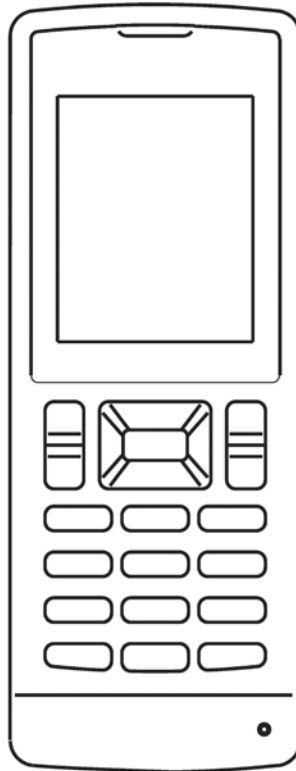

## FLX Speaker

The FLX Speaker, shown below, is a wireless active omnidirectional speaker that has been designed and optimized specifically for use with the FLX Conferencing System. The Speaker is equipped with a pairing button on the bottom and 4 LED indicators on the top to display the activity of the Speaker and the mute status of the system. The Speaker can operate in or out of the Charger Base during conference calls.

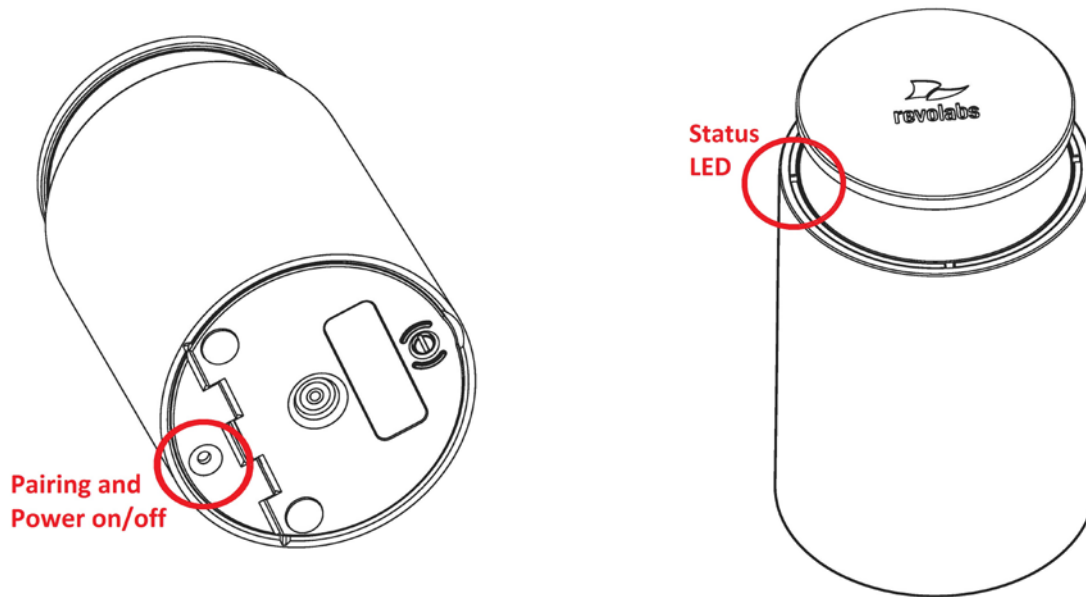

## FLX Microphones

The FLX Microphones provide a sleek and unobtrusive form factor allowing for closer proximity to the participants and creating the best audio available to the far end. They are equipped with a button for pairing and muting, an LED indicator to display mute status and battery charge level, and an internal buzzer to warn if the Microphones have lost connection to the Base Station.

The FLX Microphones, shown below, come in three different versions to provide a flexible solution to meet all applications of conferencing spaces. Microphone types include an omnidirectional tabletop Microphone, a directional tabletop Microphone, and a wearable lapel style Microphone. Any combination of two FLX Microphones can be used with a FLX2 System as they are mix and match.

FLX Microphones will operate in or out of the Charger Base. It is recommended to always remove the microphones from the charger tray for conference calls as audio on the speaker and the microphones is limited while in the charger base. When using Microphones in the charger tray system behavior is automatically adjusted to the close proximity of speaker and microphones. See the note on page 9 on how to activate microphones in the charger.

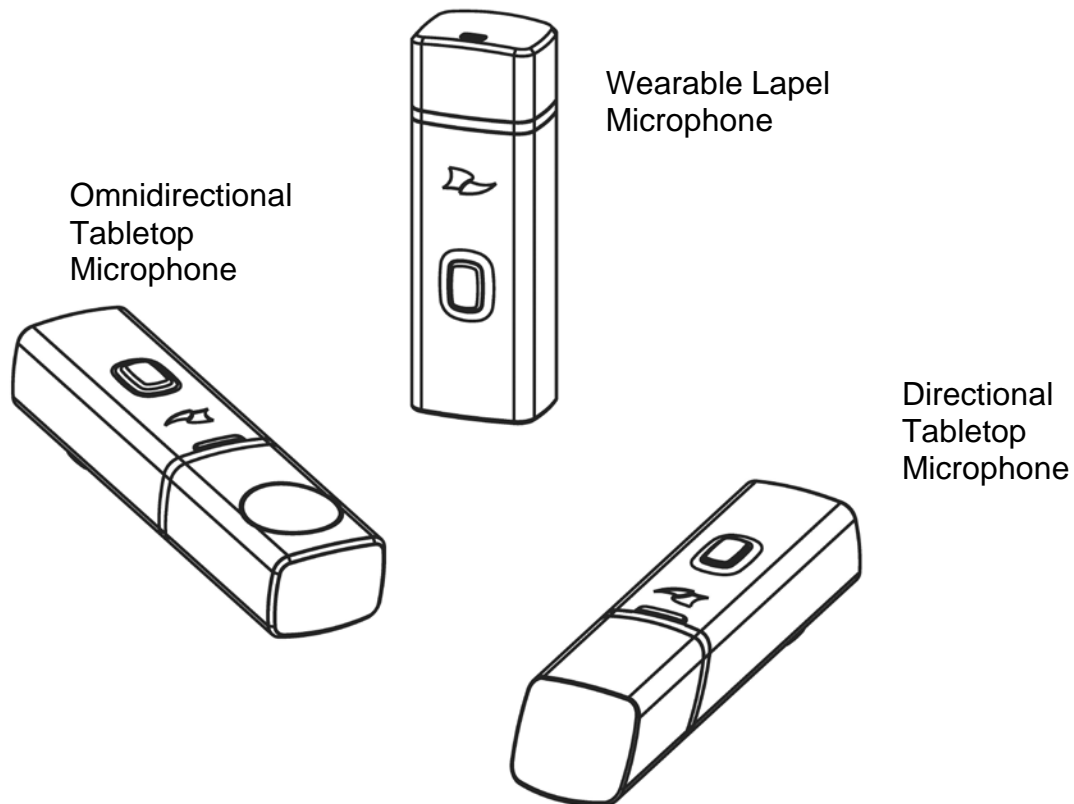

## Initial Setup

After unpacking the FLX2 Conferencing System, there are a few initial setup tasks that must be performed before a call can take place or any system configuration can be changed.

### Connecting System Cables

The FLX2 Charger Base has a power supply that needs to be connected, as shown below. In addition, the Base Station needs to be connected to the network using the provided Ethernet cable before a conference call can be made. The FLX unit expects Power over Ethernet (PoE) to be provided through the network connection. If your network does not support PoE, a power injector is required. Please contact your reseller to purchase the additional PoE power injector. The Base Station offers additional optional connections that are only being used when the FLX2 System for example is connected to a video conferencing unit or a recording device. The cables required for these connections are not included with the FLX2 system and need to be purchased separately.

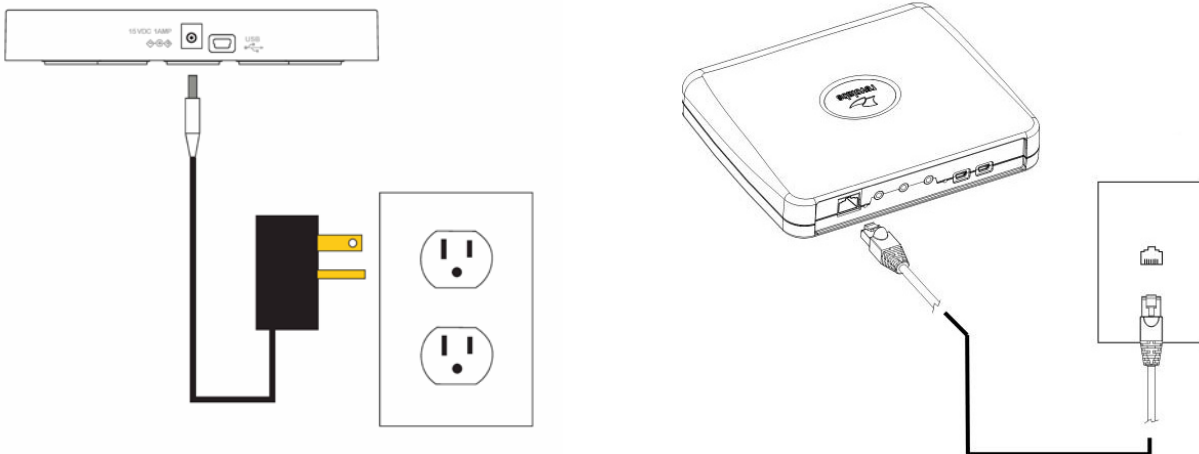

### System Setup

Before using the FLX2 to make a call, you will need to select the system language to be used for the screens. The six options are English, Español (Spanish), Français (French), Deutsch (German), Italiano (Italian), and Português (Portuguese). Please highlight the language of your choice and press 'Enter' or 'Select'.

*Note: If a wrong language was selected at this time, it can be change it later on in the admin area of the menu. However, you will have to navigate through the menu to get to that option using the language you selected. So be careful that you do not select a language you are unfamiliar with.*

### VoIP configuration

For the FLX phone to work within a VoIP environment the phone has to be set up to communicate to the IP PBX. You

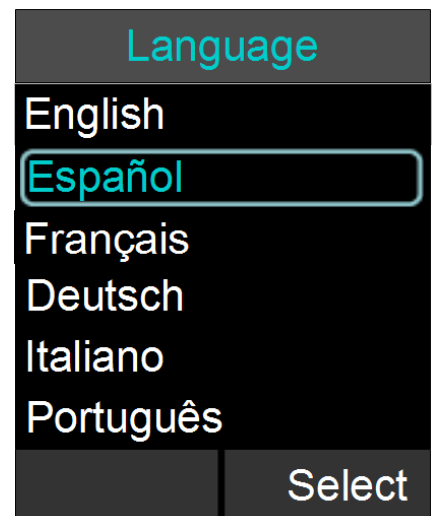



will also have to enable the extension (user) you want to use with the FLX on your PBX. Please review your PBX documentation on information on how to do that.

### **From the FLX Handset**

Depending on your IP PBX, different settings will be required for your FLX to work in your environment. First, the FLX will require an IP address. The IP address can either be obtained from a DHCP server in your network, or be statically set on the phone. The phone is preset to DHCP. If you want to change this setting, open the menu on the Dialer by pressing the right soft key, go to the “Setup” menu, and select “Advanced Setup.” You will have to enter a password, which is preset to 7386. Switch DHCP OFF, and then select “Network Settings.” Under “IP Settings” you can set the required network values like IP Address, Subnet Mask, Default Gateway, and DNS Servers. You will need to restart the phone for any changes you made in this section to take effect. If you are using DHCP, you can go to the System Info menu, and select About System. The assigned IP address for the FLX will be shown here. If you configured a VLAN (Virtual LAN) for your voice traffic on your IP network, you need to either enable VLAN on the FLX dialer and provide the VLAN identifier, or select “Automatic”, in which case the FLX will try to determine the VLAN settings of your network at startup. If you changed any IP settings, you need to select the ‘Load Settings’ option in the Network menu, which will reboot your FLX base.

Independent on how the IP address of your system was assigned, the FLX phone has to be configured to work in your VoIP environment and communicate with your IP PBX. You will have to enable the extension (user) you want to use with the FLX on your IP PBX. Please review your IP PBX documentation for information on how to add and configure users. For the minimal setup, in the FLX Dialer you will have to provide information on the IP connection to the IP PBX. On the Dialer visit Setup – Advanced Setup – Network Settings – VOIP Settings. Under Registrar, provide the IP address or host name of your IP PBX. Username should be the extension or name under which you want to register this phone on the IP PBX. In Password, provide the password for this username. If no values are provided for ID and Display Name, the Username entry will be used for them. Select “Load Settings” after you have set the values in the Dialer, which will restart the Base Station.

For enhanced settings the Web Interface provided by the FLX needs to be used.

### **From the FLX Web Interface**

If further settings are required to connect the FLX phone to your IP PBX, like a Proxy server, please visit the FLX Web Interface. You get to this interface by entering the IP address of the FLX into the web browser of your choice. After you enter the password (7386, unless you changed it in the Dialer), you can find the SIP configuration items under the Administrator tab on the top right. You will find the different SIP settings under SIP Registration, SIP Configuration, Transport, and Media. You have to press “Save” on every page where you changed an entry to save these changes. If you do not press “Save,” the changes will be lost when you leave that page. Restart the phone once you are finished with your changes. Please see page 52 for a description of the FLX Web Interface.

*Note: For some of the common IP PBXs, Revolabs provides documents on required settings for the FLX. The documents can be found on the support website at*

*<http://www.revolabs.com/Support/Product-Line/FLX.aspx>.*

## **Managing A Call**

The FLX2 Wireless Conferencing system is equipped with a VoIP interface that allows the system to make conference calls in a VoIP network. The following are the basic operational instructions for making and receiving telephone conference calls.

### **Calling Configurations**

The FLX2 Wireless Conferencing system has the ability to make and receive calls in many different ways. This provides the caller the ability to choose what mode or call type best suits the needs of each individual call.

#### **Speaker Mode**

Speaker mode allows the call to take place using the Speaker and Microphones provided with the FLX2 System. This allows multiple users, within the conference room, to participate in the call. It also provides the ability for the Microphones and Speaker to be located anywhere in the conference room to meet the needs of each meeting. The call, as well as the Speaker and Microphones, are controlled by the FLX Dialer. The user can switch between 'speaker mode' and 'handset mode' while in a call.

#### **Handset Mode**

Handset mode allows a telephone call to take place through the handset speaker and microphone located in the FLX Dialer. This allows a single user to make and receive a private call. It also provides the ability for the FLX2 System to act as a personal desk phone. The Microphones and Speaker are not used during a handset call. The user can switch between 'speaker mode' and 'handset mode' while actively in a call by using the key marked "Handset" or "Speaker".

*NOTE: To switch from a handset call to a speaker call at least one Microphone should be out of the Charger Base and switched on, and the Speaker must be switched on. If all Microphones are in the Charger Base at least one of the Microphones in the Charger Base has to be activated manually by pressing the Microphone button before switching from the handset call to a speaker call.*

#### **VoIP Call**

The FLX2 Conference Phone allows making conference calls using an Ethernet VoIP connection. A telephone call can be made using either 'speaker mode' or 'handset mode'. A telephone call can be made at the same time as a video call. Telephone calls are controlled via the FLX Dialer.

## Bluetooth Call

The FLX2 System is equipped with a Bluetooth interface that supports the Hands Free Profile (HFP). This profile allows the user to make a call through a cell phone, a computer, or other device via a Bluetooth connection. A Bluetooth call can be made using 'speaker mode' only. A Bluetooth call is controlled by the connected Bluetooth device. A Bluetooth call can be made at the same time as a video call.

*NOTE: Revolabs FLX only supports the Hands Free Profile (HFP) for Bluetooth 2.0 or higher. Applications that try to use the Bluetooth connection not using the HFP profile, or that are using an older HFP / Bluetooth standard are not supported by the FLX.*

## Video Conference Call

The FLX2 System can be connected to a 3<sup>rd</sup> party video or PC conferencing system via the Analog I/O ports located on the FLX2 Base Station. This allows the Microphones and Speaker to be used as the audio interface for the video conference call. Video Conference calls are controlled primarily by the video conference system. However, audio properties can be controlled via the FLX Dialer. While the FLX2 Conference Phone is connected to a video conferencing device, it might still make and accept calls over the VoIP connection or via a Bluetooth device.

*NOTE: When using the FLX connected through the AUX IN and AUX OUT to another device, only the FLX speaker can be used. All other speakers, e.g. in a television set, must be turned off. To avoid audio problems, any Echo Cancellation provided on the Video Conferencing unit should be switched off.*

*NOTE: For security reasons, Microphones will not send any audio signal to the AUX OUT connector when in the charger. To receive audio signal on the AUX OUT, microphones have to be taken out of the Charger Base.*

## FLX Home Screen

Whenever the FLX is not in a call, the FLX Dialer will show the FLX Home Screen. The Top of the home screen shows several symbols, indicating the current status of the FLX components. From left to right they are an indicators for each of the possible Speakers, one symbol for each of the mics, and a charging indicator for the handset itself. The color of the Speaker and Microphone symbol indicate their status. A green Speaker indicates that that speaker is available, a grey one means that this speaker is not available, e.g. no speaker is paired

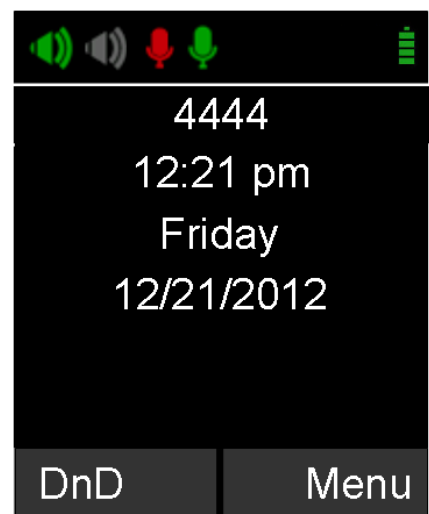

or the speaker is switched off, and a yellow speaker means that the status of the speaker is unknown, e.g. it was taken out of range or connection was unexpectedly lost. A green microphone indicates that the microphone is available and unmuted, a red indicates it is available but muted, grey indicates it is switched off, and yellow means the current status is unknown, e.g. it was taken out of range. The handset charging indicator shows the current status of the battery. Green indicates a charged battery, yellow means that the charge is getting low, and red indicates that the battery requires re-charging. In the Charger Base the battery indicator will show a grey symbol while charging.

In addition, the first line will show if a Bluetooth link is currently active with a blue symbol.

If the Handset failed to connect to the Base Station, a red, crossed out Bluetooth symbol is shown.

In the top text line of the screen the ID or the user name with which this telephone registered to the VoIP PBX is shown. Below that, current time and date are displayed.

From the home screen a call can be started by dialing a number, The “Do not Disturb” function of your switch can be activated for this phone, or the system menu can be entered. Whenever “Do not Disturb” is turned on, all calls to this phone will be handled in the switch as defined in there, e.g. sent to voice mail,

The Home screen also provides information on new voice mails for the extension (if available), and on missed or rejected calls.

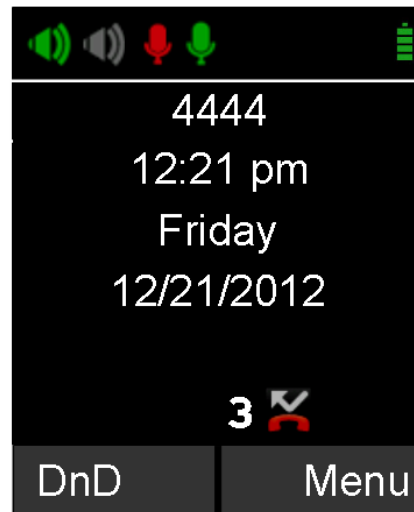
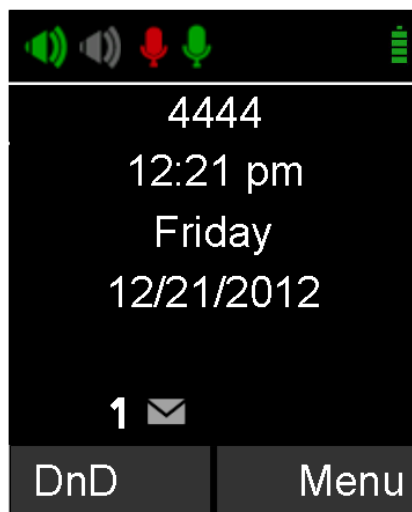
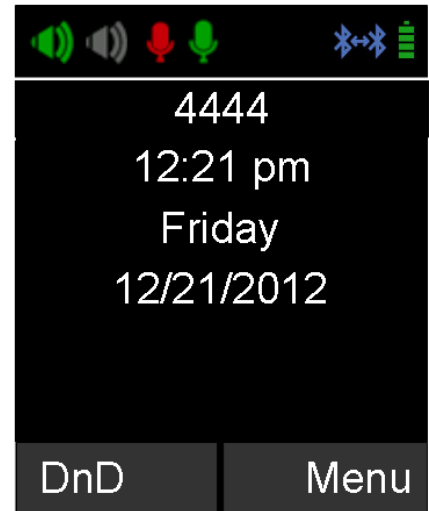

## Placing a VoIP Call

1. From the home screen on the FLX Dialer enter the phone number to be called.
2. Once the number is entered completely, press the green 'call' button to initiate the phone call.
3. If any Microphones are out of the Charger Base and active, the call will default to 'speaker mode' and will be identified by the ring tone being played out of the Speaker.
4. If no Microphones are outside the Charger Base the call will default to 'handset mode' and the call will take place on the FLX Dialer.

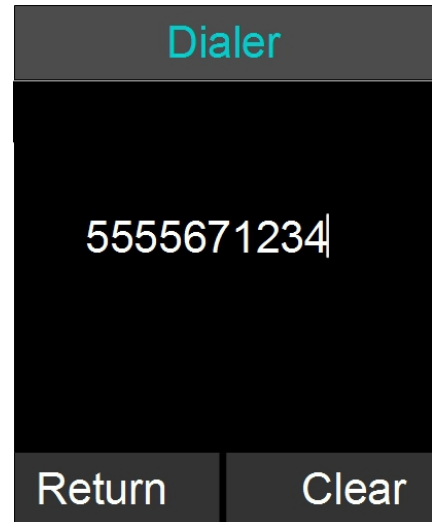

Once a call has been started, the home screen will show the two available phone lines and the activity on each line. In this case, the outgoing call is being made on line 1. **The green phone symbol represents an active call.**

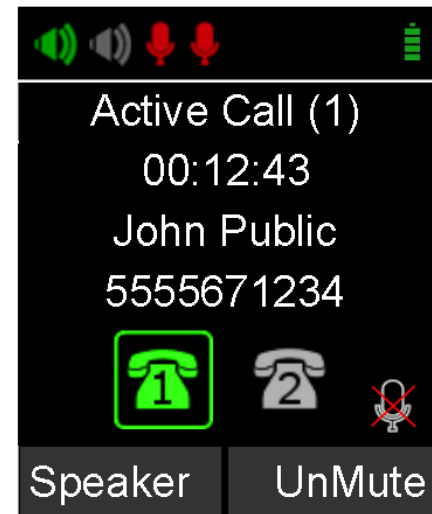

## Answering an Incoming Call

1. When the FLX2 System identifies an incoming call, it will play the ring tone through the FLX Speaker. If the Dialer is not in the Charger Base it will play a ring tone, too.
2. The FLX Dialer will display the caller ID information for the incoming call. **The yellow phone symbol represents an incoming call**, in this case on line one.
3. A call can be answered in one of three fashions.
  - a. Press the Green 'Call' button or the 'Answer' key on the FLX Dialer.
  - b. Remove a Microphone from the charger.
  - c. Press the mute/unmute button on a Microphone that is already out of the

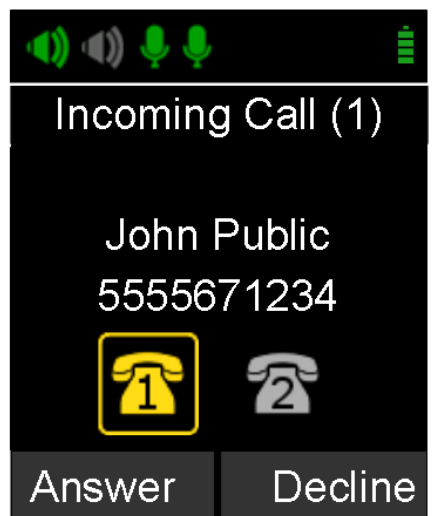

charger.

**NOTE:** *If there is either no Speaker active or no Microphones outside the Charger Base when the incoming call is answered from the FLX Dialer, the call will default to 'handset mode' and will remain in 'handset mode'. The call can only be switched to 'speaker mode' if the speaker and at least one microphone is switched on. If all microphones are in the charger base at least one has to be switched on before by pressing the microphone button.*

### Declining an Incoming VoIP Call

1. When the FLX2 System identifies an incoming call, it will play the ring tone through the FLX Speaker.
2. The FLX Dialer will display the caller ID information for the incoming call.
3. A call can be ignored in one of two fashions.
  - a. Press the Red 'End Call' button on the FLX Dialer.
  - b. Press the 'Decline' key on the FLX Dialer.

**Note:** *Once the user ignores the call, the telephone switch decides how to handle the call. It might for example be transferred into voicemail, based on settings in the telephone switch.*

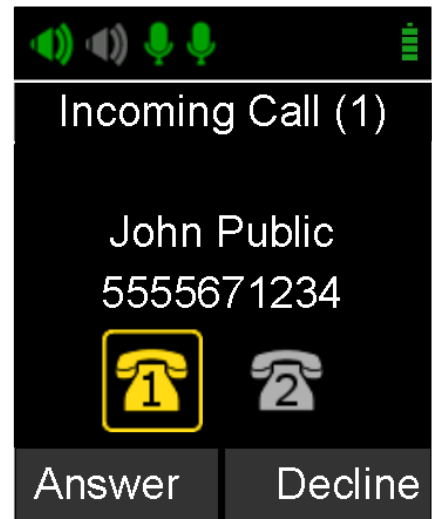

## Ending a Telephone call

1. A call can be ended in two fashions.
  - a. Press the Red 'End Call' button on the FLX Dialer during a call.
  - b. Place the Dialer in the charger. ('Handset mode' only)
2. When a call is ended the home screen is shown again.
3. Microphones not in the Charger Base will maintain their mute states (muted / unmuted) when a call is ended, and will start in this state when another call is made.



## Calling a Directory Contact

1. A directory contact can be called in one of two ways.
  - a. Browse to contact menu: Menu → Contacts. Select the contact, and press the green 'Call' key.
  - b. Browse to contact menu: Menu → Contacts. Select the contact, and press the 'Enter' key or the 'View' key. From the contact view screen, press the green 'Call' key.

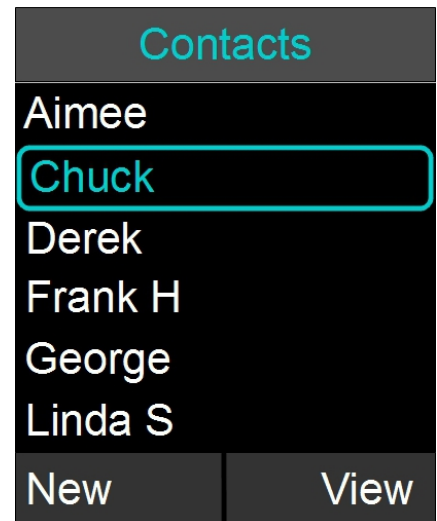

## Active Call Management

The FLX2 System has many call features that can be used when receiving or making phone calls. These features can be controlled via the FLX Dialer during the call.

### Caller ID

1. If the incoming caller is in the Contact List, Caller ID will display both name and number of the incoming contact.
2. If the incoming caller is not in the Contact List, Caller ID will display the incoming information from the network, which might include the telephone number and Caller ID.

*NOTE: An incoming Bluetooth call will display caller ID*

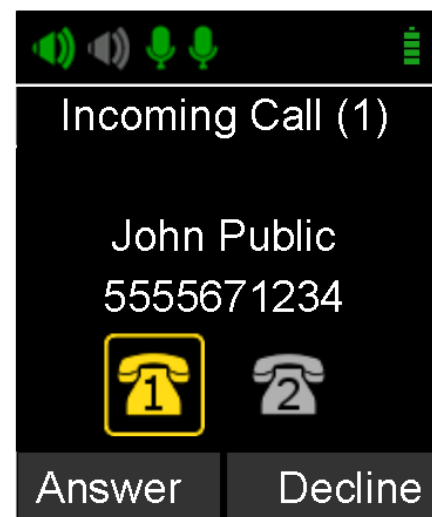

information as well if it is presented by the network.

### Muting a Call

1. In handset mode, the 'Mute' and 'UnMute' key will mute/unmute the FLX Dialer microphone, not the wireless Microphones.
2. In speaker mode, the 'Mute' and 'UnMute' key will mute/unmute all wireless Microphones.

*NOTE: If the setting 'All Mic Mute' is OFF, the Microphone mute buttons will be locked while the Master Mute is active. The Master Mute can only be deactivated via the FLX Dialer. Once deactivated, the Microphones will return to their previous mute state. If 'All Mic Mute' is ON, the Mute / UnMute button on the FLX Dialer and the mute buttons on the FLX Microphones work together. Pressing either of these buttons will mute / unmute all microphones out of the Charger Base, or in the Charger Base if no microphone is outside.*



### Active Call Menu

During a call, pressing the 'Enter' key will open the 'Active Call Menu'. This menu allows putting a caller on hold, start a Conference call based on a dialed number, a contact, or a recent call. This menu also allows transferring an active call to another number. It also provides access to the Device Status menu (see page 40), Audio Controls (see page 39) and the System Info menu (see page 41).

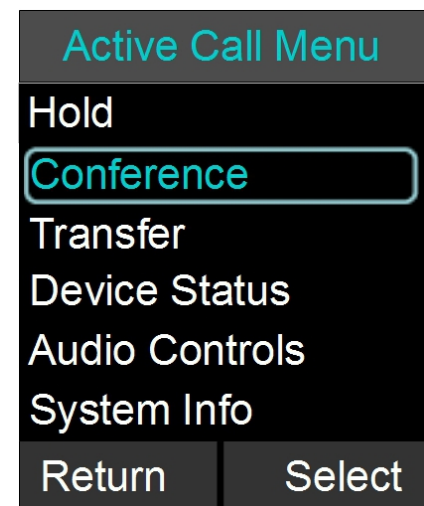

### Placing a Call on Hold

1. Access the Active Call Menu by pressing the 'Enter' key during a call. Select menu item 'Hold'. **An orange phone symbol represents a call on hold.**
2. To resume the call press the 'Resume' key.

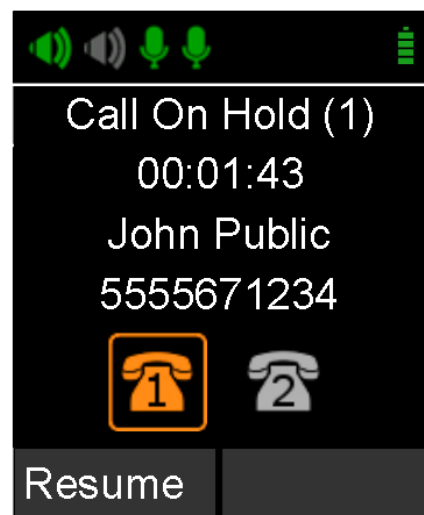



## Conference Call

There are two ways to start a conference call:

1. Press the 'Enter' key to access the Active Call Menu and select 'Conference'.
2. Create the second call by selecting Dialer, Contacts, or Recent.
3. Initiate the second call.
4. After the second call has been established, merge the two calls by pressing the left arrow key, which switches the dialer screen back to Active Call (1), and then press the 'Join' key.

OR

1. While in an active call, press the right arrow key to initiate a second call via the dialer screen. Enter the number, and press the green 'Call' button to dial the number. **Please note that the caller on the active line is not put on hold until the green 'Call' button is pressed.**
2. Once the second call is active, using the left and right arrow keys you can highlight the different lines on your handset. 'Swap' allows swapping the two calls; 'Join' will join the two calls in a conference call.

## Call Waiting

1. While a call is active and the FLX2 System receives a second call, the Speaker or Dialer will play the call waiting indication tone.
2. If available, the FLX Dialer displays the incoming caller number and name.
3. The FLX Dialer presents the user with the option to 'Answer' or 'Decline' the call.
4. If no action is taken and the second call aborts, the FLX Dialer will show the previous Active call screen again.
5. When answering the second call, the first call is put on hold.
6. To terminate either call, make that call the active call, and then press the red 'End' key. The other call will not be affected by this, you can select 'Resume' to continue that call.

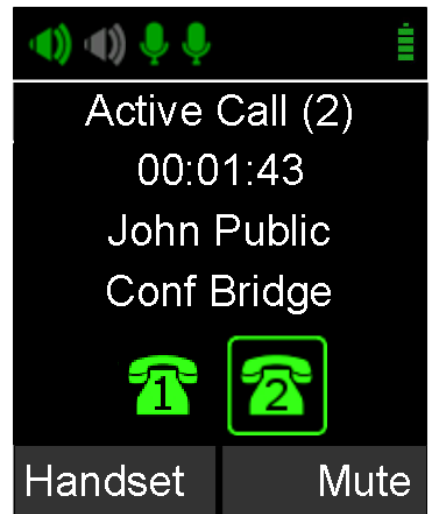

## Component behavior in and out of the Charger Base

Each system component will respond differently when placed in or out of the charger during an active telephone call. The following is a description of what can be expected.

### Dialer

When the Dialer is placed into the Charger Base during a call in 'speaker mode', the call will not be affected and the Dialer will enter its charging mode.

When the Dialer is placed into the Charger Base during a 'handset mode' call, all calls (even calls that are currently on hold) will end and the Dialer will enter its charging mode.

When the Dialer is removed from the Charger Base no change to call activity will take place. If there is no active call, the Dialer will revert to the home screen.

### Speaker

When the Speaker is placed into the charger during a call the Speaker will reboot and enter its charging mode. During the reboot the incoming audio from the conference call will mute until the reboot is complete (approximately 6 seconds). Once the reboot is complete the audio will resume on the speaker.

When the Speaker is removed from the charger no change to call activity will take place.

### Microphones

When a Microphone is placed into the charger during a call it will automatically switch off and enter its charging mode. If all Microphones are placed into the charger during a speaker call, all Microphones will switch off and the call will automatically switch to handset mode, even if the handset is in the charger. To return to a speaker call a Microphone in the charger base will need to be manually switched on by pressing the mute button, and then unmuted by pressing the button again. The call will need to be switched over to a speaker call using the dialer. It is not recommended to use the Microphones in the Charger Base for a speaker call.

If at least one Microphone is outside the charger base active, the Microphone in the Charger Base cannot be unmuted.

When a Microphone is removed from the charger, it will automatically power on and if "Start Unmute" is ON, unmute itself. If there is an incoming call when a Microphone is removed from the charger the call will automatically be answered.

## Bluetooth

The FLX2 System is equipped with a Bluetooth interface allowing a call to be placed through a cell phone, computer, or 3<sup>rd</sup> party Bluetooth device. The FLX Microphones and Speaker then act as the Microphone and Speaker for that call.

The FLX2 System only supports the Hands Free Profile for Bluetooth 2.0 or newer. Should the application on the computer, cell phone, or other 3<sup>rd</sup> party device require other profiles to be supported, FLX cannot act as the Speaker and Microphone for that application. Please contact the provider of the application to find out which Bluetooth profile is supported.

### Activating Bluetooth

1. Go to the Menu→ Bluetooth. Select 'Turn On' to activate Bluetooth.
2. Select 'Yes' when prompted 'Enable Bluetooth Radio?'

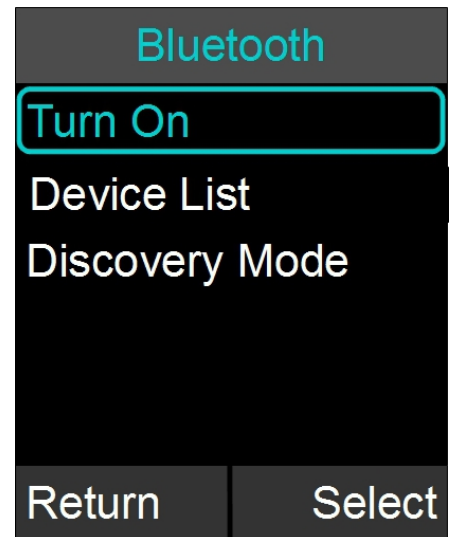

### Managing the Device Registry

The FLX2 Bluetooth interface has a device registry where it activates, stores and recalls 3<sup>rd</sup> party Bluetooth devices being used by FLX2 for Bluetooth Calls. FLX can hold information for up to four Bluetooth connections.

#### Device List

To see the list of Bluetooth devices the FLX has been connected to, go to Menu→ Bluetooth and select 'Device List'.



## Adding a Device

1. Go to the Menu → Bluetooth. Select 'Discovery Mode' to activate Bluetooth and accept Bluetooth Request from other devices.
2. The FLX Dialer displays "This device is visible to other devices in range for 3 minutes"
3. The discovery mode screen will read "System in discoverable Mode, Start Scan From BT Device. System Name: <System Name>"
4. Scan for devices from the Bluetooth device you want to connect to the FLX2 System.
5. When the FLX2 System's name shows up on the Bluetooth device, select the FLX2 System, and connect to it.
6. If prompted for confirmation, select 'yes'. If prompted for pin, type '0000' (default).
7. Press the 'Stop' key in order to abort the pairing processes.

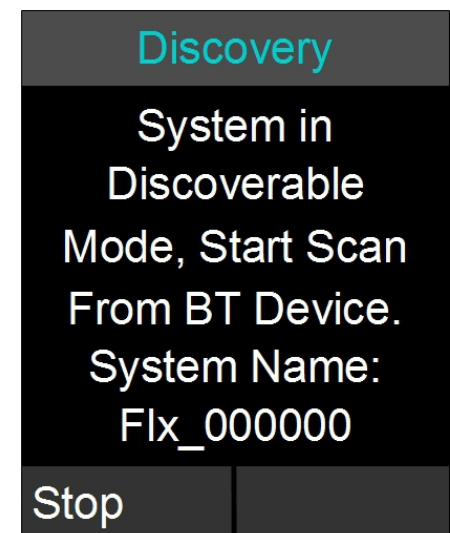
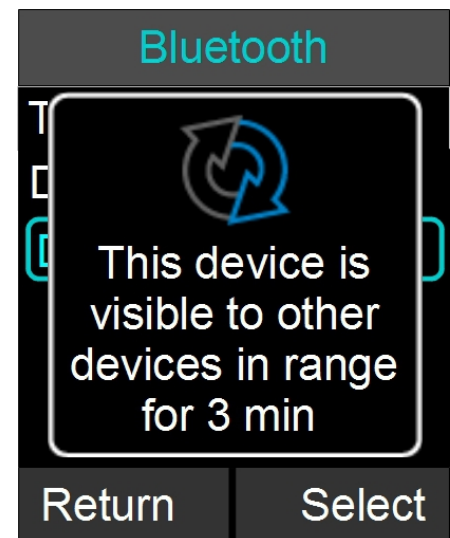
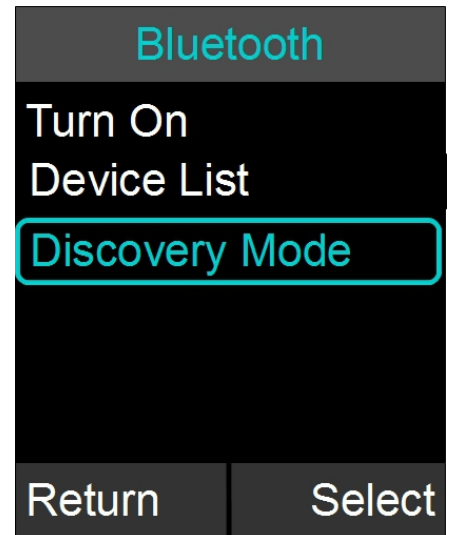

### Viewing Device Details

1. Go to the Menu→ Bluetooth. Select 'Device List'.
2. Select desired device and press the 'Enter' key or the 'Select' key to view device details
3. Device Information screen is shown with device name, address, BT version, and date/time the device was first connected.



### Removing a Device

1. Go to the Menu→ Bluetooth. Select 'Device List'.
2. Select desired device and press the 'Enter' key or the 'Select' key.
3. Press the 'Option' key
4. Select 'Unpair' in the Device Options menu, and press 'Select'.

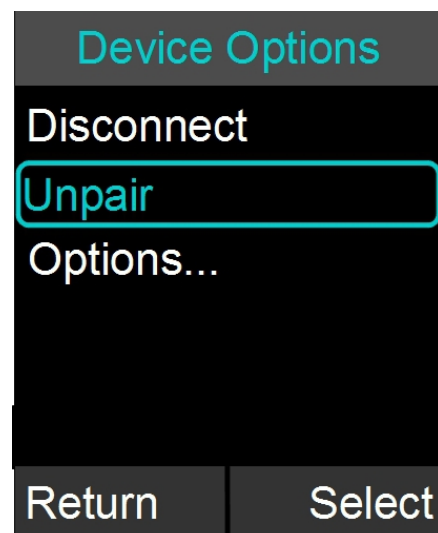

### Accepting Device Connection Request

If the trust setting for a previously paired Bluetooth device is set to 'Ask' and that device comes into range with the FLX2 System, a message will appear on the FLX Dialer.

1. Select 'Yes' to have the FLX2 System pair with the Bluetooth device and be ready for use.
2. Select 'No' to have the FLX2 System ignore the Bluetooth device until the next time it comes into proximity of the FLX2 System.

### Setting Device Trust Level

1. Go to the Menu→ Bluetooth. Select 'Device List'.
2. Select the desired device and press the 'Enter' key or the 'Select' key to view the device details.
3. Press the 'Option' key and then select 'Options...'
4. Choose either 'Auto-Connect' or 'Ask' depending on the trust level you want to set for the Bluetooth Device.

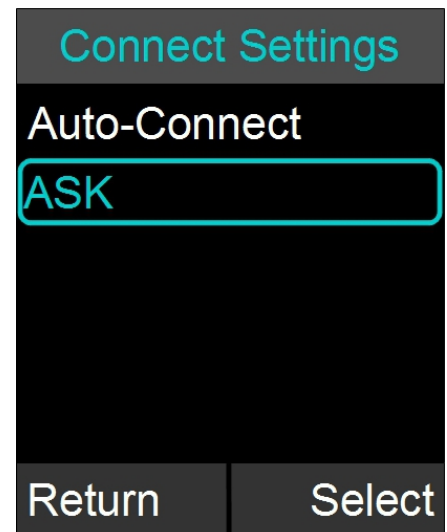

### Making a call via Bluetooth

1. With the Bluetooth connection enabled, dial a number from the Bluetooth device. The call will be conducted using the FLX Speaker and Microphones.

### Answering a call via Bluetooth

1. You can answer a Bluetooth call directly from your FLX system. If answering the call with the FLX system it will automatically be in speaker mode.
2. If you answer the call using your Bluetooth device, settings on that device will determine whether the call will be answered as a speaker call using the FLX Conference Phone, or as a call using other audio devices. If you want to have a private call not using the FLX as the Speaker of the call, ensure that you select the correct audio output device in your Bluetooth enabled device.

## Video Conference Collaboration

The FLX2 System is equipped with balanced analog audio input and output to be connected to 3<sup>rd</sup> party video or PC conferencing system. This allows the FLX Microphones and Speaker to be used as Microphones and Speaker for video calls. It also provides Acoustic Echo Cancellation and Noise Control to the video call.

### Connecting a Video Conference System

In the advanced audio setting (see page 44), change the Aux Audio setting for Aux Out to MIC. Then connect one of the AUX OUT on the FLX2 Base Station via an appropriate mono balanced or unbalanced cable with 3.5mm plugs to the 'Mic Input' on the video conference system.

The line level audio AUX IN on the FLX2 Base Station should be connected, via the appropriate mono balanced or unbalanced 3.5mm cable, to the 'line output' of the video conference system. See page 78 for a list of audio cables required for the most common video conferencing systems available in the market.

As the FLX system provides the Echo Cancellation for the call, any Echo Canceller in the Video Conferencing unit should be switched off. Not switching off the Echo Canceller in the Video Conferencing unit might negatively affect the audio on the video call. Please visit the documentation of your video conferencing unit on how to disable the Echo Canceller.

Any audio device like external speaker or TV speaker attached to the video conferencing unit needs to be disabled. The FLX Speaker and Microphones become your only audio devices for the Video Conferencing call. Any other devices will affect the Echo Canceller and will cause negative impact on the audio of the call.

***NOTE: For security reasons the FLX Microphones will not send any audio to the AUX OUT while in the Charger Base. The microphones have to be removed from the Charger Base to send audio data to the AUX OUT connector.***

### Configuring the Analog Audio

For best audio results, the AUX IN and AUX OUT connectors have to be configured in the right way to receive best results with your video conferencing unit. This requires testing and setting of the values in your environment. See page 40 on setting the volume for the AUX IN and AUX OUT connectors and how to set the level (microphone level or line level) for the AUX IN connector.

### Making a Video Call

The FLX2 System acts as a wireless Microphone, Speaker and mixer for the video conference call. Once configured, a video call can be made using the 3<sup>rd</sup> party user interface supplied with the video conference system. Simply remove the Microphones from the charger to activate the analog audio input.

## Mixing the audio signals

As discussed earlier, Audio and Video, or Bluetooth and Video calls can be made simultaneously from a FLX system, requiring FLX to mix the audio of the different inputs to go to the different outputs.

In the Audio Controls menu, available from the main menu and the Active Call Menu, the Audio Mixer menu is offered. This menu offers three different audio mixer settings, based on the output medium. The Speaker Mixer shown allows defining the mix between AUX IN and the Phone input to be played back on the Speaker. It is a sliding scale from -8 to +8.

Similar Mixers are offered for Phone Out (mixing the signal between AUX IN and the microphones), and AUX OUT (mixing the phone input and the microphones).

The mix of audio can be changed during call time to ensure that the various outputs best reflect the audio requirements. The mixer menus do not replace the AUX IN and AUX OUT volume settings described on page 40.

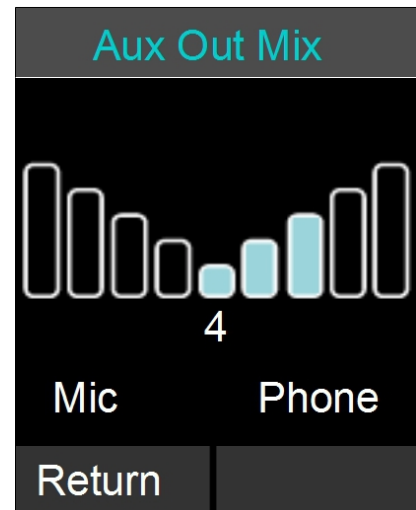



# FLX2 System Configuration

There are many features to the FLX2 System that can be modified and configured using the FLX Dialer. The following is a list of those features and their options.

## Menu Hierarchy

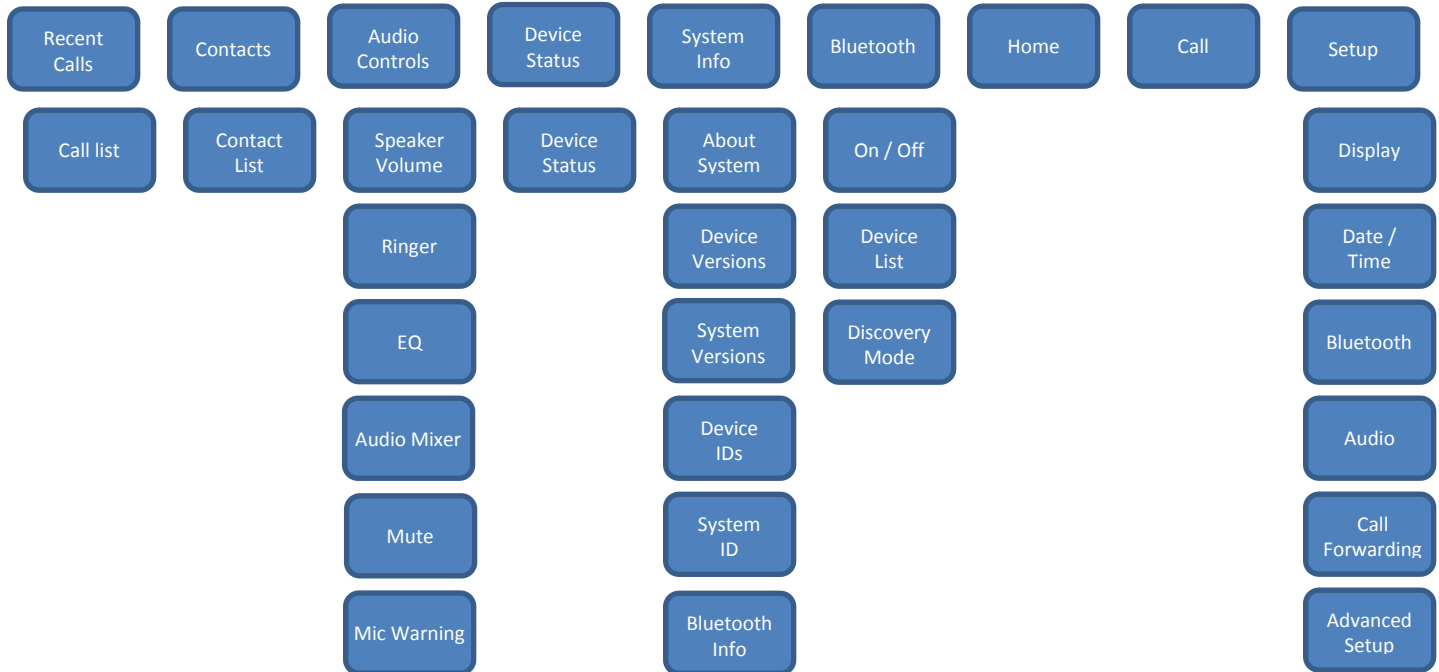

## Menu Navigation

1. Enter the menu by pressing the 'Menu' soft-key in the home screen.
2. The left, right, up and down navigation keys are used to highlight an icon and the Enter key is used to make a selection.
3. Up and Down navigation keys are used to scroll through the menu.
4. When setting levels, such as Volume, in the menus, the Up and Down keys are used to change these values.
5. You leave the menu either by pressing the 'Return' soft-key, which will bring you back one level in the menu hierarchy, or by pressing the red hang-up button, which will bring you back to the home screen.

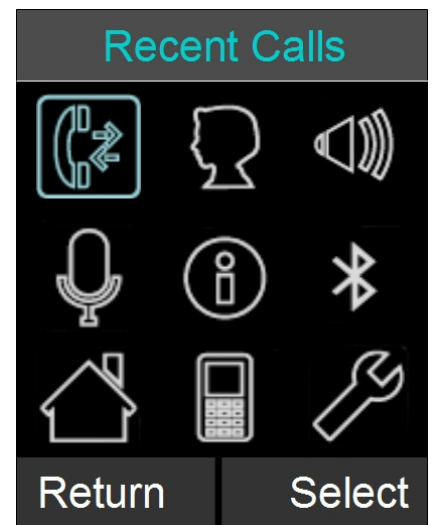

## Recent Calls

The Recent Calls call log stores the contact information from calls placed or received, allowing the user to review recent calls, redial a recent call, or store a recent call in the system directory.

### Recent Call Log

1. Access recent call log by browsing: Menu → Recent Calls
2. The recent call list is sorted chronologically with the most recent call at the top.
3. If a recent call was made by a number stored in the Contact list, the contact name is shown in this list, otherwise the caller ID or dialed number is shown.
4. The recent call log can be accessed directly from the home screen by pressing green 'Call' button in idle state.
5. The recent call log is limited to 20 entries.

**NOTE:** *Recent calls are colorized by type. Dialed calls appear blue, received calls appear green, and missed calls appear red.*

**NOTE:** *The recent call log can be deactivated in the advanced setup menu (see page 47). If it is deactivated, no logs will be kept, the recent call log will always be empty.*



### Call Recent Caller

1. Access the recent call log by browsing: Menu → Recent Calls or pressing the green 'Call' button while no call is in progress.
2. You can call an entry in the recent caller list in one of three fashions
  - a. In the recent call list, select the entry you want to call using the up and down buttons, and press the 'Call' soft-key.
  - b. Pressing the green 'Call' key will also call the entry currently highlighted in the recent call list.
  - c. In the recent call list, select the entry you want to call, and press 'View'. This displays more information. From that screen, you can press the green 'Call' key to call the entry you are viewing.



### View Recent Call Information

1. Access the recent call log by browsing: Menu → Recent Calls or pressing the green 'Call' button while no call is in progress.
2. You can view a recent call one of two ways:
  - a. In the recent call list, select the entry you want to view, and press the 'View' key. This displays more information for the recent call you selected.
  - b. In the recent call list, press enter to bring up the Options menu. Select 'View Recent Call' to display more information for the call you selected.



### Save Recent Caller as Contact

1. Access the recent call log by browsing: Menu → Recent Calls or pressing the green 'Call' button while no call is in progress.
2. In the recent call list, select the entry you want to add to the contacts, and press 'View'. This displays more information for the recent call you selected.
3. Press the 'Save' key to save the recent call as a Contact. If a caller name was provided as part of the Caller ID it will be provided as the contact name. Enter or edit the contact name when prompted and press 'Done'. Verify and edit if necessary the recent contact number and press 'Done' again.

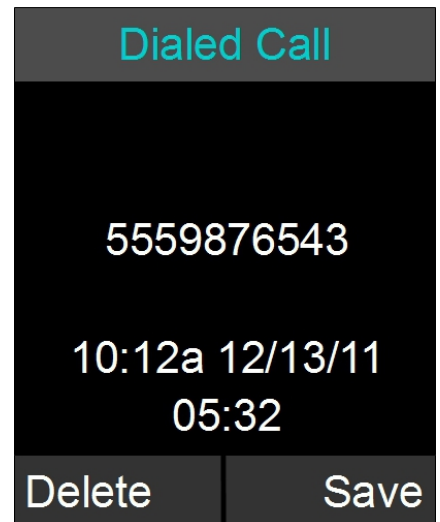

### Delete Recent Call Entry

1. Access the recent call log by browsing: Menu → Recent Calls or pressing the green 'Call' button while no call is in progress.
2. In the recent call list, select the contact you want to delete, and press the 'View' key. This displays more information for the call you selected.
3. Press the 'Delete' key to delete the recent call. Press 'Yes' when prompted for confirmation.

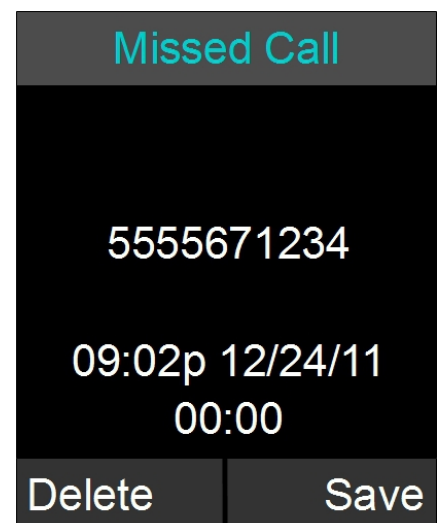

## Delete Call History

1. Access the recent call log by browsing: Menu → Recent Calls or pressing the green 'Call' button while no call is in progress.
2. In the Recent Call menu, press 'Enter' to open the Options Menu.
3. In the Options Menu select 'Delete Redundant' to delete redundant call history information, or select 'Delete All Calls' to delete all call history information.
4. Press 'Yes' to delete the information when prompted for confirmation.

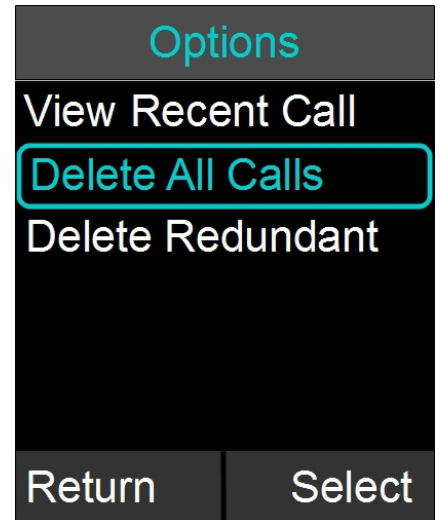

## Contacts

The FLX Dialer can store 100 entries in a contact directory (phone book). The following is a list of features and menus that allow managing the contact directory.

### View Contact List

1. The contact list can be viewed in one of two fashions
  - a. Browse to the Contacts menu: Menu → Contacts, or
  - b. From the home screen, in idle/ready state, press the enter key.
2. To leave the Contacts menu, press the red hang-up button.

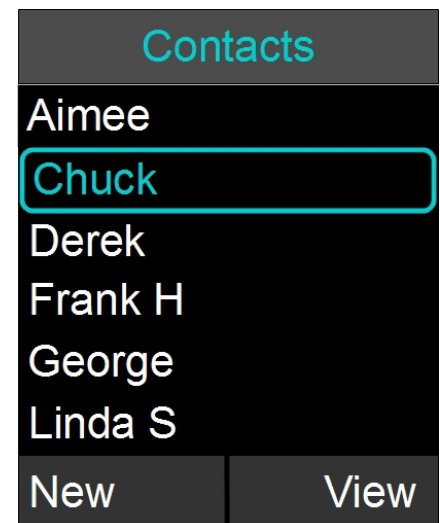

### Add a Contact

1. Browse to the Contacts menu: Menu → Contacts.
2. Press the 'New' key to create a new contact.
3. Edit the name in alphanumeric mode. Pressing 'Clear' while editing the name will delete the character left of the cursor. Press 'Cancel' to return to the previous screen without saving the contact. When finished editing the name, press the Enter button. This will bring you to the number editing screen.
4. Edit the phone number. The key 'Clear' will delete the character to the left of the cursor. Press 'Cancel' to return to the name editor. Pressing Enter will store the new contact in memory.
5. Once the editing is finished, the menu will return to

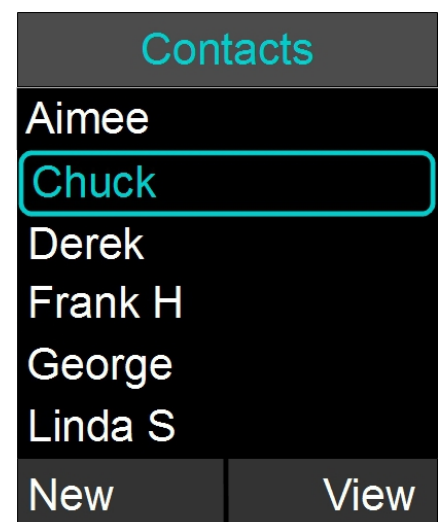

the contact list.

### Edit a Contact

1. Browse to the Contacts menu: Menu → Contacts, scroll to the desired contact, and select 'View' to access the contact.
2. The contact screen shows the current name and number. Pressing the 'Edit' key will open the Edit Contact menu.
3. In the Edit Contact menu, select 'Edit Info' to edit the selected contact.
4. Edit the name in alphanumeric mode. Pressing 'Clear' will delete a character to the left of the cursor. Press 'Cancel' to return to the previous screen without saving changes to the contact name. Pressing the Enter key will finish editing the name and go on to the number editing screen.
5. Edit the phone number. The key 'Clear' will clear/delete the number to the left of the cursor. Press 'Cancel' to return to the Name editor screen. When finished, press 'Enter' to store the edited contact in memory.
6. The contact list menu is shown once editing is completed.

### Delete a Contact

1. Browse to the Contacts menu: Menu → Contacts and press 'View' to access a contact.
2. The contact view screen shows the contact name and number. Pressing the 'Delete' key will delete the selected contact.
3. Press 'Yes' when prompted for confirmation.

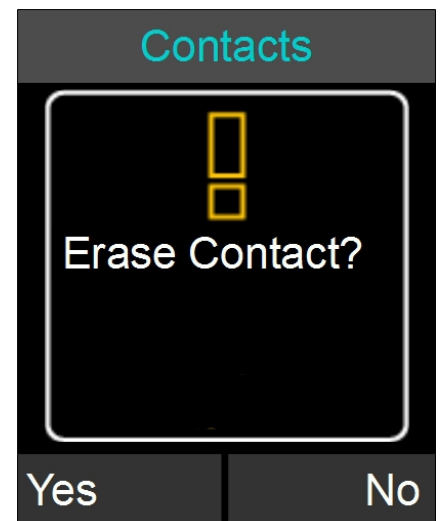
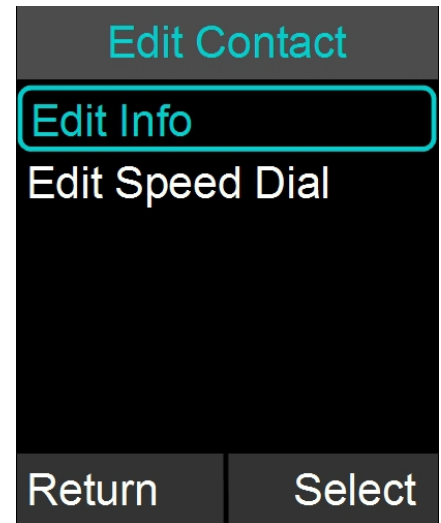

### Search for Contact

1. Browse to the Contacts menu: Menu → Contacts.
2. Use the alphanumeric keys to apply a filter
  - a. Once a key is pressed the title line will read 'Contact()' and display the characters being typed.
  - b. The search string can be up to 5 characters long.
  - c. In this mode the 'Clear' key will delete the last character in the filter field.
3. Only contact items that satisfy the filter will be shown in the contact screen. For example, if 'C' is entered, any contact name starting with 'C' will be shown. The user can scroll through the filtered list using the up and down buttons.

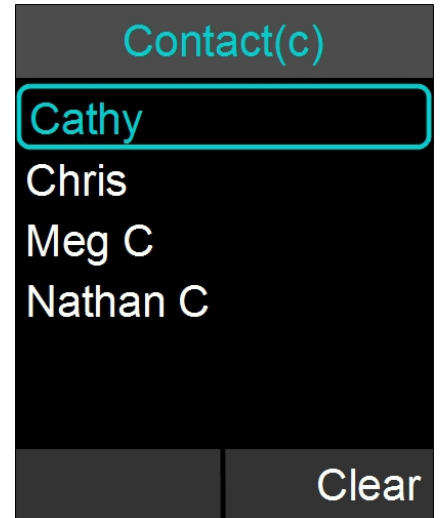

### View Contact Information

1. Browse to the Contacts menu: Menu → Contacts.
2. Select the contact by using the 'up' and 'down' keys.
3. Press 'Enter' or 'View' to see information on the currently selected contact.
4. Information for the selected contact is displayed.

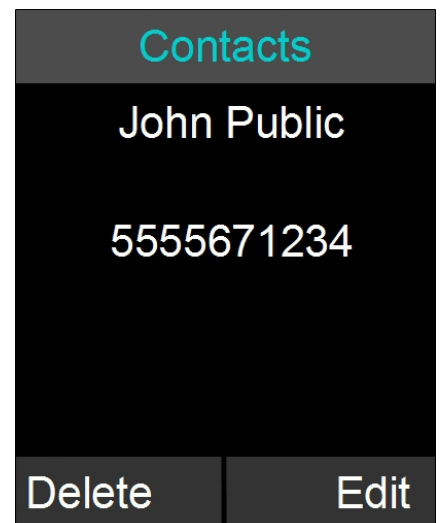

### Call Contact

1. Browse to the Contacts menu: Menu → Contacts.
2. Select the contact by using the 'up' and 'down' keys.
3. Press the green 'Call' key to call the contact currently highlighted.
4. Pressing the green 'Call' key from the contact view screen will also initiate a call.

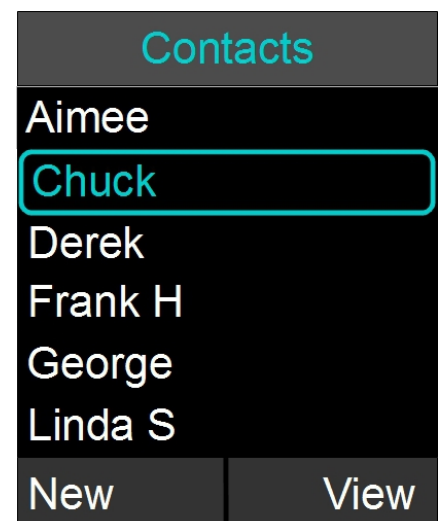

## Set Speed Dial

1. Browse to the Contacts menu: Menu → Contacts, scroll to the desired contact, and press the 'View' key to access the contact.
2. The contact view screen shows the current name and number. Pressing the 'Edit' key will open the Edit Contact menu.
3. In the Edit Contact menu select 'Edit Speed Dial'.
4. Scroll to the desired speed dial number and press the 'Set' key.
5. If this speed dial number is already set, an overlay will appear asking 'Overwrite Speed Dial X?'

## Calling a Speed Dial Number

To call a speed dial number, from the dial menu or from the home screen, press and hold the number key of the speed dial contact you want to call until the screen changes, showing that FLX is dialing the number.

Pressing and holding a number key that has not yet been assigned to a contact has no effect.

## Audio Control

The following is a list of FLX Dialer menus that adjust the system attributes related to speaker audio, Analog audio inputs/outputs, telephony audio configurations, and muting microphones.

### Speaker Volume

1. Browse to the Speaker Volume menu: Menu → Audio Controls → Speaker Volume.
2. The Speaker Volume screen is shown with graph and numerical value of the current volume level.
3. Press the up and down buttons to increase or decrease the volume.
4. During an active call or while in the home screen you can also set the volume by pressing the up and down buttons. In speaker mode or while in the home screen the speaker volume is set from this command. In handset mode the volume on the Dialer is adjusted.

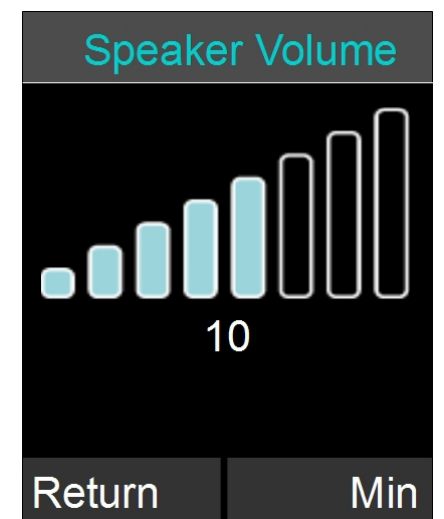
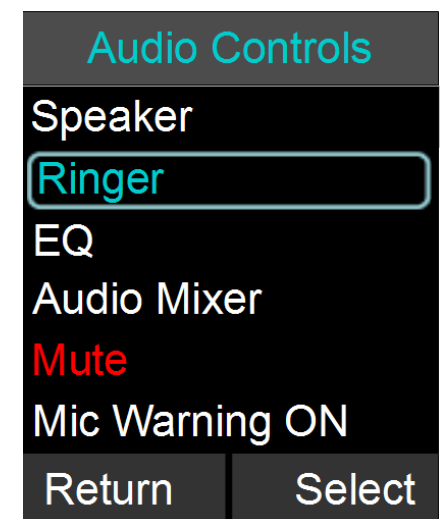
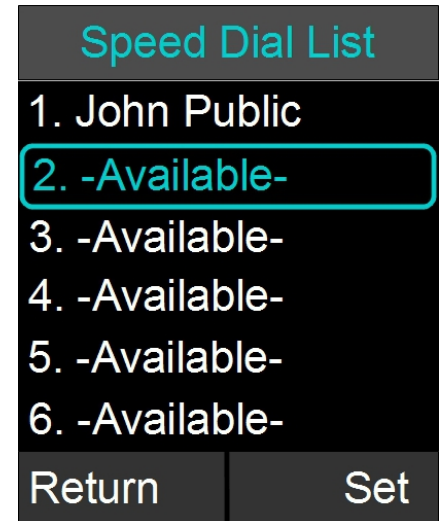

## Ringer

1. Browse to the Ringer menu: Menu → Audio Controls → Ringer.
2. Choose 'Ringer Volume' in the Ringer Settings menu to adjust the Ringer Volume.
3. Press the up and down buttons to increase and decrease the volume.
4. Choose 'Ring Tone' in the Ringer Settings menu to select a ring tone.
5. Use the up and down buttons to select a ring tone, and press enter to set the selected ring tone.
6. The selected ring tone is shown in yellow upper case letters.

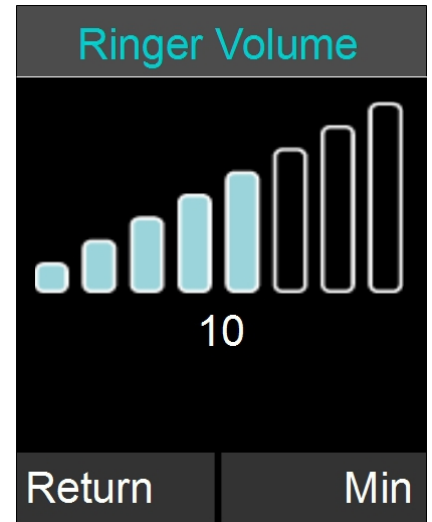

## Equalizer (EQ)

1. Browse to the Equalizer Settings menu: Menu → Audio Controls → EQ.
2. Use the up and down buttons to select a preset EQ, and press enter to set the selected EQ.
3. The selected equalizer will be listed in yellow upper case letters, while the others are listed in lower case letters. In the example to the right, VOICE is the selected EQ Setting.

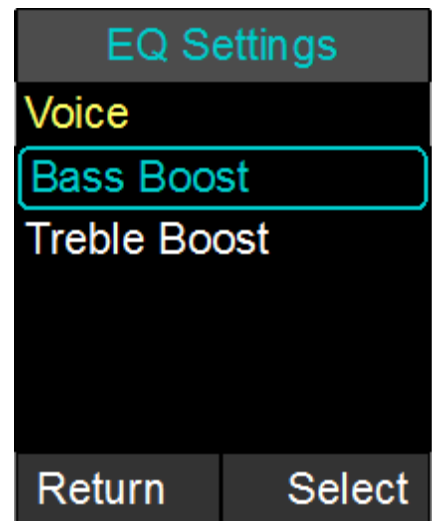

## Audio Mixer

The Audio Mixer menu is described on page 32.

## Mute / UnMute

During a phone call or Bluetooth call one of the soft-keys allows to master-Mute or UnMute all microphones. In an environment where only the AUX OUT / AUX IN connections are used for audio this option does not exist on the home screen. Mute / UnMute in the Audio Control menu provides this option. Highlight the Mute/UnMute option, and press 'Enter' to toggle between the two modes.

## Mic Warning

The Mic Warning setting allows enabling or disabling the voice prompt that is being



played once a phone calls ends, reminding users to return the components – microphones, speaker, and dialer – to the charger tray. Highlight the option and press “Select” or “Enter” to toggle between the ON and OFF mode.

## Device Status

1. Browse to Device Status: Menu → Device Status.
2. The Device Status screen shows status for the Microphones and the Speaker.

*NOTE: The device status list is colorized. If a device is charging or off, it will appear white. If a device is fully charged or has more than 50% battery remaining, it will appear green. Once the battery level of a device drops below 50% it will appear orange in the device status list. A critical battery status will appear red. If a device has lost its link or is no longer in range, it will appear yellow.*

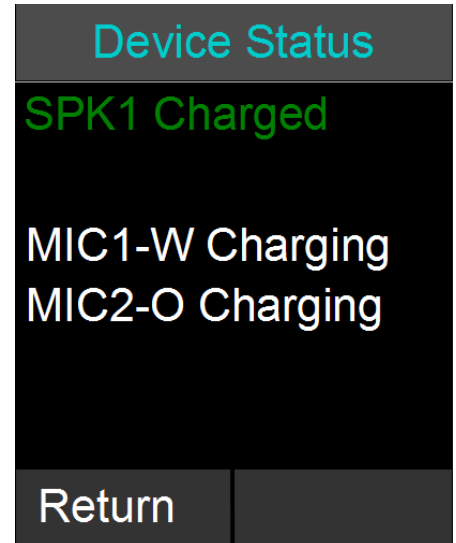

## System Information

The following is a list of FLX Dialer menus that allow the user to retrieve system information.

### System Info

1. Browse to System Info: Menu → System Info.
2. About System shows the IP Address, firmware (FW) bundle version, the System Name, phone type information, and the extension number (logon) to the telephone switch.
3. Device Versions shows firmware version for the Speaker (SPK) and Microphones (MICx).
4. System Versions shows the firmware versions for the Application (APP), Baseband (BB), Bluetooth Base (BTB), and Bluetooth Dialer (BTH) software.
5. Device IDs shows the ID of the Speaker (S1) and the Microphones (Mx).
6. System ID shows the ID of the base.
7. Bluetooth Info shows information on the Bluetooth link between the handset and the base, including signal strength ('Link Info'). Under 'Bluetooth Status' it provides information about the Bluetooth identifiers, and which Bluetooth profiles are currently in use.

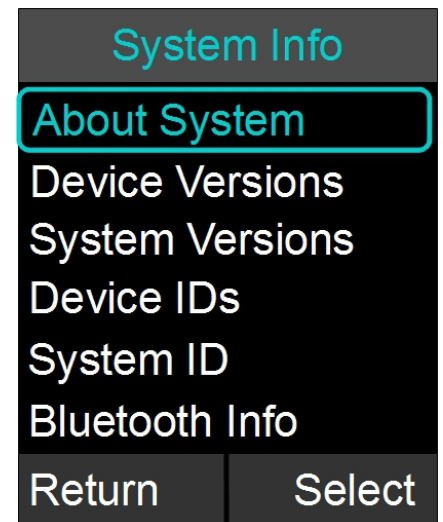

## Bluetooth

The 'Bluetooth' menu has been explained earlier in this manual on page 27.

## Home

When selecting the 'Home' menu item, the Dialer will go back to displaying the home screen. The same effect can be achieved by pressing the 'Return' key, or the red 'End Call' button.

## Call

When selecting 'Call' in the menu, the Dialer will open the Dialer menu, allowing entering and dialing a number.

## Setup

Setup is divided into a generic area of features that are not password protected and Advanced Setup, which requires a password.

### Display

1. Browse to the Display menu: Menu → Setup → Display.
2. The Display menu offers five options: Contrast, Brightness, Backlight time, whether the backlight is on or off while the Dialer is in the Charger Base, and to switch Network Alerts "Registration Failed" on or off.
3. Use the up and down buttons to highlight the setting you want to change, and press either 'Enter' or 'Select' to open that setting or change the setting.
4. Use the up and down buttons to increase or decrease the respective values.

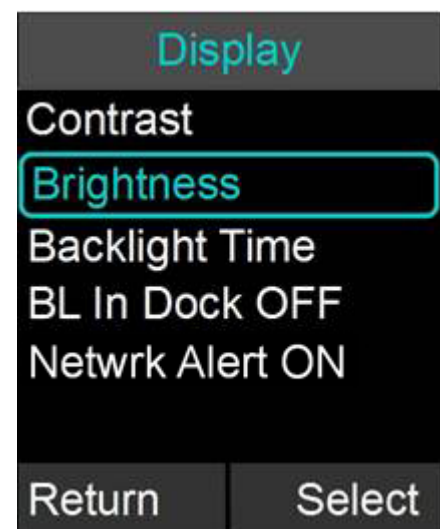
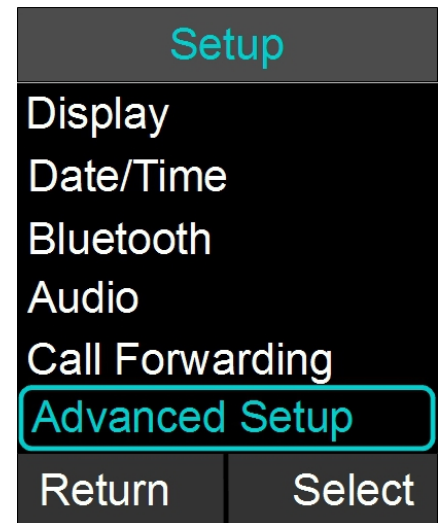

## Date/Time

1. Browse to the Date/Time menu: Menu → Setup → Set Date/Time.
2. To set the date or time, select either the 'Set Date', or 'Set Time' option, and press either 'Enter' or 'Select'.
3. Edit time and date (month/day/year) using the numeric keys and the left and right buttons. The 'Done' key will store the value; 'Cancel' will discard any changes you entered. To change the use of the network time, select the 'Netwrk Time ON/OFF' option. You change the setting by pressing the 'Select' key. If you select 'Netwrk Time ON' the FLX2 Conference Phone will attempt to derive the date and time from the IP network.
4. Date Time Format leads to a sub menu where the format in which date and time are displayed can be selected. The time format can be set to 12 Hr or 24 Hr, format depending on user preference. The offered date formats are MM/DD/YY, DD/MM/YY, or YY/MM/DD. While highlighting either setting, the "Enter" or "Select" key will change the different settings.
5. Time Zone allows the user to choose what the GMT offset at their location is.
6. Daylight Savings Time can be set ON or OFF. The rules when daylight savings time starts and ends have to be specified in the web interface.

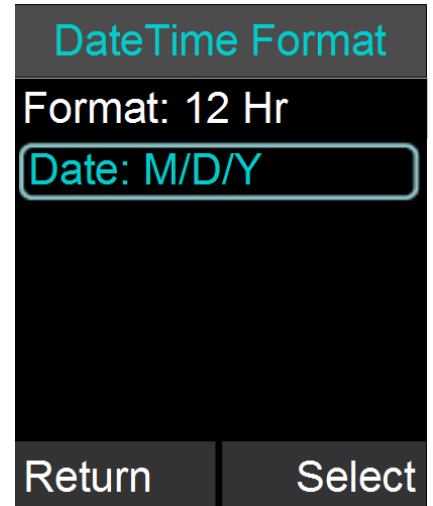
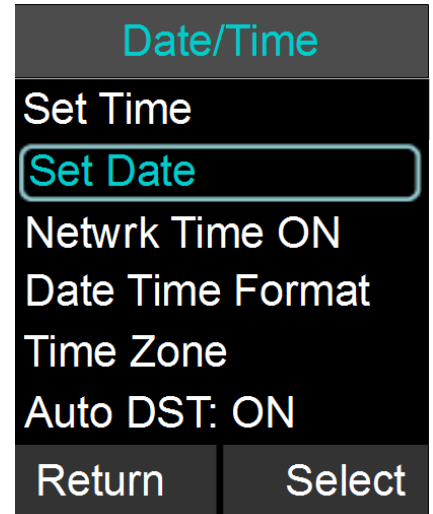

## Bluetooth, Audio

The menu entries for Bluetooth and Audio in the setup menu will open the top level menus of the same name described earlier in this documentation.

## Call Forwarding

1. To always forward incoming calls, switch 'Always' to 'ON' and enter the number to which to forward the calls.
2. To forward calls to another number when "Do not Disturb" is selected or both lines are busy, switch 'Busy' to 'ON', and enter the number to which to forward the calls.
3. To forward incoming calls when the call is not answered on the FLX system in a specific time, switch 'No Answer' to 'ON', and enter the number to which to forward the calls.

4. To set the time before the call is forwarded to the 'No Answer' number, select 'No Answer Delay' and set the time in seconds.

### Advanced Setup

The following is a list of advanced configuration settings that are protected by a 4 digit password for administrator access only. The default password is 7386 (revo). This password should be changed by the system administrator. Please ensure that you take note of the changed password.

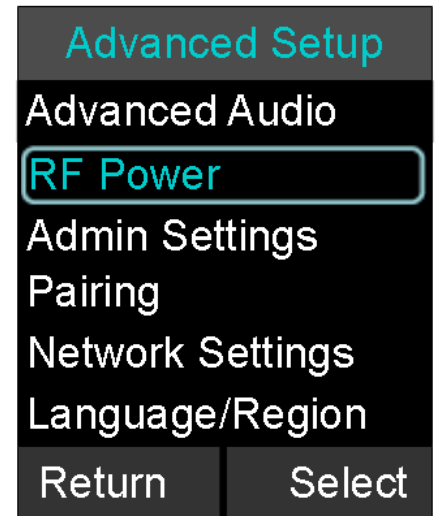

### Advanced Audio

Browse to Advanced Audio menu: Menu→ Setup→ Advanced Setup→ Advanced Audio.

### Mic Audio

The 'Mic Audio' allows controlling the Microphones.

1. If 'All Mic Mute' is ON, all active Microphones are affected when a mute button is pressed. If one or more active Microphones are outside the Charger Base, pressing the mute button will change the mute status on all Microphones outside of the Charger Base. Microphones in the Charger Base will not be affected and will remain off or stay muted at all times. If all Microphones are in the Charger Base, pressing the mute button will change the mute status of all Microphones in the Charger Base. The factory default for 'All Mic Mute' is OFF.
2. The 'Start Unmute' feature allows the Microphones to come out unmuted when taken out of charger. The factory default is ON.

## Aux Audio

'Aux Audio' is to control the AUX In and AUX Out connectors on the base.

1. Aux In ON/OFF and Aux Out ON/OFF allow enabling / disabling the Aux connectors of the FLX phone.
2. Aux In Level allows changing the level of the Aux In signal.
3. Aux Out Level allows changing the level of the Aux Out signal.
4. Aux Out – MIC / LINE allows setting the level of the Aux Out connectors to either Mic level or Line level.



## RF Power

The RF Power level setting allows changing the signal strength of the base station and microphones. Factory default is HIGH. Low or medium can be selected to reduce the signal strength. Lower signal strength reduces the maximum distance between base station and any of the wireless devices. A lower setting might be desirable in environments where a lot of DECT traffic is encountered.

1. Browse to the RF Power menu: Setup → Advanced Setup → RF Power.
2. The user can select low or high RF Power .

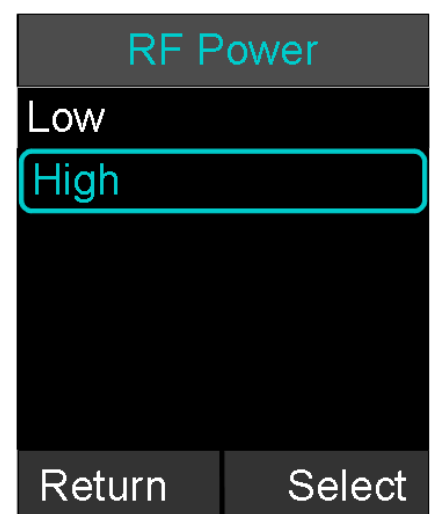

## Admin Settings

The Admin Settings menu allows changing settings that are related to general system settings.

### Setting System Name

1. Go to Menu → Setup → Advanced Setup → Admin Settings → Set System Name.
2. Change the current System Name to the new name, and press Enter.

### Reset Defaults

1. Go to Menu → Setup → Advanced Setup → Admin Settings → Reset Defaults.
2. Resetting defaults will revert back to factory defaults. Pairing of devices, recent calls, stored contacts, and the system name are not affected by this.

**NOTE:** Beside other values, 'Reset Defaults' will reset the administrative password to the factory default (7386).

### Set Password

1. Browse to the Set Password menu: Menu → Setup → Advanced Setup → Admin Settings → Set Password.
2. Set the password to an admin specified password. Note that setting this password will override the default password, so make sure that you will not lose the new password.

### Log Out Admin

1. Browse to Log Out Admin: Menu → Setup → Advanced Setup → Admin Settings → Log Out Admin.
2. Once logged out, the user will have to retype the admin password to enter the administrative menus again. If the user leaves the administrative menus without logging out, an automatic log-out will happen after about 15 minutes.

### Recent Calls ON / OFF

The Recent Calls option allows you to enable or disable logging of the recent calls. If

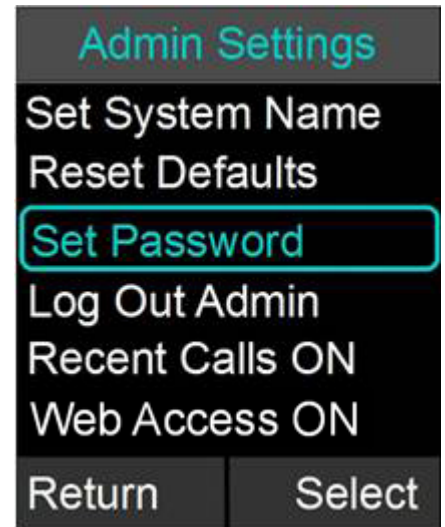

you switch Recent Calls OFF the list of the recent calls will be erased and no future information on recent calls will be kept in the system.

## **Web Access ON / OFF**

Web Access OFF allows you to disable the web interface into the FLX. If Web Access is set to off, any attempt to open the web interface will be declined. Please be aware that if the web interface is switched off, it can only be restarted from the phone.

## **Pairing**

All FLX2 wireless components are paired before the system is shipped, providing much of the system setup already completed. While pairing should not be required for the system to work, sometimes components can require pairing if a part is shipped separately.

The following are instructions on how to pair the wireless components of the system to the FLX2 Conference Phone. All components are paired to the Base, which is the central unit that communicates with all other components. To pair a Microphone or a Speaker to the FLX Conference Phone, a FLX Dialer has to be paired first. If several components need to be paired, or a whole system needs to be paired, start with the FLX Dialer.

### **Dialer**

1. Turn off the Dialer by pressing and holding the red 'end call' button until an overlay appears asking whether you want to shut the Dialer down. Press 'Yes'.
2. Plug in the FLX2 Base Station.
3. Turn the Dialer back on (press the red 'end call' key). The screen should read "Scanning for new base". If the screen reads "scanning for paired base", press the 'Stop' button, press the 'Menu' button, navigate to "Advanced", and select 'Re-Pair'. When asked whether to 'Scan for New Base', select 'Yes'.
4. After some time scanning for available bases, an overlay will appear asking 'Pair with <System Name>?' The system name is either the Factory preset name of RevoFlxxxx, with xxxx the last 4 digits of the BT number on the bottom of the Base station, or the system name you previously selected in the Advanced Setup. Select 'Yes'.
5. An overlay, 'Pairing with base <System Name>', should appear followed by a 'Connecting...' and then an 'Initializing...' screen. Shortly after that the Dialer home screen will appear. Your Dialer is now paired.
6. If the Dialer does not automatically pair, repeat steps 1-5. If this still does not resolve the problem, select "Reset Factory Defaults" under 'Advanced' as this will force a scan for a new base.

### **Speaker**

1. To pair a Speaker first turn it off by pressing and holding the button on the bottom

- of the Speaker until you hear the Speaker shut-off or the LEDs turn off.
2. Ensure that the Base Station is plugged in and powered up.
  3. On the Dialer, browse to the Pairing menu: Menu → Setup → Advanced Setup → Pairing.
  4. Select SPK 1 (Speaker 1) and press the 'Enter' or 'Pair' key to enter pairing state.
  5. The screen will display 'Pairing Speaker 1'.
  6. Press and hold the button on the bottom of the Speaker until the LED turns solid red. The speaker is now in pairing mode.
  7. After a short time an overlay will appear on the FLX Dialer saying 'Pairing Successful', after which the screen should read 'SPK 1 Linked'.
  8. If pairing was unsuccessful, the Speaker will show an alternating red -green slow blinking sequence indicating that the pairing failed. The Dialer will display a 'Pairing Timeout' message. In that case the pairing procedure should be repeated.

### Microphone

1. To pair a Microphone, turn off the Microphone by holding the mute button until the LED turns red if it is not already turned off.
2. Ensure that the Base Station is plugged in and powered up.
3. On the Dialer, browse to the Pairing menu: Menu → Setup → Advanced Setup → Pairing.
4. Select MIC 1 (Microphone 1) or MIC 2 (Microphone 2) and press the 'Enter' key to enter pairing state.
5. The screen will display 'Pairing Mic 1' or 'Pairing Mic 2' depending on which Microphone you are pairing.
6. Press the mute button on the Microphone and hold it until the LED turns solid red. The Microphone is now in pairing mode.
7. After a short time an overlay will appear on the Dialer 'Pairing Successful', after that the screen should read 'MIC 1 Linked' or 'MIC 2 Linked', based on which one you were pairing.
9. If pairing was unsuccessful, the Microphone will show an alternating red - green slow blink sequence, indicating that the pairing failed. The Dialer will display a 'Pairing Timeout' message. In that case the pairing procedure should be repeated.

### LED Pairing Indicators:

Speaker Indicator	Status
Steady Red	Speaker is in Pairing Mode, either waiting or pairing in progress
Slow red- green flash	Pairing failed or timed out
Green flash	Pairing successful
Microphone Indicator	Status
Steady Red	Pairing Mode, either waiting or pairing in progress
Slow red – green flash	Pairing failed or timed out
Green flash	Pairing successful



## Network Settings

1. Browse to the Network Settings menu: Menu → Setup → Advanced Setup → Network Settings.
  - a. You can change the DHCP configuration by turning it off and manually setting your IP address in the IP Settings. If DHCP is set to ON this takes precedent over static IP settings.

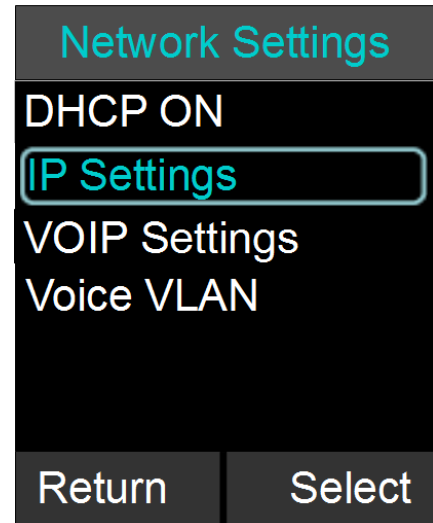

- b. IP Settings allows you to set the IP Address, Subnet Mask, Default Gateway, Primary DNS and Secondary DNS when you are not using DHCP. If you change any of these values, a sixth option 'Load Settings' will display to restart the FLX base with the changed settings.
    - c.

VoIP Settings allow you to set minimal required settings to connect to a VoIP switch. Registrar, Username, and Password (which can be empty) are required fields to connect to your IP PBX.

- i. 'Registrar' is either the IP address or server name of your IP PBX.
      - ii. 'ID' is the name used in messages to identify this phone. If ID is left open, the Username will be used as ID.
      - iii. 'Display Name' is the string that is shown at the far side when you make outbound calls. If you do not provide a Display Name, the Username will

be used. Please note that your IP PBX might override the Display name sent by the FLX and replace it with names configured in the PBX.

- iv. 'Username' is the extension off the IP PBX this phone will be reached under
  - v. 'Password' is the password used by the Username to logon to the IP PBX.
  - vi. If any value was changed, a sixth option 'Load Settings' is offered. This will reboot the FLX Base Station, applying the changed settings.
- d. Voice VLAN allows changing VLAN settings. Highlight the 'Mode' field and press Enter to switch between the three options. 'Auto' will automatically determine whether a VLAN is in place, and request the VLAN identifier from the network. 'Enabled' will enable the VLAN, but requires a VLAN identifier to be manually set in the Voice VLAN ID menu. 'Disabled' means that no Voice VLAN is in use.

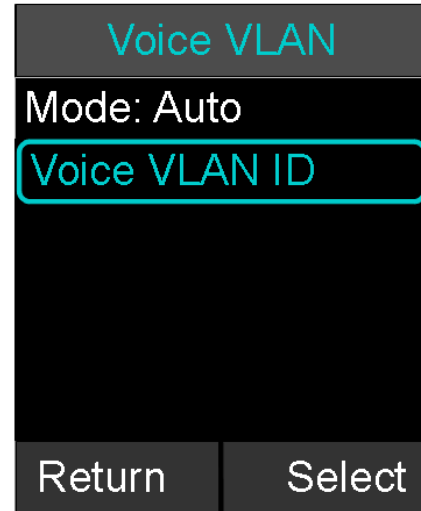

### Language / Region

1. Browse to the Network Settings menu: Menu → Setup → Advanced Setup → Language/Region.
  - a. The Language submenu allows selecting the dialer language from one of the six supported languages: The options are English, Español (Spanish), Français (French), Deutsch (German), Italiano (Italian), and Português (Portuguese). Highlight the language of your choice, and press either "Enter" or "Select" on the Dialer to select it. Once a language is selected, the system will use that language for all screen contents.
  - b. The Country/Region submenu allows

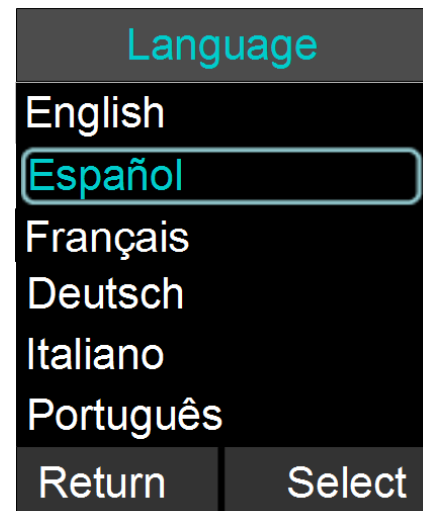
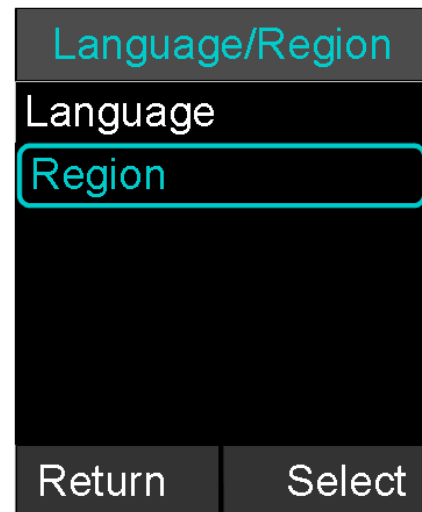

selecting the local Country or region. Please ensure that this selection is always set to your local country or region. Changing this setting might lead to loss of connectivity to the microphones and speakers. If your microphones and speakers do not automatically reconnect after changing the Region setting, you need to pair all of them again to your system.

**NOTE:** We recommend changing the Region setting only after previous consultation with Revolabs Support.

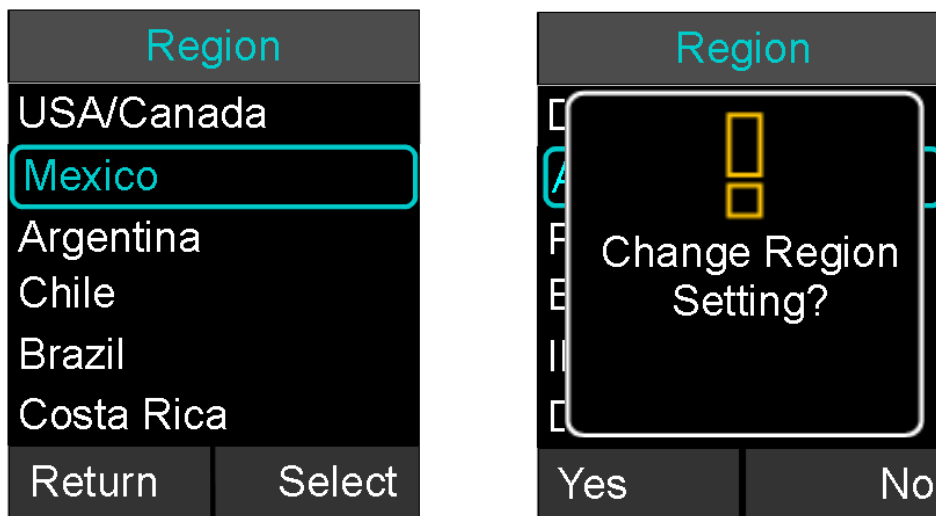

## Web Interface

The FLX web interface provides access to advanced configuration settings, call statistics and system logs. Web access can be enabled or disabled from the FLX Handset, and the web interface is password protected using the same password that is required to access Administrator settings on the FLX Handset.

This section describes the web interface, organized as follows:

- Enabling Web Access
- Connecting to the FLX Web Interface
- Home Page
- User Settings
- Administrator Settings

The Administrator Settings section also describes how FLX configuration settings can be imported and exported to aid in configuring multiple FLX phones in an enterprise.

## Enabling Web Access

To enable the web interface, from the FLX Handset select Menu > Setup > Advanced Setup, enter the administrator password, then select Admin Settings > Web Access ON/OFF. Press the Enter button to toggle between ON and OFF to control access. Factory default is web access enabled. To change the password needed to access both the web interface and advanced settings on the Handset, see the Set Password section on page 46. The web interface also includes a web session timeout to protect against unwanted access if the session is left open for more than fifteen minutes.

## Connecting to the FLX Web Interface

To use the web interface, open a web browser and navigate to the IP address of the FLX. If you do not know the IP address of your FLX system, on the handset open the menu, System Info, About System. The IP address is listed here. The Login page will appear as shown below.

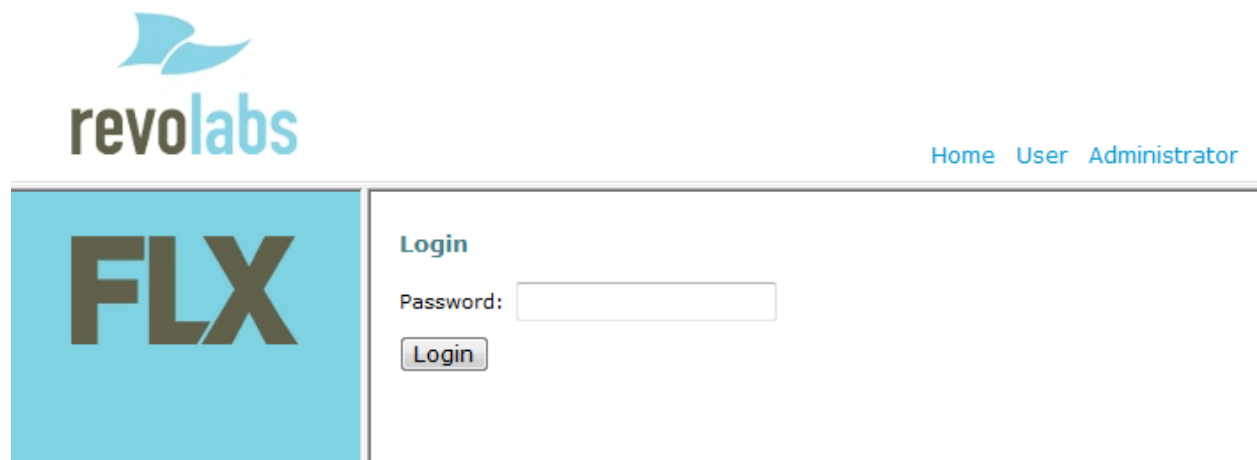

The screenshot shows the FLX web interface login page. At the top left is the Revolabs logo. At the top right are navigation links: [Home](#), [User](#), and [Administrator](#). On the left side, there is a large blue box with the text "FLX" in white. To the right of this box is a "Login" section. It contains the text "Login" in bold, followed by "Password:" and a text input field. Below the input field is a "Login" button.

Enter the administrator password and click Login.

After logging in, the FLX Home page will appear. The FLX web interface is organized into three categories: Home, User and Administrator. Choose any one of these categories by clicking on the corresponding link in the upper right corner.

## Home Page

The Home page shows general information about the system as shown below.

### System Information

Product:	FLX VoIP Phone
System IP Address:	10.134.122.219
Physical Address:	ac:44:f2:01:0a:0d
Base Version:	2.0.42
Speaker 1 Version:	2.0.42
Speaker 2 Version:	unknown
Mic 1 Version:	2.0.26
Mic 2 Version:	2.0.26

The Product field is a brief description of the FLX phone to which you are connected. The System IP Address shows the IP address of the device, whether it was configured by DHCP or with a static IP address. The Physical Address is the MAC address of the phone. The remaining fields show the software versions of the FLX base, speaker and microphones, respectively. If the microphones have not been removed from the charger tray, the microphone versions may be shown as “unknown.” To update these fields, remove the microphones from the charger tray, wait a few seconds for the phone to detect the microphone state, and then refresh the web page by selecting your browser’s refresh option. If the microphones or the speaker still do not show a version number, verify that these components are paired properly. See the pairing instructions in this manual. If no second speaker is used with the system that entry will always show “unknown”.

## User Settings

In the upper right corner click the User link to access the User settings. The User Menu will appear on the left side of the page showing these options:

- Audio
- Call Forwarding
- Date/Time
- Restart
- Logout

Choose a User Menu option to show the corresponding page.

## Audio

The Audio page can be used to configure audio settings and audio mixer settings of your FLX. These settings are also available on the Handset. The figure below shows the Audio page, followed by a description of each setting. After changing any of the settings, click Save to save the settings. If you navigate away from any of the web pages without saving settings, the changes on that page will be lost.

### Audio

Ringer Volume:

Ring Tone:

EQ Setting:

Play Charging Announcement:

### Audio Mixer

Speaker Mix:

Phone Out Mix:

Aux Out Mix:

Audio	
Ringer Volume	Choose the speaker volume for the ring tone played when the phone receives an incoming call. This setting is separate from call volume, which is set from the Handset while in a call. The range of values is 0-16.
Ring Tone	Select from one of the six provided ring tones, Ring 1-Ring 6.
EQ Setting	The Equalizer setting allows you to adjust the speaker frequencies to your preference for the room and the types of calls. The EQ options are: Voice, Bass Boost, and Treble Boost.
Play Charging Announcement	Enable / Disable playing the message reminding users to return the components to the charger tray after a conference call.
Audio Mixer	
<i>The settings below can be changed at any time during a call.</i>	
Speaker Mix	The Speaker Mixer specifies the mix between AUX IN and the phone input to be played back on the speaker. It is a sliding scale from -8 (favoring phone) to +8 (favoring AUX IN).
Phone Out Mix	The Speaker Mixer specifies the mix between the microphones and AUX IN to be transmitted to the far end during a call. It is a sliding scale from -8 (favoring microphones) to +8 (favoring AUX IN).
Aux Out Mix	The Aux Out Mixer specifies the mix between the microphones and

	the phone audio received from the far end while in a call. It is a sliding scale from -8 (favoring microphones) to +8 (favoring phone).
--	---

**Call Forwarding**

The Call Forwarding settings are used to forward incoming calls to another phone. There are three conditions that can be set to determine when to forward calls, as shown in the figure below.

**Call Forwarding**

Always Forward:  Forward Number:

Forward on Busy:  Forward Number:

Forward on No Answer:  Forward Number:

Delay on No Answer:

<b>Call Forwarding</b>	
Always Forward	The Always Forward option will forward all incoming calls to the specified number.
Forward on Busy	The Forward on Busy option will forward incoming calls to the specified number if the local phone is in “Do Not Disturb” mode or if both lines are busy.
Forward on No Answer	The Forward on No Answer option will forward incoming calls to the specified number if the call is not answered within the duration specified in the “Delay on No Answer” field.
Delay on No Answer	Specify the number of seconds to wait before forwarding an unanswered incoming call to the “Forward on No Answer” number. The default is 20 seconds.

**Date/Time**

The Date/Time page is used to specify how the date and time are to be set, either automatically or manually, and the time zone and Daylight Saving Time rules for your locale.

Below is an illustration showing the Date/Time page settings followed by a table describing each field.

## Date/Time

Network Time:

Time Zone:

Daylight Saving Time (DST):

DST Start Rule: Month:  Week:  Day:  Hour:

DST End Rule:

Date/Time	
Network Time	To enable the system to automatically detect the local date and time by using a public Date Time Server (DTS), set the Network Time to On. If you want to manually specify the local date and time, choose Off. See page 43 for instruction on how to manually set the date and time using the FLX Handset.
Time Zone	Select the local time zone, indicated as an offset from Greenwich Mean Time (GMT). These are the available time zones: -11 Samoa, -10 Hawaii, -9 Alaska, -8 Pacific Time, -7 Mountain Time, -6 Central Time, -5 Eastern Time, -4:30 Caracas, -4 Atlantic Time, -3:30 Newfoundland, -3 Brazil/Argentina, -2 Mid Atlantic, -1 Azores, 0 GMT, +1 Berlin/Paris, +2 Athens, +3 Kuwait, +3:30 Tehran, +4 Moscow, +4:30 Kabul, +5 Islamabad, +5:30 Mumbai, +5:45 Kathmandu, +6 Yekaterinburg, +6:30 Yangon, +7 Bangkok, +8 Beijing/Hong Kong, +9 Tokyo, +9:30 Adelaide, +10 Sydney, +11 Vladivostok, +12 Auckland, +13 Nuku'alofa
Daylight Saving Time (DST)	Use the Daylight Saving Time (DTS) option to specify whether or not you want the system to automatically adjust the time according to your locale's DTS rules.
DST Start Rule and DST End Rule	Use the DST Start Rule and DST End Rule options to indicate the month, week, day and hour that the time changes. The illustration above shows the default DST rules for the United States.
Month	Select the month in which DST changes.
Week	For the specified month, select the week in which DST changes. For example, if DST changes on the second Sunday of the selected month, choose "Second."
Day	Select the day on which DST changes, for example, Sunday.
Hour	Select the hour at which DST changes. For example, if DST changes at 2:00 a.m., choose 2.



## Restarting the Phone

To restart the phone, choose Restart from the User menu or Administrator menu on the left of the page. On the Restart page click the Restart button as shown below.

### Restart the Phone

Restart

The page will indicate that the system is restarting. After the phone has restarted, choose the web browser's refresh option to refresh the web session. You will return to the Login page.

## Logging Out of the Web Session

When you login to the FLX web interface, the web session will remain active for fifteen minutes. Once the session times out, the user will need to login again. This is a security measure to protect against unwanted access if the web client is left unattended. To force the web session to close before the timeout interval, choose Logout from the User Menu or Administrator Menu on the left of the page, then click the Logout button as shown below.

### Logout

Logout

## Administrator Settings

In the upper right corner click the Administrator link to access the Administrator settings. The Administrator Menu will appear on the left side of the page showing these options:

- Network
- SIP Registration
- SIP Configuration
- Transport
- Media
- Call Settings
- Advanced Audio
- RF Settings
- Access Control
- Language and Country
- Import/Export
- System Log
- Call Status
- Restart
- Logout

Choose an Administrator Menu option to show the corresponding page.

## Network Settings

Use the Network Settings page to specify how IP addressing is to be determined for the phone connected to the IP network. You can use DHCP to automatically detect the phone's IP address and network server settings, or you can manually specify a static IP address for the phone and the network server addresses provided by your network administrator. If you select Static IP as the Connection Type, you will have to provide the Static IP Address, Subnet Mask, and Default Gateway. If DHCP is set, it will take precedent over manually entered Static IP information.

The illustration shows the Network Settings page. Note that after changing any settings, the changes must be saved and the phone must be restarted for the changes to take effect.

### Network Settings

Connection Type:	<input type="text" value="DHCP"/>
Static IP Address:	<input type="text"/>
Subnet Mask:	<input type="text"/>
Default Gateway:	<input type="text"/>
Domain Name:	<input type="text"/>
Primary DNS Server:	<input type="text"/>
Secondary DNS Server:	<input type="text"/>

### VLAN Settings

Voice VLAN:	<input type="text" value="Disabled"/>
Voice VLAN ID:	<input type="text"/>

### NTP Servers:

Server 1:	<input type="text"/>
Server 2:	<input type="text"/>
Server 3:	<input type="text"/>
Server 4:	<input type="text"/>

<b>Network Settings</b>	
Connection Type	Select the network connection type, either DHCP or Static IP. If you choose Static IP, specify the Static IP Address, Subnet Mask, and Default Gateway in the fields below.
<b>Static IP Settings</b>	
Static IP Address	The Static IP Address is the IP address that the network administrator has assigned to the phone.
Subnet Mask	Subnet Mask is used to determine the subnet to which the phone belongs, for example, 255.255.255.0.
Default Gateway	The Default Gateway is the phone's default router on the IP network. It is usually the router connecting the internal network with the outside network.
Domain Name	This is the network domain name.
Primary DNS Server	This is the address of the primary Domain Name System (DNS) server that translates domain names into IP addresses. Sites often configure a primary DNS server and a secondary backup DNS server.
Secondary DNS Server	This is the address of the secondary DNS server.
<b>VLAN Settings</b>	
Voice VLAN	The options are Enabled, Disabled, or Automatic. "Enabled" indicates that a VLAN is used. The Voice VLAN ID has to be specified, the system is not trying to determine the VLAN automatically. Use this setting if the FLX was not able to detect the VLAN environment automatically. "Disabled" switches off VLAN capabilities. The FLX will only communicate using the standard IP network. "Automatic" should be used in environments that provide a Voice VLAN with automatic detection. The FLX will determine the VLAN identifier and register in that network.
Voice VLAN ID	Manually specify a VLAN identifier. This setting requires the Voice VLAN selector to be "Enabled".
<b>NTP Servers</b>	
Server 1 – Server 4	Specifies the IP addresses of NTP (Network Time Protocol) servers. The FLX will provide standard NTP servers at start-up. If local NTP servers or other NTP servers should be used, provide them in these settings.

## SIP Registration

The SIP Registration page is used to configure the SIP registrar and proxy settings and the SIP account and user settings for the phone. The minimum number of information required to register your phone is the Registrar, the Username and Password. If ID and Display Name are not set, FLX will use the user name for both of these parameters. Some IP PBXs an ID different from the user name to be set. You must register successfully to the SIP registrar before you can make calls with your FLX.

The figure below shows the SIP Registration page. After changing any settings, the changes must be saved and the phone must be restarted for the changes to take effect.

### SIP Registration

Registrar:	<input type="text" value="10.10.10.10"/>
Backup Registrar:	<input type="text" value="10.10.10.11"/>
Use Proxy for Registration:	<input type="text" value="No Proxy"/>
Outbound Proxy:	<input type="text"/>
ID:	<input type="text" value="1234"/>
Display Name:	<input type="text"/>
Username:	<input type="text" value="1234"/>
Password:	<input type="password"/>
Registration Timeout (sec):	<input type="text" value="55"/>
Auto Re-registration Retry Interval (sec):	<input type="text" value="300"/>

The table below describes the SIP Registration settings. Different IP PBX providers might use different names in their setup. The descriptions below will help you in mapping the FLX fields to your IP PBX fields.

SIP Registration	
Registrar	This is the IP address or DNS name of the SIP registrar server.
Backup Registrar	This field can hold the IP address of a failover SIP registrar, it should be configured with the failover or secondary SIP registrar IP address or domain name if applicable. If no failover or secondary SIP registrar is present in the VoIP infrastructure, this field should be left blank.

	When this field is specified, the phone will register with the primary SIP registrar (The “Registrar” field) if it is accessible. If the primary SIP registrar becomes inaccessible via UDP or TCP, the phone will attempt to register with the backup registrar. If the phone successfully registered with backup registrar, it will switch to the backup registrar to perform outgoing calls and receive incoming calls. While the phone is registered with the backup registrar, it will monitor the primary SIP registrar connection. Once the primary SIP registrar becomes available again, the phone will roll back to register with the primary registrar and route SIP traffic from/to the primary registrar.
Use Proxy for Registration	Use this option to indicate whether or not the SIP proxy server(s) specified in the Outbound Proxy field should be used when registering. Select “Use Outbound Proxy” to have the system add listed proxy servers to the route headers of the SIP REGISTER request.
Outbound Proxy	Enter the outbound SIP proxy server’s IP address or name in the Outbound Proxy field. If there are multiple SIP proxies, separate the addresses by a comma. Also note that on the SIP Settings page there’s an option to allow strict routing. If that option is set and you have a SIP proxy that is configured for loose routing, add the “;lr” designation after the proxy’s address, for example, “10.134.129.101;lr”.
ID	ID is the phone’s SIP ID used for SIP registration. If this field is left blank, the Username field will be used as the ID.
Display Name	Display Name is the string that is shown at the far side when you make outbound calls. If you do not provide a Display Name, the Username will be used. Please note that your IP PBX might override the Display name sent by the FLX and replace it with names configured in the PBX.
Username	This is the username for the account used to authentication with the SIP registrar and proxies.
Password	This is the password for the account used to authenticate with the SIP registrar and proxies.
Registration Timeout	Registration Timeout is the optional timeout for SIP account registration, in seconds. The default is 55. If set to 0, the default will be used.
Auto Re-registration Retry Interval	If SIP registration is unsuccessful, this field specified the time duration between retry attempts, in seconds. The default is 300 seconds (5 minutes).

## SIP Settings

Use the SIP Settings page to configure settings related to SIP sessions, as shown in the illustration below. After changing any of these settings, the phone must be restarted for the changes to take effect.

### SIP Settings

Use SIP session timers:	Always ▼
Session timers expiration period (sec):	1800
Session timers minimum expiration period (sec):	90
Require reliable SIP provisional response:	<input type="checkbox"/>
Enable SIP traversal behind symmetric NAT:	<input checked="" type="checkbox"/>
Suppress SIP event subscription when transferring calls:	<input type="checkbox"/>
Allow strict routing:	<input type="checkbox"/>
Minimize SIP message size:	<input type="checkbox"/>
DTMF signaling method:	RTP (RFC2833) ▼
Media on-hold method:	M line only (RFC3264) ▼

SIP Settings	
Use SIP session timers	<p>Specify the preference for using SIP session keep-alive timers. During a SIP session, if SIP session timers are active, the SIP User Agent (UA) periodically sends INVITE or UPDATE requests (also called refresh requests) to keep the SIP session alive. The interval and use of the keep-alive is determined at call negotiation. If one of the UAs in a call does not receive the refresh request within the expiration timeout period, it will terminate the session.</p> <p>The available options in FLX are:</p> <p><i>Inactive</i> – Session Timers will not be used in any session, except if explicitly required in the remote request.</p> <p><i>Optional</i> – Session Timers will be used in all sessions whenever the remote supports and uses it.</p> <p><i>Required</i> – Session Timers support will be a requirement for the remote to be able to establish a session.</p> <p><i>Always</i> – Session Timers will always be used in all sessions, regardless of whether or not the remote supports or uses them. This option is the FLX default.</p>
Session timers	The expiration period is the interval at which the phone will consider

expiration period	the SIP session timed out if it does not receive a refresh message from the remote phone. It is measured in seconds; the default is 1800. At call negotiation, the nodes will negotiate the expiration period to be used for the session.
Session timers minimum expiration period	This is the minimum session timer expiration period that FLX will accept when negotiating the expiration period with the remote phone. It is measured in seconds; the default is 90.
Require reliable SIP provisional response	Select this option to implement reliable SIP provisional responses. By default the setting is unchecked. SIP is a request-response type of protocol with two types of responses: provisional and final. Final responses are sent reliably, using an ACK to ensure receipt. Provisional responses by default are not sent reliably and do not require an ACK; however, in some cases, such as for PSTN interoperability support, reliability of provisional types of responses is needed. Choose this option to add the PRACK (provisional ACK) message support for reliability.
Enable SIP traversal behind symmetric NAT	This option may be used when the phone is behind a symmetric NAT (Network Address Translation). When enabled, FLX will keep track of the public IP address from the response of the REGISTER request. If it detects that the address has changed, it will unregister the current Contact, update the Contact with the transport address obtained from the Via header, and register a new Contact to the SIP registrar. This option will also update the public name of the UDP transport if STUN is configured.
Suppress SIP event subscription when transferring calls	When transferring a SIP call, the SIP REFER process automatically establishes a temporary event subscription to notify the party initiating the transfer about the receiver's status in handling the REFER. In some cases these event subscriptions and notifications are not needed, such as when forking is not used. Enable this option to suppress the automatic event subscriptions when transferring calls. The option is disabled by default.
Allow strict routing	By default, proxies specified on the SIP Registration page will be configured as loose-routing proxies. The loose-routing designation (";lr") will be automatically appended to each proxy address when the proxy is added to the SIP Route header. Older proxies may be strict-routing (see IETF RFC 2543), not supporting loose routing (see IETF RFC 3261). Enable this option if you are using strict-routing proxies. If this option is enabled and you are specifying one or more loose-routing proxies in the SIP Registration page's Outbound Proxy field, then you must manually add the ";lr" suffix to each loose-routing proxy address. For example, "10.134.123.101;lr".
Minimize SIP message size	The SIP protocol specifies that header field names can be in the full name form or in the abbreviated form. Abbreviated form is useful when messages might be too large to be carried on the available transport, for example when exceeding UDP's Maximum Transmission Unit (MTU). Enable this option to encode SIP headers

	in their short forms to reduce size. By default, the option is not enabled and SIP headers in outgoing messages will be encoded in their full names. (See SIP protocol standard, IETF RFC 3261.)
DTMF Signaling Method	Select the signaling method for transmitting DTFM tones, either via RTP (RFC2833) or SIP INFO messages. The default is RTP.
Media on-hold method	The Media on hold method setting allows switching the Media on Hold behavior between the different RFC definitions. “M line only (RFC3264)” implements the functionality according to RFC3264. In the INVITE message SDP body, the attribute “a=sendonly” is set to a designated media stream to put media on-hold. “M and C line (RFC2543)” implements the functionality according to RFC2543. In the INVITE message SDP body, the connection line ip is set to “0.0.0.0” (e.g. “c= IN IP4 0.0.0.0”), and the attribute “a=inactive” is added.



## Transport

Use the web interface's Transport page to manage transport and Network Address Translation (NAT) settings, and to enable or disable Quality of Service (QoS). The illustration below shows the Transport page. After changing any of these settings, the phone must be restarted for the changes to take effect.

### Transport Settings

Use SRTP:	<input type="text" value="Disabled"/>
Start RTP Port:	<input type="text" value="4000"/>
TCP/UDP Selection:	<input type="text" value="Both TCP and UDP"/>
Local TCP/UDP Port:	<input type="text" value="5060"/>
IP Address (SIP and RTP address):	<input type="text"/>
Bound IP Address (bind transports to this address):	<input type="text"/>

### NAT Settings

STUN Server:	<input type="text"/>
Use ICE:	<input type="checkbox"/>
ICE Nomination Method:	<input type="text" value="Aggressive"/>
Maximum number of ICE host candidates:	<input type="text"/>
Disable RTCP component in ICE:	<input type="checkbox"/>
Enable TURN relay with ICE:	<input type="checkbox"/>
TURN Server:	<input type="text"/>
TURN Username:	<input type="text"/>
TURN Password:	<input type="text"/>
Use TCP connection to TURN server:	<input type="checkbox"/>

### QoS

Enable QoS:	<input type="checkbox"/>
-------------	--------------------------

<b>Transport Settings</b>	
Use SRTP	Use this setting to control Secure Real-time Transport Protocol (SRTP) usage. These are the available options: <i>Disabled</i> – Do not use SRTP; always use RTP. This is the default setting. <i>Optional</i> – Use the optional disposition for SRTP in SDP. If the remote end supports SRTP, then use SRTP; otherwise, use RTP. <i>Mandatory</i> – Force use of SRTP. If the remote end does not support SRTP, the call does not connect. <i>Optional by duplicating media offer</i> – Use duplicated media, both secured and unsecured versions, in the SDP offer.
Start RTP Port	This is the base port number for RTP. The default is 4000. RTP is originated and received on even port numbers, and the associated RTCP uses the next higher odd port number. The range is 0 to 65535.
TCP/UDP Selection	Select the transport that will be enabled for SIP messages. The options are: Both TCP and UDP, TCP Only, and UDP Only. The default is Both TCP and UDP. Note that UDP will be used if it is available.
Local TCP/UDP Port	Specify the local port for SIP transport. The default is 5060 for UDP and TCP. (Both use the same port.) The range is 0 to 65535.
IP Address (SIP and RTP address)	Optional. If specified, use this IP address (or hostname) as the advertised SIP and RTP address of this transport (the public address). The IP address does not have to correspond with one of the local host network interfaces; it may be the public IP address of a NAT router where port mappings have been configured for the phone application.
Bound IP Address	Optional. Bind the SIP and media transports to the specified IP address. The IP address must be an IP address of one of the host network interfaces.
<b>NAT Settings</b>	
STUN Server	Optional. Specify the STUN (Session Traversal Utilities for NAT) server to use to determine if the phone is behind a NAT, the type of NAT, and the public address of the phone. The field can contain a comma separated list of servers. Each server can be a domain name, host name, or IP address, and it may contain an optional port number. (For STUN see IETF RFC 5389.)
Use ICE	Check this option to use the ICE (Interactive Connectivity Establishment) protocol for NAT traversal. This option is checked by default. ICE takes advantage of STUN and TURN to identify candidates (IP addresses and ports) for communication, evaluating and prioritizing the candidate pairs to select the best route. Expensive candidates, such as using a media relay, are selected only as a last resort. (For ICE see IETF RFC 5245.)
ICE Nomination Method	When using ICE, select the preferred ICE Nomination Method. To validate candidate pairs (IP addresses and ports for the local and

	<p>remote nodes), FLX sends STUN binding requests as part of the media connectivity tests. When a candidate is nominated for use, a STUN binding request is sent with a flag indicating that the candidate pair is nominated. There are two nomination methods that can be used:</p> <p><i>Regular</i> – For Regular Nomination, FLX validates candidate pairs with initial STUN binding requests, and then selects a valid candidate pair by sending another STUN binding request with a flag indicating that the pair is nominated.</p> <p><i>Aggressive</i> – For Aggressive Nomination, FLX doesn't wait to set the nominated flag in a second STUN binding request, but rather sets the flag in the STUN binding requests for all of the candidate pairs. The ICE processing completes when the first pair successfully passes connectivity checks. The aggressive method is faster but does not always result in the optimal path being selected. This is the default method.</p>
Maximum number of ICE host candidates	An ICE host candidate is an actual local transport address in the host. Host transport addresses are obtained by binding to attached network interfaces. These interfaces include both physical interfaces and virtual interfaces such as VPN. This option specifies the maximum number of local ICE host candidates that may be used in evaluating candidate pairs when determining the best route. The default value is -1 or an empty field, which indicates that there is no maximum.
Disable RTCP component in ICE	Select this option to disable the RTCP component in ICE. The option is unchecked by default.
Enable TURN relay with ICE	Select this option to enable the use of a TURN (Traversal Using Relay NAT) relay when using ICE. A TURN relay is a media relay server residing on the public internet which can relay media data packet between clients. TURN relays are used when other preferred mechanisms are not available, such as STUN or direct connectivity. The option is unchecked by default. If TURN is enabled, the TURN settings below (server, username and password) must also be specified.
TURN Server	Specify the TURN server domain name or hostname. The format is either "DOMAIN:PORT" or "HOST:PORT"
TURN Username	Specify the username to authenticate against the TURN server.
TURN Password	Specify the password to authenticate against the TURN server.
Use TCP connection to TURN server	Use TCP to communicate with the TURN server rather than UDP. This option is unchecked by default.
<b>QoS</b>	
Enable QoS	Select this option to enable QoS (Quality of Service) tagging for SIP and media. For layer 3, at the Internet layer, the DiffServ (Differentiated Services) precedence level is Class 3. The

	Differentiated Services Code Point (DSCP) in the IP header is set to 24 (0x18). For layer 2, IEEE 802.1p tagging is supported. This option is unchecked by default.
--	---

**Media Settings**

Use the Media page to specify the preferred audio codecs and other audio stream processing preferences as shown in the illustration below. After changing any of these settings, the phone must be restarted for the changes to take effect.

**Media Settings**

Codec 1:

Codec 2:

Codec 3:

Codec 4:

Audio Quality (decrease to reduce CPU usage):

Codec ptime override (msec):

Disable silence detector/voice activity detector:

Jitter buffer maximum delay (ms; -1=auto):

<b>Media Settings</b>	
Codec 1, 2, 3, 4	Use the four codec fields to specify the preferred audio codecs to use, listed in priority order. The supported codecs are: G.722, G.711 $\mu$ -law (PCMU), G.711 $\alpha$ -law (PCMA), and G.726-32kbps. If fewer than four codecs are desired, choose "Disabled" for the unused codec options. Please note that at least one Codec has to be provided as Codec 1 does not offer the option "Disabled". The default precedence order is as shown in the list above.
Audio Quality	The Audio Quality setting determines which audio resampling method to use. A higher number uses a more sophisticated resampling method (ranging from a large filter to smaller filters down to a linear method). More sophisticated resampling requires more CPU processing, but delivers better audio quality. Audio Quality can be set to values between 1 and 10, with 6 being the default.
Codec ptime override	The ptime (packetization interval) value for a codec determines the length of time in milliseconds represented by the media in an RTP packet which is used to transmit audio traffic. The valid range is 10-1000. Leave the field blank to use the default value. For all of the codecs supported by FLX, the default ptime value is 20 ms/packet.

Disable silence detector/voice activity detector	Select this option to disable silence detector/voice activity detector (VAD). VAD is a technique used in audio processing to detect the presence or absence of human speech. Disabling VAD is sometimes useful to work around NAT problems. This option is unchecked by default.
Jitter buffer maximum delay	Specify the jitter buffer maximum delay in milliseconds. Leave the field empty or specify -1 to use the default. The FLX default is 500 ms.

## Call Settings

From the Call Settings page you can choose to automatically answer calls, set the maximum call duration, and enable or disable the FLX Handset's message waiting indicator. The figure below shows the Call Settings page. After changing any of these settings, the phone must be restarted for the changes to take effect.

### Call Settings

Auto-answer:

Maximum call duration (sec):

Enable message waiting indication:

Call Settings	
Auto-answer	<i>This option allows to automatically answer calls even if not physically at the location where the phone is located. We recommend enabling this feature only for test purposes.</i> Enable Auto-answer to automatically answer incoming calls. If the phone is set to Do Not Disturb or if there are no available lines, the Forward rules will apply. If there are no Forward rules specified, the incoming call will be sent to voice mail. If voice mail is not supported, the call will be rejected.
Maximum call duration	Specify the maximum call duration in seconds. When the call duration reaches the maximum duration, the call will be automatically terminated. An empty field indicates no maximum.
Enable message waiting indication	Select this option to display the message waiting indicator (MWI) on the FLX handset and to enable message waiting notifications from the PBX. The PBX must be configured to support voice mail for the registered user in order for this feature to work properly.

## Advanced Audio Settings

Use the Advanced Audio Settings page to specify microphone mute behavior, AUX audio in and out settings, and Acoustic Echo Cancellation (AEC) settings. The illustration below shows this page. The settings and options on this page reflect the same settings as can be done on the handset, allowing remotely setting and managing the phone behavior.

Any changes on this page take effect as soon as the settings are saved; it is not necessary to restart the phone, but it is necessary to press “Save” for the change to be taken into the phone.

### Advanced Audio Settings

All Mic Mute	Off ▾
Start Mute:	On ▾
Aux In:	On ▾
Aux Out:	On ▾
Aux In Level:	7 ▾
Aux Out Level:	7 ▾
Aux Out Mic/Line:	Line ▾

Save

Advanced Audio Settings	
All Mic Mute	If “All Mic Mute” is On, all active microphones are affected when a mute button is pressed. If one or more active microphones are outside the Charger Base, pressing the mute button will change the mute status on all microphones outside of the Charger Base. Microphones in the Charger Base will not be affected and will stay muted at all times. If all microphones are in the Charger Base, pressing the mute button will change the mute status of all microphones in the Charger Base. The default for “All Mic Mute” is Off.
Start Mute	The “Start Unmute” option specifies that microphones will be unmuted when taken out of the Charger. The default value is On.
Aux In, Aux Out	The “Aux In” and “Aux Out” settings are used to enable and disable Aux audio connections on the FLX Base.
Aux In Level, Aux Out Level	The “Aux In” and “Aux Out” settings are used to change the level of the Aux In and Out signals. The range is 1-15.
Aux Out Mic/Line	Use Aux Out Mic/Line to set the level of the Aux Out connectors to either Mic level or Line level.

## RF Setting

Use the RF Setting page to set the Radio Frequency (RF) signal strength of the base station and microphones. There are two RF Power settings: High or Low. The default is High. Low can be selected to reduce the signal strength. Lower signal strength reduces the maximum distance between the base station and any of the wireless devices. A lower setting might be desirable in environments where more wireless DECT traffic is encountered.

The illustration below shows the RF Setting page. It is not necessary to restart the phone after changing the RF Power setting, but it is necessary to press “Save” for the change to be taken into the phone.

### RF Setting

RF Power:

## Access Control

Use the Access Control page to set the system password, enable or disable the Recent Call list on the FLX Handset, and enable or disable web access. The illustration below shows the Access Control page. You do not need to restart the phone for changes to take effect, but will need to press “Save” for the change to be taken into the phone.

### Access Control

Password:

Recent Call Enabled:

Web Access Enabled:

Access Control	
Password	The password is used to control access to the web interface and the advanced Administrator settings on the FLX Handset. The password must be four digits. The default password is 7386. This password should be changed by the system administrator. Please ensure that you take note of the changed password.
Recent Call Enabled	Use the Recent Call Enabled option to enable or disable the Recent Calls list on the FLX Handset. The default setting is On.
Web Access	Use the Web Access Enabled option to enable or disable the FLX

Enabled	web interface. If access is enabled, users can browse to the FLX using a web browser. Even if enabled, the web interface is password protected for all pages. It is restricted to Administrator use. If disabled, any web-access is rejected. Once web access is disabled, it can only be enabled again by an administrator from the handset. The default setting is On
---------	---

## Language and Country

### Language and Country

Language:

Country/Region:

Language and Country	
Language	Select the handset language from the list of available languages.
Country / Region	Select the country or region you are in. This selection will affect country specific settings. Please change this setting from the current region to another region only if you move the unit to that different country/region, or if advised by Revolabs support to do so.

## Importing and Exporting Configuration Settings

Through the web interface you can import and export FLX configuration settings. These features are particularly useful if you are installing several FLX phones and want them all to use the same base set of configuration values.

A common procedure would be to configure one FLX phone as desired, ensure that it is working properly in your environment, and then export the configuration settings for that phone. Then, you would use that configuration file as a starting point for the other phones, importing that file into each of the other phones.

The export process creates a single XML file that includes all the core settings, excluding the following:

- Static IP Address
- SIP ID
- Display Name
- Username
- Password

Below is an illustration of the Import/Export page.



## Import

File to Upload:

## Export

Export configuration settings as XML file:

To export FLX configuration settings, click the Export button. A File Download window will appear prompting you to open or save the file as shown below. Click the “Save” button to save the file to the desired location.

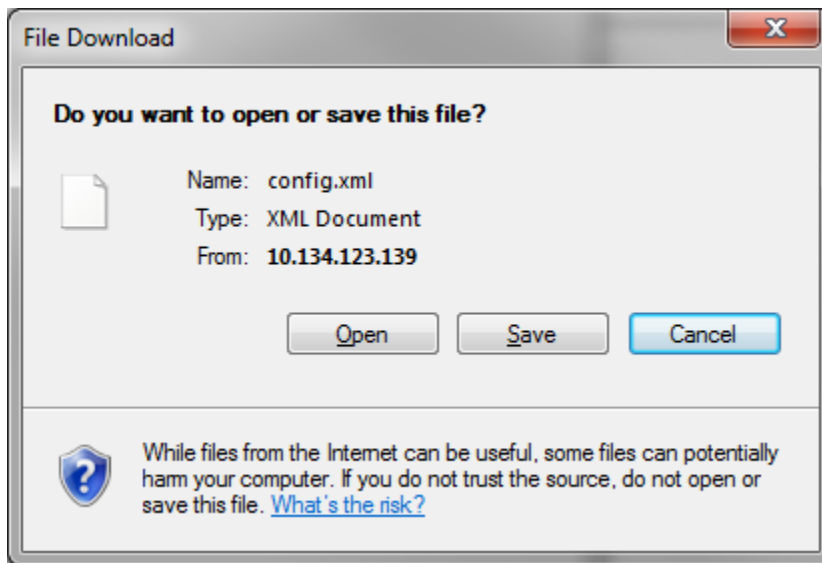

To import a configuration file, open a web session and login to the target phone to be configured, and select the Administrator > Import/Export page. Use the File to Upload field's Browse button to navigate to the previously saved configuration file, select the file in the file browser, and then click the Import button.

After importing the settings, you must minimally set the target phone-specific settings that were not uploaded with the import.

Use the web interface to browse to the Network page and specify either DHCP or the Static IP-related settings as described in this manual. Also, browse to the SIP Registration page and specify the registration settings for the phone being configured. After importing, you must restart the phone for the changes to take effect.

## Downloading the System Log Package

If you have problems with the FLX conference phone or questions about its operation, the support staff may request that you download the FLX system log package for their review.

Select the Administrator > System Log page, and click the Retrieve button to begin the download process as shown in the picture.

### System Log

Click to retrieve system log package:

### System Log Settings

Enable Verbose SIP Logging:

Your web browser should indicate the download progress. When the download is complete, you will be prompted to save the compressed configuration file. The file name will include the IP address of the FLX and a date and time stamp, for example, log-10.134.123.101-120131-210112.tar.gz.

You should be able to email the compressed file as instructed by the support staff.

The support staff may also ask you to select the option to Enable Verbose SIP Logging. Selecting this option will cause the system to log more of the internal operations and network traffic useful for isolating problems. However, the additional logging can degrade performance.

***NOTE: Use this setting only when instructed by revolabs support, and uncheck this option after you have retrieved the system log package.***

## Call Status

The Call Status page displays summary call statistics while in an active call. If there is no active call, the page will show a “No active call” message. If in a call, the page will show stats similar to those below. Click the Refresh button to manually refresh the page. The page does not update automatically. You can select, copy and paste the stats into a file or email them if desired.

## Sample Call Status

```
[CONFIRMED] To: "4002" <sip:4002@10.134.122.95>;tag=as7ba338fa
Call time: 00h:00m:25s, 1st res in 2600 ms, conn in 2670ms
SRTP status: Not active Crypto-suite:
#0 G722 @16KHz, sendrecv, peer=10.134.122.95:13400
RX pt=9, stat last update: 00h:00m:05.390s ago
  total 1.1Kpkt 179.3KB (224.2KB +IP hdr) @avg=57.1Kbps/71.4Kbps
  pkt loss=0 (0.0%), discrd=0 (0.0%), dup=0 (0.0%), reord=0 (0.0%)
      (msec)   min     avg     max     last     dev
  loss period: 0.000   0.000   0.000   0.000   0.000   0.000
  jitter      : 0.000   2.004  14.625   2.625   2.186
TX pt=9, ptime=20ms, stat last update: 00h:00m:00.110s ago
  total 1.2Kpkt 200.6KB (250.8KB +IP hdr) @avg 63.8Kbps/79.8Kbps
  pkt loss=0 (0.0%), dup=0 (0.0%), reorder=0 (0.0%)
      (msec)   min     avg     max     last     dev
  loss period: 0.000   0.000   0.000   0.000   0.000   0.000
  jitter      : 0.375   3.925  15.000  15.000   5.570
RTT msec     : 0.000   1.810   5.020   2.014   1.840
```

## Power On/Off the System Components

During normal use and operation of the FLX2 System, there is no need to turn off any part of the system. However, if the system is going to be stored without the Charger Base powered on, then each component should be powered off until further use.

### Dialer On/Off

To power off the FLX Dialer, hold down the red ‘end call’ soft key until the device asks whether you want to shut it down. Confirm this by pressing ‘Yes’.

To turn the Dialer back on, either:

1. Hold down the red ‘end call’ soft key until the Dialer powers on.

OR

2. Simply return the Dialer to an active Charger Base and it will power on automatically.

### Speaker On/Off

To power off the FLX Speaker, hold down the button located on the bottom of the Speaker until the LED indicators on the top of the Speaker turn solid red. Once the LED indicators are solid red, release the button and the Speaker will power off.

To power the Speaker back on, either:

1. Hold down the button on the bottom of the Speaker until the LED indicators on the top of the Speaker turn green. Once the LED indicators turn green, release the button and the Speaker will power on and connect to the system.

OR

2. Simply return the Speaker to an active Charger Base and it will power on automatically.

### **Microphones On/Off**

To power off a FLX Microphone, hold down the button located on the Microphone until the LED indicator turns solid red. Once the LED indicator is solid red, release the button and the Microphone will power off.

To power a Microphone back on, either:

1. Hold down the button on the Microphone until the LED indicator on the Microphone turns green. Once the LED indicator turns green, release the button and the Microphone will power on and connect to the system.

OR

2. Return the Microphone to an active Charger Base and take it out again. It will power on automatically.

## Battery Exchange

The rechargeable batteries in the different FLX components can all be exchanged. Please note that only Revolabs approved batteries should be used for the replacement. The following sections explain how to change the batteries in the different components. We recommend charging any component for 8 hours after exchanging the battery.

**Caution:** Risk of explosion if batteries are mishandled or replaced by an incorrect type. Do not disassemble batteries or attempt to charge outside the system. Do not dispose of batteries in fire. Dispose of batteries in accordance with manufacturer's instructions and local regulations.

| [Replace batteries only with Revolabs approved batteries!](#) Please contact Revolabs ([www.revolabs.com](http://www.revolabs.com)) or your AV service provider for correct manufacturer approved and recommended replacement type batteries.

## Microphones

To exchange a microphone battery push the bottom part of the back cover slightly down towards the charger port and then lift it as shown in the illustration below.

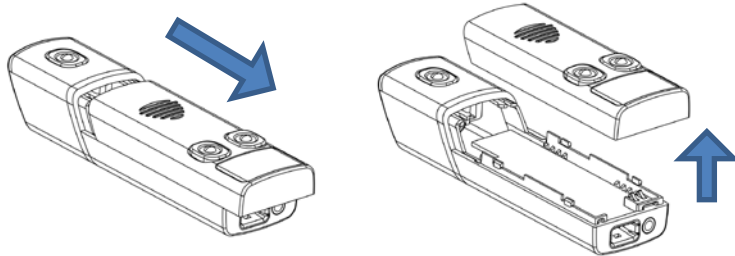

Carefully take the battery out of the plastic cover. Put the new battery into the back cover as shown in the figure below. Press on the battery until it snaps into the back of the microphone housing.

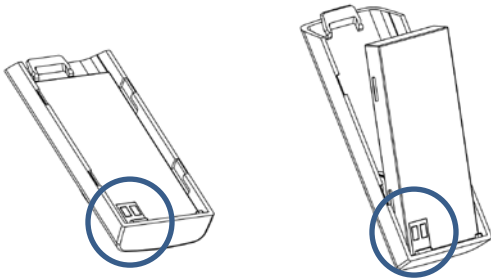

Slide the back of the microphone back in place. Place the microphone back into the charger base. The LED should go on indicating the charge status of the microphone.

## Dialer

The battery in the dialer can be exchanged after the dialer's back was opened. The back of the dialer opens if pressure is applied, pushing it back away from the charger port and lift it, as shown in the picture.

Take the current battery out of the handset as shown, and replace it with the new battery. Please ensure that the connectors on the battery are lined up with the connectors inside the dialer.

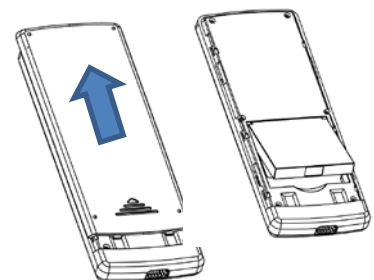

## Speaker

To change the rechargeable battery in the FLX speaker you will need to use a screwdriver to loosen the screw on the bottom of the speaker.

Once the screw is loose, the bottom door of the speaker will open, revealing the rechargeable battery pack. Carefully take this battery pack out of the speaker enclosure, unplugging the wire.

Plug the new replaceable battery into the connector, and place it into the speaker. Close the door, and re-tighten the screw.

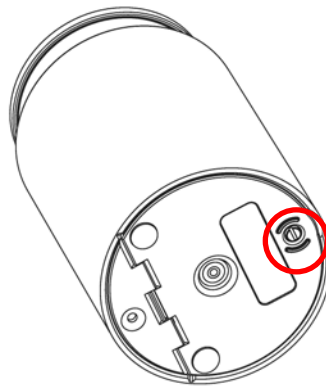

## Connecting using AUX IN / AUX OUT

The following table shows the different cables required to connect the FLX to common videoconferencing codecs in the market.

Brand	Codec	FLX OUT			FLX IN	
		Connects TO:	Level	Cable	Connects TO:	Cable
Lifesize	LG Executive	Mic Input	Mic	07-35MUTO35MU-01	Line Output	07-35MUTO35MS-01
Lifesize	Passport	Mic Input	Mic	07-35MUTO35MU-01	Line Output	07-35MUTO35MS-01
Lifesize	Passport Connect	Mic Input	Mic	07-35MUTO35MU-01	Line Output	07-35MUTO35MS-01
Lifesize	Express 200	Mic Input	Mic	07-35MUTO35MU-01	Line Output	07-35MUTO35MS-01
Lifesize	Express 220	Mic Input	Mic	07-35MUTO35MU-01	Line Output	07-35MUTO35MS-01
Lifesize	Room	Input 1	Mic	07-35MUTORCA-01	Line Output	07-35MUTODRCA-01
Lifesize	Room 200	Mic Input	Mic	07-35MUTO35MU-01	Line Output	07-35MUTODRCA-01
Lifesize	Room 220	Mic Input	Mic	07-35MUTO35MU-01	Line Output	07-35MUTO35MS-01
Lifesize	Team 200	Mic Input	Mic	07-35MUTO35MU-01	Line Output	07-35MUTO35MS-01
Lifesize	Team 220	Mic Input	Mic	07-35MUTO35MU-01	Line Output	07-35MUTO35MS-01
Polycom	HDX7000	Main Line Input 1	Line	07-35MUTODRCA-01	Line Output	07-35MUTODRCA-01
Polycom	HDX8000	Main Line Input 1	Line	07-35MUTODRCA-01	Line Output	07-35MUTODRCA-01
Polycom	HDX9000	Main Line Input L	Line	07-35MBTOMPHX-01	Line Output L	07-35MBTOMPHX-01
Polycom	QDX6000	Main Line Input 1	Line	07-35MUTODRCA-01	Line Output	07-35MUTODRCA-01
Polycom	FX	Mono Line Input	Line	07-35MUTORCA-01	Line Output	07-35MUTODRCA-01
Polycom	VSX7000e	Main Line Input 1	Line	07-35MUTODRCA-01	Line Output	07-35MUTODRCA-01
Polycom	VSX7000s	Main Line Input 1	Line	07-35MUTODRCA-01	Line Output	07-35MUTODRCA-01
Polycom	VSX8000	Main Line Input L	Line	07-35MBTOMPHX-01	Line Output L	07-35MBTOMPHX-01
Tandberg	C20	Mic Input	Mic	07-35MBTO35M4-01	Line Output	07-35MUTODRCA-01
Tandberg	C40	Mic Input	Mic	07-35MBTOXLR-01	Line Output	07-35MUTODRCA-01
Tandberg	C60	Mic Input	Mic	07-35MBTOXLR-01	Line Output	07-35MUTODRCA-01
Tandberg	C90	Mic Input	Mic	07-35MBTOXLR-01	Line Output	07-35MUTODRCA-01
Tandberg	Edge	Mic Input	Mic	07-35MBTOXLR-01	Line Output	07-35MUTODRCA-01



Tandberg	3000 MXP	Mic Input	Mic	07-35MBTOXLR-01	Line Output	07-35MUTODRCA-01
Tandberg	6000 MXP	Mic Input	Mic	07-35MBTOXLR-01	Line Output	07-35MUTODRCA-01
PC Audio	USB Audio Adapter	Mic Input	Line	07-35MUTO35MU-01	Line Output	07-35MUTO35MS-01
Sony	XG-80	Mic Input	Mic	07-35MUTO35MU-01	Line Output	07-35MUTODRCA-01
Sony	PCS-G70	Mic Input	Mic	07-35MUTO35MU-01	Line Output	07-35MUTODRCA-01
Sony	PCS-HG90	Mic Input	Mic	07-35MBTOXLR-01	Line Output	07-35MUTODRCA-01
Sony	PCS-G50	Mic Input	Mic	07-35MUTO35MU-01	Line Output	07-35MUTODRCA-01
Sony	PCS-1	Mic Input	Mic	07-35MUTO35MU-01	Line Output	07-35MUTORCA-01
Panasonic	KX-VC600	Audio In L/R	Line	07-35MUTODRCA-01	Line Output	07-35MUTODRCA-01
Panasonic	KX-VC500	Audio In L/R	Line	07-35MUTODRCA-01	Line Output	07-35MUTODRCA-01
Panasonic	KX-VC300	Audio In L/R	Line	07-35MUTODRCA-01	Line Output	07-35MUTODRCA-01

To connect a FLX to a computer we recommend using Revolabs' USB connector kit, 01-USBAUD35-KIT. This kit includes a USB audio dongle and two cables to connect to the FLX.

## Troubleshooting

### Warning Messages

#### Speaker / Microphone Link Lost

If a FLX Microphone or FLX Speaker loses connection to the FLX2 Base Station, the LED indicator will begin flashing a sequence of red – yellow - green - yellow and start emitting a beeping notification. To reconnect the Microphone or Speaker move it back into range of the Base Station.

#### Speaker/Microphone Low Battery

If a FLX Microphone or FLX Speaker begins to experience a low battery, the LED indicator will begin to flash a green - yellow (unmuted) or red - yellow (muted) sequence. It will also start to emit an audio signal. When this LED and sound sequence begins, the battery has roughly 5% battery power remaining and should be returned to the Charger Base.

#### Speaker/Microphone Off

If the FLX Microphone or FLX Speaker suddenly turns off, it is the result of two possible causes.

1. The battery has completely depleted and should be returned to the charger until it is fully charged again.
2. The Microphone or Speaker lost connection with the Base Station for more than 10 minutes and therefore shut down. It should be returned into reach of the Base

Station and switched on again to be reactivated.

### **Dialer Low Battery**

When the Dialer experiences a low battery it will display a 'low battery' notification on the screen. The Dialer should be returned to the charger until the battery status on the home screen shows a full charge.

### **Dialer Link Lost**

If the FLX Dialer loses connection to the FLX2 Base Station it will display a 'connection lost' notification on the screen and starts emitting a warning sound. The Dialer should be moved back into range of the Base Station at which point it will reconnect automatically.

### **Base Power Lost**

If the FLX2 Base Station loses power, it will disconnect all telephone calls, analog audio inputs/outputs and will disconnect from the FLX Dialer, Speaker, and Microphones. Check to make sure that the network connector is still connected to the FLX2 Base Station. Once the FLX2 Base Station is powered back on, the Dialer, Speaker and Microphones will reconnect automatically.

## **Microphone, Speaker, or Dialer not connecting to Base Station**

If any of the components of the FLX2 Conference Phone indicate that they are searching for the Base Station, or lost the connection to the Base Station, please follow these steps:

1. Is the Base Station powered up – the Status LED on the back of the Base Station should have green double flashes about every second. If not, please power up the Base Station. All components should automatically connect to the Base Station after a few seconds.
2. The Base Station is powered up, but the Status LED indicates a fault has happened by missing every fifth green double flash. Power down and power up the Base Station. All components should reconnect to the Base Station after a few seconds. The fault message in the Base Station will continue (every fifth double flash is skipped) – this just shows that a fault has happened in the past and can be ignored. If the components still do not connect to the base please contact Revolabs Support.
3. Are the Dialer, Microphone, and Speaker out of reach of the Base Station? Please bring the components closer to the Base Station to see whether this resolves the issue.
4. Power down the Base Station, the Microphones, the Dialer, and the Speaker. Now power up the Base Station. Once the Base Station is powered up (double green flashes of the Status LED), power up the Dialer, and then the Microphones and the Speaker. The components should now connect to the Base Station.
5. If the components still do not connect to the Base Station, please re-pair the components that have not connected to the Base Station, beginning with the Dialer. Pair of components to the Base Station is explained on page 42.
6. If the components still do not connect to the Base Station, please contact Revolabs support.

## Microphone, Speaker, or Dialer not paired with Base Station

Please follow the descriptions on page 42 on how to pair the different components with the Base Station.

### LED Indicators

Device LED Indicator	Status
<b>Microphone in Charger Base</b>	
Steady Red	Charging
Steady Green	Fully charged
Single red flash	Active phone call, both microphones in Charger Base, microphones muted via Master Mute or All Mic Mute is ON
Double red flash	Active phone call, microphone(s) in Charger Base, microphone is muted
Green flash	Active phone call, microphone in Charger Base is unmuted
Off	Microphone is powered off: <ul style="list-style-type: none"> <li>o Microphone is not seated properly</li> <li>o Charger Base is powered off</li> </ul>
<b>Microphone not in Charger Base</b>	
Off	Microphone is powered off
Single green flash every second	On, connected, battery charged, un-muted
Two Red flashes every second	On, connected, battery charged, individually muted
Red flash every second	On, connected, battery charged, Master Mute or "All Mic Mute" is ON, microphones muted
Alternating Yellow - Green flash	On, connected, battery low, un-muted
Alternating Yellow - Double-Red flash	On, connected, battery low, individually muted
Alternating long Red - Yellow flash	On, connected, battery low, Master Mute or "All Mic Mute" is ON, microphones muted
Flashing Yellow – Red – Yellow – Green	Searching for a connection to the base. <i>The microphone will try to re-establish the link for 10 minutes, then power off</i>
Alternating slow Red - Green flash	Microphone is not paired to a Base Station <i>The microphone will power off after two minutes</i>
Steady Red	<ul style="list-style-type: none"> <li>o Microphone is being powered down</li> <li>o Microphone is in pairing mode</li> </ul>
Groups of five rapid Red flashes	Microphone is in a fault condition
Device LED Indicator	Status
<b>Speaker in Charger Base</b>	
Steady Green	<ul style="list-style-type: none"> <li>o Connected, battery charging, no phone call in progress, Microphones in Charger Base</li> <li>o Connected, battery charging, phone call in progress, Microphones are not muted using All Mic Mute or Master Mute. Microphone(s) might</li> </ul>

Device LED Indicator	Status
	<ul style="list-style-type: none"> <li>still be individually muted</li> <li>Connected, battery charging, no phone call in progress, Microphone(s) outside of the Charger Base unmuted</li> </ul>
Steady Red	<ul style="list-style-type: none"> <li>Connected, battery charging, phone call in progress, Master Mute or "All Mic Mute" is ON, all Microphones are muted</li> <li>Connected, battery charging, no phone call in progress, Microphone(s) outside of Charger Base, "All Mic Mute" is ON, all Microphones are muted</li> </ul>
Green flash every second	<ul style="list-style-type: none"> <li>Connected, battery fully charged, no phone call in progress, Microphones in Charger Base</li> <li>Connected, battery fully charged, phone call in progress, Microphones are not muted using All Mic Mute or Master Mute. Microphones might still be individually muted</li> <li>Connected, battery fully charged, no phone call in progress, Microphone(s) outside of the Charger Base unmuted</li> </ul>
Red flash every second	<ul style="list-style-type: none"> <li>Connected, battery fully charged, phone call in progress, Master Mute or "All Mic Mute" is ON, all Microphones are muted</li> <li>Connected, battery fully charged, no phone call in progress, microphones outside of Charger Base, "All Mic Mute" is ON, all Microphones are muted</li> </ul>
Flashing Yellow* – Red – Yellow* – Green	Searching for a connection to the Base Station
Alternating slow Red - Green flash	Speaker is not paired to a Base Station
Off	Speaker is powered off: <ul style="list-style-type: none"> <li>Speaker is not seated properly</li> <li>Charger tray is powered off</li> </ul>
Speaker not in Charger Base	
Off	Speaker is powered off
Green flash every second	<ul style="list-style-type: none"> <li>Connected, no call in progress, Microphones in Charger Base</li> <li>Connected, no phone call in progress, Microphone(s) outside of the Charger Base unmuted</li> <li>Connected, call in progress, Microphones are not muted using All Mic Mute or Master Mute</li> <li>Microphone(s) might still be individually muted</li> </ul>
Red flash every second	<ul style="list-style-type: none"> <li>Connected, phone call in progress, Master Mute or "All Mic Mute" is ON, all microphones are muted</li> <li>Connected, no phone call in progress, Microphone(s) outside of Charger Base, "All Mic Mute" is ON, all Microphones are muted</li> </ul>
Alternating Green – Yellow* flash	<ul style="list-style-type: none"> <li>Connected, battery low, no call in progress</li> <li>Connected, battery low, call in progress, Microphones are not muted using All Mic Mute or Master Mute. Microphone(s) might still be individually muted</li> </ul>

Device LED Indicator	Status
Alternating long Red – Yellow* flash	<ul style="list-style-type: none"> <li>○ Connected, battery low, no call in progress, “All Mic Mute” is ON, all Microphones are muted</li> <li>○ Connected, battery low, call in progress, Master Mute or “All Mic Mute” is ON, all Microphones muted</li> </ul>
Flashing Yellow* – Red – Yellow* – Green	Searching for a connection to the base <i>The speaker will try to re-establish the link for about 10 minutes, then power off.</i>
Alternating slow Red - Green flash	Speaker is not paired to a Base Station <i>The speaker will power down after two minutes.</i>
Steady Red	<ul style="list-style-type: none"> <li>○ Speaker is being powered down</li> <li>○ Speaker is in pairing mode.</li> </ul>
Groups of five rapid Red flashes	Speaker is in a fault condition.
Device LED Indicator	Status
Base Station	
Long solid on, then a long solid off	Power On Boot Process
Double flashes every second	Operating Mode indicating that Base Station is functional.
Skip every fifth double flash	Fault indication. This also indicates past faults that have no bearings on current operation
Continuous Fast Flashing	Updating non-volatile memory as part of software update
Off	No Power

\* In some Speakers the LED Indicator color Yellow might look like Red.

## Reset to Factory Defaults

See page 41 for a description on how to reset the FLX2 Conference Phone back to its factory defaults.

## Technical Specifications

### Models

The Revolabs FLX2 VoIP System is available with a variety of configurations to provide the best audio capture in the industry. The following is a list of the available models. All of these models are SIP enabled and require an IP connection.

10-FLX2-200-VOIP	FLX2 System w/ 2 Omni Microphones
10-FLX2-101-VOIP	FLX2 System w/ 1 Omni & 1 Wearable Microphone
10-FLX2-002-VOIP	FLX2 System w/ 2 Wearable Microphones
10-FLX2-020-VOIP	FLX2 System w/ 2 Directional Microphones
10-FLX2-200-DUAL-VOIP	FLX2 System w/ 2 Omni Microphones and 2 Speakers

<b>FLX</b>	
Wireless Technology	
DECT	DECT 6.0 for US, ETSI ETS 300 175 for other countries
Bluetooth	BT 2.1 + EDR
Wireless Range	
DECT	65 feet, 20 meters
Bluetooth	Class II, 33 feet, 10 meters
Security (DECT / Bluetooth)	DECT: 128 bit encryption
Noise Cancelation	Noise cancellation on the Microphone
Echo Cancelation	Acoustic echo canceller for Speaker/Microphone.
RF Shield	No cell phone interference due to RF Armor™ technology
Language versions	System messages and menus in English; Documentation in English
Certifications / Regulatory Compliance	
Electrical Safety	UL/CSA, EN 60950
Radio / Telephone	Part 68, IC-CS03, TBR 21, A-Tick
Environmental Requirements	0°C - 40°C; 20% - 80% non-condensing humidity
Warranty	1 year
<b>Speaker</b>	
Dimensions Speaker	157mm x 93mm diameter
Weight	600.3g
Bandwidth	120-11,000 Hz from Analog IN. This is reduced for VoIP calls based on the bandwidth supported by the selected transport codec.
Battery life (talk time)	8 hours.
Charge time	3 hours
<b>Microphones</b>	
Dimensions Microphones	94.2 x 24.6mm x 18.5 mm (omnidirectional Microphone)
Weight	28.6g (omnidirectional Microphone)
Bandwidth	80-11,000 Hz from Microphone to Analog OUT. This is reduced for VoIP calls based on the bandwidth supported by the selected transport codec.
Battery life (talk time)	8 hours
Charge time	2 hours
<b>Base Station</b>	
Power	5V 1A
Dimensions Base Station	180 x 153 x 32mm
Weight	302g
Connections	
Ethernet	RJ45
USB	2 Mini-USB connectors for firmware upgrades
AUX IN / AUX OUT	Line level input, 2 outputs, line level or mic level
Indicators (LED)	1 indicating system status
<b>Charger Base</b>	
Power	15V 1A
Dimensions Charger Base	170 diameter x 22mm
Weight	252g

<b>Dialer</b>	
Dimensions Dialer	125 x 48 x 11mm
Weight	67.5g
Microphone and Speaker bandwidth	300 – 3300Hz
Battery life	8 hours
Charge time	3 hours
Display	High resolution color LCD display
Caller ID	Support for multiple Caller ID standards
Phonebook	Up to 100 entries
Keypad	12 key telephone keypad 2 context sensitive soft keys answer / hang-up keys, 5 key cursor and control panel

# Regulatory Information

## FCC Notice to Users

This device complies with Part 15 of the FCC Rules. Operation is subject to the following two conditions: (1) this device may not cause harmful interference, and (2) this device must accept any interference received, including interference that may cause undesired operation.

Users are not permitted to make changes or modify the equipment in any way. Changes or modifications not expressly approved by Revolabs, Inc. could void your authority to operate this equipment under Federal Communications Commission's rules.

### RADIO AND TELEVISION INTERFERENCE

This equipment has been tested and found to comply with the limits for a Class B digital device, pursuant to Part 15 of the FCC rules. These limits are designed to provide reasonable protection against harmful interference in a residential installation. This equipment generates, uses and can radiate radio frequency energy and, if not installed and used in accordance with the instructions, may cause harmful interference to radio communications. However, there is no guarantee that interference will not occur in a particular installation. If this equipment does cause harmful interference to radio or television reception, which can be determined by turning the equipment off and on, the user is encouraged to try to correct the interference by one or more of the following measures:

- Reorient or relocate the receiving antenna.
- Increase the separation between the equipment and the receiver.
- Connect the equipment into an outlet on a circuit different from that to which the receiver is connected.
- Consult the dealer or an experienced radio/TV technician for help.

You may also find helpful the following booklet, prepared by the FCC: "How to Identify and Resolve Radio-TV Interference Problems." This booklet is available from the U.S. Government Printing Office, Washington D.C. 20402.

Model Number	FCC Identification
10-FLX2BASE-VOIP	T5V10FLX
10-FLXSPEAKER-01	T5V10FLXSPKRNM
10-FLXHDDIALER-01	T5V10FLXHNDNM
10-FLXHDDIALER	T5V10FLXHNDVE
01-HDTBLMIC-OM	T5V0HDEXEMIC
01-HDTBLMIC-DR	T5V0HDEXEMIC
01-HDEXEMIC	T5V0HDEXEMIC



## Industry Canada Notice to Users

This Class B digital apparatus complies with Canadian ICES-003.

Operation is subject to the following two conditions:

- (1) This device may not cause interference and
- (2) This device must accept any interference, including interference that may cause undesired operation of the device

Model Number	Industry Canada Identification
10-FLX2BASE-VOIP	6455A-10FLX
10-FLXSPEAKER-01	6455A-10FLXSPKRNM
10-FLXHDDIALER-01	6455A-10FLXHNDNM
10-FLXHDDIALER	6455A-10FLXHNDVE
01-HDTBLMIC-OM	6455A-0HDEXEMIC
01-HDTBLMIC-DR	6455A-0HDEXEMIC
01-HDEXEMIC	6455A-0HDEXEMIC

### RF Exposure:

This equipment complies with FCC radiation exposure limits set forth for an uncontrolled environment. The antenna(s) used for this equipment must be installed to provide a separation distance of at least eight inches (20 cm) from all persons. This equipment must not be operated in conjunction with any other antenna.

This device complies with RF exposure requirements in Industry Canada RSS-102 Issue 4.

#### For Body Worn Operation:

SAR data information for residents in countries that have adopted the SAR limit recommended by the International Commission of Non-Ionizing Radiation Protection (ICNIRP), which is 0.08 W/kg averaged over the whole body or 2.00 W/kg averaged over ten (10) gram of tissue (for example European Union, Japan, Brazil and New Zealand): The highest SAR value for this product when tested for use on the body is 0.35 W/kg (averaged over 10g).

### Professional Installation Recommended

This product should be professionally installed.

### Notice to Customers in Australia

- Do not use the areas where there are explosive hazards
- Do not use in environments where there is a danger of ignition of flammable gasses.

## **Restricted use with certain medical devices**

### **Hearing Aids**

Some devices may interfere with some hearing aids. In the event of such interference, you may want to consult with your hearing aid manufacturer to discuss alternatives.

### **Other Medical Devices**

If you use any other personal medical device, consult the manufacturer of your device to determine if it is adequately shielded from RF energy. Your physician may be able to assist you in obtaining this information.

## **Export Law Assurance**

This product is controlled under the export regulations of the United States of America and Canada. The Governments of the United States of America and Canada may restrict the exportation or re-exportation of this product to certain destinations. For further information contact the U.S. Department of Commerce or the Canadian Department of Foreign Affairs and International Trade. The use of wireless devices and their accessories may be prohibited or restricted in certain areas. Always obey the laws and regulations on the use of these products.

## **10-FLX2BASE-VOIP North America UPCS Usage Restriction**

Due to the UPCS frequencies used, this product is licensed for operation only in the United States of America and Canada.

## **30-FLX2BASE-VOIP-EU European Union Usage Restriction**

Due to the DECT frequencies used, this product is licensed for operation only in the European Union countries and Australia.

## Notice to European Customers



190, High Street,  
Tonbridge, Kent,  
TN9 1BE,  
UK.

Declare that for the hereinafter mentioned product model numbers, the presumption of conformity with the applicable essential requirements has been approved in accordance with Council Directive 1999/5/EC “Radio and Telecommunications Terminal Equipment” and RoHS II Directive 2011/65/EU.

10-FLX2BASE-VOIP-EU	Base
10-FLX2CHGEU-01	Charger Base
30-FLXSPEAKER-EU	Speaker
10-FLXHDDIALER-01	Remote Dialer
10-FLXHDDIALER	Remote Dialer
03-HDEXEMICEU-11	HD Microphone, Wearable
03-HDTBLMICEU-OM-11	HD Microphone, Tabletop, Omnidirectional
03-HDTBLMICEU-DR-11	HD Microphone, Tabletop, Directional

Any unauthorized modification of the products voids this Declaration.

For a copy of the original signed declaration of conformity, please contact Revolabs at the above address.

### WEEE Notification:

The Waste Electrical and Electronic Equipment (WEEE) directive (2012/19/EU) is intended to promote recycling of electrical and electronic equipment and their components at end of life.

According to the requirement of the WEEE legislation the following user information is provided to customers for all branded Revolabs products subject to the WEEE directive.



“The symbol on the product or its packaging indicates that this product must not be disposed of with your other household waste. Instead, it is your responsibility to dispose of your waste equipment by handing it over to a designated collection point for the recycling of waste electrical and electronic equipment. The separate collection and recycling of your waste equipment at the time of disposal will help conserve natural resources and ensure that it is recycled in a manner that protects human health and the environment. For more information about where you can drop off your waste for recycling, please contact your local authority, or where you purchased your product.”

# Limited Warranty and Limitation of Liability

## Limited Warranty

Revolabs warrants to the end user ("Customer") that this product will be free from significant defects in workmanship and materials, under normal use and service, for one year from the date of purchase from Revolabs or its authorized reseller provided the customer provides proof of purchase that demonstrates that the product is still within the warranty period and contacts Revolabs customer service, regarding warranty claims, within the warranty period. Revolabs's sole obligation under this express warranty shall be, at Revolabs's option and expense, to repair the defective product or part, deliver to Customer an equivalent product or part to replace the defective item, or if neither of the two foregoing options is reasonably available, Revolabs may, in its sole discretion, refund to Customer the purchase price paid for the defective product upon Customer's return of the defective product. All products that are replaced will become the property of Revolabs. Replacement products or parts may be new or reconditioned. Revolabs warrants any replaced or repaired product or part for ninety (90) days from shipment, or the remainder of the initial warranty period, whichever is longer. Products returned to Revolabs must be issued a valid Return Material Authorization ("RMA") number. To request an RMA, contact Revolabs Customer Service. Prior to receiving an RMA, the product must be first troubleshot and determined to be defective by a Revolabs Technical Support Technician.

Product returned to Revolabs must have a valid RMA # clearly marked on the outside of the shipping container and the serial number and model of the returned product must match the RMA. Products returned without a RMA number will be returned to the customer. The product must contain all of the original accessories and be properly packaged. Products returned to Revolabs must be sent prepaid, and it is recommended that they be insured or sent by a method that provides for tracking of the package. Responsibility for loss or damage does not transfer to Revolabs until the returned item is received by Revolabs. The repaired or replaced item will be shipped to Customer, via standard economy shipping methods and at Revolabs's expense, not later than thirty (30) days after Revolabs receives the defective product, and Revolabs will retain risk of loss or damage until the item is delivered to Customer. Any customer request for expedited shipping will be considered on a case-by-case basis and will be at the sole expense of the customer. Any product found to be not covered under the terms of this warranty, per the exclusions listed below, will be treated as an out-of-warranty service and will be billed to the customer according to the Revolabs Product Repair Policy. The sole exceptions to the terms of this warranty are those listed as part of the Revolabs DOA Replacement Policy.

## Exclusions and Remedies

Revolabs will not be liable under this limited warranty if its testing and examination disclose that the alleged defect or malfunction in the product does not exist or results from:

- ▶ Failure to follow Revolabs's installation, operation, or maintenance instructions;
- ▶ Product modification or alteration, including but not limited to modification or removal of the serial number.
- ▶ Use of common carrier communication services accessed through the product;
- ▶ Failure of Consumable Components and Accessories including but not limited to batteries and cables.
- ▶ Abuse, misuse, negligent acts or omissions of Customer and persons under Customer's control; or
- ▶ Acts of third parties or products, acts of God, accident, fire, lightning, power surges, outages, or other hazards, or any other cause outside of Revolabs's reasonable control.

WARRANTY EXCLUSION. IF A REVOLABS PRODUCT DOES NOT OPERATE AS

WARRANTED ABOVE, CUSTOMER'S SOLE REMEDY FOR BREACH OF THAT WARRANTY SHALL BE REPAIR, REPLACEMENT, OR REFUND OF THE PURCHASE PRICES PAID, AT REVOLABS'S OPTION. TO THE FULL EXTENT ALLOWED BY LAW, THE FOREGOING WARRANTIES AND REMEDIES ARE EXCLUSIVE AND ARE IN LIEU OF ALL OTHER WARRANTIES, TERMS OR CONDITIONS, EXPRESS OR IMPLIED, EITHER IN FACT OR BY OPERATION OF LAW, STATUTORY OR OTHERWISE, INCLUDING WARRANTIES, TERMS OR CONDITIONS OF MERCHANTABILITY, FITNESS FOR A PARTICULAR PURPOSE, SATISFACTORY QUALITY, CORRESPONDENCE WITH DESCRIPTION, AND NON-INFRINGEMENT, ALL OF WHICH ARE EXPRESSLY DISCLAIMED. REVOLABS NEITHER ASSUMES NOR AUTHORIZES ANY OTHER PERSON TO ASSUME FOR IT ANY OTHER LIABILITY IN CONNECTION WITH THE SALE, INSTALLATION, MAINTENANCE OR USE OF ITS PRODUCTS.

#### **Limitation of Liability**

TO THE FULL EXTENT ALLOWED BY LAW, REVOLABS EXCLUDES FOR ITSELF AND ITS SUPPLIERS ANY LIABILITY, WHETHER BASED IN CONTRACT OR TORT (INCLUDING NEGLIGENCE), FOR INCIDENTAL, CONSEQUENTIAL, INDIRECT, SPECIAL, OR PUNITIVE DAMAGES OF ANY KIND, OR FOR LOSS OF REVENUE OR PROFITS, LOSS OF BUSINESS, LOSS OF INFORMATION OR DATA, OR OTHER FINANCIAL LOSS ARISING OUT OF OR IN CONNECTION WITH THE SALE, INSTALLATION, MAINTENANCE, USE, PERFORMANCE, FAILURE, OR INTERRUPTION OF ITS PRODUCTS, EVEN IF REVOLABS OR ITS AUTHORIZED RESELLER HAS BEEN ADVISED OF THE POSSIBILITY OF SUCH DAMAGES, AND LIMITS ITS LIABILITY TO REPAIR, REPLACEMENT, OR REFUND OF THE PURCHASE PRICE PAID, AT REVOLABS'S OPTION. THIS DISCLAIMER OF LIABILITY FOR DAMAGES WILL NOT BE AFFECTED IF ANY REMEDY PROVIDED HEREIN SHALL FAIL OF ITS ESSENTIAL PURPOSE.

#### **Disclaimer**

Some countries, states, or provinces do not allow the exclusion or limitation of implied warranties or the limitation of incidental or consequential damages for certain products supplied to consumers, or the limitation of liability for personal injury, so the above limitations and exclusions may

be limited in their application to you. When the implied warranties are not allowed to be excluded in their entirety, they will be limited to the duration of the applicable written warranty. This warranty gives you specific legal rights which may vary depending on local law.

#### **Governing Laws**

This Limited Warranty and Limitation of Liability shall be governed by the laws of the Commonwealth of Massachusetts, USA, and by the laws of the United States, excluding their conflicts of laws principles.

The United Nations Convention on Contracts for the International Sale of Goods is hereby excluded in its entirety from application to this Limited Warranty and Limitation of Liability.

## GPL LICENSED SOFTWARE

The following GPL licensed software is used in this product and is subject to the GNU General Public License version 2 (GPLv2) License Agreements included as part of this documentation:

uClinux 2.6.26

BusyBox 1.2.2

Source code for this software can be obtained by contacting Revolabs at support@revolabs.com.

## GNU GENERAL PUBLIC LICENSE

Version 2, June 1991

Copyright (C) 1989, 1991 Free Software Foundation, Inc.

51 Franklin Street, Fifth Floor, Boston, MA 02110-1301, USA

Everyone is permitted to copy and distribute verbatim copies of this license document, but changing it is not allowed.

### Preamble

The licenses for most software are designed to take away your freedom to share and change it. By contrast, the GNU General Public License is intended to guarantee your freedom to share and change free software--to make sure the software is free for all its users. This General Public License applies to most of the Free Software Foundation's software and to any other program whose authors commit to using it. (Some other Free Software Foundation software is covered by the GNU Lesser General Public License instead.) You can apply it to your programs, too.

When we speak of free software, we are referring to freedom, not price. Our General Public Licenses are designed to make sure that you have the freedom to distribute copies of free software (and charge for this service if you wish), that you receive source code or can get it if you want it, that you can change the software or use pieces of it in new free programs; and that you know you can do these things.

To protect your rights, we need to make restrictions that forbid anyone to deny you these rights or to ask you to surrender the rights. These restrictions translate to certain responsibilities for you if you distribute copies of the software, or if you modify it.

For example, if you distribute copies of such a program, whether gratis or for a fee, you must give the recipients all the rights that you have. You must make sure that they, too, receive or can get the source code. And you must show them these terms so they know their rights.

We protect your rights with two steps: (1) copyright the software, and (2) offer you this license which gives you legal permission to copy, distribute and/or modify the software. Also, for each author's protection and ours, we want to make certain that everyone understands that there is no warranty for this free software. If the software is modified by someone else and passed on, we want its recipients to know that what they have is not the original, so that any problems introduced by others will not reflect on the original authors' reputations.

Finally, any free program is threatened constantly by software patents. We wish to avoid the danger that redistributors of a free program will individually obtain patent licenses, in effect making the program proprietary. To prevent this, we have made it clear that any patent must be licensed for everyone's free use or not licensed at all.

The precise terms and conditions for copying, distribution and modification follow.

## **TERMS AND CONDITIONS FOR COPYING, DISTRIBUTION AND MODIFICATION**

**0.** This License applies to any program or other work which contains a notice placed by the copyright holder saying it may be distributed under the terms of this General Public License. The "Program", below, refers to any such program or work, and a "work based on the Program" means either the Program or any derivative work under copyright law: that is to say, a work containing the Program or a portion of it, either verbatim or with modifications and/or translated into another language. (Hereinafter, translation is included without limitation in the term "modification".) Each licensee is addressed as "you".

Activities other than copying, distribution and modification are not covered by this License; they are outside its scope. The act of running the Program is not restricted, and the output from the Program is covered only if its contents constitute a work based on the Program (independent of having been made by running the Program). Whether that is true depends on what the Program does.

**1.** You may copy and distribute verbatim copies of the Program's source code as you receive it, in any medium, provided that you conspicuously and appropriately publish on each copy an appropriate copyright notice and disclaimer of warranty; keep intact all the notices that refer to this License and to the absence of any warranty; and give any other recipients of the Program a copy of this License along with the Program.

You may charge a fee for the physical act of transferring a copy, and you may at your option offer warranty protection in exchange for a fee.

**2.** You may modify your copy or copies of the Program or any portion of it, thus forming a work based on the Program, and copy and distribute such modifications or work under the terms of Section 1 above, provided that you also meet all of these conditions:

**a)** You must cause the modified files to carry prominent notices stating that you changed the files and the date of any change.

**b)** You must cause any work that you distribute or publish, that in whole or in part contains or is derived from the Program or any part thereof, to be licensed as a whole at no charge to all third parties under the terms of this License.

**c)** If the modified program normally reads commands interactively when run, you must cause it, when started running for such interactive use in the most ordinary way, to print or display an announcement including an appropriate copyright notice and a notice that there is no warranty (or else, saying that you provide a warranty) and that users may redistribute the program under these conditions, and telling the user how to view a copy of this License. (Exception: if the Program itself is interactive but does not normally print such an announcement, your work

based on the Program is not required to print an announcement.)

These requirements apply to the modified work as a whole. If identifiable sections of that work are not derived from the Program, and can be reasonably considered independent and separate works in themselves, then this License, and its terms, do not apply to those sections when you distribute them as separate works. But when you distribute the same sections as part of a whole which is a work based on the Program, the distribution of the whole must be on the terms of this License, whose permissions for other licensees extend to the entire whole, and thus to each and every part regardless of who wrote it.

Thus, it is not the intent of this section to claim rights or contest your rights to work written entirely by you; rather, the intent is to exercise the right to control the distribution of derivative or collective works based on the Program.

In addition, mere aggregation of another work not based on the Program with the Program (or with a work based on the Program) on a volume of a storage or distribution medium does not bring the other work under the scope of this License.

**3.** You may copy and distribute the Program (or a work based on it, under Section 2) in object code or executable form under the terms of Sections 1 and 2 above provided that you also do one of the following:

- a)** Accompany it with the complete corresponding machine-readable source code, which must be distributed under the terms of Sections 1 and 2 above on a medium customarily used for software interchange; or,
- b)** Accompany it with a written offer, valid for at least three years, to give any third party, for a charge no more than your cost of physically performing source distribution, a complete machine-readable copy of the corresponding source code, to be distributed under the terms of Sections 1 and 2 above on a medium customarily used for software interchange; or,
- c)** Accompany it with the information you received as to the offer to distribute corresponding source code. (This alternative is allowed only for noncommercial distribution and only if you received the program in object code or executable form with such an offer, in accord with Subsection b above.)

The source code for a work means the preferred form of the work for making modifications to it.

For an executable work, complete source code means all the source code for all modules it contains, plus any associated interface definition files, plus the scripts used to control compilation and installation of the executable. However, as a special exception, the source code distributed need not include anything that is normally distributed (in either source or binary form) with the major components (compiler, kernel, and so on) of the operating system on which the executable runs, unless that component itself accompanies the executable.



If distribution of executable or object code is made by offering access to copy from a designated place, then offering equivalent access to copy the source code from the same place counts as distribution of the source code, even though third parties are not compelled to copy the source along with the object code.

**4.** You may not copy, modify, sublicense, or distribute the Program except as expressly provided under this License. Any attempt otherwise to copy, modify, sublicense or distribute the Program is void, and will automatically terminate your rights under this License. However, parties who have received copies, or rights, from you under this License will not have their licenses terminated so long as such parties remain in full compliance.

**5.** You are not required to accept this License, since you have not signed it. However, nothing else grants you permission to modify or distribute the Program or its derivative works. These actions are prohibited by law if you do not accept this License. Therefore, by modifying or distributing the Program (or any work based on the Program), you indicate your acceptance of this License to do so, and all its terms and conditions for copying, distributing or modifying the Program or works based on it.

**6.** Each time you redistribute the Program (or any work based on the Program), the recipient automatically receives a license from the original licensor to copy, distribute or modify the Program subject to these terms and conditions. You may not impose any further restrictions on the recipients' exercise of the rights granted herein. You are not responsible for enforcing compliance by third parties to this License.

**7.** If, as a consequence of a court judgment or allegation of patent infringement or for any other reason (not limited to patent issues), conditions are imposed on you (whether by court order, agreement or otherwise) that contradict the conditions of this License, they do not excuse you from the conditions of this License. If you cannot distribute so as to satisfy simultaneously your obligations under this License and any other pertinent obligations, then as a consequence you may not distribute the Program at all. For example, if a patent license would not permit royalty-free redistribution of the Program by all those who receive copies directly or indirectly through you, then the only way you could satisfy both it and this License would be to refrain entirely from distribution of the Program.

If any portion of this section is held invalid or unenforceable under any particular circumstance, the balance of the section is intended to apply and the section as a whole is intended to apply in other circumstances.

It is not the purpose of this section to induce you to infringe any patents or other property right claims or to contest validity of any such claims; this section has the sole purpose of protecting the integrity of the free software distribution system, which is implemented by public license practices. Many people have made generous contributions to the wide range of software distributed through that system in reliance on consistent application of that system; it is up to the author/donor to decide if he or she is

willing to distribute software through any other system and a licensee cannot impose that choice.

This section is intended to make thoroughly clear what is believed to be a consequence of the rest of this License.

**8.** If the distribution and/or use of the Program is restricted in certain countries either by patents or by copyrighted interfaces, the original copyright holder who places the Program under this License may add an explicit geographical distribution limitation excluding those countries, so that distribution is permitted only in or among countries not thus excluded. In such case, this License incorporates the limitation as if written in the body of this License.

**9.** The Free Software Foundation may publish revised and/or new versions of the General Public License from time to time. Such new versions will be similar in spirit to the present version, but may differ in detail to address new problems or concerns. Each version is given a distinguishing version number. If the Program specifies a version number of this License which applies to it and "any later version", you have the option of following the terms and conditions either of that version or of any later version published by the Free Software Foundation. If the Program does not specify a version number of this License, you may choose any version ever published by the Free Software Foundation.

**10.** If you wish to incorporate parts of the Program into other free programs whose distribution conditions are different, write to the author to ask for permission. For software which is copyrighted by the Free Software Foundation, write to the Free Software Foundation; we sometimes make exceptions for this. Our decision will be guided by the two goals of preserving the free status of all derivatives of our free software and of promoting the sharing and reuse of software generally.

## **NO WARRANTY**

**11.** BECAUSE THE PROGRAM IS LICENSED FREE OF CHARGE, THERE IS NO WARRANTY FOR THE PROGRAM, TO THE EXTENT PERMITTED BY APPLICABLE LAW. EXCEPT WHEN OTHERWISE STATED IN WRITING THE COPYRIGHT HOLDERS AND/OR OTHER PARTIES PROVIDE THE PROGRAM "AS IS" WITHOUT WARRANTY OF ANY KIND, EITHER EXPRESSED OR IMPLIED, INCLUDING, BUT NOT LIMITED TO, THE IMPLIED WARRANTIES OF MERCHANTABILITY AND FITNESS FOR A PARTICULAR PURPOSE. THE ENTIRE RISK AS TO THE QUALITY AND PERFORMANCE OF THE PROGRAM IS WITH YOU. SHOULD THE PROGRAM PROVE DEFECTIVE, YOU ASSUME THE COST OF ALL NECESSARY SERVICING, REPAIR OR CORRECTION.

**12.** IN NO EVENT UNLESS REQUIRED BY APPLICABLE LAW OR AGREED TO IN WRITING WILL ANY COPYRIGHT HOLDER, OR ANY OTHER PARTY WHO MAY MODIFY AND/OR REDISTRIBUTE THE PROGRAM AS PERMITTED ABOVE, BE LIABLE TO YOU FOR DAMAGES, INCLUDING ANY GENERAL, SPECIAL, INCIDENTAL OR CONSEQUENTIAL DAMAGES ARISING OUT OF THE USE OR INABILITY TO USE THE PROGRAM (INCLUDING BUT NOT LIMITED TO LOSS OF DATA OR DATA BEING RENDERED INACCURATE OR LOSSES SUSTAINED BY YOU OR THIRD PARTIES OR A FAILURE OF THE PROGRAM TO OPERATE WITH ANY OTHER PROGRAMS), EVEN IF SUCH HOLDER OR OTHER PARTY HAS BEEN ADVISED OF THE POSSIBILITY OF SUCH DAMAGES.

## Technical Support

If you are experiencing technical problems or if you have questions about the operation, configuration or troubleshooting of any Revolabs product, please email [FLXsupport@revolabs.com](mailto:FLXsupport@revolabs.com) or call +1-800-326-1088