

**COMPLIANCE WORLDWIDE INC.
TEST REPORT 165-14A**

In Accordance with the Requirements of
Industry Canada RSS 213, Issue 2, December 2005
2 GHz License-exempt Personal Communications Service Devices (LE-PCS)

Federal Communications Commission 47 CFR Part 15, Subpart D
Technical Requirements for
Unlicensed Personal Communication Systems (UPCS)

Issued to

**Revolabs, Inc.
144 North Road, Suite 3250
Sudbury, MA 01776**

For the
**HD Elite Antenna
Model Numbers: 02-ELITEREMANT4**

**FCC ID: T5V01EXEC4
IC: 6455A-01EXEC4**

Report Issued on June 13, 2014

Tested by

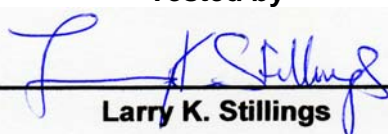

Larry K. Stillings

Reviewed By

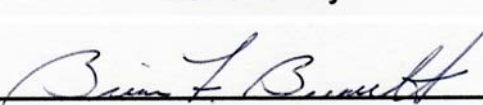

Brian F. Breault

This test report shall not be reproduced, except in full, without written permission from Compliance Worldwide, Inc.

Table of Contents

1. Scope.....	3
2. Product Details.....	3
2.1. Manufacturer.....	3
2.2. Model Number.....	3
2.3. Serial Number.....	3
2.4. Description.....	3
2.5. Power Source.....	3
2.6. Hardware Revision.....	3
2.7. Software Revision.....	3
2.8. Modulation Type.....	3
2.9. Operating Frequency.....	3
2.10. Emission Designator.....	3
2.11. EMC Modifications.....	3
3. Product Configuration.....	3
3.1. Cables.....	3
3.2. EUT Hardware.....	3
3.3. Support Equipment.....	4
3.4. EUT Diagram.....	4
3.6. Test Setup Diagram.....	4
4. Measurements Parameters.....	5
4.1. Measurement Equipment Used to Perform Test.....	5
4.2. Measurement & Equipment Setup.....	6
4.3. Measurement Procedure.....	6
4.4. Choice of Operating Frequencies.....	6
5. Measurement Summary.....	7
6. Measurement Data.....	8
6.1. Antenna Gain.....	8
6.2. Type of Modulation and Access Protocol.....	8
6.3. Peak Transmit Power.....	9
6.4. Emission Bandwidth.....	14
6.5. Spurious Emissions at the antenna terminals.....	22
6.6. Radiated Spurious Emissions (Harmonics).....	33
6.7. Power Spectral Density.....	36
6.8. Conducted Emissions.....	40
6.9. Frequency Stability.....	43
6.10. Transmitter Spurious Emissions.....	44
6.11. Specific Requirements to UPCS Devices.....	48
6.12. Public Exposure to Radio Frequency Energy Levels.....	65
7. Test Images.....	67
8. Test Site Description.....	74

1. Scope

This test report certifies that the Revolabs HD Elite Antenna, as tested, meets the FCC Part 15, Subpart D and Industry Canada RSS 213 requirements. The scope of this test report is limited to the test sample provided by the client, only in as much as that sample represents other production units. If any significant changes are made to the unit, the changes shall be evaluated and a retest may be required.

2. Product Details

- 2.1. Manufacturer:** Revolabs, Inc.
- 2.2. Model Numbers:** Tested 02-ELITEREMANT8 (6250126-00) also represents 02-ELITEREMANT4
- 2.3. Serial Number:** FX325500134 (ant port measurements), FX3255001087 (radiated)
- 2.4. Description:** Remote Antenna for the HD Elite Base Product
- 2.5. Power Source:** 48 VDC via PoE
- 2.6. Hardware Revision:** Rev 7
- 2.7. Software Revision:** ATTN 6 Setting was used for all of the measurements
- 2.8. Modulation Type:** GFSK
- 2.9. Operating Frequencies:** 1921.536 – 1928.448 MHz
- 2.10. Emission Designator:** 1M34F7E (FCC), 1M19F7E (IC)
- 2.11. EMC Modifications:** Steward Ferrite (unmarked) was added to POE Ethernet cable at antenna

3. Product Configuration

3.1. Cables

Cable Type	Length	Shield	From	To
Ethernet	10 M	No	EUT (primary base)	POE Injector and Laptop

3.2. EUT Hardware

Device	Manufacturer	Model	Serial No.	Comment
HD Elite Base Remote Antenna	Revolabs	6250126-00	FX325500134	

3. Product Configuration (continued)

3.3. Support Equipment

Manufacturer	Model/Part #	Input Voltage	Input Freq	Description/Function
Dell	Latitude D620	120V	60	Software Control via Ethernet

3.4 EUT Diagram

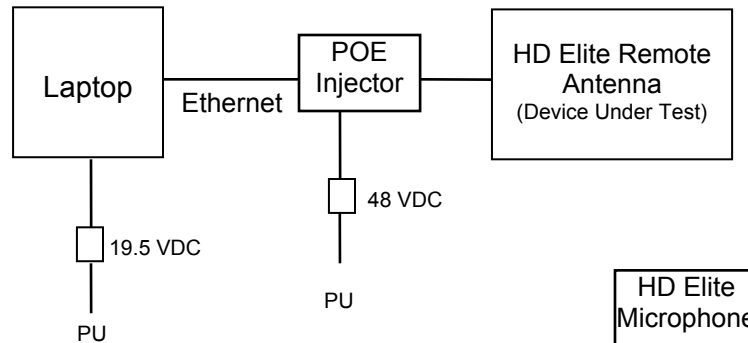

Channel Plan	Channel	Frequency (MHz)	
Measure	0	1928.448	Note: The channel numbers count down vs frequency
	1	1926.720	
Measure	2	1924.992	
	3	1923.264	
Measure	4	1921.536	

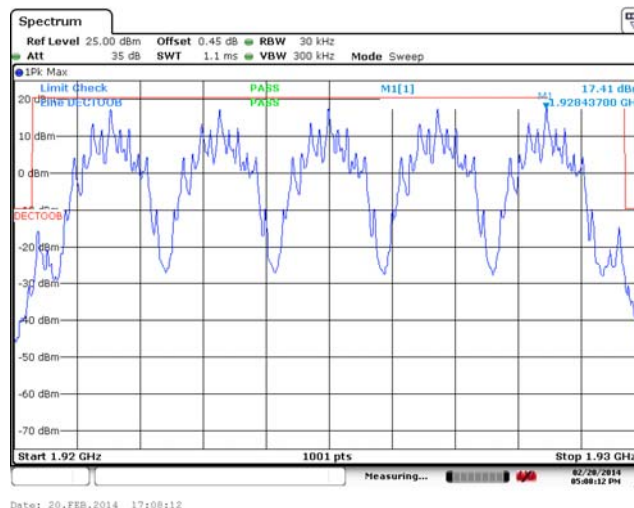

4. Measurements Parameters

4.1. Measurement Equipment Used to Perform Test

Device	Manufacturer	Model No.	Serial No.	Cal Due	Cal Interval
Spectrum Analyzer 10 Hz to 40 GHz	Rohde & Schwarz	FSVR40	100909	5/15/2015	2 yr
Spectrum Analyzer 9 kHz to 40 GHz	Rohde & Schwarz	FSV40	100899	6/6/2015	2 yr
EMI Receiver 9 kHz to 7 GHz	Rohde & Schwarz	ESR7	101156	4/4/2015	2 yr
Bilog Antenna 30 to 2000 MHz	Sunol Sciences	JB1	A050913	5/15/2014	1 yr
Horn Antenna 1 to 18 GHz	ETS-Lindgren	3117	00143292	1/14/2015	2 yr
Horn Antenna 1 to 18 GHz	Electro-Metrics	EM-6961	6337	10/11/2015	2 yr
High Pass Filter 2.5 to 20 GHz	Micro-Tronics	HPM50110	070	2/5/2015	1 yr
DECT 1.88 to 1.93 GHz Notch Filter	Micro-Tronics	BRM18083	001	4/14/2015	1 yr
DMM / Temperature	Fluke	187	79690058	2/22/2015	1 yr
Barometer	Control Company	4195	Cal ID# 236	2/25/2015	2 yr
Thermal Chamber	Associated Testing Labs	SLHU-1-CRLC	N/A	CNR	
Digital Radio Communication Tester	Rohde & Schwarz	CTS65	829877/006	11/2/2014	2 yr
RF Signal Generator 100 kHz - 40 GHz	Rohde & Schwarz	SMB 100A	175352	5/14/2014	2 yr
RF Signal Generator 5 kHz to 6.4 GHz	Rohde & Schwarz	SMIQ06B	100090	2/22/2015	2 yr
Modulation Generator	Rohde & Schwarz	AMIQ04	100540	CBU	
DC Source 0-60 Volts, 0-3 Amps	Hewlett Packard	6296A	1929A03770	9/18/2014	1 yr
Power Splitter Resistive DC – 4.2 GHz	RF Bay	PSC-2R-42	14110124	4/3/2015	1 yr
Power Splitter Resistive DC – 4.2 GHz	RF Bay	PSC-2R-42	14110125	4/3/2015	1 yr
Power Splitter Resistive DC – 4.2 GHz	RF Bay	PSC-2R-42	14110126	4/3/2015	1 yr
Spectrum Analyzer w/DECT Personality	Hewlett Packard	8593E	3829A03887	6/13/2014	2 yr
Dipole Antenna Set 30 to 300 MHz	Schwarzbeck	VHAP-10dB	562	CNR	
Dipole Antenna Set 30 to 300 MHz	Schwarzbeck	VHAP-10dB	563	CNR	
Dipole Antenna Set 300 to 1000 MHz	Schwarzbeck	UHAP-10dB	527	CNR	
Dipole Antenna Set 300 to 1000 MHz	Schwarzbeck	UHAP-10dB	528	CNR	

4. Measurements Parameters (continued)

4.2. Measurement & Equipment Setup

Test Date: 1/31/2014, 2/19/2014, 2/20/2014, 2/24/2014, 3/3/2014

Test Engineer: Larry Stillings

Normal Site Temperature (15 – 35 °C): 21.6 °C

Relative Humidity (20 – 75 %RH): 35 %

Frequency Range: 150 kHz to 19.3 GHz

Measurement Distance: 3 Meters or 1 Meter as necessary

EMI Receiver IF Bandwidth: 9 kHz – 150 kHz to 30 MHz
120 kHz - 30 MHz to 1000 MHz
1 MHz - Above 1000 MHz

EMI Receiver Avg Bandwidth: 30 kHz – 150 kHz to 30 MHz
300 kHz - 30 MHz to 1000 MHz
3 MHz - Above 1000 MHz

Detector Function: Peak, Quasi-Peak, EMI Average and RMS Average

4.3. Measurement Procedure

Test measurements were made in accordance FCC Part 15.315, 15.317, 15.319, 15.323, IC RSS-213 Issue 2, and ANSI C63.17:2006.

The test methods used to generate the data in this test report is in accordance with ANSI C63.17:2006, American National Standard Methods of Measurement of the Electromagnetic and Operational Compatibility of Unlicensed Personal Communications Services (UPCS) Devices.

4.4. Measurement Uncertainty

The following uncertainties are expressed for an expansion/coverage factor of K=2.

RF Frequency (out of band)	$\pm 1 \times 10^{-8}$
Radiated Emission of Transmitter to 20 GHz	± 4.55 dB
Radiated Emission of Receiver	± 4.55 dB
Temperature	$\pm 0.91^{\circ}$ C
Humidity	$\pm 5\%$

5. Measurements Summary

Test Requirement	FCC Rule Requirement	IC Rule Requirement	Test Report Section	Result	Comment
Antenna Requirement	15.317 15.203	RSS-GEN 7.1.4	6.1	Compliant	Equipment uses an PCB Mounted Ant
Antenna Gain	15.319 (e)	RSS 213 4.1(e)	6.1	Compliant	2.35 dBi Maximum
Type of Modulation and Access Protocol	15.319 (b) 15.307	RSS-213 6.1	6.2	Compliant	Device uses GFSK Digital Modulation
Peak Transmit Power	15.319 (c)	RSS-213 6.5	6.3	Compliant	
Emission Bandwidth Occupied Bandwidth	15.323 (a)	RSS-213 6.4	6.4	Compliant	
Spurious Conducted Emissions – Antenna Port	15.323 (d) 15.319 (g)	RSS-213 6.7	6.5	Compliant	
Spurious Radiated Emissions for integral antennas	15.323 (d) 15.319 (g) 15.209	RSS-213 6.7	6.6	Compliant	
Power Spectral Density	15.319 (d)	RSS-213 6.6	6.7	Compliant	
Conducted Emissions	15.315 15.207	RSS-213 6.3 RSS-GEN	6.8	Compliant	
Frequency Stability	15.323 (f)	RSS-213 6.2	6.9	Compliant	
Transmitter Spurious Emissions	15.323 (d) 15.209	RSS-213 6.7	6.10	Compliant	
Specific Requirements for UPCS	15.323 (c) 15.323 (e)	RSS-213 4.3.4 RSS-213 6.1	6.11	Compliant	
Radio Frequency Exposure	15.319 (i) 2.1091 FCC OET Bulletin 65	RSS-GEN 5.5 RSS-102	6.12	Compliant	

6. Measurement Data

6.1. Antenna Requirement (15.317, 15.203), RSS-GEN Section 7.1.4

Requirement: An intentional radiator shall be designed to ensure that no antenna other than that furnished by the responsible party shall be used with the device. The use of a permanently attached antenna or of an antenna that uses a unique coupling to the intentional radiator shall be considered sufficient to comply. Further, this requirement does not apply to intentional radiators that must be professionally installed, such as perimeter protection systems and some field disturbance sensors, or to other intentional radiators which, in accordance with § 15.31(d), must be measured at the installation site. However, the installer shall be responsible for ensuring that the proper antenna is employed so that the limits in this part are not exceeded.

Result: The EUT incorporates two PCB mounted antennas for antenna diversity.

6.1.1 Antenna Gain (15.319 (e)), RSS-213 Section 4.1(e)

Requirement: The peak transmit power shall be reduced by the amounts in decibels that the maximum directional gain of the antenna exceeds 3 dBi

Result: Compliant, the EUT uses five PCB Mount antennas for antenna diversity with a maximum gain of 2.35 dBi. One antenna is used for receiving only.

6.2 Type of Modulation and Access Protocol (15.319 (b), 15.307), RSS-213 Sect 4.1(e)

Requirement: UTAM, Inc. is designated to coordinate and manage the transition of the 1910–1930 MHz band from the Private Operational-Fixed Microwave Service (OFS) operating under part 101 of this chapter to unlicensed PCS operations.

Result: A letter from UTAM to Revolabs, Inc. will be provided as part of the submittal.

Requirement: Equipment certified under this standard shall use digital modulation.

Result: The product uses GFSK digital modulation.

6. Measurement Data

6.3. Peak Transmit Power (15.319 (c)), RSS-213 Sec 6.5

Requirement: Peak transmit power shall not exceed 100 microwatts multiplied by the square root of the emission bandwidth in Hertz. Peak transmit power must be measured over any interval of continuous transmission using instrumentation calibrated in terms of an RMS equivalent voltage.

Peak power shall not exceed 100 microwatts multiplied by the square root of the occupied bandwidth in hertz.

EBW = 1339700 Hz, OBW = 1192800 Hz

$P_{max} = 100 \mu W * (EBW)^{1/2} = 100 \mu W * (1339700)^{1/2} = 115.75 mW = 20.16 dBm$

$P_{max} = 100 \mu W * (OBW)^{1/2} = 100 \mu W * (1192800)^{1/2} = 109.22 mW = 20.38 dBm$

BB1 ANT 0 Channel	Channel Frequency	Peak Power	Requirement	Peak Power
	MHz	dBm	FCC = 20.64 dBm, IC = 20.38 dBm	Watts
TX4	1921.536	19.93	Compliant	0.098
TX2	1924.992	20.01	Compliant	0.100
TX0	1928.448	20.16	Compliant	0.104

BB2 ANT 1 Channel	Channel Frequency	Peak Power	Requirement	Peak Power
	MHz	dBm	FCC = 20.64 dBm, IC = 20.38 dBm	Watts
TX4	1921.536	19.76	Compliant	0.095
TX2	1924.992	19.76	Compliant	0.095
TX0	1928.448	19.79	Compliant	0.095

6. Measurement Data

6.3. Peak Transmit Power (15.319 (c)), RSS-213 Sec 6.5 cont.

Channel 0 – BB1

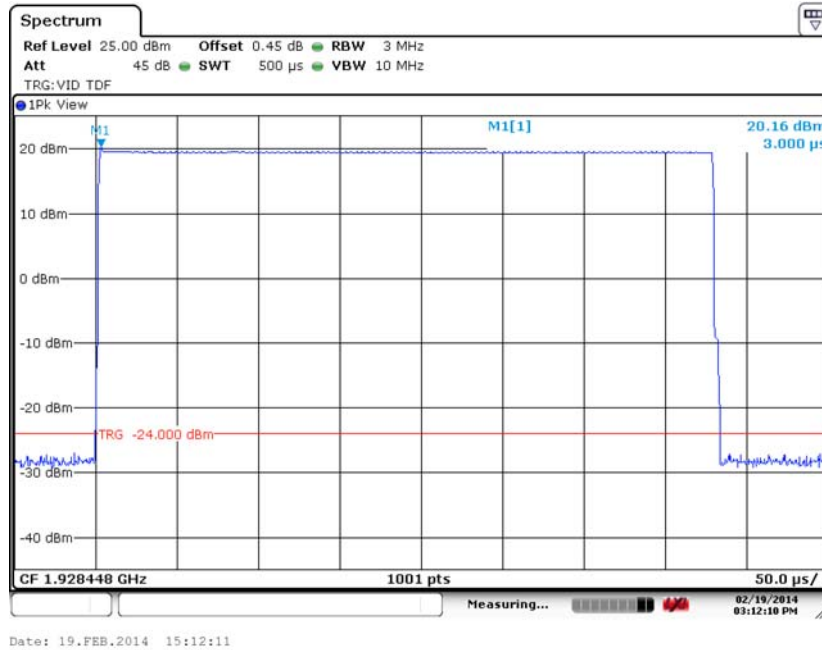

Channel 2 – BB1

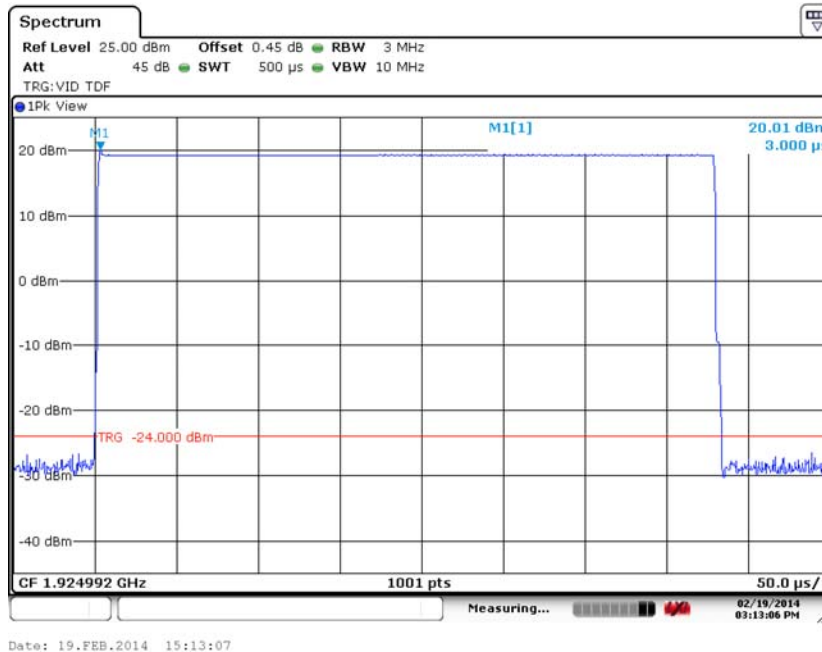

6. Measurement Data

6.3. Peak Transmit Power (15.319 (c)), RSS-213 Sec 6.5 cont.

Channel 4 – BB1

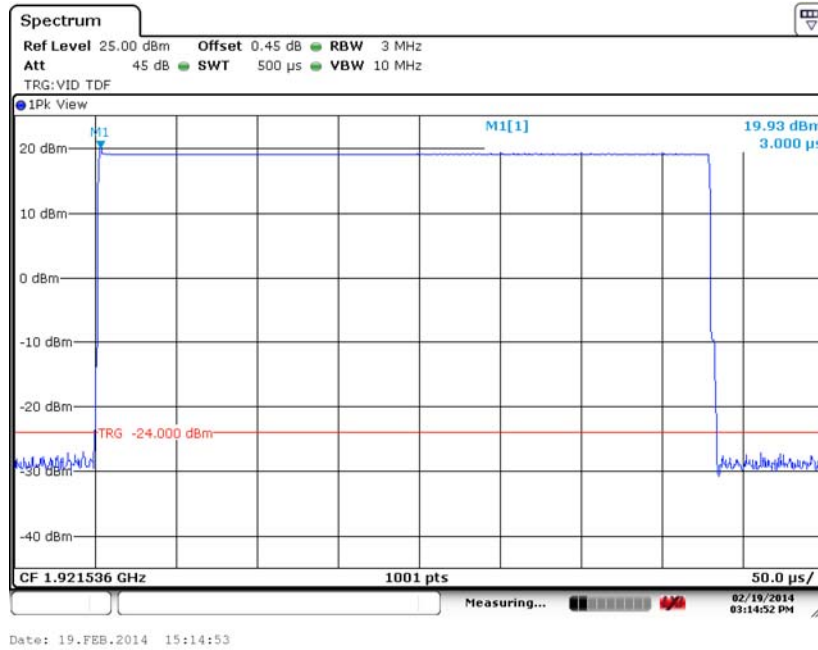

Channel 0 – BB2

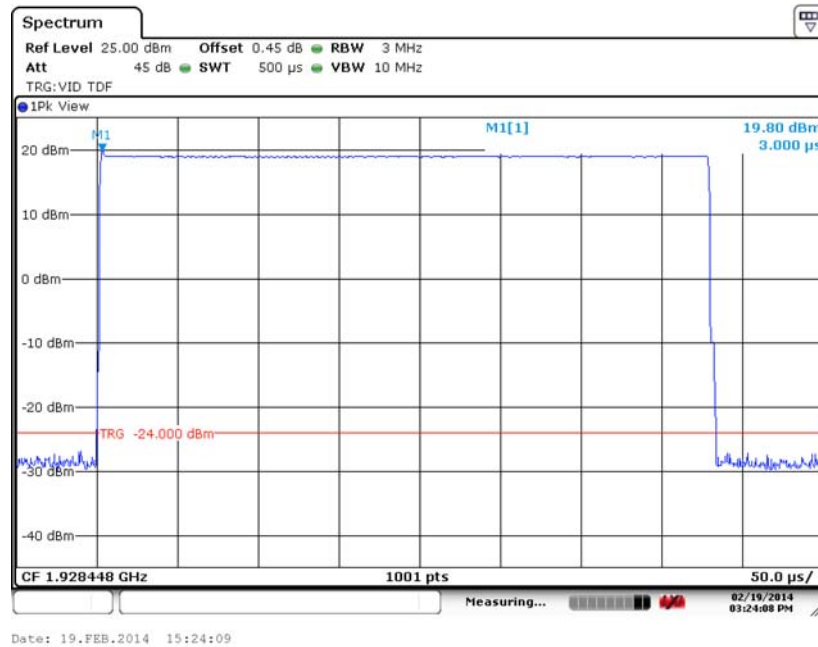

6. Measurement Data

6.3. Peak Transmit Power (15.319 (c)), RSS-213 Sec 6.5 cont.

Channel 2 – BB2

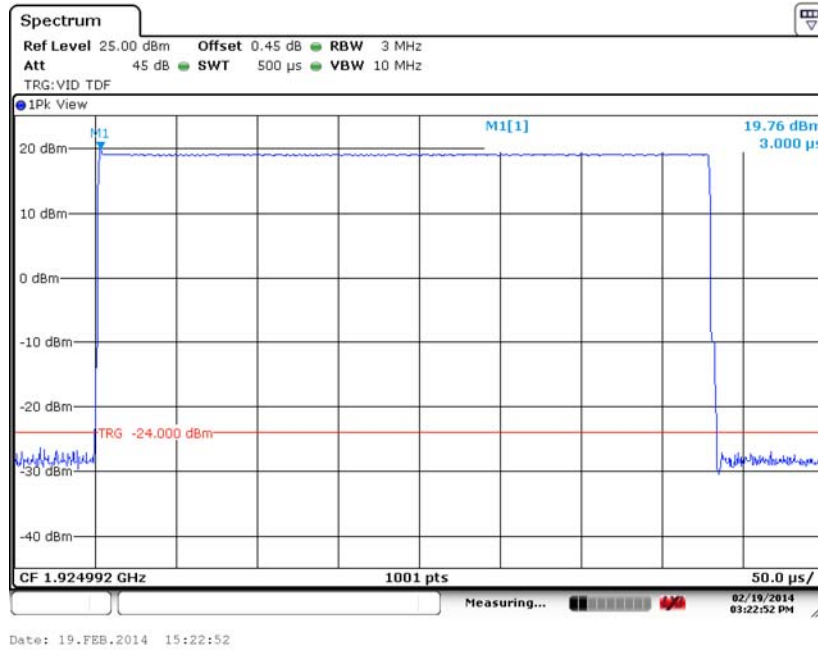

Channel 4 – BB2

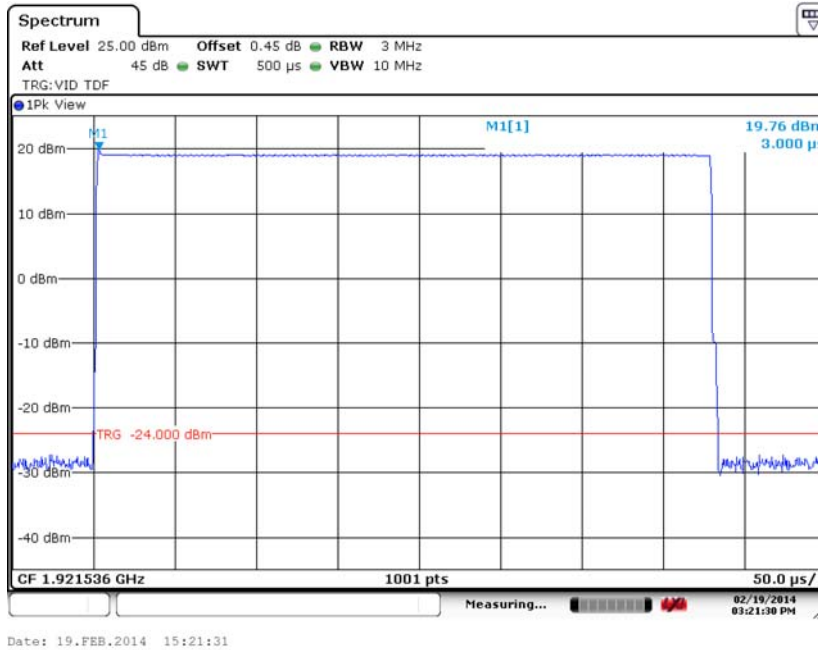

6. Measurement Data

6.3. Peak Transmit Power (15.303 (f)), RSS-213 Sec 6.5 (cont)

Requirement: Radiated Emissions test is performed on device that only contains integral antenna(s) to determine their gain. Gain shall be less than 3 dBi or output power shall be adjusted.
 Field strength was measured at 3 Meters and 95.2 dBuV/m conversion was used to determine Radiated Peak Power in dBm.

Result: Peak Field Strength is $22.38 + 95.2 = 117.58$ dBuV/m at 3 Meters

Radiated Test for Integral Antennas					
BB1 Channel	Channel Frequency	Conducted Peak Power	Radiated Peak Power	Antenna Gain	Result
	MHz	dBm	dBm	dBi	
TX4	1921.536	19.93	22.12	2.19	Compliant
TX2	1924.992	20.01	22.36	2.35	Compliant
TX0	1928.448	20.16	22.38	2.22	Compliant

Radiated Test for Integral Antennas					
BB2 Channel	Channel Frequency	Conducted Peak Power	Radiated Peak Power	Antenna Gain	Result
	MHz	dBm	dBm	dBi	
TX4	1921.536	19.76	18.95	-0.81	Compliant
TX2	1924.992	19.76	19.40	-0.36	Compliant
TX0	1928.448	19.79	19.87	0.08	Compliant

6. Measurement Data

6.4. Emission Bandwidth (15.323 (a))

Requirement: Operation shall be contained within the 1920–1930 MHz band. The emission bandwidth shall be less than 2.5 MHz. The power level shall be as specified in § 15.319(c), but in no event shall the emission bandwidth be less than 50 kHz.

6.4.1. Measurement Data – 26 dB Emission Bandwidth (EBW)

BB1 ANT 0 Channel	Channel Frequency	Emission Bandwidth	Requirement
	MHz	MHz	50 kHz < EBW < 2.5 MHz
TX4	1921.536	1.3007	Compliant
TX2	1924.992	1.2977	Compliant
TX0	1928.448	1.2977	Compliant

BB2 ANT 1 Channel	Channel Frequency	Emission Bandwidth	Requirement
	MHz	MHz	50 kHz < EBW < 2.5 MHz
TX4	1921.536	1.3007	Compliant
TX2	1924.992	1.3007	Compliant
TX0	1928.448	1.2977	Compliant

Note: Please see the next pages for plots of measurements

6. Measurement Data (continued)

6.4. Emission Bandwidth (15.323 (a) (continued))

6.4.2. Measurement Plot – TX0 – BB1



Date: 19.FEB.2014 17:19:01

6.4.3. Measurement Plot – TX2 – BB1



Date: 19.FEB.2014 17:28:12

6. Measurement Data (continued)

6.4. Emission Bandwidth (15.323 (a) (continued))

6.4.4. Measurement Plot – TX4 – BB1

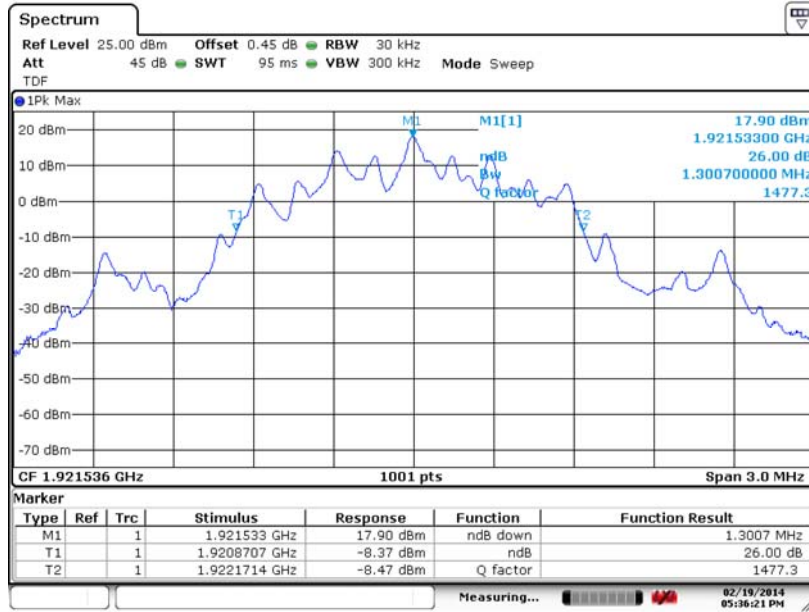

Date: 19.FEB.2014 17:36:22

6.4.5. Measurement Plot – TX0 – BB2

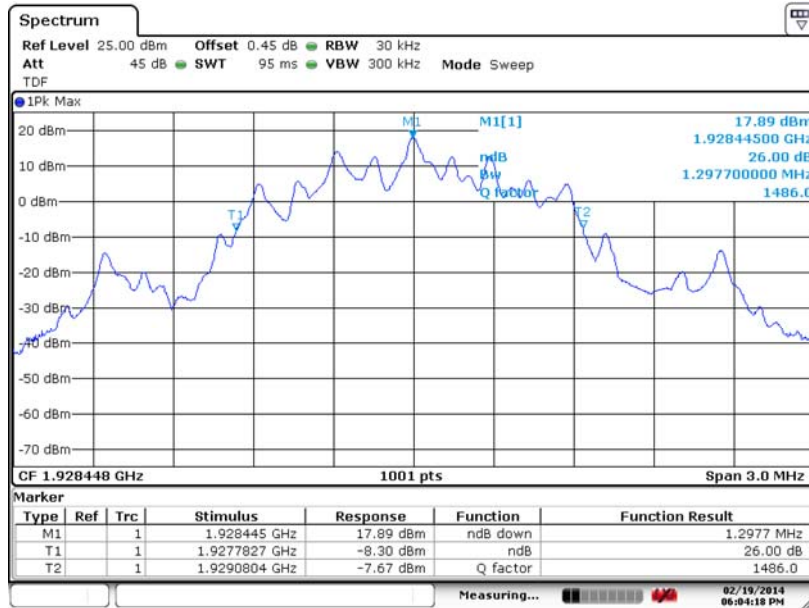

Date: 19.FEB.2014 18:04:19

6. Measurement Data (continued)

6.4. Emission Bandwidth (15.323 (a) (continued))

6.4.6. Measurement Plot – TX2 – BB2

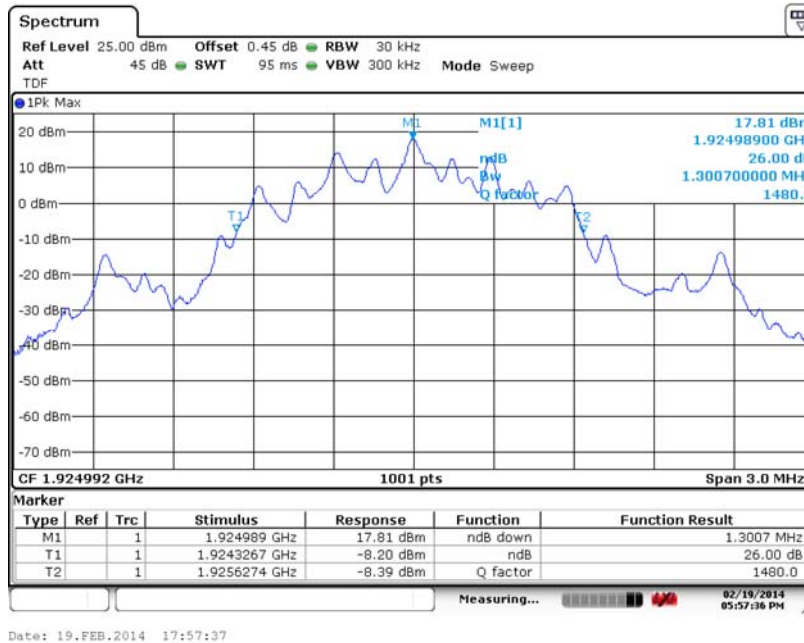

6.4.7. Measurement Plot – TX4 – BB2

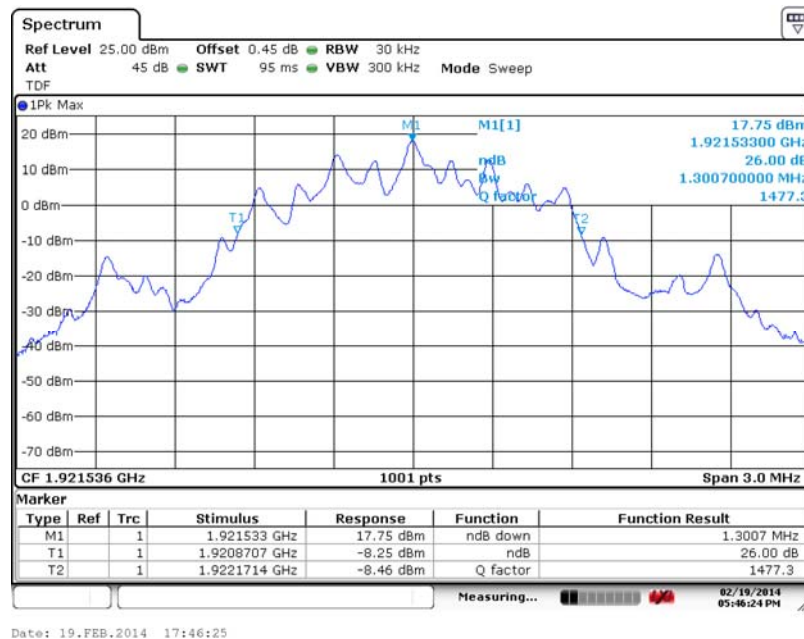

6. Measurement Data (continued)

6.4. Occupied Bandwidth (RSS-213 Section 6.4)

Requirement: Operation shall be contained within the 1920–1930 MHz band. The occupied bandwidth shall not be less than 50 kHz nor more than 2.5 MHz.

6.4.15. Measurement Data – 99% Occupied Bandwidth (OBW)

BB1 ANT 0 Channel	Channel Frequency	Occupied Bandwidth	Requirement
	MHz	MHz	50 kHz < OBW < 2.5 MHz
TX4	1921.536	1.1838	Compliant
TX2	1924.992	1.1838	Compliant
TX0	1928.448	1.1808	Compliant

BB2 ANT 1 Channel	Channel Frequency	Occupied Bandwidth	Requirement
	MHz	MHz	50 kHz < OBW < 2.5 MHz
TX4	1921.536	1.1838	Compliant
TX2	1924.992	1.1838	Compliant
TX0	1928.448	1.1838	Compliant

Note: Please see the next pages for plots of measurements

6. Measurement Data (continued)

6.4. Occupied Bandwidth (RSS-213 Section 6.4) (continued)

6.4.16. Measurement Plot – TX0 – BB1

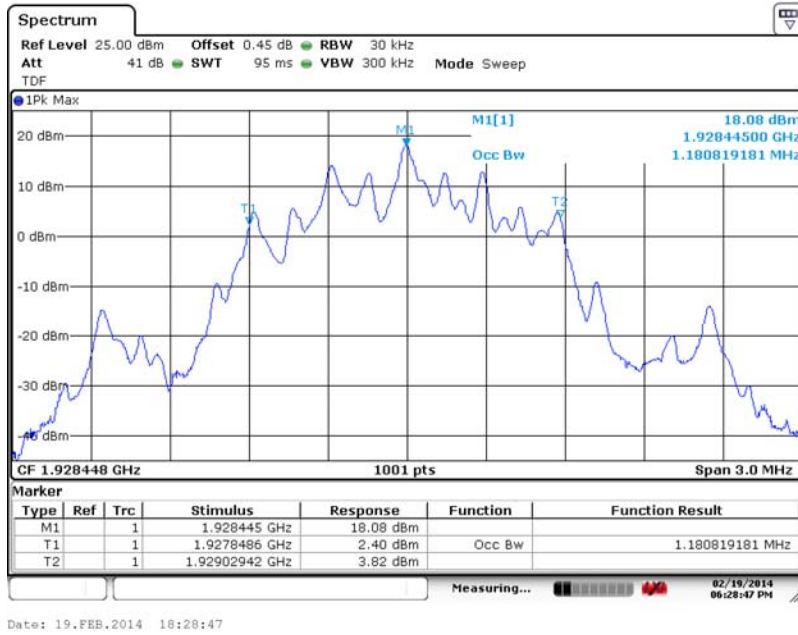

6.4.17. Measurement Plot – TX2 – BB1

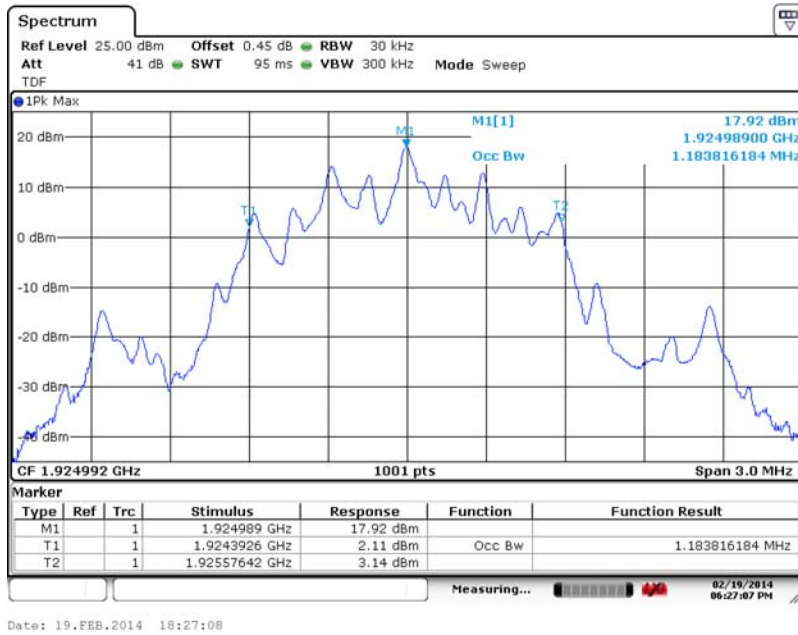

6. Measurement Data (continued)

6.4. Occupied Bandwidth (RSS-213 Section 6.4) (continued)

6.4.18. Measurement Plot – TX4 – BB1

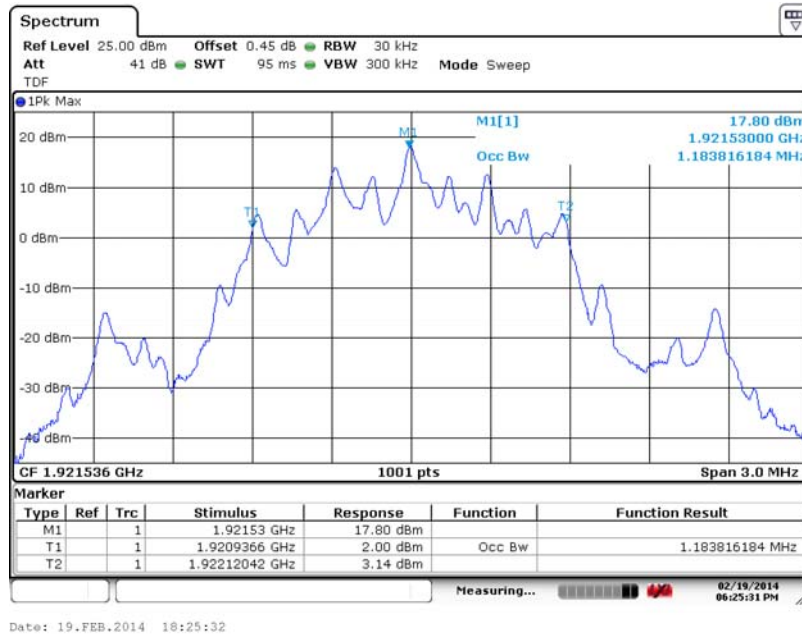

6.4.19. Measurement Plot – TX0 – BB2



6. Measurement Data (continued)

6.4. Occupied Bandwidth (RSS-213 Section 6.4) (continued)

6.4.20. Measurement Plot – TX2 – BB2

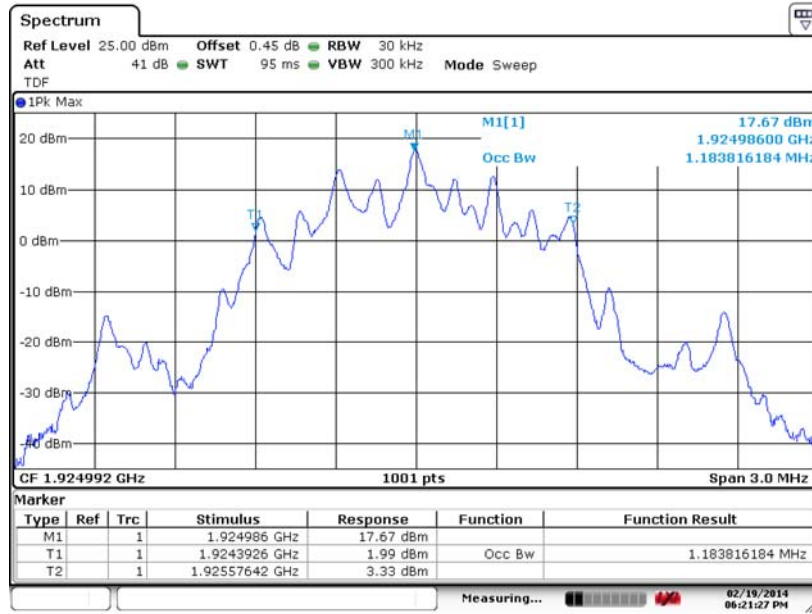

6.4.21. Measurement Plot – TX4 – BB2

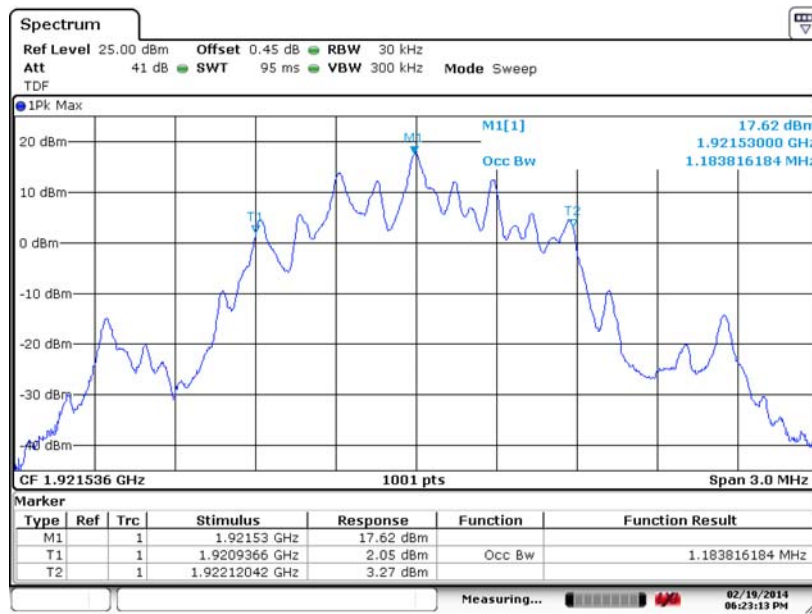

6. Measurement Data (continued)

6.5 Spurious Emissions at the antenna terminals (15.323 (d), RSS-213 6.7.2))

Requirement: Emissions inside the sub-band must comply with the following emission mask: In the bands between 1B and 2B measured from the center of the emission bandwidth the total power emitted by the device shall be at least; 30 dB below the transmit power permitted for that device; in the bands between 2B and 3B measured from the center of the emission bandwidth the total power emitted by an intentional radiator shall be at least 50 dB below the transmit power permitted for that radiator; in the bands between 3B and the subband edge the total power emitted by an intentional radiator in the measurement bandwidth shall be at least 60 dB below the transmit power permitted for that radiator.

- 30 dB between the frequencies 1B and 2B measured from the centre of the occupied bandwidth;
- 50 dB between the frequencies 2B and 3B measured from the centre of the occupied bandwidth; and
- 60 dB between the frequencies 3B and band edge, where B is the occupied bandwidth in hertz.

6.5.1 Low Channel – In Band – BB1

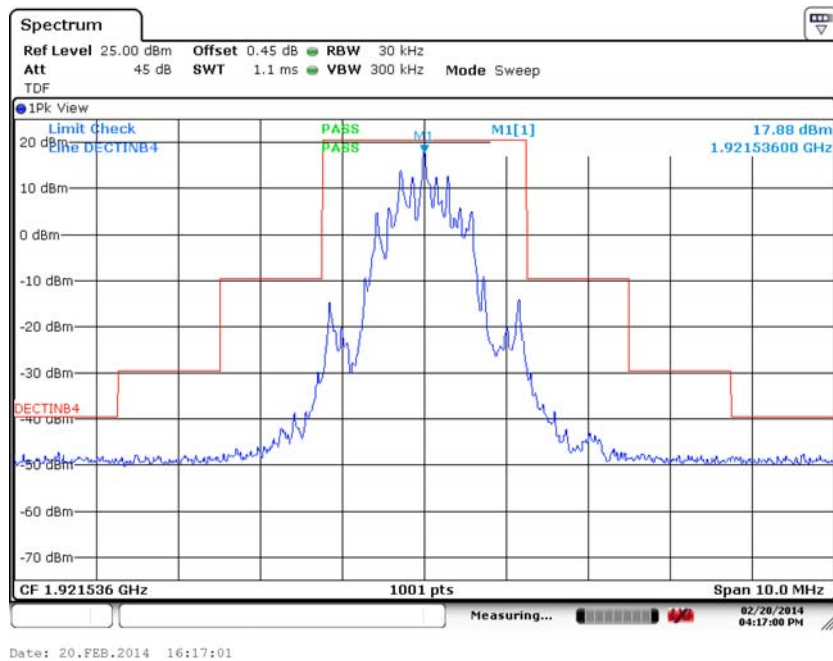

Test Number: 165-14A

Issue Date: 6/13/2014

6. Measurement Data (continued)

6.5 Spurious Emissions at the antenna terminals (15.323 (d), RSS-213 6.7.2)) (cont)

6.5.2 Mid Channel – In Band – BB1

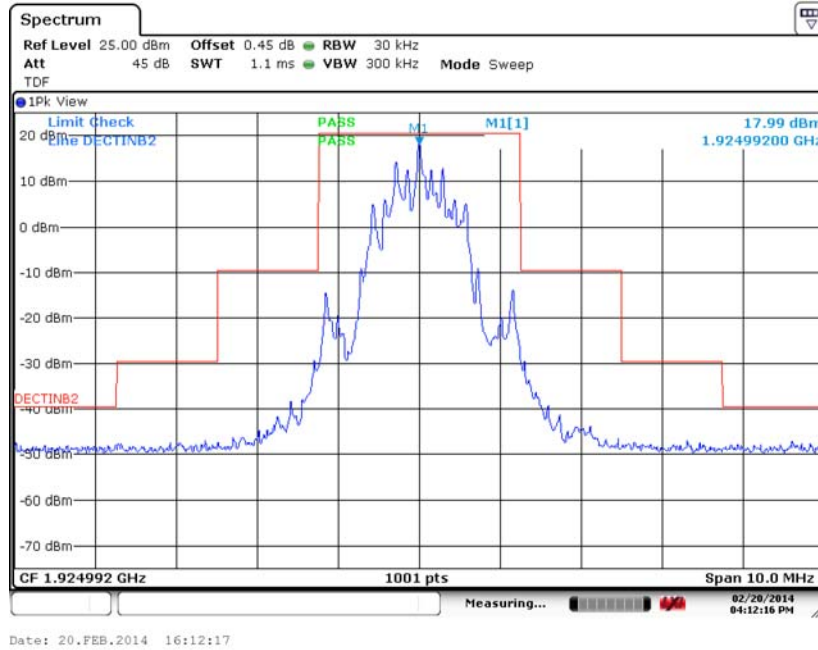

6.5.3 High Channel – In Band – BB1

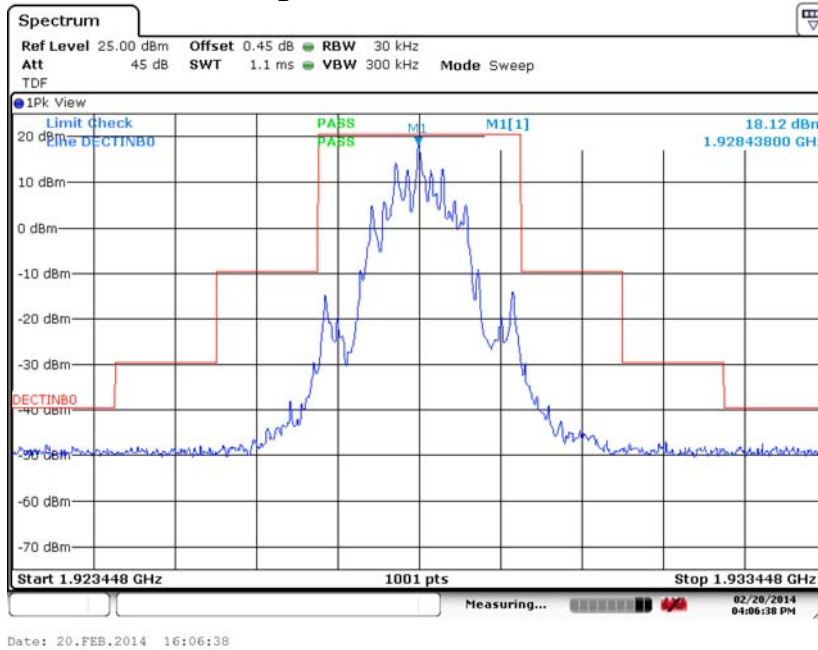

6. Measurement Data (continued)

6.5 Spurious Emissions at the antenna terminals (15.323 (d), RSS-213 6.7.2)) (cont)

6.5.4 Low Channel – In Band – BB2

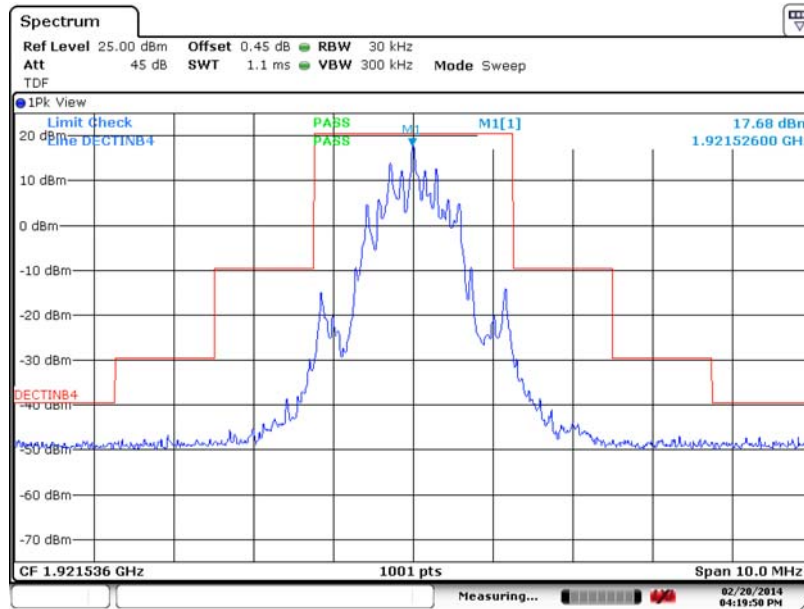

Date: 20.FEB.2014 16:19:51

6.5.5 Mid Channel – In Band – BB2

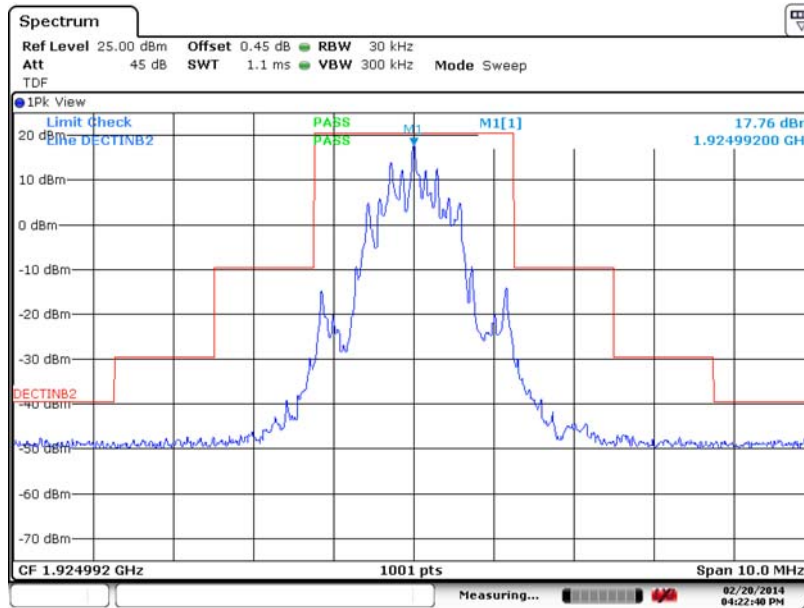

Date: 20.FEB.2014 16:22:41

Test Number: 165-14A

Issue Date: 6/13/2014

6. Measurement Data (continued)

6.5 Spurious Emissions at the antenna terminals (15.323 (d), RSS-213 6.7.2)) (cont)

6.5.6 High Channel – In Band – BB2

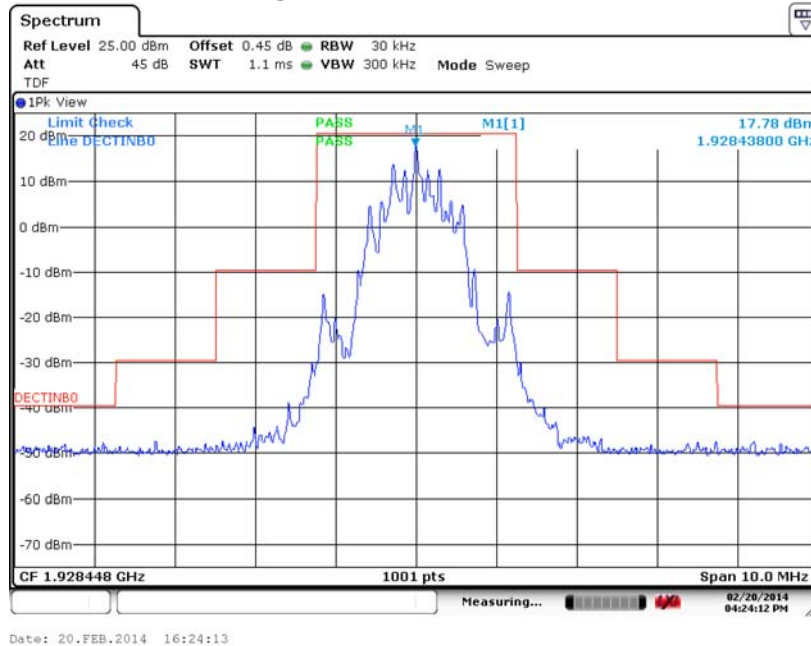

6. Measurement Data (continued)

6.5 Spurious Emissions at the antenna terminals (15.323 (d), RSS-213 6.7.1) (cont)

Requirement: Emissions outside the sub-band shall be attenuated below a reference power of 112 milliwatts as follows: 30 dB between the sub-band and 1.25 MHz above or below the sub-band; 50 dB between 1.25 and 2.5 MHz above or below the sub-band; and 60 dB at 2.5 MHz or greater above or below the sub-band.

Per ANSI C63.17-2006 Clause 6.1.6.2 the emissions in the region 2.5 MHz or greater above and below the limit can either meet the requirements outlined below or be made as a radiated emissions test and not exceed the limits of section 15.209.

Emissions outside the 1920-1930 MHz band shall be attenuated below a reference power of 112 milliwatts (-9.5 dBW) by at least:

- 30 dB between the band edges and 1.25 MHz above and below the band edges;
- 50 dB between 1.25 MHz and 2.5 MHz above or below the band edges; and
- 60 dB at 2.5 MHz or greater above or below the band edges.

6.5.13 Low Channel – Out of Band 30 MHz – 1.915 GHz

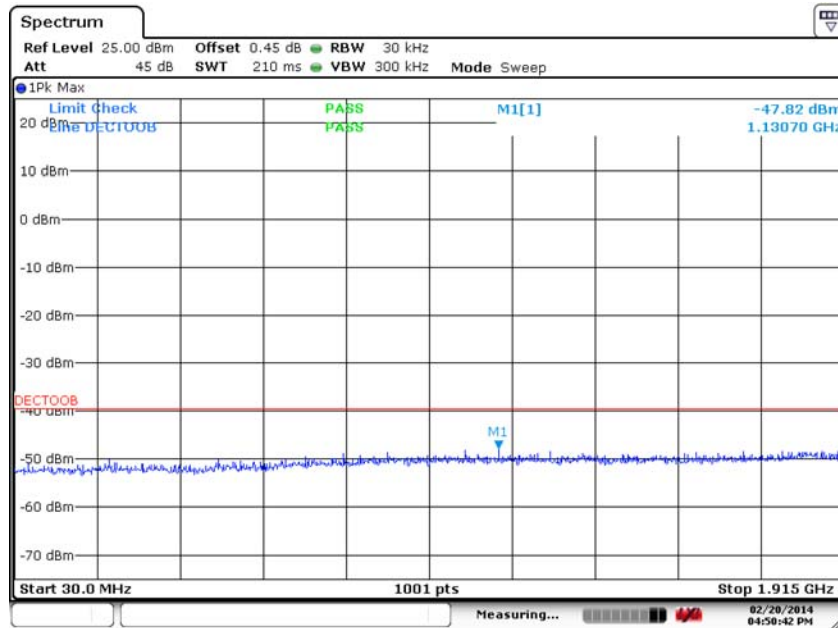

Date: 20.FEB.2014 16:50:42

6. Measurement Data (continued)

6.5 Spurious Emissions at the antenna terminals (15.323 (d), RSS-213 6.7.1) (cont)

6.5.14 Low Channel – Out of Band 1.915 – 1.920 GHz

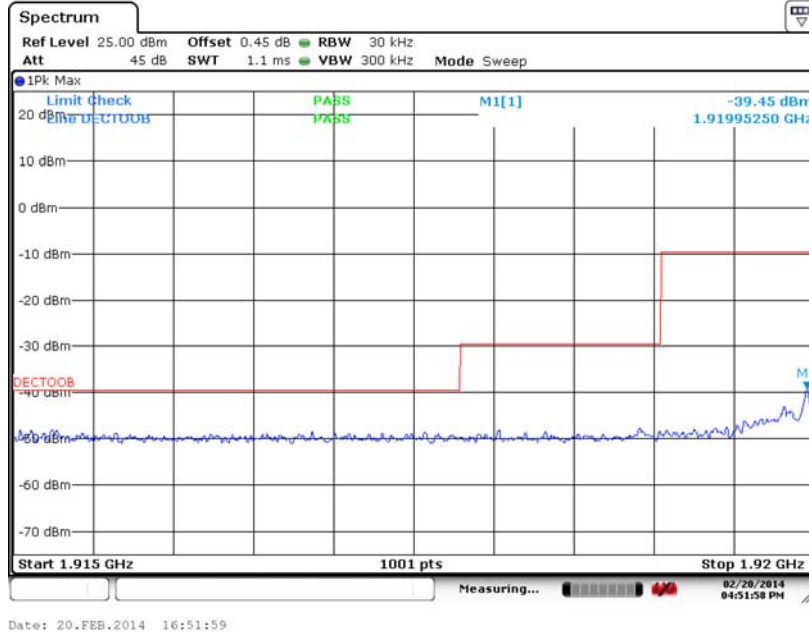

6.5.15 Low Channel Out of Band 1.930 – 1.935 GHz

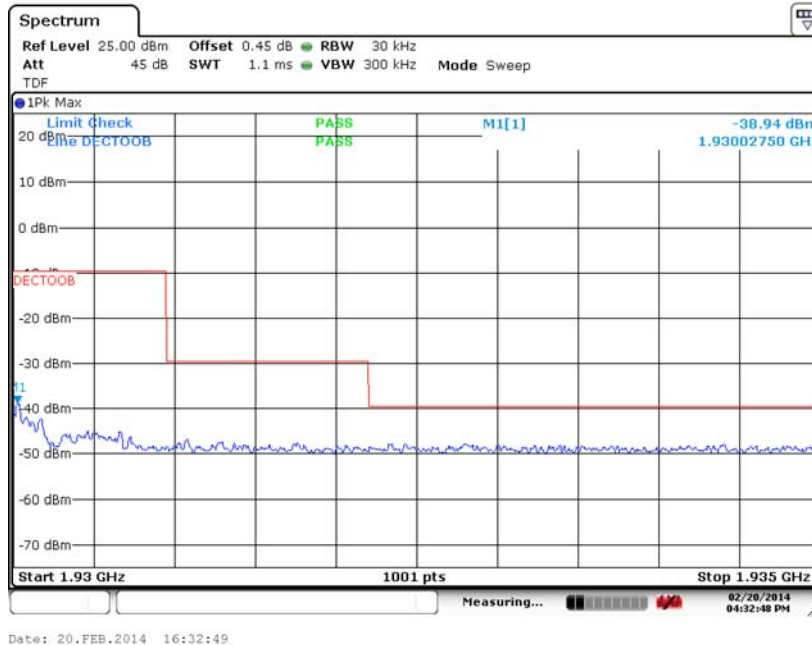

6. Measurement Data (continued)

6.5 Spurious Emissions at the antenna terminals (15.323 (d), RSS-213 6.7.1) (cont)

6.5.16 Low Channel Out of Band 1.935 – 19.3 GHz

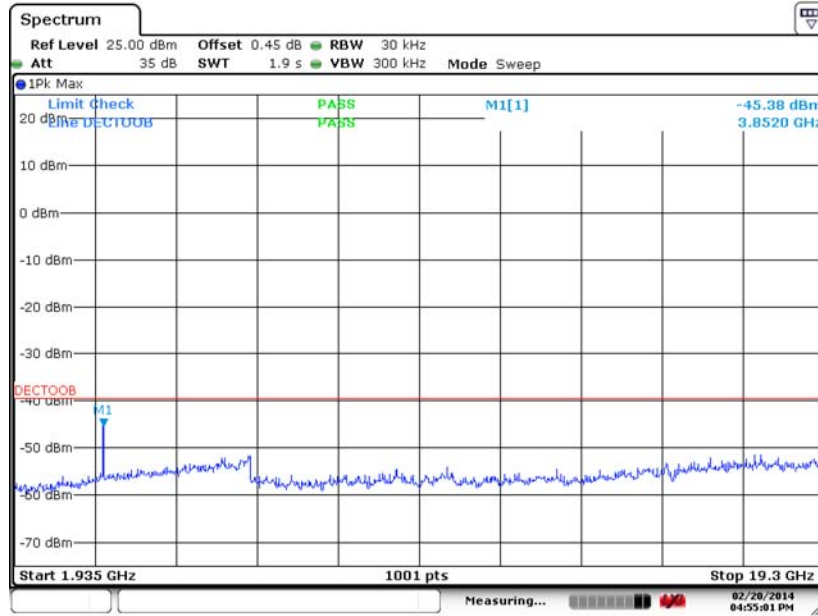

6.5.17 Mid Channel Out of Band 30 MHz – 1.915 GHz

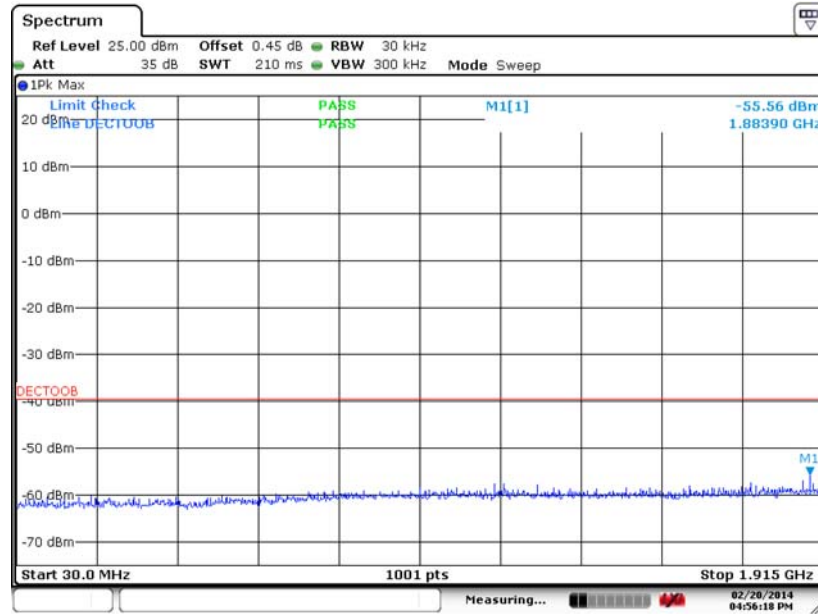

6. Measurement Data (continued)

6.5 Spurious Emissions at the antenna terminals (15.323 (d), RSS-213 6.7.1) (cont)

6.5.18 Mid Channel Out of Band 1.915 – 1.920 GHz

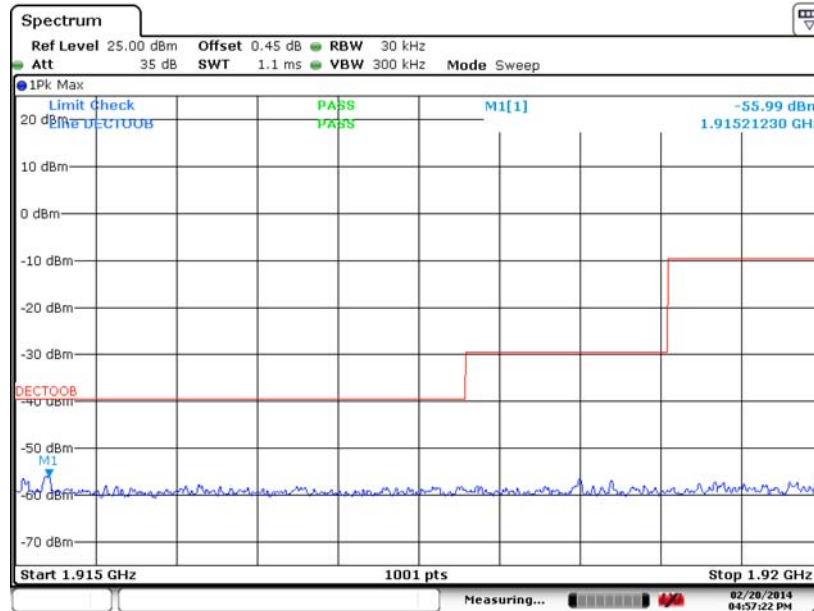

6.5.19 Mid Channel Out of Band 1.930 – 1.935 GHz

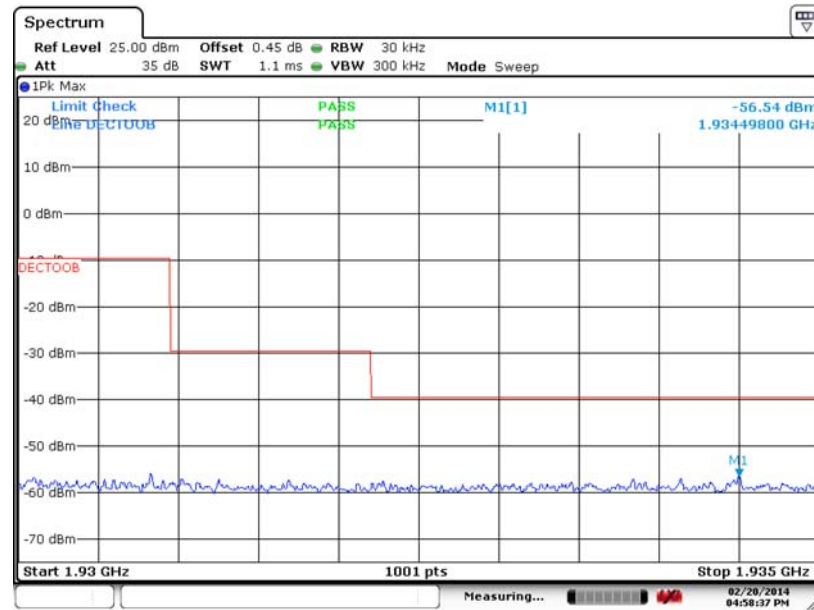

Test Number: 165-14A

Issue Date: 6/13/2014

6. Measurement Data (continued)

6.5 Spurious Emissions at the antenna terminals (15.323 (d), RSS-213 6.7.1) (cont)

6.5.20 Mid Channel Out of Band 1.935 – 19.3 GHz

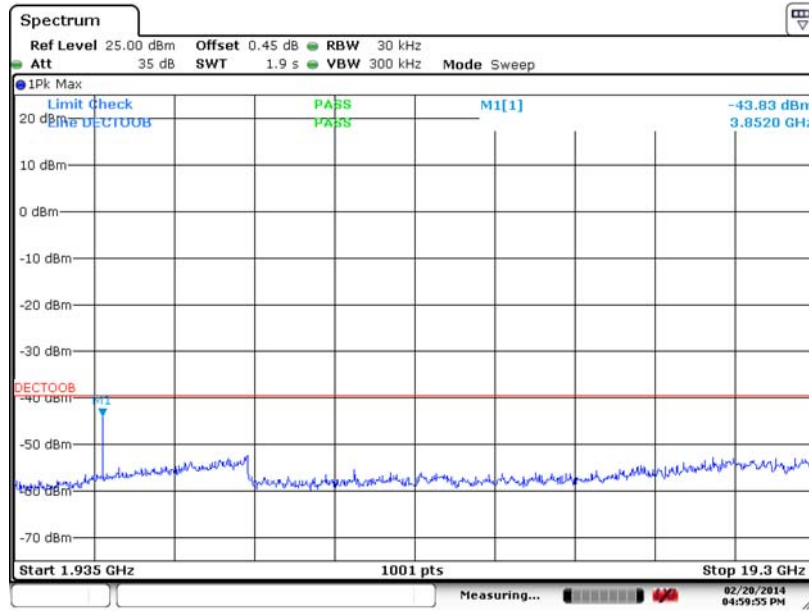

6.5.21 High Channel Out of Band 30 MHz – 1.915 GHz

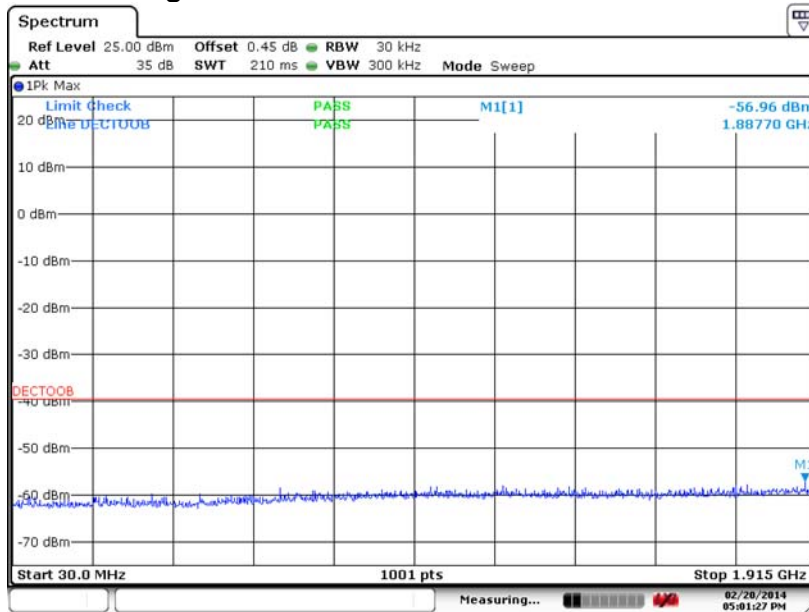

6. Measurement Data (continued)

6.5 Spurious Emissions at the antenna terminals (15.323 (d), RSS-213 6.7.1) (cont)

6.5.22 High Channel Out of Band 1.915 – 1.920 GHz

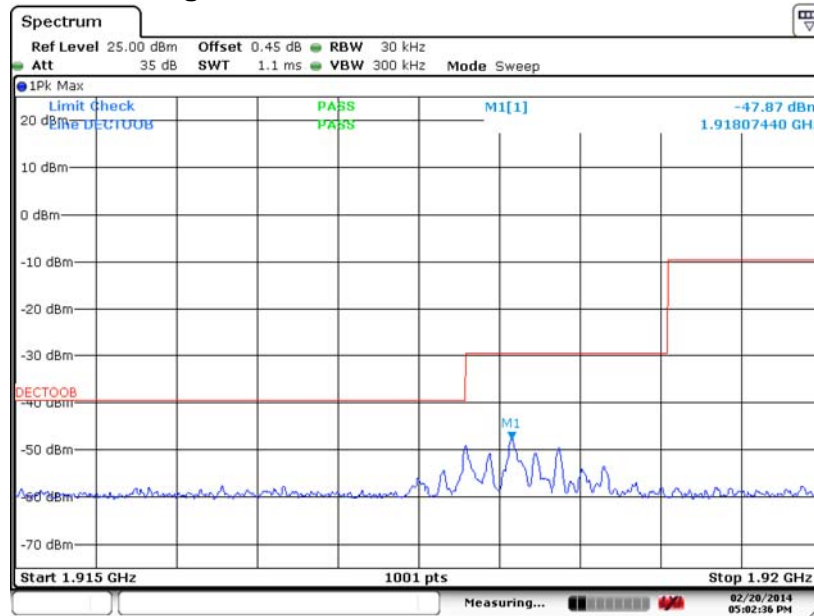

6.5.23 High Channel Out of Band 1.930 – 1.935 GHz

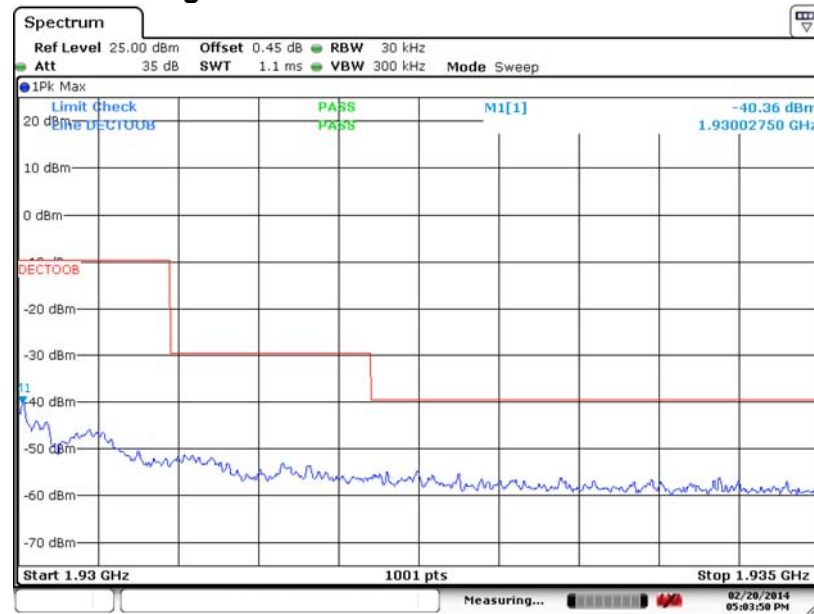

6. Measurement Data (continued)

6.5 Spurious Emissions at the antenna terminals (15.323 (d), RSS-213 6.7.1) (cont)

6.5.24 High Channel Out of Band 1.935 – 19.3 GHz

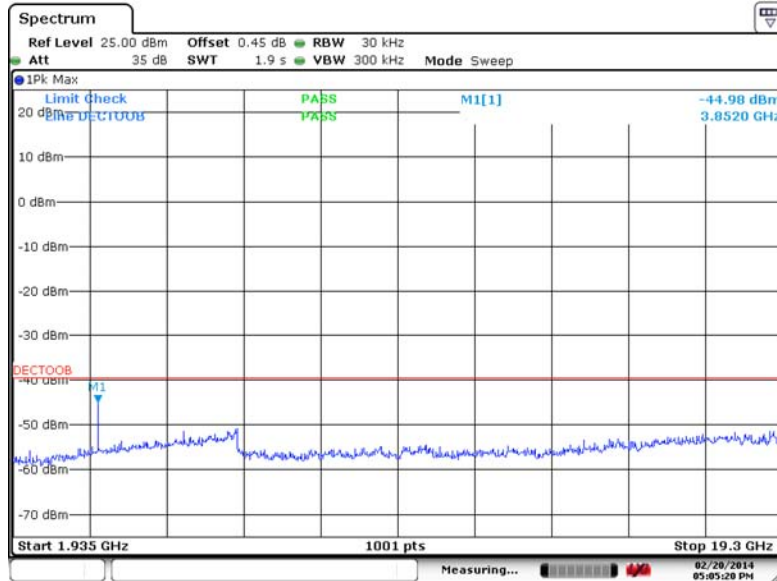

Date: 20.FEB.2014 17:05:21

6. Measurement Data

6.6. Radiated Spurious Emissions (Harmonics)

Regulatory Limit: FCC Part 15.323(d), 15.209, IC RSS-213 6.7, RSS-GEN

Frequency Range (GHz)	Limits (dBµV/m)	
	Peak	Average
1.0 to 19.3	74	54

6.6.1. Measurement Equipment Used to Perform Test

Device	Manufacturer	Model No.	Serial No.	Cal Due	Cal Interval
Horn Antenna 1-18	EMCO	3117	00143292	1/14/2015	2 yr
Horn Antenna 18-40	Com Power	AH-840	03075	8/27/2014	2 yr
Spectrum Analyzer 9 kHz to 40 GHz	Rohde & Schwarz	FSV40	100899	6/6/2015	2 yr
Preamplifier 1 – 26.5	Hewlett Packard	8449B	3008A01323	6/5/2015	2 yr
DECT 1.88 to 1.93 GHz Notch Filter	Micro-Tronics	BRM18083	001	4/14/2015	1 yr
Manufacturer	Software Description		Title/Model #	Rev.	
Compliance Worldwide	Test Report Generation Software		Test Report Generator	1.0	

6.6.2. Measurement & Equipment Setup

Test Date: March 5, 2014
 Test Engineer: Cody Merry
 Site Temperature (°C): 21.6
 Relative Humidity (%RH): 35
 Frequency Range: 1.0 GHz to 19.3 GHz
 EMI Receiver IF Bandwidth: 1 MHz
 EMI Receiver Avg Bandwidth: 3 MHz
 Detector Functions: Peak, Average

6.6.3. Test Procedure

Test measurements were made in accordance with ANSI C63.4-2003, Standard Methods of Measurement of Radio Noise Emissions from Low-Voltage Electrical and Electronics Equipment in the Range of 9 kHz to 40 GHz.

6. Measurement Data (continued)

6.6 Spurious Emissions for integral antennas (15.323 (d), 15.209, RSS-213 6.7.1) (cont)

Low Channel

Frequency (MHz)	Amplitude (dBµV/m)		Peak Limit	Peak Margin (dB)	Average Limit	Average Margin (dB)	Ant Pol	Ant Ht	TT Pos	Result
	Peak	Avg					H/V	cm	Deg	
3843	67.16	38.95	74	-6.84	54	-15.05	V	100	148	Compliant
5765	66.22	40.13	74	-7.78	54	-13.87	V	100	188	Compliant
7686	71.85	43.43	74	-2.15	54	-10.57	V	100	270	Compliant
9608	66.04	43.00	74	-7.96	54	-11.00	V	100	173	Compliant
11529	56.79	42.67	74	-17.21	54	-11.33	V	100	0	Compliant
13451	59.13	45.56	74	-14.87	54	-8.44	V	100	0	Compliant
15372	60.56	47.31	74	-13.44	54	-6.69	V	100	0	Compliant
17294	52.29	40.04	74	-21.71	54	-13.96	V	100	0	Compliant
19215	59.67	39.67	74	-14.33	54	-14.33	V	100	0	Compliant

Mid Channel

Frequency (MHz)	Amplitude (dBµV/m)		Peak Limit	Peak Margin (dB)	Average Limit	Average Margin (dB)	Ant Pol	Ant Ht	TT Pos	Result
	Peak	Avg					H/V	cm	Deg	
3850	66.51	38.87	74	-7.49	54	-15.13	V	100	152	Compliant
5775	66.27	36.61	74	-7.73	54	-17.39	V	100	188	Compliant
7700	71.16	42.94	74	-2.84	54	-11.06	V	100	271	Compliant
9625	66.30	43.11	74	-7.70	54	-10.89	V	100	177	Compliant
11550	55.59	35.59	74	-18.41	54	-18.41	V	100	0	Compliant
13475	56.97	36.97	74	-17.03	54	-17.03	V	100	0	Compliant
15400	56.13	36.13	74	-17.87	54	-17.87	V	100	0	Compliant
17325	56.31	36.31	74	-17.69	54	-17.69	V	100	0	Compliant
19250	56.63	36.63	74	-17.37	54	-17.37	V	100	0	Compliant

High Channel

Frequency (MHz)	Amplitude (dBµV/m)		Peak Limit	Peak Margin (dB)	Average Limit	Average Margin (dB)	Ant Pol	Ant Ht	TT Pos	Result
	Peak	Avg					H/V	cm	Deg	
3857	66.90	39.06	74	-7.10	54	-14.94	V	100	154	Compliant
5785	66.48	40.01	74	-7.52	54	-13.99	V	100	189	Compliant
7714	71.44	43.20	74	-2.56	54	-10.80	V	100	271	Compliant
9642	66.20	42.93	74	-7.80	54	-11.07	V	100	177	Compliant
11571	55.19	35.19	74	-18.81	54	-18.81	V	100	0	Compliant
13499	56.65	36.65	74	-17.35	54	-17.35	V	100	0	Compliant
15428	56.18	36.18	74	-17.82	54	-17.82	V	100	0	Compliant
17356	55.83	35.83	74	-18.17	54	-18.17	V	104	0	Compliant
19284	56.69	36.69	74	-17.31	54	-17.31	V	100	0	Compliant

¹ Correction factors are included in measurement values

6. Measurement Data (continued)

6.6 Spurious Emissions for integral antennas (15.323 (d), 15.209, RSS-213 6.7.1) (cont)

Low Channel

Frequency (MHz)	Amplitude (dBµV/m)		Peak Limit	Peak Margin (dB)	Average Limit	Average Margin (dB)	Ant Pol	Ant Ht	TT Pos	Result
	Peak	Avg					H/V	cm	Deg	
3843	68.43	40.38	74	-5.57	54	-13.62	H	198	146	Compliant
5765	61.41	39.18	74	-12.59	54	-14.82	H	190	166	Compliant
7686	66.18	41.85	74	-7.82	54	-12.15	H	153	357	Compliant
9608	64.15	43.55	74	-9.85	54	-10.45	H	155	144	Compliant
11529	57.80	43.79	74	-16.20	54	-10.21	H	100	0	Compliant
13451	59.89	46.57	74	-14.11	54	-7.43	H	100	0	Compliant
15372	62.44	48.29	74	-11.56	54	-5.71	H	100	0	Compliant
17294	55.59	41.75	74	-18.41	54	-12.25	H	100	0	Compliant
19215	56.49	36.49	74	-17.51	54	-17.51	H	100	0	Compliant

Mid Channel

Frequency (MHz)	Amplitude (dBµV/m)		Peak Limit	Peak Margin (dB)	Average Limit	Average Margin (dB)	Ant Pol	Ant Ht	TT Pos	Result
	Peak	Avg					H/V	cm	Deg	
3850	67.70	39.47	74	-6.30	54	-14.53	H	183	155	Compliant
5775	58.33	38.42	74	-15.67	54	-15.58	H	183	311	Compliant
7700	63.30	40.91	74	-10.70	54	-13.09	H	180	151	Compliant
9625	62.96	43.01	74	-11.04	54	-10.99	H	163	149	Compliant
11550	57.17	43.27	74	-16.83	54	-10.73	H	100	0	Compliant
13475	56.61	36.61	74	-17.39	54	-17.39	H	100	0	Compliant
15400	56.59	36.59	74	-17.41	54	-17.41	H	100	0	Compliant
17325	55.29	35.29	74	-18.71	54	-18.71	H	100	0	Compliant
19250	56.18	36.18	74	-17.82	54	-17.82	H	100	0	Compliant

High Channel

Frequency (MHz)	Amplitude (dBµV/m)		Peak Limit	Peak Margin (dB)	Average Limit	Average Margin (dB)	Ant Pol	Ant Ht	TT Pos	Result
	Peak	Avg					H/V	cm	Deg	
3857	66.78	39.43	74	-7.22	54	-14.57	H	199	160	Compliant
5785	57.25	38.07	74	-16.75	54	-15.93	H	202	179	Compliant
7714	62.01	40.39	74	-11.99	54	-13.61	H	198	67	Compliant
9642	59.37	42.24	74	-14.63	54	-11.76	H	199	274	Compliant
11571	56.97	42.96	74	-17.03	54	-11.04	H	100	0	Compliant
13499	56.78	36.78	74	-17.22	54	-17.22	H	100	0	Compliant
15428	55.91	35.91	74	-18.09	54	-18.09	H	100	0	Compliant
17356	55.63	35.63	74	-18.37	54	-18.37	H	100	0	Compliant
19284	57.52	37.52	74	-16.48	54	-16.48	H	100	0	Compliant

¹ Correction factors are included in measurement values

6. Measurement Data

6.7. Power Spectral Density (15.319 (d)), RSS-213 Sec 6.6

Requirement: FCC: Power spectral density shall not exceed 3 milliwatts in any 3 kHz bandwidth as measured with a spectrum analyzer having a resolution bandwidth of 3 kHz.

IC: The peak-hold power spectral density shall not exceed 12 milliwatts per any 3 kHz bandwidth.

As an alternative to the peak-hold power spectral density, the time-averaged power spectral density may be measured and it shall not exceed 3 milliwatts per any 3 kHz bandwidth.

BB1 ANT 0 Channel	Channel Frequency	Actual Measured Frequency	Power Spectral Density	Limit	Limit	Result
	MHz	MHz	dBm / 3kHz	dBm / 3kHz	mW / 3kHz	
TX4	1921.536	1921.533	-1.280	4.77	3.00	Compliant
TX2	1924.992	1924.989	-1.590	4.77	3.00	Compliant
TX0	1928.448	1928.442	-1.760	4.77	3.00	Compliant

BB2 ANT 1 Channel	Channel Frequency	Actual Measured Frequency	Power Spectral Density	Limit	Limit	Result
	MHz	MHz	dBm / 3kHz	dBm / 3kHz	mW / 3kHz	
TX4	1921.536	1921.533	-1.680	4.77	3.00	Compliant
TX2	1924.992	1924.989	-1.860	4.77	3.00	Compliant
TX0	1928.448	1928.445	-0.890	4.77	3.00	Compliant

6. Measurement Data

6.7. Power Spectral Density (15.319 (d)), RSS-213 Sec 6.6 (cont)

6.7.1 Low Channel PSD – BB1



Date: 3.MAR.2014 15:45:03

6.7.2 Mid Channel PSD – BB1



Date: 3.MAR.2014 15:43:19

6. Measurement Data

6.7. Power Spectral Density (15.319 (d)), RSS-213 Sec 6.6 (cont)

6.7.3 High Channel PSD – BB1



Date: 3.MAR.2014 15:41:29

6.7.4 Low Channel PSD – BB2



Date: 3.MAR.2014 15:46:40

6. Measurement Data

6.7. Power Spectral Density (15.319 (d)), RSS-213 Sec 6.6 (cont)

6.7.5 Mid Channel PSD – BB2



6.7.6 High Channel PSD – BB2



6. Measurement Data

6.8. Conducted Emissions FCC Part 15.315, 15.207, IC RSS-213 6.3, RSS-GEN

Frequency Range (MHz)	Limits (dBµV)	
	Quasi-Peak	Average
0.15 to 0.50	66 to 56*	56 to 46*
0.50 to 5.0	56	46
5.0 to 30.0	60	50

* Decreases with the logarithm of the frequency.

6.8.1. Measurement Equipment Used to Perform Test

Device	Manufacturer	Model No.	Serial No.	Cal Due	Cal Interval
LISN	EMCO	3825/2	9109-1860	6/6/2014	1 yr
EMI Receiver	Hewlett Packard	8546A	3330A00115	6/8/2014	2 yr
Manufacturer	Software Description	Title/Model #		Rev.	
Compliance Worldwide	Test Report Generation Software	Test Report Generator		1.0	

6.8.2. Measurement & Equipment Setup

Test Date: 01/31/2014
 Test Engineer: Cody Merry
 Site Temperature (°C): 22.5
 Relative Humidity (%RH): 25
 Frequency Range: 0.15 MHz to 30 MHz
 EMI Receiver IF Bandwidth: 9 kHz
 EMI Receiver Avg Bandwidth: 30 kHz
 Detector Functions: Peak, Quasi-Peak & Average

6.8.3. Test Procedure

Test measurements were made in accordance with ANSI C63.4-2003, Standard Methods of Measurement of Radio Noise Emissions from Low-Voltage Electrical and Electronics Equipment in the Range of 9 kHz to 40 GHz.

6. Measurement Data

6.8. Conducted Emissions FCC Part 15.315, 15.207, IC RSS-213 6.3, RSS-GEN (cont)

6.8.4. 120 Volts, 60 Hz Phase

Test No.: 151-14, 120 Volts, 60 Hz Phase

EN55022, Class B

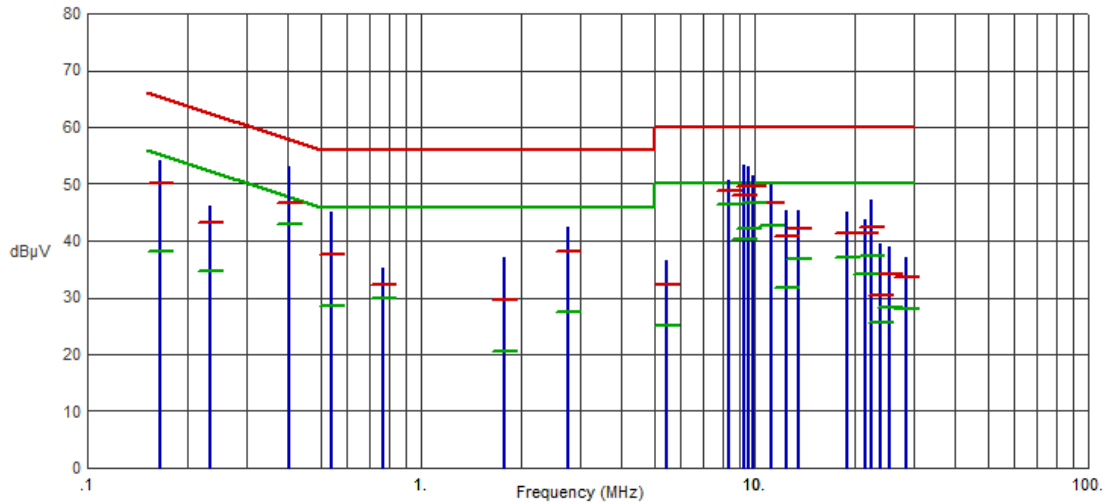

Frequency (MHz)	Pk Amp (dBµV)	QP Amp (dBµV)	QP Limit (dBµV)	QP Margin (dB)	Avg Amp (dBµV)	Avg Limit (dBµV)	Avg Margin (dB)	Comments
.1661	54.14	50.15	65.15	-15.00	38.18	55.15	-16.97	
.2337	46.25	43.08	62.32	-19.24	34.60	52.32	-17.72	
.4016	53.08	46.74	57.82	-11.08	43.04	47.82	-4.78	
.5395	45.18	37.47	56.00	-18.53	28.60	46.00	-17.40	
.7696	35.31	32.20	56.00	-23.80	29.97	46.00	-16.03	
1.7721	37.12	29.73	56.00	-26.27	20.60	46.00	-25.40	
2.7536	42.30	38.23	56.00	-17.77	27.42	46.00	-18.58	
5.4722	36.46	32.31	60.00	-27.69	25.20	50.00	-24.80	
8.3398	50.64	48.67	60.00	-11.33	46.28	50.00	-3.72	
9.3148	53.29	48.07	60.00	-11.93	40.21	50.00	-9.79	
9.6188	52.97	49.52	60.00	-10.48	42.17	50.00	-7.83	
9.9438	51.44	49.51	60.00	-10.49	46.67	50.00	-3.33	
11.2250	49.97	46.65	60.00	-13.35	42.56	50.00	-7.44	
12.4975	45.29	40.89	60.00	-19.11	31.64	50.00	-18.36	
13.4787	45.39	42.13	60.00	-17.87	36.90	50.00	-13.10	
18.9148	45.11	41.46	60.00	-18.54	37.07	50.00	-12.93	
21.4708	43.68	41.29	60.00	-18.71	34.22	50.00	-15.78	
22.4585	47.17	42.51	60.00	-17.49	37.25	50.00	-12.75	
23.7727	39.34	30.51	60.00	-29.49	25.52	50.00	-24.48	
25.3612	38.90	34.01	60.00	-25.99	28.36	50.00	-21.64	
28.5616	37.06	33.73	60.00	-26.27	28.03	50.00	-21.97	

6. Measurement Data

6.8. Conducted Emissions FCC Part 15.315, 15.207, IC RSS-213 6.3, RSS-GEN (cont)
6.8.5. 120 Volts, 60 Hz Neutral

Test No.: 151-14, 120 Volts, 60 Hz Neutral

EN55022, Class B

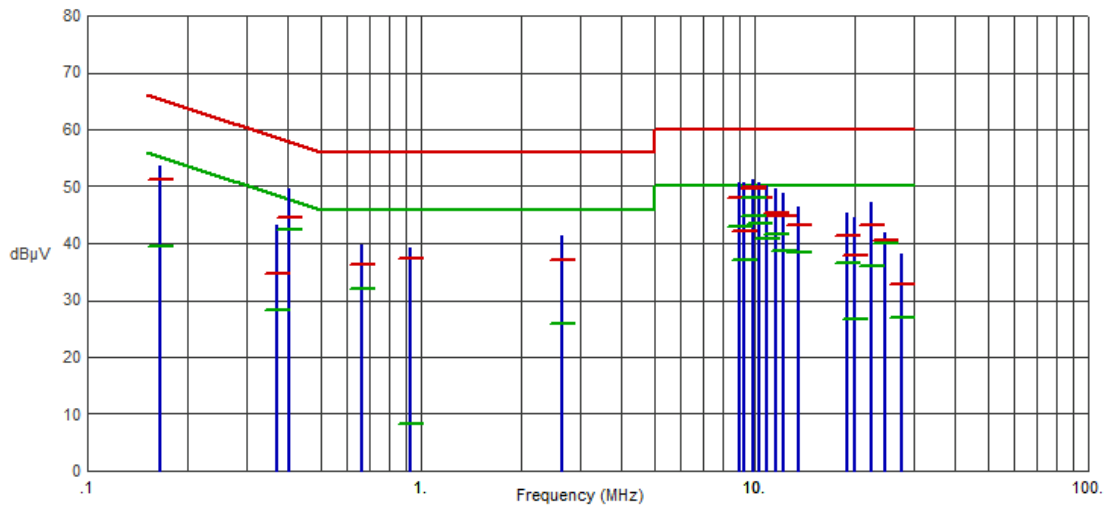

Frequency (MHz)	Pk Amp (dBµV)	QP Amp (dBµV)	QP Limit (dBµV)	QP Margin (dB)	Avg Amp (dBµV)	Avg Limit (dBµV)	Avg Margin (dB)	Comments
.1655	53.56	51.28	65.18	-13.90	39.42	55.18	-15.76	
.3714	43.15	34.57	58.47	-23.90	28.39	48.47	-20.08	
.4017	49.69	44.48	57.82	-13.34	42.51	47.82	-5.31	
.6672	39.63	36.38	56.00	-19.62	32.09	46.00	-13.91	
.9336	39.11	37.25	56.00	-18.75	8.25	46.00	-37.75	
2.6541	41.41	37.07	56.00	-18.93	25.84	46.00	-20.16	
8.9885	50.63	47.91	60.00	-12.09	42.84	50.00	-7.16	
9.3197	50.67	42.05	60.00	-17.95	37.15	50.00	-12.85	
9.9465	51.27	49.71	60.00	-10.29	44.79	50.00	-5.21	
9.9478	51.21	49.74	60.00	-10.26	47.87	50.00	-2.13	
10.2717	50.59	47.93	60.00	-12.07	43.59	50.00	-6.41	
10.9137	50.25	44.90	60.00	-15.10	40.70	50.00	-9.30	
11.5546	49.57	45.23	60.00	-14.77	41.51	50.00	-8.49	
12.1963	48.77	44.87	60.00	-15.13	38.55	50.00	-11.45	
13.4799	46.28	43.29	60.00	-16.71	38.35	50.00	-11.65	
18.9189	45.43	41.25	60.00	-18.75	36.61	50.00	-13.39	
19.9193	44.56	37.97	60.00	-22.03	26.58	50.00	-23.42	
22.4545	47.21	43.09	60.00	-16.91	35.99	50.00	-14.01	
24.5757	41.89	40.61	60.00	-19.39	39.92	50.00	-10.08	
27.6072	38.23	32.77	60.00	-27.23	26.91	50.00	-23.09	

6. Measurement Data (continued)

6.9 Frequency Stability (15.323 (f)), IC RSS-213 6.2)

Requirement: The frequency stability of the carrier frequency of the intentional radiator shall be maintained within 10 ppm over 1 hour or the interval between channel access monitoring, whichever is shorter. This translates to a frequency drift of 19.2 kHz for a 1920 MHz carrier.

The frequency stability shall be maintained over a temperature variation of -20° to +50 °C at normal supply voltage, and over a variation in the primary supply voltage of 85 percent to 115 percent of the rated supply voltage at a temperature of 20 °C.

Channel	Channel Frequency	Voltage	Temperature	Measured Frequency Offset	Limit (+/-)	Limit (+/-)	Result
	MHz	VDC	Degrees C	kHz	kHz	ppm	
TX0	1928.448	48.00	20	3.0	19.2	10.0	Compliant
TX0	1928.448	40.80	20	3.0	19.2	10.0	Compliant
TX0	1928.448	55.20	20	3.0	19.2	10.0	Compliant
TX0	1928.448	48.00	-20	6.0	19.2	10.0	Compliant
TX0	1928.448	48.00	+50	6.0	19.2	10.0	Compliant

6.9.1 Timing 48 VDC, 20 degrees C

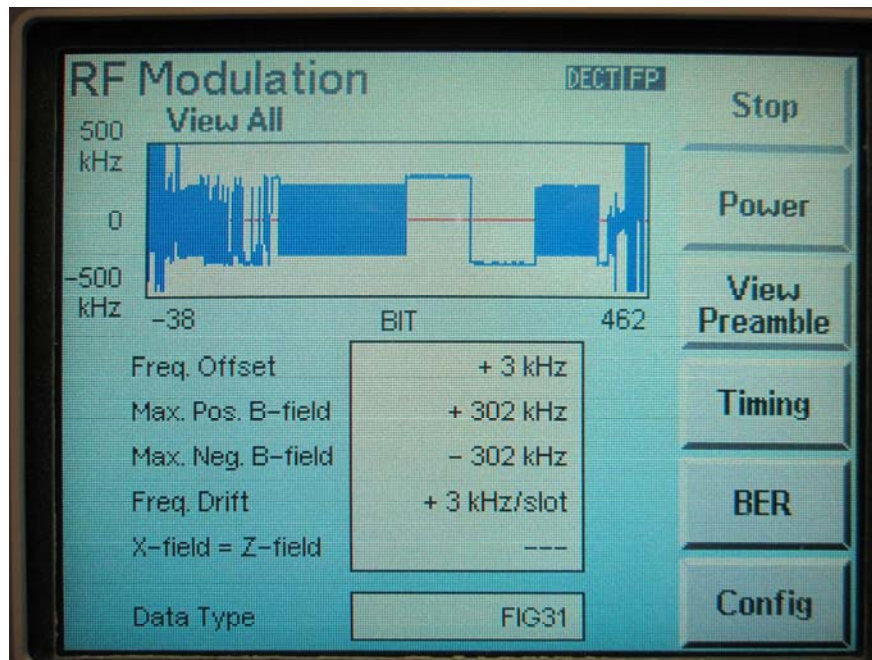

6. Measurement Data (continued)

6.10 Transmitter Spurious Radiated Emissions (FCC Part 15.209, RSS 213 6.8)

6.10.1. Regulatory Limit: FCC Part 15, IC RSS-GEN, Class B, Quasi-Peak

Frequency Range (MHz)	Distance (Meters)	Limit (dBµV/m)
0.009 to 0.490	3	128.5 to 93.8
0.490 to 1.705	3	73.8 to 63.0
1.705 to 30	3	69.5
30 to 88	3	40.0
88 to 216	3	43.5
216 to 960	3	46.0
960 to 1000	3	54.0

6.10.2. Measurement Equipment Used to Perform Test

Device	Manufacturer	Model No.	Serial No.	Cal Due	Cal Interval
Loop Antenna	EMCO	6512	9309-1139	8/28/2014	2 yr
Biconilog Antenna	Sunol Sciences	JB1	A050913	5/15/2014	1 yr
EMI Receiver	Hewlett Packard	8546A	3330A00115	6/13/2014	2 yr

6.10.3. Measurement & Equipment Setup

Test Date: 1/31/2014
 Test Engineer: Cody Merry
 Site Temperature (°C): 25
 Relative Humidity (%RH): 33
 Frequency Range: 150 kHz to 1 GHz
 Measurement Distance: 3 Meters
 EMI Receiver IF Bandwidth: 9 kHz, 120 kHz
 EMI Receiver Avg Bandwidth: 30 kHz, 300 kHz
 Detector Functions: Peak and Quasi-Peak.
 Antenna Height: 1 to 4 meters

6.10.4. Test Procedure

Test measurements were made in accordance with ANSI C63.4-2003, Standard Methods of Measurement of Radio Noise Emissions from Low-Voltage Electrical and Electronics Equipment in the Range of 9 kHz to 40 GHz.

6. Measurement Data (continued)

6.10. Radiated Emissions (150 kHz to 30 MHz) Test Results

6.10.5. Antenna Parallel to the Device Under Test

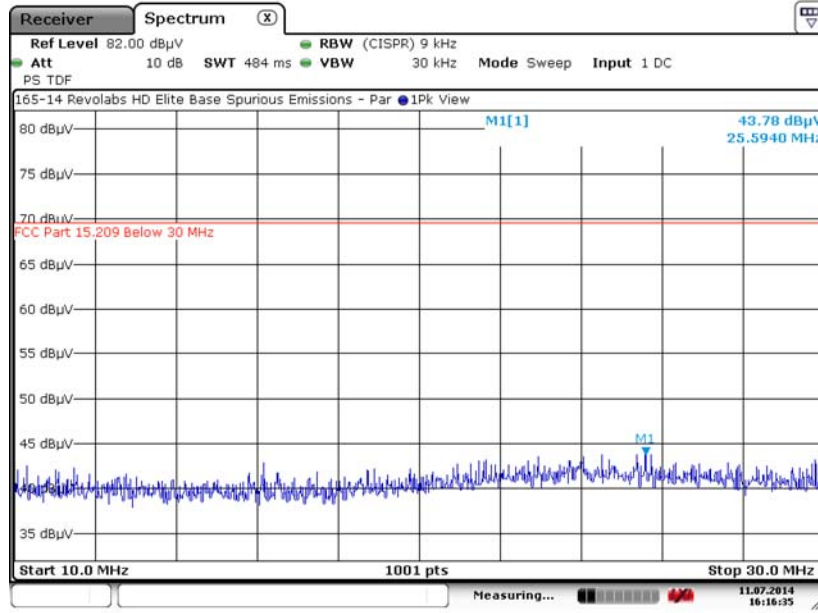

Date: 11.JUL.2014 16:16:36

6.10.6. Antenna Perpendicular to the Device Under Test

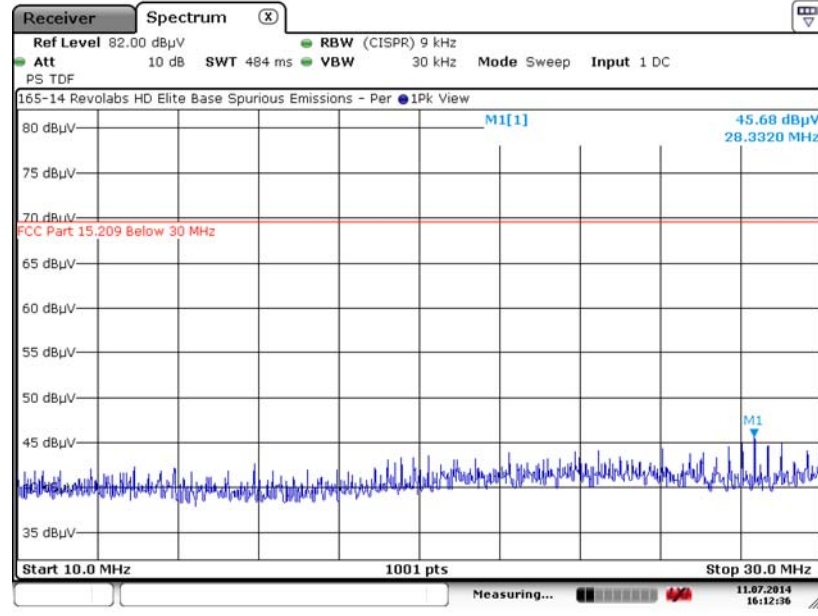

Date: 11.JUL.2014 16:12:37

6. Measurement Data (continued)

6.10. Radiated Emissions (30 MHz to 1 GHz) Test Results

6.10.7. Horizontal Polarity

Test No.: 165-14, Radiated Emissions - Horizontal Polarity

FCC, Class B

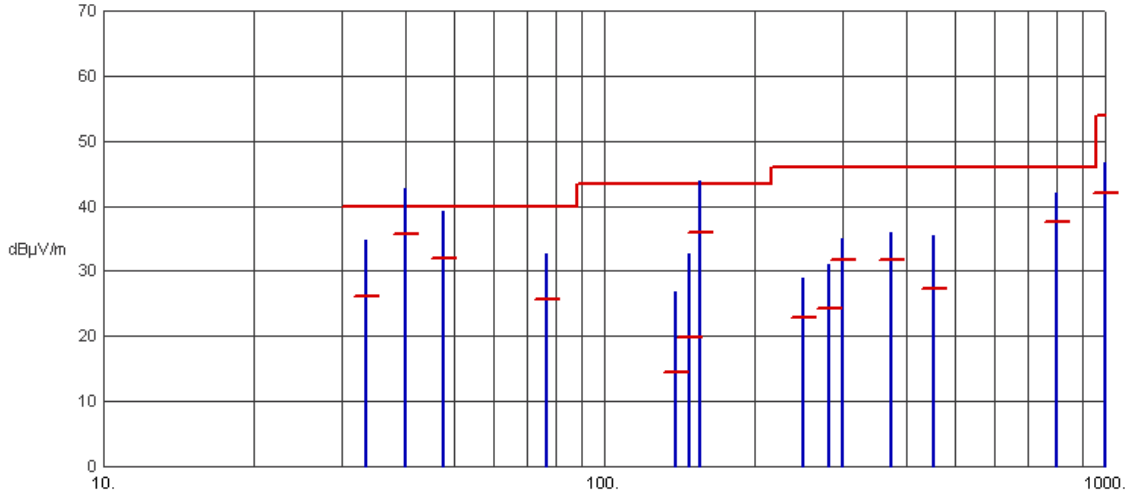

Frequency (MHz)	Pk Amp (dBµV/m)	QP Amp (dBµV/m)	QP Limit (dBµV/m)	Margin (dB)	Ant Ht (cm)	Table (Deg)	Comments
33.4196	34.71	26.14	40.00	-13.86	N/A	N/A	
40.0438	42.69	35.67	40.00	-4.33	N/A	N/A	
47.7858	39.30	31.89	40.00	-8.11	N/A	N/A	
76.5252	32.59	25.75	40.00	-14.25	N/A	N/A	
138.3733	26.81	14.57	43.50	-28.93	N/A	N/A	
148.1039	32.70	19.72	43.50	-23.78	N/A	N/A	
154.9476	43.84	35.82	43.50	-7.68	N/A	N/A	
249.9860	28.93	22.76	46.00	-23.24	N/A	N/A	
280.5068	30.98	24.16	46.00	-21.84	N/A	N/A	
299.9687	35.00	31.80	46.00	-14.20	N/A	N/A	
374.9834	35.83	31.81	46.00	-14.19	N/A	N/A	
455.9716	35.55	27.24	46.00	-18.76	N/A	N/A	
799.9642	42.06	37.61	46.00	-8.39	N/A	N/A	
999.0022	46.72	41.91	54.00	-12.09	N/A	N/A	

6. Measurement Data (continued)

6.10 Radiated Emissions (30 MHz to 1 GHz) Test Results (continued)

6.10.8. Vertical Polarity

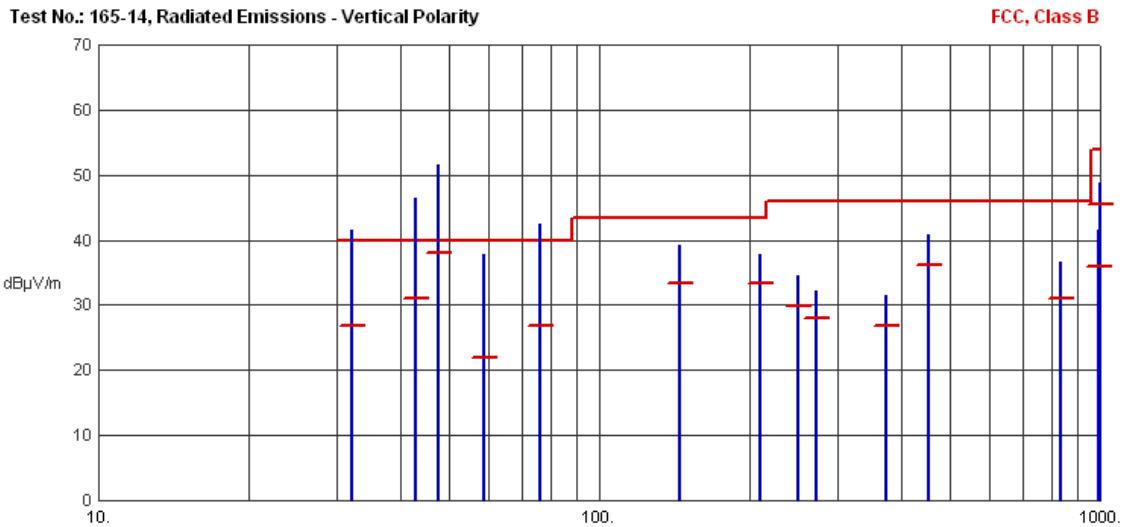

Frequency (MHz)	Pk Amp (dBµV/m)	QP Amp (dBµV/m)	QP Limit (dBµV/m)	Margin (dB)	Ant Ht (cm)	Table (Deg)	Comments
32.0301	41.46	26.75	40.00	-13.25	N/A	N/A	
42.9496	46.33	31.02	40.00	-8.98	N/A	N/A	
47.7747	51.64	37.93	40.00	-2.07	N/A	N/A	
58.7023	37.85	21.88	40.00	-18.12	N/A	N/A	
75.9401	42.38	26.93	40.00	-13.07	N/A	N/A	
145.2454	39.11	33.40	43.50	-10.10	N/A	N/A	
208.8712	37.81	33.28	43.50	-10.22	N/A	N/A	
249.9770	34.49	29.86	46.00	-16.14	N/A	N/A	
270.3331	32.12	28.00	46.00	-18.00	N/A	N/A	
374.9903	31.53	26.72	46.00	-19.28	N/A	N/A	
455.9888	40.77	36.17	46.00	-9.83	N/A	N/A	
834.7274	36.64	31.14	46.00	-14.86	N/A	N/A	
993.6314	41.48	36.00	54.00	-18.00	N/A	N/A	
999.9976	48.82	45.55	54.00	-8.45	N/A	N/A	

6.10.9. Above 1 GHz

Note: There were not measurable emissions above 1 GHz other than the harmonics documented in Section 6.6.

6. Measurement Data (continued)

6.11 Specific Requirements to UPCS Devices (15.323 (e), RSS-213 4.3.4 (c), ANSI C63.17 Section 6.2.2 Frame Repetition-Stability and ANSI C63.17 Section 6.2.3 Frame Period and Jitter)

Requirement: The frame period (a set of consecutive time slots in which the position of each time slot can be identified by reference to a synchronizing source) of an intentional radiator operating in this sub-band shall be 20 milliseconds/X where X is a positive whole number.

Each device that implements time division for the purpose of maintaining a duplex connection on a given frequency carrier shall maintain a frame repetition rate with a frequency stability of at least 50 parts per millions (ppm). Each device which further divides access in time in order to support multiple communication links on a given frequency carrier shall maintain a frame repetition rate with a frequency stability of at least 10 ppm.

The jitter (time-related, abrupt, spurious variations in the duration of the frame interval) introduced at the two ends of such a communication link shall not exceed 25 microseconds for any two consecutive transmissions.

The Frame Repetition Stability which is measured is 3 times the standard deviation.

Test Equipment Setup: EUT is connected to the CTS65 test set using a special operational mode of the EUT (TBR6 mode) on one of the channels (frequencies). The CTS65 test set serves as the companion device for the EUT. The Timing function of the test set is used for this measurement. The test set is configured to perform the measurement over 1000 bursts. The data is captured approximately once every 10 seconds via the laptop for 1000 seconds.

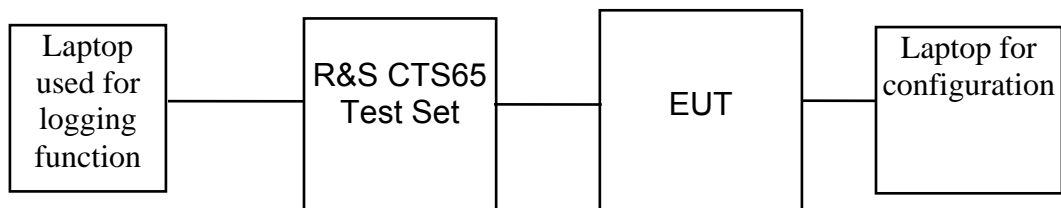

6. Measurement Data (continued)

6.11 Specific Requirements to UPCS Devices (15.323 (e), RSS-213 4.3.4 (c), ANSI C63.17 Section 6.2.2 Frame Repetition-Stability and ANSI C63.17 Section 6.2.3 Frame Period and Jitter) (cont)

Frame Repetition Stability (ppm)	Limit (ppm)	Standard Deviation (ppm)	Result
0.98	± 10.00	0.33	Compliant

Maximum Positive Jitter (µS)	Maximum Negative Jitter (µS)	Frame Period (mS)	3xStandard Deviation of Jitter (µS)	Maximum Jitter Limit	Result
0.00	-0.00	10.000	0.000	25 µS	Compliant

6.11.1 Time Accuracy & Maximum Jitter (cont)

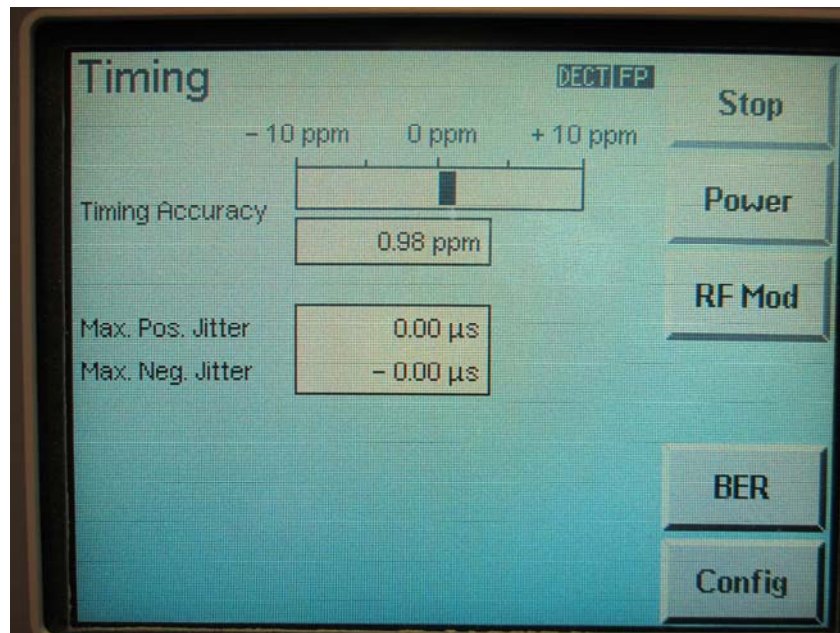

Note: The tester is configured for 1000 bursts of analysis (its maximum) and then monitored for a minimum of 1000 seconds recording the maximum and minimum values of jitter to satisfy the measurement requirement over 100,000 frames.

6. Measurement Data (continued)

6.11 Specific Requirements to UPCS Devices (15.323 (e), RSS-213 4.3.4) (cont)

6.11.2 Automatic Discontinuation of Transmission (15.319(f), RSS-213 4.3.4 (a))

Requirement: Devices shall automatically discontinue transmission in case of either absence of information to transmit or operational failure. This is not intended to preclude transmission of control and signaling information or use of repetitive codes used by certain digital technologies to complete frame or burst intervals.

Result: Compliant

Evaluation	Result
Test according to a)	Compliant
Assessment of manufacturer declaration	-- --

a) The tests are done after establishment of a connection to counterpart.

	Test case	Reaction of EUT	Result
1	Switch – off counterpart	B	Compliant
2	Hook-on by counterpart	--	--
3	Switch- off by EUT	A	Compliant
4	Hook -on on EUT side	--	--
5	Remove power from EUT	A	Compliant
6	Remove power from counterpart	B	Compliant

A – Connection break down, cease of transmit

B – Connection break down, EUT transmits signaling information

C – Connection break down, counterpart transmits signaling information

6. Measurement Data (continued)

6.11 Specific Requirements to UPCS Devices (cont)

6.11.3 Monitoring Time (15.323(c) (1), RSS-213 4.3.4 (b) (1))

Requirement: Devices must incorporate a mechanism for monitoring the time and spectrum windows that their transmission is intended to occupy. The following criteria must be met:

Immediately prior to initiating a transmission, devices must monitor the combined time and spectrum window, which they intend to use, to verify if the channel is free, for at least 10 milliseconds for systems designed to use a 10 ms or shorter frame period, or at least 20 ms for systems designed to use a 20 ms frame period.

6.11.3.1 Measurement of Frame Period

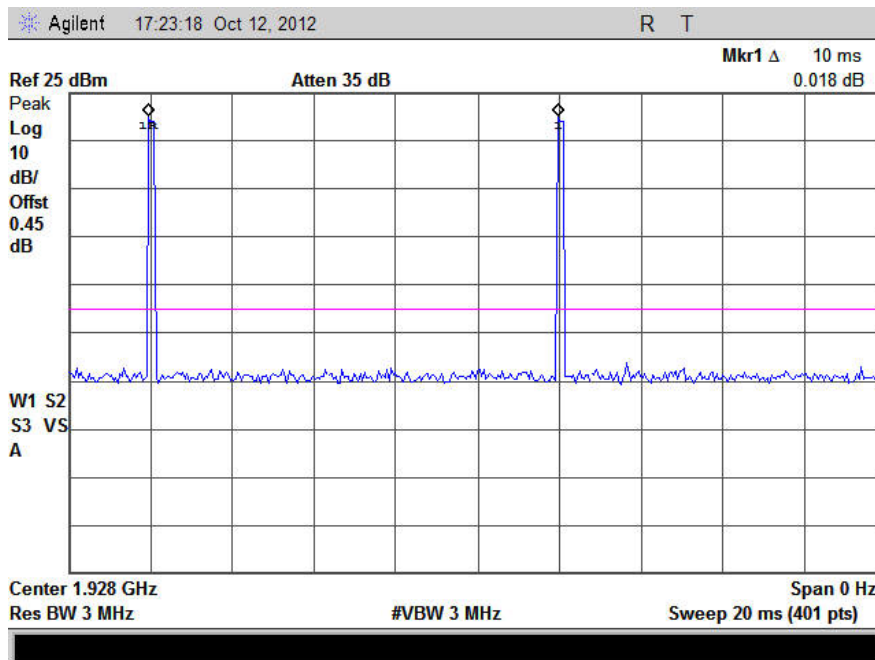

Result: Compliant, plot is used to demonstrate this is a 10 mS or shorter system. This requirement is covered by the results of the LIC test.

6. Measurement Data (continued)

6.11 Specific Requirements to UPCS Devices (cont)

6.11.3 Monitoring Time (15.323(c) (1), RSS-213 4.3.4 (b) (1) (cont)

6.11.3.2 Measurement of Nominal Burst Length (Frame Width)

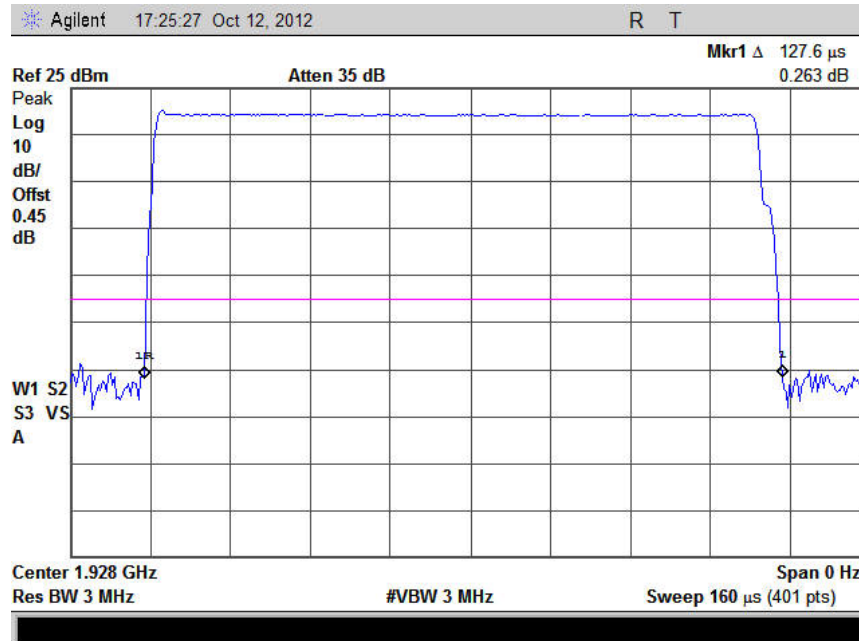

Result: Compliant, plot is for reference only, requirement covered via the LIC tests.

6. Measurement Data (continued)**6.11 Specific Requirements to UPCS Devices (cont)****6.11.4 Lower Monitoring Threshold (15.323(c) (2), RSS-213 4.3.4 (b) (2))**

Requirement: The monitoring threshold must not be more than 30 dB above the thermal noise power (KTB) of a bandwidth equivalent to the emission bandwidth used by the device.

For EUTs which support least interfered channel procedure (LIC), it is not necessary to measure the lower threshold under rule parts 15.323 (c) (2) and 4.3.4 (b) (2).

These are automatically met by the LIC procedure in clauses 15.323 (c) (5) and 4.3.4 (b) (5).

Result: Compliant, requirement covered via the LIC tests.

The EUT implements 5 channels as shown on page 4 of the test report. Each channel is made up of 12 timeslots for the Fixed Part (EUT) and 12 timeslots for the portable part (microphones) as documented in the manufacturers declaration. Therefore the EUT uses 60 TDMA Duplex Channels and meets the requirement via the LIC tests.

6. Measurement Data (continued)**6.11 Specific Requirements to UPCS Devices (cont)****6.11.5 Maximum Transmit Period (15.323(c) (3), RSS-213 4.3.4 (b) (3))**

Requirement: If no signal above the threshold level is detected, transmission may commence and continue with the same bandwidth in the monitored time and spectrum windows without further monitoring. However, occupation of the same combined time and spectrum windows by a device or group of cooperating devices, continuously over a period of time longer than 8 hours is not permitted without repeating the access criteria.

Requirement	Time	Limit	Result
Maximum Transmission Time 8.2.2	< 8 Hours	8 Hours	Compliant

Result: Compliant

6. Measurement Data (continued)

6.11 Specific Requirements to UPCS Devices (cont)

6.11.6 System Acknowledgement (15.323(c) (4), RSS-213 4.3.4 (b) (4)

Requirement: Once access to specific combined time and spectrum windows is obtained, an acknowledgement from a system participant must be received by the initiating transmitter within one second or transmission must cease. Periodic acknowledgements must be received at least every 30 seconds or transmission must cease. Channels used exclusively for control and signaling information may transmit continuously for 30 seconds without receiving an acknowledgement, at which time the access criteria must be repeated.

Connection acknowledgements are tested according to ANSI 63.17-2006 subclause 8.2.1. Unacknowledged transmission following sub clause 8.1.1.

Access criteria test interval and 8.1.2 Access criteria functional test. subclause 8.1.3 Access criteria functional test is not applicable because option FCC 15.323 (c)(6) / RSS-213 4.3.4 (b)(6) is not implemented.

Requirement	Time	Limit	Result
Access Criteria test interval 8.1.1	28 s	<=30 secs	Compliant

Result: Compliant, the test was repeated 5 times and the worst case time is documented.

6. Measurement Data (continued)

6.11 Specific Requirements to UPCS Devices (cont)

6.11.7 Least Interfered Channel (LIC) Selection (15.323(c) (5))

Requirement: If access to spectrum is not available as determined by the above, and a minimum of 20 duplex system access channels are defined for the system, the time and spectrum windows with the lowest power level may be accessed.

A device utilizing the provisions of this paragraph (5) must have monitored all access channels defined for its system within the last 10 seconds and must verify, within the 20 milliseconds (40 milliseconds for devices designed to use a 20 millisecond frame period) immediately preceding actual channel access, that the detected power of the selected time and spectrum windows is no higher than the previously detected value.

The power measurement resolution bandwidth for this comparison must be accurate to within 6 dB.

No device or group of cooperating devices located within 1 meter of each other shall during any frame period occupy more than 6 MHz of aggregate bandwidth, or alternatively, more than one third of the time and spectrum windows defined by the system.

Result: Compliant, the maximum number of wireless microphones that is used with a base is one. Up to two bases could be daisy chained together and therefore they could be up to two devices co-located with 1 meter, although this is not realistic for proper operation. However, since each device occupies 1.45 MHz of spectrum the maximum that would ever occur is 2.9 MHz of aggregate bandwidth.

Upper Threshold: $TU \leq -174 + 10 \log_{10} B + Mu + Pmax - Peut$ (dBm)

B = Emission Bandwidth in Hz

P = Peak Transmit Power (dBm)

$Pmax = 5 \log_{10} B - 10$ dBm

Calculated Thresholds:

	dBm
TL: Lower Threshold	N/A
TU: Upper Threshold	-61.79

Limits:

Limits	
	$TLR < TL + UM = N/A + 6.0 = N/A$
	$TUR < TU + UM = -61.79 + 6.0 = -55.79$ dBm

6. Measurement Data (continued)

6.11 Specific Requirements to UPCS Devices (cont)

6.11.7 Least Interfered Channel (LIC) Selection (RSS-213 4.3.4 (b) (5))

Requirement: If access to spectrum is not available as determined by the above, and a minimum of 40 duplex system access channels are defined for the system, the time and spectrum windows with a power level below a monitoring threshold of 50 dB above the thermal noise power determined for the occupied bandwidth may be accessed.

A device utilizing the provisions of this paragraph (5) must have monitored all access channels defined for its system within the last 10 seconds and must verify, within the 20 milliseconds (40 milliseconds for devices designed to use a 20 millisecond frame period) immediately preceding actual channel access, that the detected power of the selected time and spectrum windows is no higher than the previously detected value.

The power measurement resolution bandwidth for this comparison must be accurate to within 6 dB.

No device or group of cooperating devices located within 1 meter of each other shall during any frame period occupy more than 6 MHz of aggregate bandwidth, or alternatively, more than one third of the time and spectrum windows defined by the system.

Result: Compliant, the maximum number of wireless microphones that is used with a base is one. Up to two bases could be daisy chained together and therefore they could be up to two devices co-located within 1 meter, although this is not realistic for proper operation. However, since each device occupies 1.45 MHz of spectrum the maximum that would ever occur is 2.9 MHz of aggregate bandwidth.

Upper Threshold: $TU \leq -174 + 10 \log_{10} B + Mu + Pmax - Peut$ (dBm)

B = Emission Bandwidth in Hz

P = Peak Transmit Power (dBm)

$Pmax = 5 \log_{10} B - 10$ dBm

Calculated Thresholds:

	dBm
TL: Lower Threshold	N/A
TU: Upper Threshold	-61.79

Limits:

Limits	$TUR < TU + UM = -61.79 + 6.0 = -55.79$ dBm
	$TLR < TL + UM = N/A + 6.0 = N/A$

6. Measurement Data (continued)

6.11 Specific Requirements to UPCS Devices (cont)

6.11.7 (LIC) Selection (15.323(c) (5), RSS-213 4.3.4 (b) (5) (cont)

6.11.7.1 Plot Showing Channel Move Function

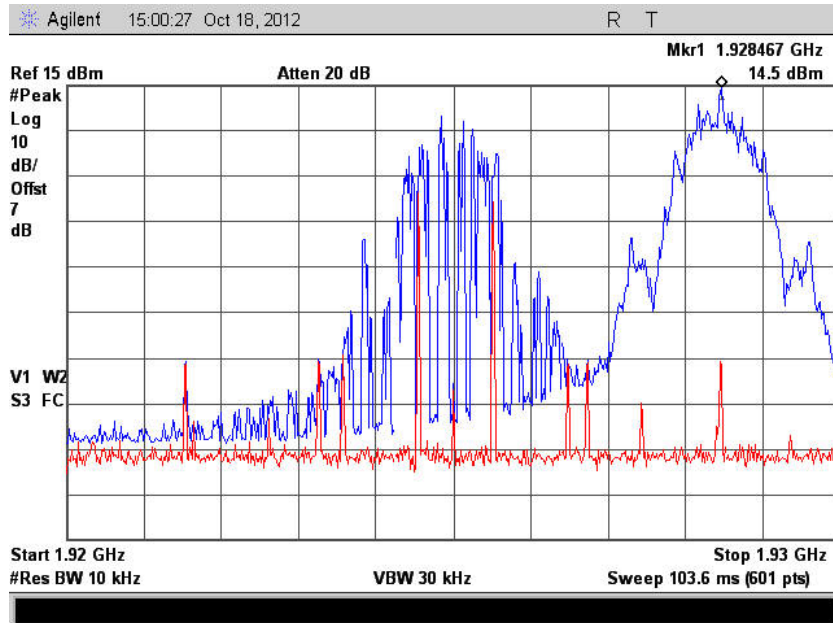

6.11.7.2 Channel Selection with TX2 - Mid Channel Low

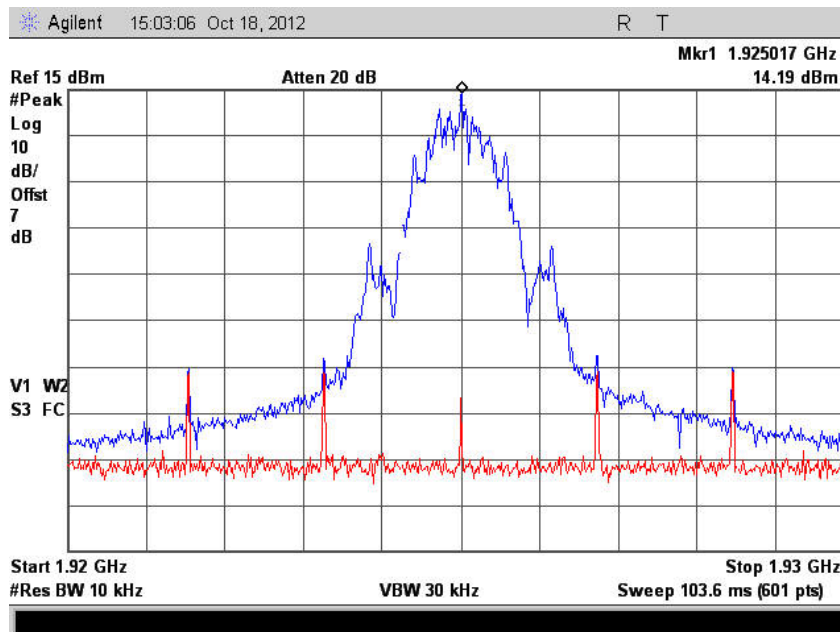

6. Measurement Data (continued)

6.11 Specific Requirements to UPCS Devices (cont)

6.11.7 (LIC) Selection (15.323(c) (5), RSS-213 4.3.4 (b) (5) (cont)

6.11.7.3 Channel Selection with Mid Channel Low, Low Channel Lower

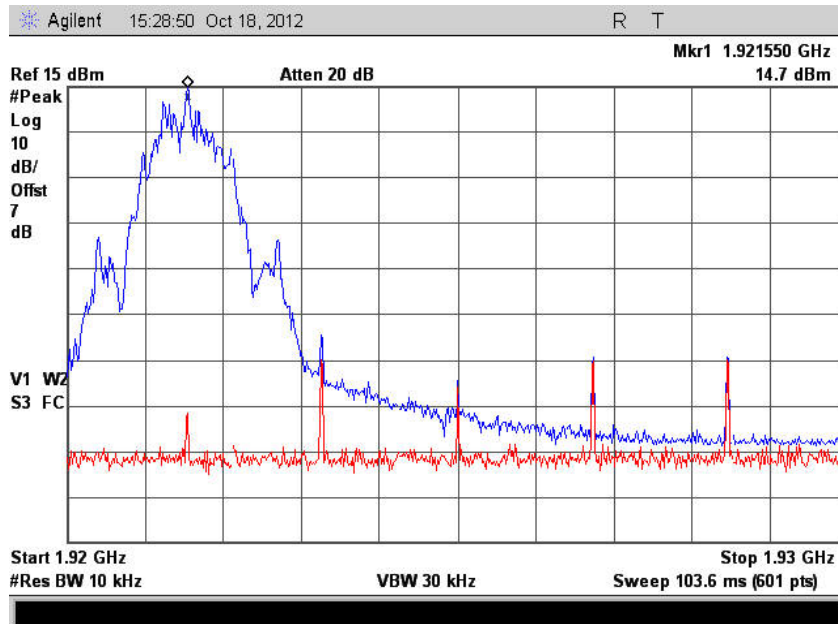

6.11.7.4 Channel Selection with TX1 Channel Low

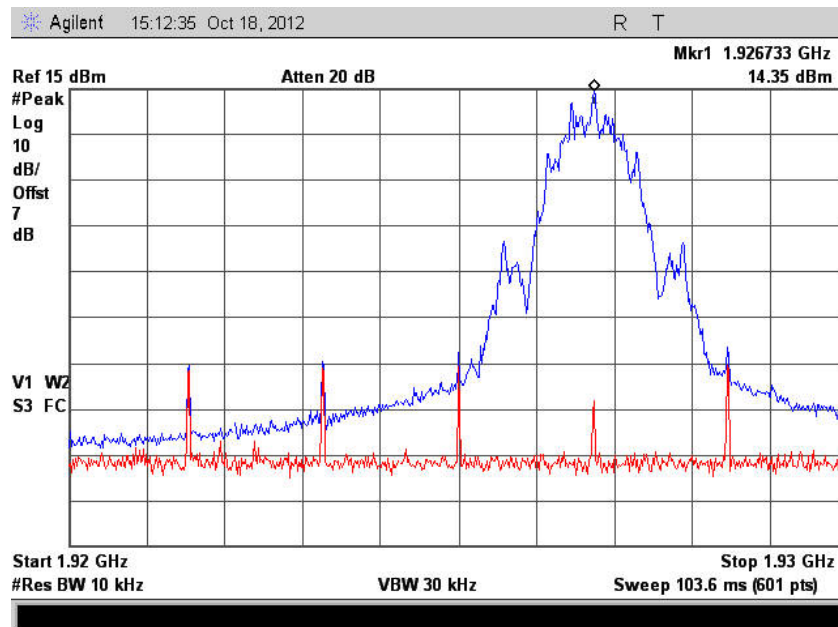

6. Measurement Data (continued)

6.11 Specific Requirements to UPCS Devices (cont)

6.11.7 (LIC) Selection (15.323(c) (5), RSS-213 4.3.4 (b) (5) (cont)

6.11.7.5 Channel Selection with TX3 Channel Low

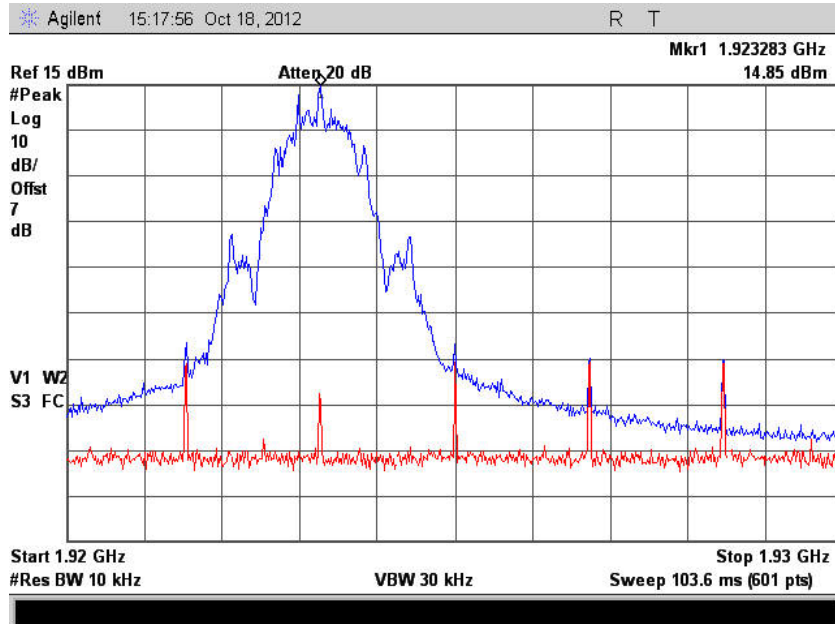

6.11.7.6 Channel Selection with TX0 Channel Low

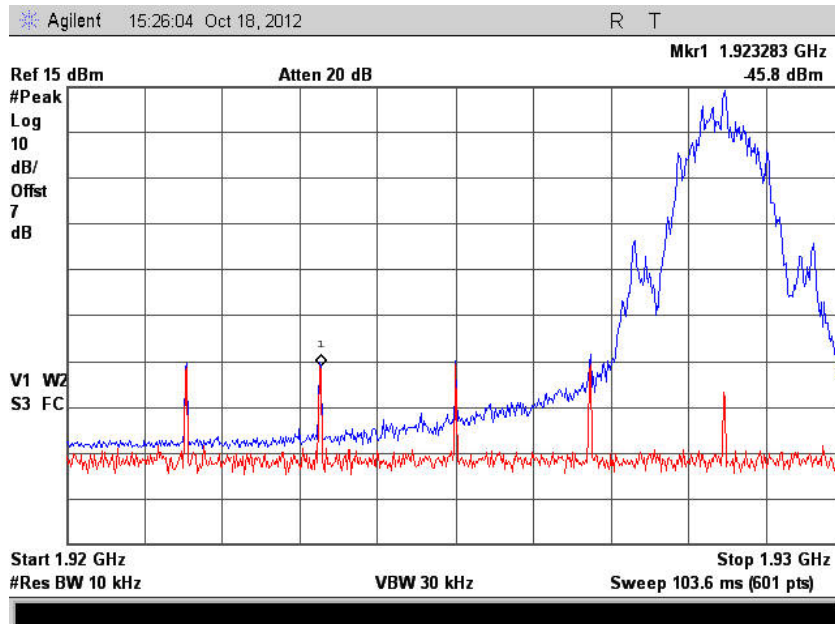

6. Measurement Data (continued)

6.11 Specific Requirements to UPCS Devices (cont)

6.11.7 (LIC) Selection (15.323(c) (5), RSS-213 4.3.4 (b) (5) (cont)

Requirement: By a multicarrier interference generator, apply to the EUT uniform CW interference on all system carriers each at level $TU + UM + 10$ dB. Lower the interference uniformly on all carriers until the EUT can transmit. If the EUT first transmits at a per-carrier interference level greater than $TU + UM$, the EUT fails the test.

TU = -61.79 dBm

UM = 6 dBm

TUR = -55.79 dBm

Result: Compliant the EUT starts transmitting at -57.01 dBm

6.11.7.7 LIC Upper Threshold Measurement

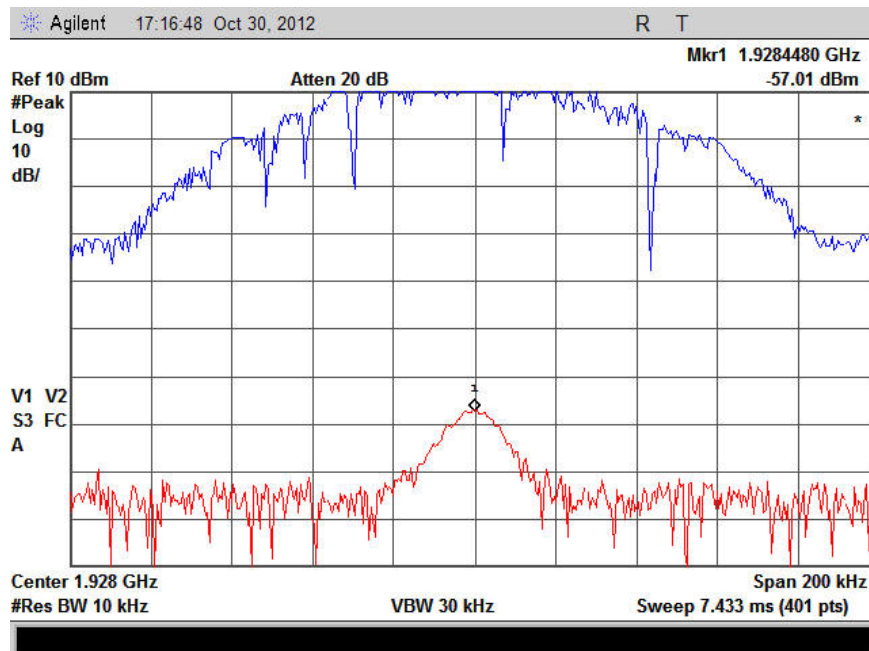

6. Measurement Data (continued)

6.11 Specific Requirements to UPCS Devices (cont)

6.11.8 Random waiting (15.323(c) (6), RSS-213 4.3.4 (b) (6))

Requirement: If the selected combined time and spectrum windows are unavailable, the device may either monitor and select different windows or seek to use the same windows after waiting an amount of time, randomly chosen from a uniform random distribution between 10 and 150 milliseconds, commencing from the time when the channel becomes available.

Result: Compliant, this feature is not implemented in the EUT.

6.11.9 Monitoring Bandwidth (15.323(c) (7), RSS-213 4.3.4 (b) (7))

Requirement: The monitoring system bandwidth must be equal to or greater than the occupied bandwidth of the intended transmission.

Note: Testing of the monitoring system bandwidth is not required if the designed bandwidth from the manufacturer is available and given in the test report.

The monitor shall have a maximum reaction time less than $50\sqrt{1.25 / \text{occupied bandwidth in MHz}}$ microseconds for signals at the applicable threshold level but shall not be required to be less than 50 microseconds.

If a signal is detected that is 6 dB or more above the threshold level, the maximum reaction time shall be $35\sqrt{1.25 / \text{occupied bandwidth in MHz}}$ microseconds but shall not be required to be less than 35 microseconds.

Pulse Width	Connection
50 μ S or 50 * SQRT (1.25/B) μ S	no
35 μ S or 35 * SQRT (1.25/B) μ S	no

Result: Compliant, the EUT does not connect in the presence of 35 μ S and/or 50 μ S pulses

6. Measurement Data (continued)**6.11 Specific Requirements to UPCS Devices (cont)****6.11.10 Monitoring Antenna (15.323(c) (8), RSS-213 4.3.4 (b) (8)**

Requirement: The monitoring system shall use the same antenna used for transmission, or an antenna that yields equivalent reception at that location.

Note: A monitoring antenna of the same model (and manufacturer) as the transmitting antenna is considered equivalent. An antenna not of the same model but of the same type (e.g. both are horn antennas of different manufacturers) is considered equivalent if the main beam antenna gains are within 3 dB of each other. Both antennas are to be installed to point at the same general coverage area.

Result: Compliant, the device uses the same antenna(s).

6.11.11 Monitoring Threshold Relaxation (15.323(c) (9), RSS-213 4.3.4 (b) (9)

Requirement: Devices that have a power output lower than the maximum permitted under this standard may increase their detection threshold by 1 dB for each 1 dB that the transmitter power is below the maximum permitted.

Result: Compliant, requirement is covered by LIC test in 15.323 (b)(5) / 4.3.4 (b)(5).

6.11.12 Duplex Connections (15.323(c) (10), RSS-213 4.3.4 (b) (10)

Requirement: A device initiating a communication (hereafter called an initiating device) may attempt to establish a duplex connection by monitoring both its intended transmit and receive time and spectrum windows. If both the intended transmit and receive time and spectrum windows meet the access criteria, then the initiating device can initiate a transmission in the intended transmit time and spectrum window. If the power detected by the responding device can be decoded as a duplex connection signal from the initiating device, then the responding device may immediately begin transmitting on the receive time and spectrum window monitored by the initiating device.

Result: Compliant, EUT does not support Duplex Connections.

6. Measurement Data (continued)**6.11 Specific Requirements to UPCS Devices (cont)****6.11.13 Alternative monitoring interval for co-located devices
(15.323(c) (11), RSS-213 4.3.4 (b) (11))**

Requirement: An initiating device that is prevented from monitoring during its intended transmit window due to monitoring system blocking from the transmissions of a co-located (within one meter) transmitter of the same system, may monitor the portions of the time and spectrum windows in which they intend to receive over a period of at least 10 milliseconds.

The monitored time and spectrum window must total at least 50 percent of the 10 millisecond frame interval and the monitored spectrum must be within 1.25 MHz of the centre frequency of channel(s) already occupied by that device or co-located co-operating devices.

If the access criteria is met for the intended receive time and spectrum window under the above conditions, then transmission in the intended transmit window by the initiating device may commence.

Result: Compliant, devices are not co-located within 1 meter.

6.11.14 Fair Access (15.323(c) (12), RSS-213 4.3.4 (b) (12))

Requirement: The provisions of Part 15.323 (c) (10) or (c) (11) and/or RSS-213 4.3.4 (b) (10) or (11) shall not be used to extend the range of spectrum occupied over space or time for the purpose of denying fair access to spectrum to other devices.

Result: Compliant, EUT does not operate in a mode that denies fair access.

6. Measurement Data (continued)

6.12. Public Exposure to Radio Frequency Energy Levels (1.1307 (b)(1))

RSS-GEN 5.5, RSS 102

6.12.1. MPE Power Density Table

Channel	MPE Distance (cm)	DUT Output Power (dBm)	DUT Antenna Gain (dBi)	Power Density		Limit (mW/cm ²)	Result
				(mW/cm ²)	(W/m ²)		
	(1)	(2)	(3)	(4)		(5)	
TX4	20	19.93	2.19	0.032	0.324	1	Compliant
TX2	20	20.01	2.35	0.034	0.343	1	Compliant
TX0	20	20.16	2.22	0.034	0.344	1	Compliant
TX4	20	19.76	-0.81	0.016	0.156	1	Compliant
TX2	20	19.76	-0.36	0.017	0.173	1	Compliant
TX0	20	19.79	0.08	0.019	0.193	1	Compliant

$$PD = \frac{OP + AG}{(4 \times \pi \times d^2)}$$

PD = Power Density

OP = DUT Output Power (dBm)

AG = Antenna Gain (dBi)

D = MPE Distance

- Reference CFR 2.1093(b): For purposes of this section, a portable device is defined as a transmitting device designed to be used so that the radiating structure(s) of the device is/are within 20 centimeters of the body of the user.
- Section 6.3 of this test report.
- Data supplied by the client.
- Power density is calculated from conducted power output measurement and antenna gain.
- Reference CFR 1.1310, Table 1: Limits for Maximum Permissible Exposure (MPE), Section (B): Limits for General Population/Uncontrolled Exposure.

6. Measurement Data (continued)

6.12. Public Exposure to Radio Frequency Energy Levels (1.1307 (b)(1))

RSS-GEN 5.5, RSS 102 (cont.)

6.12.2. MPE Time Averaged Power Table

Channel	Frequency	DUT Output Power	DUT Antenna Gain	Calculated Output Power	Time Averaged Power	Limit	Result	Time Averaged Power	Time Reduction Factor
	(MHz)	(dBm)	(dBi)	(mW)	(mW)	(mW)		dBm	dB
TX4	1921.536	19.93	2.19	162.93	2.08	100.00	Compliant	3.18	-18.94
TX2	1924.992	20.01	2.35	172.19	2.20	100.00	Compliant	3.42	-18.94
TX0	1928.448	20.16	2.22	172.98	2.21	100.00	Compliant	3.44	-18.94
TX4	1921.536	19.76	-0.81	78.52	1.00	100.00	Compliant	0.01	-18.94
TX2	1924.992	19.76	-0.36	87.10	1.11	100.00	Compliant	0.46	-18.94
TX0	1928.448	19.79	0.08	97.05	1.24	100.00	Compliant	0.93	-18.94

NOTE: Although the peak power is over the general exposure limit, the time averaged power is very small for DECT technology. In this case a nominal frame width of 127.6 μ S repeating every 10 mS, and therefore is compliant with the general exposure requirements defined in RSS-102 Section 2.5.1. The reduction in power is calculated by $10 * \text{LOG} (0.1276 / 10)$ or -18.94 dB.

RSS-102 Section 2.5, 2.5.1 & 2.5.2 Requirements:

2.5 - All transmitters are exempt from routine SAR and RF exposure evaluations provided that output power complies with the power levels of sections 2.5.1 or 2.5.2. If the equipment under test (EUT) meets the requirements of sections 2.5.1 or 2.5.2, applicants are only required to submit a properly signed declaration of compliance (see Annex C).

2.5.1 - SAR evaluation is required if the separation distance between the user and the radiating element of the device is less than or equal to 20 cm, except when the device operates as follows:

- above 1 GHz and up to 2.2 GHz inclusively, and with output power (i.e. the higher of the conducted or radiated (e.i.r.p.) source-based, time-averaged output power) that is less than or equal to 100 mW for general public use and 500 mW for controlled use

2.5.2 - RF exposure evaluation is required if the separation distance between the user and the device's radiating element is greater than 20 cm, except when the device operates as follows:

- at or above 1.5 GHz and the maximum e.i.r.p. of the device is equal to or less than 5 W.

7. Test Images

7.1. Radiated Emissions – Front



7. Test Images

7.2. Radiated Emissions – Rear Below 30 MHz



7. Test Images

7.3. Radiated Emissions – Rear 30 MHz to 1 GHz



7. Test Images

7.4. Radiated Emissions – Rear Above 1 GHz



7. Test Images

7.5. Radiated Emissions – Front Above 1 GHz



Test Number: 165-14A

Issue Date: 6/13/2014

7. Test Images

7.6. Conducted Emissions (Front)



7. Test Images

7.7. Conducted Emissions (Rear)

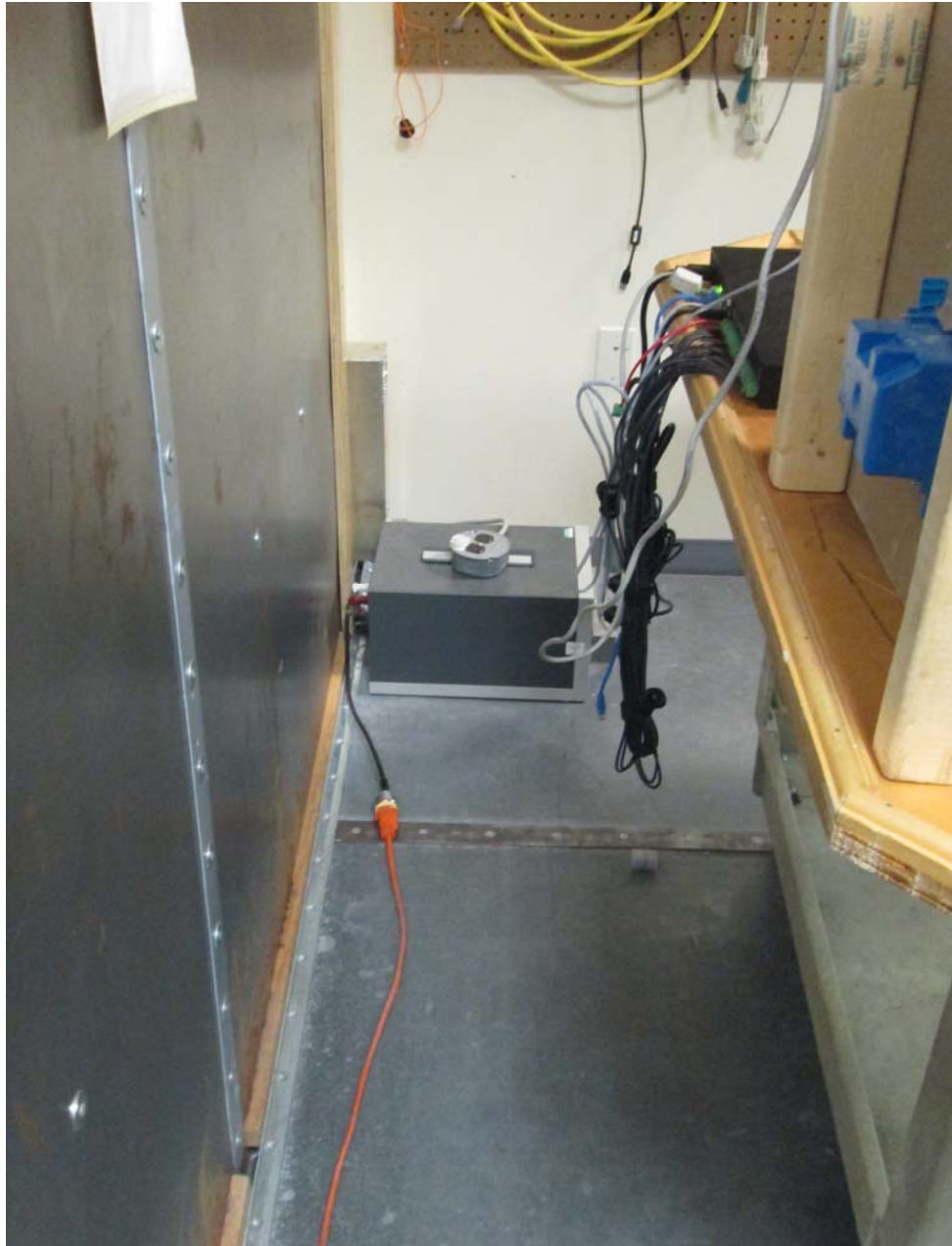

8. Test Site Description

Compliance Worldwide is located at 357 Main Street in Sandown, New Hampshire. The test sites at Compliance Worldwide are used for conducted and radiated emissions testing in accordance with Federal Communications Commission (FCC) and Industry Canada standards. A description of the test sites is on file with the FCC (registration number **96392**) and Industry Canada (file number **IC 3023A-1**).

The radiated emissions test site is a 3 and 10 meter enclosed open area test site (OATS). Personnel, support equipment and test equipment are located in the basement beneath the OATS ground plane.

The conducted emissions site consists of a 10' x 9' ground plane with an 8' x 9' Vertical Plane that is bonded at the seams.

Both sites are designed to test products or systems 1.5 meter W x 1.5 meter L x 2.0 meter H, floor standing or table top.