

30MHz-3GHz_Band4_1.4MHz_QPSK_1_0_LowCH19957-1710.7

3GHz-10GHz_Band4_1.4MHz_QPSK_1_0_MidCH20175-1732.5

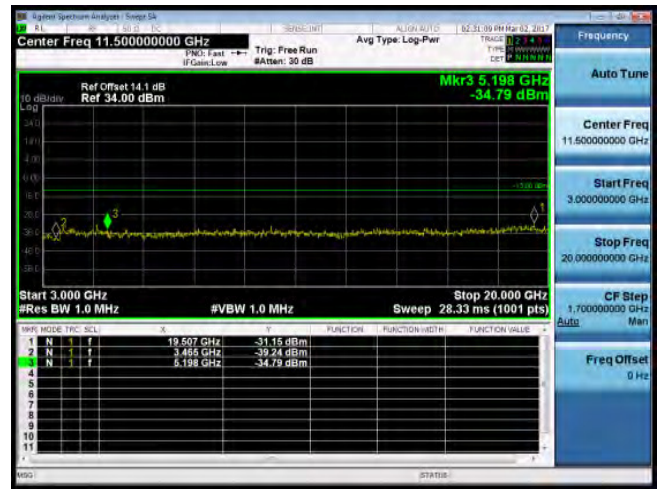
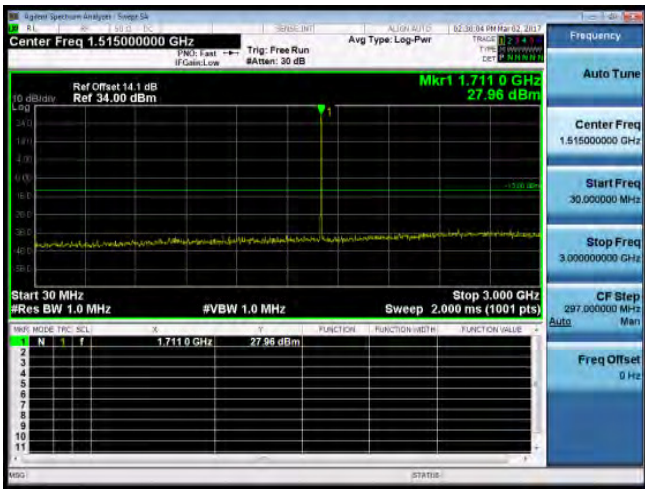

3GHz-10GHz_Band4_1.4MHz_QPSK_1_0_LowCH19957-1710.7

30MHz-3GHz_Band4_1.4MHz_QPSK_1_0_HighCH20393-1754.3

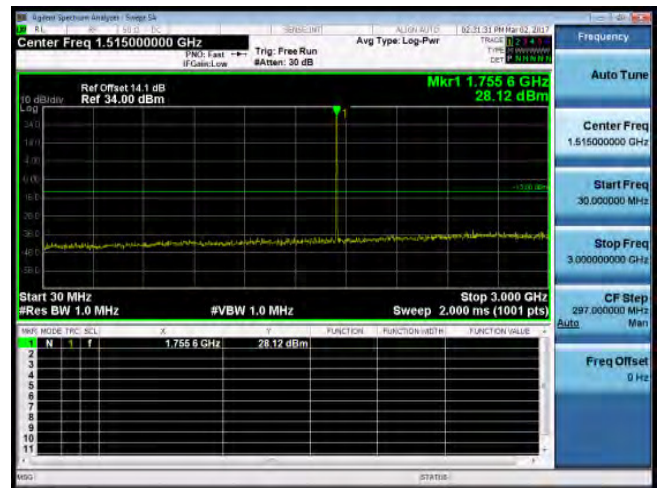
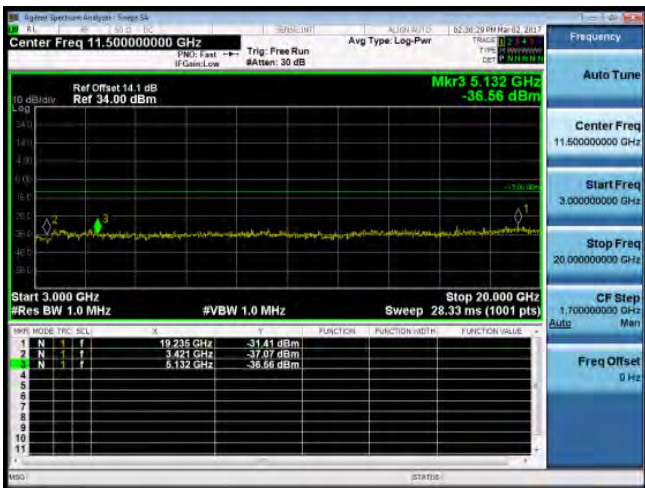

30MHz-3GHz_Band4_1.4MHz_QPSK_1_0_MidCH20175-1732.5

3GHz-10GHz_Band4_1.4MHz_QPSK_1_0_HighCH20393-1754.3

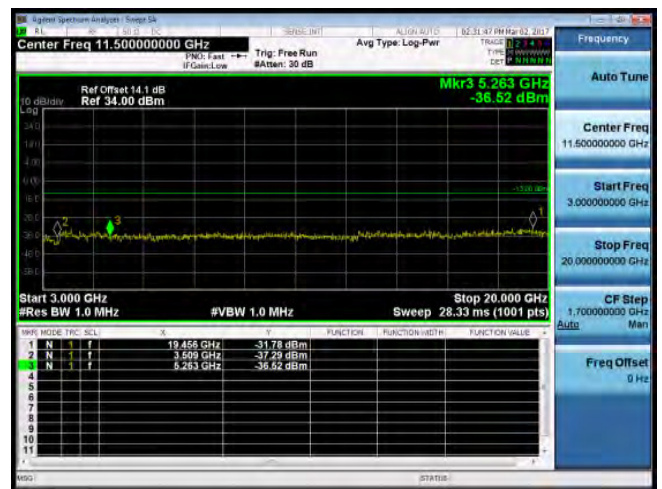
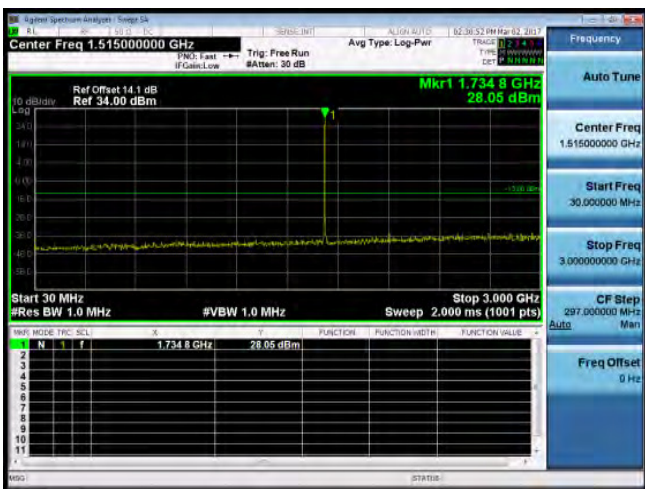

Unless otherwise stated the results shown in this test report refer only to the sample(s) tested and such sample(s) are retained for 90 days only.
除非另有說明，此報告結果僅對測試之樣品負責，同時此樣品僅保留90天。本報告未經本公司書面許可，不可部份複製。

This document is issued by the Company subject to its General Conditions of Service printed overleaf, available on request or accessible at www.sgs.com/terms_and_conditions.htm and, for electronic format documents, subject to Terms and Conditions for Electronic Documents at www.sgs.com/terms_e-document.htm. Attention is drawn to the limitation of liability, indemnification and jurisdiction issues defined therein. Any holder of this document is advised that information contained hereon reflects the Company's findings at the time of its intervention only and within the limits of Client's instructions, if any. The Company's sole responsibility is to its Client and this document does not exonerate parties to a transaction from exercising all their rights and obligations under the transaction documents. This document cannot be reproduced except in full, without prior written approval of the Company. Any unauthorized alteration, forgery or falsification of the content or appearance of this document is unlawful and offenders may be prosecuted to the fullest extent of the law.

30MHz-3GHz_Band4_3MHz_QPSK_1_0_LowCH19965-1711.5

3GHz-10GHz_Band4_3MHz_QPSK_1_0_MidCH20175-1732.5

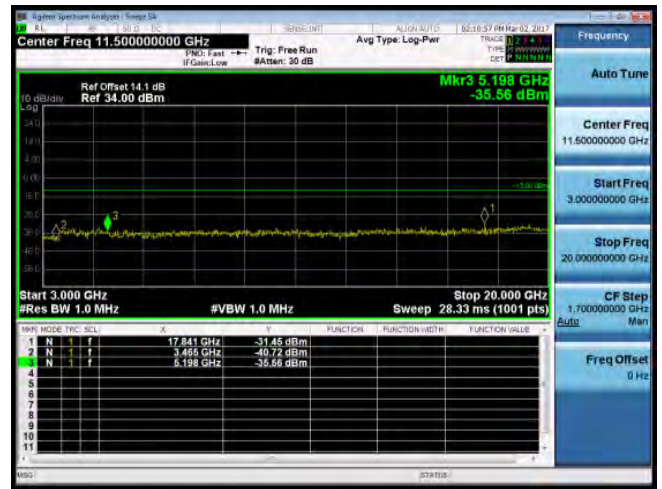
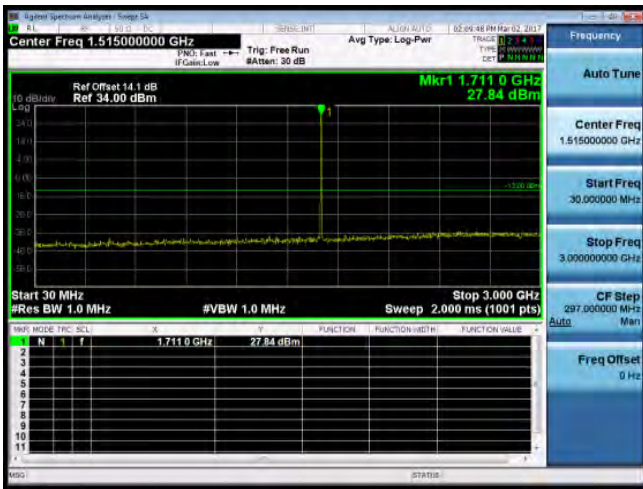

3GHz-10GHz_Band4_3MHz_QPSK_1_0_LowCH19965-1711.5

30MHz-3GHz_Band4_3MHz_QPSK_1_0_HighCH20385-1753.5

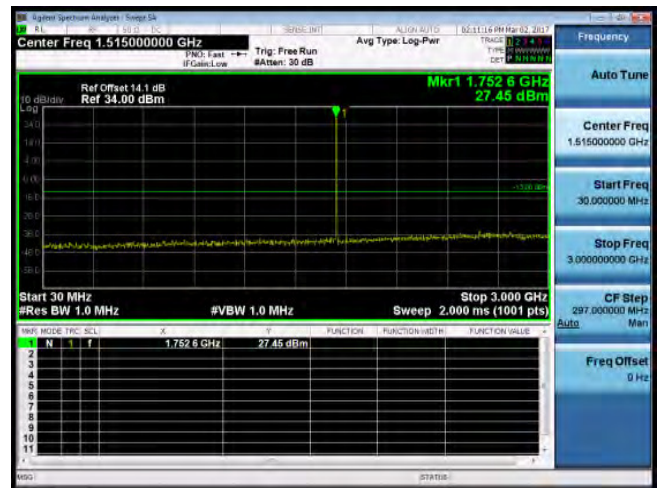
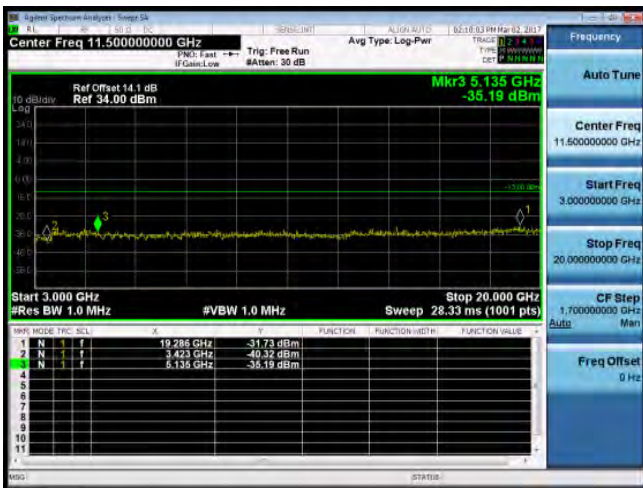

30MHz-3GHz_Band4_3MHz_QPSK_1_0_MidCH20175-1732.5

3GHz-10GHz_Band4_3MHz_QPSK_1_0_HighCH20385-1753.5

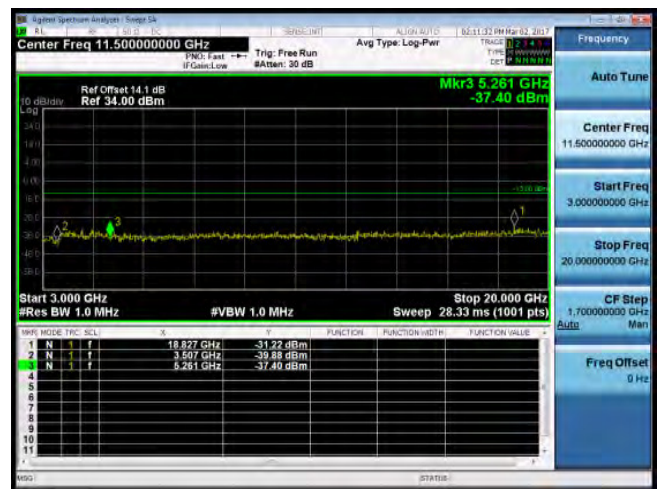
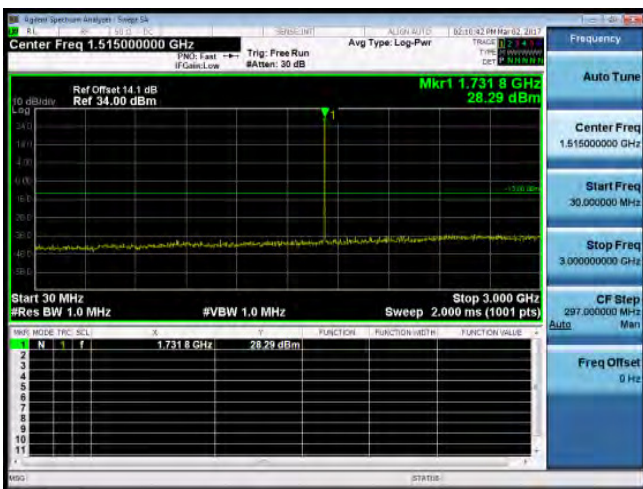

Unless otherwise stated the results shown in this test report refer only to the sample(s) tested and such sample(s) are retained for 90 days only.

除非另有說明，此報告結果僅對測試之樣品負責，同時此樣品僅保留90天。本報告未經本公司書面許可，不可部份複製。

This document is issued by the Company subject to its General Conditions of Service printed overleaf, available on request or accessible at www.sgs.com/terms_and_conditions.htm and, for electronic format documents, subject to Terms and Conditions for Electronic Documents at www.sgs.com/terms_e-document.htm. Attention is drawn to the limitation of liability, indemnification and jurisdiction issues defined therein. Any holder of this document is advised that information contained hereon reflects the Company's findings at the time of its intervention only and within the limits of Client's instructions, if any. The Company's sole responsibility is to its Client and this document does not exonerate parties to a transaction from exercising all their rights and obligations under the transaction documents. This document cannot be reproduced except in full, without prior written approval of the Company. Any unauthorized alteration, forgery or falsification of the content or appearance of this document is unlawful and offenders may be prosecuted to the fullest extent of the law.

30MHz-3GHz_Band4_5MHz_QPSK_1_0_LowCH19975-1712.5

3GHz-10GHz_Band4_5MHz_QPSK_1_0_MidCH20175-1732.5

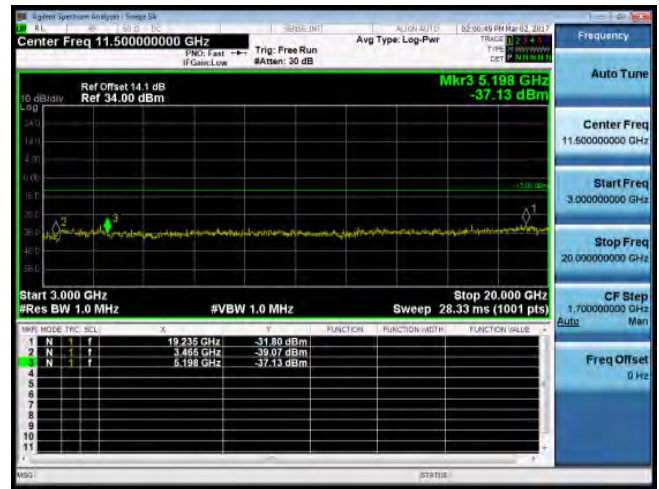
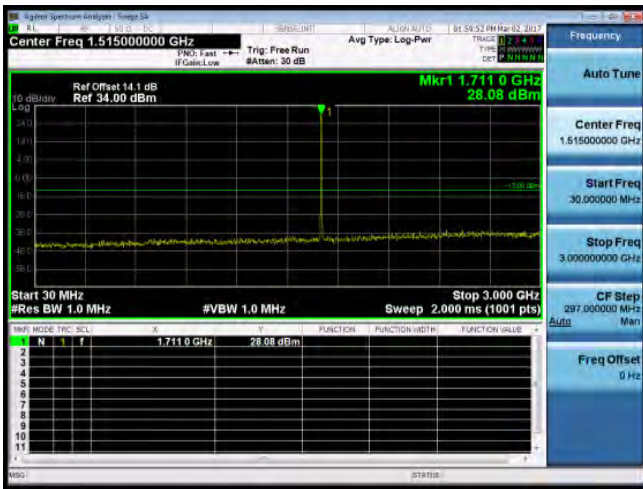

3GHz-10GHz_Band4_5MHz_QPSK_1_0_LowCH19975-1712.5

30MHz-3GHz_Band4_5MHz_QPSK_1_0_HighCH20375-1752.5

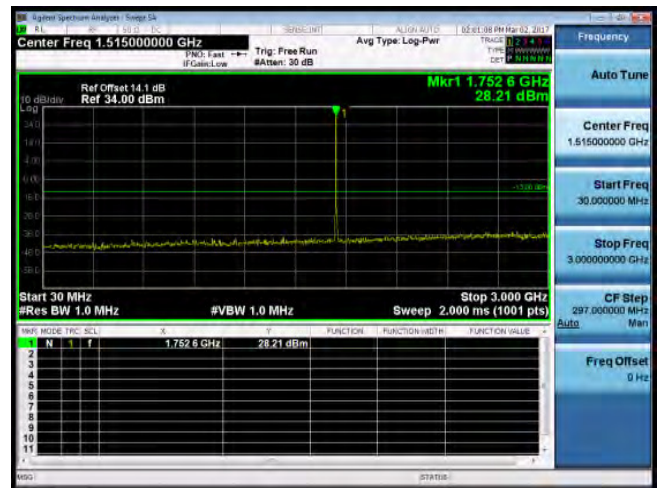
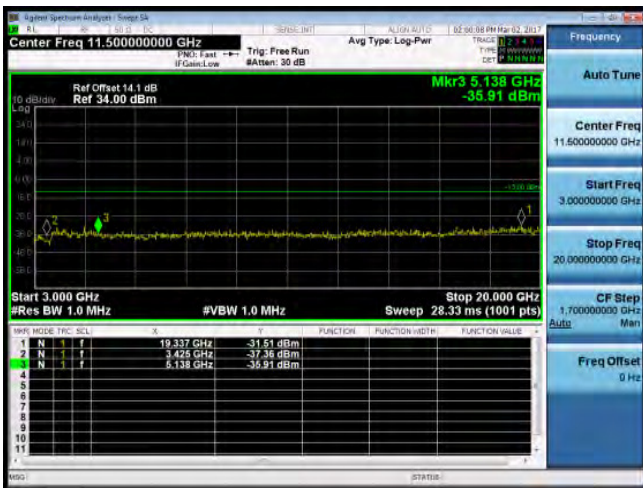

30MHz-3GHz_Band4_5MHz_QPSK_1_0_MidCH20175-1732.5

3GHz-10GHz_Band4_5MHz_QPSK_1_0_HighCH20375-1752.5

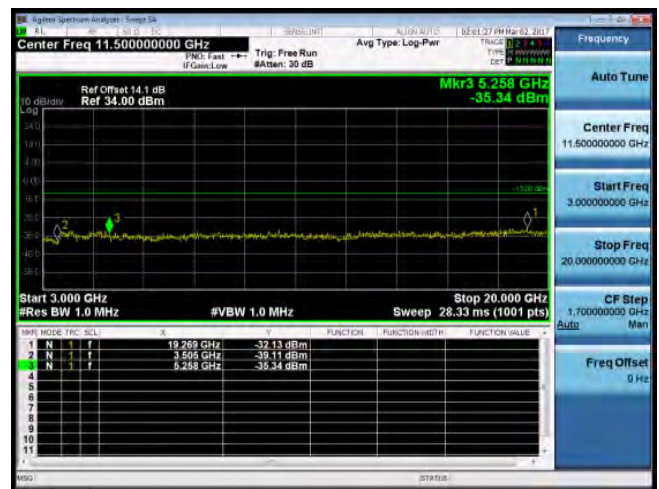
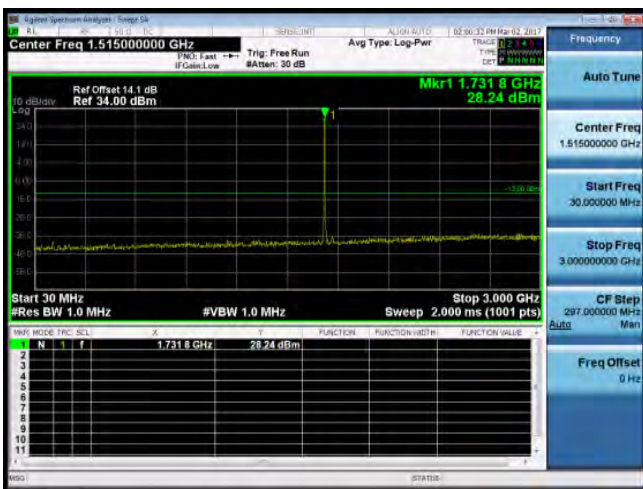

Unless otherwise stated the results shown in this test report refer only to the sample(s) tested and such sample(s) are retained for 90 days only.
除非另有說明，此報告結果僅對測試之樣品負責，同時此樣品僅保留90天。本報告未經本公司書面許可，不可部份複製。

This document is issued by the Company subject to its General Conditions of Service printed overleaf, available on request or accessible at www.sgs.com/terms_and_conditions.htm and, for electronic format documents, subject to Terms and Conditions for Electronic Documents at www.sgs.com/terms_e-document.htm. Attention is drawn to the limitation of liability, indemnification and jurisdiction issues defined therein. Any holder of this document is advised that information contained hereon reflects the Company's findings at the time of its intervention only and within the limits of Client's instructions, if any. The Company's sole responsibility is to its Client and this document does not exonerate parties to a transaction from exercising all their rights and obligations under the transaction documents. This document cannot be reproduced except in full, without prior written approval of the Company. Any unauthorized alteration, forgery or falsification of the content or appearance of this document is unlawful and offenders may be prosecuted to the fullest extent of the law.

30MHz-3GHz_Band4_10MHz_QPSK_1_0_LowCH20000-1715

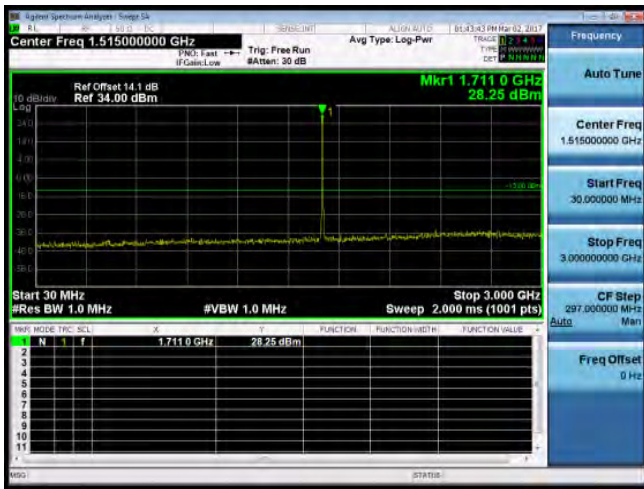

3GHz-10GHz_Band4_10MHz_QPSK_1_0_MidCH20175-1732.5

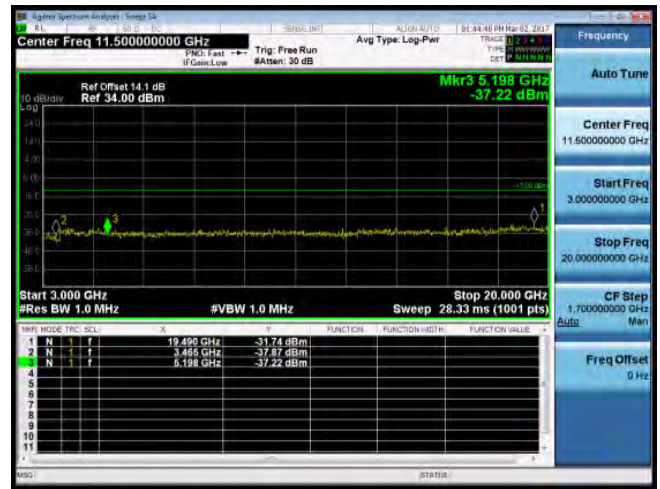

3GHz-10GHz_Band4_10MHz_QPSK_1_0_LowCH20000-1715

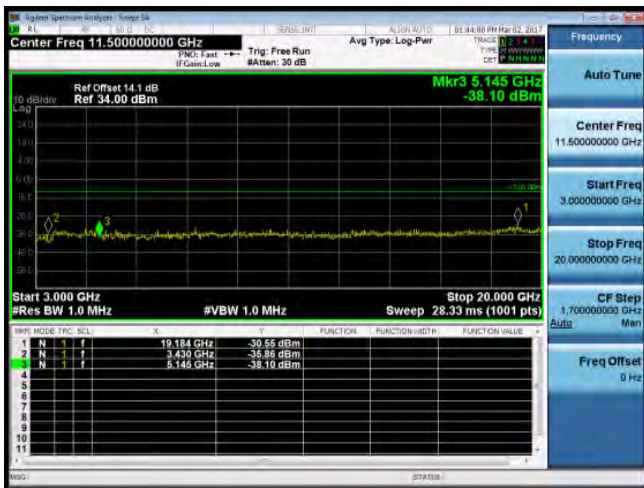

30MHz-3GHz_Band4_10MHz_QPSK_1_0_HighCH20350-1750

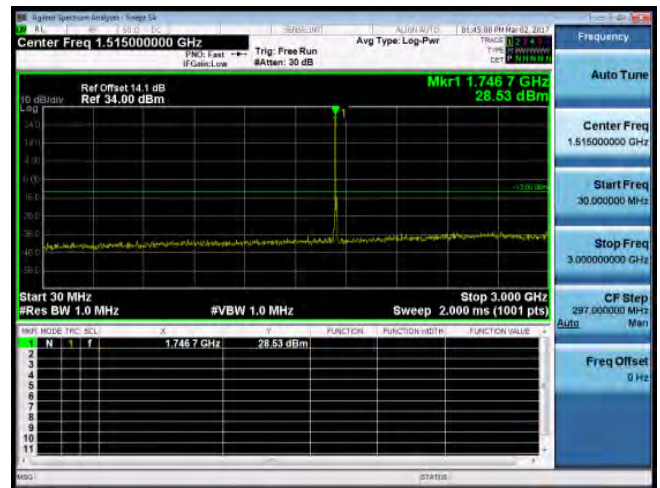

30MHz-3GHz_Band4_10MHz_QPSK_1_0_MidCH20175-1732.5

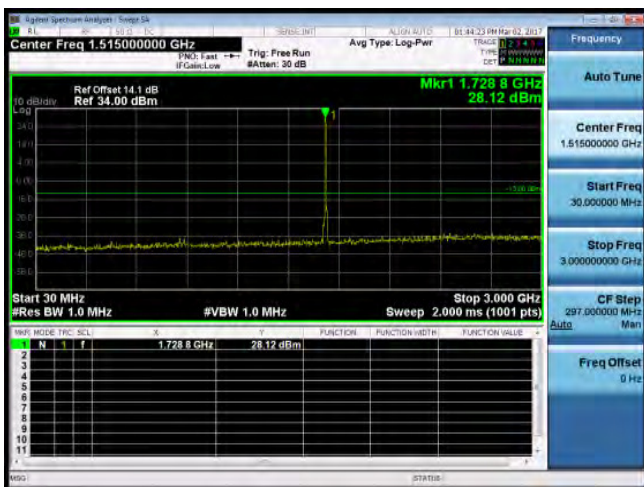

3GHz-10GHz_Band4_10MHz_QPSK_1_0_HighCH20350-1750

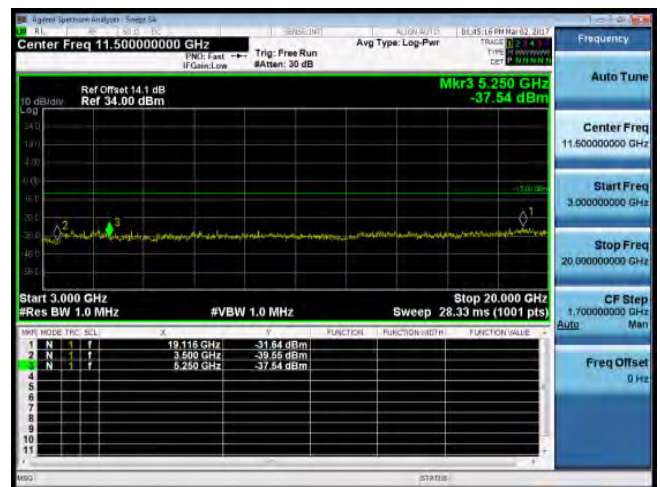

Unless otherwise stated the results shown in this test report refer only to the sample(s) tested and such sample(s) are retained for 90 days only. 除非另有說明，此報告結果僅對測試之樣品負責，同時此樣品僅保留90天。本報告未經本公司書面許可，不可部份複製。

This document is issued by the Company subject to its General Conditions of Service printed overleaf, available on request or accessible at www.sgs.com/terms_and_conditions.htm and, for electronic format documents, subject to Terms and Conditions for Electronic Documents at www.sgs.com/terms_e-document.htm. Attention is drawn to the limitation of liability, indemnification and jurisdiction issues defined therein. Any holder of this document is advised that information contained hereon reflects the Company's findings at the time of its intervention only and within the limits of Client's instructions, if any. The Company's sole responsibility is to its Client and this document does not exonerate parties to a transaction from exercising all their rights and obligations under the transaction documents. This document cannot be reproduced except in full, without prior written approval of the Company. Any unauthorized alteration, forgery or falsification of the content or appearance of this document is unlawful and offenders may be prosecuted to the fullest extent of the law.

30MHz-3GHz_Band4_15MHz_QPSK_1_0_LowCH20025-1717.5

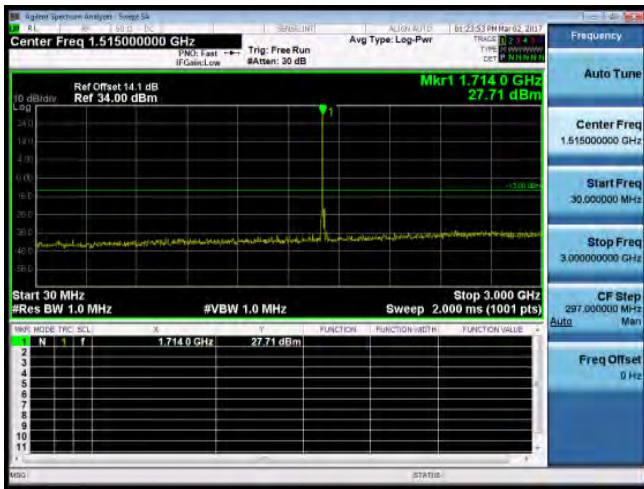

3GHz-10GHz_Band4_15MHz_QPSK_1_0_MidCH20175-1732.5

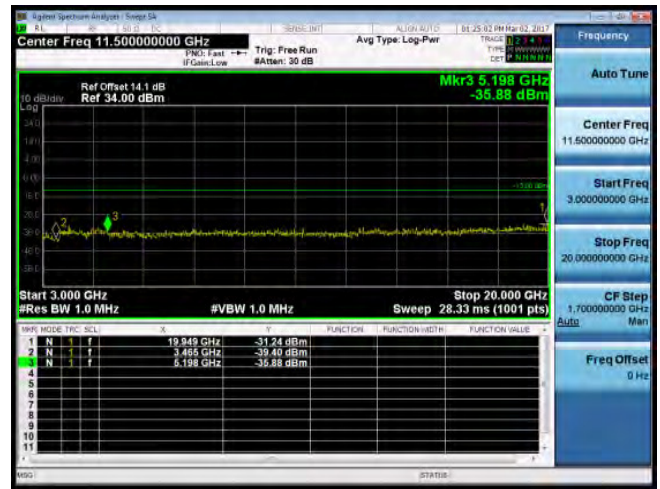

3GHz-10GHz_Band4_15MHz_QPSK_1_0_LowCH20025-1717.5

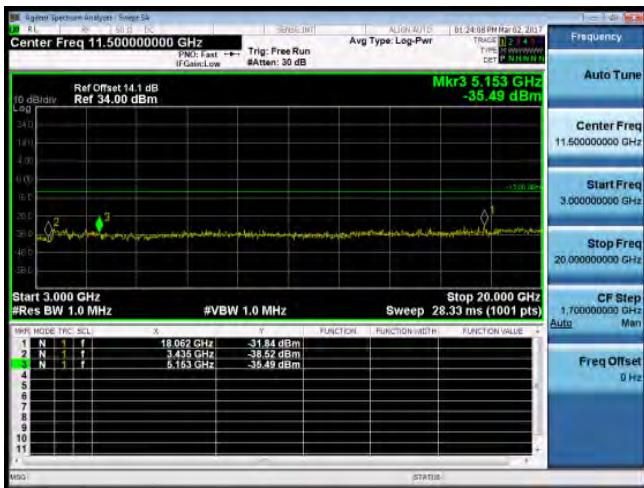

30MHz-3GHz_Band4_15MHz_QPSK_1_0_HighCH20325-1747.5

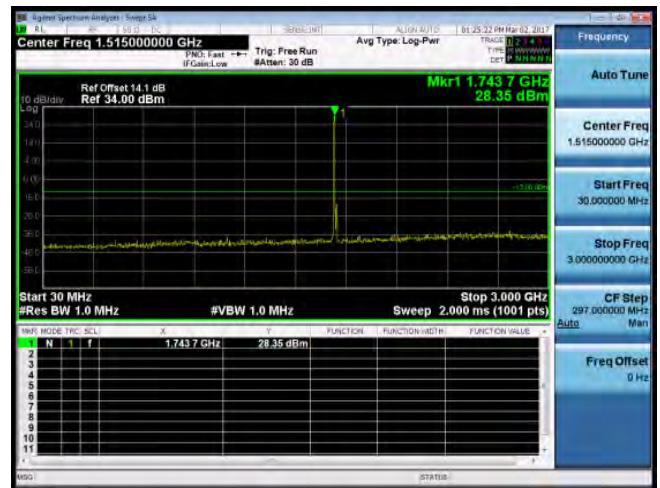

30MHz-3GHz_Band4_15MHz_QPSK_1_0_MidCH20175-1732.5

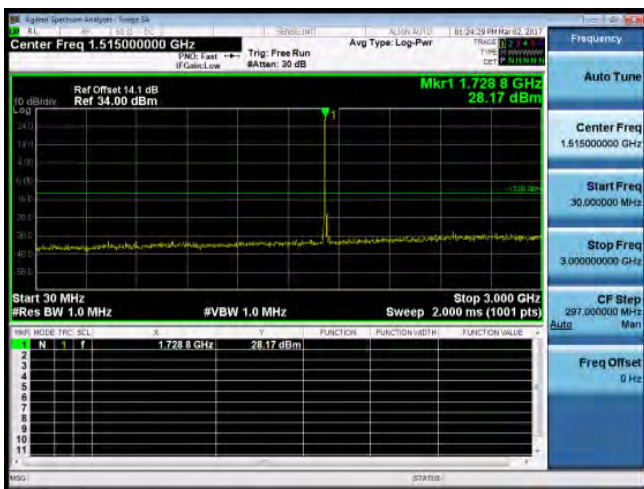

3GHz-10GHz_Band4_15MHz_QPSK_1_0_HighCH20325-1747.5

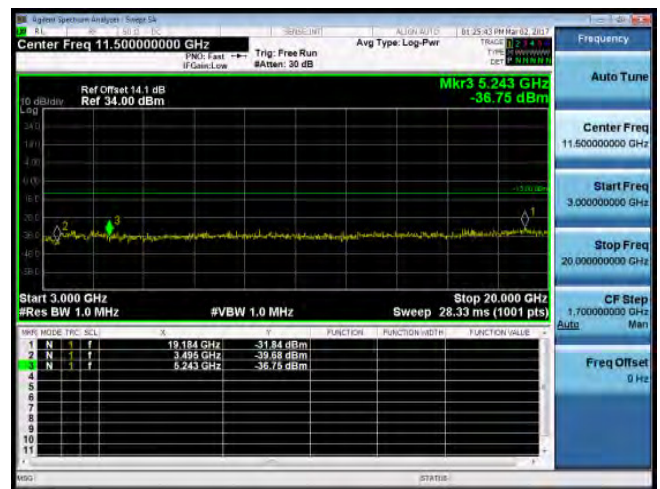

Unless otherwise stated the results shown in this test report refer only to the sample(s) tested and such sample(s) are retained for 90 days only. 除非另有說明，此報告結果僅對測試之樣品負責，同時此樣品僅保留90天。本報告未經本公司書面許可，不可部份複製。

This document is issued by the Company subject to its General Conditions of Service printed overleaf, available on request or accessible at www.sgs.com/terms_and_conditions.htm and, for electronic format documents, subject to Terms and Conditions for Electronic Documents at www.sgs.com/terms_e-document.htm. Attention is drawn to the limitation of liability, indemnification and jurisdiction issues defined therein. Any holder of this document is advised that information contained hereon reflects the Company's findings at the time of its intervention only and within the limits of Client's instructions, if any. The Company's sole responsibility is to its Client and this document does not exonerate parties to a transaction from exercising all their rights and obligations under the transaction documents. This document cannot be reproduced except in full, without prior written approval of the Company. Any unauthorized alteration, forgery or falsification of the content or appearance of this document is unlawful and offenders may be prosecuted to the fullest extent of the law.

30MHz-3GHz_Band4_20MHz_QPSK_1_0_LowCH20050-1720

3GHz-10GHz_Band4_20MHz_QPSK_1_0_MidCH20175-1732.5

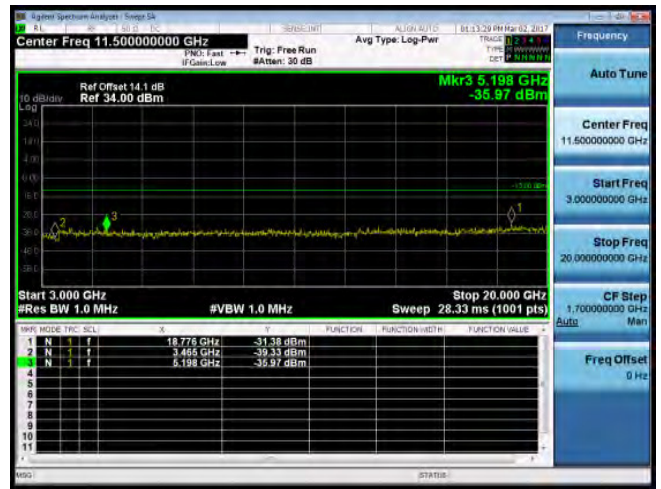
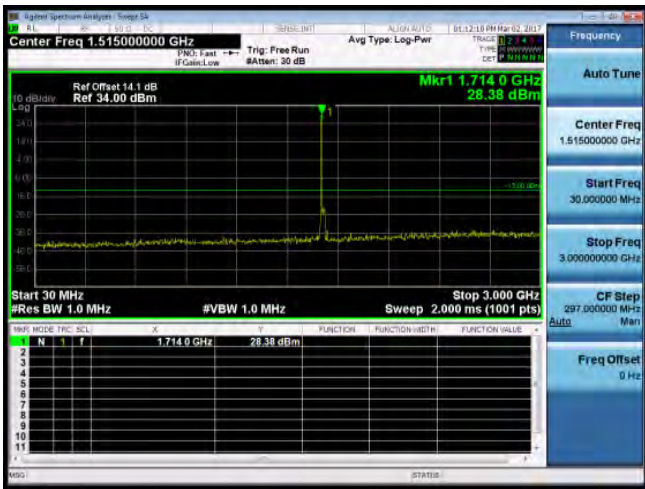

3GHz-10GHz_Band4_20MHz_QPSK_1_0_LowCH20050-1720

30MHz-3GHz_Band4_20MHz_QPSK_1_0_HighCH20300-1745

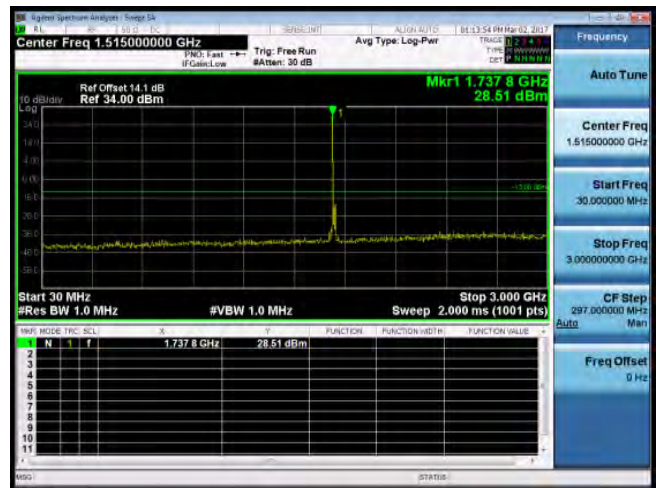
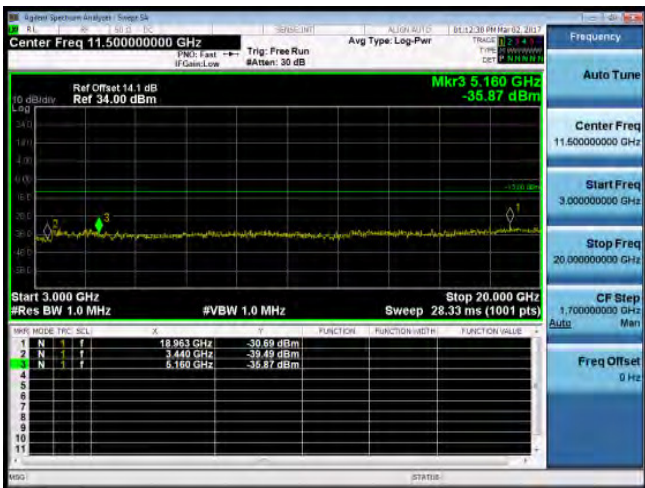

30MHz-3GHz_Band4_20MHz_QPSK_1_0_MidCH20175-1732.5

3GHz-10GHz_Band4_20MHz_QPSK_1_0_HighCH20300-1745

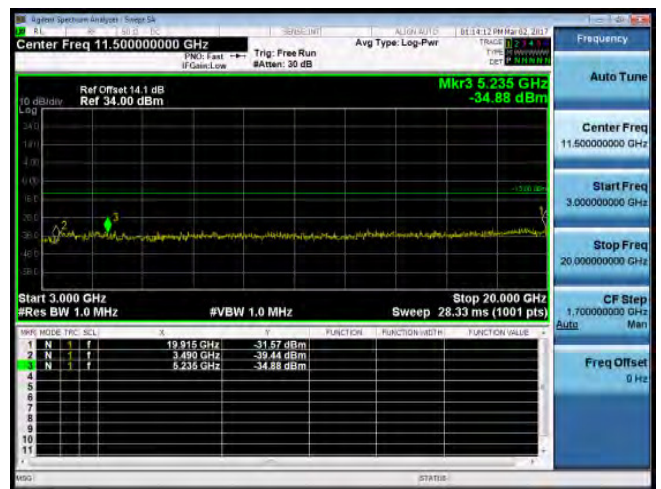
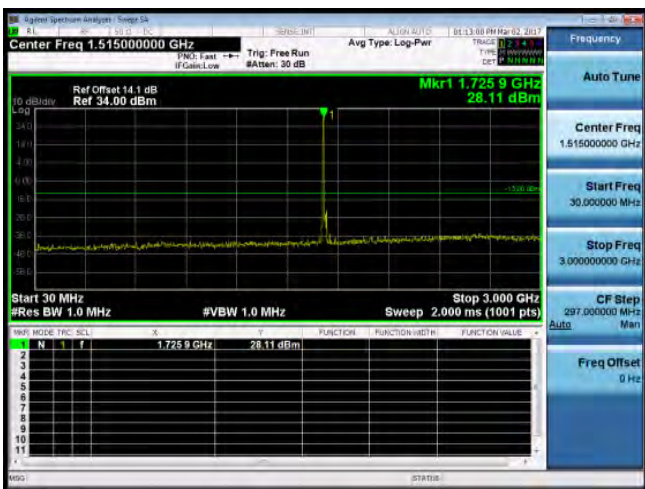

Unless otherwise stated the results shown in this test report refer only to the sample(s) tested and such sample(s) are retained for 90 days only. 除非另有說明，此報告結果僅對測試之樣品負責，同時此樣品僅保留90天。本報告未經本公司書面許可，不可部份複製。

This document is issued by the Company subject to its General Conditions of Service printed overleaf, available on request or accessible at www.sgs.com/terms_and_conditions.htm and, for electronic format documents, subject to Terms and Conditions for Electronic Documents at www.sgs.com/terms_e-document.htm. Attention is drawn to the limitation of liability, indemnification and jurisdiction issues defined therein. Any holder of this document is advised that information contained hereon reflects the Company's findings at the time of its intervention only and within the limits of Client's instructions, if any. The Company's sole responsibility is to its Client and this document does not exonerate parties to a transaction from exercising all their rights and obligations under the transaction documents. This document cannot be reproduced except in full, without prior written approval of the Company. Any unauthorized alteration, forgery or falsification of the content or appearance of this document is unlawful and offenders may be prosecuted to the fullest extent of the law.

30MHz-3GHz_Band5_1.4MHz_QPSK_1_0_LowCH20407-824.7

3GHz-10GHz_Band5_1.4MHz_QPSK_1_0_MidCH20525-836.5

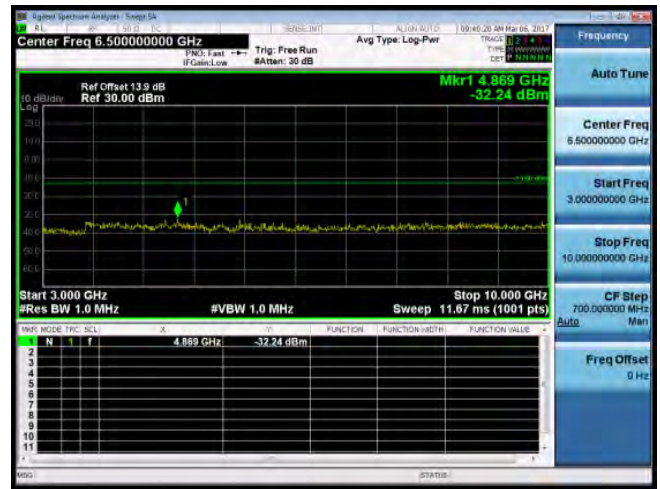
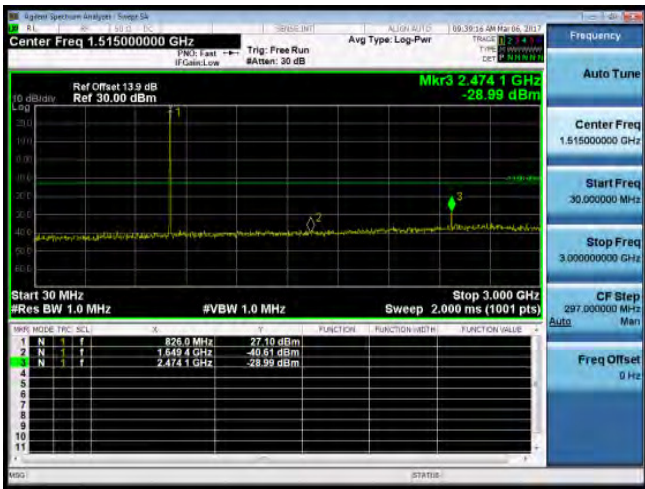

3GHz-10GHz_Band5_1.4MHz_QPSK_1_0_LowCH20407-824.7

30MHz-3GHz_Band5_1.4MHz_QPSK_1_0_HighCH20643-848.3

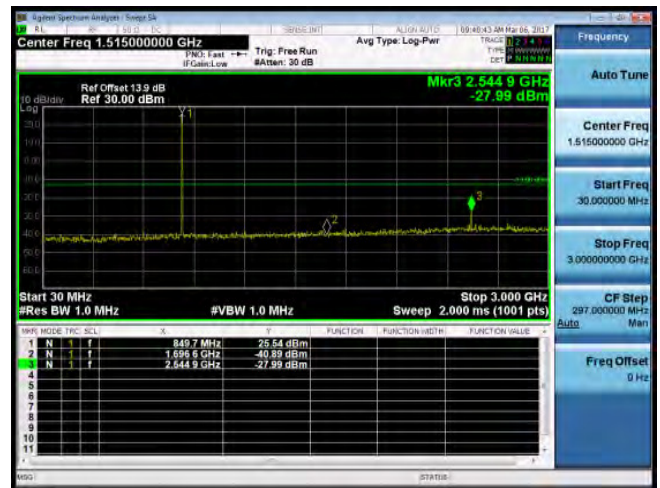
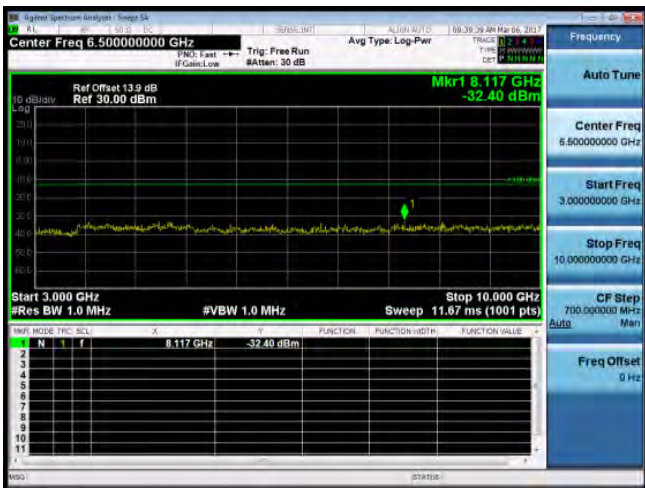

30MHz-3GHz_Band5_1.4MHz_QPSK_1_0_MidCH20525-836.5

3GHz-10GHz_Band5_1.4MHz_QPSK_1_0_HighCH20643-848.3

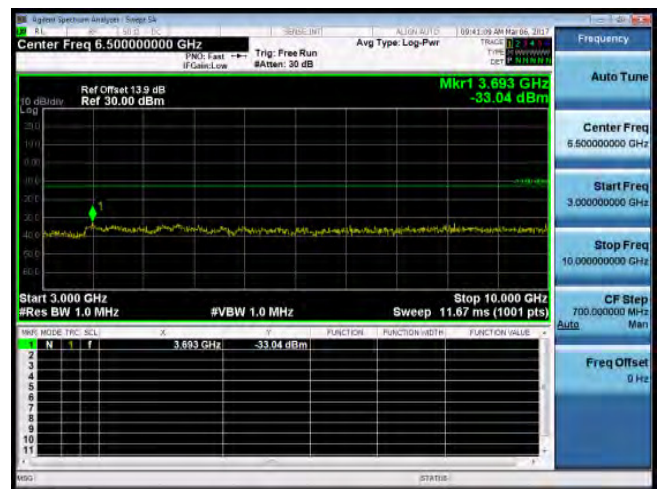
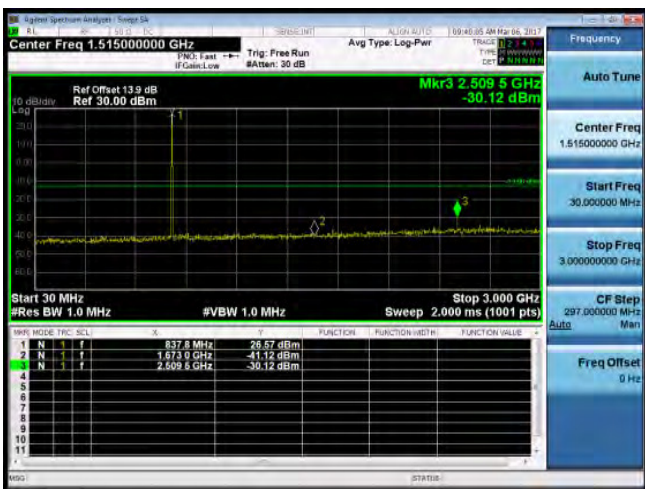

Unless otherwise stated the results shown in this test report refer only to the sample(s) tested and such sample(s) are retained for 90 days only.
除非另有說明，此報告結果僅對測試之樣品負責，同時此樣品僅保留90天。本報告未經本公司書面許可，不可部份複製。

This document is issued by the Company subject to its General Conditions of Service printed overleaf, available on request or accessible at www.sgs.com/terms_and_conditions.htm and, for electronic format documents, subject to Terms and Conditions for Electronic Documents at www.sgs.com/terms_e-document.htm. Attention is drawn to the limitation of liability, indemnification and jurisdiction issues defined therein. Any holder of this document is advised that information contained herein reflects the Company's findings at the time of its intervention only and within the limits of Client's instructions, if any. The Company's sole responsibility is to its Client and this document does not exonerate parties to a transaction from exercising all their rights and obligations under the transaction documents. This document cannot be reproduced except in full, without prior written approval of the Company. Any unauthorized alteration, forgery or falsification of the content or appearance of this document is unlawful and offenders may be prosecuted to the fullest extent of the law.

30MHz-3GHz_Band5_3MHz_QPSK_1_0_LowCH20415-825.5

3GHz-10GHz_Band5_3MHz_QPSK_1_0_MidCH20525-836.5

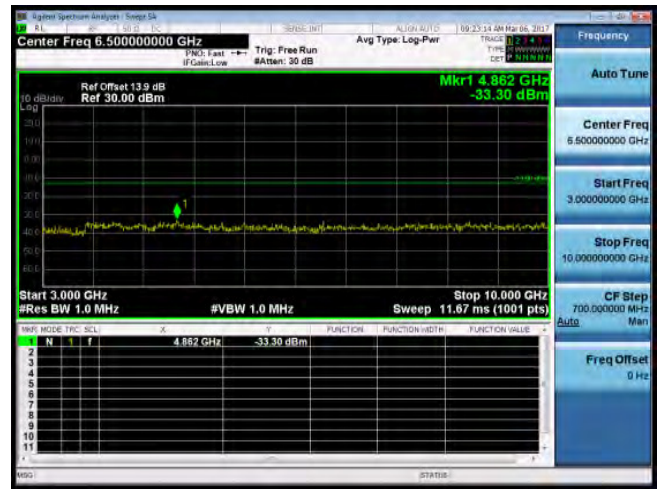
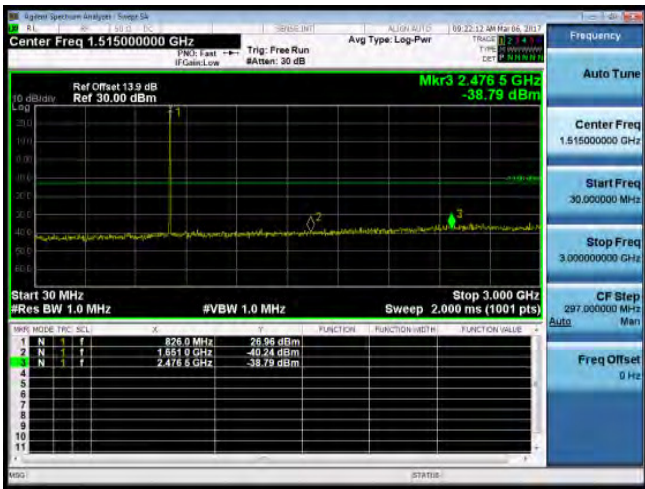

3GHz-10GHz_Band5_3MHz_QPSK_1_0_LowCH20415-825.5

30MHz-3GHz_Band5_3MHz_QPSK_1_0_HighCH20635-847.5

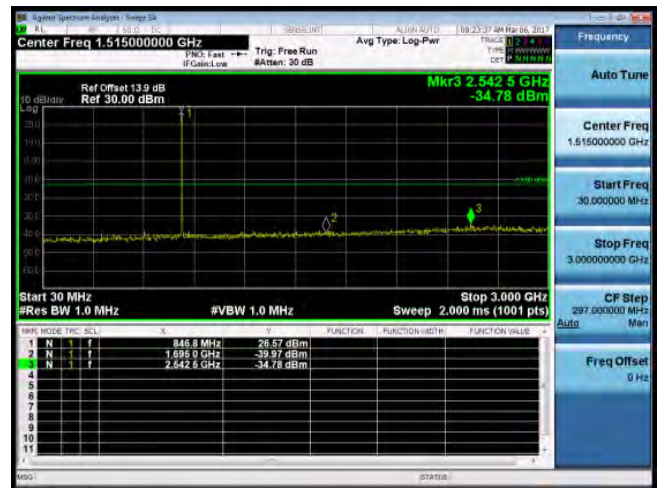
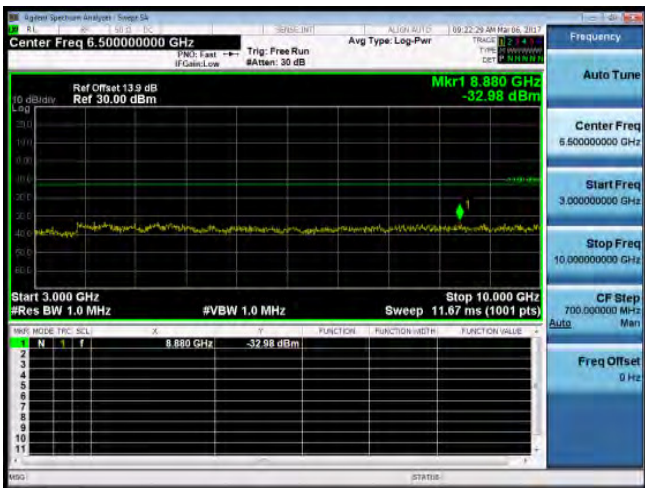

30MHz-3GHz_Band5_3MHz_QPSK_1_0_MidCH20525-836.5

3GHz-10GHz_Band5_3MHz_QPSK_1_0_HighCH20635-847.5

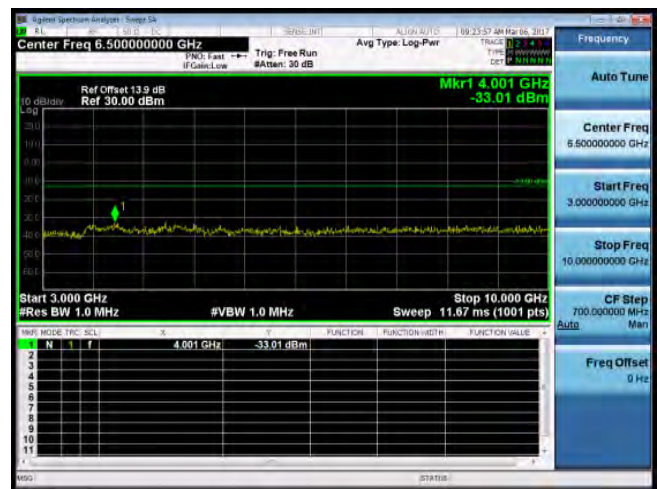
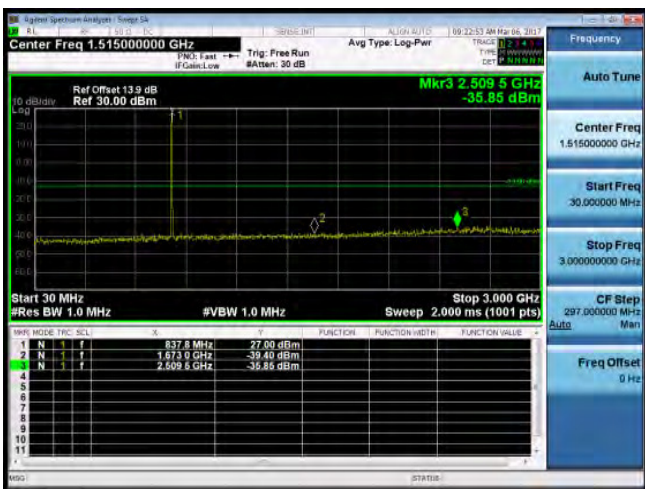

Unless otherwise stated the results shown in this test report refer only to the sample(s) tested and such sample(s) are retained for 90 days only.
除非另有說明，此報告結果僅對測試之樣品負責，同時此樣品僅保留90天。本報告未經本公司書面許可，不可部份複製。

This document is issued by the Company subject to its General Conditions of Service printed overleaf, available on request or accessible at www.sgs.com/terms_and_conditions.htm and, for electronic format documents, subject to Terms and Conditions for Electronic Documents at www.sgs.com/terms_e-document.htm. Attention is drawn to the limitation of liability, indemnification and jurisdiction issues defined therein. Any holder of this document is advised that information contained hereon reflects the Company's findings at the time of its intervention only and within the limits of Client's instructions, if any. The Company's sole responsibility is to its Client and this document does not exonerate parties to a transaction from exercising all their rights and obligations under the transaction documents. This document cannot be reproduced except in full, without prior written approval of the Company. Any unauthorized alteration, forgery or falsification of the content or appearance of this document is unlawful and offenders may be prosecuted to the fullest extent of the law.

30MHz-3GHz_Band5_5MHz_QPSK_1_0_LowCH20425-826.5

3GHz-10GHz_Band5_5MHz_QPSK_1_0_MidCH20525-836.5

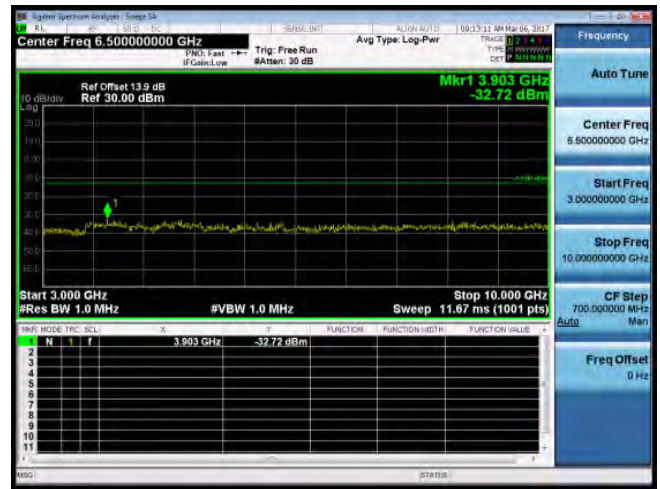
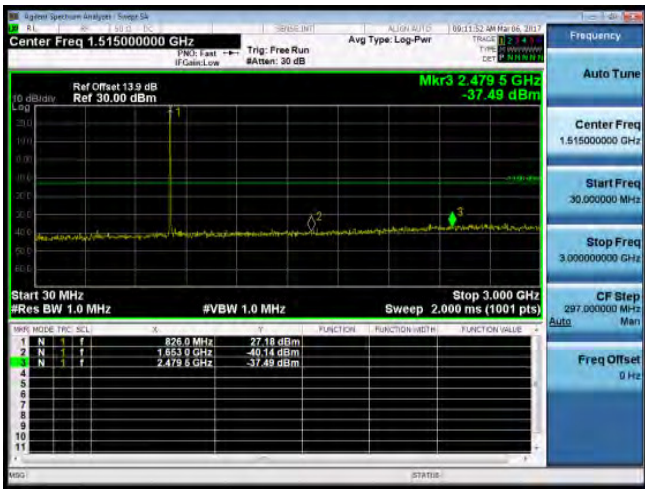

3GHz-10GHz_Band5_5MHz_QPSK_1_0_LowCH20425-826.5

30MHz-3GHz_Band5_5MHz_QPSK_1_0_HighCH20625-846.5

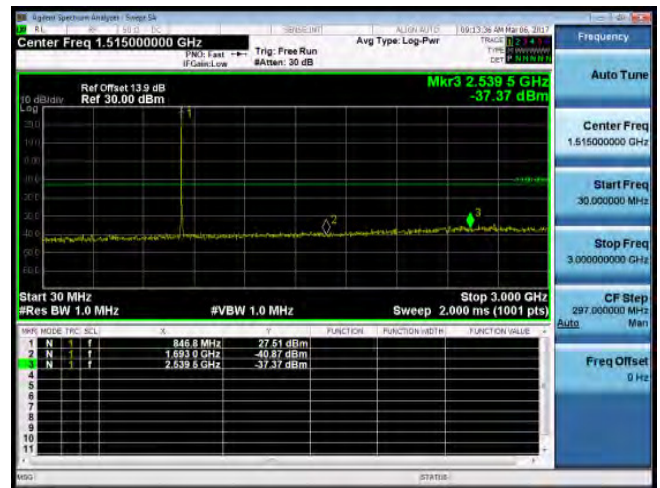
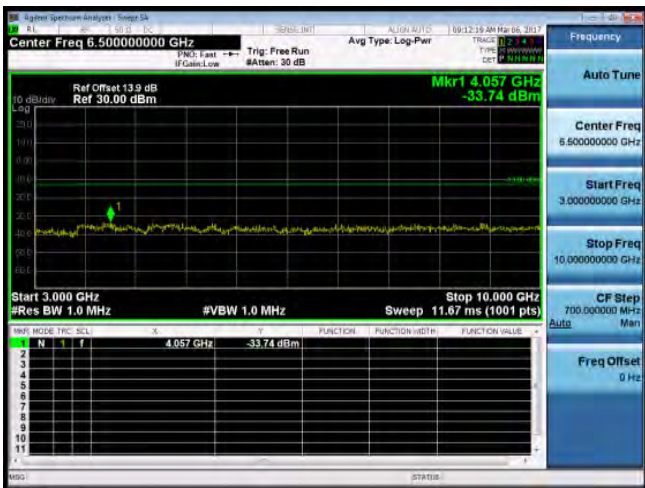

30MHz-3GHz_Band5_5MHz_QPSK_1_0_MidCH20525-836.5

3GHz-10GHz_Band5_5MHz_QPSK_1_0_HighCH20625-846.5

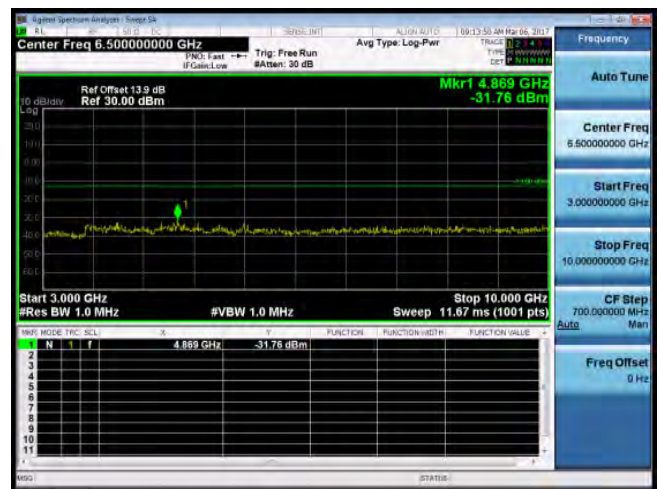
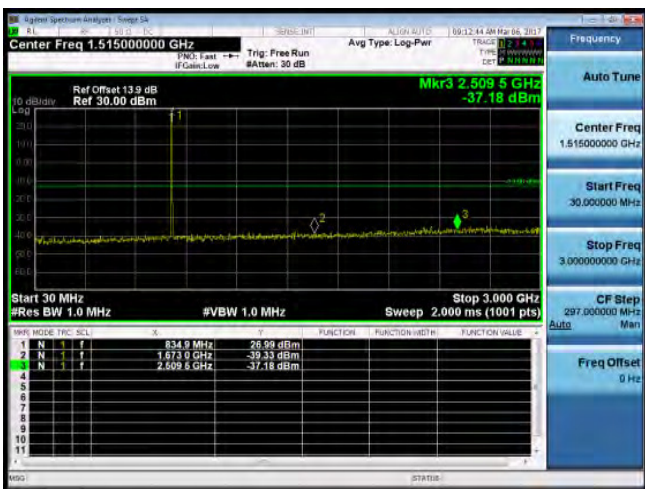

Unless otherwise stated the results shown in this test report refer only to the sample(s) tested and such sample(s) are retained for 90 days only. 除非另有說明，此報告結果僅對測試之樣品負責，同時此樣品僅保留90天。本報告未經本公司書面許可，不可部份複製。

This document is issued by the Company subject to its General Conditions of Service printed overleaf, available on request or accessible at www.sgs.com/terms_and_conditions.htm and, for electronic format documents, subject to Terms and Conditions for Electronic Documents at www.sgs.com/terms_e-document.htm. Attention is drawn to the limitation of liability, indemnification and jurisdiction issues defined therein. Any holder of this document is advised that information contained hereon reflects the Company's findings at the time of its intervention only and within the limits of Client's instructions, if any. The Company's sole responsibility is to its Client and this document does not exonerate parties to a transaction from exercising all their rights and obligations under the transaction documents. This document cannot be reproduced except in full, without prior written approval of the Company. Any unauthorized alteration, forgery or falsification of the content or appearance of this document is unlawful and offenders may be prosecuted to the fullest extent of the law.

30MHz-3GHz_Band5_10MHz_QPSK_1_0_LowCH20450-829

3GHz-10GHz_Band5_10MHz_QPSK_1_0_MidCH20525-836.5

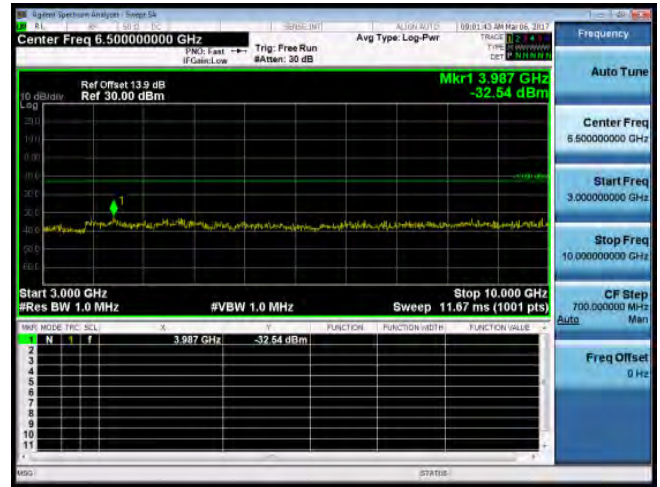
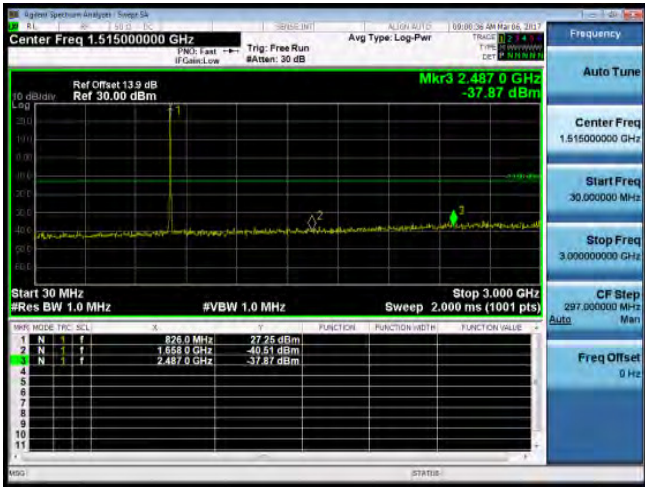

3GHz-10GHz_Band5_10MHz_QPSK_1_0_LowCH20450-829

30MHz-3GHz_Band5_10MHz_QPSK_1_0_HighCH20600-844

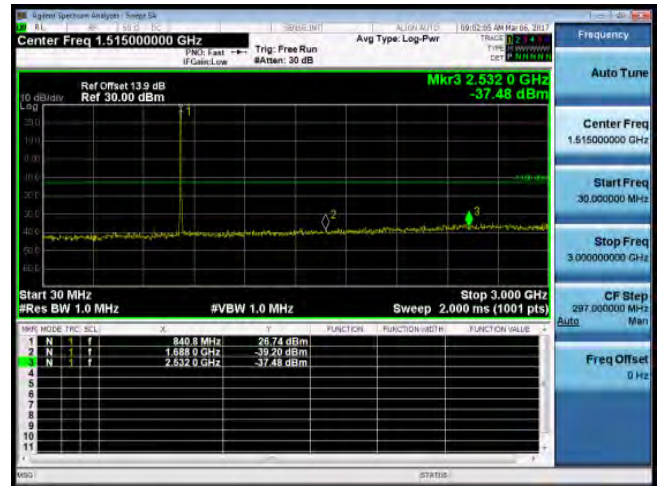
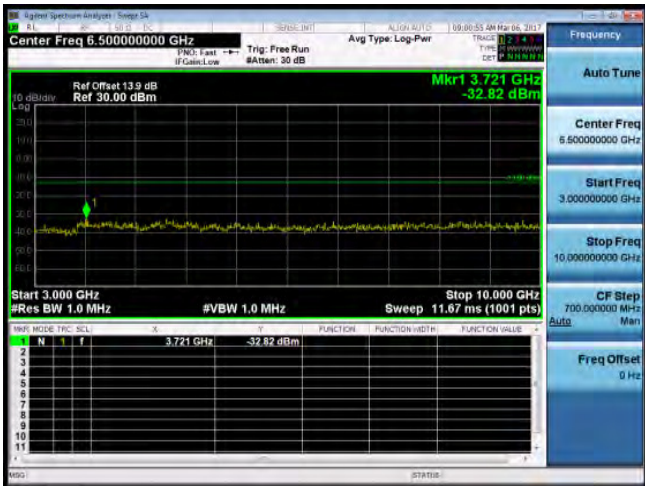

30MHz-3GHz_Band5_10MHz_QPSK_1_0_MidCH20525-836.5

3GHz-10GHz_Band5_10MHz_QPSK_1_0_HighCH20600-844

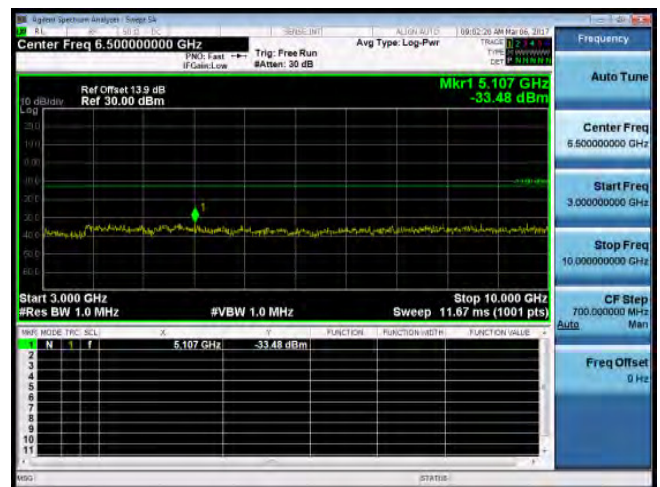
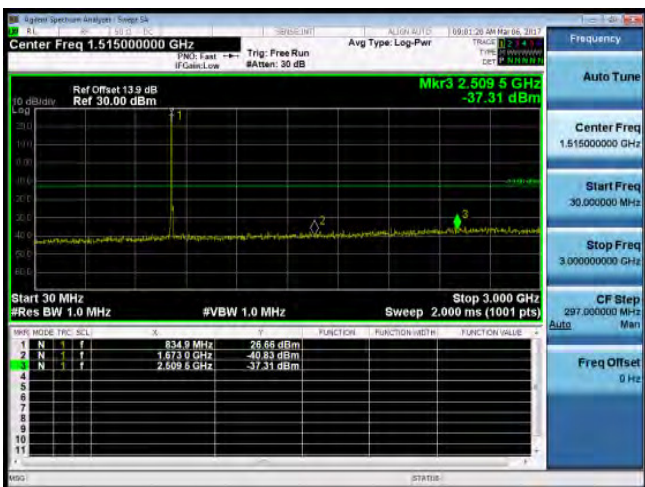

Unless otherwise stated the results shown in this test report refer only to the sample(s) tested and such sample(s) are retained for 90 days only. 除非另有說明，此報告結果僅對測試之樣品負責，同時此樣品僅保留90天。本報告未經本公司書面許可，不可部份複製。

This document is issued by the Company subject to its General Conditions of Service printed overleaf, available on request or accessible at www.sgs.com/terms_and_conditions.htm and, for electronic format documents, subject to Terms and Conditions for Electronic Documents at www.sgs.com/terms_e-document.htm. Attention is drawn to the limitation of liability, indemnification and jurisdiction issues defined therein. Any holder of this document is advised that information contained hereon reflects the Company's findings at the time of its intervention only and within the limits of Client's instructions, if any. The Company's sole responsibility is to its Client and this document does not exonerate parties to a transaction from exercising all their rights and obligations under the transaction documents. This document cannot be reproduced except in full, without prior written approval of the Company. Any unauthorized alteration, forgery or falsification of the content or appearance of this document is unlawful and offenders may be prosecuted to the fullest extent of the law.

30MHz-3GHz_Band12_1.4MHz_QPSK_1_0_LowCH23017-699.7

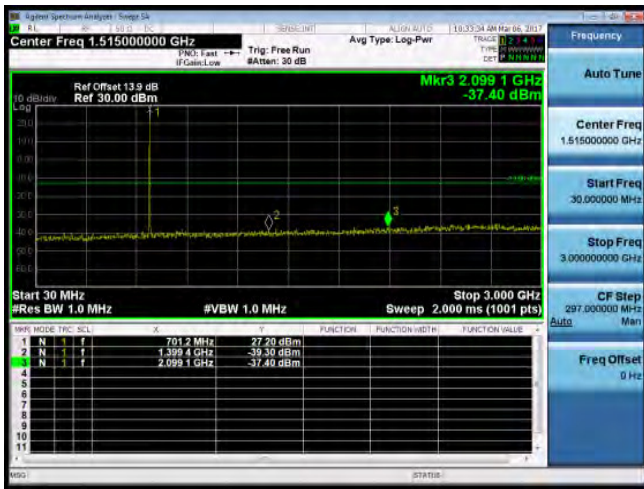

3GHz-10GHz_Band12_1.4MHz_QPSK_1_0_MidCH23095-707.5

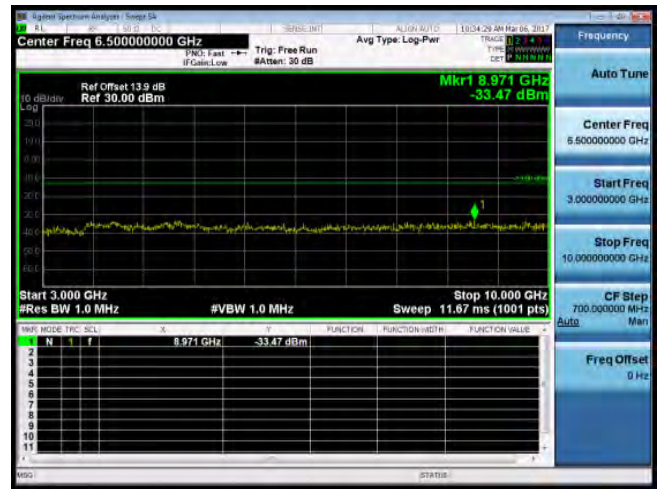

3GHz-10GHz_Band12_1.4MHz_QPSK_1_0_LowCH23017-699.7

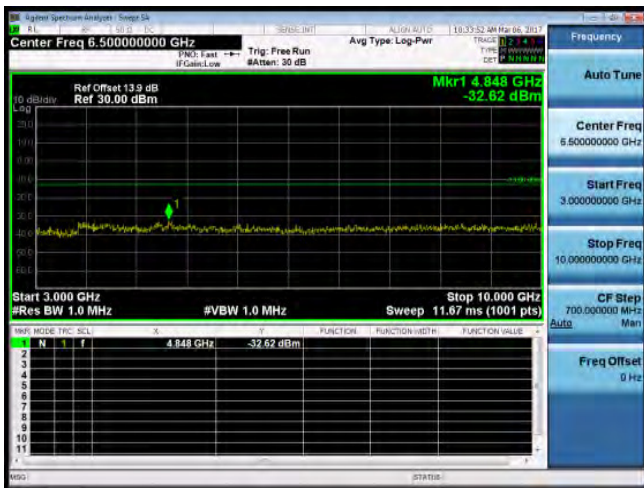

30MHz-3GHz_Band12_1.4MHz_QPSK_1_0_HighCH23173-715.3

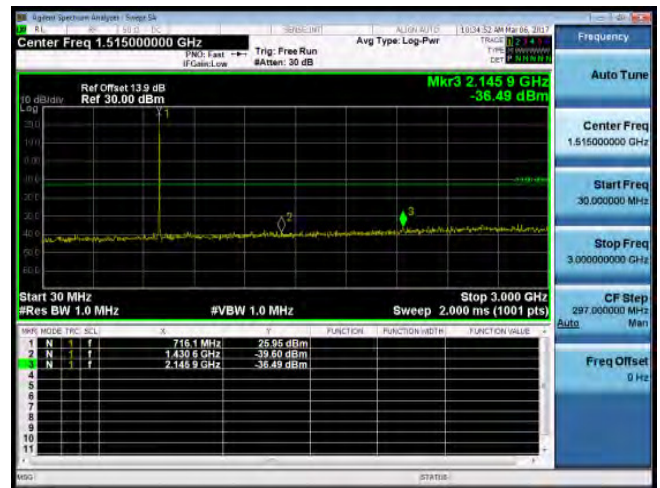

30MHz-3GHz_Band12_1.4MHz_QPSK_1_0_MidCH23095-707.5

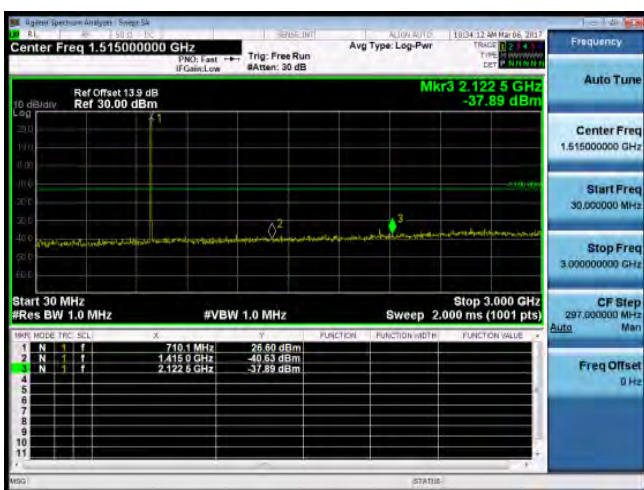

3GHz-10GHz_Band12_1.4MHz_QPSK_1_0_HighCH23173-715.3

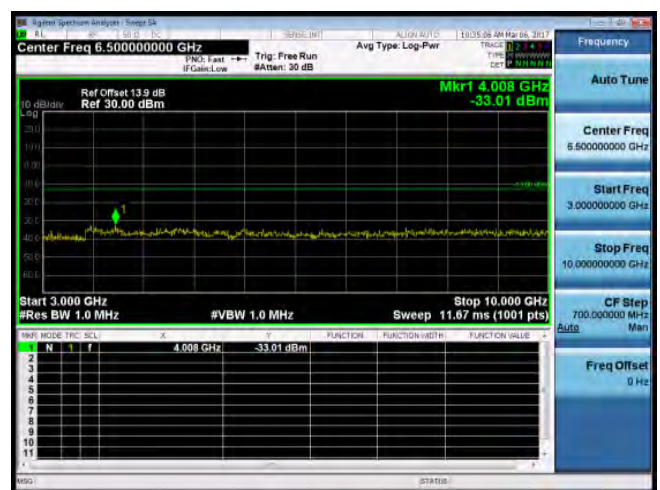

Unless otherwise stated the results shown in this test report refer only to the sample(s) tested and such sample(s) are retained for 90 days only. 除非另有說明，此報告結果僅對測試之樣品負責，同時此樣品僅保留90天。本報告未經本公司書面許可，不可部份複製。

This document is issued by the Company subject to its General Conditions of Service printed overleaf, available on request or accessible at www.sgs.com/terms_and_conditions.htm and, for electronic format documents, subject to Terms and Conditions for Electronic Documents at www.sgs.com/terms_e-document.htm. Attention is drawn to the limitation of liability, indemnification and jurisdiction issues defined therein. Any holder of this document is advised that information contained hereon reflects the Company's findings at the time of its intervention only and within the limits of Client's instructions, if any. The Company's sole responsibility is to its Client and this document does not exonerate parties to a transaction from exercising all their rights and obligations under the transaction documents. This document cannot be reproduced except in full, without prior written approval of the Company. Any unauthorized alteration, forgery or falsification of the content or appearance of this document is unlawful and offenders may be prosecuted to the fullest extent of the law.

30MHz-3GHz_Band12_3MHz_QPSK_1_0_LowCH23025-700.5

3GHz-10GHz_Band12_3MHz_QPSK_1_0_MidCH23095-707.5

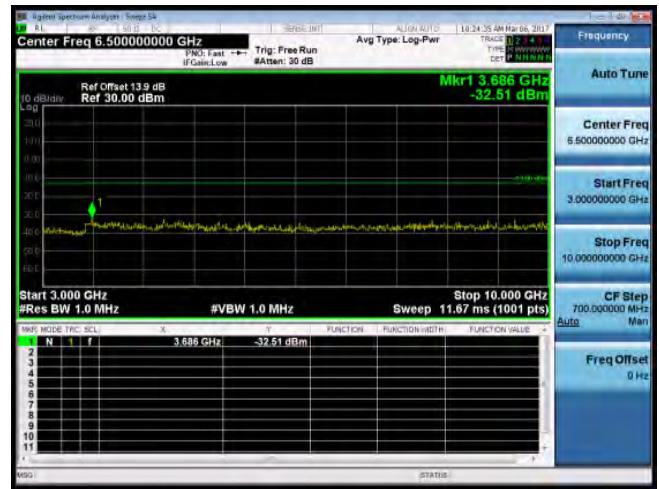
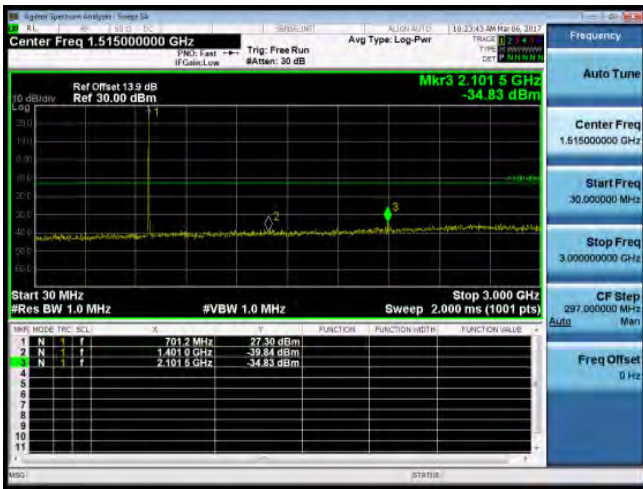

3GHz-10GHz_Band12_3MHz_QPSK_1_0_LowCH23025-700.5

30MHz-3GHz_Band12_3MHz_QPSK_1_0_HighCH23165-714.5

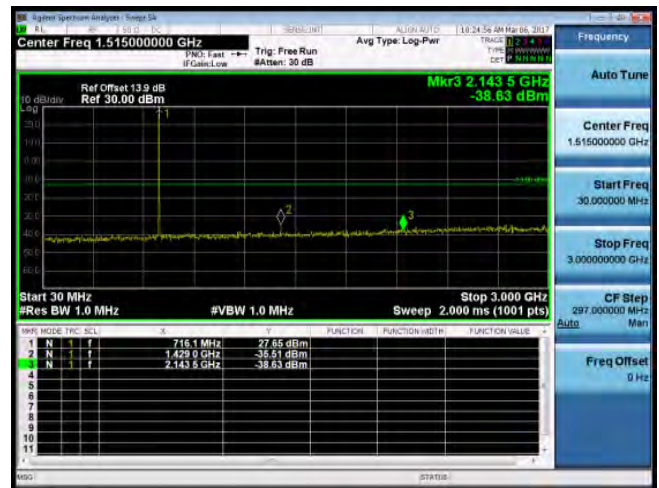
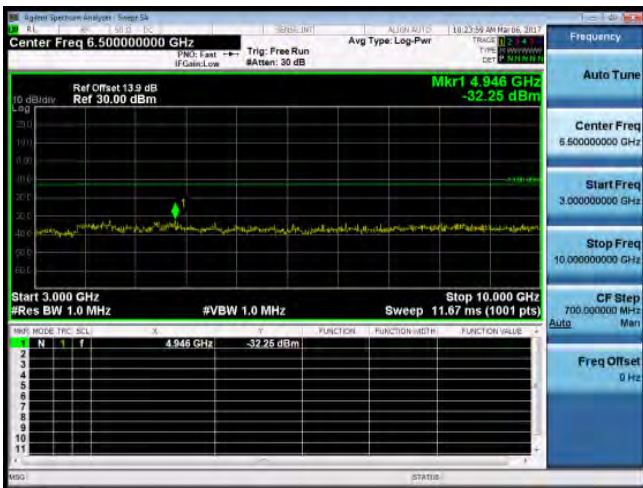

30MHz-3GHz_Band12_3MHz_QPSK_1_0_MidCH23095-707.5

3GHz-10GHz_Band12_3MHz_QPSK_1_0_HighCH23165-714.5

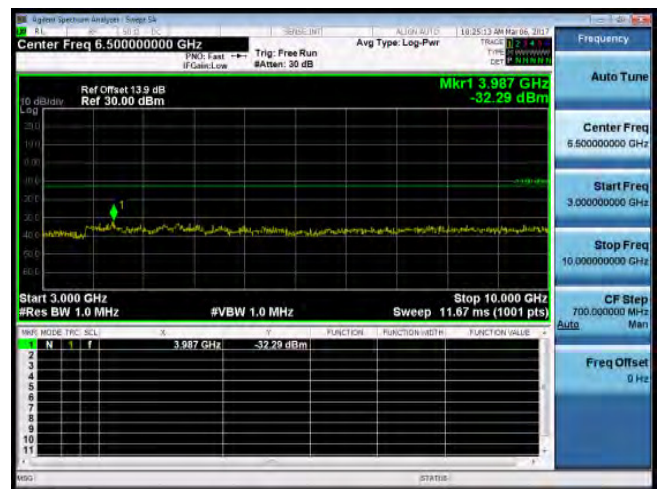
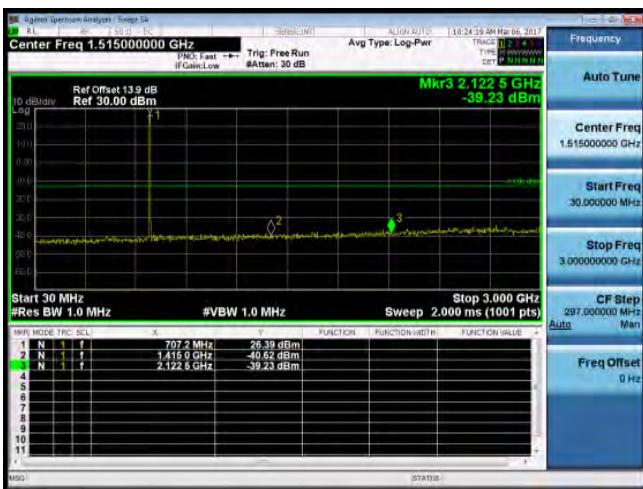

Unless otherwise stated the results shown in this test report refer only to the sample(s) tested and such sample(s) are retained for 90 days only. 除非另有說明，此報告結果僅對測試之樣品負責，同時此樣品僅保留90天。本報告未經本公司書面許可，不可部份複製。

This document is issued by the Company subject to its General Conditions of Service printed overleaf, available on request or accessible at www.sgs.com/terms_and_conditions.htm and, for electronic format documents, subject to Terms and Conditions for Electronic Documents at www.sgs.com/terms_e-document.htm. Attention is drawn to the limitation of liability, indemnification and jurisdiction issues defined therein. Any holder of this document is advised that information contained hereon reflects the Company's findings at the time of its intervention only and within the limits of Client's instructions, if any. The Company's sole responsibility is to its Client and this document does not exonerate parties to a transaction from exercising all their rights and obligations under the transaction documents. This document cannot be reproduced except in full, without prior written approval of the Company. Any unauthorized alteration, forgery or falsification of the content or appearance of this document is unlawful and offenders may be prosecuted to the fullest extent of the law.

30MHz-3GHz_Band12_5MHz_QPSK_1_0_LowCH23035-701.5

3GHz-10GHz_Band12_5MHz_QPSK_1_0_MidCH23095-707.5

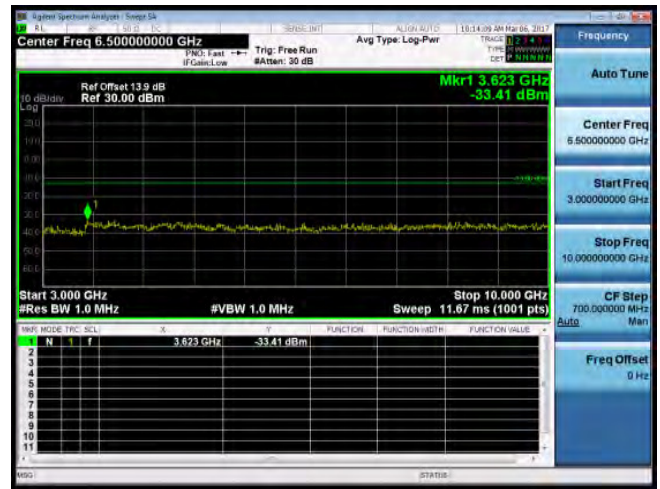
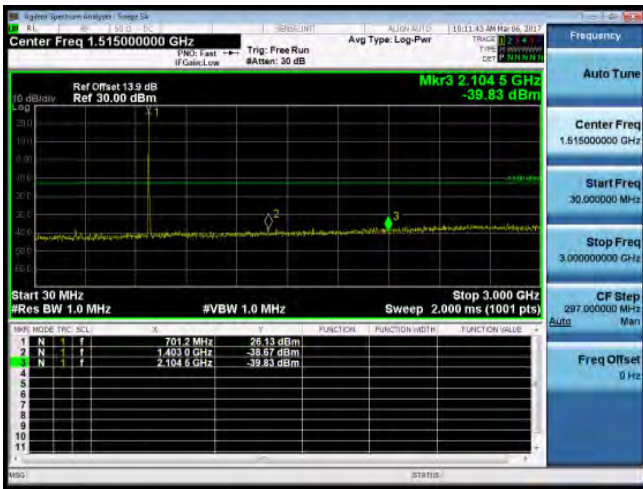

3GHz-10GHz_Band12_5MHz_QPSK_1_0_LowCH23035-701.5

30MHz-3GHz_Band12_5MHz_QPSK_1_0_HighCH23155-713.5

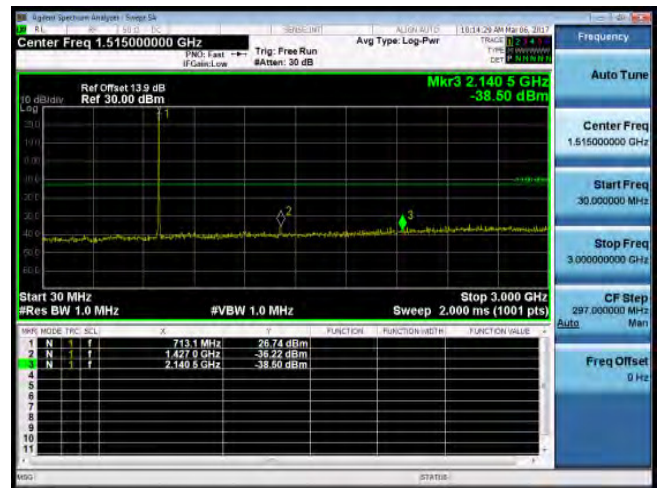
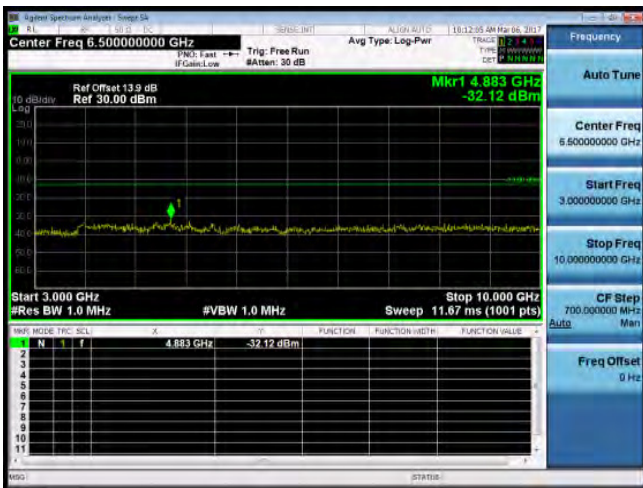

30MHz-3GHz_Band12_5MHz_QPSK_1_0_MidCH23095-707.5

3GHz-10GHz_Band12_5MHz_QPSK_1_0_HighCH23155-713.5

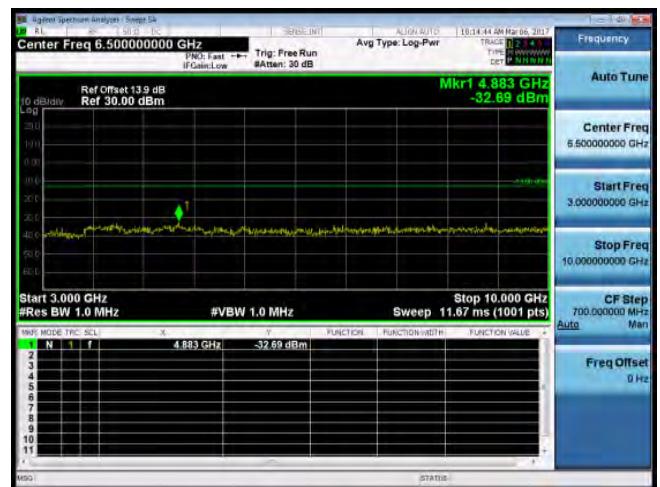
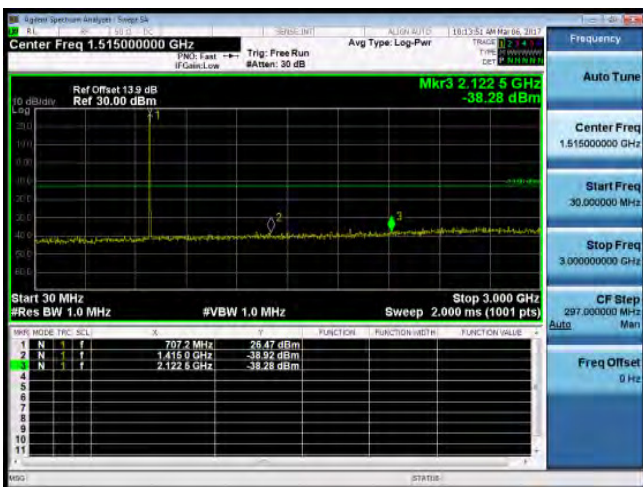

Unless otherwise stated the results shown in this test report refer only to the sample(s) tested and such sample(s) are retained for 90 days only. 除非另有說明，此報告結果僅對測試之樣品負責，同時此樣品僅保留90天。本報告未經本公司書面許可，不可部份複製。

This document is issued by the Company subject to its General Conditions of Service printed overleaf, available on request or accessible at www.sgs.com/terms_and_conditions.htm and, for electronic format documents, subject to Terms and Conditions for Electronic Documents at www.sgs.com/terms_e-document.htm. Attention is drawn to the limitation of liability, indemnification and jurisdiction issues defined therein. Any holder of this document is advised that information contained hereon reflects the Company's findings at the time of its intervention only and within the limits of Client's instructions, if any. The Company's sole responsibility is to its Client and this document does not exonerate parties to a transaction from exercising all their rights and obligations under the transaction documents. This document cannot be reproduced except in full, without prior written approval of the Company. Any unauthorized alteration, forgery or falsification of the content or appearance of this document is unlawful and offenders may be prosecuted to the fullest extent of the law.

30MHz-3GHz_Band12_10MHz_QPSK_1_0_LowCH23060-704

3GHz-10GHz_Band12_10MHz_QPSK_1_0_MidCH23095-707.5

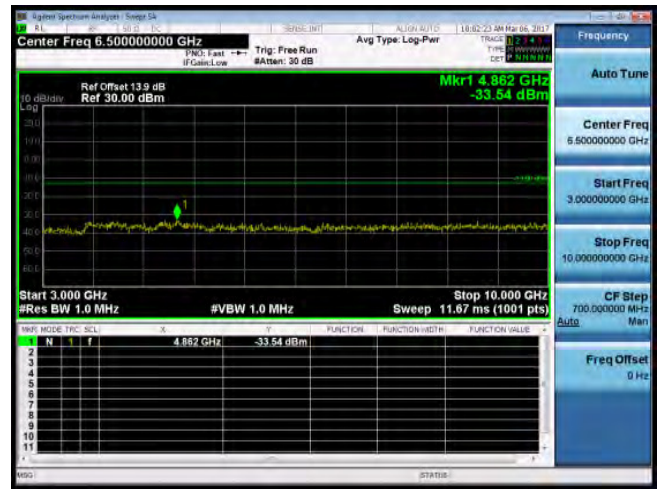
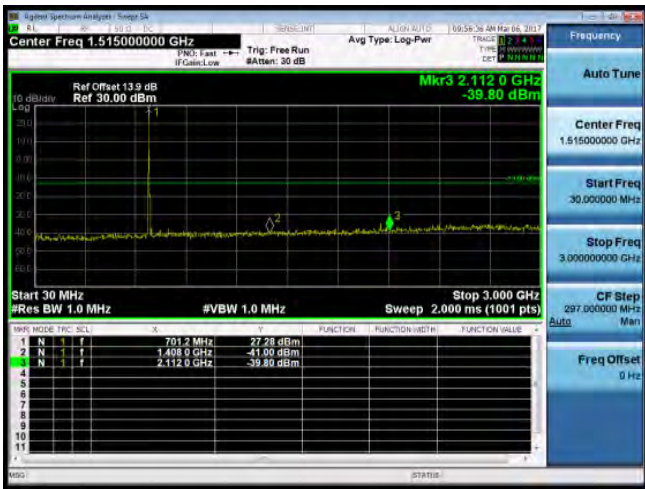

3GHz-10GHz_Band12_10MHz_QPSK_1_0_LowCH23060-704

30MHz-3GHz_Band12_10MHz_QPSK_1_0_HighCH23130-711

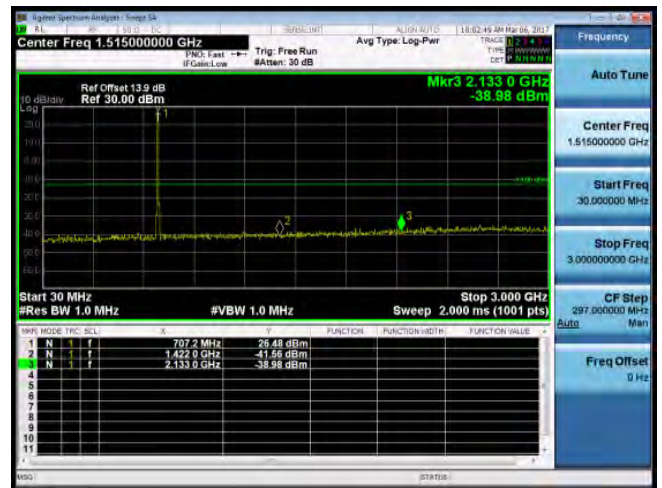
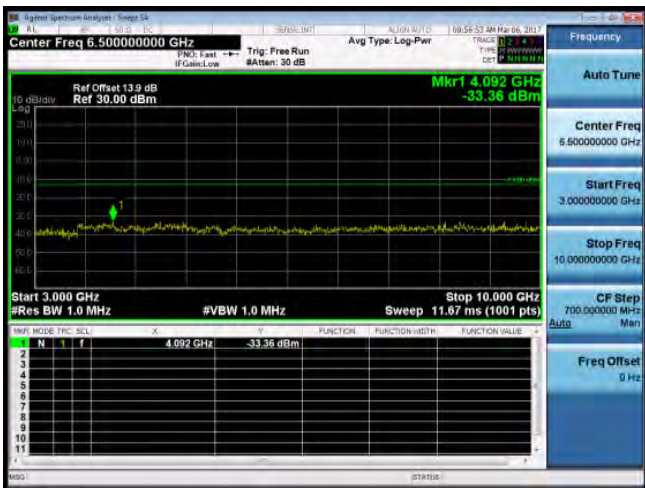

30MHz-3GHz_Band12_10MHz_QPSK_1_0_MidCH23095-707.5

3GHz-10GHz_Band12_10MHz_QPSK_1_0_HighCH23130-711

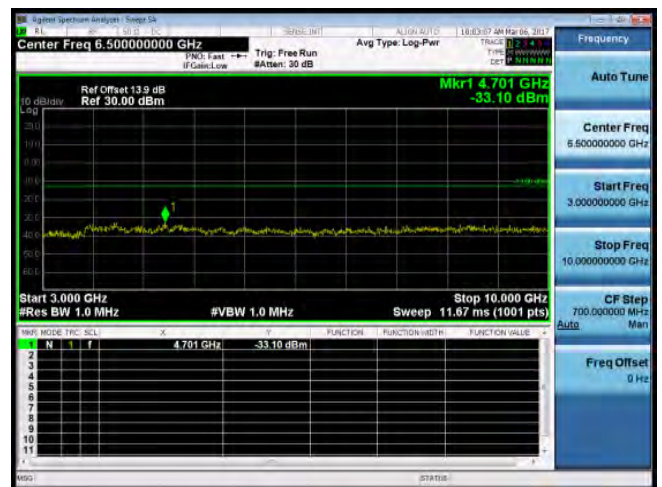
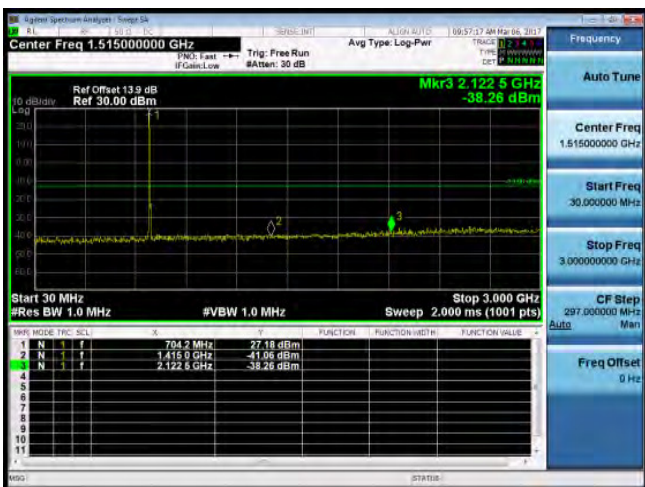

Unless otherwise stated the results shown in this test report refer only to the sample(s) tested and such sample(s) are retained for 90 days only. 除非另有說明，此報告結果僅對測試之樣品負責，同時此樣品僅保留90天。本報告未經本公司書面許可，不可部份複製。

This document is issued by the Company subject to its General Conditions of Service printed overleaf, available on request or accessible at www.sgs.com/terms_and_conditions.htm and, for electronic format documents, subject to Terms and Conditions for Electronic Documents at www.sgs.com/terms_e-document.htm. Attention is drawn to the limitation of liability, indemnification and jurisdiction issues defined therein. Any holder of this document is advised that information contained hereon reflects the Company's findings at the time of its intervention only and within the limits of Client's instructions, if any. The Company's sole responsibility is to its Client and this document does not exonerate parties to a transaction from exercising all their rights and obligations under the transaction documents. This document cannot be reproduced except in full, without prior written approval of the Company. Any unauthorized alteration, forgery or falsification of the content or appearance of this document is unlawful and offenders may be prosecuted to the fullest extent of the law.

30MHz-3GHz_Band25_1.4MHz_QPSK_1_0_LowCH26047-1850.7

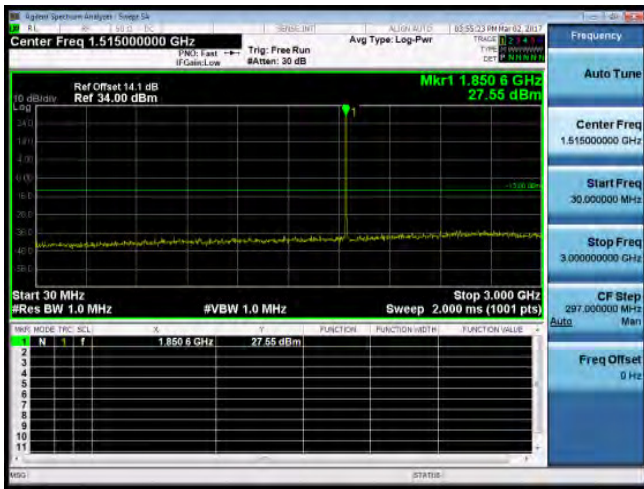

3GHz-10GHz_Band25_1.4MHz_QPSK_1_0_MidCH26365-1882.5

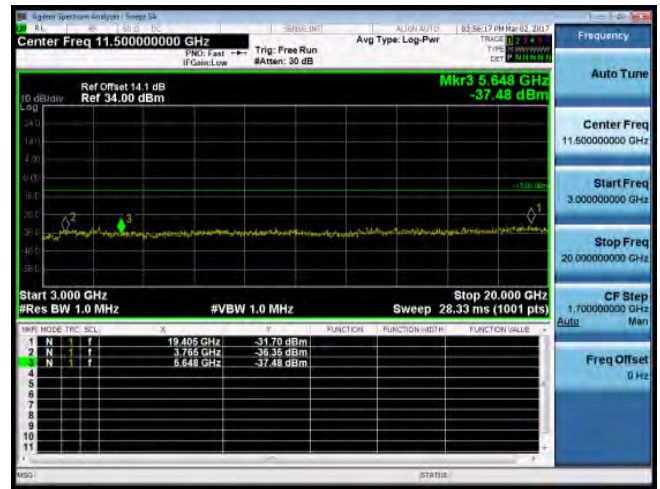

3GHz-10GHz_Band25_1.4MHz_QPSK_1_0_LowCH26047-1850.7

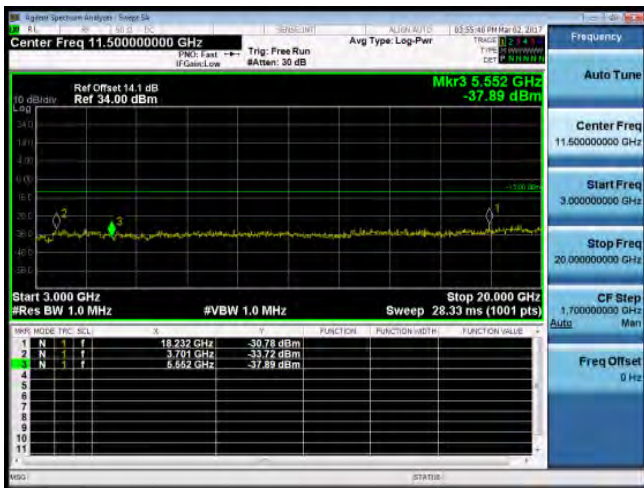

30MHz-3GHz_Band25_1.4MHz_QPSK_1_0_HighCH26683-1914.3

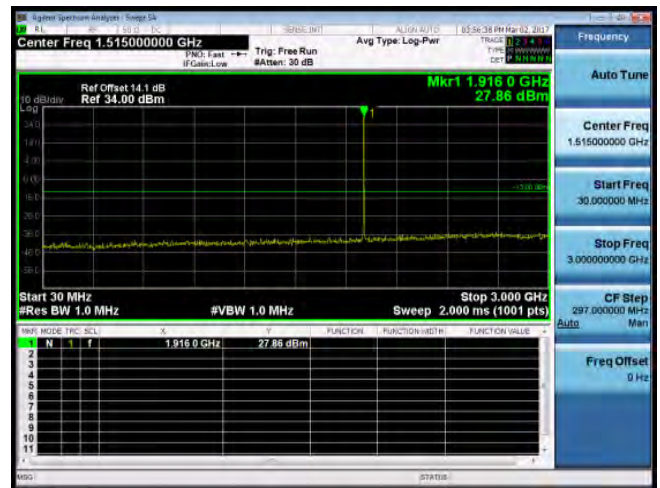

30MHz-3GHz_Band25_1.4MHz_QPSK_1_0_MidCH26365-1882.5

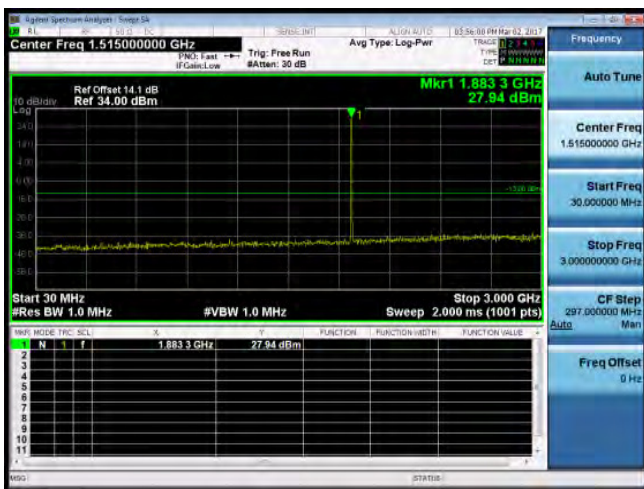

3GHz-10GHz_Band25_1.4MHz_QPSK_1_0_HighCH26683-1914.3

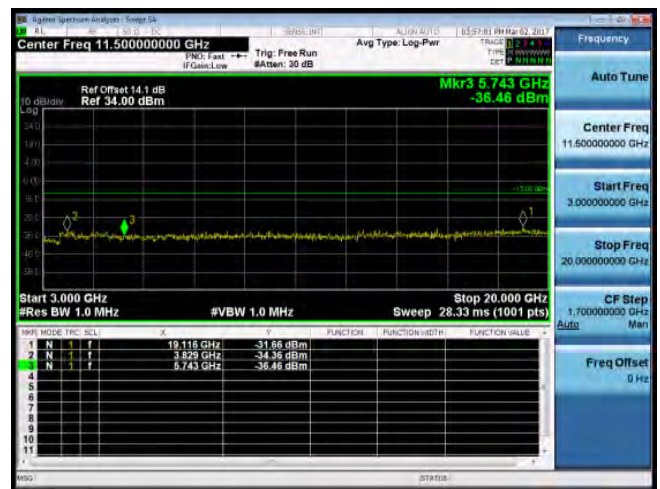

Unless otherwise stated the results shown in this test report refer only to the sample(s) tested and such sample(s) are retained for 90 days only.
除非另有說明，此報告結果僅對測試之樣品負責，同時此樣品僅保留90天。本報告未經本公司書面許可，不可部份複製。

This document is issued by the Company subject to its General Conditions of Service printed overleaf, available on request or accessible at www.sgs.com/terms_and_conditions.htm and, for electronic format documents, subject to Terms and Conditions for Electronic Documents at www.sgs.com/terms_e-document.htm. Attention is drawn to the limitation of liability, indemnification and jurisdiction issues defined therein. Any holder of this document is advised that information contained hereon reflects the Company's findings at the time of its intervention only and within the limits of Client's instructions, if any. The Company's sole responsibility is to its Client and this document does not exonerate parties to a transaction from exercising all their rights and obligations under the transaction documents. This document cannot be reproduced except in full, without prior written approval of the Company. Any unauthorized alteration, forgery or falsification of the content or appearance of this document is unlawful and offenders may be prosecuted to the fullest extent of the law.

30MHz~3GHz_Band25_3MHz_QPSK_1_0_LowCH26055-1851.5

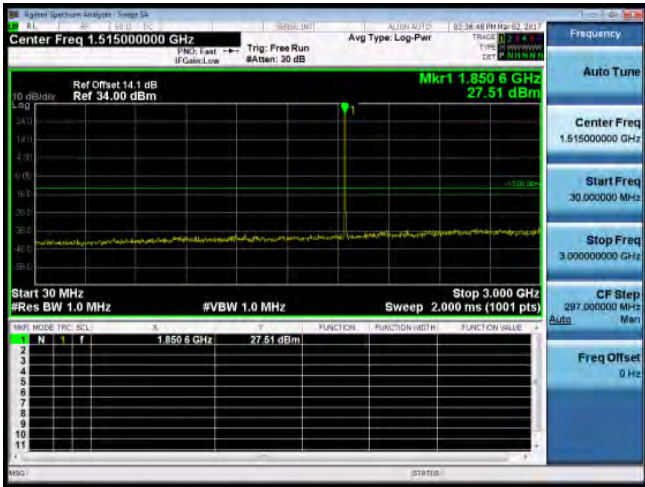

3GHz~10GHz_Band25_3MHz_QPSK_1_0_MidCH26365-1882.5

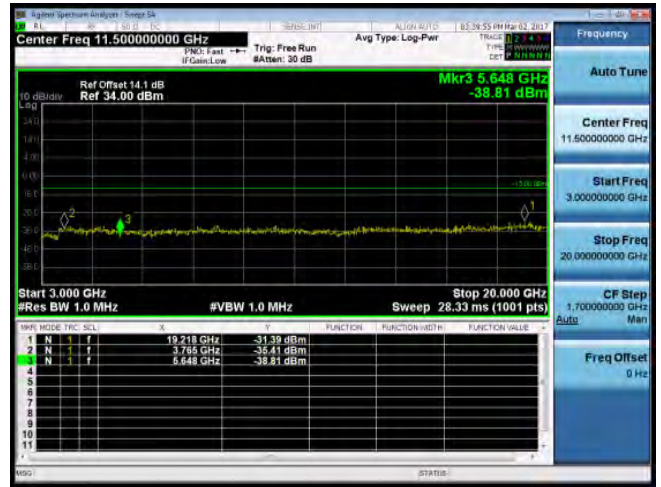

3GHz~10GHz_Band25_3MHz_QPSK_1_0_LowCH26055-1851.5

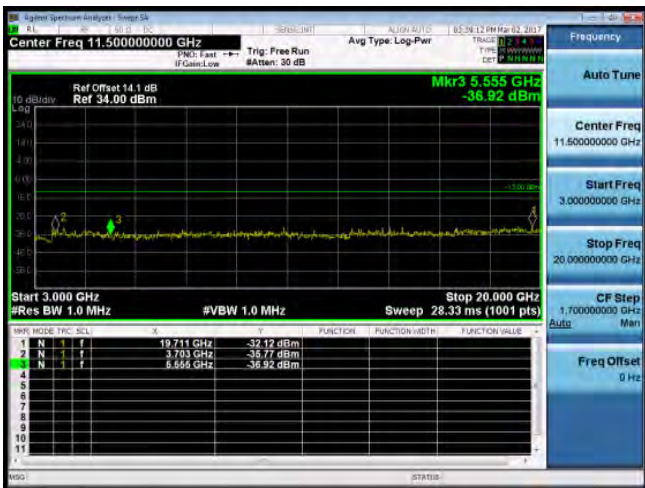

30MHz~3GHz_Band25_3MHz_QPSK_1_0_HighCH26675-1913.5

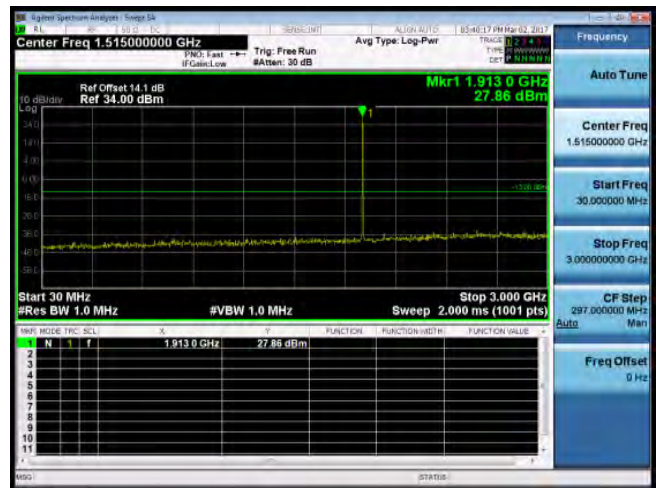

30MHz~3GHz_Band25_3MHz_QPSK_1_0_MidCH26365-1882.5

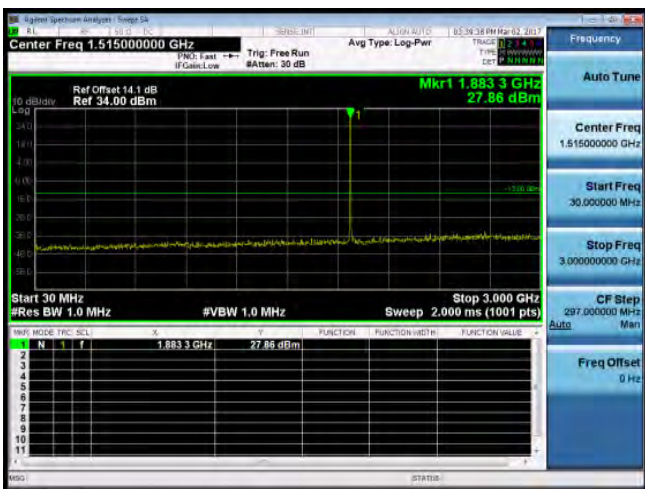

3GHz~10GHz_Band25_3MHz_QPSK_1_0_HighCH26675-1913.5

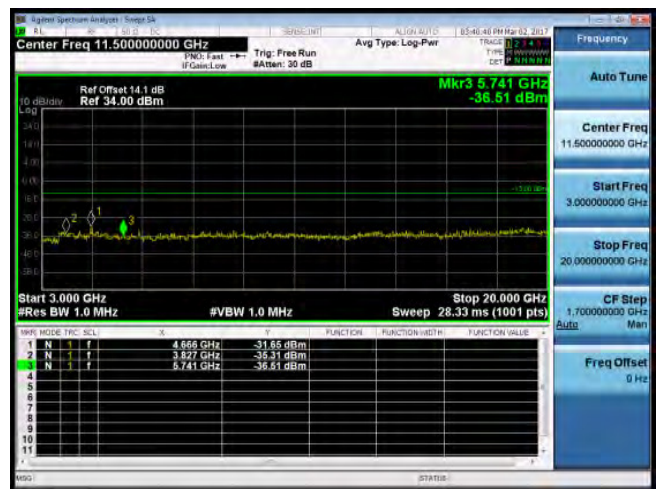

Unless otherwise stated the results shown in this test report refer only to the sample(s) tested and such sample(s) are retained for 90 days only. 除非另有說明，此報告結果僅對測試之樣品負責，同時此樣品僅保留90天。本報告未經本公司書面許可，不可部份複製。

This document is issued by the Company subject to its General Conditions of Service printed overleaf, available on request or accessible at www.sgs.com/terms_and_conditions.htm and, for electronic format documents, subject to Terms and Conditions for Electronic Documents at www.sgs.com/terms_e-document.htm. Attention is drawn to the limitation of liability, indemnification and jurisdiction issues defined therein. Any holder of this document is advised that information contained hereon reflects the Company's findings at the time of its intervention only and within the limits of Client's instructions, if any. The Company's sole responsibility is to its Client and this document does not exonerate parties to a transaction from exercising all their rights and obligations under the transaction documents. This document cannot be reproduced except in full, without prior written approval of the Company. Any unauthorized alteration, forgery or falsification of the content or appearance of this document is unlawful and offenders may be prosecuted to the fullest extent of the law.

30MHz~3GHz_Band25_5MHz_QPSK_1_0_LowCH26065-1852.5

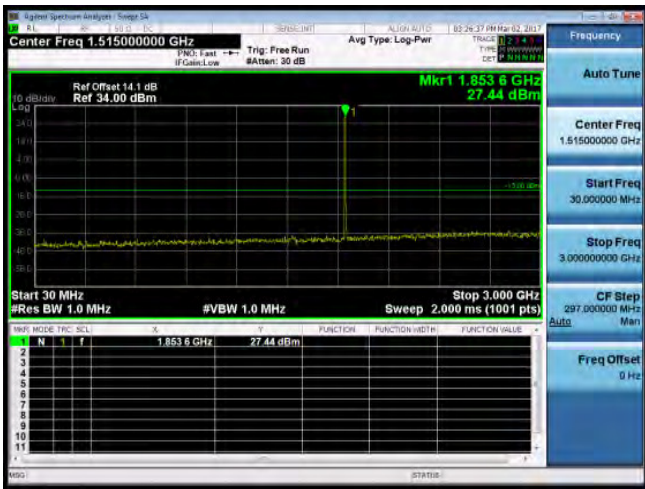

3GHz~10GHz_Band25_5MHz_QPSK_1_0_MidCH26365-1882.5

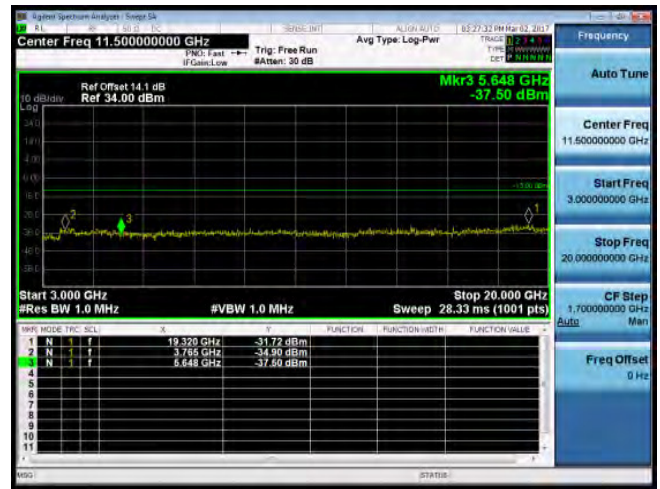

3GHz~10GHz_Band25_5MHz_QPSK_1_0_LowCH26065-1852.5

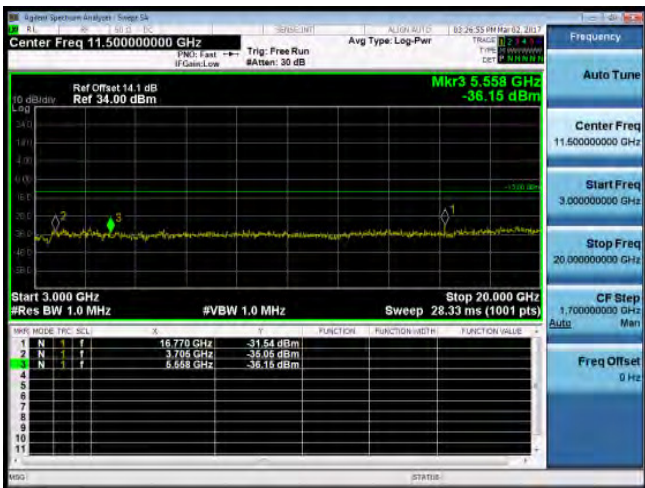

30MHz~3GHz_Band25_5MHz_QPSK_1_0_HighCH26665-1912.5

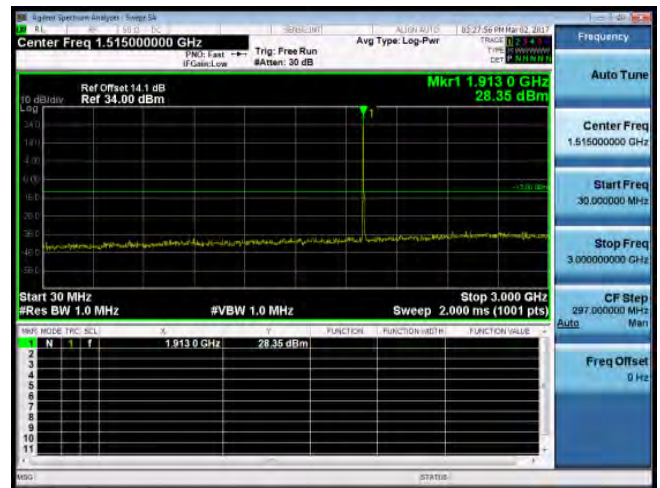

30MHz~3GHz_Band25_5MHz_QPSK_1_0_MidCH26365-1882.5

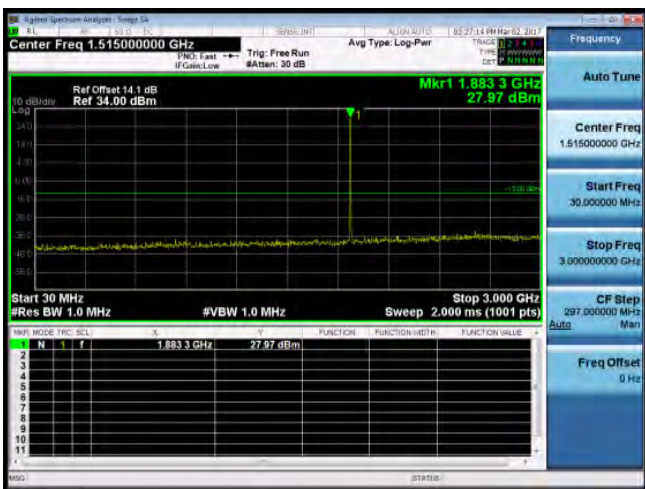

3GHz~10GHz_Band25_5MHz_QPSK_1_0_HighCH26665-1912.5

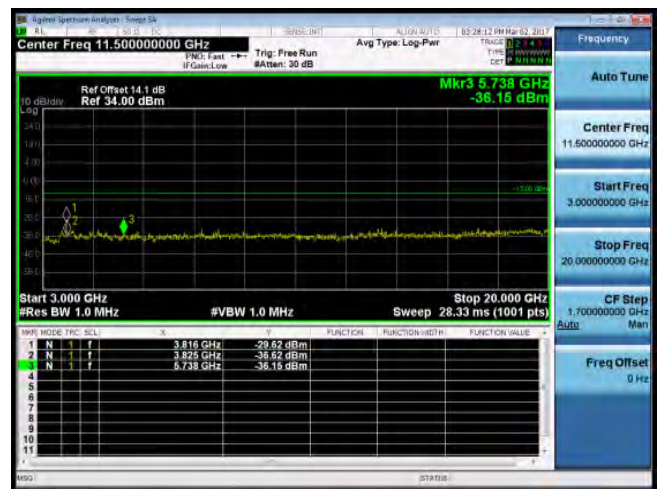

Unless otherwise stated the results shown in this test report refer only to the sample(s) tested and such sample(s) are retained for 90 days only.
除非另有說明，此報告結果僅對測試之樣品負責，同時此樣品僅保留90天。本報告未經本公司書面許可，不可部份複製。

This document is issued by the Company subject to its General Conditions of Service printed overleaf, available on request or accessible at www.sgs.com/terms_and_conditions.htm and, for electronic format documents, subject to Terms and Conditions for Electronic Documents at www.sgs.com/terms_e-document.htm. Attention is drawn to the limitation of liability, indemnification and jurisdiction issues defined therein. Any holder of this document is advised that information contained hereon reflects the Company's findings at the time of its intervention only and within the limits of Client's instructions, if any. The Company's sole responsibility is to its Client and this document does not exonerate parties to a transaction from exercising all their rights and obligations under the transaction documents. This document cannot be reproduced except in full, without prior written approval of the Company. Any unauthorized alteration, forgery or falsification of the content or appearance of this document is unlawful and offenders may be prosecuted to the fullest extent of the law.

30MHz-3GHz_Band25_10MHz_QPSK_1_0_LowCH26090-1855

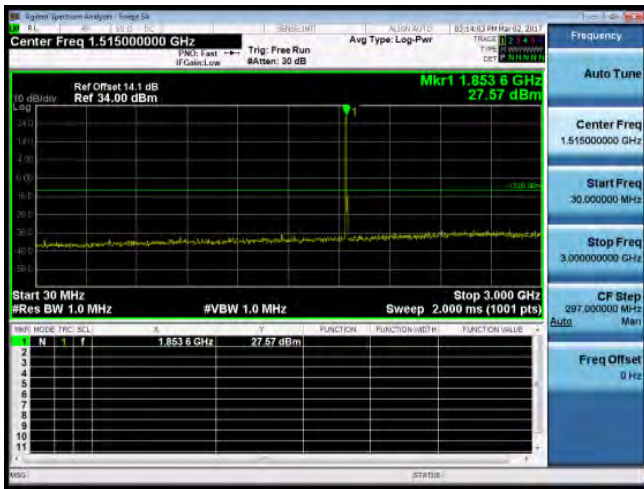

3GHz-10GHz_Band25_10MHz_QPSK_1_0_MidCH26365-1882.5

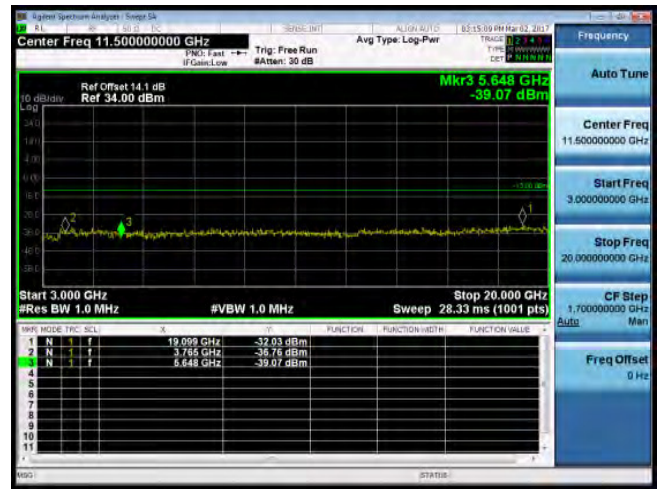

3GHz-10GHz_Band25_10MHz_QPSK_1_0_LowCH26090-1855

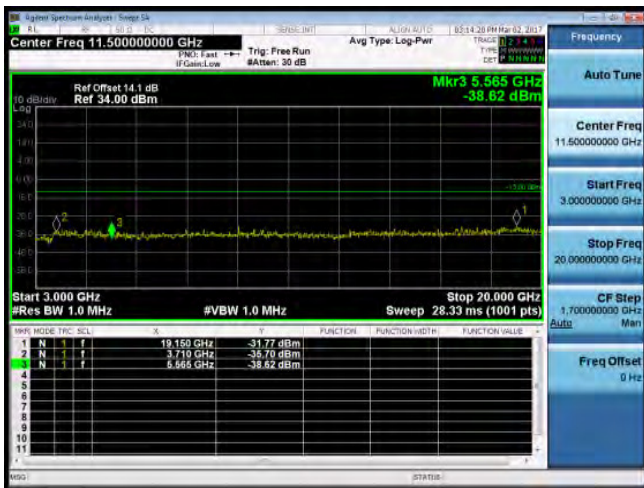

30MHz-3GHz_Band25_10MHz_QPSK_1_0_HighCH26640-1910

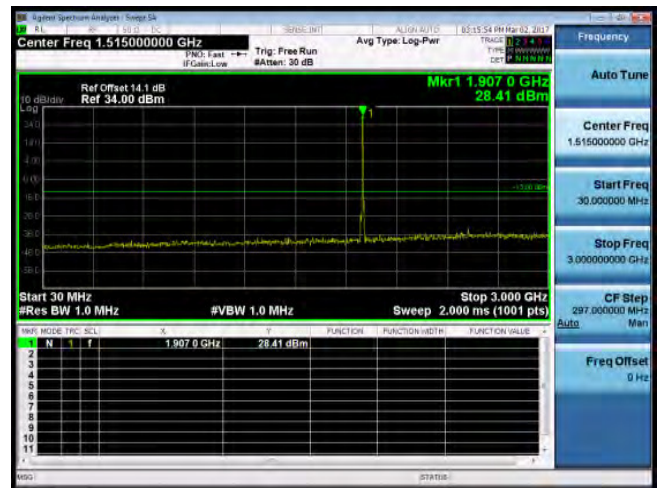

30MHz-3GHz_Band25_10MHz_QPSK_1_0_MidCH26365-1882.5

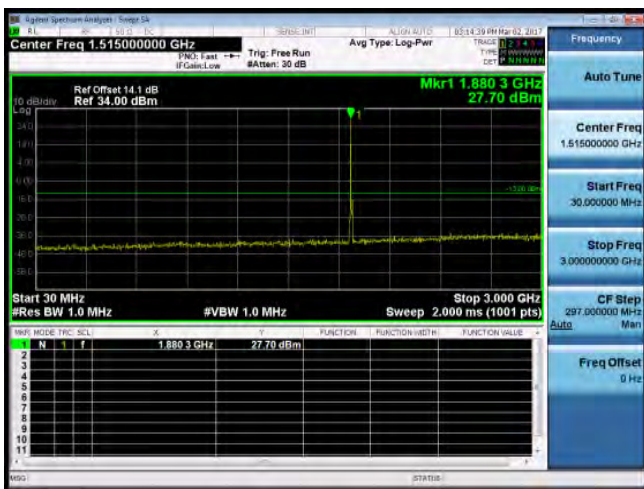

3GHz-10GHz_Band25_10MHz_QPSK_1_0_HighCH26640-1910

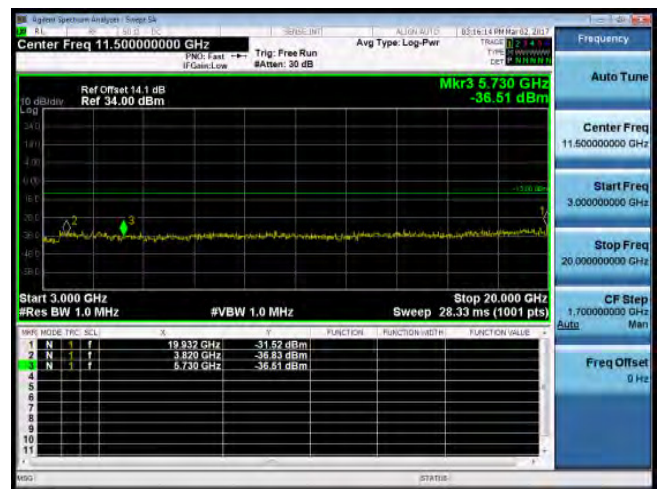

Unless otherwise stated the results shown in this test report refer only to the sample(s) tested and such sample(s) are retained for 90 days only.
除非另有說明，此報告結果僅對測試之樣品負責，同時此樣品僅保留90天。本報告未經本公司書面許可，不可部份複製。

This document is issued by the Company subject to its General Conditions of Service printed overleaf, available on request or accessible at www.sgs.com/terms_and_conditions.htm and, for electronic format documents, subject to Terms and Conditions for Electronic Documents at www.sgs.com/terms_e-document.htm. Attention is drawn to the limitation of liability, indemnification and jurisdiction issues defined therein. Any holder of this document is advised that information contained hereon reflects the Company's findings at the time of its intervention only and within the limits of Client's instructions, if any. The Company's sole responsibility is to its Client and this document does not exonerate parties to a transaction from exercising all their rights and obligations under the transaction documents. This document cannot be reproduced except in full, without prior written approval of the Company. Any unauthorized alteration, forgery or falsification of the content or appearance of this document is unlawful and offenders may be prosecuted to the fullest extent of the law.

30MHz-3GHz_Band25_15MHz_QPSK_1_0_LowCH26115-1857.5

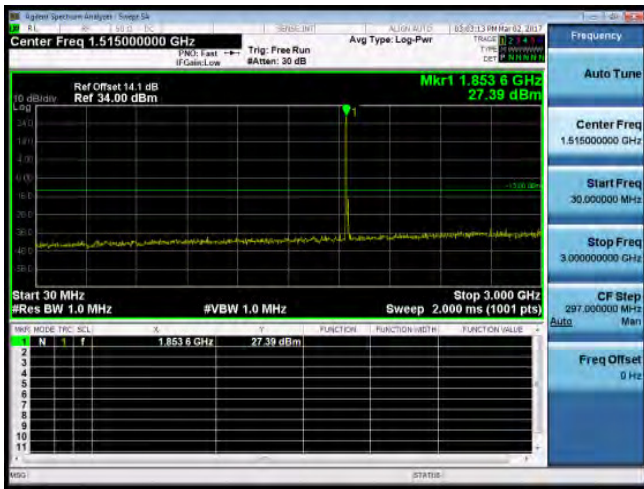

3GHz-10GHz_Band25_15MHz_QPSK_1_0_MidCH26365-1882.5

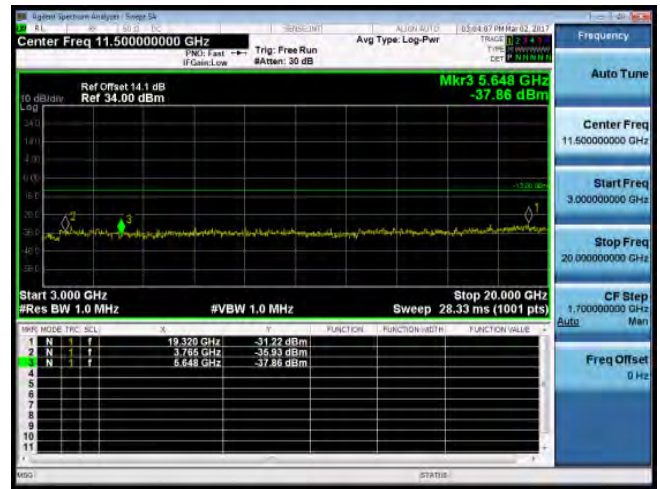

3GHz-10GHz_Band25_15MHz_QPSK_1_0_LowCH26115-1857.5

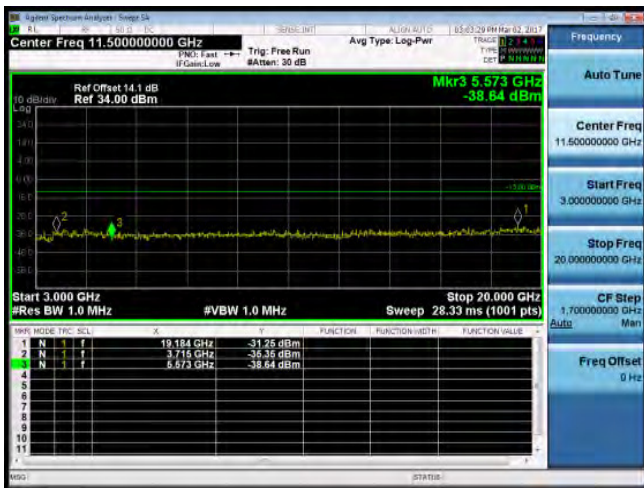

30MHz-3GHz_Band25_15MHz_QPSK_1_0_MidCH26365-1882.5

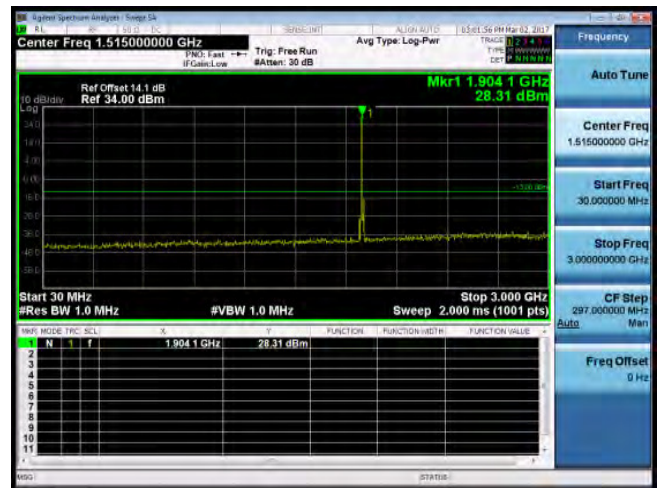

30MHz-3GHz_Band25_15MHz_QPSK_1_0_MidCH26365-1882.5

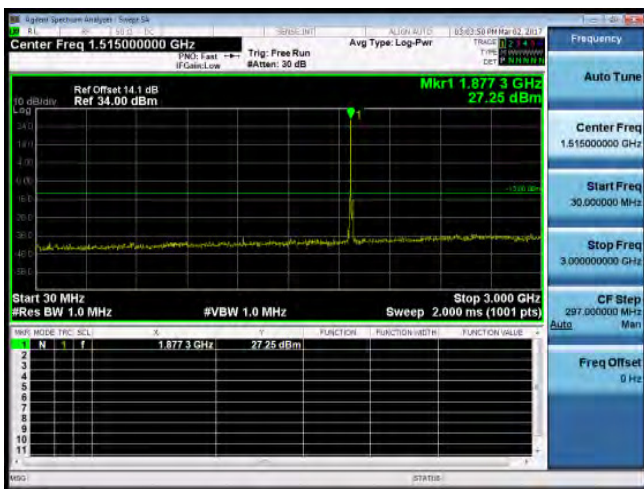

30MHz-3GHz_Band25_15MHz_QPSK_1_0_HighCH26615-1907.5

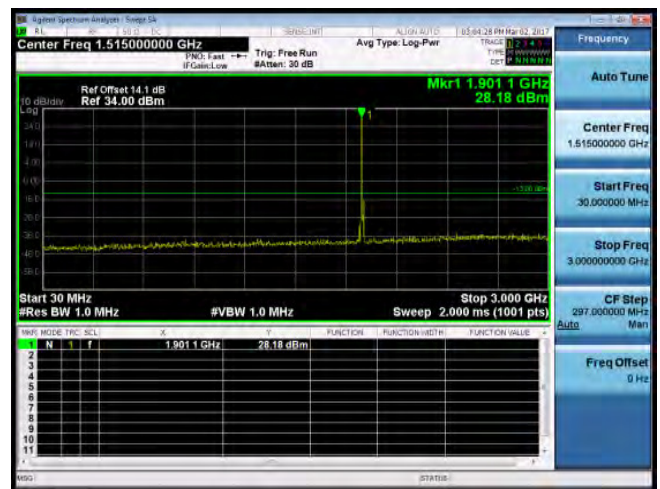

Unless otherwise stated the results shown in this test report refer only to the sample(s) tested and such sample(s) are retained for 90 days only. 除非另有說明，此報告結果僅對測試之樣品負責，同時此樣品僅保留90天。本報告未經本公司書面許可，不可部份複製。

This document is issued by the Company subject to its General Conditions of Service printed overleaf, available on request or accessible at www.sgs.com/terms_and_conditions.htm and, for electronic format documents, subject to Terms and Conditions for Electronic Documents at www.sgs.com/terms_e-document.htm. Attention is drawn to the limitation of liability, indemnification and jurisdiction issues defined therein. Any holder of this document is advised that information contained hereon reflects the Company's findings at the time of its intervention only and within the limits of Client's instructions, if any. The Company's sole responsibility is to its Client and this document does not exonerate parties to a transaction from exercising all their rights and obligations under the transaction documents. This document cannot be reproduced except in full, without prior written approval of the Company. Any unauthorized alteration, forgery or falsification of the content or appearance of this document is unlawful and offenders may be prosecuted to the fullest extent of the law.

3GHz-10GHz_Band25_15MHz_QPSK_1_0_HighCH26615-1907.5

30MHz-3GHz_Band25_20MHz_QPSK_1_0_MidCH26365-1882.5

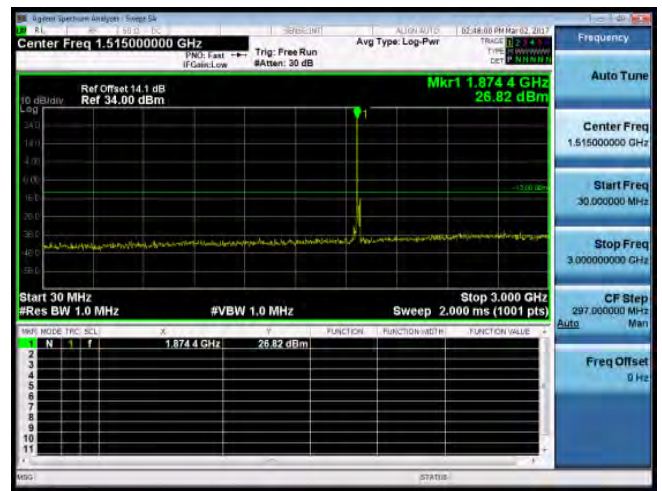
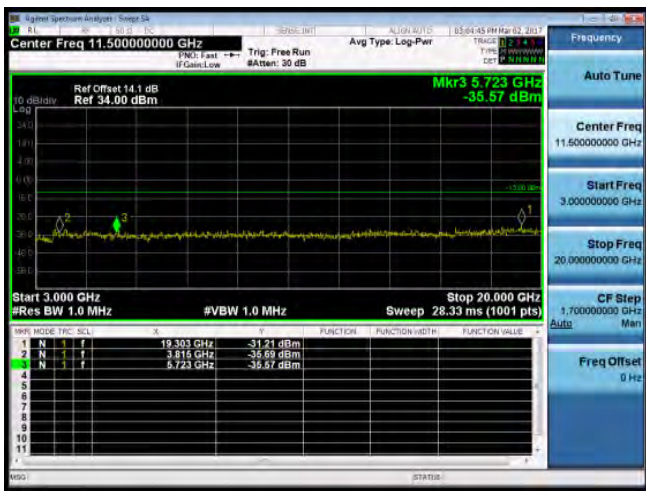

30MHz-3GHz_Band25_20MHz_QPSK_1_0_LowCH26140-1860

3GHz-10GHz_Band25_20MHz_QPSK_1_0_MidCH26365-1882.5

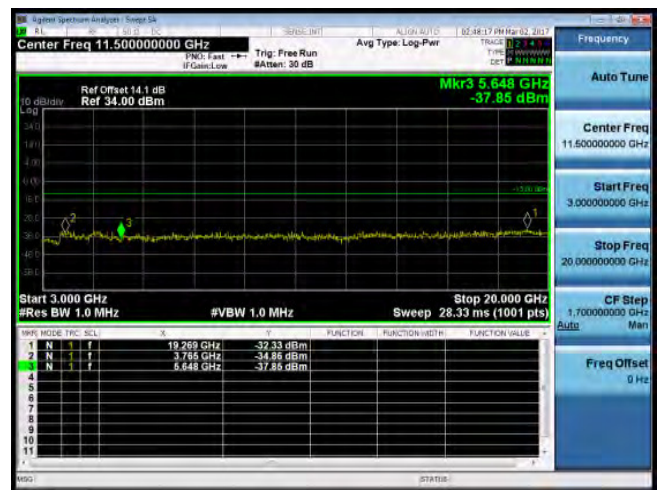
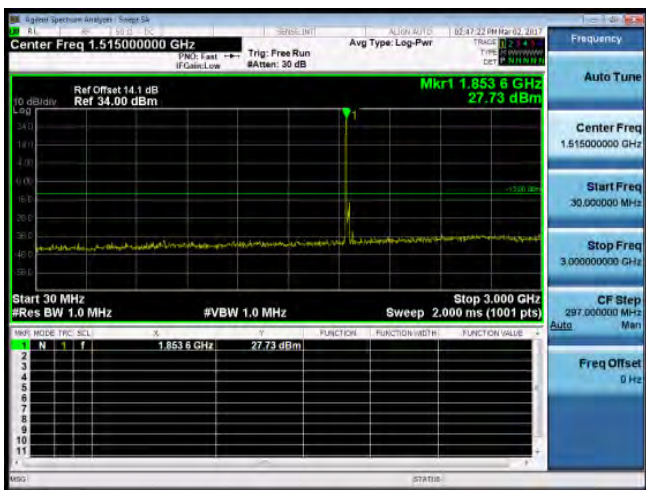

3GHz-10GHz_Band25_20MHz_QPSK_1_0_LowCH26140-1860

30MHz-3GHz_Band25_20MHz_QPSK_1_0_HighCH26590-1905

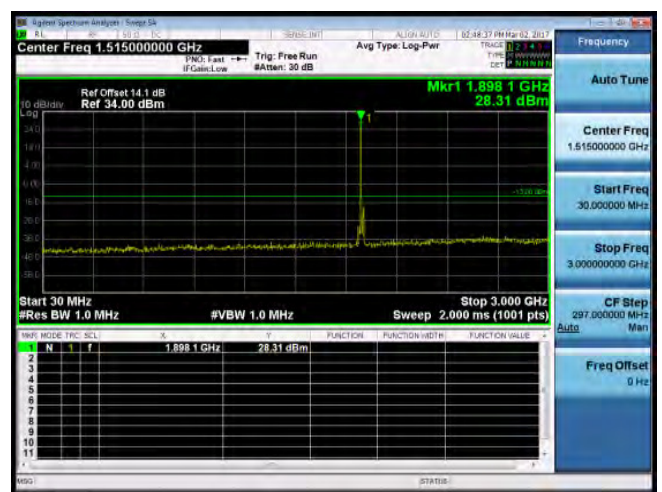
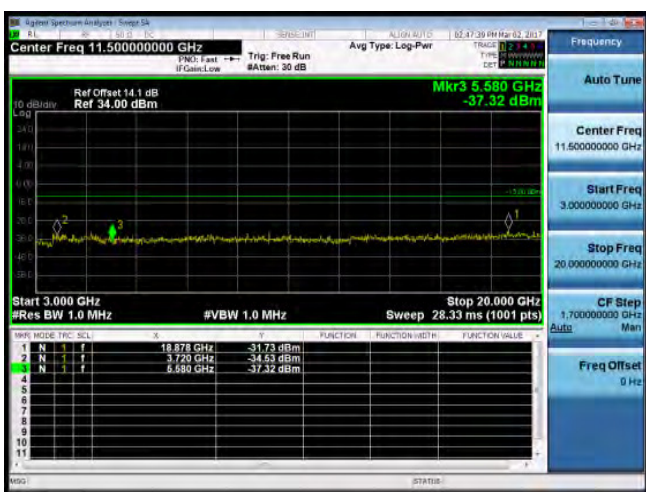

Unless otherwise stated the results shown in this test report refer only to the sample(s) tested and such sample(s) are retained for 90 days only.

除非另有說明，此報告結果僅對測試之樣品負責，同時此樣品僅保留90天。本報告未經本公司書面許可，不可部份複製。

This document is issued by the Company subject to its General Conditions of Service printed overleaf, available on request or accessible at www.sgs.com/terms_and_conditions.htm and, for electronic format documents, subject to Terms and Conditions for Electronic Documents at www.sgs.com/terms_e-document.htm. Attention is drawn to the limitation of liability, indemnification and jurisdiction issues defined therein. Any holder of this document is advised that information contained hereon reflects the Company's findings at the time of its intervention only and within the limits of Client's instructions, if any. The Company's sole responsibility is to its Client and this document does not exonerate parties to a transaction from exercising all their rights and obligations under the transaction documents. This document cannot be reproduced except in full, without prior written approval of the Company. Any unauthorized alteration, forgery or falsification of the content or appearance of this document is unlawful and offenders may be prosecuted to the fullest extent of the law.

3GHz-10GHz_Band25_20MHz_QPSK_1_0_HighCH26590-1905

30MHz-3GHz_Band26_1.4MHz_QPSK_1_0_MidCH26865-831.5

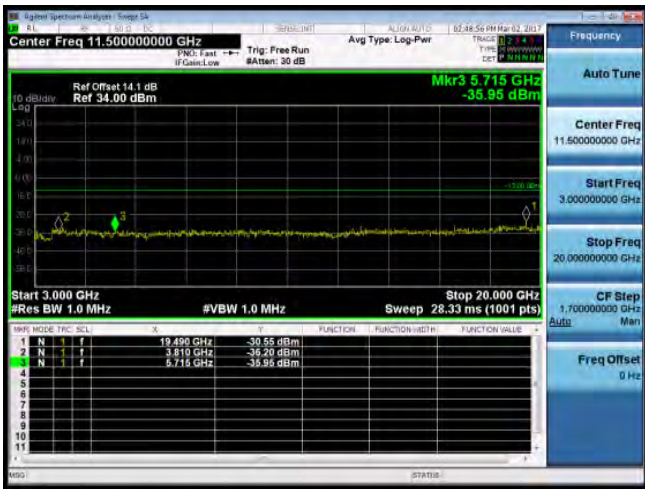

30MHz-3GHz_Band26_1.4MHz_QPSK_1_0_LowCH26697-814.7

3GHz-10GHz_Band26_1.4MHz_QPSK_1_0_MidCH26865-831.5

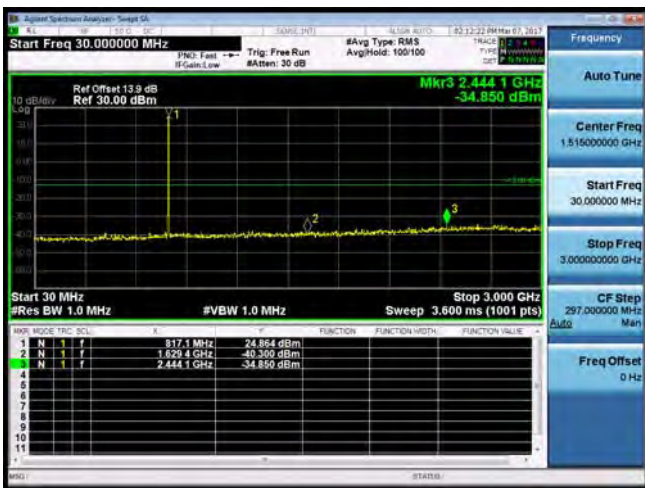

3GHz-10GHz_Band26_1.4MHz_QPSK_1_0_LowCH26697-814.7

30MHz-3GHz_Band26_1.4MHz_QPSK_1_0_HighCH27033-848.3

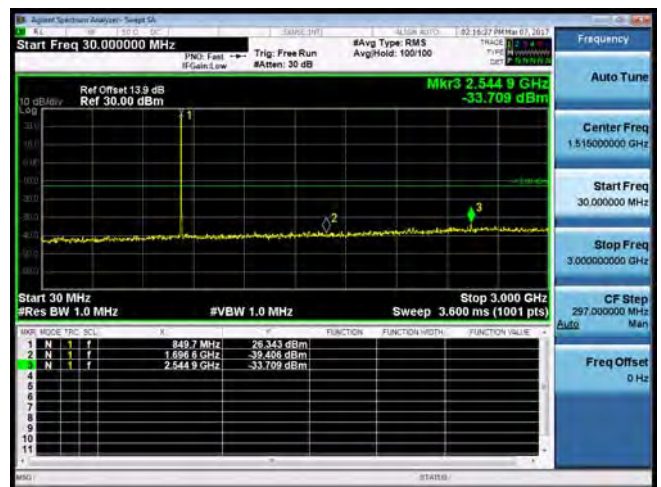
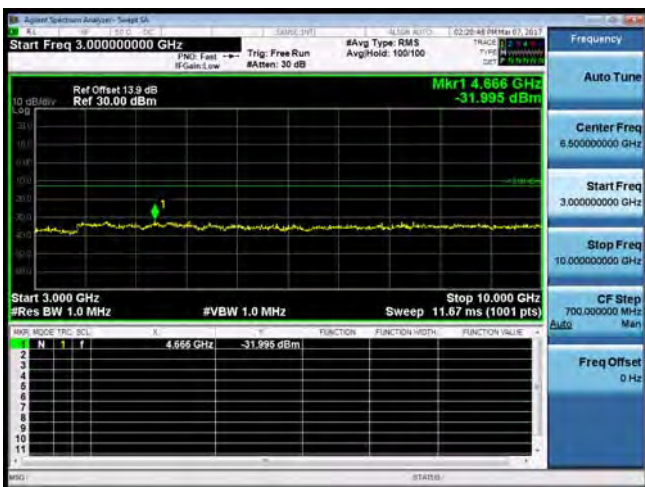

Unless otherwise stated the results shown in this test report refer only to the sample(s) tested and such sample(s) are retained for 90 days only. 除非另有說明，此報告結果僅對測試之樣品負責，同時此樣品僅保留90天。本報告未經本公司書面許可，不可部份複製。

This document is issued by the Company subject to its General Conditions of Service printed overleaf, available on request or accessible at www.sgs.com/terms_and_conditions.htm and, for electronic format documents, subject to Terms and Conditions for Electronic Documents at www.sgs.com/terms_e-document.htm. Attention is drawn to the limitation of liability, indemnification and jurisdiction issues defined therein. Any holder of this document is advised that information contained hereon reflects the Company's findings at the time of its intervention only and within the limits of Client's instructions, if any. The Company's sole responsibility is to its Client and this document does not exonerate parties to a transaction from exercising all their rights and obligations under the transaction documents. This document cannot be reproduced except in full, without prior written approval of the Company. Any unauthorized alteration, forgery or falsification of the content or appearance of this document is unlawful and offenders may be prosecuted to the fullest extent of the law.

3GHz-10GHz_Band26_1.4MHz_QPSK_1_0_HighCH27033-848.3

30MHz-3GHz_Band26_3MHz_QPSK_1_0_MidCH26865-831.5

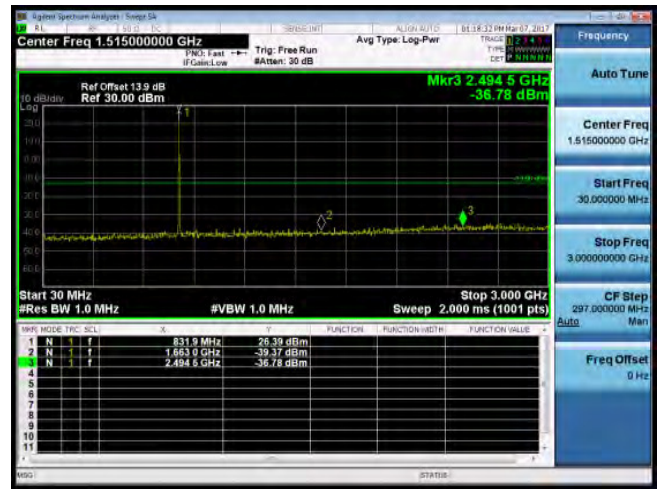
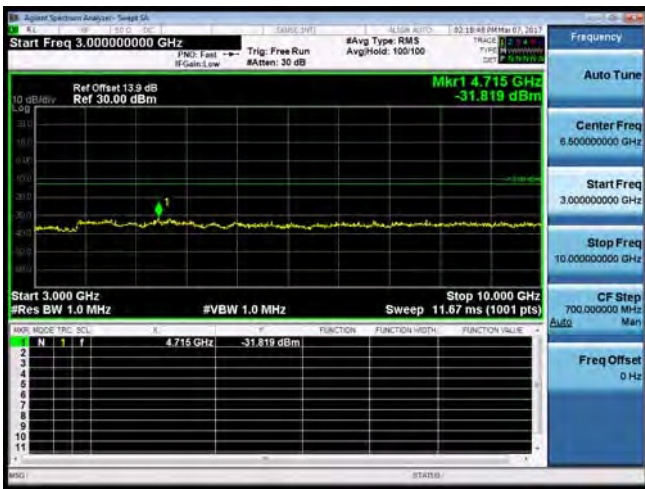

30MHz-3GHz_Band26_3MHz_QPSK_1_0_LowCH26705-815.5

3GHz-10GHz_Band26_3MHz_QPSK_1_0_MidCH26865-831.5

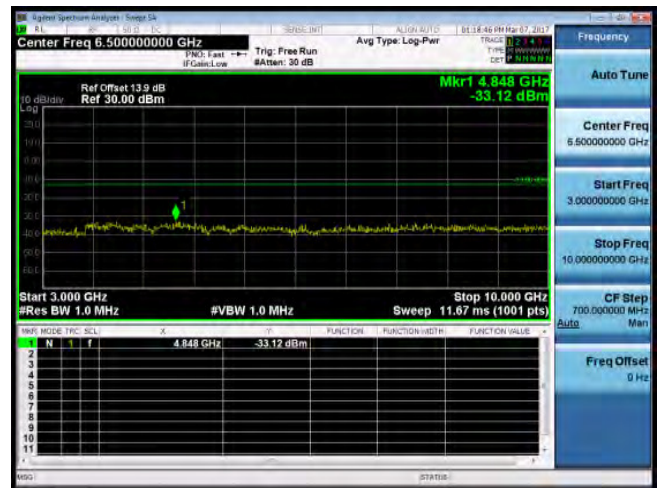
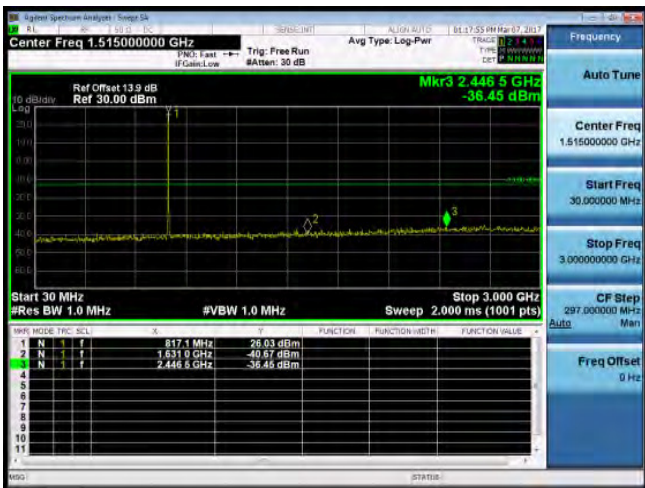

3GHz-10GHz_Band26_3MHz_QPSK_1_0_LowCH26705-815.5

30MHz-3GHz_Band26_3MHz_QPSK_1_0_HighCH27025-847.5

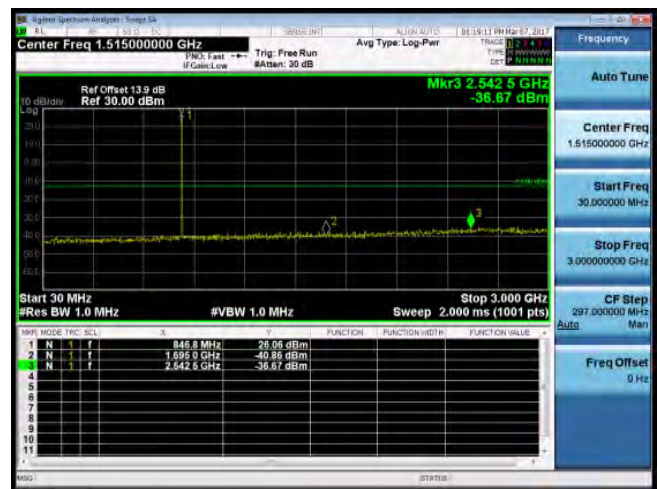
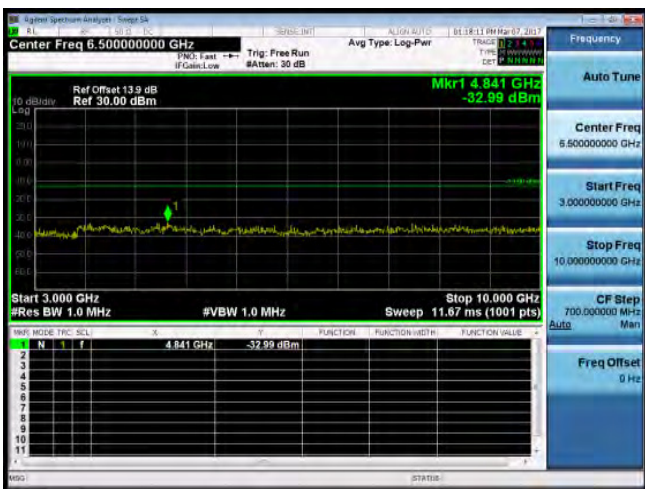

Unless otherwise stated the results shown in this test report refer only to the sample(s) tested and such sample(s) are retained for 90 days only.

除非另有說明，此報告結果僅對測試之樣品負責，同時此樣品僅保留90天。本報告未經本公司書面許可，不可部份複製。

This document is issued by the Company subject to its General Conditions of Service printed overleaf, available on request or accessible at www.sgs.com/terms_and_conditions.htm and, for electronic format documents, subject to Terms and Conditions for Electronic Documents at www.sgs.com/terms_e-document.htm. Attention is drawn to the limitation of liability, indemnification and jurisdiction issues defined therein. Any holder of this document is advised that information contained hereon reflects the Company's findings at the time of its intervention only and within the limits of Client's instructions, if any. The Company's sole responsibility is to its Client and this document does not exonerate parties to a transaction from exercising all their rights and obligations under the transaction documents. This document cannot be reproduced except in full, without prior written approval of the Company. Any unauthorized alteration, forgery or falsification of the content or appearance of this document is unlawful and offenders may be prosecuted to the fullest extent of the law.

3GHz-10GHz_Band26_3MHz_QPSK_1_0_HighCH27025-847.5

30MHz-3GHz_Band26_5MHz_QPSK_1_0_MidCH26865-831.5

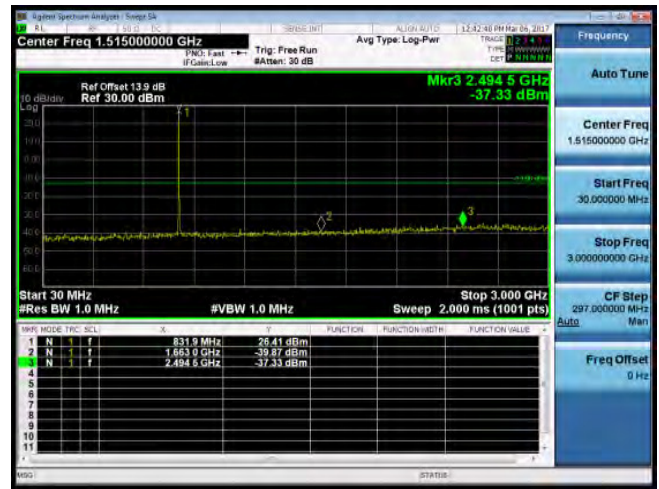
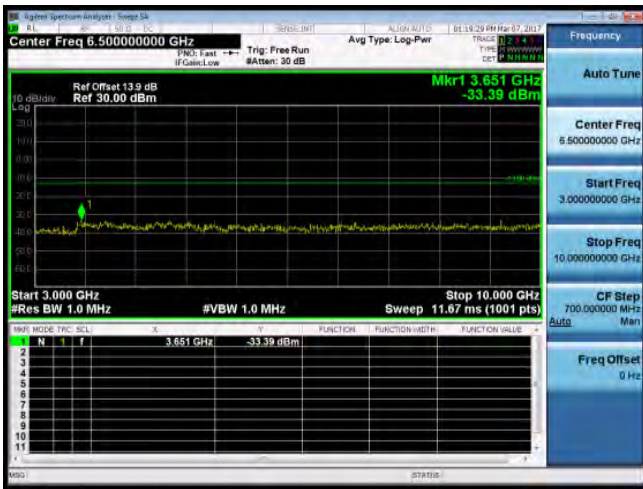

30MHz-3GHz_Band26_5MHz_QPSK_1_0_LowCH26715-816.5

3GHz-10GHz_Band26_5MHz_QPSK_1_0_MidCH26865-831.5

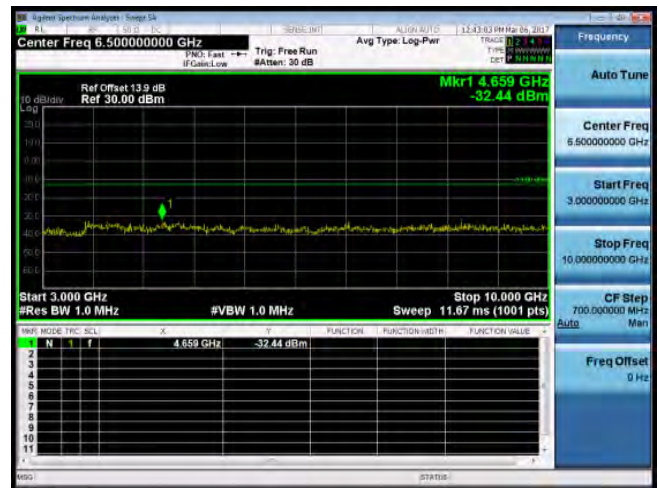
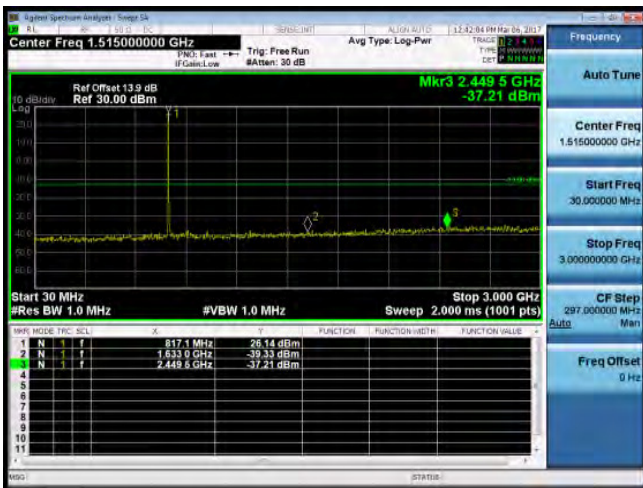

3GHz-10GHz_Band26_5MHz_QPSK_1_0_LowCH26715-816.5

30MHz-3GHz_Band26_5MHz_QPSK_1_0_HighCH27015-846.5

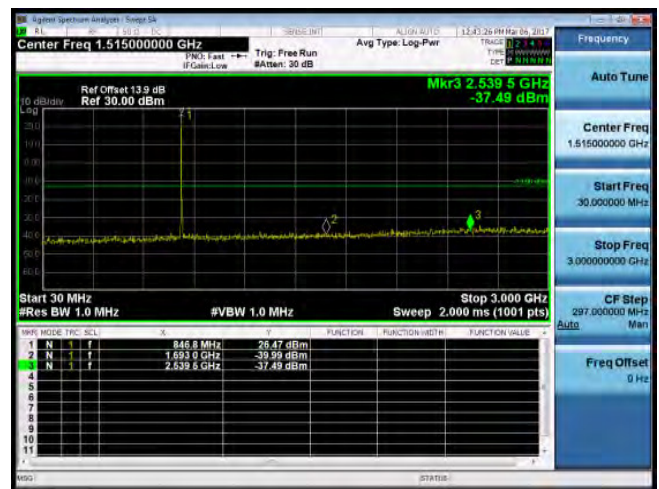
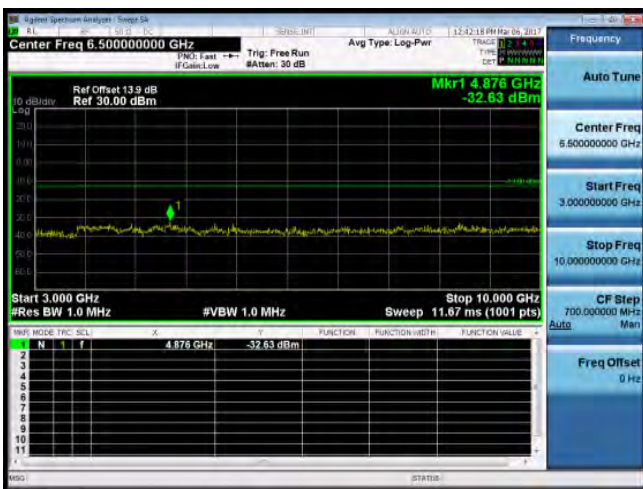

Unless otherwise stated the results shown in this test report refer only to the sample(s) tested and such sample(s) are retained for 90 days only.
除非另有說明，此報告結果僅對測試之樣品負責，同時此樣品僅保留90天。本報告未經本公司書面許可，不可部份複製。

This document is issued by the Company subject to its General Conditions of Service printed overleaf, available on request or accessible at www.sgs.com/terms_and_conditions.htm and, for electronic format documents, subject to Terms and Conditions for Electronic Documents at www.sgs.com/terms_e-document.htm. Attention is drawn to the limitation of liability, indemnification and jurisdiction issues defined therein. Any holder of this document is advised that information contained hereon reflects the Company's findings at the time of its intervention only and within the limits of Client's instructions, if any. The Company's sole responsibility is to its Client and this document does not exonerate parties to a transaction from exercising all their rights and obligations under the transaction documents. This document cannot be reproduced except in full, without prior written approval of the Company. Any unauthorized alteration, forgery or falsification of the content or appearance of this document is unlawful and offenders may be prosecuted to the fullest extent of the law.

3GHz-10GHz_Band26_5MHz_QPSK_1_0_HighCH27015-846.5

30MHz-3GHz_Band26_10MHz_QPSK_1_0_MidCH26865-831.5

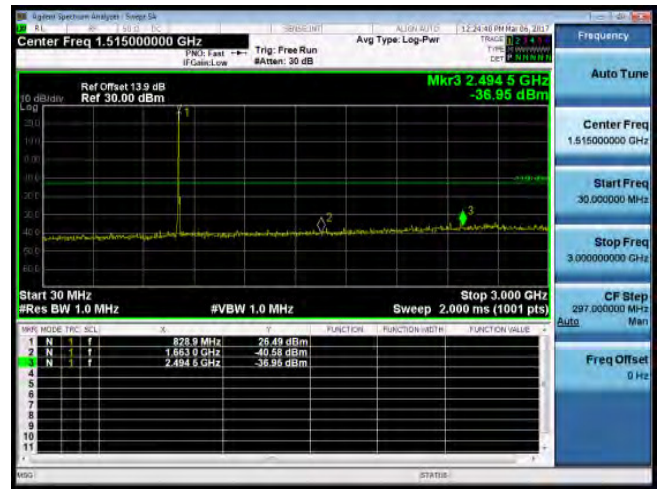
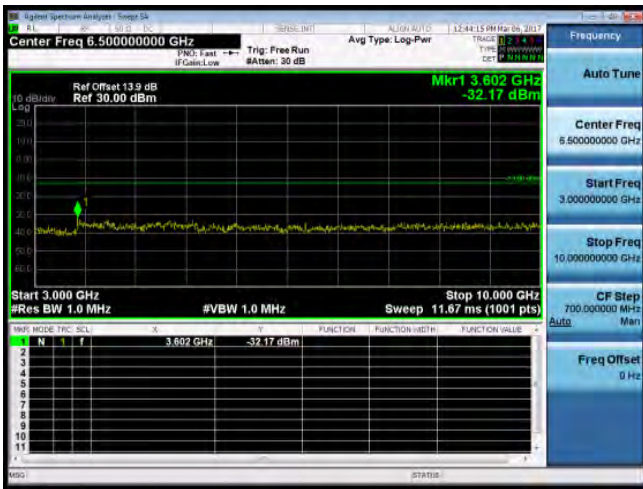

30MHz-3GHz_Band26_10MHz_QPSK_1_0_LowCH26750-820

3GHz-10GHz_Band26_10MHz_QPSK_1_0_MidCH26865-831.5

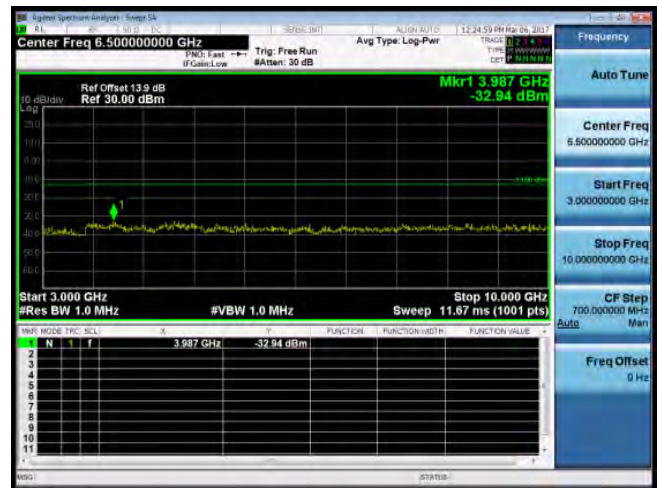
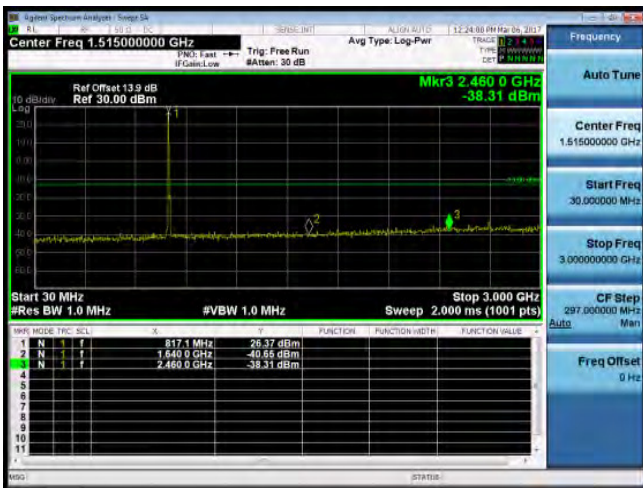

3GHz-10GHz_Band26_10MHz_QPSK_1_0_LowCH26750-820

30MHz-3GHz_Band26_10MHz_QPSK_1_0_HighCH26990-844

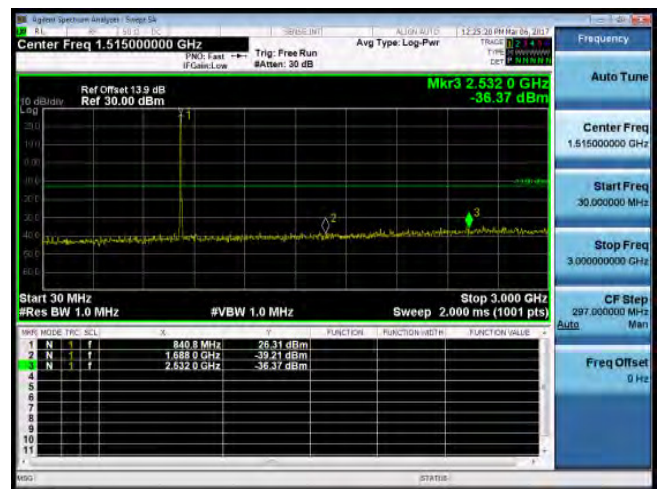
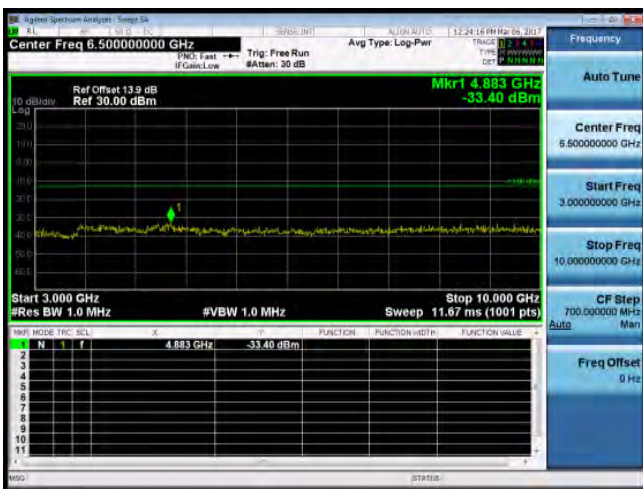

Unless otherwise stated the results shown in this test report refer only to the sample(s) tested and such sample(s) are retained for 90 days only.
除非另有說明，此報告結果僅對測試之樣品負責，同時此樣品僅保留90天。本報告未經本公司書面許可，不可部份複製。

This document is issued by the Company subject to its General Conditions of Service printed overleaf, available on request or accessible at www.sgs.com/terms_and_conditions.htm and, for electronic format documents, subject to Terms and Conditions for Electronic Documents at www.sgs.com/terms_e-document.htm. Attention is drawn to the limitation of liability, indemnification and jurisdiction issues defined therein. Any holder of this document is advised that information contained hereon reflects the Company's findings at the time of its intervention only and within the limits of Client's instructions, if any. The Company's sole responsibility is to its Client and this document does not exonerate parties to a transaction from exercising all their rights and obligations under the transaction documents. This document cannot be reproduced except in full, without prior written approval of the Company. Any unauthorized alteration, forgery or falsification of the content or appearance of this document is unlawful and offenders may be prosecuted to the fullest extent of the law.

3GHz~10GHz_Band26_10MHz_QPSK_1_0_HighCH26990-844

30MHz~3GHz_Band26_15MHz_QPSK_1_0_MidCH26865-831.5

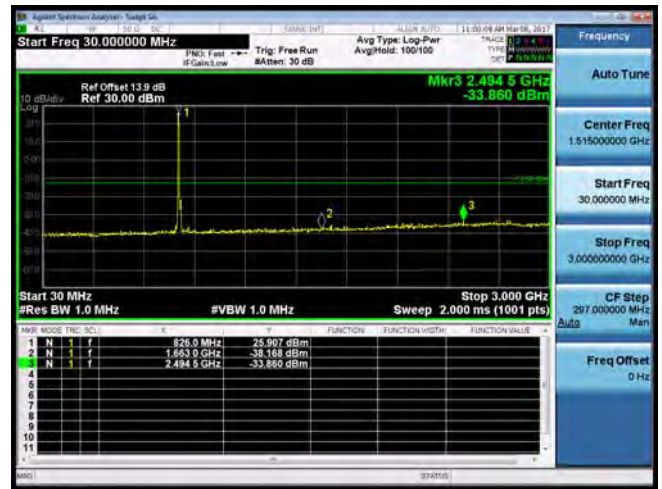
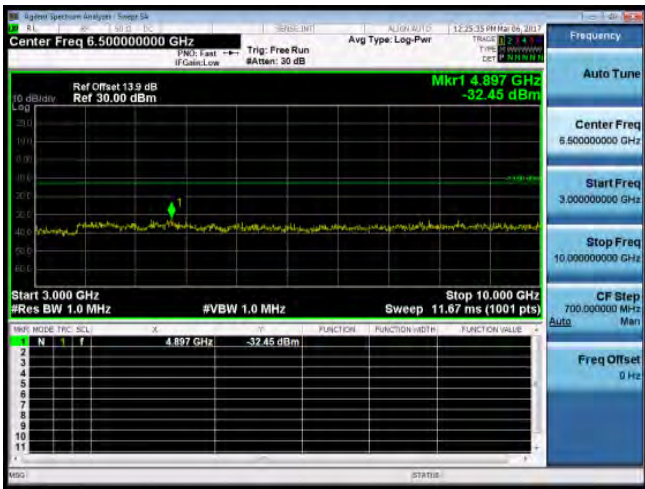

30MHz~3GHz_Band26_15MHz_QPSK_1_0_LowCH26775-822.5

3GHz~10GHz_Band26_15MHz_QPSK_1_0_MidCH26865-831.5

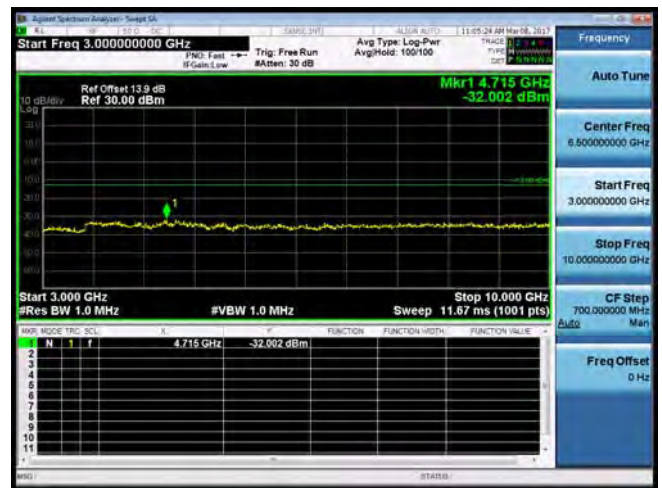

3GHz~10GHz_Band26_15MHz_QPSK_1_0_LowCH26775-822.5

30MHz~3GHz_Band26_15MHz_QPSK_1_0_HighCH26965-841.5

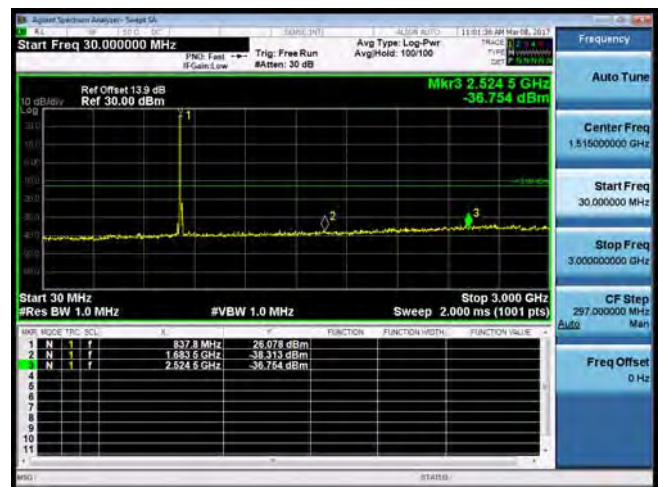
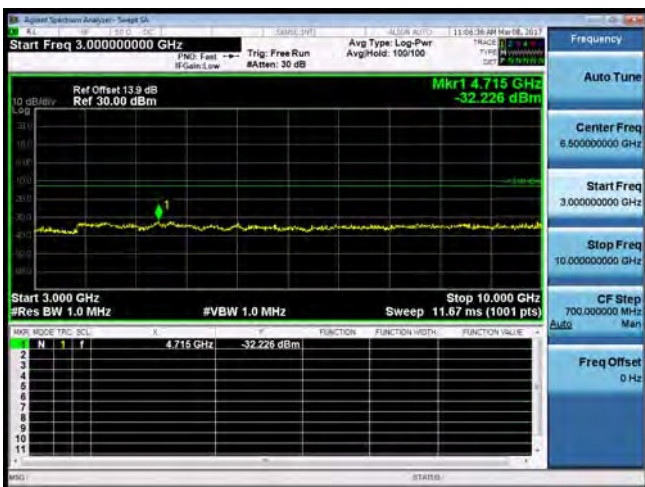

Unless otherwise stated the results shown in this test report refer only to the sample(s) tested and such sample(s) are retained for 90 days only.
除非另有說明，此報告結果僅對測試之樣品負責，同時此樣品僅保留90天。本報告未經本公司書面許可，不可部份複製。

This document is issued by the Company subject to its General Conditions of Service printed overleaf, available on request or accessible at www.sgs.com/terms_and_conditions.htm and, for electronic format documents, subject to Terms and Conditions for Electronic Documents at www.sgs.com/terms_e-document.htm. Attention is drawn to the limitation of liability, indemnification and jurisdiction issues defined therein. Any holder of this document is advised that information contained hereon reflects the Company's findings at the time of its intervention only and within the limits of Client's instructions, if any. The Company's sole responsibility is to its Client and this document does not exonerate parties to a transaction from exercising all their rights and obligations under the transaction documents. This document cannot be reproduced except in full, without prior written approval of the Company. Any unauthorized alteration, forgery or falsification of the content or appearance of this document is unlawful and offenders may be prosecuted to the fullest extent of the law.

3GHz~10GHz_Band26_15MHz_QPSK_1_0_HighCH26965-841.5

30MHz~3GHz_Band41_5MHz_QPSK_1_0_MidCH40620

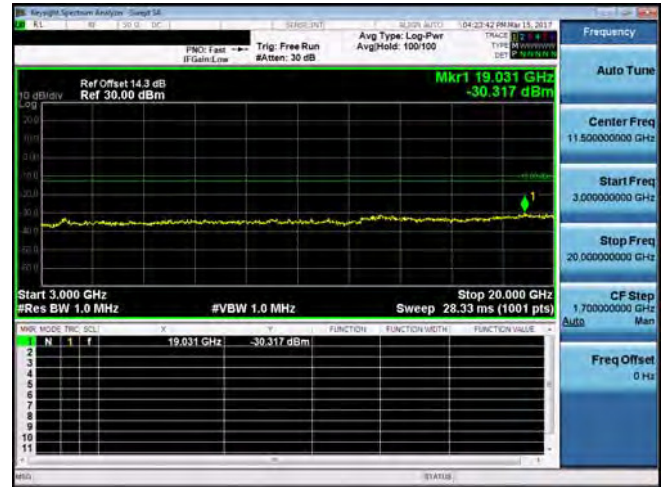
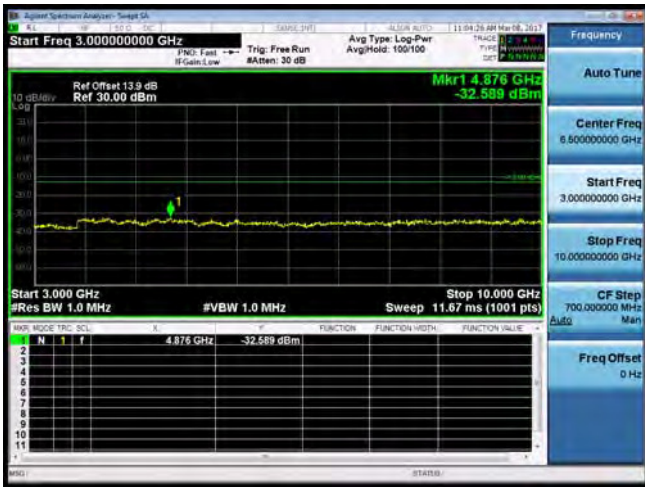

30MHz~3GHz_Band41_5MHz_QPSK_1_0_LowCH39675

3GHz~10GHz_Band41_5MHz_QPSK_1_0_MidCH40620

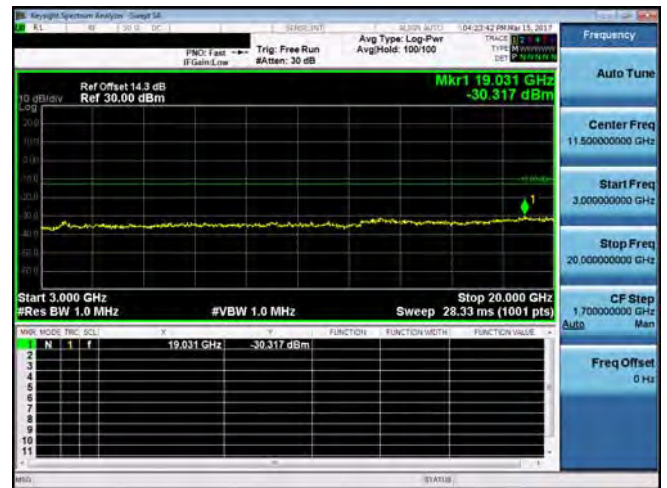
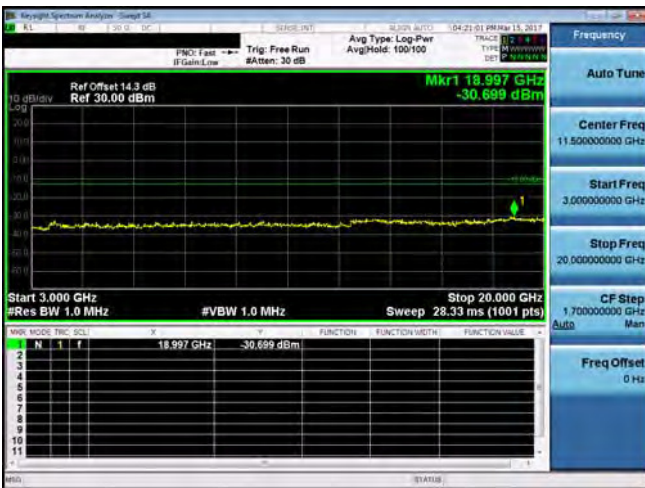

3GHz~10GHz_Band41_5MHz_QPSK_1_0_LowCH39675

30MHz~3GHz_Band41_5MHz_QPSK_1_0_HighCH41565

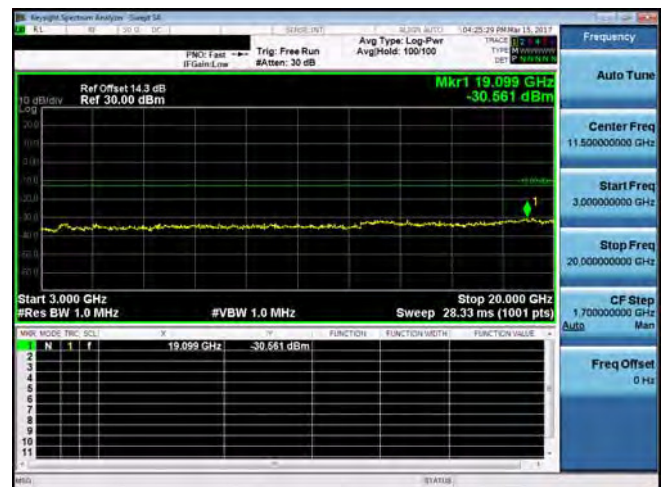
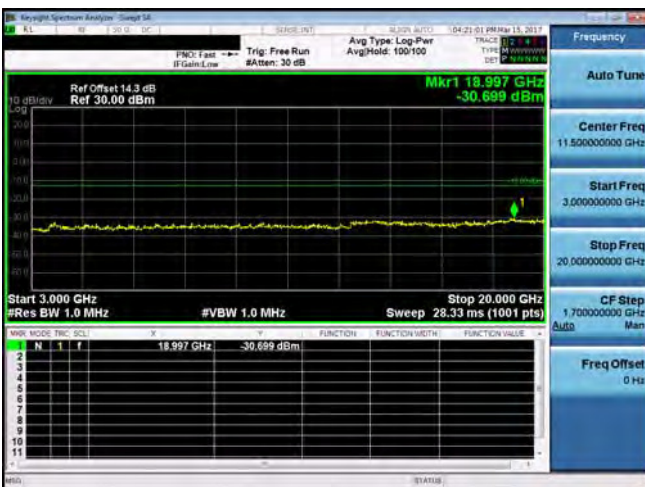

Unless otherwise stated the results shown in this test report refer only to the sample(s) tested and such sample(s) are retained for 90 days only.
除非另有說明，此報告結果僅對測試之樣品負責，同時此樣品僅保留90天。本報告未經本公司書面許可，不可部份複製。

This document is issued by the Company subject to its General Conditions of Service printed overleaf, available on request or accessible at www.sgs.com/terms_and_conditions.htm and, for electronic format documents, subject to Terms and Conditions for Electronic Documents at www.sgs.com/terms_e-document.htm. Attention is drawn to the limitation of liability, indemnification and jurisdiction issues defined therein. Any holder of this document is advised that information contained hereon reflects the Company's findings at the time of its intervention only and within the limits of Client's instructions, if any. The Company's sole responsibility is to its Client and this document does not exonerate parties to a transaction from exercising all their rights and obligations under the transaction documents. This document cannot be reproduced except in full, without prior written approval of the Company. Any unauthorized alteration, forgery or falsification of the content or appearance of this document is unlawful and offenders may be prosecuted to the fullest extent of the law.

3GHz-10GHz_Band41_5MHz_QPSK_1_0_HighCH41565

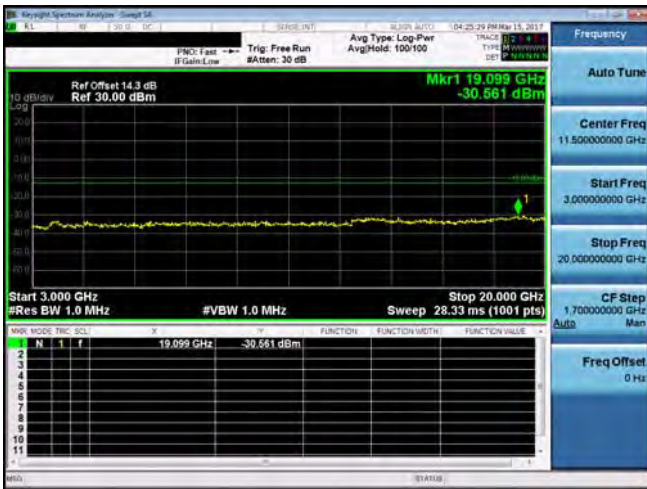

30MHz-3GHz_Band41_10MHz_QPSK_1_0_MidCH40620

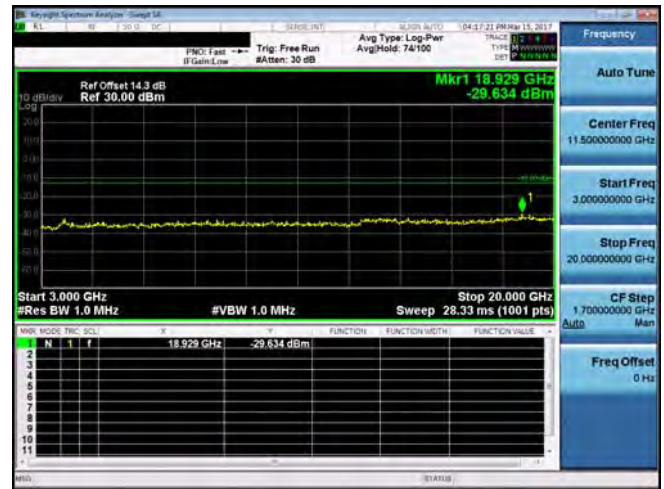

30MHz-3GHz_Band41_10MHz_QPSK_1_0_LowCH39700

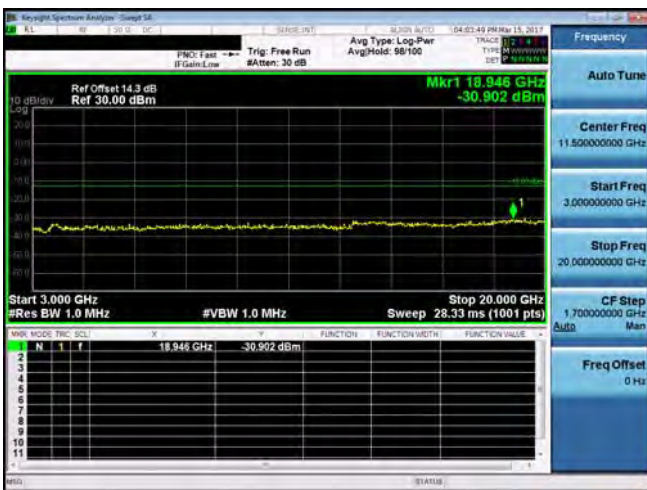

3GHz-10GHz_Band41_10MHz_QPSK_1_0_MidCH40620

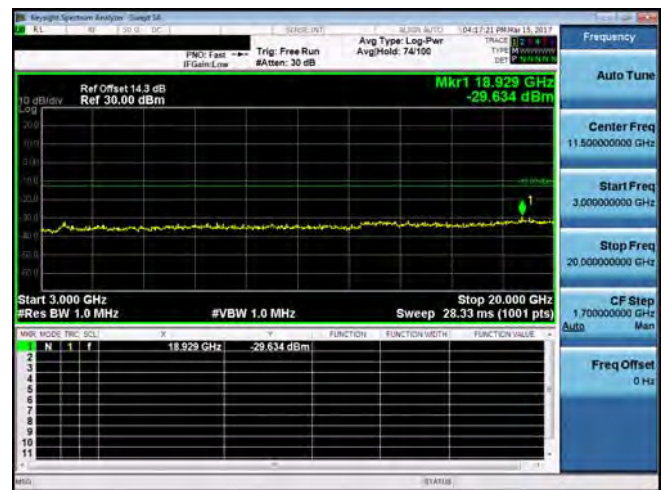

3GHz-10GHz_Band41_10MHz_QPSK_1_0_LowCH39700

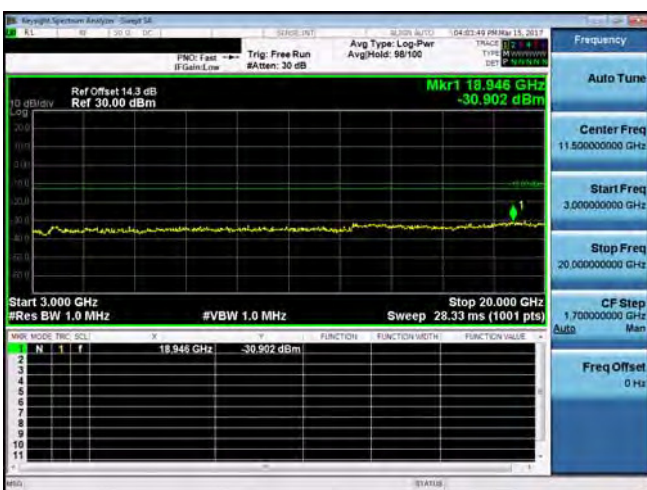

30MHz-3GHz_Band41_10MHz_QPSK_1_0_HighCH41540

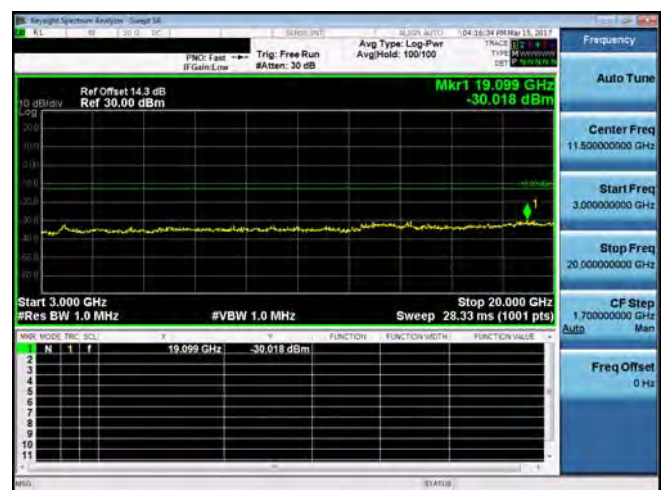

Unless otherwise stated the results shown in this test report refer only to the sample(s) tested and such sample(s) are retained for 90 days only.

除非另有說明，此報告結果僅對測試之樣品負責，同時此樣品僅保留90天。本報告未經本公司書面許可，不可部份複製。

This document is issued by the Company subject to its General Conditions of Service printed overleaf, available on request or accessible at www.sgs.com/terms_and_conditions.htm and, for electronic format documents, subject to Terms and Conditions for Electronic Documents at www.sgs.com/terms_e-document.htm. Attention is drawn to the limitation of liability, indemnification and jurisdiction issues defined therein. Any holder of this document is advised that information contained hereon reflects the Company's findings at the time of its intervention only and within the limits of Client's instructions, if any. The Company's sole responsibility is to its Client and this document does not exonerate parties to a transaction from exercising all their rights and obligations under the transaction documents. This document cannot be reproduced except in full, without prior written approval of the Company. Any unauthorized alteration, forgery or falsification of the content or appearance of this document is unlawful and offenders may be prosecuted to the fullest extent of the law.

3GHz~10GHz_Band41_10MHz_QPSK_1_0_HighCH41540

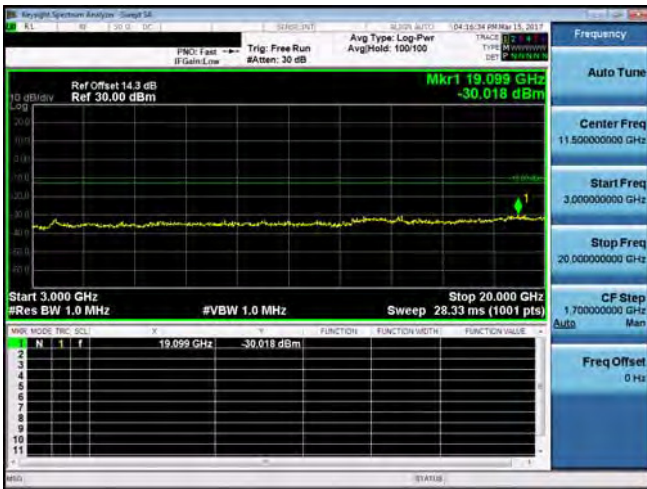

30MHz~3GHz_Band41_15MHz_QPSK_1_0_MidCH40620

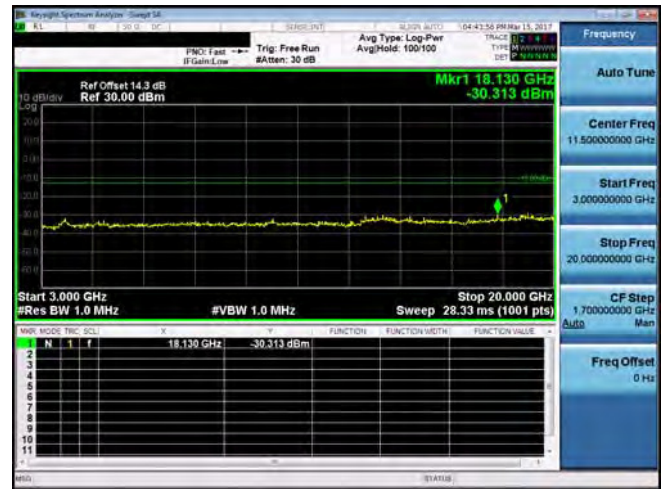

30MHz~3GHz_Band41_15MHz_QPSK_1_0_LowCH39725

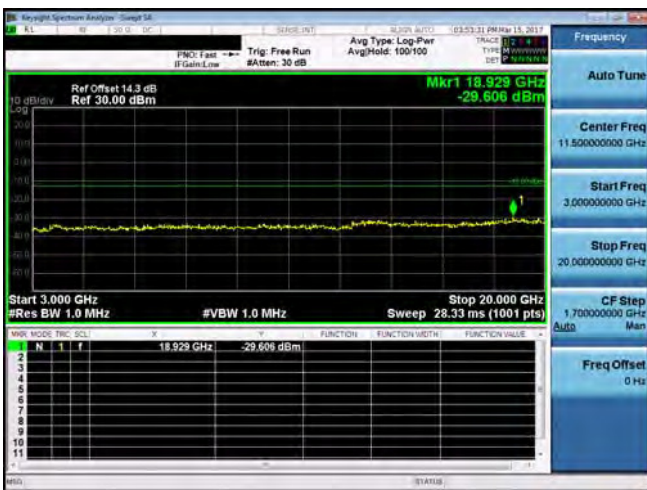

3GHz~10GHz_Band41_15MHz_QPSK_1_0_MidCH40620

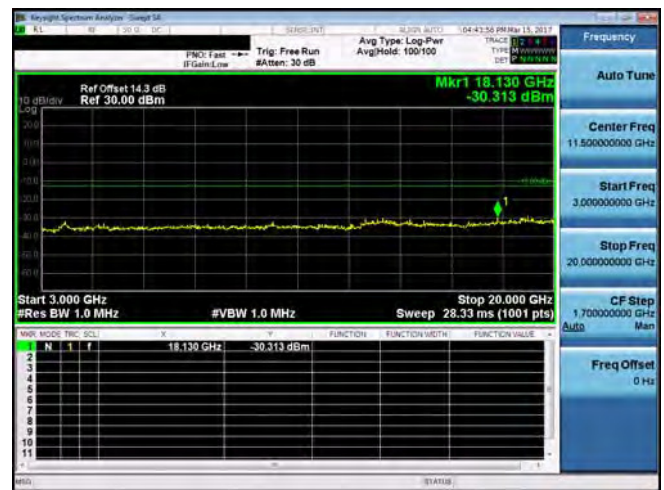

3GHz~10GHz_Band41_15MHz_QPSK_1_0_LowCH39725

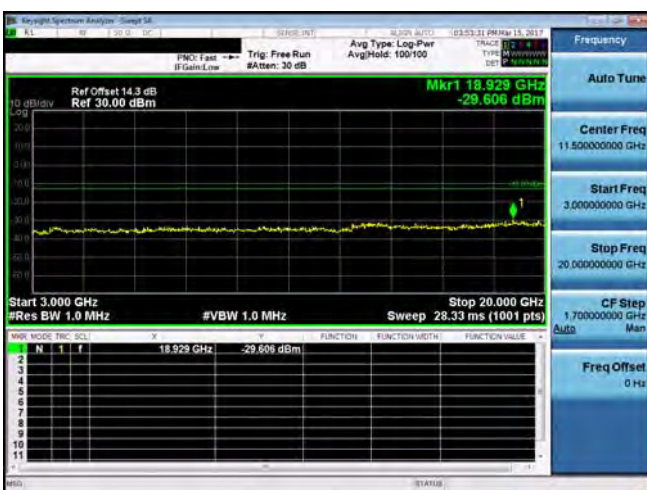

30MHz~3GHz_Band41_15MHz_QPSK_1_0_HighCH41515

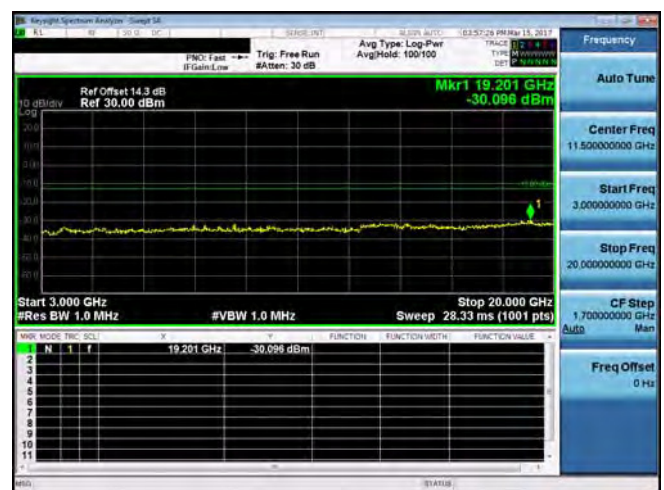

Unless otherwise stated the results shown in this test report refer only to the sample(s) tested and such sample(s) are retained for 90 days only.
除非另有說明，此報告結果僅對測試之樣品負責，同時此樣品僅保留90天。本報告未經本公司書面許可，不可部份複製。

This document is issued by the Company subject to its General Conditions of Service printed overleaf, available on request or accessible at www.sgs.com/terms_and_conditions.htm and, for electronic format documents, subject to Terms and Conditions for Electronic Documents at www.sgs.com/terms_e-document.htm. Attention is drawn to the limitation of liability, indemnification and jurisdiction issues defined therein. Any holder of this document is advised that information contained hereon reflects the Company's findings at the time of its intervention only and within the limits of Client's instructions, if any. The Company's sole responsibility is to its Client and this document does not exonerate parties to a transaction from exercising all their rights and obligations under the transaction documents. This document cannot be reproduced except in full, without prior written approval of the Company. Any unauthorized alteration, forgery or falsification of the content or appearance of this document is unlawful and offenders may be prosecuted to the fullest extent of the law.

3GHz-10GHz_Band41_15MHz_QPSK_1_0_HighCH41515

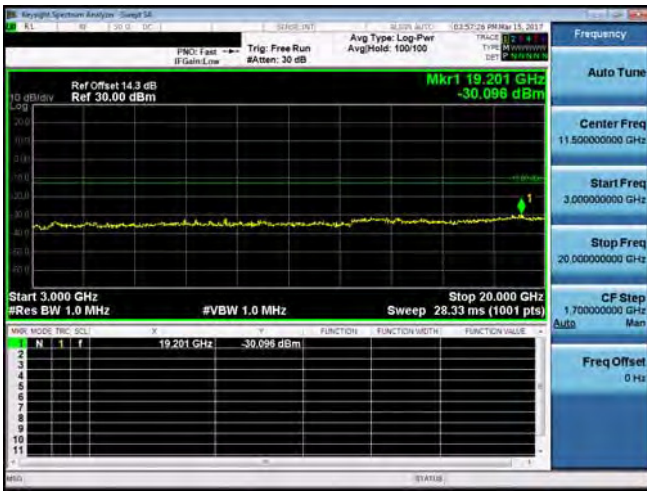

30MHz-3GHz_Band41_20MHz_QPSK_1_0_MidCH40620

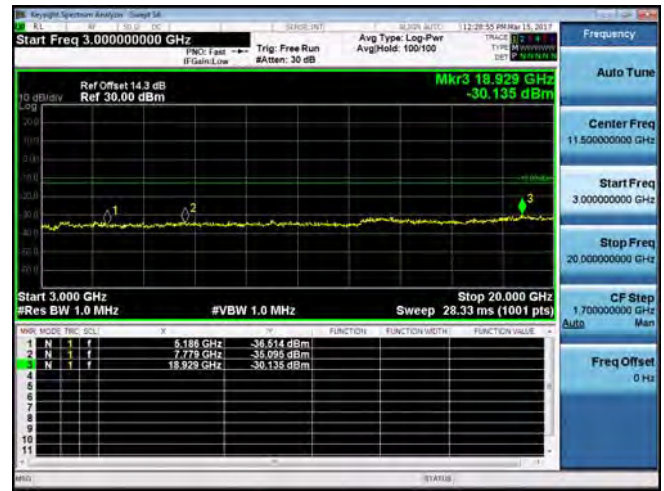

30MHz-3GHz_Band41_20MHz_QPSK_1_0_LowCH39750



3GHz-10GHz_Band41_20MHz_QPSK_1_0_MidCH40620



3GHz-10GHz_Band41_20MHz_QPSK_1_0_LowCH39750

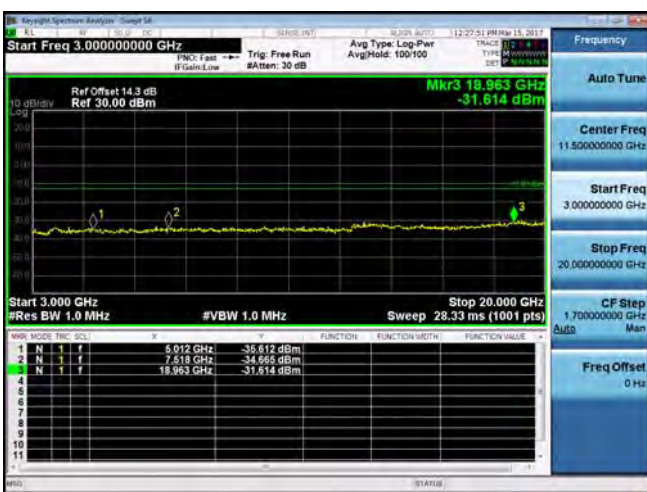

30MHz-3GHz_Band41_20MHz_QPSK_1_0_HighCH41490



Unless otherwise stated the results shown in this test report refer only to the sample(s) tested and such sample(s) are retained for 90 days only.

除非另有說明，此報告結果僅對測試之樣品負責，同時此樣品僅保留90天。本報告未經本公司書面許可，不可部份複製。

This document is issued by the Company subject to its General Conditions of Service printed overleaf, available on request or accessible at www.sgs.com/terms_and_conditions.htm and, for electronic format documents, subject to Terms and Conditions for Electronic Documents at www.sgs.com/terms_e-document.htm. Attention is drawn to the limitation of liability, indemnification and jurisdiction issues defined therein. Any holder of this document is advised that information contained hereon reflects the Company's findings at the time of its intervention only and within the limits of Client's instructions, if any. The Company's sole responsibility is to its Client and this document does not exonerate parties to a transaction from exercising all their rights and obligations under the transaction documents. This document cannot be reproduced except in full, without prior written approval of the Company. Any unauthorized alteration, forgery or falsification of the content or appearance of this document is unlawful and offenders may be prosecuted to the fullest extent of the law.

3GHz-10GHz_Band41_20MHz_QPSK_1_0_HighCH41490

30MHz-3GHz_Band26_1.4MHz_QPSK_1_0_MidCH26740

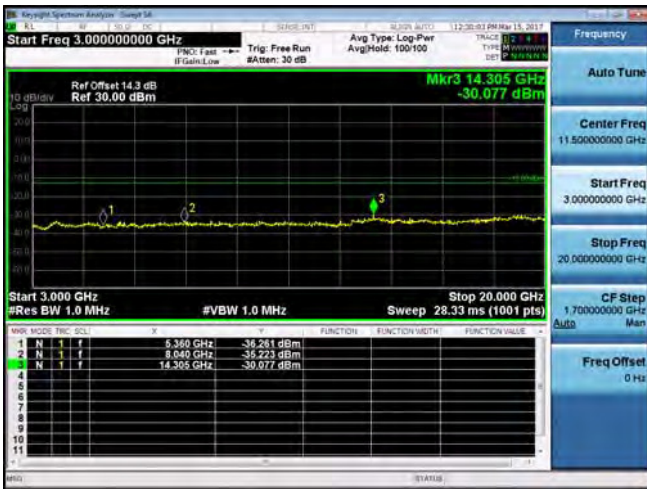

Band 26 for Part 90S

3GHz-10GHz_Band26_1.4MHz_QPSK_1_0_MidCH26740

30MHz-3GHz_Band26_1.4MHz_QPSK_1_0_LowCH26697

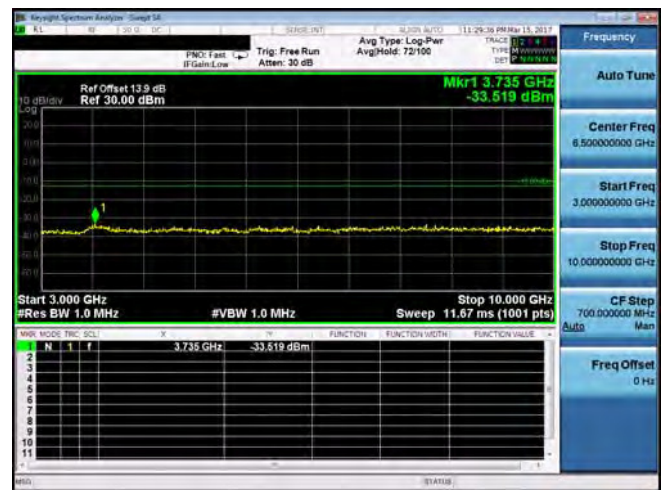
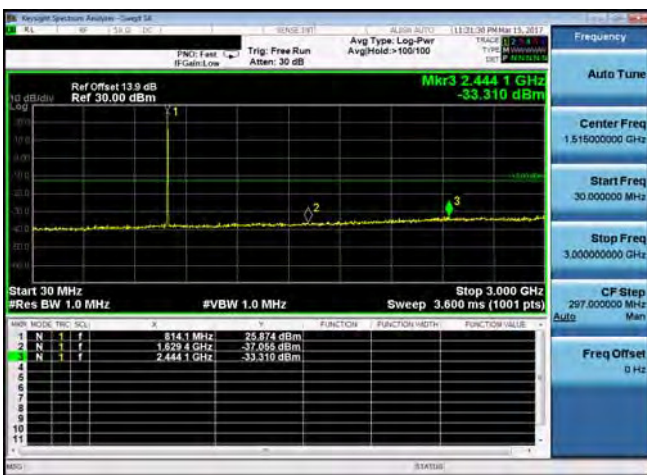

3GHz-10GHz_Band26_1.4MHz_QPSK_1_0_LowCH26697

30MHz-3GHz_Band26_1.4MHz_QPSK_1_0_HighCH26783

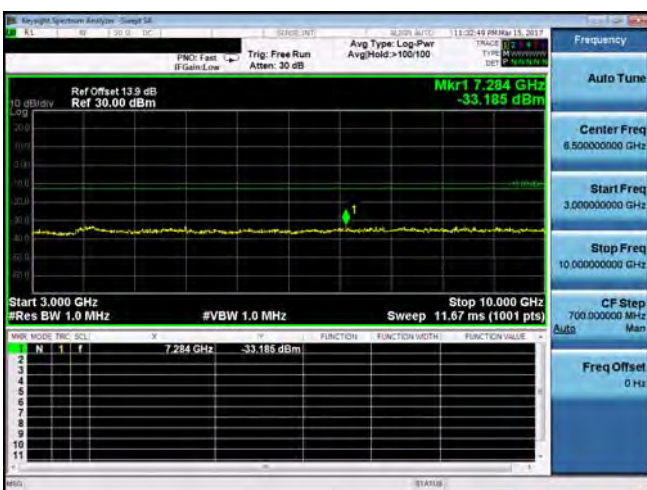

Unless otherwise stated the results shown in this test report refer only to the sample(s) tested and such sample(s) are retained for 90 days only.

除非另有說明，此報告結果僅對測試之樣品負責，同時此樣品僅保留90天。本報告未經本公司書面許可，不可部份複製。

This document is issued by the Company subject to its General Conditions of Service printed overleaf, available on request or accessible at www.sgs.com/terms_and_conditions.htm and, for electronic format documents, subject to Terms and Conditions for Electronic Documents at www.sgs.com/terms_e-document.htm. Attention is drawn to the limitation of liability, indemnification and jurisdiction issues defined therein. Any holder of this document is advised that information contained hereon reflects the Company's findings at the time of its intervention only and within the limits of Client's instructions, if any. The Company's sole responsibility is to its Client and this document does not exonerate parties to a transaction from exercising all their rights and obligations under the transaction documents. This document cannot be reproduced except in full, without prior written approval of the Company. Any unauthorized alteration, forgery or falsification of the content or appearance of this document is unlawful and offenders may be prosecuted to the fullest extent of the law.

3GHz-10GHz_Band26_1.4MHz_QPSK_1_0_HighCH26783

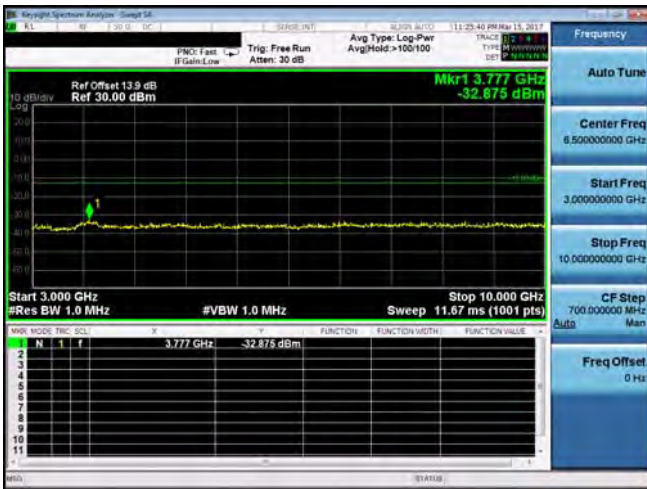

30MHz-3GHz_Band26_3MHz_QPSK_1_0_MidCH24740



30MHz-3GHz_Band26_3MHz_QPSK_1_0_LowCH26705

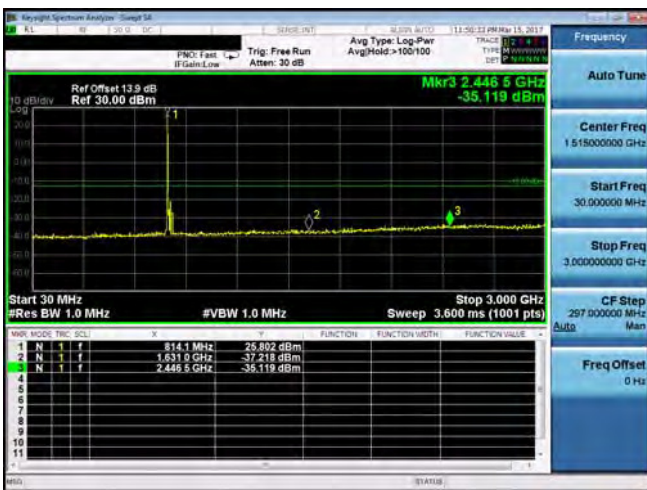

3GHz-10GHz_Band26_3MHz_QPSK_1_0_MidCH24740

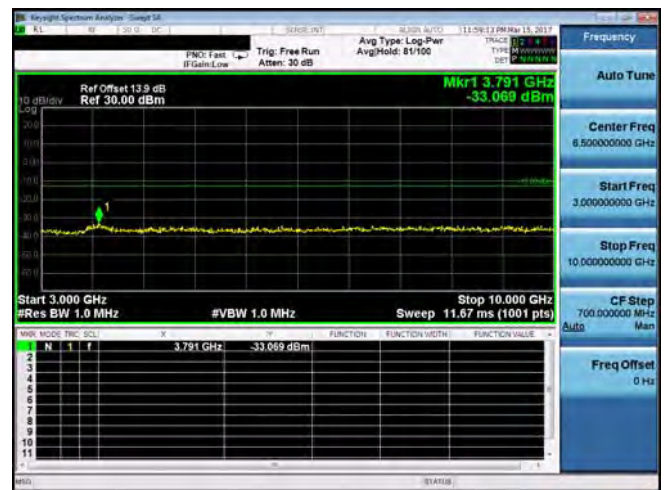

3GHz-10GHz_Band26_3MHz_QPSK_1_0_LowCH26705

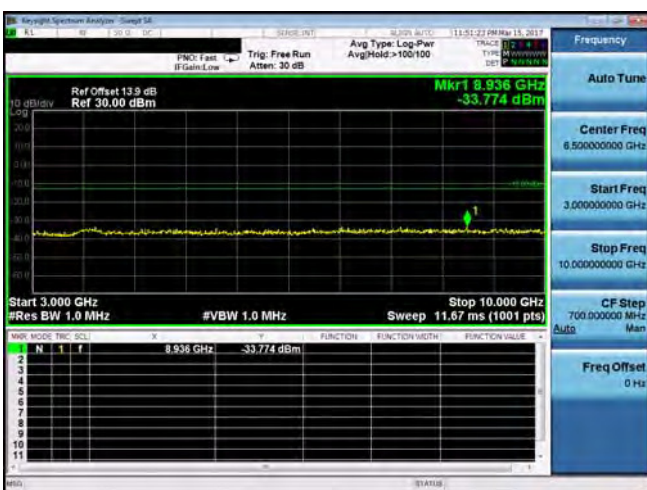

30MHz-3GHz_Band26_3MHz_QPSK_1_0_HighCH26775



Unless otherwise stated the results shown in this test report refer only to the sample(s) tested and such sample(s) are retained for 90 days only.
除非另有說明，此報告結果僅對測試之樣品負責，同時此樣品僅保留90天。本報告未經本公司書面許可，不可部份複製。

This document is issued by the Company subject to its General Conditions of Service printed overleaf, available on request or accessible at www.sgs.com/terms_and_conditions.htm and, for electronic format documents, subject to Terms and Conditions for Electronic Documents at www.sgs.com/terms_e-document.htm. Attention is drawn to the limitation of liability, indemnification and jurisdiction issues defined therein. Any holder of this document is advised that information contained hereon reflects the Company's findings at the time of its intervention only and within the limits of Client's instructions, if any. The Company's sole responsibility is to its Client and this document does not exonerate parties to a transaction from exercising all their rights and obligations under the transaction documents. This document cannot be reproduced except in full, without prior written approval of the Company. Any unauthorized alteration, forgery or falsification of the content or appearance of this document is unlawful and offenders may be prosecuted to the fullest extent of the law.

3GHz-10GHz_Band26_3MHz_QPSK_1_0_HighCH26775

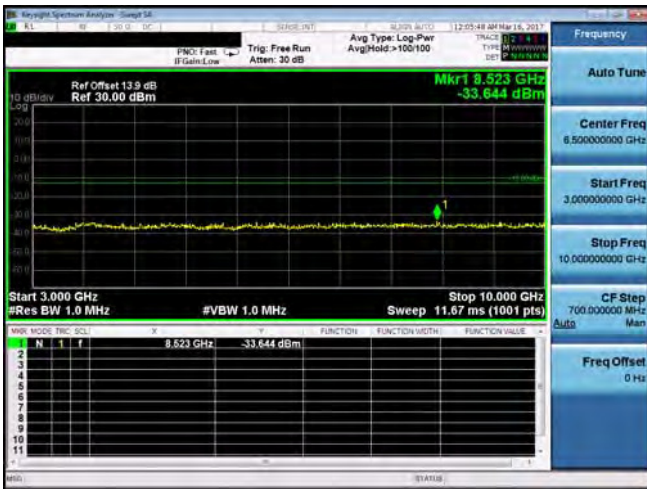

30MHz-3GHz_Band26_5MHz_QPSK_1_0_MidCH26740

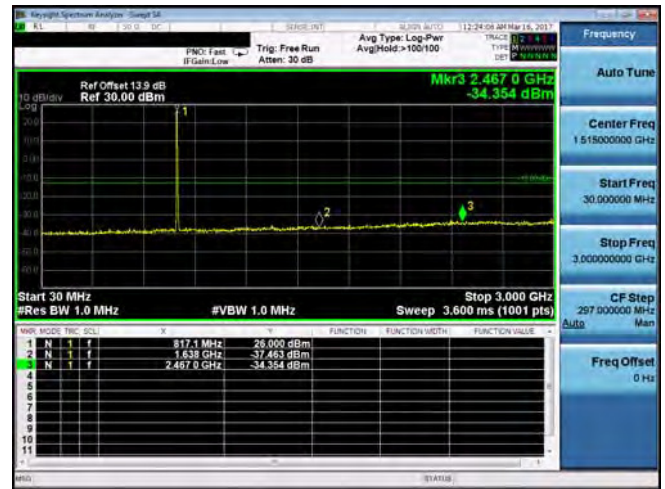

30MHz-3GHz_Band26_5MHz_QPSK_1_0_LowCH26715

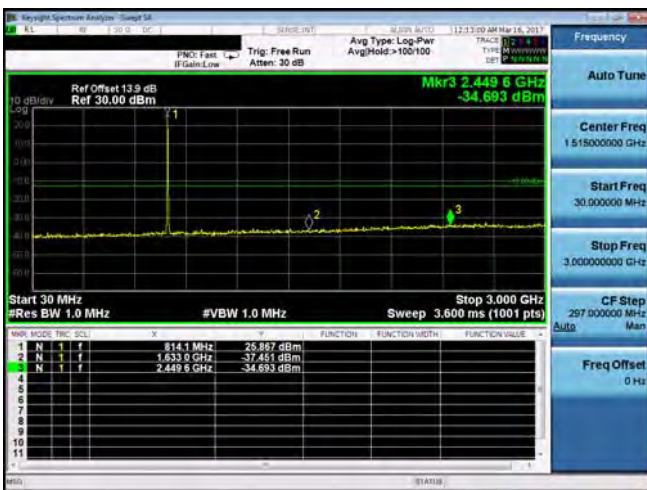

3GHz-10GHz_Band26_5MHz_QPSK_1_0_MidCH26740

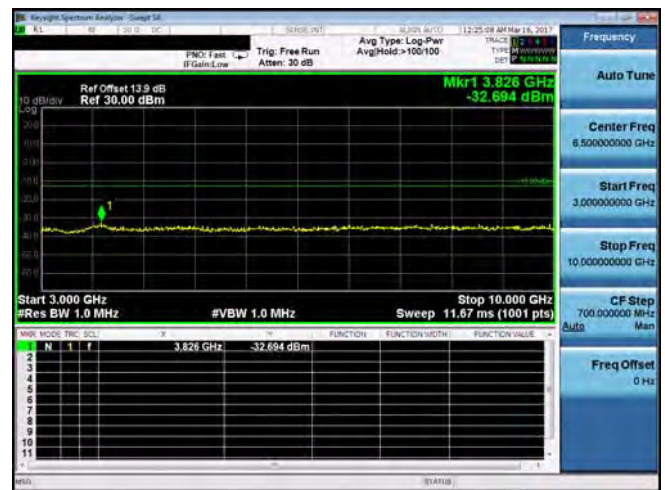

3GHz-10GHz_Band26_5MHz_QPSK_1_0_LowCH26715

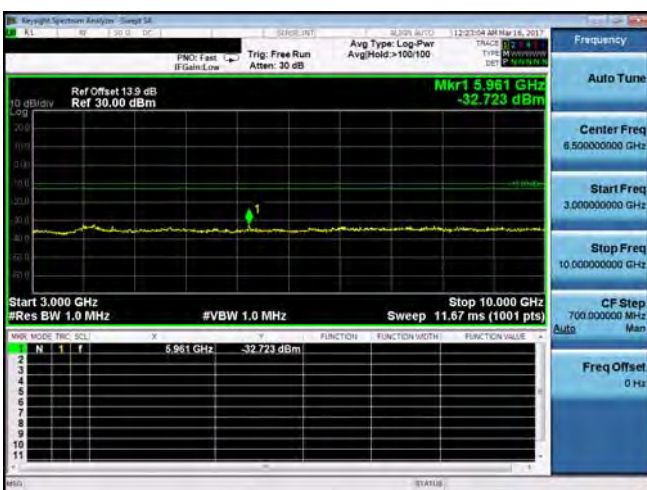

30MHz-3GHz_Band26_5MHz_QPSK_1_0_HighCH26765

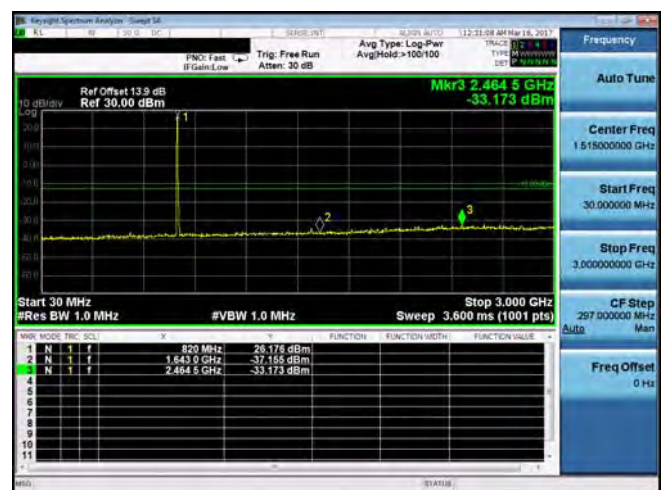

Unless otherwise stated the results shown in this test report refer only to the sample(s) tested and such sample(s) are retained for 90 days only.
除非另有說明，此報告結果僅對測試之樣品負責，同時此樣品僅保留90天。本報告未經本公司書面許可，不可部份複製。

This document is issued by the Company subject to its General Conditions of Service printed overleaf, available on request or accessible at www.sgs.com/terms_and_conditions.htm and, for electronic format documents, subject to Terms and Conditions for Electronic Documents at www.sgs.com/terms_e-document.htm. Attention is drawn to the limitation of liability, indemnification and jurisdiction issues defined therein. Any holder of this document is advised that information contained hereon reflects the Company's findings at the time of its intervention only and within the limits of Client's instructions, if any. The Company's sole responsibility is to its Client and this document does not exonerate parties to a transaction from exercising all their rights and obligations under the transaction documents. This document cannot be reproduced except in full, without prior written approval of the Company. Any unauthorized alteration, forgery or falsification of the content or appearance of this document is unlawful and offenders may be prosecuted to the fullest extent of the law.

3GHz-10GHz_Band26_5MHz_QPSK_1_0_HighCH26765

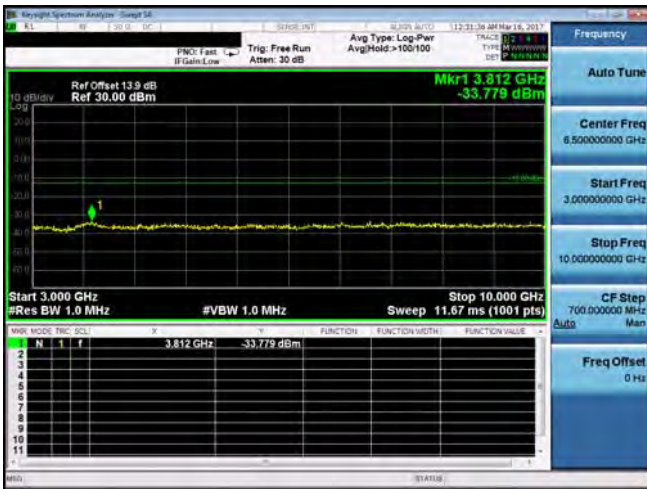

3GHz-10GHz_Band26_10MHz_QPSK_1_0_MidCH26740

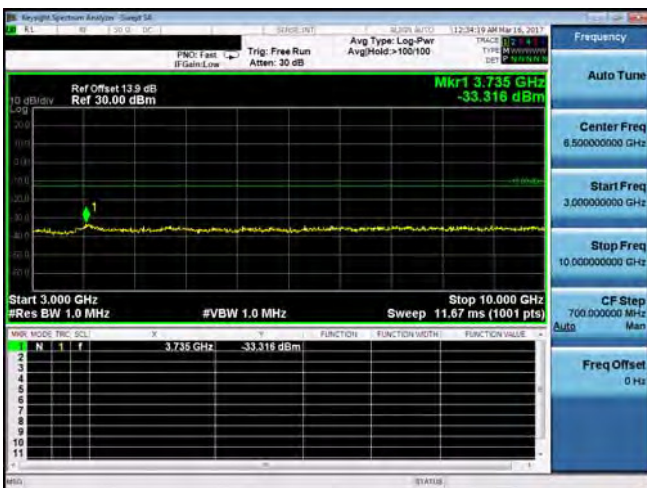

30MHz-3GHz_Band26_10MHz_QPSK_1_0_MidCH26740



Unless otherwise stated the results shown in this test report refer only to the sample(s) tested and such sample(s) are retained for 90 days only.
除非另有說明，此報告結果僅對測試之樣品負責，同時此樣品僅保留90天。本報告未經本公司書面許可，不可部份複製。

This document is issued by the Company subject to its General Conditions of Service printed overleaf, available on request or accessible at www.sgs.com/terms_and_conditions.htm and, for electronic format documents, subject to Terms and Conditions for Electronic Documents at www.sgs.com/terms_e-document.htm. Attention is drawn to the limitation of liability, indemnification and jurisdiction issues defined therein. Any holder of this document is advised that information contained hereon reflects the Company's findings at the time of its intervention only and within the limits of Client's instructions, if any. The Company's sole responsibility is to its Client and this document does not exonerate parties to a transaction from exercising all their rights and obligations under the transaction documents. This document cannot be reproduced except in full, without prior written approval of the Company. Any unauthorized alteration, forgery or falsification of the content or appearance of this document is unlawful and offenders may be prosecuted to the fullest extent of the law.

10. FIELD STRENGTH OF SPURIOUS RADIATION MEASUREMENT

10.1. Standard Applicable

According to FCC §2.1053,

FCC §22.917(a) , §24.238(a) , §27.53(g)(h) , the magnitude of each spurious and harmonic emission that can be detected when the equipment is operated under the conditions specified in the instruction manual and/ or alignment procedure, shall not be less than $43 + 10 \log$ (mean output power in watts) dBc below the mean power output outside a license’s frequency block (-13dBm).

FCC §27.53 (m) (4) shall not be less than $55 + 10 \log$ (mean output power in watt) dBc below the mean power output outside a license’s frequency block (-25dBm).

§27.53 (c)

(2) On any frequency outside the 776– 788 MHz band, the power of any emission shall be attenuated outside the band below the transmitter power (P) by at least $43 + 10 \log$ (P) dB (-13dBm)

(4) On all frequencies between 763-775 MHz and 793-805 MHz, by a factor not less than $65 + 10 \log$ (P) dB in a 6.25 kHz band segment, for mobile and portable stations;

§27.53 (f) For operations in the 746-758 MHz, 775-788 MHz, and 805-806 MHz bands, emissions in the band 1559-1610 MHz shall be limited to -70 dBW/MHz equivalent isotropically radiated power (EIRP) for wideband signals, and -80 dBW EIRP for discrete emissions of less than 700 Hz bandwidth. For the purpose of equipment authorization, a transmitter shall be tested with an antenna that is representative of the type that will be used with the equipment in normal operation.

Table 2 — Unwanted Emissions for Mobile, Portable and Low-Power Fixed Subscriber Equipment

| Frequency (MHz) | Attenuation (dB) |
|-----------------|--|
| <2200 | $43 + 10 \log_{10}(p)$ |
| 2200 - 2288 | $70 + 10 \log_{10}(p)$ |
| 2288 - 2292 | $67 + 10 \log_{10}(p)$ |
| 2292 - 2296 | $61 + 10 \log_{10}(p)$ |
| 2296 - 2300 | $55 + 10 \log_{10}(p)$ |
| 2300 - 2305 | $43 + 10 \log_{10}(p)$ |
| 2305 - 2320 | $43 + 10 \log_{10}(p)$ ^{Note} |
| 2320 - 2324 | $55 + 10 \log_{10}(p)$ |
| 2324 - 2328 | $61 + 10 \log_{10}(p)$ |
| 2328 - 2337 | $67 + 10 \log_{10}(p)$ |
| 2337 - 2341 | $61 + 10 \log_{10}(p)$ |
| 2341 - 2345 | $55 + 10 \log_{10}(p)$ |
| 2345 - 2360 | $43 + 10 \log_{10}(p)$ ^{Note} |
| 2360 - 2365 | $43 + 10 \log_{10}(p)$ |
| 2365 - 2395 | $70 + 10 \log_{10}(p)$ |
| >2395 | $43 + 10 \log_{10}(p)$ |

Note: Measured at the edges of the highest and lowest frequency range(s) in which the equipment is designed to operate. See Section 5.2 for the permitted frequency ranges for various equipment types.

Unless otherwise stated the results shown in this test report refer only to the sample(s) tested and such sample(s) are retained for 90 days only.

除非另有說明，此報告結果僅對測試之樣品負責，同時此樣品僅保留90天。本報告未經本公司書面許可，不可部份複製。

This document is issued by the Company subject to its General Conditions of Service printed overleaf, available on request or accessible at www.sgs.com/terms_and_conditions.htm and, for electronic format documents, subject to Terms and Conditions for Electronic Documents at www.sgs.com/terms_e-document.htm. Attention is drawn to the limitation of liability, indemnification and jurisdiction issues defined therein. Any holder of this document is advised that information contained hereon reflects the Company’s findings at the time of its intervention only and within the limits of Client’s instructions, if any. The Company’s sole responsibility is to its Client and this document does not exonerate parties to a transaction from exercising all their rights and obligations under the transaction documents. This document cannot be reproduced except in full, without prior written approval of the Company. Any unauthorized alteration, forgery or falsification of the content or appearance of this document is unlawful and offenders may be prosecuted to the fullest extent of the law.

10.2. EUT Setup

Radiated Emission Test Set-Up, Frequency Below 1000MHz

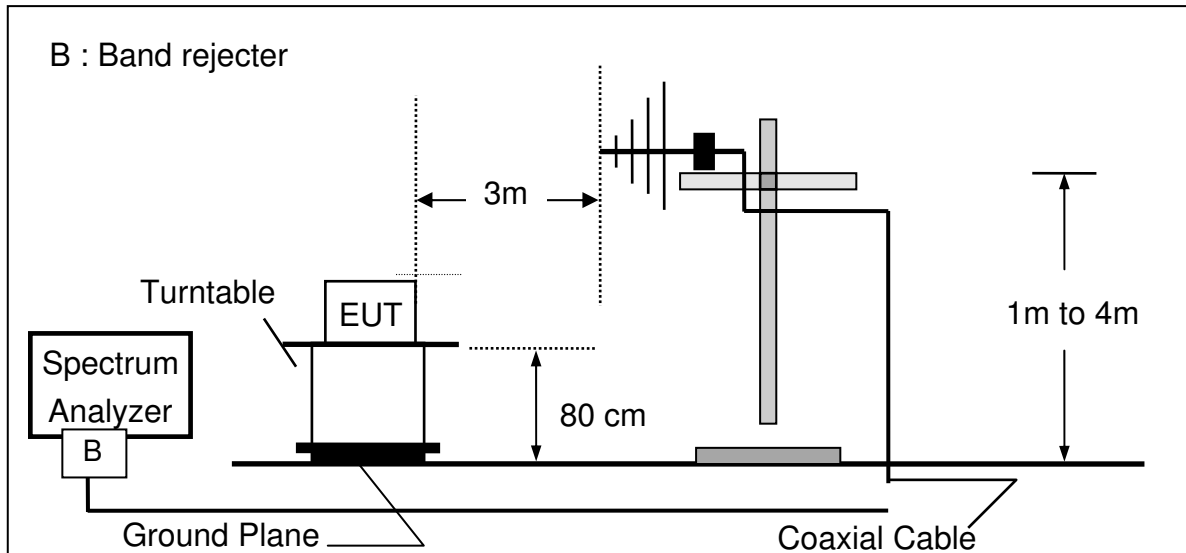

Radiated Emission Test Set-UP Frequency Over 1 GHz

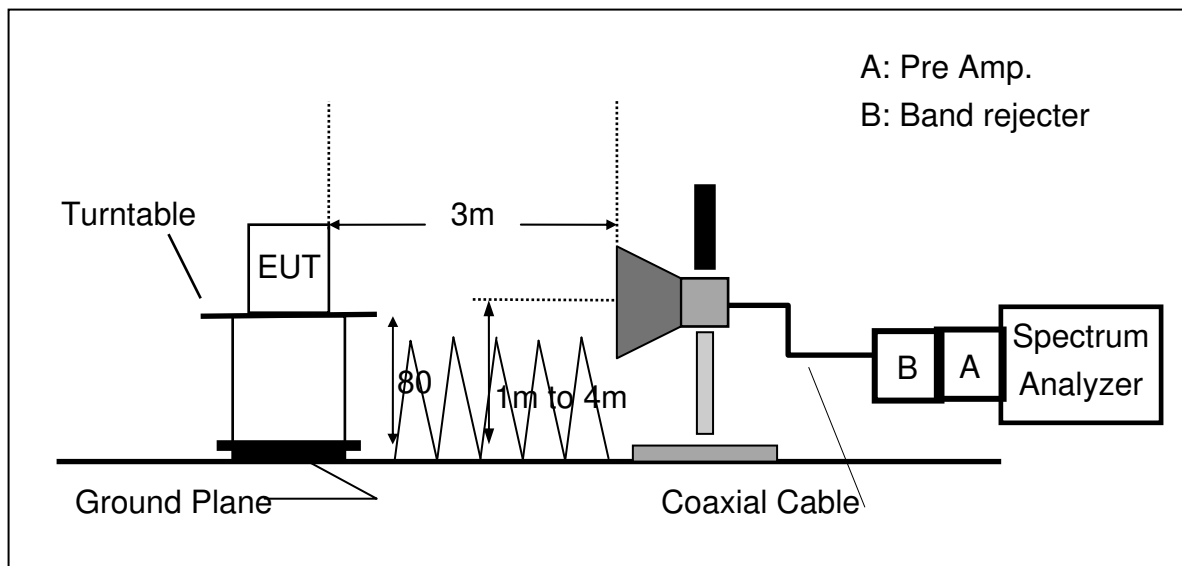

Unless otherwise stated the results shown in this test report refer only to the sample(s) tested and such sample(s) are retained for 90 days only.

除非另有說明，此報告結果僅對測試之樣品負責，同時此樣品僅保留90天。本報告未經本公司書面許可，不可部份複製。

This document is issued by the Company subject to its General Conditions of Service printed overleaf, available on request or accessible at www.sgs.com/terms_and_conditions.htm and, for electronic format documents, subject to Terms and Conditions for Electronic Documents at www.sgs.com/terms_e-document.htm. Attention is drawn to the limitation of liability, indemnification and jurisdiction issues defined therein. Any holder of this document is advised that information contained hereon reflects the Company's findings at the time of its intervention only and within the limits of Client's instructions, if any. The Company's sole responsibility is to its Client and this document does not exonerate parties to a transaction from exercising all their rights and obligations under the transaction documents. This document cannot be reproduced except in full, without prior written approval of the Company. Any unauthorized alteration, forgery or falsification of the content or appearance of this document is unlawful and offenders may be prosecuted to the fullest extent of the law.

10.3. Measurement Procedure:

The EUT was placed on a non-conductive; the measurement antenna was placed at a distance of 3 meters from the EUT. During the tests, the antenna height and the EUT azimuth were varied in order to identify the maximum level of emissions from the EUT. This maximization process was repeated with the EUT positioned in each of its three orthogonal orientations.

The frequency range up to tenth harmonic was investigated for each of three fundamental frequencies (low, middle and high channels). Once spurious emission was identified, the power of the emission was determined using the substitution method.

The spurious emissions attenuation was calculated as the difference between radiated power at the fundamental frequency and the spurious emissions frequency.

$$\text{ERP (dBm)} = \text{SG Level(dBm)} + \text{Antenna Gain(dBd)} + \text{Cable Loss(dB)}$$

$$\text{EIRP (dBm)} = \text{SG Level(dBm)} + \text{Antenna Gain(dBi)} + \text{Cable Loss(dB)}$$

Note : “F” : denotes Fundamental Frequency. ; “H” : denotes Harmonic Frequency.
“E” : denotes Band Edge Frequency. ; “S” : denotes Spurious Frequency.
“---” : denotes Noise Floor.

Unless otherwise stated the results shown in this test report refer only to the sample(s) tested and such sample(s) are retained for 90 days only.

除非另有說明，此報告結果僅對測試之樣品負責，同時此樣品僅保留90天。本報告未經本公司書面許可，不可部份複製。

This document is issued by the Company subject to its General Conditions of Service printed overleaf, available on request or accessible at www.sgs.com/terms_and_conditions.htm and, for electronic format documents, subject to Terms and Conditions for Electronic Documents at www.sgs.com/terms_e-document.htm. Attention is drawn to the limitation of liability, indemnification and jurisdiction issues defined therein. Any holder of this document is advised that information contained hereon reflects the Company's findings at the time of its intervention only and within the limits of Client's instructions, if any. The Company's sole responsibility is to its Client and this document does not exonerate parties to a transaction from exercising all their rights and obligations under the transaction documents. This document cannot be reproduced except in full, without prior written approval of the Company. Any unauthorized alteration, forgery or falsification of the content or appearance of this document is unlawful and offenders may be prosecuted to the fullest extent of the law.

SGS Taiwan Ltd.

No.134,WuKungRoad,NewTaipeiIndustrialPark,WukuDistrict,NewTaipeiCity,Taiwan24803/新北市五股區新北產業園區五工路 134 號

台灣檢驗科技股份有限公司

t (886-2) 2299-3279

f (886-2) 2298-0488

www.tw.sgs.com

Member of SGS Group

10.4. Measurement Equipment Used:

| ERP, EIRP MEASUREMENT EQUIPMENT List 966 Chamber | | | | | |
|--|-----------------|--------------------------------|------------------|------------|------------|
| EQUIPMENT TYPE | MFR | MODEL NUMBER | SERIAL NUMBER | LAST CAL. | CAL DUE. |
| EMI Test Receiver | R&S | ESU 40 | 100363 | 04/12/2016 | 04/11/2017 |
| Broadband Antenna | TESEQ | CBL 6112D | 35240 | 11/03/2016 | 11/02/2017 |
| Broadband Antenna | TESEQ | CBL 6112D | 35243 | 11/09/2016 | 11/08/2017 |
| Horn Antenna | ETS-Lindgren | 3117 | 00143272 | 12/15/2016 | 12/16/2017 |
| Horn Antenna | ETS-Lindgren | 3117 | 143279 | 11/14/2016 | 11/13/2017 |
| Horn Antenna | Schwarzbeck | BBHA9170 | 184 | 12/11/2016 | 12/10/2017 |
| Horn Antenna | Schwarzbeck | BBHA9170 | 185 | 07/24/2016 | 07/23/2017 |
| Pre Amplifier | EMC Instruments | EMC330 | 980096 | 12/12/2016 | 12/11/2017 |
| Pre Amplifier | EMC Instruments | EMC0011830 | 980199 | 12/12/2016 | 12/11/2017 |
| Pre Amplifier | R&S | SCU-18 | 10204 | 12/12/2016 | 12/11/2017 |
| Pre Amplifier | R&S | SCU-26 | 100780 | 12/12/2016 | 12/11/2017 |
| Pre Amplifier | EMC Instruments | EMC184045B | 980135 | 12/12/2016 | 12/11/2017 |
| Coaxial Cable | Huber+Suhner | RG 214/U | 966Rx 9K-30M | 12/12/2016 | 12/11/2017 |
| Coaxial Cable | Huber+Suhner | RG 214/U SUCOFLEX 104 | 966Rx 30M-3G | 12/12/2016 | 12/11/2017 |
| Coaxial Cable | Huber+Suhner | SUCOFLEX 104 | 966Rx 1G-18G | 12/12/2016 | 12/11/2017 |
| Coaxial Cable | Huber+Suhner | mini 141-12 SUCOFLEX 104 | 966Rx 18G-40G | 12/12/2016 | 12/11/2017 |
| Coaxial Cable | Huber+Suhner | SUCOFLEX 104 | 966Tx 30M-18G | 12/12/2016 | 12/11/2017 |
| Coaxial Cable | Huber+Suhner | SUCOFLEX 102 | 966Tx 18G-40G | 12/12/2016 | 12/11/2017 |
| Attenuator | WOKEN | 218FS-10 | RF27 | 12/12/2016 | 12/11/2017 |
| Communication Tester | Anritsu | MT8820C | 6201107337 | 05/25/2016 | 05/24/2017 |
| Site NSA | SGS | 966 Chamber C | SAC-C | 03/02/2017 | 03/01/2018 |
| Site VSWR | SGS | 966 Chamber C | SAC-C | 03/02/2017 | 03/01/2018 |
| DC Power Supply | HOLA | DP-3003 | D7070035 | 05/04/2016 | 05/03/2017 |
| Controller | MF | MF-7802 | N/A | N.C.R. | N.C.R. |
| Antenna Master | MF | N/A | N/A | N.C.R. | N.C.R. |
| Turn Table | MF | N/A | N/A | N.C.R. | N.C.R. |
| Test Software | World-Pallas | Dr. E | V 3.0 Lite | N.C.R. | N.C.R. |

Unless otherwise stated the results shown in this test report refer only to the sample(s) tested and such sample(s) are retained for 90 days only.

除非另有說明，此報告結果僅對測試之樣品負責，同時此樣品僅保留90天。本報告未經本公司書面許可，不可部份複製。

This document is issued by the Company subject to its General Conditions of Service printed overleaf, available on request or accessible at www.sgs.com/terms_and_conditions.htm and, for electronic format documents, subject to Terms and Conditions for Electronic Documents at www.sgs.com/terms_e-document.htm. Attention is drawn to the limitation of liability, indemnification and jurisdiction issues defined therein. Any holder of this document is advised that information contained hereon reflects the Company's findings at the time of its intervention only and within the limits of Client's instructions, if any. The Company's sole responsibility is to its Client and this document does not exonerate parties to a transaction from exercising all their rights and obligations under the transaction documents. This document cannot be reproduced except in full, without prior written approval of the Company. Any unauthorized alteration, forgery or falsification of the content or appearance of this document is unlawful and offenders may be prosecuted to the fullest extent of the law.

SGS Taiwan Ltd.

No.134,WuKungRoad,NewTaipeiIndustrialPark,WukuDistrict,NewTaipeiCity,Taiwan24803/新北市五股區新北產業園區五工路 134 號

台灣檢驗科技股份有限公司

t (886-2) 2299-3279

f (886-2) 2298-0488

www.tw.sgs.com

Member of SGS Group

10.5. Measurement Result:

Radiated Spurious Emission Measurement Result: LTE-Band 2 (The Worst Case)

| | | | |
|-------------------------|------------------------|----------------------------|----------------|
| Operation Mode : | LTE B2 20M QPSK RB 1.0 | Test Date : | 2017/3/15 |
| Fundamental Frequency : | 1860 MHz | Temp. / Humi. : | 22.7deg_C/57RH |
| Operation Band : | Tx CH Low | Test Engineer : | Ashton |
| EUT Pol. : | E2 | Measurement Antenna Pol. : | Vertical |

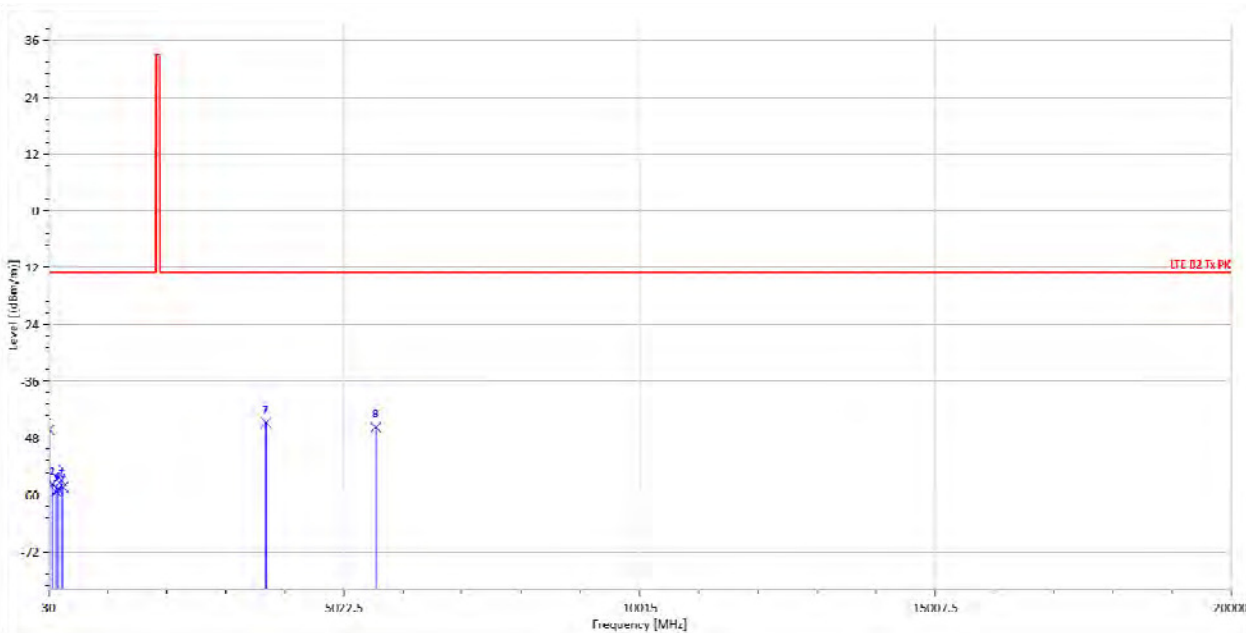

| Freq. MHz | Note F/H/E/S | EIRP dBm | SG Output Level dBm | Antenna Gain dBi | Cable Loss dB | Limit @3m dBm/m | Margin dB |
|--------------|-----------------|-------------|---------------------------|------------------------|---------------------|-----------------------|--------------|
| 42.61 | S | -46.21 | -35.59 | -9.85 | -0.76 | -13 | -33.21 |
| 93.05 | S | -57.73 | -56.32 | -0.28 | -1.14 | -13 | -44.73 |
| 160.95 | S | -59.33 | -61.67 | 3.70 | -1.36 | -13 | -46.33 |
| 188.11 | S | -58.75 | -63.28 | 6.10 | -1.56 | -13 | -45.75 |
| 247.28 | S | -56.96 | -60.50 | 5.39 | -1.85 | -13 | -43.96 |
| 273.47 | S | -58.35 | -61.98 | 5.55 | -1.92 | -13 | -45.35 |
| 3702.00 | H | -44.77 | -49.92 | 12.30 | -7.15 | -13 | -31.77 |
| 5557.00 | H | -45.72 | -49.69 | 12.62 | -8.66 | -13 | -32.72 |

Unless otherwise stated the results shown in this test report refer only to the sample(s) tested and such sample(s) are retained for 90 days only.

除非另有說明，此報告結果僅對測試之樣品負責，同時此樣品僅保留90天。本報告未經本公司書面許可，不可部份複製。

This document is issued by the Company subject to its General Conditions of Service printed overleaf, available on request or accessible at www.sgs.com/terms_and_conditions.htm and, for electronic format documents, subject to Terms and Conditions for Electronic Documents at www.sgs.com/terms_e-document.htm. Attention is drawn to the limitation of liability, indemnification and jurisdiction issues defined therein. Any holder of this document is advised that information contained hereon reflects the Company's findings at the time of its intervention only and within the limits of Client's instructions, if any. The Company's sole responsibility is to its Client and this document does not exonerate parties to a transaction from exercising all their rights and obligations under the transaction documents. This document cannot be reproduced except in full, without prior written approval of the Company. Any unauthorized alteration, forgery or falsification of the content or appearance of this document is unlawful and offenders may be prosecuted to the fullest extent of the law.

| | | | |
|-------------------------|------------------------|----------------------------|----------------|
| Operation Mode : | LTE B2 20M QPSK RB 1.0 | Test Date : | 2017/3/15 |
| Fundamental Frequency : | 1860 MHz | Temp. / Humi. : | 22.7deg_C/57RH |
| Operation Band : | Tx CH Low | Test Engineer : | Ashton |
| EUT Pol. : | E2 | Measurement Antenna Pol. : | Horizontal |

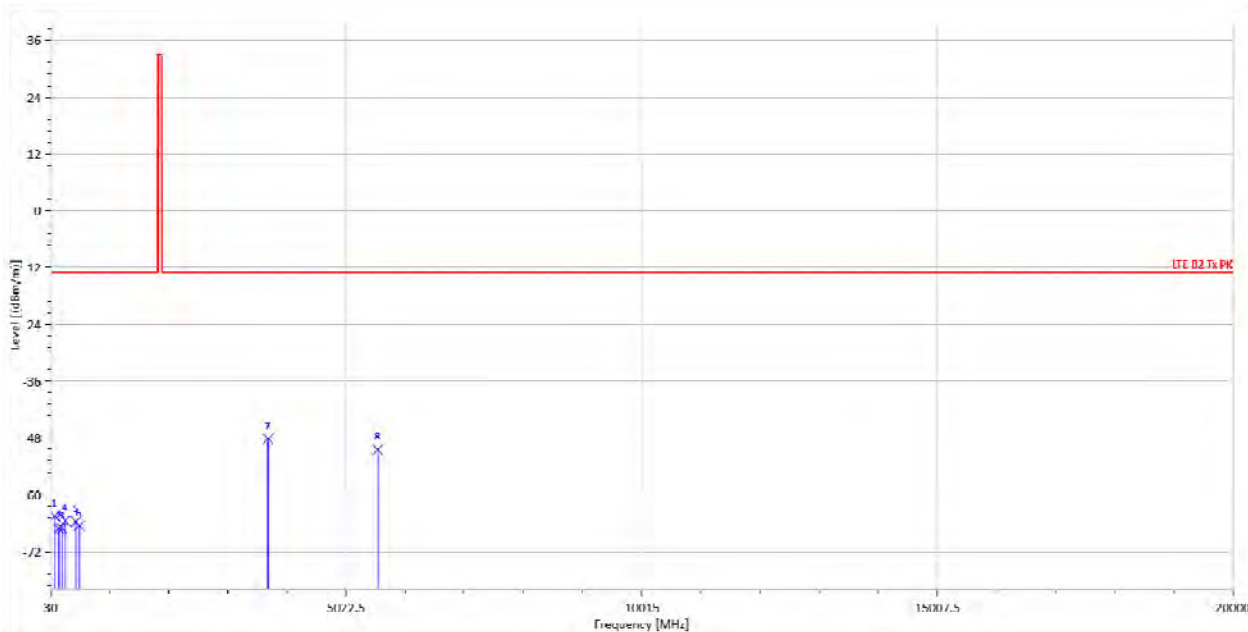

| Freq. MHz | Note F/H/E/S | EIRP dBm | SG Output Level dBm | Antenna Gain dBi | Cable Loss dB | Limit @3m dBm/m | Margin dB |
|--------------|-----------------|-------------|---------------------------|------------------------|---------------------|-----------------------|--------------|
| 101.78 | S | -64.51 | -62.37 | -0.96 | -1.18 | -13 | -51.51 |
| 172.59 | S | -67.12 | -70.51 | 4.98 | -1.58 | -13 | -54.12 |
| 224.97 | S | -67.07 | -71.74 | 6.40 | -1.73 | -13 | -54.07 |
| 277.35 | S | -65.47 | -69.16 | 5.67 | -1.98 | -13 | -52.47 |
| 457.77 | S | -65.68 | -69.39 | 6.29 | -2.58 | -13 | -52.68 |
| 515.00 | S | -66.50 | -70.37 | 6.40 | -2.53 | -13 | -53.50 |
| 3702.00 | H | -48.14 | -53.29 | 12.30 | -7.15 | -13 | -35.14 |
| 5557.00 | H | -50.47 | -54.43 | 12.62 | -8.66 | -13 | -37.47 |

Unless otherwise stated the results shown in this test report refer only to the sample(s) tested and such sample(s) are retained for 90 days only.

除非另有說明，此報告結果僅對測試之樣品負責，同時此樣品僅保留90天。本報告未經本公司書面許可，不可部份複製。

This document is issued by the Company subject to its General Conditions of Service printed overleaf, available on request or accessible at www.sgs.com/terms_and_conditions.htm and, for electronic format documents, subject to Terms and Conditions for Electronic Documents at www.sgs.com/terms_e-document.htm. Attention is drawn to the limitation of liability, indemnification and jurisdiction issues defined therein. Any holder of this document is advised that information contained hereon reflects the Company's findings at the time of its intervention only and within the limits of Client's instructions, if any. The Company's sole responsibility is to its Client and this document does not exonerate parties to a transaction from exercising all their rights and obligations under the transaction documents. This document cannot be reproduced except in full, without prior written approval of the Company. Any unauthorized alteration, forgery or falsification of the content or appearance of this document is unlawful and offenders may be prosecuted to the fullest extent of the law.

SGS Taiwan Ltd.

No.134,WuKungRoad,NewTaipeiIndustrialPark,WukuDistrict,NewTaipeiCity,Taiwan24803/新北市五股區新北產業園區五工路 134 號

台灣檢驗科技股份有限公司

t (886-2) 2299-3279

f (886-2) 2298-0488

www.tw.sgs.com

Member of SGS Group

| | | | |
|-------------------------|------------------------|----------------------------|----------------|
| Operation Mode : | LTE B2 20M QPSK RB 1.0 | Test Date : | 2017/3/15 |
| Fundamental Frequency : | 1880 MHz | Temp. / Humi. : | 22.7deg_C/57RH |
| Operation Band : | Tx CH Mid | Test Engineer : | Ashton |
| EUT Pol. : | E2 | Measurement Antenna Pol. : | Vertical |

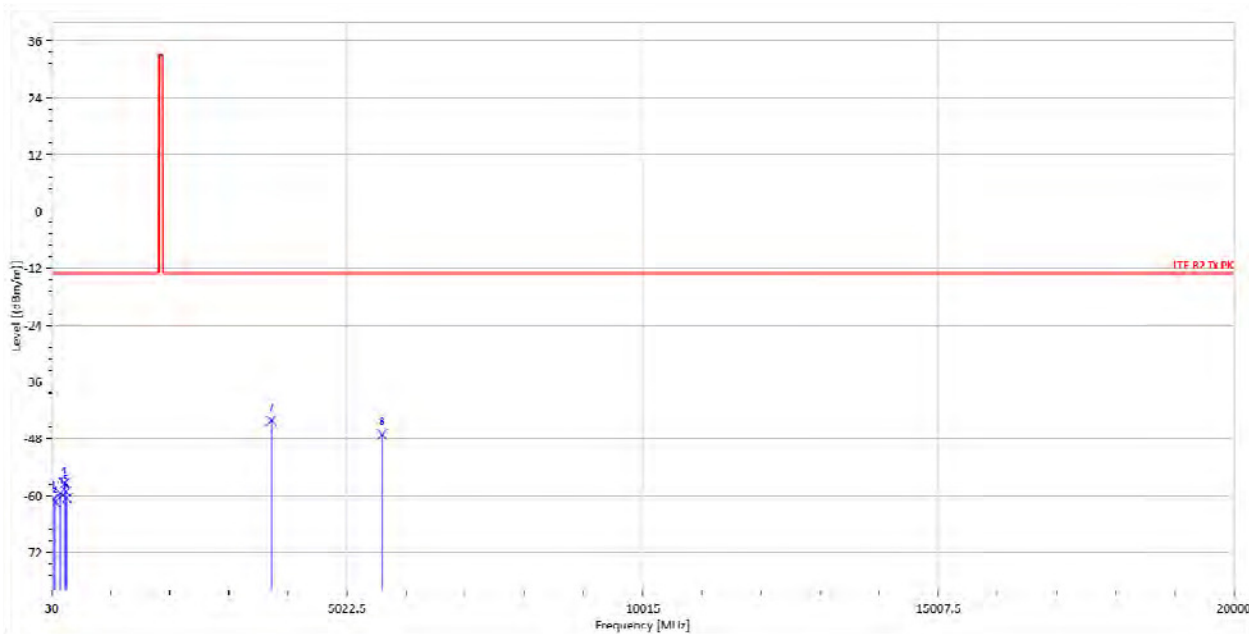

| Freq. | Note | EIRP | SG Output | Antenna | Cable | Limit | Margin |
|---------|---------|--------|--------------|-------------|------------|--------------|--------|
| MHz | F/H/E/S | dBm | Level dBm | Gain dBi | Loss dB | @3m dBm/m | dB |
| 61.04 | S | -60.64 | -58.90 | -0.79 | -0.95 | -13 | -47.64 |
| 91.11 | S | -61.42 | -60.20 | -0.10 | -1.12 | -13 | -48.42 |
| 177.44 | S | -59.55 | -63.50 | 5.46 | -1.51 | -13 | -46.55 |
| 248.25 | S | -57.44 | -60.94 | 5.35 | -1.85 | -13 | -44.44 |
| 275.41 | S | -59.22 | -62.90 | 5.61 | -1.92 | -13 | -46.22 |
| 288.02 | S | -60.57 | -64.40 | 5.84 | -2.00 | -13 | -47.57 |
| 3744.00 | H | -44.14 | -49.23 | 12.30 | -7.21 | -13 | -31.14 |
| 5613.00 | H | -47.14 | -50.99 | 12.65 | -8.80 | -13 | -34.14 |

Unless otherwise stated the results shown in this test report refer only to the sample(s) tested and such sample(s) are retained for 90 days only.

除非另有說明，此報告結果僅對測試之樣品負責，同時此樣品僅保留90天。本報告未經本公司書面許可，不可部份複製。

This document is issued by the Company subject to its General Conditions of Service printed overleaf, available on request or accessible at www.sgs.com/terms_and_conditions.htm and, for electronic format documents, subject to Terms and Conditions for Electronic Documents at www.sgs.com/terms_e-document.htm. Attention is drawn to the limitation of liability, indemnification and jurisdiction issues defined therein. Any holder of this document is advised that information contained hereon reflects the Company's findings at the time of its intervention only and within the limits of Client's instructions, if any. The Company's sole responsibility is to its Client and this document does not exonerate parties to a transaction from exercising all their rights and obligations under the transaction documents. This document cannot be reproduced except in full, without prior written approval of the Company. Any unauthorized alteration, forgery or falsification of the content or appearance of this document is unlawful and offenders may be prosecuted to the fullest extent of the law.

SGS Taiwan Ltd.

No.134,WuKungRoad,NewTaipeiIndustrialPark,WukuDistrict,NewTaipeiCity,Taiwan24803/新北市五股區新北產業園區五工路 134 號

台灣檢驗科技股份有限公司

t (886-2) 2299-3279

f (886-2) 2298-0488

www.tw.sgs.com

Member of SGS Group

| | | | |
|-------------------------|------------------------|----------------------------|----------------|
| Operation Mode : | LTE B2 20M QPSK RB 1.0 | Test Date : | 2017/3/15 |
| Fundamental Frequency : | 1880 MHz | Temp. / Humi. : | 22.7deg_C/57RH |
| Operation Band : | Tx CH Mid | Test Engineer : | Ashton |
| EUT Pol. : | E2 | Measurement Antenna Pol. : | Horizontal |

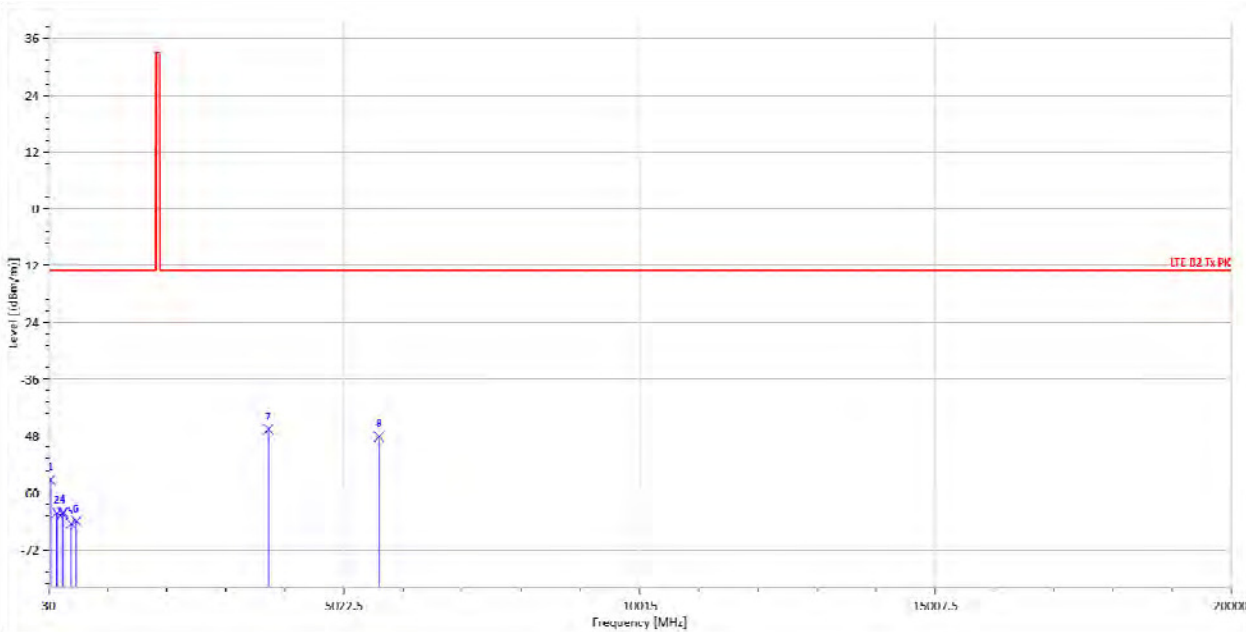

| Freq. MHz | Note F/H/E/S | EIRP dBm | SG Output Level dBm | Antenna Gain dBi | Cable Loss dB | Limit @3m dBm/m | Margin dB |
|--------------|-----------------|-------------|---------------------------|------------------------|---------------------|-----------------------|--------------|
| 62.01 | S | -57.29 | -55.64 | -0.66 | -1.00 | -13 | -44.29 |
| 170.65 | S | -64.19 | -67.49 | 4.78 | -1.49 | -13 | -51.19 |
| 265.71 | S | -64.37 | -67.57 | 5.08 | -1.88 | -13 | -51.37 |
| 278.32 | S | -64.10 | -67.82 | 5.70 | -1.98 | -13 | -51.10 |
| 409.27 | S | -66.52 | -69.90 | 5.85 | -2.47 | -13 | -53.52 |
| 496.57 | S | -65.94 | -69.82 | 6.38 | -2.50 | -13 | -52.94 |
| 3744.00 | H | -46.55 | -51.64 | 12.30 | -7.21 | -13 | -33.55 |
| 5613.00 | H | -48.11 | -51.96 | 12.65 | -8.80 | -13 | -35.11 |

Unless otherwise stated the results shown in this test report refer only to the sample(s) tested and such sample(s) are retained for 90 days only.

除非另有說明，此報告結果僅對測試之樣品負責，同時此樣品僅保留90天。本報告未經本公司書面許可，不可部份複製。

This document is issued by the Company subject to its General Conditions of Service printed overleaf, available on request or accessible at www.sgs.com/terms_and_conditions.htm and, for electronic format documents, subject to Terms and Conditions for Electronic Documents at www.sgs.com/terms_e-document.htm. Attention is drawn to the limitation of liability, indemnification and jurisdiction issues defined therein. Any holder of this document is advised that information contained hereon reflects the Company's findings at the time of its intervention only and within the limits of Client's instructions, if any. The Company's sole responsibility is to its Client and this document does not exonerate parties to a transaction from exercising all their rights and obligations under the transaction documents. This document cannot be reproduced except in full, without prior written approval of the Company. Any unauthorized alteration, forgery or falsification of the content or appearance of this document is unlawful and offenders may be prosecuted to the fullest extent of the law.

SGS Taiwan Ltd.

No.134,WuKungRoad,NewTaipeiIndustrialPark,WukuDistrict,NewTaipeiCity,Taiwan24803/新北市五股區新北產業園區五工路 134 號

台灣檢驗科技股份有限公司

t (886-2) 2299-3279

f (886-2) 2298-0488

www.tw.sgs.com

Member of SGS Group

| | | | |
|-------------------------|------------------------|----------------------------|----------------|
| Operation Mode : | LTE B2 20M QPSK RB 1.0 | Test Date : | 2017/3/15 |
| Fundamental Frequency : | 1900 MHz | Temp. / Humi. : | 22.7deg_C/57RH |
| Operation Band : | Tx CH High | Test Engineer : | Ashton |
| EUT Pol. : | E2 | Measurement Antenna Pol. : | Vertical |

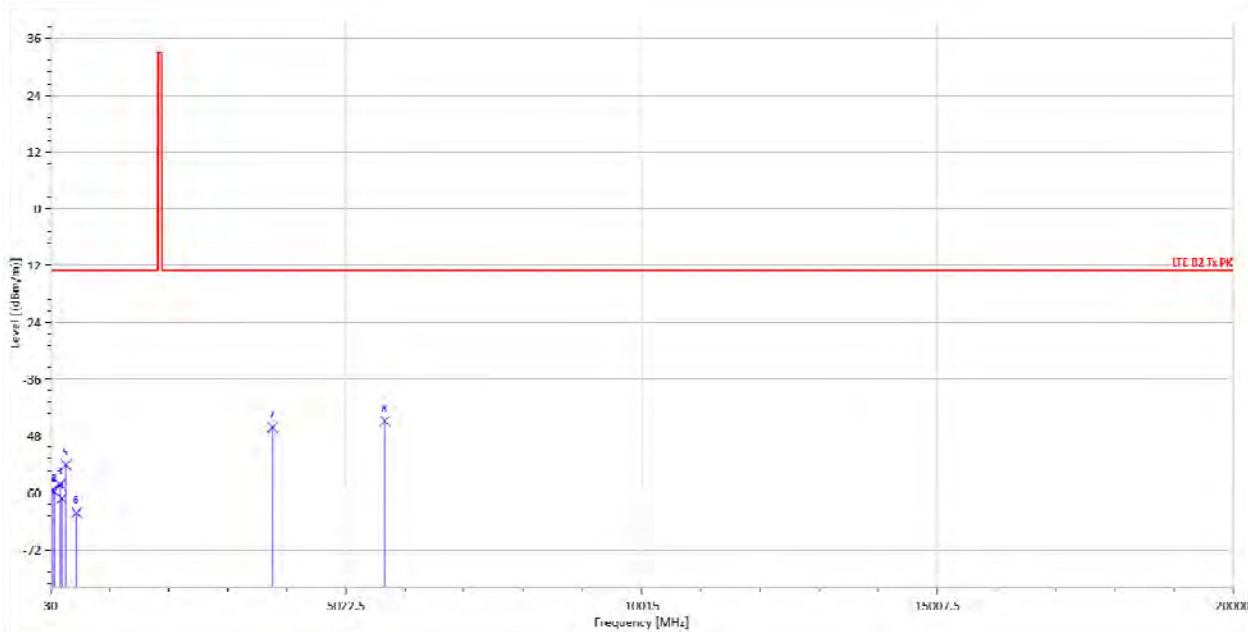

| Freq. MHz | Note F/H/E/S | EIRP dBm | SG Output Level dBm | Antenna Gain dBi | Cable Loss dB | Limit @3m dBm/m | Margin dB |
|--------------|-----------------|-------------|---------------------------|------------------------|---------------------|-----------------------|--------------|
| 60.07 | S | -59.48 | -57.68 | -0.92 | -0.89 | -13 | -46.48 |
| 96.93 | S | -59.67 | -57.90 | -0.62 | -1.15 | -13 | -46.67 |
| 188.11 | S | -58.20 | -62.73 | 6.10 | -1.56 | -13 | -45.20 |
| 220.12 | S | -61.22 | -66.02 | 6.55 | -1.75 | -13 | -48.22 |
| 288.99 | S | -54.15 | -58.01 | 5.85 | -1.99 | -13 | -41.15 |
| 467.47 | S | -64.24 | -67.95 | 6.31 | -2.60 | -13 | -51.24 |
| 3779.00 | H | -46.13 | -51.18 | 12.30 | -7.25 | -13 | -33.13 |
| 5676.00 | H | -44.83 | -48.65 | 12.67 | -8.86 | -13 | -31.83 |

Unless otherwise stated the results shown in this test report refer only to the sample(s) tested and such sample(s) are retained for 90 days only.

除非另有說明，此報告結果僅對測試之樣品負責，同時此樣品僅保留90天。本報告未經本公司書面許可，不可部份複製。

This document is issued by the Company subject to its General Conditions of Service printed overleaf, available on request or accessible at www.sgs.com/terms_and_conditions.htm and, for electronic format documents, subject to Terms and Conditions for Electronic Documents at www.sgs.com/terms_e-document.htm. Attention is drawn to the limitation of liability, indemnification and jurisdiction issues defined therein. Any holder of this document is advised that information contained hereon reflects the Company's findings at the time of its intervention only and within the limits of Client's instructions, if any. The Company's sole responsibility is to its Client and this document does not exonerate parties to a transaction from exercising all their rights and obligations under the transaction documents. This document cannot be reproduced except in full, without prior written approval of the Company. Any unauthorized alteration, forgery or falsification of the content or appearance of this document is unlawful and offenders may be prosecuted to the fullest extent of the law.

SGS Taiwan Ltd.

No.134,WuKungRoad,NewTaipeiIndustrialPark,WukuDistrict,NewTaipeiCity,Taiwan24803/新北市五股區新北產業園區五工路 134 號

台灣檢驗科技股份有限公司

t (886-2) 2299-3279

f (886-2) 2298-0488

www.tw.sgs.com

Member of SGS Group

| | | | |
|-------------------------|------------------------|----------------------------|----------------|
| Operation Mode : | LTE B2 20M QPSK RB 1.0 | Test Date : | 2017/3/15 |
| Fundamental Frequency : | 1900 MHz | Temp. / Humi. : | 22.7deg_C/57RH |
| Operation Band : | Tx CH High | Test Engineer : | Ashton |
| EUT Pol. : | E2 | Measurement Antenna Pol. : | Horizontal |

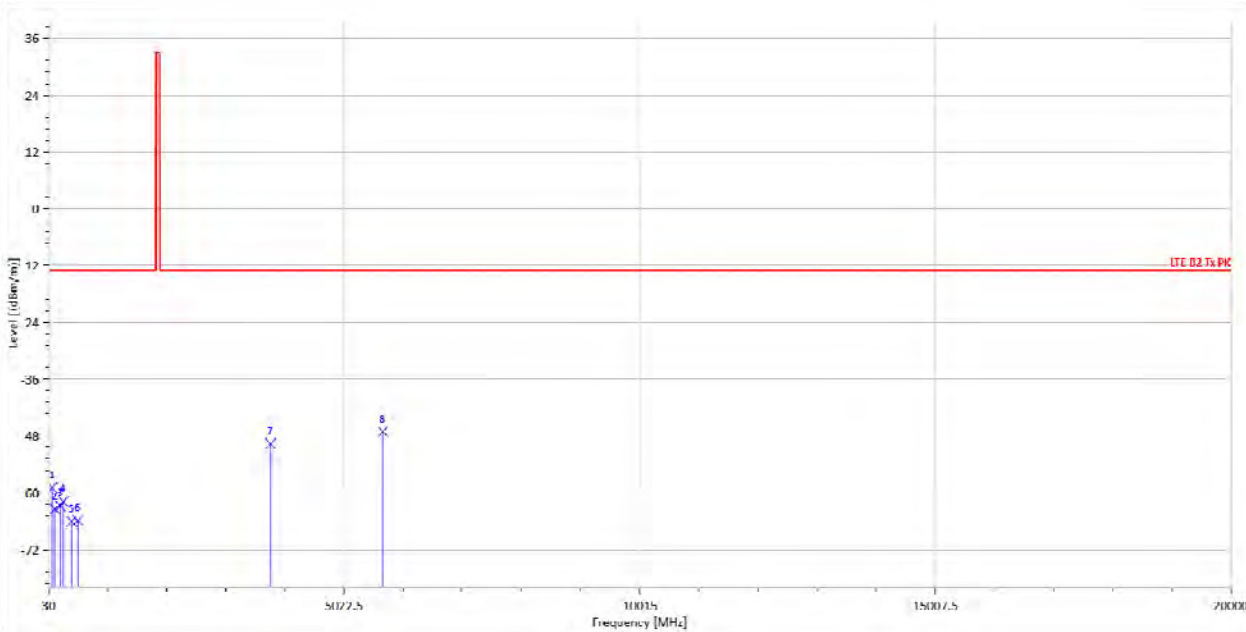

| Freq. | Note | EIRP | SG Output | Antenna | Cable | Limit | Margin |
|---------|---------|--------|-----------|---------|-------|-------|--------|
| MHz | F/H/E/S | dBm | Level | Gain | Loss | @3m | dB |
| 91.11 | S | -58.90 | -57.68 | -0.10 | -1.12 | -13 | -45.90 |
| 134.76 | S | -63.43 | -62.54 | 0.48 | -1.38 | -13 | -50.43 |
| 226.91 | S | -62.76 | -67.36 | 6.34 | -1.74 | -13 | -49.76 |
| 277.35 | S | -61.85 | -65.55 | 5.67 | -1.98 | -13 | -48.85 |
| 418.97 | S | -66.01 | -69.50 | 5.95 | -2.45 | -13 | -53.01 |
| 524.70 | S | -65.84 | -69.76 | 6.40 | -2.48 | -13 | -52.84 |
| 3779.00 | H | -49.63 | -54.69 | 12.30 | -7.25 | -13 | -36.63 |
| 5676.00 | H | -47.03 | -50.84 | 12.67 | -8.86 | -13 | -34.03 |

Unless otherwise stated the results shown in this test report refer only to the sample(s) tested and such sample(s) are retained for 90 days only.

除非另有說明，此報告結果僅對測試之樣品負責，同時此樣品僅保留90天。本報告未經本公司書面許可，不可部份複製。

This document is issued by the Company subject to its General Conditions of Service printed overleaf, available on request or accessible at www.sgs.com/terms_and_conditions.htm and, for electronic format documents, subject to Terms and Conditions for Electronic Documents at www.sgs.com/terms_e-document.htm. Attention is drawn to the limitation of liability, indemnification and jurisdiction issues defined therein. Any holder of this document is advised that information contained hereon reflects the Company's findings at the time of its intervention only and within the limits of Client's instructions, if any. The Company's sole responsibility is to its Client and this document does not exonerate parties to a transaction from exercising all their rights and obligations under the transaction documents. This document cannot be reproduced except in full, without prior written approval of the Company. Any unauthorized alteration, forgery or falsification of the content or appearance of this document is unlawful and offenders may be prosecuted to the fullest extent of the law.

SGS Taiwan Ltd.

No.134,WuKungRoad,NewTaipeiIndustrialPark,WukuDistrict,NewTaipeiCity,Taiwan24803/新北市五股區新北產業園區五工路 134 號

台灣檢驗科技股份有限公司

t (886-2) 2299-3279

f (886-2) 2298-0488

www.tw.sgs.com

Member of SGS Group

Radiated Spurious Emission Measurement Result: LTE-Band 4 (The Worst Case)

| | | | |
|-------------------------|--------------------------|----------------------------|----------------|
| Operation Mode : | LTE B4 10M 16QAM RB 1.49 | Test Date : | 2017/3/15 |
| Fundamental Frequency : | 1715 MHz | Temp. / Humi. : | 22.7deg_C/57RH |
| Operation Band : | Tx CH Low | Test Engineer : | Ashton |
| EUT Pol. : | E2 | Measurement Antenna Pol. : | Vertical |

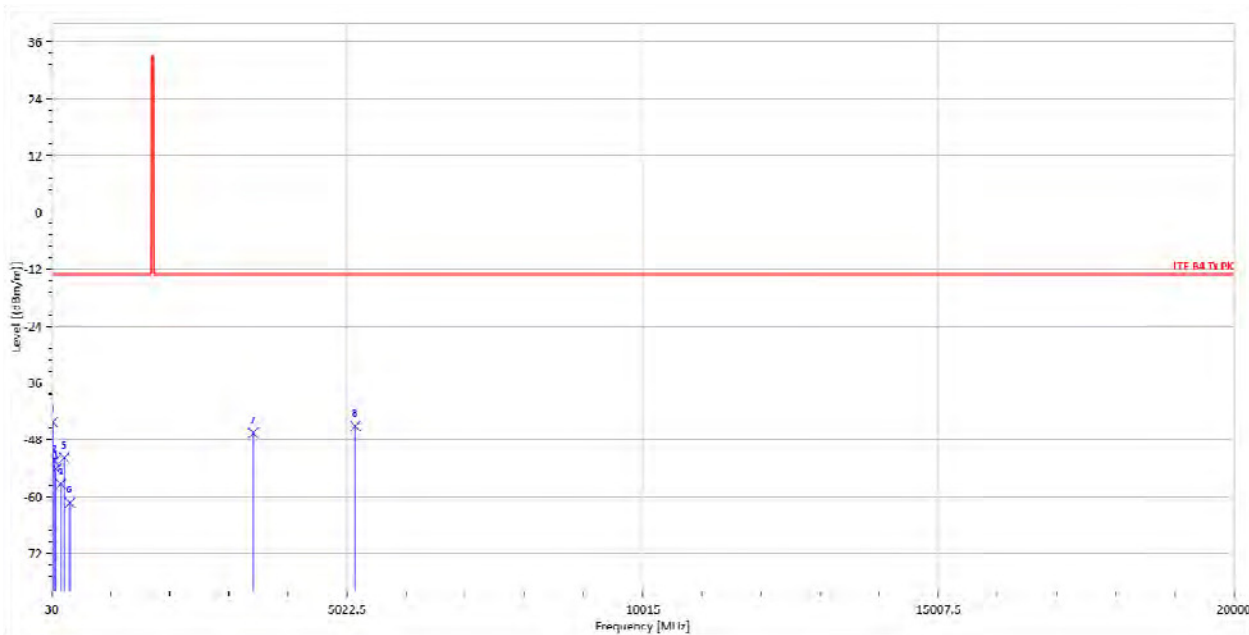

| Freq. | Note | EIRP | SG Output | Antenna | Cable | Limit | Margin |
|---------|---------|--------|-----------|---------|-------|-------|--------|
| MHz | F/H/E/S | dBm | Level | Gain | Loss | @3m | dB |
| | | | dBm | dBi | dB | dBm/m | |
| 50.37 | S | -44.30 | -38.42 | -4.76 | -1.12 | -13 | -31.30 |
| 82.38 | S | -52.53 | -51.53 | 0.51 | -1.51 | -13 | -39.53 |
| 101.78 | S | -54.13 | -51.50 | -0.96 | -1.67 | -13 | -41.13 |
| 186.17 | S | -57.39 | -61.03 | 6.01 | -2.37 | -13 | -44.39 |
| 244.37 | S | -51.80 | -54.65 | 5.52 | -2.67 | -13 | -38.80 |
| 338.46 | S | -61.33 | -64.09 | 5.91 | -3.14 | -13 | -48.33 |
| 3436.00 | H | -46.59 | -51.83 | 12.17 | -6.94 | -13 | -33.59 |
| 5158.00 | H | -45.14 | -49.07 | 12.39 | -8.46 | -13 | -32.14 |

Unless otherwise stated the results shown in this test report refer only to the sample(s) tested and such sample(s) are retained for 90 days only.

除非另有說明，此報告結果僅對測試之樣品負責，同時此樣品僅保留90天。本報告未經本公司書面許可，不可部份複製。

This document is issued by the Company subject to its General Conditions of Service printed overleaf, available on request or accessible at www.sgs.com/terms_and_conditions.htm and, for electronic format documents, subject to Terms and Conditions for Electronic Documents at www.sgs.com/terms_e-document.htm. Attention is drawn to the limitation of liability, indemnification and jurisdiction issues defined therein. Any holder of this document is advised that information contained hereon reflects the Company's findings at the time of its intervention only and within the limits of Client's instructions, if any. The Company's sole responsibility is to its Client and this document does not exonerate parties to a transaction from exercising all their rights and obligations under the transaction documents. This document cannot be reproduced except in full, without prior written approval of the Company. Any unauthorized alteration, forgery or falsification of the content or appearance of this document is unlawful and offenders may be prosecuted to the fullest extent of the law.

SGS Taiwan Ltd.

No.134,WuKungRoad,NewTaipeiIndustrialPark,WukuDistrict,NewTaipeiCity,Taiwan24803/新北市五股區新北產業園區五工路 134 號

台灣檢驗科技股份有限公司

t (886-2) 2299-3279

f (886-2) 2298-0488

www.tw.sgs.com

Member of SGS Group

| | | | |
|-------------------------|--------------------------|----------------------------|----------------|
| Operation Mode : | LTE B4 10M 16QAM RB 1.49 | Test Date : | 2017/3/15 |
| Fundamental Frequency : | 1715 MHz | Temp. / Humi. : | 22.7deg_C/57RH |
| Operation Band : | Tx CH Low | Test Engineer : | Ashton |
| EUT Pol. : | E2 | Measurement Antenna Pol. : | Horizontal |

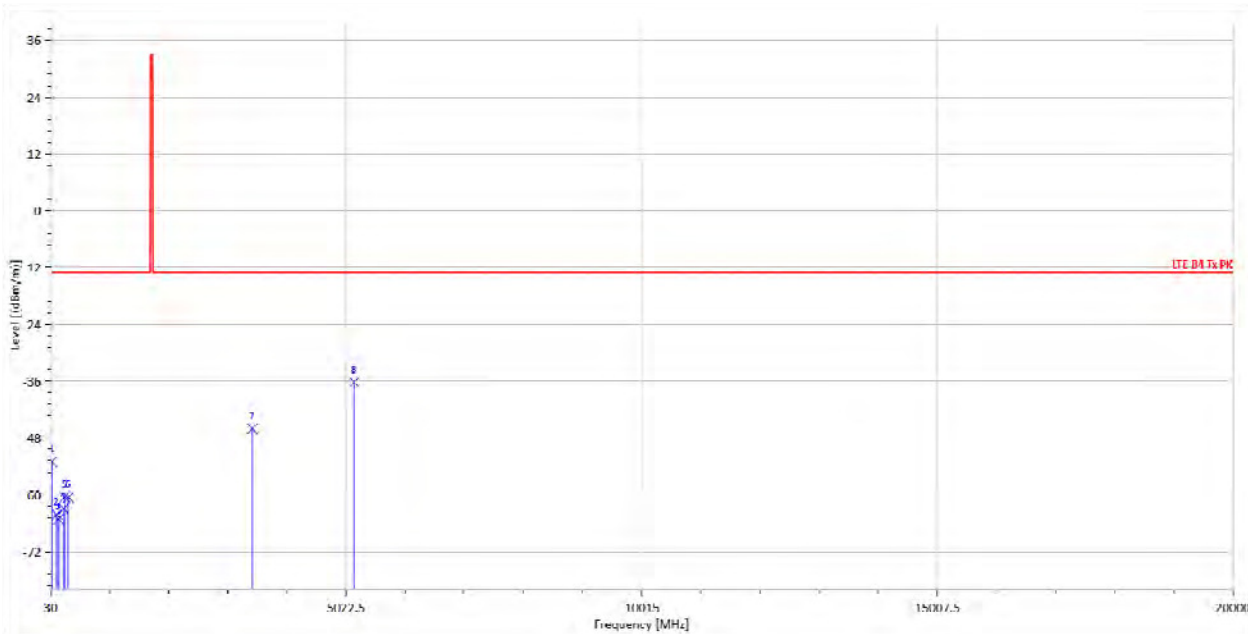

| Freq. MHz | Note F/H/E/S | EIRP dBm | SG Output Level dBm | Antenna Gain dBi | Cable Loss dB | Limit @3m dBm/m | Margin dB |
|--------------|-----------------|-------------|---------------------------|------------------------|---------------------|-----------------------|--------------|
| 52.31 | S | -52.98 | -47.79 | -3.99 | -1.21 | -13 | -39.98 |
| 132.82 | S | -64.17 | -62.51 | 0.24 | -1.90 | -13 | -51.17 |
| 161.92 | S | -65.13 | -66.87 | 3.81 | -2.08 | -13 | -52.13 |
| 250.19 | S | -62.91 | -65.38 | 5.26 | -2.79 | -13 | -49.91 |
| 268.62 | S | -60.43 | -62.87 | 5.32 | -2.88 | -13 | -47.43 |
| 327.79 | S | -60.52 | -63.15 | 5.92 | -3.29 | -13 | -47.52 |
| 3436.00 | H | -46.00 | -51.23 | 12.17 | -6.94 | -13 | -33.00 |
| 5158.00 | H | -36.18 | -40.12 | 12.39 | -8.46 | -13 | -23.18 |

Unless otherwise stated the results shown in this test report refer only to the sample(s) tested and such sample(s) are retained for 90 days only.

除非另有說明，此報告結果僅對測試之樣品負責，同時此樣品僅保留90天。本報告未經本公司書面許可，不可部份複製。

This document is issued by the Company subject to its General Conditions of Service printed overleaf, available on request or accessible at www.sgs.com/terms_and_conditions.htm and, for electronic format documents, subject to Terms and Conditions for Electronic Documents at www.sgs.com/terms_e-document.htm. Attention is drawn to the limitation of liability, indemnification and jurisdiction issues defined therein. Any holder of this document is advised that information contained hereon reflects the Company's findings at the time of its intervention only and within the limits of Client's instructions, if any. The Company's sole responsibility is to its Client and this document does not exonerate parties to a transaction from exercising all their rights and obligations under the transaction documents. This document cannot be reproduced except in full, without prior written approval of the Company. Any unauthorized alteration, forgery or falsification of the content or appearance of this document is unlawful and offenders may be prosecuted to the fullest extent of the law.

SGS Taiwan Ltd.

No.134,WuKungRoad,NewTaipeiIndustrialPark,WukuDistrict,NewTaipeiCity,Taiwan24803/新北市五股區新北產業園區五工路 134 號

台灣檢驗科技股份有限公司

t (886-2) 2299-3279

f (886-2) 2298-0488

www.tw.sgs.com

Member of SGS Group

| | | | |
|-------------------------|--------------------------|----------------------------|----------------|
| Operation Mode : | LTE B4 10M 16QAM RB 1.49 | Test Date : | 2017/3/15 |
| Fundamental Frequency : | 1732.5 MHz | Temp. / Humi. : | 22.7deg_C/57RH |
| Operation Band : | Tx CH Mid | Test Engineer : | Ashton |
| EUT Pol. : | E2 | Measurement Antenna Pol. : | Vertical |

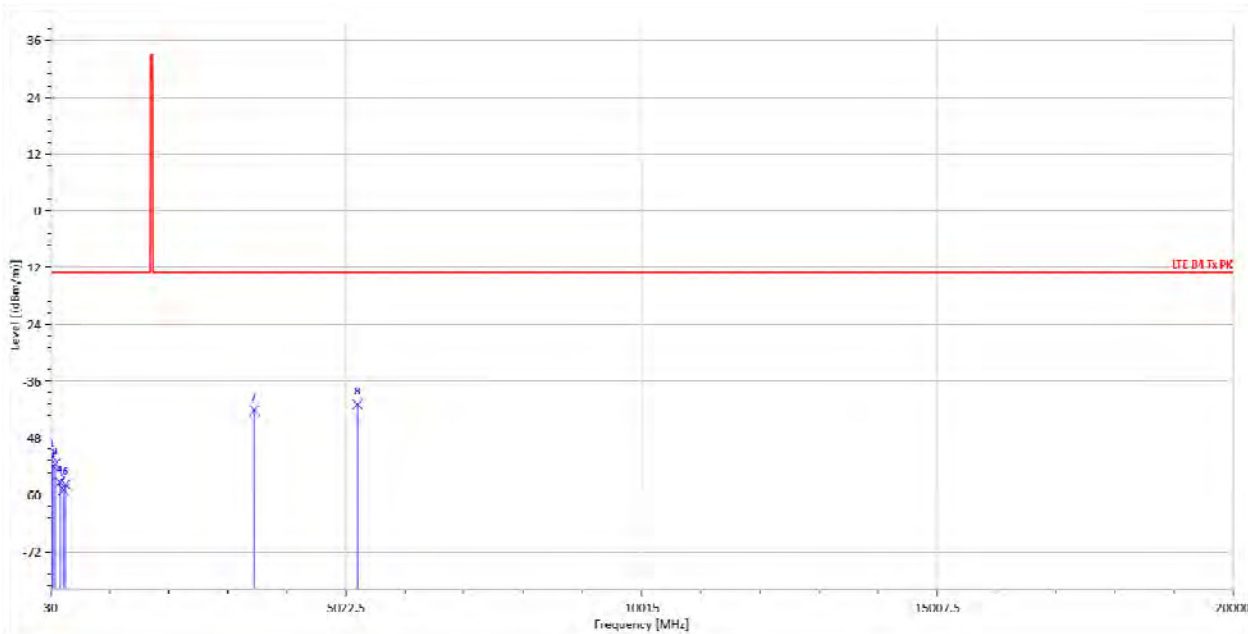

| Freq. | Note | EIRP | SG Output | Antenna | Cable | Limit | Margin |
|---------|---------|--------|-----------|---------|-------|-------|--------|
| MHz | F/H/E/S | dBm | Level | Gain | Loss | @3m | dB |
| 48.43 | S | -51.85 | -44.86 | -5.89 | -1.10 | -13 | -38.85 |
| 69.77 | S | -53.99 | -52.97 | 0.38 | -1.40 | -13 | -40.99 |
| 109.54 | S | -53.45 | -50.45 | -1.25 | -1.76 | -13 | -40.45 |
| 188.11 | S | -57.36 | -61.16 | 6.10 | -2.30 | -13 | -44.36 |
| 247.28 | S | -58.89 | -61.49 | 5.39 | -2.79 | -13 | -45.89 |
| 282.20 | S | -57.84 | -60.67 | 5.78 | -2.95 | -13 | -44.84 |
| 3471.00 | H | -42.15 | -47.53 | 12.24 | -6.85 | -13 | -29.15 |
| 5214.00 | H | -40.92 | -44.82 | 12.43 | -8.53 | -13 | -27.92 |

Unless otherwise stated the results shown in this test report refer only to the sample(s) tested and such sample(s) are retained for 90 days only.

除非另有說明，此報告結果僅對測試之樣品負責，同時此樣品僅保留90天。本報告未經本公司書面許可，不可部份複製。

This document is issued by the Company subject to its General Conditions of Service printed overleaf, available on request or accessible at www.sgs.com/terms_and_conditions.htm and, for electronic format documents, subject to Terms and Conditions for Electronic Documents at www.sgs.com/terms_e-document.htm. Attention is drawn to the limitation of liability, indemnification and jurisdiction issues defined therein. Any holder of this document is advised that information contained hereon reflects the Company's findings at the time of its intervention only and within the limits of Client's instructions, if any. The Company's sole responsibility is to its Client and this document does not exonerate parties to a transaction from exercising all their rights and obligations under the transaction documents. This document cannot be reproduced except in full, without prior written approval of the Company. Any unauthorized alteration, forgery or falsification of the content or appearance of this document is unlawful and offenders may be prosecuted to the fullest extent of the law.

SGS Taiwan Ltd.

No.134,WuKungRoad,NewTaipeiIndustrialPark,WukuDistrict,NewTaipeiCity,Taiwan24803/新北市五股區新北產業園區五工路 134 號

台灣檢驗科技股份有限公司

t (886-2) 2299-3279

f (886-2) 2298-0488

www.tw.sgs.com

Member of SGS Group

| | | | |
|-------------------------|--------------------------|----------------------------|----------------|
| Operation Mode : | LTE B4 10M 16QAM RB 1.49 | Test Date : | 2017/3/15 |
| Fundamental Frequency : | 1732.5 MHz | Temp. / Humi. : | 22.7deg_C/57RH |
| Operation Band : | Tx CH Mid | Test Engineer : | Ashton |
| EUT Pol. : | E2 | Measurement Antenna Pol. : | Horizontal |

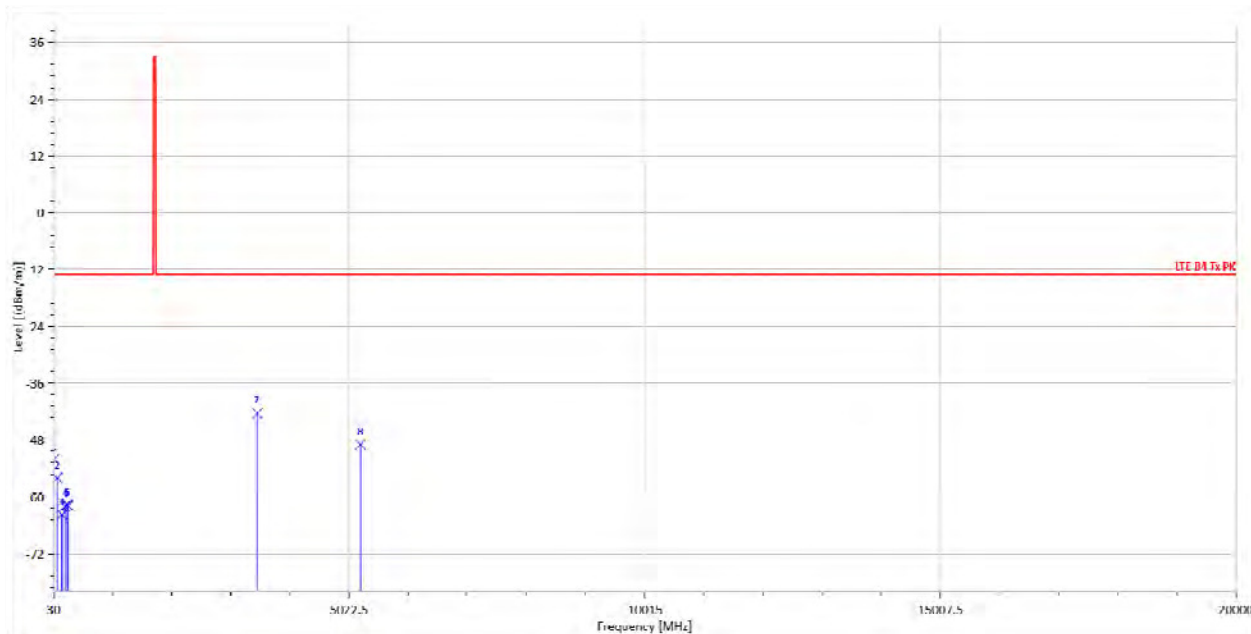

| Freq. MHz | Note F/H/E/S | EIRP dBm | SG Output Level dBm | Antenna Gain dBi | Cable Loss dB | Limit @3m dBm/m | Margin dB |
|--------------|-----------------|-------------|---------------------------|------------------------|---------------------|-----------------------|--------------|
| 32.91 | S | -52.10 | -33.46 | -17.72 | -0.92 | -13 | -39.10 |
| 92.08 | S | -56.02 | -54.23 | -0.19 | -1.60 | -13 | -43.02 |
| 170.65 | S | -63.81 | -66.39 | 4.78 | -2.20 | -13 | -50.81 |
| 222.06 | S | -61.98 | -65.90 | 6.49 | -2.57 | -13 | -48.98 |
| 258.92 | S | -61.73 | -63.62 | 4.68 | -2.79 | -13 | -48.73 |
| 278.32 | S | -61.90 | -64.66 | 5.70 | -2.94 | -13 | -48.90 |
| 3471.00 | H | -42.38 | -47.77 | 12.24 | -6.85 | -13 | -29.38 |
| 5214.00 | H | -48.94 | -52.84 | 12.43 | -8.53 | -13 | -35.94 |

Unless otherwise stated the results shown in this test report refer only to the sample(s) tested and such sample(s) are retained for 90 days only.

除非另有說明，此報告結果僅對測試之樣品負責，同時此樣品僅保留90天。本報告未經本公司書面許可，不可部份複製。

This document is issued by the Company subject to its General Conditions of Service printed overleaf, available on request or accessible at www.sgs.com/terms_and_conditions.htm and, for electronic format documents, subject to Terms and Conditions for Electronic Documents at www.sgs.com/terms_e-document.htm. Attention is drawn to the limitation of liability, indemnification and jurisdiction issues defined therein. Any holder of this document is advised that information contained hereon reflects the Company's findings at the time of its intervention only and within the limits of Client's instructions, if any. The Company's sole responsibility is to its Client and this document does not exonerate parties to a transaction from exercising all their rights and obligations under the transaction documents. This document cannot be reproduced except in full, without prior written approval of the Company. Any unauthorized alteration, forgery or falsification of the content or appearance of this document is unlawful and offenders may be prosecuted to the fullest extent of the law.

SGS Taiwan Ltd.

No.134,WuKungRoad,NewTaipeiIndustrialPark,WukuDistrict,NewTaipeiCity,Taiwan24803/新北市五股區新北產業園區五工路 134 號

台灣檢驗科技股份有限公司

t (886-2) 2299-3279

f (886-2) 2298-0488

www.tw.sgs.com

Member of SGS Group

| | | | |
|-------------------------|--------------------------|----------------------------|----------------|
| Operation Mode : | LTE B4 10M 16QAM RB 1.49 | Test Date : | 2017/3/15 |
| Fundamental Frequency : | 1750 MHz | Temp. / Humi. : | 22.7deg_C/57RH |
| Operation Band : | Tx CH High | Test Engineer : | Ashton |
| EUT Pol. : | E2 | Measurement Antenna Pol. : | Vertical |

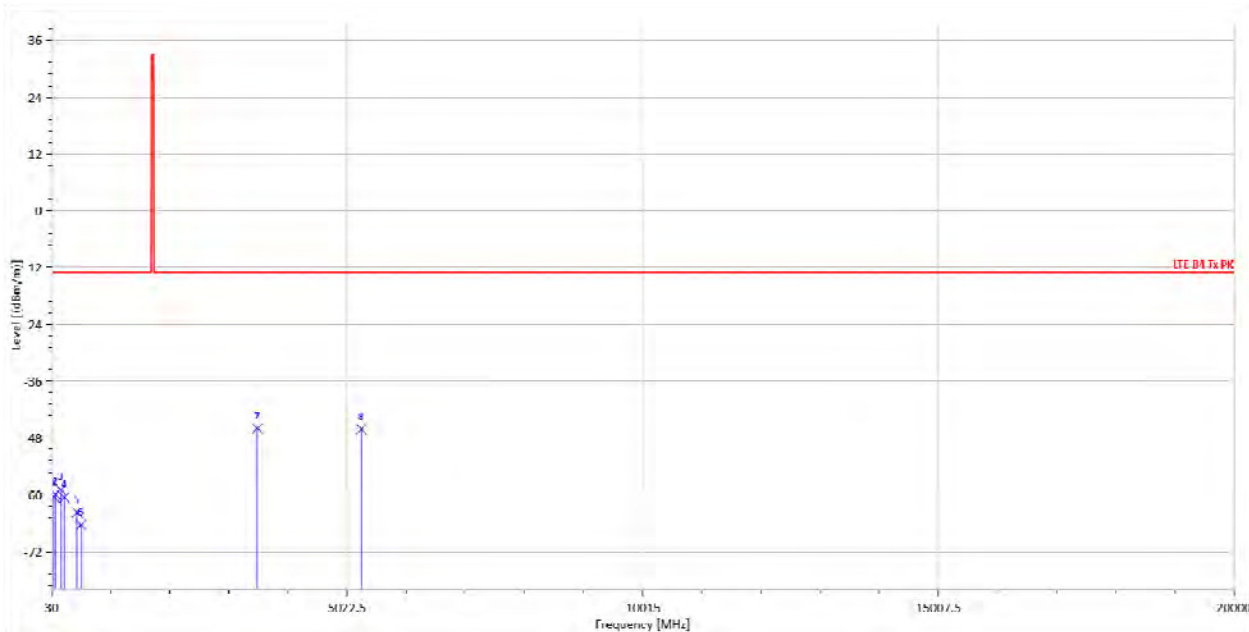

| Freq. MHz | Note F/H/E/S | EIRP dBm | SG Output Level dBm | Antenna Gain dBi | Cable Loss dB | Limit @3m dBm/m | Margin dB |
|--------------|-----------------|-------------|---------------------------|------------------------|---------------------|-----------------------|--------------|
| 60.07 | S | -60.26 | -58.03 | -0.92 | -1.31 | -13 | -47.26 |
| 97.90 | S | -59.95 | -57.61 | -0.70 | -1.64 | -13 | -46.95 |
| 185.20 | S | -58.90 | -62.46 | 5.96 | -2.41 | -13 | -45.90 |
| 245.34 | S | -60.51 | -63.34 | 5.48 | -2.64 | -13 | -47.51 |
| 456.80 | S | -63.76 | -66.15 | 6.29 | -3.89 | -13 | -50.76 |
| 528.58 | S | -66.33 | -68.73 | 6.41 | -4.00 | -13 | -53.33 |
| 3506.00 | H | -45.96 | -51.24 | 12.30 | -7.03 | -13 | -32.96 |
| 5263.00 | H | -46.11 | -50.01 | 12.46 | -8.56 | -13 | -33.11 |

Unless otherwise stated the results shown in this test report refer only to the sample(s) tested and such sample(s) are retained for 90 days only.

除非另有說明，此報告結果僅對測試之樣品負責，同時此樣品僅保留90天。本報告未經本公司書面許可，不可部份複製。

This document is issued by the Company subject to its General Conditions of Service printed overleaf, available on request or accessible at www.sgs.com/terms_and_conditions.htm and, for electronic format documents, subject to Terms and Conditions for Electronic Documents at www.sgs.com/terms_e-document.htm. Attention is drawn to the limitation of liability, indemnification and jurisdiction issues defined therein. Any holder of this document is advised that information contained hereon reflects the Company's findings at the time of its intervention only and within the limits of Client's instructions, if any. The Company's sole responsibility is to its Client and this document does not exonerate parties to a transaction from exercising all their rights and obligations under the transaction documents. This document cannot be reproduced except in full, without prior written approval of the Company. Any unauthorized alteration, forgery or falsification of the content or appearance of this document is unlawful and offenders may be prosecuted to the fullest extent of the law.

SGS Taiwan Ltd.

No.134,WuKungRoad,NewTaipeiIndustrialPark,WukuDistrict,NewTaipeiCity,Taiwan24803/新北市五股區新北產業園區五工路 134 號

台灣檢驗科技股份有限公司

t (886-2) 2299-3279

f (886-2) 2298-0488

www.tw.sgs.com

Member of SGS Group

| | | | |
|-------------------------|--------------------------|----------------------------|----------------|
| Operation Mode : | LTE B4 10M 16QAM RB 1.49 | Test Date : | 2017/3/15 |
| Fundamental Frequency : | 1750 MHz | Temp. / Humi. : | 22.7deg_C/57RH |
| Operation Band : | Tx CH High | Test Engineer : | Ashton |
| EUT Pol. : | E2 | Measurement Antenna Pol. : | Horizontal |

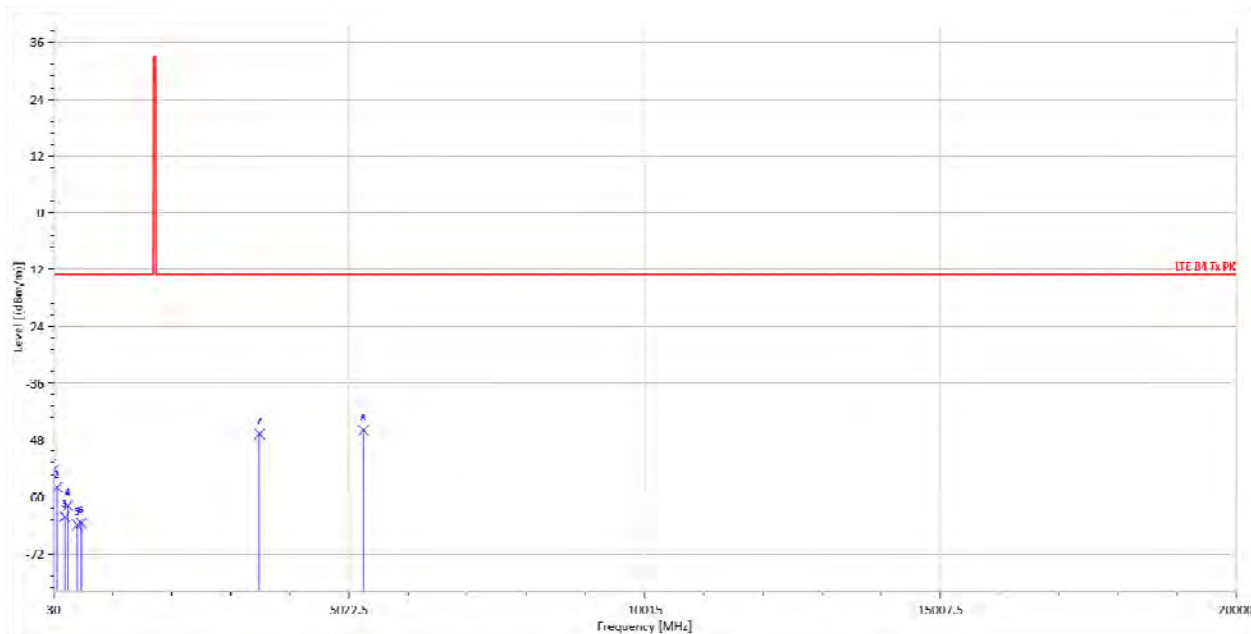

| Freq. | Note | EIRP | SG Output | Antenna | Cable | Limit | Margin |
|---------|---------|--------|-----------|---------|-------|-------|--------|
| MHz | F/H/E/S | dBm | Level | Gain | Loss | @3m | dB |
| 31.94 | S | -54.24 | -34.78 | -18.56 | -0.90 | -13 | -41.24 |
| 88.20 | S | -58.02 | -56.59 | 0.12 | -1.55 | -13 | -45.02 |
| 221.09 | S | -64.21 | -68.16 | 6.52 | -2.58 | -13 | -51.21 |
| 272.50 | S | -61.87 | -64.53 | 5.52 | -2.86 | -13 | -48.87 |
| 428.67 | S | -65.92 | -68.18 | 6.05 | -3.79 | -13 | -52.92 |
| 499.48 | S | -65.57 | -67.86 | 6.39 | -4.10 | -13 | -52.57 |
| 3506.00 | H | -46.71 | -51.99 | 12.30 | -7.03 | -13 | -33.71 |
| 5263.00 | H | -45.92 | -49.82 | 12.46 | -8.56 | -13 | -32.92 |

Unless otherwise stated the results shown in this test report refer only to the sample(s) tested and such sample(s) are retained for 90 days only.

除非另有說明，此報告結果僅對測試之樣品負責，同時此樣品僅保留90天。本報告未經本公司書面許可，不可部份複製。

This document is issued by the Company subject to its General Conditions of Service printed overleaf, available on request or accessible at www.sgs.com/terms_and_conditions.htm and, for electronic format documents, subject to Terms and Conditions for Electronic Documents at www.sgs.com/terms_e-document.htm. Attention is drawn to the limitation of liability, indemnification and jurisdiction issues defined therein. Any holder of this document is advised that information contained hereon reflects the Company's findings at the time of its intervention only and within the limits of Client's instructions, if any. The Company's sole responsibility is to its Client and this document does not exonerate parties to a transaction from exercising all their rights and obligations under the transaction documents. This document cannot be reproduced except in full, without prior written approval of the Company. Any unauthorized alteration, forgery or falsification of the content or appearance of this document is unlawful and offenders may be prosecuted to the fullest extent of the law.

SGS Taiwan Ltd.

No.134,WuKungRoad,NewTaipeiIndustrialPark,WukuDistrict,NewTaipeiCity,Taiwan24803/新北市五股區新北產業園區五工路 134 號

台灣檢驗科技股份有限公司

t (886-2) 2299-3279

f (886-2) 2298-0488

www.tw.sgs.com

Member of SGS Group

Radiated Spurious Emission Measurement Result: LTE-Band 5 (The Worst Case)

| | | | |
|-------------------------|-------------------------|----------------------------|----------------|
| Operation Mode : | LTE B5 1.4M QPSK RB 1.5 | Test Date : | 2017/3/15 |
| Fundamental Frequency : | 824.7 MHz | Temp. / Humi. : | 22.7deg_C/57RH |
| Operation Band : | Tx CH Low | Test Engineer : | Ashton |
| EUT Pol. : | H | Measurement Antenna Pol. : | Vertical |

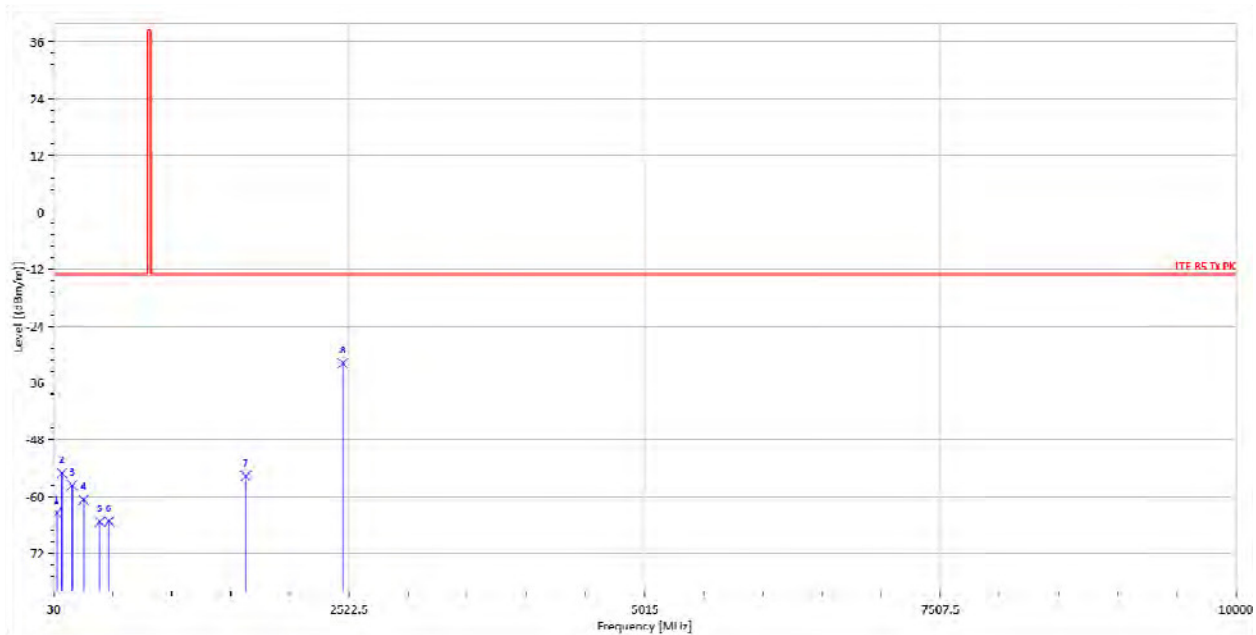

| Freq. | Note | ERP | SG Output | Antenna | Cable | Limit | Margin |
|---------|---------|--------|--------------|-------------|------------|--------------|--------|
| MHz | F/H/E/S | dBm | Level dBm | Gain dBd | Loss dB | @3m dBm/m | dB |
| 59.10 | S | -63.44 | -59.14 | -3.44 | -0.87 | -13 | -50.44 |
| 100.81 | S | -55.05 | -50.80 | -3.07 | -1.17 | -13 | -42.05 |
| 187.14 | S | -57.63 | -59.98 | 3.90 | -1.55 | -13 | -44.63 |
| 283.17 | S | -60.69 | -62.37 | 3.64 | -1.96 | -13 | -47.69 |
| 419.94 | S | -65.31 | -66.81 | 3.81 | -2.30 | -13 | -52.31 |
| 497.54 | S | -65.22 | -66.99 | 4.23 | -2.46 | -13 | -52.22 |
| 1651.00 | H | -55.70 | -57.73 | 6.76 | -4.72 | -13 | -42.70 |
| 2470.00 | H | -31.84 | -34.23 | 8.23 | -5.84 | -13 | -18.84 |

Unless otherwise stated the results shown in this test report refer only to the sample(s) tested and such sample(s) are retained for 90 days only.

除非另有說明，此報告結果僅對測試之樣品負責，同時此樣品僅保留90天。本報告未經本公司書面許可，不可部份複製。

This document is issued by the Company subject to its General Conditions of Service printed overleaf, available on request or accessible at www.sgs.com/terms_and_conditions.htm and, for electronic format documents, subject to Terms and Conditions for Electronic Documents at www.sgs.com/terms_e-document.htm. Attention is drawn to the limitation of liability, indemnification and jurisdiction issues defined therein. Any holder of this document is advised that information contained hereon reflects the Company's findings at the time of its intervention only and within the limits of Client's instructions, if any. The Company's sole responsibility is to its Client and this document does not exonerate parties to a transaction from exercising all their rights and obligations under the transaction documents. This document cannot be reproduced except in full, without prior written approval of the Company. Any unauthorized alteration, forgery or falsification of the content or appearance of this document is unlawful and offenders may be prosecuted to the fullest extent of the law.

SGS Taiwan Ltd.

No.134,WuKungRoad,NewTaipeiIndustrialPark,WukuDistrict,NewTaipeiCity,Taiwan24803/新北市五股區新北產業園區五工路 134 號

台灣檢驗科技股份有限公司

t (886-2) 2299-3279

f (886-2) 2298-0488

www.tw.sgs.com

Member of SGS Group

| | | | |
|-------------------------|-------------------------|----------------------------|----------------|
| Operation Mode : | LTE B5 1.4M QPSK RB 1.5 | Test Date : | 2017/3/15 |
| Fundamental Frequency : | 824.7 MHz | Temp. / Humi. : | 22.7deg_C/57RH |
| Operation Band : | Tx CH Low | Test Engineer : | Ashton |
| EUT Pol. : | H | Measurement Antenna Pol. : | Horizontal |

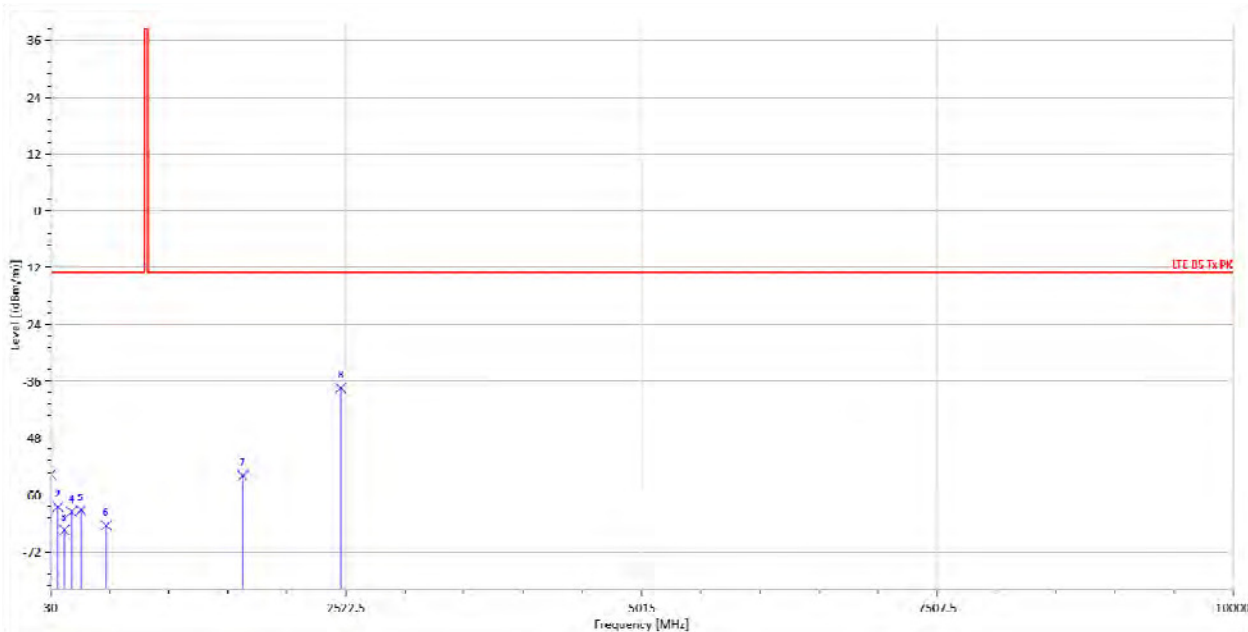

| Freq. MHz | Note F/H/E/S | ERP dBm | SG Output Level dBm | Antenna Gain dBd | Cable Loss dB | Limit @3m dBm/m | Margin dB |
|--------------|-----------------|------------|---------------------------|------------------------|---------------------|-----------------------|--------------|
| 31.94 | S | -55.67 | -34.29 | -20.71 | -0.67 | -13 | -42.67 |
| 91.11 | S | -62.57 | -59.19 | -2.25 | -1.12 | -13 | -49.57 |
| 146.40 | S | -67.42 | -65.83 | -0.12 | -1.47 | -13 | -54.42 |
| 206.54 | S | -63.58 | -65.74 | 3.83 | -1.67 | -13 | -50.58 |
| 286.08 | S | -63.20 | -64.88 | 3.67 | -1.99 | -13 | -50.20 |
| 499.48 | S | -66.47 | -67.97 | 4.24 | -2.74 | -13 | -53.47 |
| 1651.00 | H | -55.99 | -58.03 | 6.76 | -4.72 | -13 | -42.99 |
| 2477.00 | H | -37.43 | -39.82 | 8.24 | -5.84 | -13 | -24.43 |

Unless otherwise stated the results shown in this test report refer only to the sample(s) tested and such sample(s) are retained for 90 days only.

除非另有說明，此報告結果僅對測試之樣品負責，同時此樣品僅保留90天。本報告未經本公司書面許可，不可部份複製。

This document is issued by the Company subject to its General Conditions of Service printed overleaf, available on request or accessible at www.sgs.com/terms_and_conditions.htm and, for electronic format documents, subject to Terms and Conditions for Electronic Documents at www.sgs.com/terms_e-document.htm. Attention is drawn to the limitation of liability, indemnification and jurisdiction issues defined therein. Any holder of this document is advised that information contained hereon reflects the Company's findings at the time of its intervention only and within the limits of Client's instructions, if any. The Company's sole responsibility is to its Client and this document does not exonerate parties to a transaction from exercising all their rights and obligations under the transaction documents. This document cannot be reproduced except in full, without prior written approval of the Company. Any unauthorized alteration, forgery or falsification of the content or appearance of this document is unlawful and offenders may be prosecuted to the fullest extent of the law.

SGS Taiwan Ltd.

No.134,WuKungRoad,NewTaipeiIndustrialPark,WukuDistrict,NewTaipeiCity,Taiwan24803/新北市五股區新北產業園區五工路 134 號

台灣檢驗科技股份有限公司

t (886-2) 2299-3279

f (886-2) 2298-0488

www.tw.sgs.com

Member of SGS Group

| | | | |
|-------------------------|-------------------------|----------------------------|----------------|
| Operation Mode : | LTE B5 1.4M QPSK RB 1.5 | Test Date : | 2017/3/15 |
| Fundamental Frequency : | 836.5 MHz | Temp. / Humi. : | 22.7deg_C/57RH |
| Operation Band : | Tx CH Mid | Test Engineer : | Ashton |
| EUT Pol. : | H | Measurement Antenna Pol. : | Vertical |

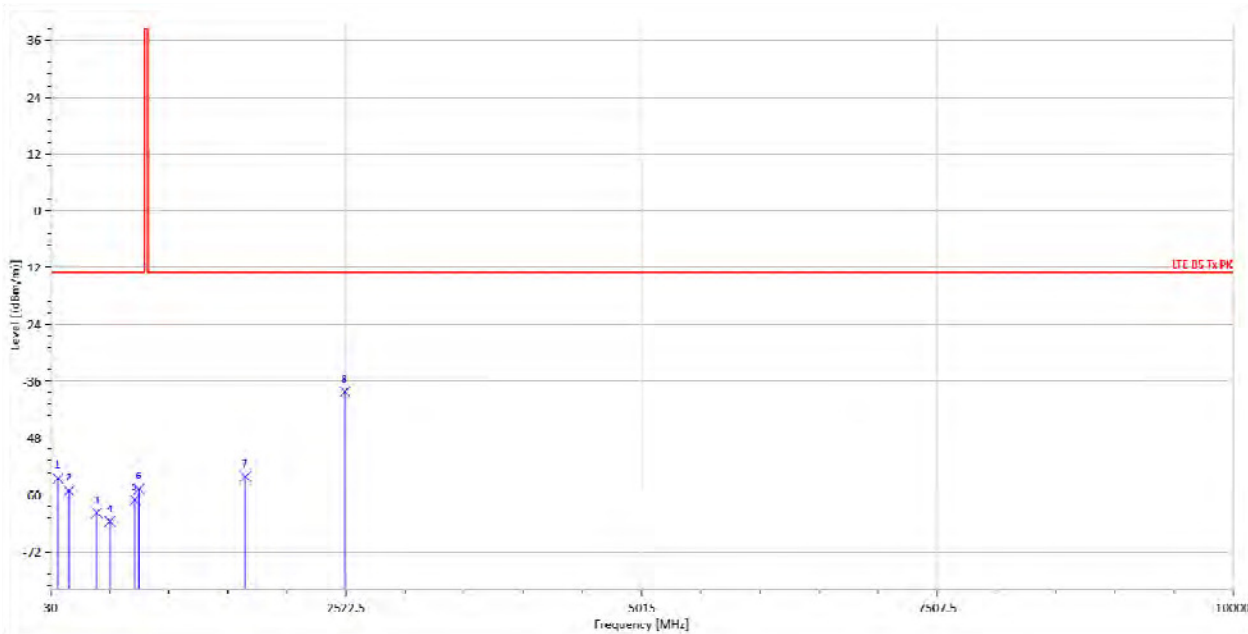

| Freq. MHz | Note F/H/E/S | ERP dBm | SG Output Level dBm | Antenna Gain dBd | Cable Loss dB | Limit @3m dBm/m | Margin dB |
|--------------|-----------------|------------|---------------------------|------------------------|---------------------|-----------------------|--------------|
| 93.05 | S | -56.56 | -53.00 | -2.43 | -1.14 | -13 | -43.56 |
| 185.20 | S | -59.14 | -61.30 | 3.81 | -1.64 | -13 | -46.14 |
| 419.94 | S | -63.80 | -65.31 | 3.81 | -2.30 | -13 | -50.80 |
| 530.52 | S | -65.61 | -67.15 | 4.26 | -2.72 | -13 | -52.61 |
| 740.04 | S | -61.05 | -63.13 | 5.46 | -3.37 | -13 | -48.05 |
| 775.93 | S | -58.74 | -61.18 | 5.49 | -3.06 | -13 | -45.74 |
| 1672.00 | H | -56.17 | -58.23 | 6.83 | -4.78 | -13 | -43.17 |
| 2512.00 | H | -38.22 | -40.60 | 8.27 | -5.89 | -13 | -25.22 |

Unless otherwise stated the results shown in this test report refer only to the sample(s) tested and such sample(s) are retained for 90 days only.

除非另有說明，此報告結果僅對測試之樣品負責，同時此樣品僅保留90天。本報告未經本公司書面許可，不可部份複製。

This document is issued by the Company subject to its General Conditions of Service printed overleaf, available on request or accessible at www.sgs.com/terms_and_conditions.htm and, for electronic format documents, subject to Terms and Conditions for Electronic Documents at www.sgs.com/terms_e-document.htm. Attention is drawn to the limitation of liability, indemnification and jurisdiction issues defined therein. Any holder of this document is advised that information contained hereon reflects the Company's findings at the time of its intervention only and within the limits of Client's instructions, if any. The Company's sole responsibility is to its Client and this document does not exonerate parties to a transaction from exercising all their rights and obligations under the transaction documents. This document cannot be reproduced except in full, without prior written approval of the Company. Any unauthorized alteration, forgery or falsification of the content or appearance of this document is unlawful and offenders may be prosecuted to the fullest extent of the law.

SGS Taiwan Ltd.

No.134,WuKungRoad,NewTaipeiIndustrialPark,WukuDistrict,NewTaipeiCity,Taiwan24803/新北市五股區新北產業園區五工路 134 號

台灣檢驗科技股份有限公司

t (886-2) 2299-3279

f (886-2) 2298-0488

www.tw.sgs.com

Member of SGS Group

| | | | |
|-------------------------|-------------------------|----------------------------|----------------|
| Operation Mode : | LTE B5 1.4M QPSK RB 1.5 | Test Date : | 2017/3/15 |
| Fundamental Frequency : | 836.5 MHz | Temp. / Humi. : | 22.7deg_C/57RH |
| Operation Band : | Tx CH Mid | Test Engineer : | Ashton |
| EUT Pol. : | H | Measurement Antenna Pol. : | Horizontal |

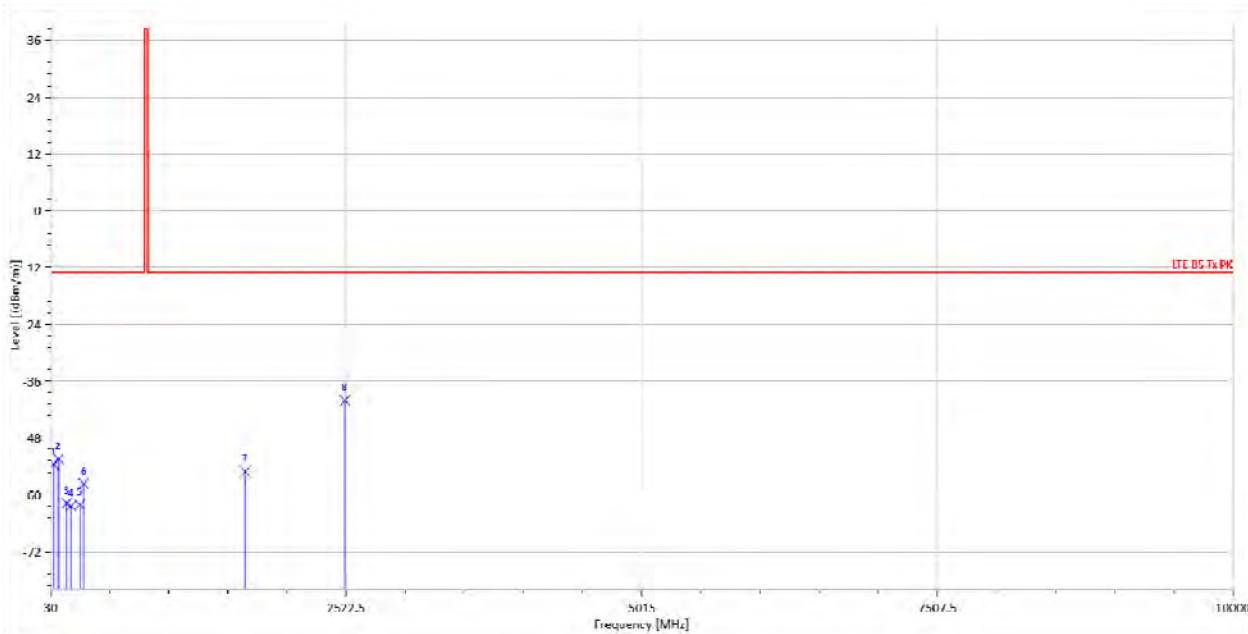

| Freq. MHz | Note F/H/E/S | ERP dBm | SG Output Level dBm | Antenna Gain dBd | Cable Loss dB | Limit @3m dBm/m | Margin dB |
|--------------|-----------------|------------|---------------------------|------------------------|---------------------|-----------------------|--------------|
| 56.19 | S | -53.58 | -48.14 | -4.59 | -0.85 | -13 | -40.58 |
| 95.96 | S | -52.39 | -48.56 | -2.68 | -1.15 | -13 | -39.39 |
| 164.83 | S | -61.83 | -62.29 | 1.99 | -1.52 | -13 | -48.83 |
| 200.72 | S | -62.38 | -64.42 | 3.70 | -1.65 | -13 | -49.38 |
| 277.35 | S | -62.08 | -63.62 | 3.52 | -1.98 | -13 | -49.08 |
| 309.36 | S | -57.69 | -59.50 | 3.79 | -1.98 | -13 | -44.69 |
| 1672.00 | H | -55.06 | -57.12 | 6.83 | -4.78 | -13 | -42.06 |
| 2512.00 | H | -40.03 | -42.41 | 8.27 | -5.89 | -13 | -27.03 |

Unless otherwise stated the results shown in this test report refer only to the sample(s) tested and such sample(s) are retained for 90 days only.

除非另有說明，此報告結果僅對測試之樣品負責，同時此樣品僅保留90天。本報告未經本公司書面許可，不可部份複製。

This document is issued by the Company subject to its General Conditions of Service printed overleaf, available on request or accessible at www.sgs.com/terms_and_conditions.htm and, for electronic format documents, subject to Terms and Conditions for Electronic Documents at www.sgs.com/terms_e-document.htm. Attention is drawn to the limitation of liability, indemnification and jurisdiction issues defined therein. Any holder of this document is advised that information contained hereon reflects the Company's findings at the time of its intervention only and within the limits of Client's instructions, if any. The Company's sole responsibility is to its Client and this document does not exonerate parties to a transaction from exercising all their rights and obligations under the transaction documents. This document cannot be reproduced except in full, without prior written approval of the Company. Any unauthorized alteration, forgery or falsification of the content or appearance of this document is unlawful and offenders may be prosecuted to the fullest extent of the law.

SGS Taiwan Ltd.

No.134,WuKungRoad,NewTaipeiIndustrialPark,WukuDistrict,NewTaipeiCity,Taiwan24803/新北市五股區新北產業園區五工路 134 號

台灣檢驗科技股份有限公司

t (886-2) 2299-3279

f (886-2) 2298-0488

www.tw.sgs.com

Member of SGS Group

| | | | |
|-------------------------|-------------------------|----------------------------|----------------|
| Operation Mode : | LTE B5 1.4M QPSK RB 1.5 | Test Date : | 2017/3/15 |
| Fundamental Frequency : | 848.3 MHz | Temp. / Humi. : | 22.7deg_C/57RH |
| Operation Band : | Tx CH High | Test Engineer : | Ashton |
| EUT Pol. : | H | Measurement Antenna Pol. : | Vertical |

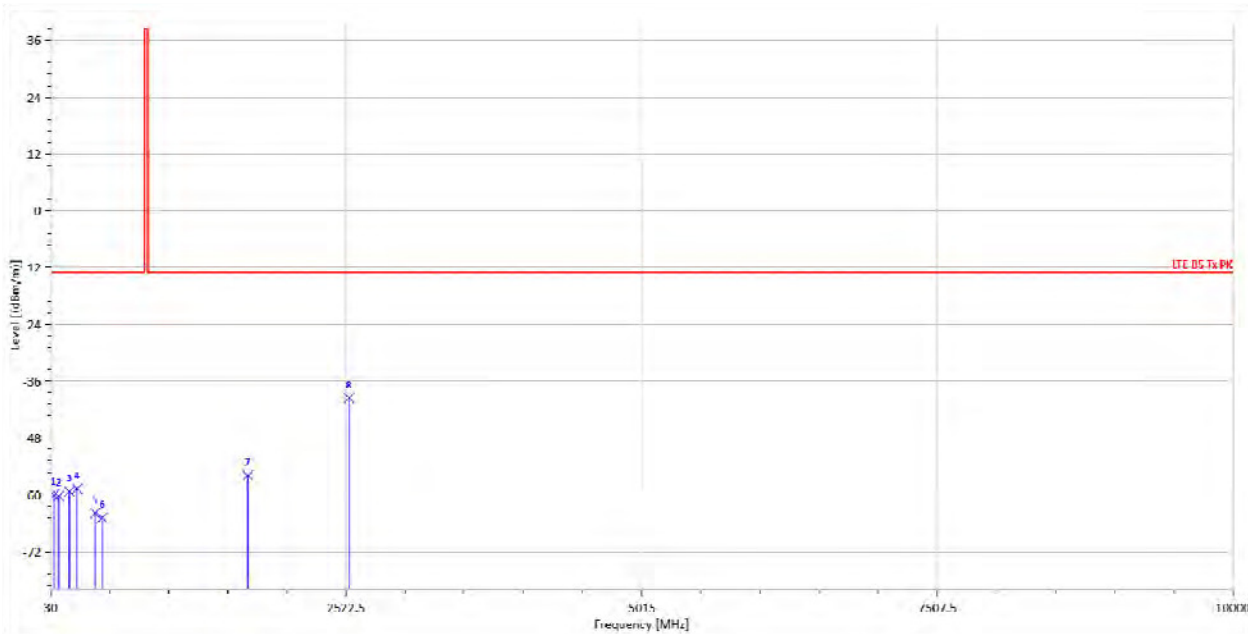

| Freq. MHz | Note F/H/E/S | ERP dBm | SG Output Level dBm | Antenna Gain dBd | Cable Loss dB | Limit @3m dBm/m | Margin dB |
|--------------|-----------------|------------|---------------------------|------------------------|---------------------|-----------------------|--------------|
| 59.10 | S | -60.04 | -55.74 | -3.44 | -0.87 | -13 | -47.04 |
| 96.93 | S | -60.24 | -56.32 | -2.77 | -1.15 | -13 | -47.24 |
| 188.11 | S | -59.27 | -61.65 | 3.95 | -1.56 | -13 | -46.27 |
| 253.10 | S | -58.70 | -59.82 | 2.91 | -1.80 | -13 | -45.70 |
| 406.36 | S | -63.90 | -65.25 | 3.67 | -2.32 | -13 | -50.90 |
| 465.53 | S | -64.83 | -66.60 | 4.16 | -2.39 | -13 | -51.83 |
| 1693.00 | H | -55.93 | -58.04 | 6.91 | -4.80 | -13 | -42.93 |
| 2547.00 | H | -39.53 | -41.95 | 8.33 | -5.91 | -13 | -26.53 |

Unless otherwise stated the results shown in this test report refer only to the sample(s) tested and such sample(s) are retained for 90 days only.

除非另有說明，此報告結果僅對測試之樣品負責，同時此樣品僅保留90天。本報告未經本公司書面許可，不可部份複製。

This document is issued by the Company subject to its General Conditions of Service printed overleaf, available on request or accessible at www.sgs.com/terms_and_conditions.htm and, for electronic format documents, subject to Terms and Conditions for Electronic Documents at www.sgs.com/terms_e-document.htm. Attention is drawn to the limitation of liability, indemnification and jurisdiction issues defined therein. Any holder of this document is advised that information contained hereon reflects the Company's findings at the time of its intervention only and within the limits of Client's instructions, if any. The Company's sole responsibility is to its Client and this document does not exonerate parties to a transaction from exercising all their rights and obligations under the transaction documents. This document cannot be reproduced except in full, without prior written approval of the Company. Any unauthorized alteration, forgery or falsification of the content or appearance of this document is unlawful and offenders may be prosecuted to the fullest extent of the law.

SGS Taiwan Ltd.

No.134,WuKungRoad,NewTaipeiIndustrialPark,WukuDistrict,NewTaipeiCity,Taiwan24803/新北市五股區新北產業園區五工路 134 號

台灣檢驗科技股份有限公司

t (886-2) 2299-3279

f (886-2) 2298-0488

www.tw.sgs.com

Member of SGS Group

| | | | |
|-------------------------|-------------------------|----------------------------|----------------|
| Operation Mode : | LTE B5 1.4M QPSK RB 1.5 | Test Date : | 2017/3/15 |
| Fundamental Frequency : | 848.3 MHz | Temp. / Humi. : | 22.7deg_C/57RH |
| Operation Band : | Tx CH High | Test Engineer : | Ashton |
| EUT Pol. : | H | Measurement Antenna Pol. : | Horizontal |

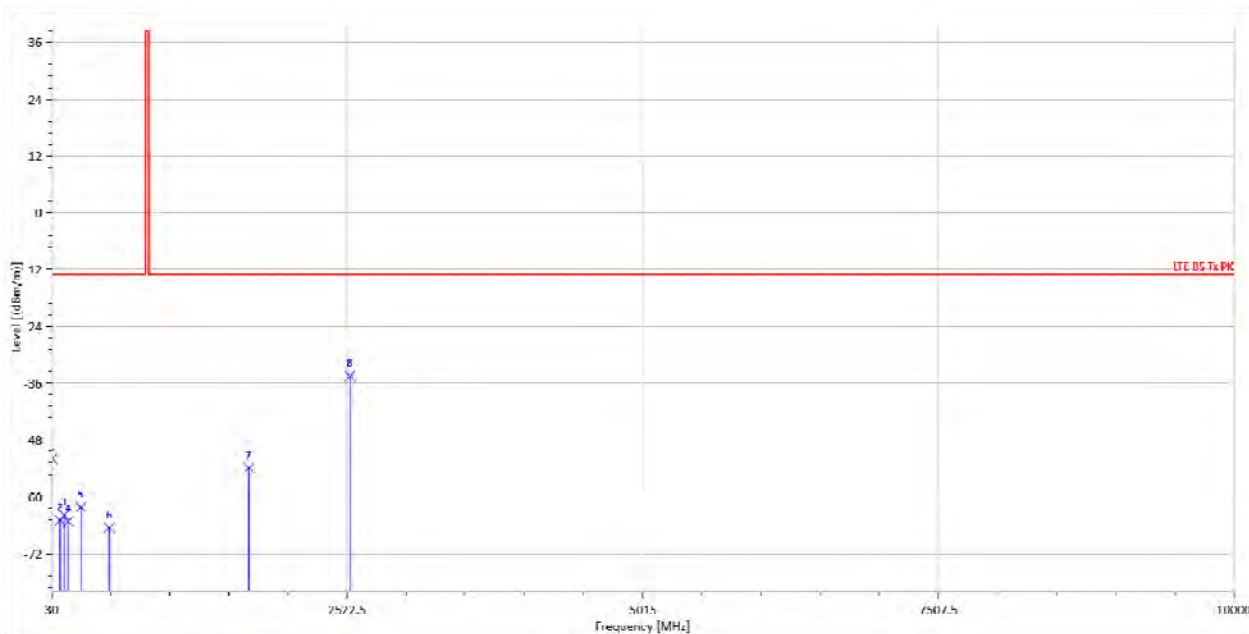

| Freq. MHz | Note F/H/E/S | ERP dBm | SG Output Level dBm | Antenna Gain dBd | Cable Loss dB | Limit @3m dBm/m | Margin dB |
|--------------|-----------------|------------|---------------------------|------------------------|---------------------|-----------------------|--------------|
| 32.91 | S | -51.99 | -31.44 | -19.87 | -0.67 | -13 | -38.99 |
| 101.78 | S | -64.93 | -60.64 | -3.11 | -1.18 | -13 | -51.93 |
| 135.73 | S | -63.90 | -60.89 | -1.55 | -1.46 | -13 | -50.90 |
| 170.65 | S | -65.17 | -66.31 | 2.63 | -1.49 | -13 | -52.17 |
| 277.35 | S | -62.20 | -63.74 | 3.52 | -1.98 | -13 | -49.20 |
| 515.97 | S | -66.55 | -68.44 | 4.25 | -2.35 | -13 | -53.55 |
| 1693.00 | H | -53.89 | -56.00 | 6.91 | -4.80 | -13 | -40.89 |
| 2547.00 | H | -34.46 | -36.88 | 8.33 | -5.91 | -13 | -21.46 |

Unless otherwise stated the results shown in this test report refer only to the sample(s) tested and such sample(s) are retained for 90 days only.

除非另有說明，此報告結果僅對測試之樣品負責，同時此樣品僅保留90天。本報告未經本公司書面許可，不可部份複製。

This document is issued by the Company subject to its General Conditions of Service printed overleaf, available on request or accessible at www.sgs.com/terms_and_conditions.htm and, for electronic format documents, subject to Terms and Conditions for Electronic Documents at www.sgs.com/terms_e-document.htm. Attention is drawn to the limitation of liability, indemnification and jurisdiction issues defined therein. Any holder of this document is advised that information contained hereon reflects the Company's findings at the time of its intervention only and within the limits of Client's instructions, if any. The Company's sole responsibility is to its Client and this document does not exonerate parties to a transaction from exercising all their rights and obligations under the transaction documents. This document cannot be reproduced except in full, without prior written approval of the Company. Any unauthorized alteration, forgery or falsification of the content or appearance of this document is unlawful and offenders may be prosecuted to the fullest extent of the law.

SGS Taiwan Ltd.

No.134,WuKungRoad,NewTaipeiIndustrialPark,WukuDistrict,NewTaipeiCity,Taiwan24803/新北市五股區新北產業園區五工路 134 號

台灣檢驗科技股份有限公司

t (886-2) 2299-3279

f (886-2) 2298-0488

www.tw.sgs.com

Member of SGS Group

Radiated Spurious Emission Measurement Result: LTE-Band 12 (The Worst Case)

| | | | |
|-------------------------|------------------------|----------------------------|----------------|
| Operation Mode : | LTE B12 3M QPSK RB 1.0 | Test Date : | 2017/3/15 |
| Fundamental Frequency : | 700.5 MHz | Temp. / Humi. : | 19.0deg_C/52RH |
| Operation Band : | Tx CH Low | Test Engineer : | Ashton |
| EUT Pol. : | H | Measurement Antenna Pol. : | Vertical |

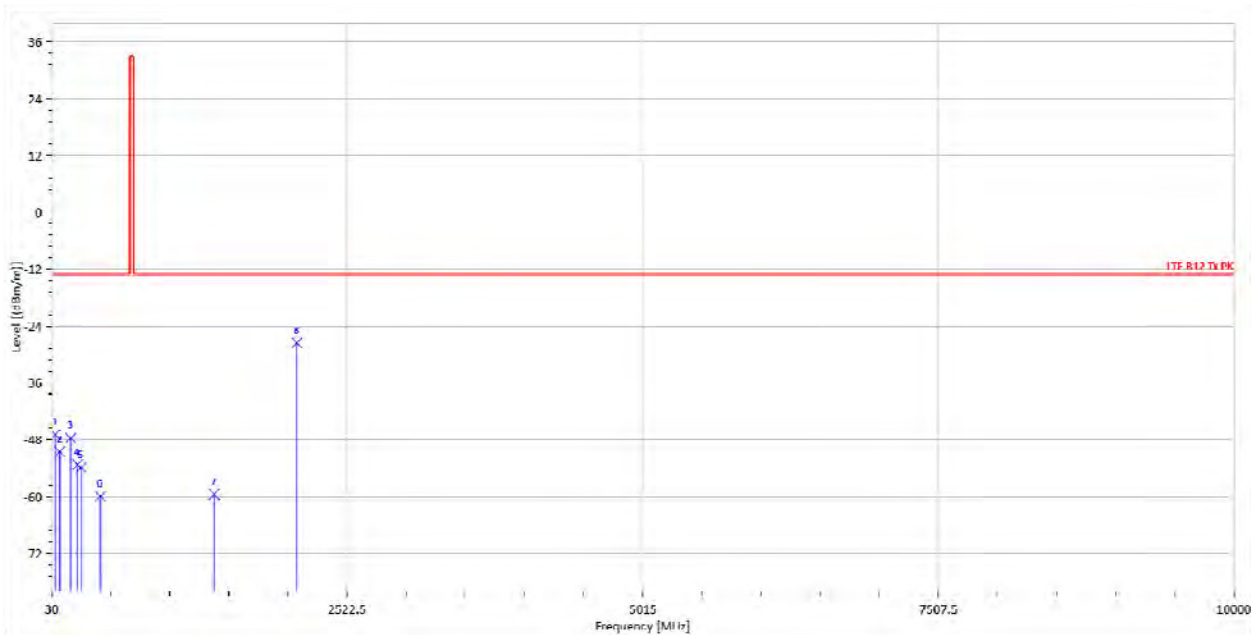

| Freq. MHz | Note F/H/E/S | ERP dBm | SG Output Level dBm | Antenna Gain dBd | Cable Loss dB | Limit @3m dBm/m | Margin dB |
|--------------|-----------------|------------|---------------------------|------------------------|---------------------|-----------------------|--------------|
| 61.04 | S | -46.96 | -43.07 | -2.94 | -0.95 | -13 | -33.96 |
| 97.90 | S | -50.51 | -46.50 | -2.85 | -1.16 | -13 | -37.51 |
| 191.02 | S | -47.67 | -50.05 | 4.00 | -1.62 | -13 | -34.67 |
| 248.25 | S | -53.27 | -54.62 | 3.20 | -1.85 | -13 | -40.27 |
| 278.32 | S | -53.94 | -55.51 | 3.55 | -1.98 | -13 | -40.94 |
| 441.28 | S | -59.95 | -61.62 | 4.03 | -2.37 | -13 | -46.95 |
| 1401.00 | H | -59.55 | -61.07 | 5.87 | -4.36 | -13 | -46.55 |
| 2099.00 | H | -27.54 | -30.19 | 8.01 | -5.37 | -13 | -14.54 |

Unless otherwise stated the results shown in this test report refer only to the sample(s) tested and such sample(s) are retained for 90 days only.

除非另有說明，此報告結果僅對測試之樣品負責，同時此樣品僅保留90天。本報告未經本公司書面許可，不可部份複製。

This document is issued by the Company subject to its General Conditions of Service printed overleaf, available on request or accessible at www.sgs.com/terms_and_conditions.htm and, for electronic format documents, subject to Terms and Conditions for Electronic Documents at www.sgs.com/terms_e-document.htm. Attention is drawn to the limitation of liability, indemnification and jurisdiction issues defined therein. Any holder of this document is advised that information contained hereon reflects the Company's findings at the time of its intervention only and within the limits of Client's instructions, if any. The Company's sole responsibility is to its Client and this document does not exonerate parties to a transaction from exercising all their rights and obligations under the transaction documents. This document cannot be reproduced except in full, without prior written approval of the Company. Any unauthorized alteration, forgery or falsification of the content or appearance of this document is unlawful and offenders may be prosecuted to the fullest extent of the law.

SGS Taiwan Ltd.

No.134,WuKungRoad,NewTaipeiIndustrialPark,WukuDistrict,NewTaipeiCity,Taiwan24803/新北市五股區新北產業園區五工路 134 號

台灣檢驗科技股份有限公司

t (886-2) 2299-3279

f (886-2) 2298-0488

www.tw.sgs.com

Member of SGS Group

Operation Mode : LTE B12 3M QPSK RB 1.0
Fundamental Frequency : 700.5 MHz
Operation Band : Tx CH Low
EUT Pol. : H

Test Date : 2017/3/15
Temp. / Humi. : 19.0deg_C/52RH
Test Engineer : Ashton
Measurement Antenna Pol. : Horizontal

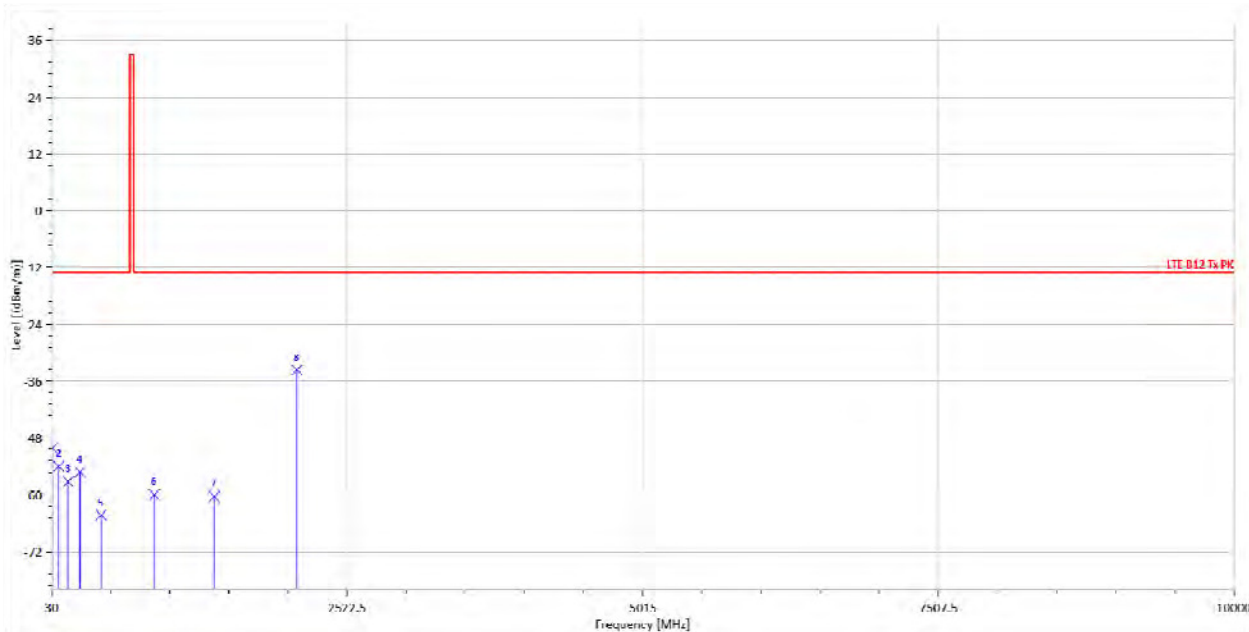

| Freq. MHz | Note F/H/E/S | ERP dBm | SG Output Level dBm | Antenna Gain dBd | Cable Loss dB | Limit @3m dBm/m | Margin dB |
|--------------|-----------------|------------|---------------------------|------------------------|---------------------|-----------------------|--------------|
| 34.85 | S | -50.14 | -31.24 | -18.19 | -0.71 | -13 | -37.14 |
| 89.17 | S | -53.99 | -50.79 | -2.10 | -1.11 | -13 | -40.99 |
| 169.68 | S | -57.25 | -58.38 | 2.53 | -1.40 | -13 | -44.25 |
| 269.59 | S | -55.18 | -56.49 | 3.25 | -1.94 | -13 | -42.18 |
| 448.07 | S | -64.29 | -65.86 | 4.10 | -2.54 | -13 | -51.29 |
| 896.21 | S | -60.02 | -62.04 | 5.63 | -3.61 | -13 | -47.02 |
| 1401.00 | H | -60.37 | -61.89 | 5.87 | -4.36 | -13 | -47.37 |
| 2099.00 | H | -33.62 | -36.26 | 8.01 | -5.37 | -13 | -20.62 |

Unless otherwise stated the results shown in this test report refer only to the sample(s) tested and such sample(s) are retained for 90 days only.

除非另有說明，此報告結果僅對測試之樣品負責，同時此樣品僅保留90天。本報告未經本公司書面許可，不可部份複製。

This document is issued by the Company subject to its General Conditions of Service printed overleaf, available on request or accessible at www.sgs.com/terms_and_conditions.htm and, for electronic format documents, subject to Terms and Conditions for Electronic Documents at www.sgs.com/terms_e-document.htm. Attention is drawn to the limitation of liability, indemnification and jurisdiction issues defined therein. Any holder of this document is advised that information contained hereon reflects the Company's findings at the time of its intervention only and within the limits of Client's instructions, if any. The Company's sole responsibility is to its Client and this document does not exonerate parties to a transaction from exercising all their rights and obligations under the transaction documents. This document cannot be reproduced except in full, without prior written approval of the Company. Any unauthorized alteration, forgery or falsification of the content or appearance of this document is unlawful and offenders may be prosecuted to the fullest extent of the law.

SGS Taiwan Ltd.

No.134,WuKungRoad,NewTaipeiIndustrialPark,WukuDistrict,NewTaipeiCity,Taiwan24803/新北市五股區新北產業園區五工路 134 號

台灣檢驗科技股份有限公司

t (886-2) 2299-3279

f (886-2) 2298-0488

www.tw.sgs.com

Member of SGS Group

| | | | |
|-------------------------|------------------------|----------------------------|----------------|
| Operation Mode : | LTE B12 3M QPSK RB 1.0 | Test Date : | 2017/3/15 |
| Fundamental Frequency : | 707.5 MHz | Temp. / Humi. : | 19.0deg_C/52RH |
| Operation Band : | Tx CH Mid | Test Engineer : | Ashton |
| EUT Pol. : | H | Measurement Antenna Pol. : | Vertical |

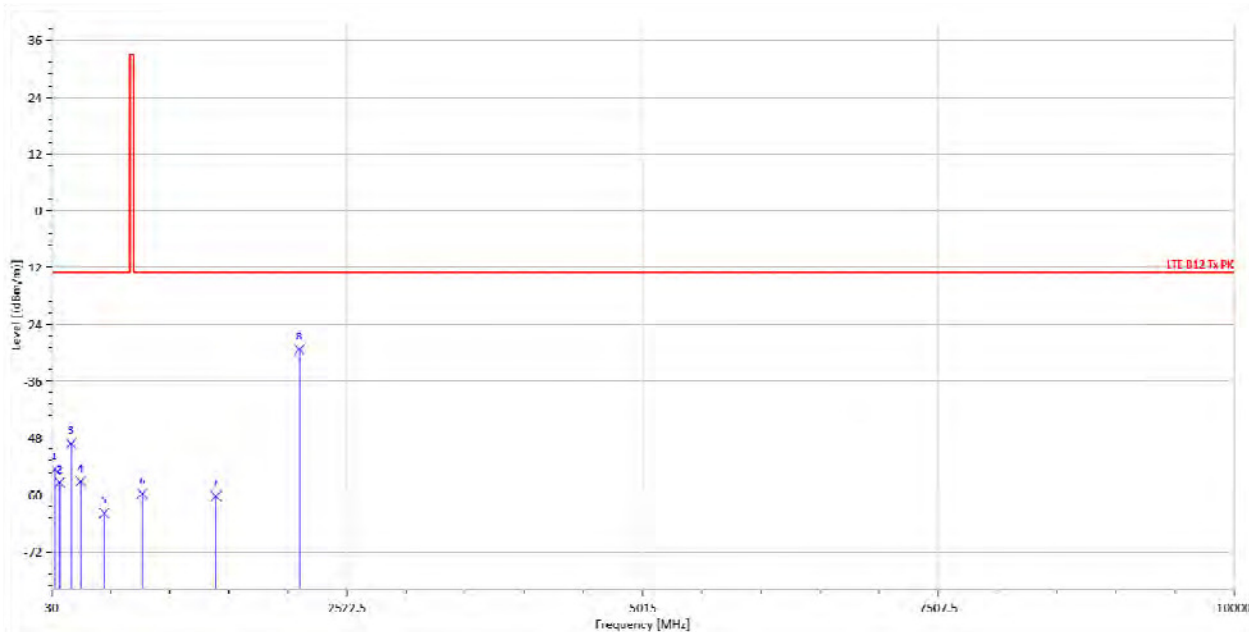

| Freq. MHz | Note F/H/E/S | ERP dBm | SG Output Level dBm | Antenna Gain dBd | Cable Loss dB | Limit @3m dBm/m | Margin dB |
|--------------|-----------------|------------|---------------------------|------------------------|---------------------|-----------------------|--------------|
| 58.13 | S | -54.61 | -49.91 | -3.82 | -0.88 | -13 | -41.61 |
| 96.93 | S | -57.40 | -53.48 | -2.77 | -1.15 | -13 | -44.40 |
| 194.90 | S | -49.20 | -51.42 | 3.86 | -1.64 | -13 | -36.20 |
| 275.41 | S | -57.18 | -58.71 | 3.46 | -1.92 | -13 | -44.18 |
| 473.29 | S | -63.91 | -65.58 | 4.18 | -2.51 | -13 | -50.91 |
| 795.33 | S | -59.74 | -62.09 | 5.52 | -3.16 | -13 | -46.74 |
| 1415.00 | H | -60.30 | -61.85 | 5.93 | -4.38 | -13 | -47.30 |
| 2120.00 | H | -29.26 | -31.87 | 8.02 | -5.42 | -13 | -16.26 |

Unless otherwise stated the results shown in this test report refer only to the sample(s) tested and such sample(s) are retained for 90 days only.

除非另有說明，此報告結果僅對測試之樣品負責，同時此樣品僅保留90天。本報告未經本公司書面許可，不可部份複製。

This document is issued by the Company subject to its General Conditions of Service printed overleaf, available on request or accessible at www.sgs.com/terms_and_conditions.htm and, for electronic format documents, subject to Terms and Conditions for Electronic Documents at www.sgs.com/terms_e-document.htm. Attention is drawn to the limitation of liability, indemnification and jurisdiction issues defined therein. Any holder of this document is advised that information contained hereon reflects the Company's findings at the time of its intervention only and within the limits of Client's instructions, if any. The Company's sole responsibility is to its Client and this document does not exonerate parties to a transaction from exercising all their rights and obligations under the transaction documents. This document cannot be reproduced except in full, without prior written approval of the Company. Any unauthorized alteration, forgery or falsification of the content or appearance of this document is unlawful and offenders may be prosecuted to the fullest extent of the law.

SGS Taiwan Ltd.

No.134,WuKungRoad,NewTaipeiIndustrialPark,WukuDistrict,NewTaipeiCity,Taiwan24803/新北市五股區新北產業園區五工路 134 號

台灣檢驗科技股份有限公司

t (886-2) 2299-3279

f (886-2) 2298-0488

www.tw.sgs.com

Member of SGS Group

| | | | |
|-------------------------|------------------------|----------------------------|----------------|
| Operation Mode : | LTE B12 3M QPSK RB 1.0 | Test Date : | 2017/3/15 |
| Fundamental Frequency : | 707.5 MHz | Temp. / Humi. : | 19.0deg_C/52RH |
| Operation Band : | Tx CH Mid | Test Engineer : | Ashton |
| EUT Pol. : | H | Measurement Antenna Pol. : | Horizontal |

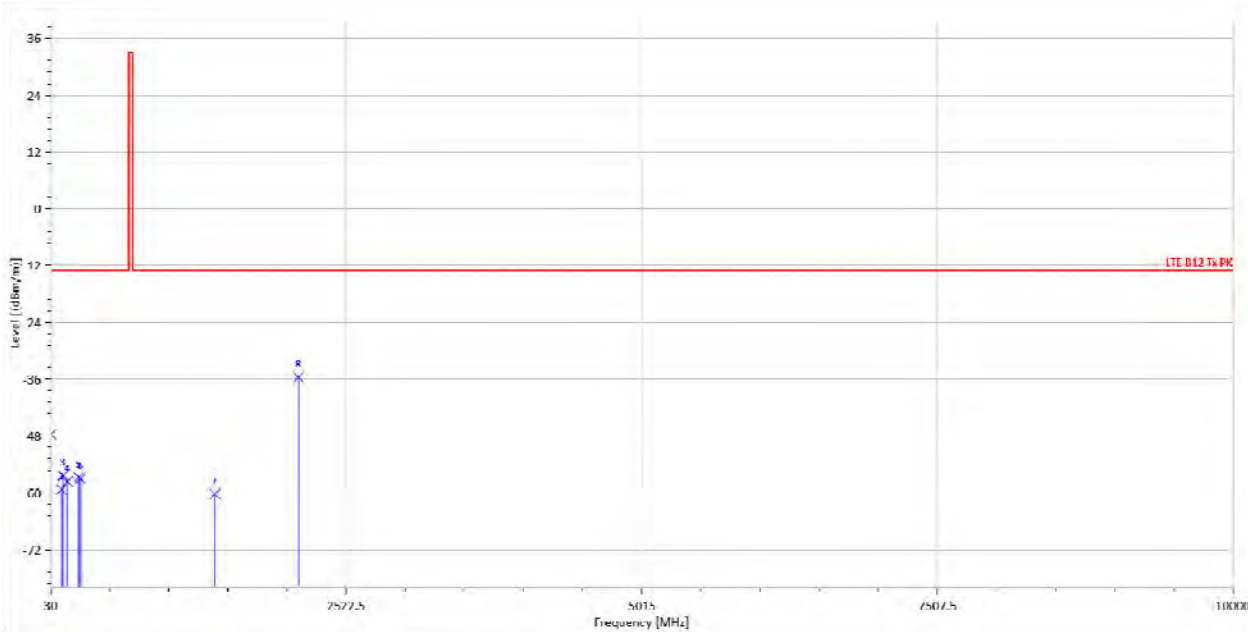

| Freq. MHz | Note F/H/E/S | ERP dBm | SG Output Level dBm | Antenna Gain dBd | Cable Loss dB | Limit @3m dBm/m | Margin dB |
|--------------|-----------------|------------|---------------------------|------------------------|---------------------|-----------------------|--------------|
| 32.91 | S | -47.69 | -27.15 | -19.87 | -0.67 | -13 | -34.69 |
| 121.18 | S | -59.27 | -55.14 | -2.87 | -1.25 | -13 | -46.27 |
| 134.76 | S | -56.37 | -53.33 | -1.67 | -1.38 | -13 | -43.37 |
| 171.62 | S | -57.62 | -58.78 | 2.73 | -1.57 | -13 | -44.62 |
| 266.68 | S | -56.72 | -57.82 | 3.01 | -1.90 | -13 | -43.72 |
| 282.20 | S | -56.97 | -58.63 | 3.63 | -1.97 | -13 | -43.97 |
| 1415.00 | H | -60.26 | -61.81 | 5.93 | -4.38 | -13 | -47.26 |
| 2120.00 | H | -35.60 | -38.20 | 8.02 | -5.42 | -13 | -22.60 |

Unless otherwise stated the results shown in this test report refer only to the sample(s) tested and such sample(s) are retained for 90 days only.

除非另有說明，此報告結果僅對測試之樣品負責，同時此樣品僅保留90天。本報告未經本公司書面許可，不可部份複製。

This document is issued by the Company subject to its General Conditions of Service printed overleaf, available on request or accessible at www.sgs.com/terms_and_conditions.htm and, for electronic format documents, subject to Terms and Conditions for Electronic Documents at www.sgs.com/terms_e-document.htm. Attention is drawn to the limitation of liability, indemnification and jurisdiction issues defined therein. Any holder of this document is advised that information contained hereon reflects the Company's findings at the time of its intervention only and within the limits of Client's instructions, if any. The Company's sole responsibility is to its Client and this document does not exonerate parties to a transaction from exercising all their rights and obligations under the transaction documents. This document cannot be reproduced except in full, without prior written approval of the Company. Any unauthorized alteration, forgery or falsification of the content or appearance of this document is unlawful and offenders may be prosecuted to the fullest extent of the law.

SGS Taiwan Ltd.

No.134,WuKungRoad,NewTaipeiIndustrialPark,WukuDistrict,NewTaipeiCity,Taiwan24803/新北市五股區新北產業園區五工路 134 號

台灣檢驗科技股份有限公司

t (886-2) 2299-3279

f (886-2) 2298-0488

www.tw.sgs.com

Member of SGS Group

| | | | |
|-------------------------|------------------------|----------------------------|----------------|
| Operation Mode : | LTE B12 3M QPSK RB 1.0 | Test Date : | 2017/3/15 |
| Fundamental Frequency : | 714.5 MHz | Temp. / Humi. : | 19.0deg_C/52RH |
| Operation Band : | Tx CH High | Test Engineer : | Ashton |
| EUT Pol. : | H | Measurement Antenna Pol. : | Vertical |

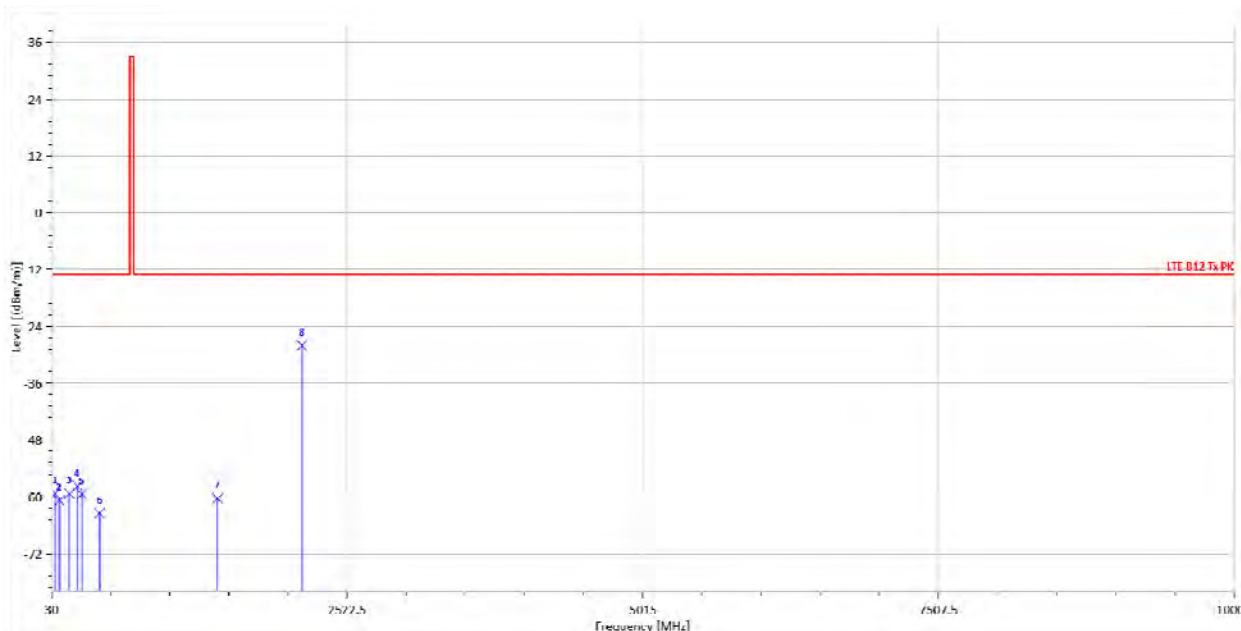

| Freq. MHz | Note F/H/E/S | ERP dBm | SG Output Level dBm | Antenna Gain dBd | Cable Loss dB | Limit @3m dBm/m | Margin dB |
|--------------|-----------------|------------|---------------------------|------------------------|---------------------|-----------------------|--------------|
| 60.07 | S | -59.28 | -55.33 | -3.07 | -0.89 | -13 | -46.28 |
| 95.96 | S | -60.78 | -56.95 | -2.68 | -1.15 | -13 | -47.78 |
| 180.35 | S | -59.32 | -61.32 | 3.58 | -1.58 | -13 | -46.32 |
| 249.22 | S | -57.73 | -58.99 | 3.15 | -1.89 | -13 | -44.73 |
| 285.11 | S | -59.42 | -61.12 | 3.66 | -1.96 | -13 | -46.42 |
| 434.49 | S | -63.47 | -65.10 | 3.96 | -2.33 | -13 | -50.47 |
| 1429.00 | H | -60.35 | -61.94 | 5.98 | -4.40 | -13 | -47.35 |
| 2141.00 | H | -28.06 | -30.63 | 8.03 | -5.46 | -13 | -15.06 |

Unless otherwise stated the results shown in this test report refer only to the sample(s) tested and such sample(s) are retained for 90 days only.

除非另有說明，此報告結果僅對測試之樣品負責，同時此樣品僅保留90天。本報告未經本公司書面許可，不可部份複製。

This document is issued by the Company subject to its General Conditions of Service printed overleaf, available on request or accessible at www.sgs.com/terms_and_conditions.htm and, for electronic format documents, subject to Terms and Conditions for Electronic Documents at www.sgs.com/terms_e-document.htm. Attention is drawn to the limitation of liability, indemnification and jurisdiction issues defined therein. Any holder of this document is advised that information contained hereon reflects the Company's findings at the time of its intervention only and within the limits of Client's instructions, if any. The Company's sole responsibility is to its Client and this document does not exonerate parties to a transaction from exercising all their rights and obligations under the transaction documents. This document cannot be reproduced except in full, without prior written approval of the Company. Any unauthorized alteration, forgery or falsification of the content or appearance of this document is unlawful and offenders may be prosecuted to the fullest extent of the law.

SGS Taiwan Ltd.

No.134,WuKungRoad,NewTaipeiIndustrialPark,WukuDistrict,NewTaipeiCity,Taiwan24803/新北市五股區新北產業園區五工路 134 號

台灣檢驗科技股份有限公司

t (886-2) 2299-3279

f (886-2) 2298-0488

www.tw.sgs.com

Member of SGS Group

Operation Mode : LTE B12 3M QPSK RB 1.0
Fundamental Frequency : 714.5 MHz
Operation Band : Tx CH High
EUT Pol. : H

Test Date : 2017/3/15
Temp. / Humi. : 19.0deg_C/52RH
Test Engineer : Ashton
Measurement Antenna Pol. : Horizontal

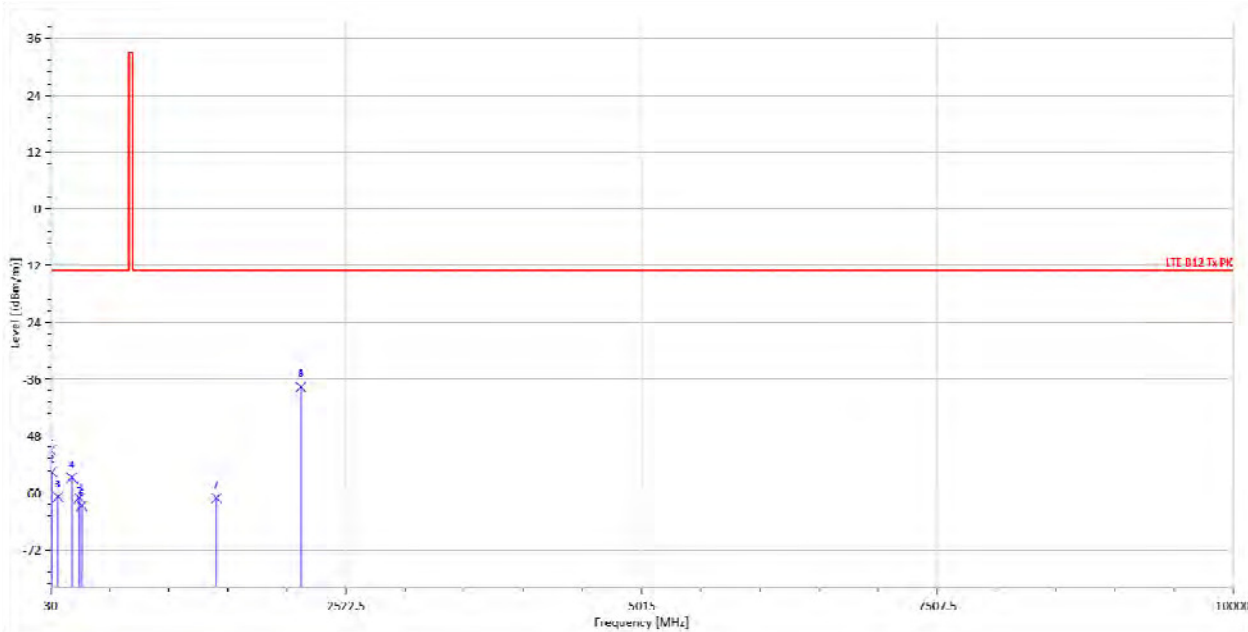

| Freq. MHz | Note F/H/E/S | ERP dBm | SG Output Level dBm | Antenna Gain dBd | Cable Loss dB | Limit @3m dBm/m | Margin dB |
|--------------|-----------------|------------|---------------------------|------------------------|---------------------|-----------------------|--------------|
| 31.94 | S | -51.00 | -29.62 | -20.71 | -0.67 | -13 | -38.00 |
| 39.70 | S | -55.60 | -40.62 | -14.24 | -0.73 | -13 | -42.60 |
| 92.08 | S | -60.86 | -57.39 | -2.34 | -1.13 | -13 | -47.86 |
| 208.48 | S | -56.76 | -58.95 | 3.87 | -1.68 | -13 | -43.76 |
| 272.50 | S | -61.02 | -62.47 | 3.37 | -1.92 | -13 | -48.02 |
| 293.84 | S | -62.71 | -64.46 | 3.74 | -1.99 | -13 | -49.71 |
| 1429.00 | H | -61.09 | -62.68 | 5.98 | -4.40 | -13 | -48.09 |
| 2141.00 | H | -37.64 | -40.22 | 8.03 | -5.46 | -13 | -24.64 |

Unless otherwise stated the results shown in this test report refer only to the sample(s) tested and such sample(s) are retained for 90 days only.

除非另有說明，此報告結果僅對測試之樣品負責，同時此樣品僅保留90天。本報告未經本公司書面許可，不可部份複製。

This document is issued by the Company subject to its General Conditions of Service printed overleaf, available on request or accessible at www.sgs.com/terms_and_conditions.htm and, for electronic format documents, subject to Terms and Conditions for Electronic Documents at www.sgs.com/terms_e-document.htm. Attention is drawn to the limitation of liability, indemnification and jurisdiction issues defined therein. Any holder of this document is advised that information contained hereon reflects the Company's findings at the time of its intervention only and within the limits of Client's instructions, if any. The Company's sole responsibility is to its Client and this document does not exonerate parties to a transaction from exercising all their rights and obligations under the transaction documents. This document cannot be reproduced except in full, without prior written approval of the Company. Any unauthorized alteration, forgery or falsification of the content or appearance of this document is unlawful and offenders may be prosecuted to the fullest extent of the law.

SGS Taiwan Ltd.

No.134,WuKungRoad,NewTaipeiIndustrialPark,WukuDistrict,NewTaipeiCity,Taiwan24803/新北市五股區新北產業園區五工路 134 號

台灣檢驗科技股份有限公司

t (886-2) 2299-3279

f (886-2) 2298-0488

www.tw.sgs.com

Member of SGS Group

Radiated Spurious Emission Measurement Result: LTE-Band 25The Worst Case)

| | | | |
|-------------------------|-------------------------|----------------------------|----------------|
| Operation Mode : | LTE B25 20M QPSK RB 1.0 | Test Date : | 2017/3/15 |
| Fundamental Frequency : | 1860 MHz | Temp. / Humi. : | 22.7deg_C/57RH |
| Operation Band : | Tx CH Low | Test Engineer : | Ashton |
| EUT Pol. : | E2 | Measurement Antenna Pol. : | Vertical |

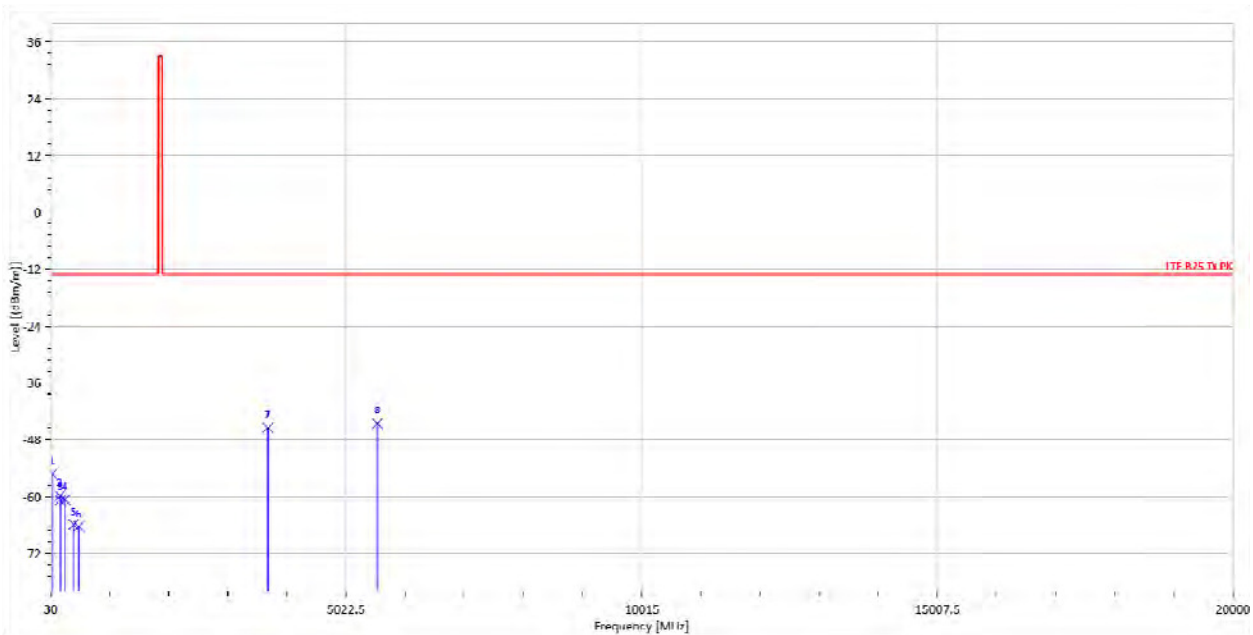

| Freq. | Note | EIRP | SG Output | Antenna | Cable | Limit | Margin |
|---------|---------|--------|-----------|---------|-------|-------|--------|
| MHz | F/H/E/S | dBm | Level | Gain | Loss | @3m | dB |
| | | | dBm | dBi | dB | dBm/m | |
| 58.13 | S | -55.28 | -52.73 | -1.67 | -0.88 | -13 | -42.28 |
| 187.14 | S | -59.87 | -64.37 | 6.05 | -1.55 | -13 | -46.87 |
| 195.87 | S | -60.78 | -65.13 | 5.98 | -1.63 | -13 | -47.78 |
| 273.47 | S | -60.64 | -64.27 | 5.55 | -1.92 | -13 | -47.64 |
| 418.00 | S | -65.95 | -69.26 | 5.94 | -2.63 | -13 | -52.95 |
| 505.30 | S | -66.33 | -70.20 | 6.39 | -2.53 | -13 | -53.33 |
| 3702.00 | H | -45.48 | -50.63 | 12.30 | -7.15 | -13 | -32.48 |
| 5550.00 | H | -44.60 | -48.52 | 12.62 | -8.70 | -13 | -31.60 |

Unless otherwise stated the results shown in this test report refer only to the sample(s) tested and such sample(s) are retained for 90 days only.

除非另有說明，此報告結果僅對測試之樣品負責，同時此樣品僅保留90天。本報告未經本公司書面許可，不可部份複製。

This document is issued by the Company subject to its General Conditions of Service printed overleaf, available on request or accessible at www.sgs.com/terms_and_conditions.htm and, for electronic format documents, subject to Terms and Conditions for Electronic Documents at www.sgs.com/terms_e-document.htm. Attention is drawn to the limitation of liability, indemnification and jurisdiction issues defined therein. Any holder of this document is advised that information contained hereon reflects the Company's findings at the time of its intervention only and within the limits of Client's instructions, if any. The Company's sole responsibility is to its Client and this document does not exonerate parties to a transaction from exercising all their rights and obligations under the transaction documents. This document cannot be reproduced except in full, without prior written approval of the Company. Any unauthorized alteration, forgery or falsification of the content or appearance of this document is unlawful and offenders may be prosecuted to the fullest extent of the law.

SGS Taiwan Ltd.

No.134,WuKungRoad,NewTaipeiIndustrialPark,WukuDistrict,NewTaipeiCity,Taiwan24803/新北市五股區新北產業園區五工路 134 號

台灣檢驗科技股份有限公司

t (886-2) 2299-3279

f (886-2) 2298-0488

www.tw.sgs.com

Member of SGS Group

| | | | |
|-------------------------|-------------------------|----------------------------|----------------|
| Operation Mode : | LTE B25 20M QPSK RB 1.0 | Test Date : | 2017/3/15 |
| Fundamental Frequency : | 1860 MHz | Temp. / Humi. : | 22.7deg_C/57RH |
| Operation Band : | Tx CH Low | Test Engineer : | Ashton |
| EUT Pol. : | E2 | Measurement Antenna Pol. : | Horizontal |

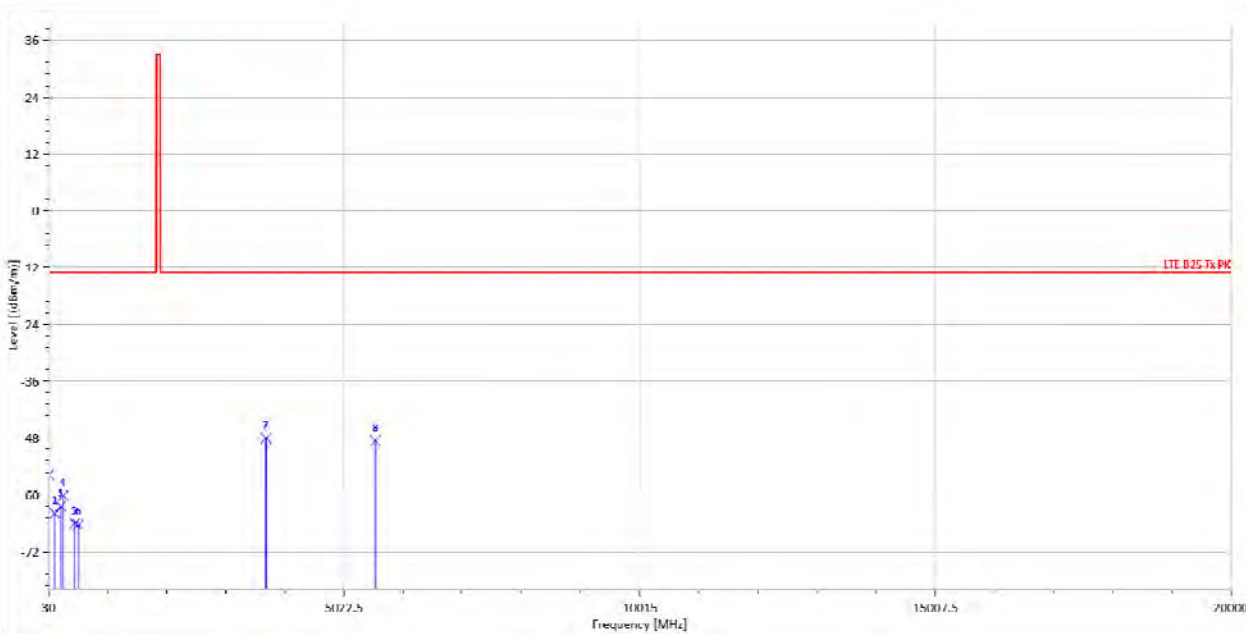

| Freq. | Note | EIRP | SG Output | Antenna | Cable | Limit | Margin |
|---------|---------|--------|-----------|---------|-------|-------|--------|
| MHz | F/H/E/S | dBm | Level | Gain | Loss | @3m | dB |
| 33.88 | S | -55.74 | -38.17 | -16.88 | -0.68 | -13 | -42.74 |
| 133.79 | S | -63.98 | -63.02 | 0.36 | -1.32 | -13 | -50.98 |
| 234.67 | S | -62.41 | -66.68 | 6.00 | -1.73 | -13 | -49.41 |
| 276.38 | S | -60.17 | -63.86 | 5.64 | -1.95 | -13 | -47.17 |
| 471.35 | S | -66.04 | -69.80 | 6.32 | -2.56 | -13 | -53.04 |
| 532.46 | S | -66.29 | -69.73 | 6.41 | -2.96 | -13 | -53.29 |
| 3702.00 | H | -48.01 | -53.16 | 12.30 | -7.15 | -13 | -35.01 |
| 5550.00 | H | -48.59 | -52.51 | 12.62 | -8.70 | -13 | -35.59 |

Unless otherwise stated the results shown in this test report refer only to the sample(s) tested and such sample(s) are retained for 90 days only.

除非另有說明，此報告結果僅對測試之樣品負責，同時此樣品僅保留90天。本報告未經本公司書面許可，不可部份複製。

This document is issued by the Company subject to its General Conditions of Service printed overleaf, available on request or accessible at www.sgs.com/terms_and_conditions.htm and, for electronic format documents, subject to Terms and Conditions for Electronic Documents at www.sgs.com/terms_e-document.htm. Attention is drawn to the limitation of liability, indemnification and jurisdiction issues defined therein. Any holder of this document is advised that information contained hereon reflects the Company's findings at the time of its intervention only and within the limits of Client's instructions, if any. The Company's sole responsibility is to its Client and this document does not exonerate parties to a transaction from exercising all their rights and obligations under the transaction documents. This document cannot be reproduced except in full, without prior written approval of the Company. Any unauthorized alteration, forgery or falsification of the content or appearance of this document is unlawful and offenders may be prosecuted to the fullest extent of the law.

SGS Taiwan Ltd.

No.134,WuKungRoad,NewTaipeiIndustrialPark,WukuDistrict,NewTaipeiCity,Taiwan24803/新北市五股區新北產業園區五工路 134 號

台灣檢驗科技股份有限公司

t (886-2) 2299-3279

f (886-2) 2298-0488

www.tw.sgs.com

Member of SGS Group

| | | | |
|-------------------------|-------------------------|----------------------------|----------------|
| Operation Mode : | LTE B25 20M QPSK RB 1.0 | Test Date : | 2017/3/15 |
| Fundamental Frequency : | 1882.5 MHz | Temp. / Humi. : | 22.7deg_C/57RH |
| Operation Band : | Tx CH Mid | Test Engineer : | Ashton |
| EUT Pol. : | E2 | Measurement Antenna Pol. : | Vertical |

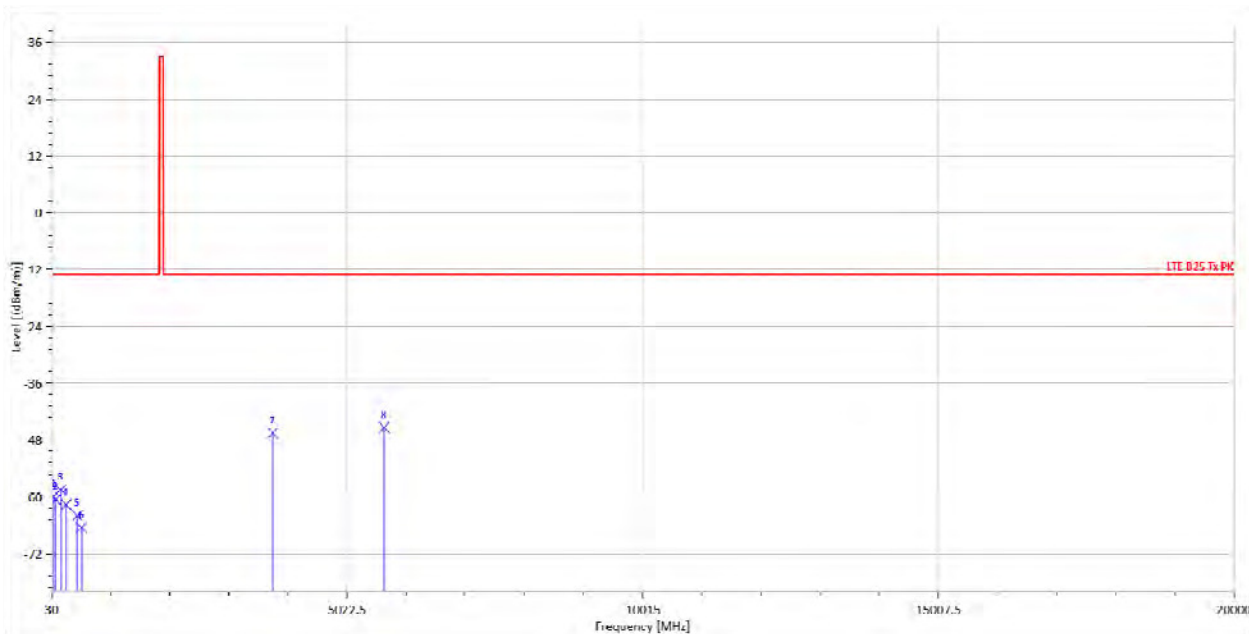

| Freq. | Note | EIRP | SG Output | Antenna | Cable | Limit | Margin |
|---------|---------|--------|-----------|---------|-------|-------|--------|
| MHz | F/H/E/S | dBm | Level | Gain | Loss | @3m | dB |
| 60.07 | S | -59.93 | -58.13 | -0.92 | -0.89 | -13 | -46.93 |
| 96.93 | S | -60.57 | -58.80 | -0.62 | -1.15 | -13 | -47.57 |
| 185.20 | S | -58.54 | -62.85 | 5.96 | -1.64 | -13 | -45.54 |
| 276.38 | S | -61.67 | -65.36 | 5.64 | -1.95 | -13 | -48.67 |
| 461.65 | S | -64.03 | -67.88 | 6.30 | -2.45 | -13 | -51.03 |
| 536.34 | S | -66.52 | -70.36 | 6.41 | -2.57 | -13 | -53.52 |
| 3765.00 | H | -46.53 | -51.62 | 12.30 | -7.21 | -13 | -33.53 |
| 5648.00 | H | -45.37 | -49.20 | 12.66 | -8.83 | -13 | -32.37 |

Unless otherwise stated the results shown in this test report refer only to the sample(s) tested and such sample(s) are retained for 90 days only.

除非另有說明，此報告結果僅對測試之樣品負責，同時此樣品僅保留90天。本報告未經本公司書面許可，不可部份複製。

This document is issued by the Company subject to its General Conditions of Service printed overleaf, available on request or accessible at www.sgs.com/terms_and_conditions.htm and, for electronic format documents, subject to Terms and Conditions for Electronic Documents at www.sgs.com/terms_e-document.htm. Attention is drawn to the limitation of liability, indemnification and jurisdiction issues defined therein. Any holder of this document is advised that information contained hereon reflects the Company's findings at the time of its intervention only and within the limits of Client's instructions, if any. The Company's sole responsibility is to its Client and this document does not exonerate parties to a transaction from exercising all their rights and obligations under the transaction documents. This document cannot be reproduced except in full, without prior written approval of the Company. Any unauthorized alteration, forgery or falsification of the content or appearance of this document is unlawful and offenders may be prosecuted to the fullest extent of the law.

SGS Taiwan Ltd.

No.134,WuKungRoad,NewTaipeiIndustrialPark,WukuDistrict,NewTaipeiCity,Taiwan24803/新北市五股區新北產業園區五工路 134 號

台灣檢驗科技股份有限公司

t (886-2) 2299-3279

f (886-2) 2298-0488

www.tw.sgs.com

Member of SGS Group

| | | | |
|-------------------------|-------------------------|----------------------------|----------------|
| Operation Mode : | LTE B25 20M QPSK RB 1.0 | Test Date : | 2017/3/15 |
| Fundamental Frequency : | 1882.5 MHz | Temp. / Humi. : | 22.7deg_C/57RH |
| Operation Band : | Tx CH Mid | Test Engineer : | Ashton |
| EUT Pol. : | E2 | Measurement Antenna Pol. : | Horizontal |

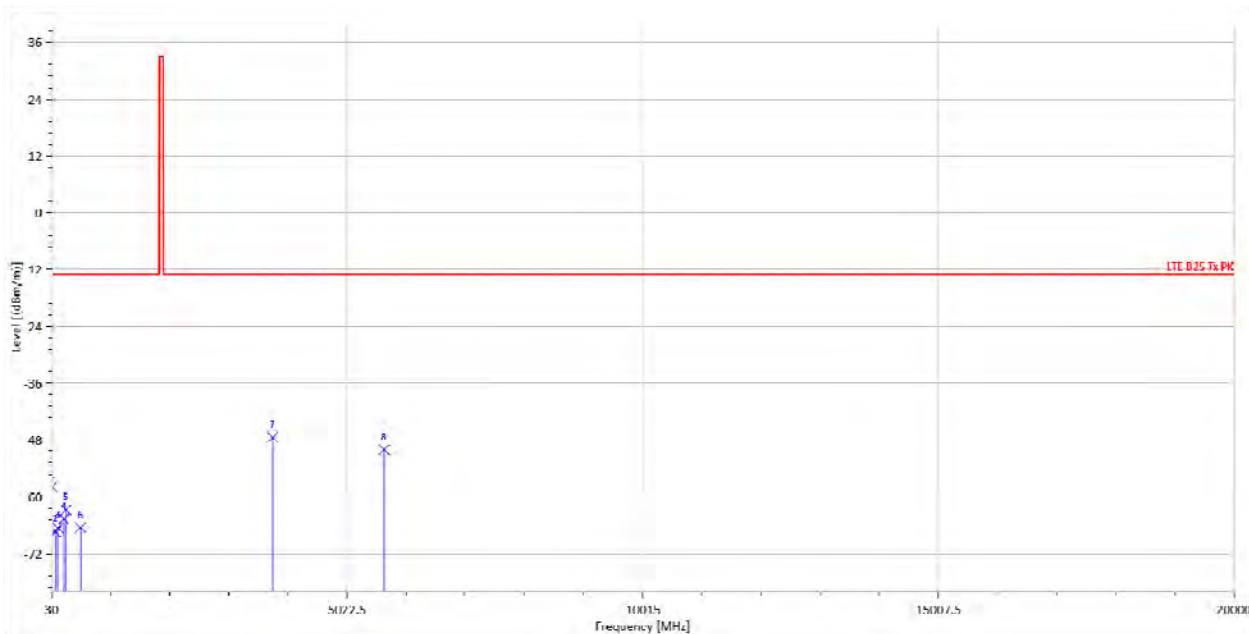

| Freq. | Note | EIRP | SG Output | Antenna | Cable | Limit | Margin |
|---------|---------|--------|-----------|---------|-------|-------|--------|
| MHz | F/H/E/S | dBm | Level | Gain | Loss | @3m | dB |
| | | | dBm | dBi | dB | dBm/m | dB |
| 37.76 | S | -57.93 | -43.57 | -13.67 | -0.70 | -13 | -44.93 |
| 97.90 | S | -67.37 | -65.50 | -0.70 | -1.16 | -13 | -54.37 |
| 133.79 | S | -66.58 | -65.62 | 0.36 | -1.32 | -13 | -53.58 |
| 236.61 | S | -64.67 | -68.76 | 5.89 | -1.80 | -13 | -51.67 |
| 274.44 | S | -62.79 | -66.45 | 5.58 | -1.91 | -13 | -49.79 |
| 519.85 | S | -66.49 | -70.12 | 6.40 | -2.78 | -13 | -53.49 |
| 3765.00 | H | -47.42 | -52.51 | 12.30 | -7.21 | -13 | -34.42 |
| 5648.00 | H | -50.02 | -53.86 | 12.66 | -8.83 | -13 | -37.02 |

Unless otherwise stated the results shown in this test report refer only to the sample(s) tested and such sample(s) are retained for 90 days only.

除非另有說明，此報告結果僅對測試之樣品負責，同時此樣品僅保留90天。本報告未經本公司書面許可，不可部份複製。

This document is issued by the Company subject to its General Conditions of Service printed overleaf, available on request or accessible at www.sgs.com/terms_and_conditions.htm and, for electronic format documents, subject to Terms and Conditions for Electronic Documents at www.sgs.com/terms_e-document.htm. Attention is drawn to the limitation of liability, indemnification and jurisdiction issues defined therein. Any holder of this document is advised that information contained hereon reflects the Company's findings at the time of its intervention only and within the limits of Client's instructions, if any. The Company's sole responsibility is to its Client and this document does not exonerate parties to a transaction from exercising all their rights and obligations under the transaction documents. This document cannot be reproduced except in full, without prior written approval of the Company. Any unauthorized alteration, forgery or falsification of the content or appearance of this document is unlawful and offenders may be prosecuted to the fullest extent of the law.

SGS Taiwan Ltd.

No.134,WuKungRoad,NewTaipeiIndustrialPark,WukuDistrict,NewTaipeiCity,Taiwan24803/新北市五股區新北產業園區五工路 134 號

台灣檢驗科技股份有限公司

t (886-2) 2299-3279

f (886-2) 2298-0488

www.tw.sgs.com

Member of SGS Group

| | | | |
|-------------------------|-------------------------|----------------------------|----------------|
| Operation Mode : | LTE B25 20M QPSK RB 1.0 | Test Date : | 2017/3/15 |
| Fundamental Frequency : | 1914.3 MHz | Temp. / Humi. : | 22.7deg_C/57RH |
| Operation Band : | Tx CH High | Test Engineer : | Ashton |
| EUT Pol. : | E2 | Measurement Antenna Pol. : | Vertical |

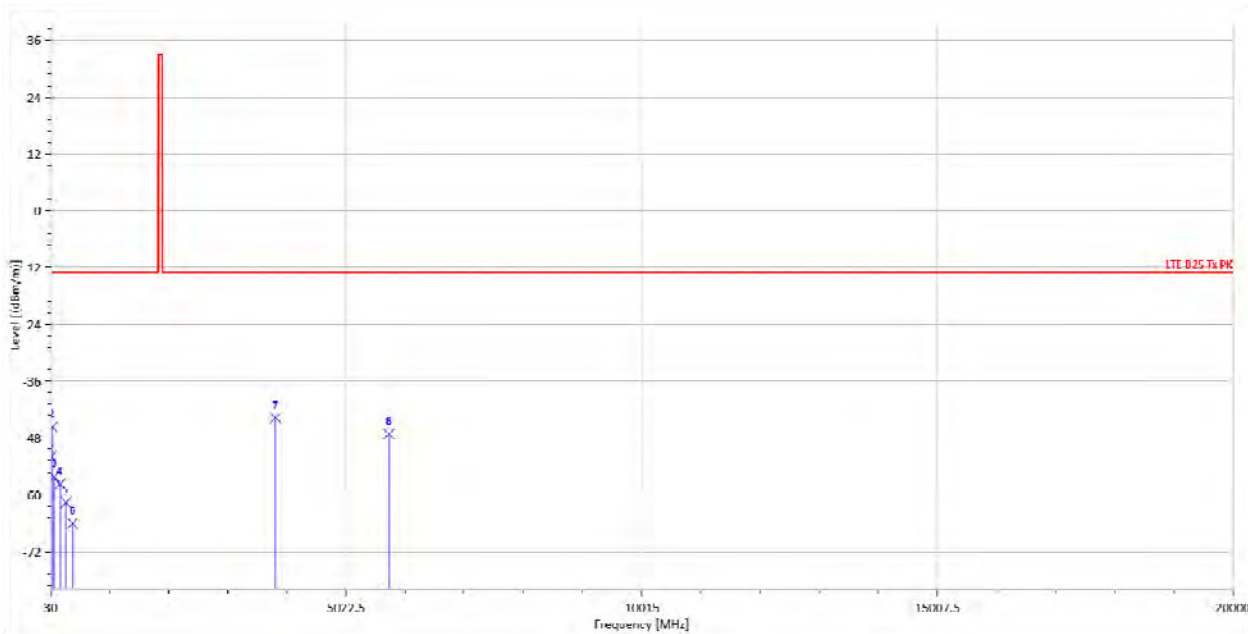

| Freq. MHz | Note F/H/E/S | EIRP dBm | SG Output Level dBm | Antenna Gain dBi | Cable Loss dB | Limit @3m dBm/m | Margin dB |
|--------------|-----------------|-------------|---------------------------|------------------------|---------------------|-----------------------|--------------|
| 35.82 | S | -51.95 | -35.98 | -15.24 | -0.73 | -13 | -38.95 |
| 58.13 | S | -45.65 | -43.10 | -1.67 | -0.88 | -13 | -32.65 |
| 91.11 | S | -56.17 | -54.95 | -0.10 | -1.12 | -13 | -43.17 |
| 189.08 | S | -57.74 | -62.29 | 6.14 | -1.59 | -13 | -44.74 |
| 289.96 | S | -61.67 | -65.54 | 5.86 | -1.99 | -13 | -48.67 |
| 401.51 | S | -66.01 | -69.60 | 5.77 | -2.17 | -13 | -53.01 |
| 3828.00 | H | -43.72 | -48.75 | 12.30 | -7.27 | -13 | -30.72 |
| 5746.00 | H | -47.14 | -50.92 | 12.70 | -8.92 | -13 | -34.14 |

Unless otherwise stated the results shown in this test report refer only to the sample(s) tested and such sample(s) are retained for 90 days only.

除非另有說明，此報告結果僅對測試之樣品負責，同時此樣品僅保留90天。本報告未經本公司書面許可，不可部份複製。

This document is issued by the Company subject to its General Conditions of Service printed overleaf, available on request or accessible at www.sgs.com/terms_and_conditions.htm and, for electronic format documents, subject to Terms and Conditions for Electronic Documents at www.sgs.com/terms_e-document.htm. Attention is drawn to the limitation of liability, indemnification and jurisdiction issues defined therein. Any holder of this document is advised that information contained hereon reflects the Company's findings at the time of its intervention only and within the limits of Client's instructions, if any. The Company's sole responsibility is to its Client and this document does not exonerate parties to a transaction from exercising all their rights and obligations under the transaction documents. This document cannot be reproduced except in full, without prior written approval of the Company. Any unauthorized alteration, forgery or falsification of the content or appearance of this document is unlawful and offenders may be prosecuted to the fullest extent of the law.

SGS Taiwan Ltd.

No.134,WuKungRoad,NewTaipeiIndustrialPark,WukuDistrict,NewTaipeiCity,Taiwan24803/新北市五股區新北產業園區五工路 134 號

台灣檢驗科技股份有限公司

t (886-2) 2299-3279

f (886-2) 2298-0488

www.tw.sgs.com

Member of SGS Group

Operation Mode : LTE B25 20M QPSK RB 1.0
 Fundamental Frequency : 1914.3 MHz
 Operation Band : Tx CH High
 EUT Pol. : E2

Test Date : 2017/3/15
 Temp. / Humi. : 22.7deg_C/57RH
 Test Engineer : Ashton
 Measurement Antenna Pol. : Horizontal

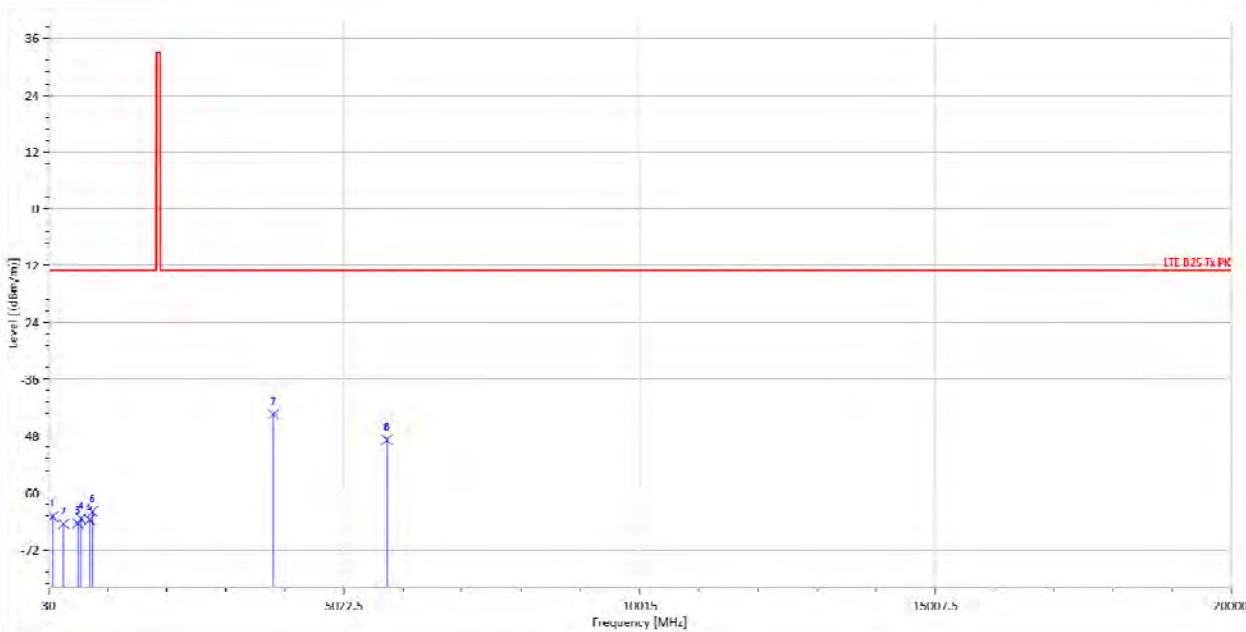

| Freq. MHz | Note F/H/E/S | EIRP dBm | SG Output Level dBm | Antenna Gain dBi | Cable Loss dB | Limit @3m dBm/m | Margin dB |
|--------------|-----------------|-------------|---------------------------|------------------------|---------------------|-----------------------|--------------|
| 101.78 | S | -64.97 | -62.84 | -0.96 | -1.18 | -13 | -51.97 |
| 282.20 | S | -66.58 | -70.39 | 5.78 | -1.97 | -13 | -53.58 |
| 527.61 | S | -66.48 | -70.25 | 6.40 | -2.63 | -13 | -53.48 |
| 576.11 | S | -65.44 | -69.41 | 6.66 | -2.69 | -13 | -52.44 |
| 723.55 | S | -65.67 | -70.43 | 7.61 | -2.85 | -13 | -52.67 |
| 772.05 | S | -63.98 | -68.29 | 7.64 | -3.33 | -13 | -50.98 |
| 3828.00 | H | -43.40 | -48.44 | 12.30 | -7.27 | -13 | -30.40 |
| 5746.00 | H | -48.80 | -52.58 | 12.70 | -8.92 | -13 | -35.80 |

Unless otherwise stated the results shown in this test report refer only to the sample(s) tested and such sample(s) are retained for 90 days only.

除非另有說明，此報告結果僅對測試之樣品負責，同時此樣品僅保留90天。本報告未經本公司書面許可，不可部份複製。

This document is issued by the Company subject to its General Conditions of Service printed overleaf, available on request or accessible at www.sgs.com/terms_and_conditions.htm and, for electronic format documents, subject to Terms and Conditions for Electronic Documents at www.sgs.com/terms_e-document.htm. Attention is drawn to the limitation of liability, indemnification and jurisdiction issues defined therein. Any holder of this document is advised that information contained hereon reflects the Company's findings at the time of its intervention only and within the limits of Client's instructions, if any. The Company's sole responsibility is to its Client and this document does not exonerate parties to a transaction from exercising all their rights and obligations under the transaction documents. This document cannot be reproduced except in full, without prior written approval of the Company. Any unauthorized alteration, forgery or falsification of the content or appearance of this document is unlawful and offenders may be prosecuted to the fullest extent of the law.

SGS Taiwan Ltd.

No.134,WuKungRoad,NewTaipeiIndustrialPark,WukuDistrict,NewTaipeiCity,Taiwan24803/新北市五股區新北產業園區五工路 134 號

台灣檢驗科技股份有限公司

t (886-2) 2299-3279

f (886-2) 2298-0488

www.tw.sgs.com

Member of SGS Group

Radiated Spurious Emission Measurement Result: LTE-Band 26 (The Worst Case)

| | | | |
|-------------------------|-------------------------|----------------------------|----------------|
| Operation Mode : | LTE B26 15M QPSK RB 1.0 | Test Date : | 2017/3/15 |
| Fundamental Frequency : | 831.5 MHz | Temp. / Humi. : | 19.0deg_C/52RH |
| Operation Band : | Tx CH Low | Test Engineer : | Ashton |
| EUT Pol. : | H | Measurement Antenna Pol. : | Vertical |

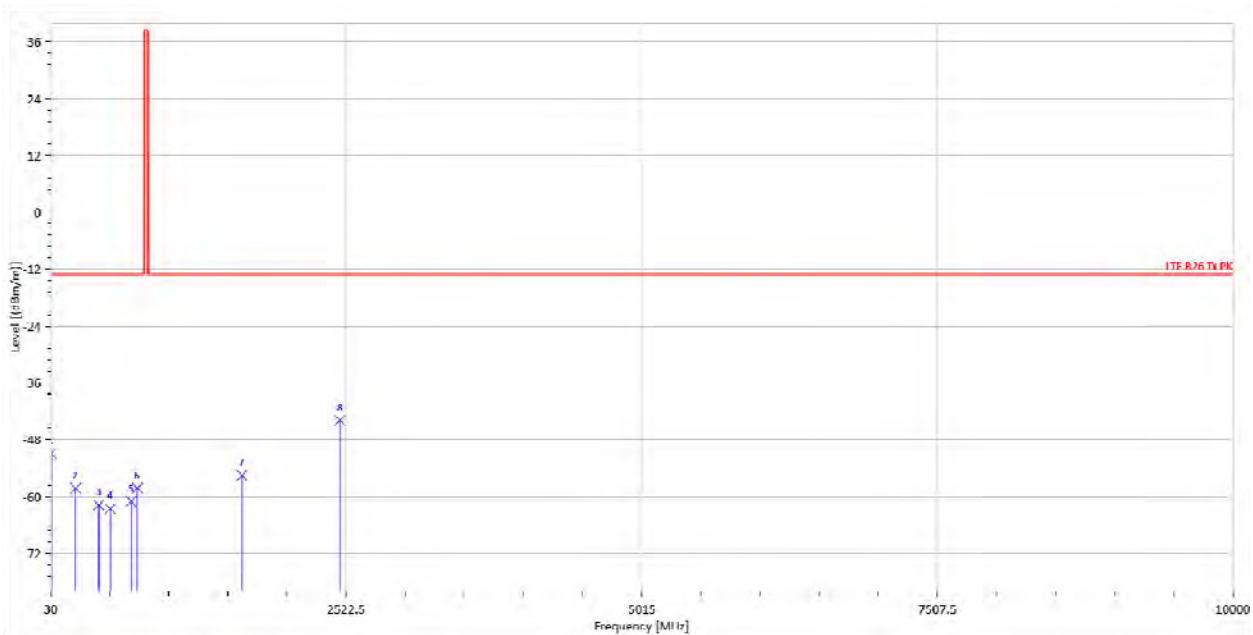

| Freq. | Note | ERP | SG Output | Antenna | Cable | Limit | Margin |
|---------|---------|--------|--------------|-------------|------------|--------------|--------|
| MHz | F/H/E/S | dBm | Level dBm | Gain dBd | Loss dB | @3m dBm/m | dB |
| 36.79 | S | -50.90 | -33.58 | -16.61 | -0.71 | -13 | -37.90 |
| 239.52 | S | -58.27 | -60.04 | 3.59 | -1.82 | -13 | -45.27 |
| 435.46 | S | -61.83 | -63.30 | 3.97 | -2.50 | -13 | -48.83 |
| 533.43 | S | -62.57 | -64.02 | 4.26 | -2.81 | -13 | -49.57 |
| 709.97 | S | -61.00 | -63.38 | 5.46 | -3.08 | -13 | -48.00 |
| 761.38 | S | -58.24 | -60.47 | 5.48 | -3.24 | -13 | -45.24 |
| 1644.00 | H | -55.55 | -57.58 | 6.74 | -4.71 | -13 | -42.55 |
| 2470.00 | H | -43.90 | -46.29 | 8.23 | -5.84 | -13 | -30.90 |

Unless otherwise stated the results shown in this test report refer only to the sample(s) tested and such sample(s) are retained for 90 days only.

除非另有說明，此報告結果僅對測試之樣品負責，同時此樣品僅保留90天。本報告未經本公司書面許可，不可部份複製。

This document is issued by the Company subject to its General Conditions of Service printed overleaf, available on request or accessible at www.sgs.com/terms_and_conditions.htm and, for electronic format documents, subject to Terms and Conditions for Electronic Documents at www.sgs.com/terms_e-document.htm. Attention is drawn to the limitation of liability, indemnification and jurisdiction issues defined therein. Any holder of this document is advised that information contained hereon reflects the Company's findings at the time of its intervention only and within the limits of Client's instructions, if any. The Company's sole responsibility is to its Client and this document does not exonerate parties to a transaction from exercising all their rights and obligations under the transaction documents. This document cannot be reproduced except in full, without prior written approval of the Company. Any unauthorized alteration, forgery or falsification of the content or appearance of this document is unlawful and offenders may be prosecuted to the fullest extent of the law.

SGS Taiwan Ltd.

No.134,WuKungRoad,NewTaipeiIndustrialPark,WukuDistrict,NewTaipeiCity,Taiwan24803/新北市五股區新北產業園區五工路 134 號

台灣檢驗科技股份有限公司

t (886-2) 2299-3279

f (886-2) 2298-0488

www.tw.sgs.com

Member of SGS Group

| | | | |
|-------------------------|-------------------------|----------------------------|----------------|
| Operation Mode : | LTE B26 15M QPSK RB 1.0 | Test Date : | 2017/3/15 |
| Fundamental Frequency : | 831.5 MHz | Temp. / Humi. : | 19.0deg_C/52RH |
| Operation Band : | Tx CH Low | Test Engineer : | Ashton |
| EUT Pol. : | H | Measurement Antenna Pol. : | Horizontal |

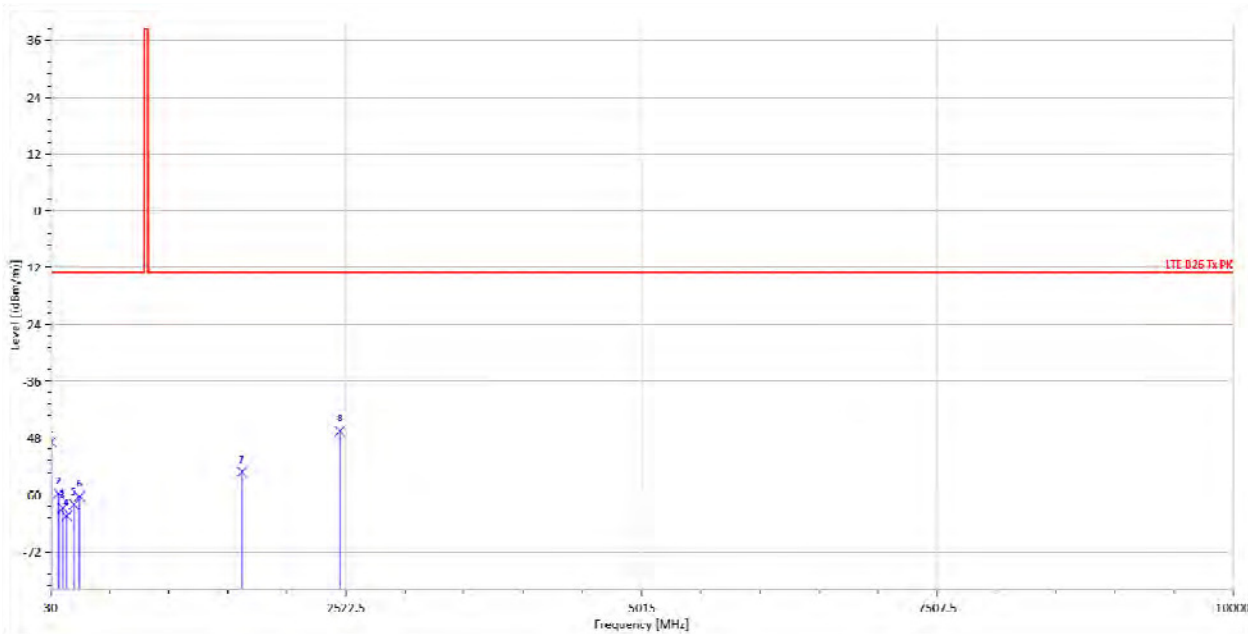

| Freq. MHz | Note F/H/E/S | ERP dBm | SG Output Level dBm | Antenna Gain dBd | Cable Loss dB | Limit @3m dBm/m | Margin dB |
|--------------|-----------------|------------|---------------------------|------------------------|---------------------|-----------------------|--------------|
| 35.82 | S | -48.84 | -30.72 | -17.39 | -0.73 | -13 | -35.84 |
| 96.93 | S | -59.71 | -55.79 | -2.77 | -1.15 | -13 | -46.71 |
| 132.82 | S | -62.81 | -59.58 | -1.91 | -1.32 | -13 | -49.81 |
| 164.83 | S | -64.45 | -64.92 | 1.99 | -1.52 | -13 | -51.45 |
| 227.88 | S | -62.03 | -64.41 | 4.16 | -1.78 | -13 | -49.03 |
| 272.50 | S | -60.36 | -61.81 | 3.37 | -1.92 | -13 | -47.36 |
| 1644.00 | H | -55.13 | -57.15 | 6.74 | -4.71 | -13 | -42.13 |
| 2470.00 | H | -46.55 | -48.94 | 8.23 | -5.84 | -13 | -33.55 |

Unless otherwise stated the results shown in this test report refer only to the sample(s) tested and such sample(s) are retained for 90 days only.

除非另有說明，此報告結果僅對測試之樣品負責，同時此樣品僅保留90天。本報告未經本公司書面許可，不可部份複製。

This document is issued by the Company subject to its General Conditions of Service printed overleaf, available on request or accessible at www.sgs.com/terms_and_conditions.htm and, for electronic format documents, subject to Terms and Conditions for Electronic Documents at www.sgs.com/terms_e-document.htm. Attention is drawn to the limitation of liability, indemnification and jurisdiction issues defined therein. Any holder of this document is advised that information contained hereon reflects the Company's findings at the time of its intervention only and within the limits of Client's instructions, if any. The Company's sole responsibility is to its Client and this document does not exonerate parties to a transaction from exercising all their rights and obligations under the transaction documents. This document cannot be reproduced except in full, without prior written approval of the Company. Any unauthorized alteration, forgery or falsification of the content or appearance of this document is unlawful and offenders may be prosecuted to the fullest extent of the law.

SGS Taiwan Ltd.

No.134,WuKungRoad,NewTaipeiIndustrialPark,WukuDistrict,NewTaipeiCity,Taiwan24803/新北市五股區新北產業園區五工路 134 號

台灣檢驗科技股份有限公司

t (886-2) 2299-3279

f (886-2) 2298-0488

www.tw.sgs.com

Member of SGS Group

| | | | |
|-------------------------|-------------------------|----------------------------|----------------|
| Operation Mode : | LTE B26 15M QPSK RB 1.0 | Test Date : | 2017/3/15 |
| Fundamental Frequency : | 836.5MHz | Temp. / Humi. : | 19.0deg_C/52RH |
| Operation Band : | Tx CH Mid | Test Engineer : | Ashton |
| EUT Pol. : | H | Measurement Antenna Pol. : | Vertical |

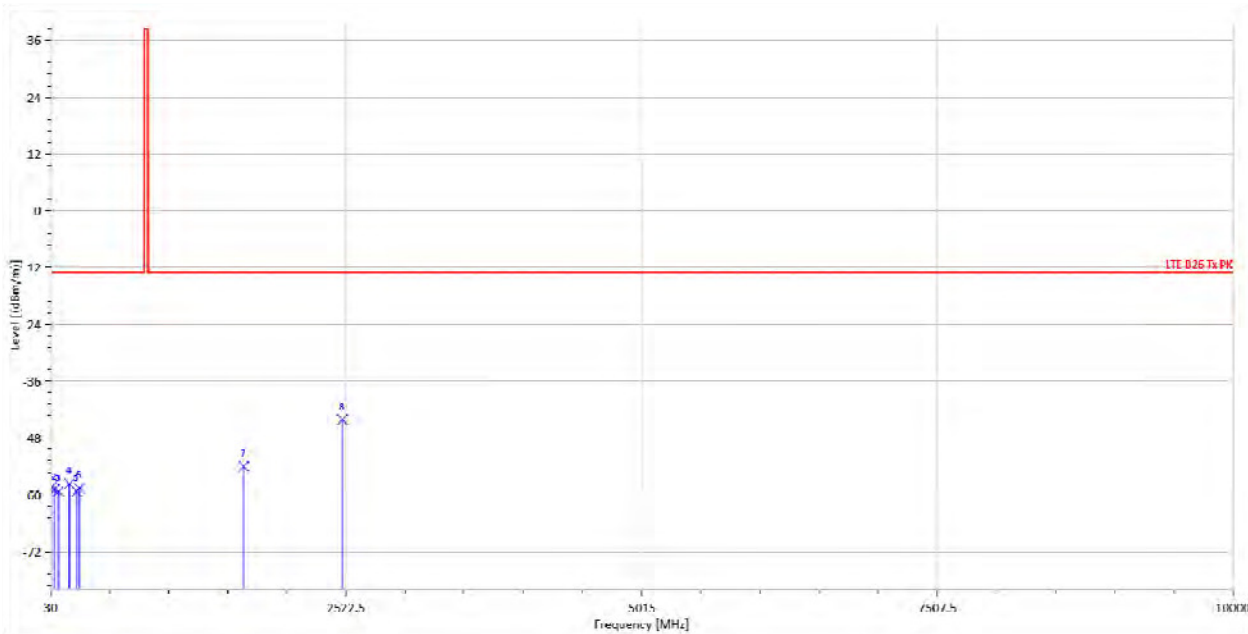

| Freq. MHz | Note F/H/E/S | ERP dBm | SG Output Level dBm | Antenna Gain dBd | Cable Loss dB | Limit @3m dBm/m | Margin dB |
|--------------|-----------------|------------|---------------------------|------------------------|---------------------|-----------------------|--------------|
| 34.85 | S | -58.40 | -39.51 | -18.19 | -0.71 | -13 | -45.40 |
| 61.04 | S | -58.85 | -54.97 | -2.94 | -0.95 | -13 | -45.85 |
| 95.96 | S | -59.24 | -55.41 | -2.68 | -1.15 | -13 | -46.24 |
| 188.11 | S | -57.67 | -60.05 | 3.95 | -1.56 | -13 | -44.67 |
| 250.19 | S | -59.29 | -60.48 | 3.11 | -1.92 | -13 | -46.29 |
| 271.53 | S | -58.59 | -60.02 | 3.34 | -1.91 | -13 | -45.59 |
| 1658.00 | H | -53.97 | -56.02 | 6.79 | -4.74 | -13 | -40.97 |
| 2491.00 | H | -44.10 | -46.47 | 8.24 | -5.87 | -13 | -31.10 |

Unless otherwise stated the results shown in this test report refer only to the sample(s) tested and such sample(s) are retained for 90 days only.

除非另有說明，此報告結果僅對測試之樣品負責，同時此樣品僅保留90天。本報告未經本公司書面許可，不可部份複製。

This document is issued by the Company subject to its General Conditions of Service printed overleaf, available on request or accessible at www.sgs.com/terms_and_conditions.htm and, for electronic format documents, subject to Terms and Conditions for Electronic Documents at www.sgs.com/terms_e-document.htm. Attention is drawn to the limitation of liability, indemnification and jurisdiction issues defined therein. Any holder of this document is advised that information contained hereon reflects the Company's findings at the time of its intervention only and within the limits of Client's instructions, if any. The Company's sole responsibility is to its Client and this document does not exonerate parties to a transaction from exercising all their rights and obligations under the transaction documents. This document cannot be reproduced except in full, without prior written approval of the Company. Any unauthorized alteration, forgery or falsification of the content or appearance of this document is unlawful and offenders may be prosecuted to the fullest extent of the law.

SGS Taiwan Ltd.

No.134,WuKungRoad,NewTaipeiIndustrialPark,WukuDistrict,NewTaipeiCity,Taiwan24803/新北市五股區新北產業園區五工路 134 號

台灣檢驗科技股份有限公司

t (886-2) 2299-3279

f (886-2) 2298-0488

www.tw.sgs.com

Member of SGS Group

| | | | |
|-------------------------|-------------------------|----------------------------|----------------|
| Operation Mode : | LTE B26 15M QPSK RB 1.0 | Test Date : | 2017/3/15 |
| Fundamental Frequency : | 836.5MHz | Temp. / Humi. : | 19.0deg_C/52RH |
| Operation Band : | Tx CH Mid | Test Engineer : | Ashton |
| EUT Pol. : | H | Measurement Antenna Pol. : | Horizontal |

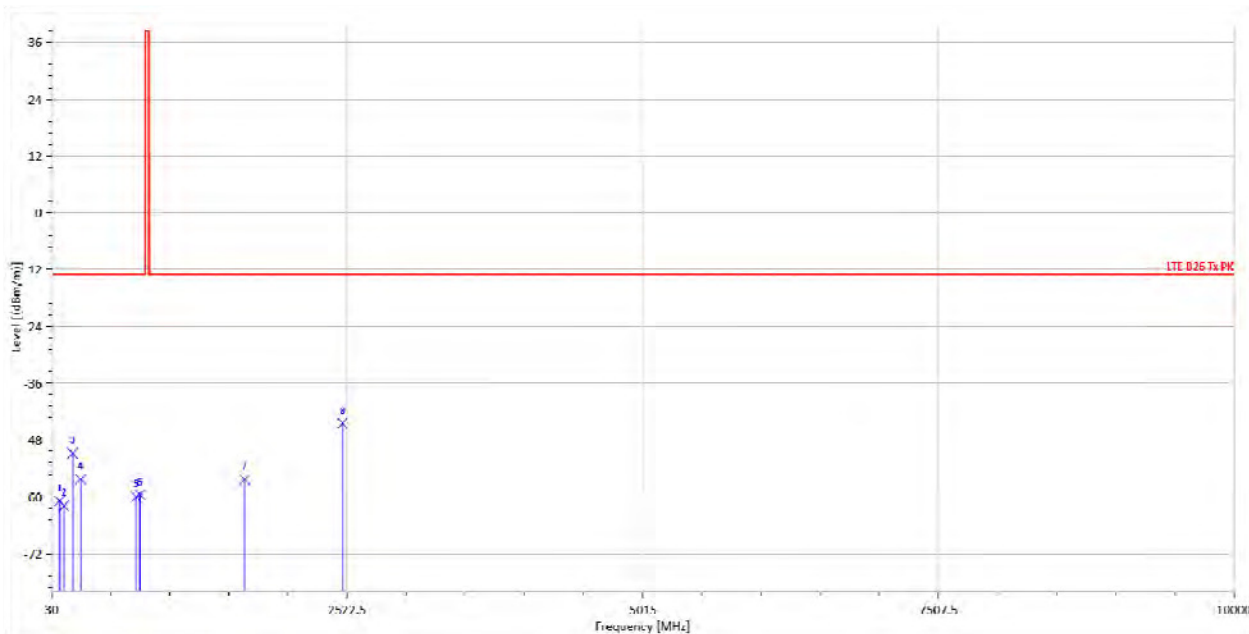

| Freq. MHz | Note F/H/E/S | ERP dBm | SG Output Level dBm | Antenna Gain dBd | Cable Loss dB | Limit @3m dBm/m | Margin dB |
|--------------|-----------------|------------|---------------------------|------------------------|---------------------|-----------------------|--------------|
| 96.93 | S | -60.86 | -56.94 | -2.77 | -1.15 | -13 | -47.86 |
| 133.79 | S | -61.89 | -58.78 | -1.79 | -1.32 | -13 | -48.89 |
| 208.48 | S | -50.82 | -53.01 | 3.87 | -1.68 | -13 | -37.82 |
| 275.41 | S | -56.27 | -57.80 | 3.46 | -1.92 | -13 | -43.27 |
| 742.95 | S | -60.01 | -62.44 | 5.46 | -3.03 | -13 | -47.01 |
| 775.93 | S | -59.59 | -62.02 | 5.49 | -3.06 | -13 | -46.59 |
| 1658.00 | H | -56.36 | -58.41 | 6.79 | -4.74 | -13 | -43.36 |
| 2484.00 | H | -44.45 | -46.84 | 8.24 | -5.85 | -13 | -31.45 |

Unless otherwise stated the results shown in this test report refer only to the sample(s) tested and such sample(s) are retained for 90 days only.

除非另有說明，此報告結果僅對測試之樣品負責，同時此樣品僅保留90天。本報告未經本公司書面許可，不可部份複製。

This document is issued by the Company subject to its General Conditions of Service printed overleaf, available on request or accessible at www.sgs.com/terms_and_conditions.htm and, for electronic format documents, subject to Terms and Conditions for Electronic Documents at www.sgs.com/terms_e-document.htm. Attention is drawn to the limitation of liability, indemnification and jurisdiction issues defined therein. Any holder of this document is advised that information contained hereon reflects the Company's findings at the time of its intervention only and within the limits of Client's instructions, if any. The Company's sole responsibility is to its Client and this document does not exonerate parties to a transaction from exercising all their rights and obligations under the transaction documents. This document cannot be reproduced except in full, without prior written approval of the Company. Any unauthorized alteration, forgery or falsification of the content or appearance of this document is unlawful and offenders may be prosecuted to the fullest extent of the law.

SGS Taiwan Ltd.

No.134,WuKungRoad,NewTaipeiIndustrialPark,WukuDistrict,NewTaipeiCity,Taiwan24803/新北市五股區新北產業園區五工路 134 號

台灣檢驗科技股份有限公司

t (886-2) 2299-3279

f (886-2) 2298-0488

www.tw.sgs.com

Member of SGS Group

Operation Mode : LTE B26 15M QPSK RB 1.0
Fundamental Frequency : 841.5 MHz
Operation Band : Tx CH High
EUT Pol. : H

Test Date : 2017/3/15
Temp. / Humi. : 19.0deg_C/52RH
Test Engineer : Ashton
Measurement Antenna Pol. : Vertical

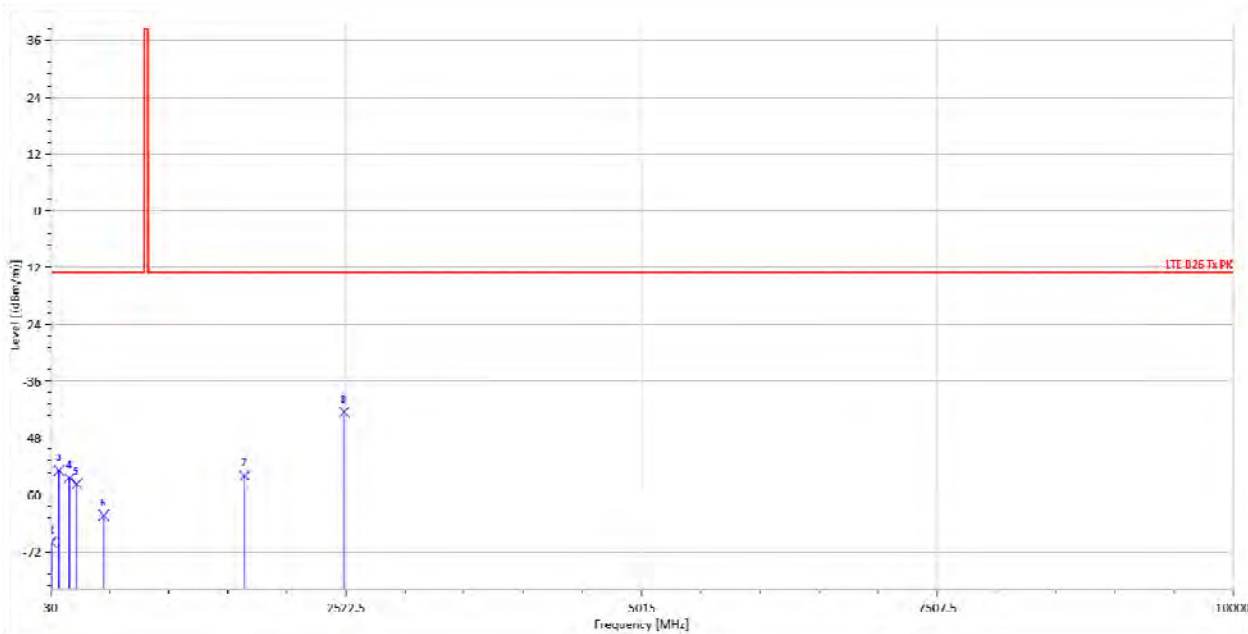

| Freq. MHz | Note F/H/E/S | ERP dBm | SG Output Level dBm | Antenna Gain dBd | Cable Loss dB | Limit @3m dBm/m | Margin dB |
|--------------|-----------------|------------|---------------------------|------------------------|---------------------|-----------------------|--------------|
| 31.94 | S | -69.90 | -48.52 | -20.71 | -0.67 | -13 | -56.90 |
| 39.70 | S | -70.05 | -55.07 | -14.24 | -0.73 | -13 | -57.05 |
| 100.81 | S | -54.83 | -50.59 | -3.07 | -1.17 | -13 | -41.83 |
| 188.11 | S | -56.40 | -58.78 | 3.95 | -1.56 | -13 | -43.40 |
| 250.19 | S | -57.71 | -58.90 | 3.11 | -1.92 | -13 | -44.71 |
| 478.14 | S | -64.36 | -65.95 | 4.19 | -2.59 | -13 | -51.36 |
| 1665.00 | H | -55.98 | -58.03 | 6.81 | -4.76 | -13 | -42.98 |
| 2505.00 | H | -42.53 | -44.90 | 8.26 | -5.89 | -13 | -29.53 |

Unless otherwise stated the results shown in this test report refer only to the sample(s) tested and such sample(s) are retained for 90 days only.

除非另有說明，此報告結果僅對測試之樣品負責，同時此樣品僅保留90天。本報告未經本公司書面許可，不可部份複製。

This document is issued by the Company subject to its General Conditions of Service printed overleaf, available on request or accessible at www.sgs.com/terms_and_conditions.htm and, for electronic format documents, subject to Terms and Conditions for Electronic Documents at www.sgs.com/terms_e-document.htm. Attention is drawn to the limitation of liability, indemnification and jurisdiction issues defined therein. Any holder of this document is advised that information contained hereon reflects the Company's findings at the time of its intervention only and within the limits of Client's instructions, if any. The Company's sole responsibility is to its Client and this document does not exonerate parties to a transaction from exercising all their rights and obligations under the transaction documents. This document cannot be reproduced except in full, without prior written approval of the Company. Any unauthorized alteration, forgery or falsification of the content or appearance of this document is unlawful and offenders may be prosecuted to the fullest extent of the law.

SGS Taiwan Ltd.

No.134,WuKungRoad,NewTaipeiIndustrialPark,WukuDistrict,NewTaipeiCity,Taiwan24803/新北市五股區新北產業園區五工路 134 號

台灣檢驗科技股份有限公司

t (886-2) 2299-3279

f (886-2) 2298-0488

www.tw.sgs.com

Member of SGS Group

Operation Mode : LTE B26 15M QPSK RB 1.0
Fundamental Frequency : 841.5 MHz
Operation Band : Tx CH High
EUT Pol. : H

Test Date : 2017/3/15
Temp. / Humi. : 19.0deg_C/52RH
Test Engineer : Ashton
Measurement Antenna Pol. : Horizontal

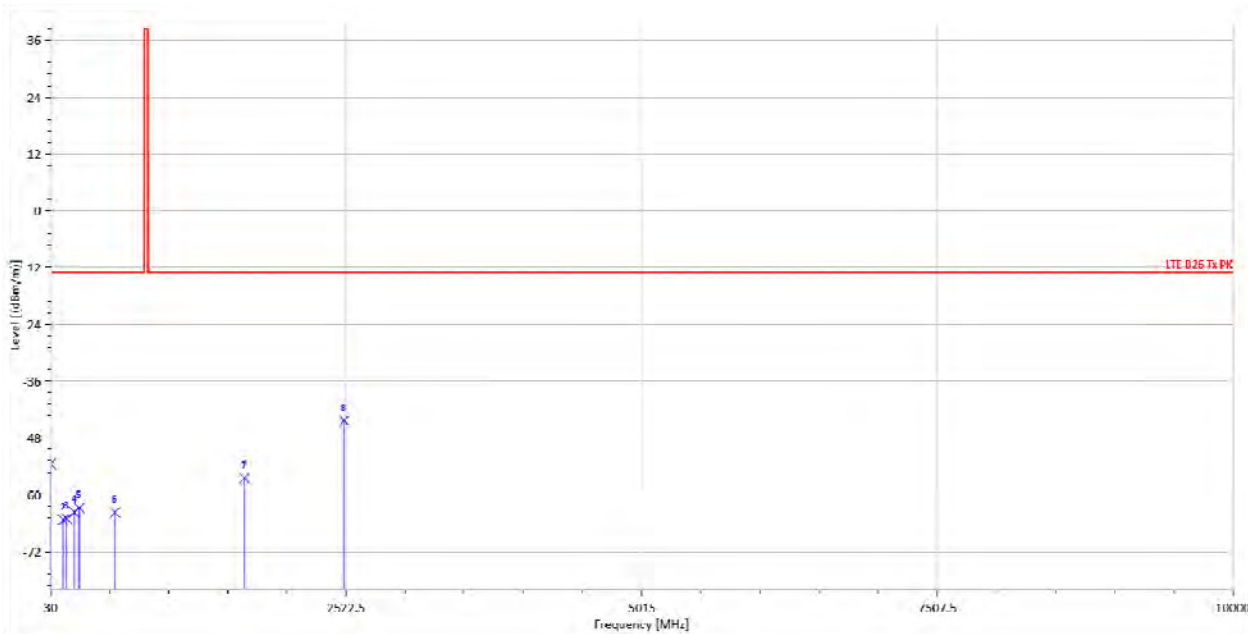

| Freq. MHz | Note F/H/E/S | ERP dBm | SG Output Level dBm | Antenna Gain dBd | Cable Loss dB | Limit @3m dBm/m | Margin dB |
|--------------|-----------------|------------|---------------------------|------------------------|---------------------|-----------------------|--------------|
| 30.97 | S | -53.47 | -31.26 | -21.56 | -0.65 | -13 | -40.47 |
| 134.76 | S | -65.27 | -62.22 | -1.67 | -1.38 | -13 | -52.27 |
| 163.86 | S | -64.99 | -65.29 | 1.88 | -1.58 | -13 | -51.99 |
| 229.82 | S | -63.68 | -65.98 | 4.10 | -1.80 | -13 | -50.68 |
| 271.53 | S | -62.78 | -64.21 | 3.34 | -1.91 | -13 | -49.78 |
| 573.20 | S | -63.72 | -65.18 | 4.48 | -3.02 | -13 | -50.72 |
| 1665.00 | H | -56.49 | -58.54 | 6.81 | -4.76 | -13 | -43.49 |
| 2505.00 | H | -44.28 | -46.65 | 8.26 | -5.89 | -13 | -31.28 |

Unless otherwise stated the results shown in this test report refer only to the sample(s) tested and such sample(s) are retained for 90 days only.

除非另有說明，此報告結果僅對測試之樣品負責，同時此樣品僅保留90天。本報告未經本公司書面許可，不可部份複製。

This document is issued by the Company subject to its General Conditions of Service printed overleaf, available on request or accessible at www.sgs.com/terms_and_conditions.htm and, for electronic format documents, subject to Terms and Conditions for Electronic Documents at www.sgs.com/terms_e-document.htm. Attention is drawn to the limitation of liability, indemnification and jurisdiction issues defined therein. Any holder of this document is advised that information contained hereon reflects the Company's findings at the time of its intervention only and within the limits of Client's instructions, if any. The Company's sole responsibility is to its Client and this document does not exonerate parties to a transaction from exercising all their rights and obligations under the transaction documents. This document cannot be reproduced except in full, without prior written approval of the Company. Any unauthorized alteration, forgery or falsification of the content or appearance of this document is unlawful and offenders may be prosecuted to the fullest extent of the law.

SGS Taiwan Ltd.

No.134,WuKungRoad,NewTaipeiIndustrialPark,WukuDistrict,NewTaipeiCity,Taiwan24803/新北市五股區新北產業園區五工路 134 號

台灣檢驗科技股份有限公司

t (886-2) 2299-3279

f (886-2) 2298-0488

www.tw.sgs.com

Member of SGS Group

Radiated Spurious Emission Measurement Result: LTE-Band 41The Worst Case)

| | | | |
|-------------------------|-------------------------|----------------------------|----------------|
| Operation Mode : | LTE B41 10M QPSK RB 1.0 | Test Date : | 2017/3/16 |
| Fundamental Frequency : | 2501 MHz | Temp. / Humi. : | 22.7deg_C/57RH |
| Operation Band : | Tx CH Low | Test Engineer : | Ashton |
| EUT Pol. : | E2 | Measurement Antenna Pol. : | Vertical |

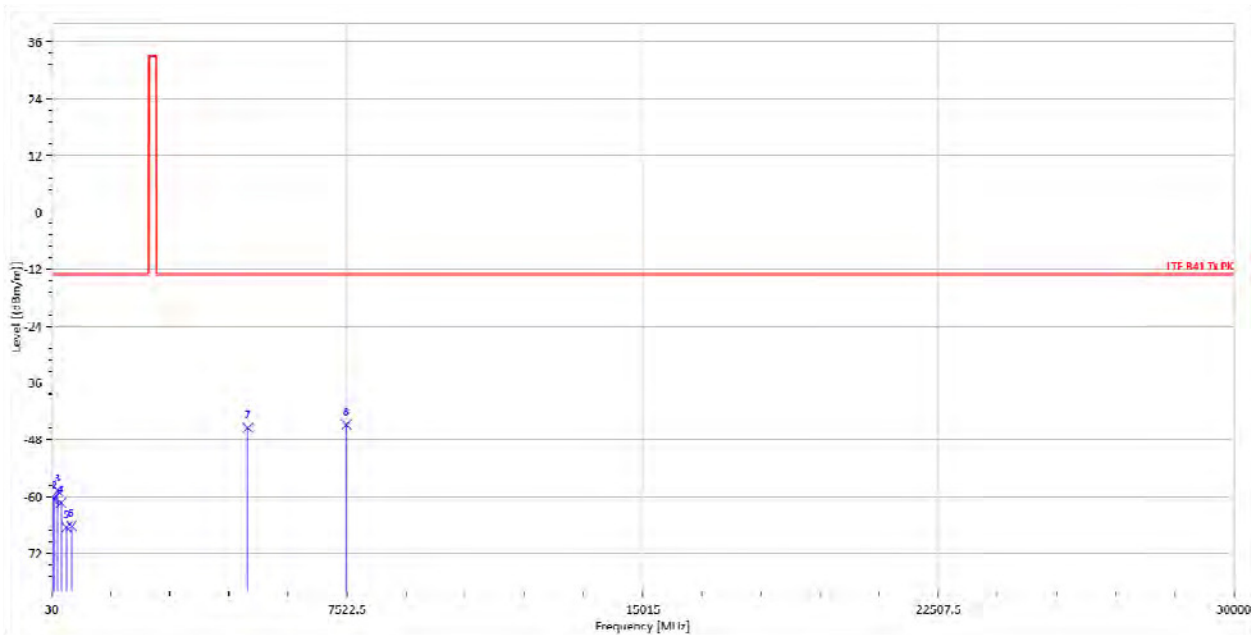

| Freq. MHz | Note F/H/E/S | EIRP dBm | SG Output Level dBm | Antenna Gain dBi | Cable Loss dB | Limit @3m dBm/m | Margin dB |
|--------------|-----------------|-------------|---------------------------|------------------------|---------------------|-----------------------|--------------|
| 60.07 | S | -60.50 | -58.70 | -0.92 | -0.89 | -13 | -47.50 |
| 100.81 | S | -60.32 | -58.22 | -0.92 | -1.17 | -13 | -47.32 |
| 186.17 | S | -58.82 | -63.24 | 6.01 | -1.59 | -13 | -45.82 |
| 272.50 | S | -61.33 | -64.93 | 5.52 | -1.92 | -13 | -48.33 |
| 409.27 | S | -66.52 | -69.90 | 5.85 | -2.47 | -13 | -53.52 |
| 535.37 | S | -66.27 | -70.19 | 6.41 | -2.49 | -13 | -53.27 |
| 5002.00 | H | -45.50 | -49.51 | 12.36 | -8.36 | -13 | -32.50 |
| 7503.00 | H | -44.84 | -45.02 | 10.67 | -10.50 | -13 | -31.84 |

Unless otherwise stated the results shown in this test report refer only to the sample(s) tested and such sample(s) are retained for 90 days only.

除非另有說明，此報告結果僅對測試之樣品負責，同時此樣品僅保留90天。本報告未經本公司書面許可，不可部份複製。

This document is issued by the Company subject to its General Conditions of Service printed overleaf, available on request or accessible at www.sgs.com/terms_and_conditions.htm and, for electronic format documents, subject to Terms and Conditions for Electronic Documents at www.sgs.com/terms_e-document.htm. Attention is drawn to the limitation of liability, indemnification and jurisdiction issues defined therein. Any holder of this document is advised that information contained hereon reflects the Company's findings at the time of its intervention only and within the limits of Client's instructions, if any. The Company's sole responsibility is to its Client and this document does not exonerate parties to a transaction from exercising all their rights and obligations under the transaction documents. This document cannot be reproduced except in full, without prior written approval of the Company. Any unauthorized alteration, forgery or falsification of the content or appearance of this document is unlawful and offenders may be prosecuted to the fullest extent of the law.

SGS Taiwan Ltd.

No.134,WuKungRoad,NewTaipeiIndustrialPark,WukuDistrict,NewTaipeiCity,Taiwan24803/新北市五股區新北產業園區五工路 134 號

台灣檢驗科技股份有限公司

t (886-2) 2299-3279

f (886-2) 2298-0488

www.tw.sgs.com

Member of SGS Group

| | | | |
|-------------------------|-------------------------|----------------------------|----------------|
| Operation Mode : | LTE B41 10M QPSK RB 1.0 | Test Date : | 2017/3/16 |
| Fundamental Frequency : | 2501 MHz | Temp. / Humi. : | 22.7deg_C/57RH |
| Operation Band : | Tx CH Low | Test Engineer : | Ashton |
| EUT Pol. : | E2 | Measurement Antenna Pol. : | Horizontal |

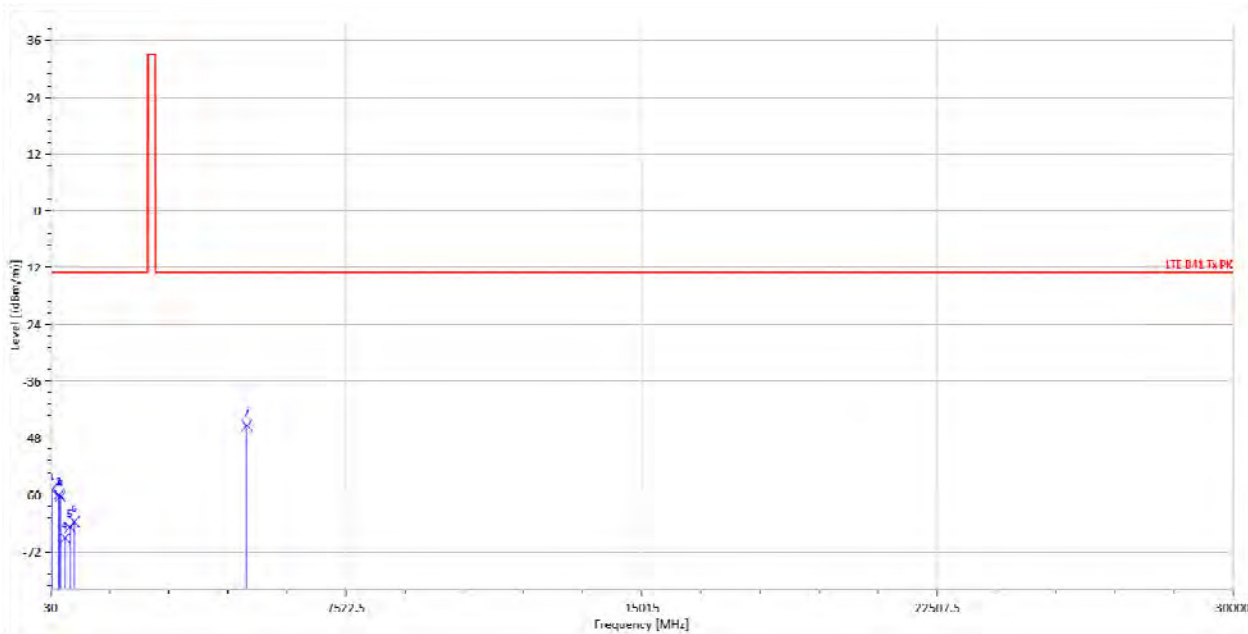

| Freq. MHz | Note F/H/E/S | EIRP dBm | SG Output Level dBm | Antenna Gain dBi | Cable Loss dB | Limit @3m dBm/m | Margin dB |
|--------------|-----------------|-------------|---------------------------|------------------------|---------------------|-----------------------|--------------|
| 59.10 | S | -58.91 | -56.76 | -1.29 | -0.87 | -13 | -45.91 |
| 245.34 | S | -59.95 | -63.61 | 5.48 | -1.82 | -13 | -46.95 |
| 276.38 | S | -60.38 | -64.07 | 5.64 | -1.95 | -13 | -47.38 |
| 398.60 | S | -69.12 | -72.44 | 5.76 | -2.43 | -13 | -56.12 |
| 522.76 | S | -66.86 | -70.46 | 6.40 | -2.80 | -13 | -53.86 |
| 630.43 | S | -65.71 | -69.96 | 6.99 | -2.74 | -13 | -52.71 |
| 5002.00 | H | -45.40 | -49.40 | 12.36 | -8.36 | -13 | -32.40 |

Unless otherwise stated the results shown in this test report refer only to the sample(s) tested and such sample(s) are retained for 90 days only.

除非另有說明，此報告結果僅對測試之樣品負責，同時此樣品僅保留90天。本報告未經本公司書面許可，不可部份複製。

This document is issued by the Company subject to its General Conditions of Service printed overleaf, available on request or accessible at www.sgs.com/terms_and_conditions.htm and, for electronic format documents, subject to Terms and Conditions for Electronic Documents at www.sgs.com/terms_e-document.htm. Attention is drawn to the limitation of liability, indemnification and jurisdiction issues defined therein. Any holder of this document is advised that information contained hereon reflects the Company's findings at the time of its intervention only and within the limits of Client's instructions, if any. The Company's sole responsibility is to its Client and this document does not exonerate parties to a transaction from exercising all their rights and obligations under the transaction documents. This document cannot be reproduced except in full, without prior written approval of the Company. Any unauthorized alteration, forgery or falsification of the content or appearance of this document is unlawful and offenders may be prosecuted to the fullest extent of the law.

SGS Taiwan Ltd.

No.134,WuKungRoad,NewTaipeiIndustrialPark,WukuDistrict,NewTaipeiCity,Taiwan24803/新北市五股區新北產業園區五工路 134 號

台灣檢驗科技股份有限公司

t (886-2) 2299-3279

f (886-2) 2298-0488

www.tw.sgs.com

Member of SGS Group

| | | | |
|-------------------------|-------------------------|----------------------------|----------------|
| Operation Mode : | LTE B41 10M QPSK RB 1.0 | Test Date : | 2017/3/16 |
| Fundamental Frequency : | 2593 MHz | Temp. / Humi. : | 22.7deg_C/57RH |
| Operation Band : | Tx CH Mid | Test Engineer : | Ashton |
| EUT Pol. : | E2 | Measurement Antenna Pol. : | Vertical |

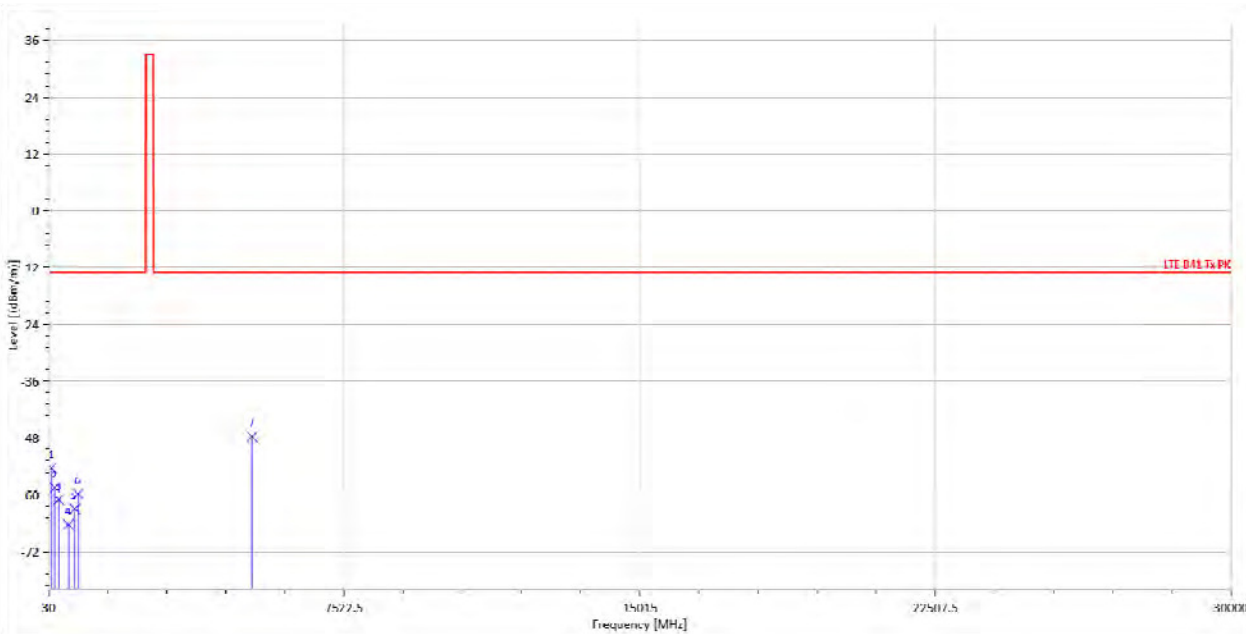

| Freq. MHz | Note F/H/E/S | EIRP dBm | SG Output Level dBm | Antenna Gain dBi | Cable Loss dB | Limit @3m dBm/m | Margin dB |
|--------------|-----------------|-------------|---------------------------|------------------------|---------------------|-----------------------|--------------|
| 100.81 | S | -54.35 | -52.26 | -0.92 | -1.17 | -13 | -41.35 |
| 189.08 | S | -58.49 | -63.04 | 6.14 | -1.59 | -13 | -45.49 |
| 285.11 | S | -60.99 | -64.83 | 5.81 | -1.96 | -13 | -47.99 |
| 534.40 | S | -66.27 | -70.11 | 6.41 | -2.57 | -13 | -53.27 |
| 692.51 | S | -62.96 | -67.56 | 7.53 | -2.92 | -13 | -49.96 |
| 776.90 | S | -59.79 | -64.32 | 7.64 | -3.12 | -13 | -46.79 |
| 5186.00 | H | -47.74 | -51.70 | 12.42 | -8.46 | -13 | -34.74 |

Unless otherwise stated the results shown in this test report refer only to the sample(s) tested and such sample(s) are retained for 90 days only.

除非另有說明，此報告結果僅對測試之樣品負責，同時此樣品僅保留90天。本報告未經本公司書面許可，不可部份複製。

This document is issued by the Company subject to its General Conditions of Service printed overleaf, available on request or accessible at www.sgs.com/terms_and_conditions.htm and, for electronic format documents, subject to Terms and Conditions for Electronic Documents at www.sgs.com/terms_e-document.htm. Attention is drawn to the limitation of liability, indemnification and jurisdiction issues defined therein. Any holder of this document is advised that information contained hereon reflects the Company's findings at the time of its intervention only and within the limits of Client's instructions, if any. The Company's sole responsibility is to its Client and this document does not exonerate parties to a transaction from exercising all their rights and obligations under the transaction documents. This document cannot be reproduced except in full, without prior written approval of the Company. Any unauthorized alteration, forgery or falsification of the content or appearance of this document is unlawful and offenders may be prosecuted to the fullest extent of the law.

SGS Taiwan Ltd.

No.134,WuKungRoad,NewTaipeiIndustrialPark,WukuDistrict,NewTaipeiCity,Taiwan24803/新北市五股區新北產業園區五工路 134 號

台灣檢驗科技股份有限公司

t (886-2) 2299-3279

f (886-2) 2298-0488

www.tw.sgs.com

Member of SGS Group

| | | | |
|-------------------------|-------------------------|----------------------------|----------------|
| Operation Mode : | LTE B41 10M QPSK RB 1.0 | Test Date : | 2017/3/16 |
| Fundamental Frequency : | 2593 MHz | Temp. / Humi. : | 22.7deg_C/57RH |
| Operation Band : | Tx CH Mid | Test Engineer : | Ashton |
| EUT Pol. : | E2 | Measurement Antenna Pol. : | Horizontal |

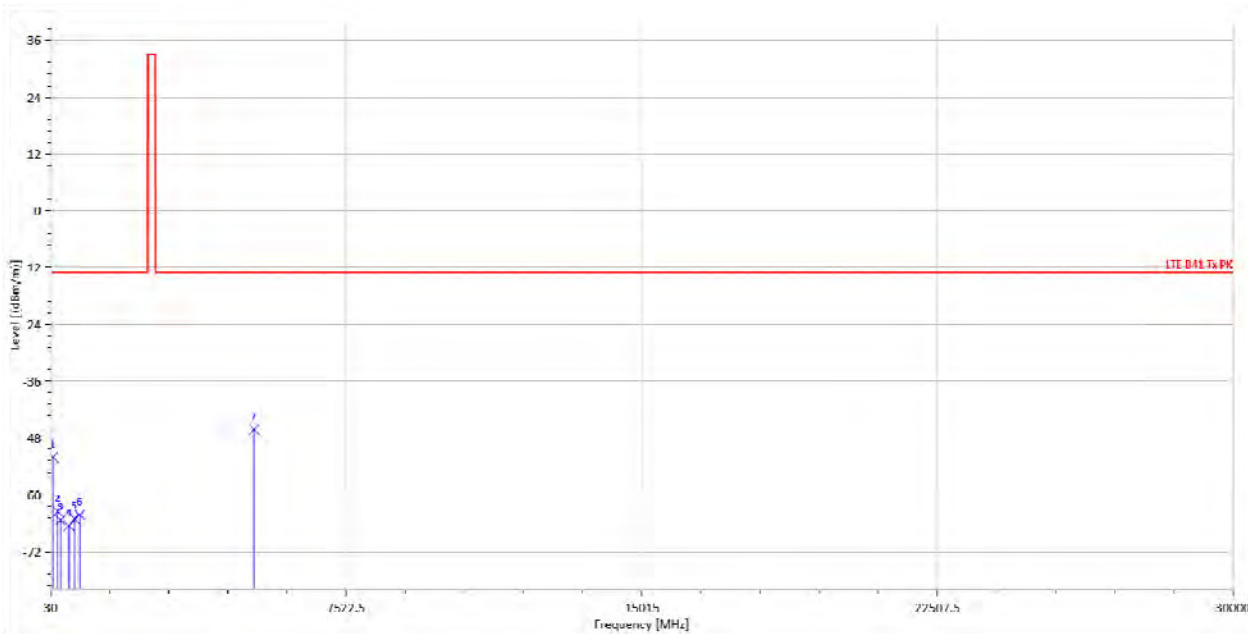

| Freq. MHz | Note F/H/E/S | EIRP dBm | SG Output Level dBm | Antenna Gain dBi | Cable Loss dB | Limit @3m dBm/m | Margin dB |
|--------------|-----------------|-------------|---------------------------|------------------------|---------------------|-----------------------|--------------|
| 91.11 | S | -52.02 | -50.80 | -0.10 | -1.12 | -13 | -39.02 |
| 211.39 | S | -63.52 | -67.94 | 6.12 | -1.71 | -13 | -50.52 |
| 278.32 | S | -65.35 | -69.08 | 5.70 | -1.98 | -13 | -52.35 |
| 494.63 | S | -66.53 | -70.42 | 6.38 | -2.49 | -13 | -53.53 |
| 638.19 | S | -65.02 | -69.02 | 7.02 | -3.02 | -13 | -52.02 |
| 767.20 | S | -64.24 | -68.68 | 7.63 | -3.20 | -13 | -51.24 |
| 5186.00 | H | -46.18 | -50.13 | 12.42 | -8.46 | -13 | -33.18 |

Unless otherwise stated the results shown in this test report refer only to the sample(s) tested and such sample(s) are retained for 90 days only.

除非另有說明，此報告結果僅對測試之樣品負責，同時此樣品僅保留90天。本報告未經本公司書面許可，不可部份複製。

This document is issued by the Company subject to its General Conditions of Service printed overleaf, available on request or accessible at www.sgs.com/terms_and_conditions.htm and, for electronic format documents, subject to Terms and Conditions for Electronic Documents at www.sgs.com/terms_e-document.htm. Attention is drawn to the limitation of liability, indemnification and jurisdiction issues defined therein. Any holder of this document is advised that information contained hereon reflects the Company's findings at the time of its intervention only and within the limits of Client's instructions, if any. The Company's sole responsibility is to its Client and this document does not exonerate parties to a transaction from exercising all their rights and obligations under the transaction documents. This document cannot be reproduced except in full, without prior written approval of the Company. Any unauthorized alteration, forgery or falsification of the content or appearance of this document is unlawful and offenders may be prosecuted to the fullest extent of the law.

SGS Taiwan Ltd.

No.134,WuKungRoad,NewTaipeiIndustrialPark,WukuDistrict,NewTaipeiCity,Taiwan24803/新北市五股區新北產業園區五工路 134 號

台灣檢驗科技股份有限公司

t (886-2) 2299-3279

f (886-2) 2298-0488

www.tw.sgs.com

Member of SGS Group

Operation Mode : LTE B41 10M QPSK RB 1.0
Fundamental Frequency : 2685 MHz
Operation Band : Tx CH High
EUT Pol. : E2

Test Date : 2017/3/16
Temp. / Humi. : 22.7deg_C/57RH
Test Engineer : Ashton
Measurement Antenna Pol. : Vertical

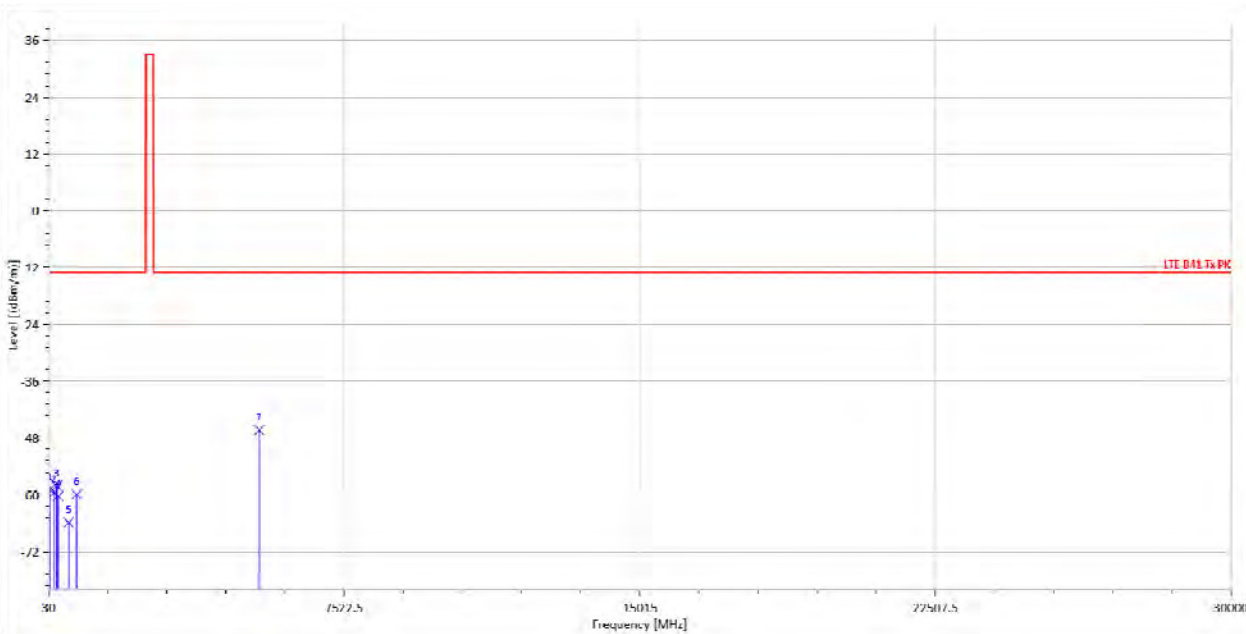

| Freq. MHz | Note F/H/E/S | EIRP dBm | SG Output Level dBm | Antenna Gain dBi | Cable Loss dB | Limit @3m dBm/m | Margin dB |
|--------------|-----------------|-------------|---------------------------|------------------------|---------------------|-----------------------|--------------|
| 60.07 | S | -58.92 | -57.12 | -0.92 | -0.89 | -13 | -45.92 |
| 177.44 | S | -59.39 | -63.34 | 5.46 | -1.51 | -13 | -46.39 |
| 240.49 | S | -58.15 | -62.00 | 5.69 | -1.85 | -13 | -45.15 |
| 274.44 | S | -60.27 | -63.94 | 5.58 | -1.91 | -13 | -47.27 |
| 539.25 | S | -65.85 | -69.70 | 6.41 | -2.56 | -13 | -52.85 |
| 739.07 | S | -59.94 | -64.17 | 7.61 | -3.38 | -13 | -46.94 |
| 5370.00 | H | -46.30 | -50.20 | 12.47 | -8.58 | -13 | -33.30 |

Unless otherwise stated the results shown in this test report refer only to the sample(s) tested and such sample(s) are retained for 90 days only.

除非另有說明，此報告結果僅對測試之樣品負責，同時此樣品僅保留90天。本報告未經本公司書面許可，不可部份複製。

This document is issued by the Company subject to its General Conditions of Service printed overleaf, available on request or accessible at www.sgs.com/terms_and_conditions.htm and, for electronic format documents, subject to Terms and Conditions for Electronic Documents at www.sgs.com/terms_e-document.htm. Attention is drawn to the limitation of liability, indemnification and jurisdiction issues defined therein. Any holder of this document is advised that information contained hereon reflects the Company's findings at the time of its intervention only and within the limits of Client's instructions, if any. The Company's sole responsibility is to its Client and this document does not exonerate parties to a transaction from exercising all their rights and obligations under the transaction documents. This document cannot be reproduced except in full, without prior written approval of the Company. Any unauthorized alteration, forgery or falsification of the content or appearance of this document is unlawful and offenders may be prosecuted to the fullest extent of the law.

SGS Taiwan Ltd.

No.134,WuKungRoad,NewTaipeiIndustrialPark,WukuDistrict,NewTaipeiCity,Taiwan24803/新北市五股區新北產業園區五工路 134 號

台灣檢驗科技股份有限公司

t (886-2) 2299-3279

f (886-2) 2298-0488

www.tw.sgs.com

Member of SGS Group

| | | | |
|-------------------------|-------------------------|----------------------------|----------------|
| Operation Mode : | LTE B41 10M QPSK RB 1.0 | Test Date : | 2017/3/16 |
| Fundamental Frequency : | 2685 MHz | Temp. / Humi. : | 22.7deg_C/57RH |
| Operation Band : | Tx CH High | Test Engineer : | Ashton |
| EUT Pol. : | E2 | Measurement Antenna Pol. : | Horizontal |

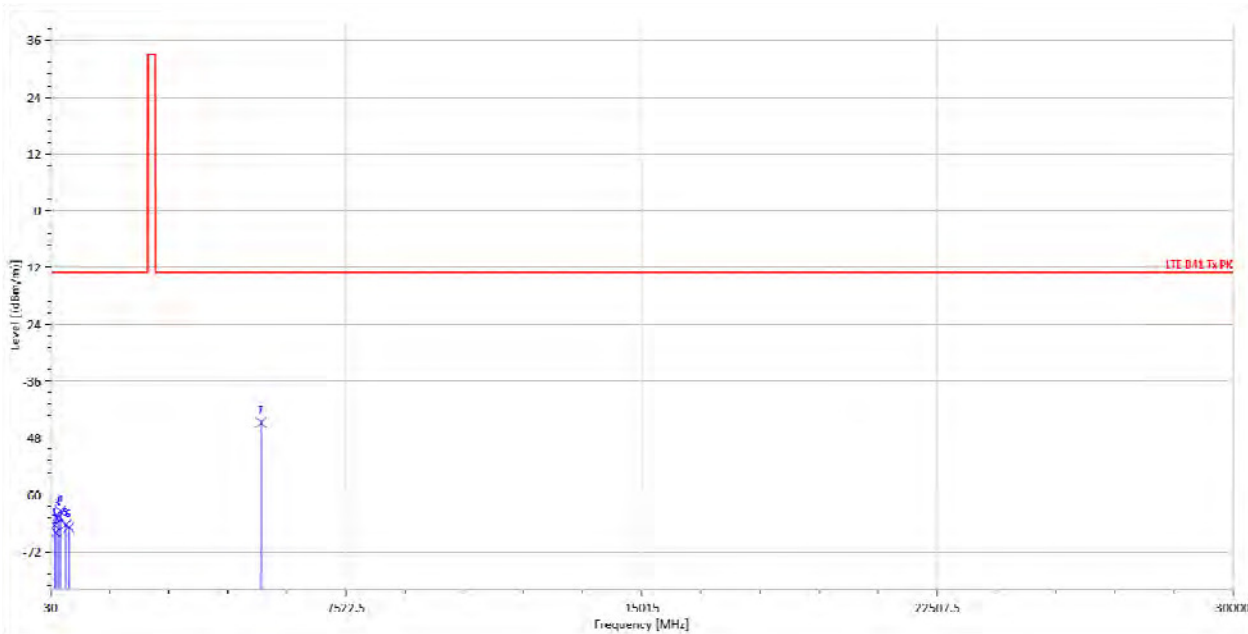

| Freq. MHz | Note F/H/E/S | EIRP dBm | SG Output Level dBm | Antenna Gain dBi | Cable Loss dB | Limit @3m dBm/m | Margin dB |
|--------------|-----------------|-------------|---------------------------|------------------------|---------------------|-----------------------|--------------|
| 133.79 | S | -66.36 | -65.40 | 0.36 | -1.32 | -13 | -53.36 |
| 165.80 | S | -67.97 | -70.68 | 4.25 | -1.54 | -13 | -54.97 |
| 224.00 | S | -64.45 | -69.14 | 6.43 | -1.75 | -13 | -51.45 |
| 277.35 | S | -63.45 | -67.14 | 5.67 | -1.98 | -13 | -50.45 |
| 416.06 | S | -66.32 | -69.84 | 5.92 | -2.40 | -13 | -53.32 |
| 492.69 | S | -66.84 | -70.72 | 6.37 | -2.49 | -13 | -53.84 |
| 5370.00 | H | -44.74 | -48.64 | 12.47 | -8.58 | -13 | -31.74 |

Unless otherwise stated the results shown in this test report refer only to the sample(s) tested and such sample(s) are retained for 90 days only.

除非另有說明，此報告結果僅對測試之樣品負責，同時此樣品僅保留90天。本報告未經本公司書面許可，不可部份複製。

This document is issued by the Company subject to its General Conditions of Service printed overleaf, available on request or accessible at www.sgs.com/terms_and_conditions.htm and, for electronic format documents, subject to Terms and Conditions for Electronic Documents at www.sgs.com/terms_e-document.htm. Attention is drawn to the limitation of liability, indemnification and jurisdiction issues defined therein. Any holder of this document is advised that information contained hereon reflects the Company's findings at the time of its intervention only and within the limits of Client's instructions, if any. The Company's sole responsibility is to its Client and this document does not exonerate parties to a transaction from exercising all their rights and obligations under the transaction documents. This document cannot be reproduced except in full, without prior written approval of the Company. Any unauthorized alteration, forgery or falsification of the content or appearance of this document is unlawful and offenders may be prosecuted to the fullest extent of the law.

SGS Taiwan Ltd.

No.134,WuKungRoad,NewTaipeiIndustrialPark,WukuDistrict,NewTaipeiCity,Taiwan24803/新北市五股區新北產業園區五工路 134 號

台灣檢驗科技股份有限公司

t (886-2) 2299-3279

f (886-2) 2298-0488

www.tw.sgs.com

Member of SGS Group

Radiated Spurious Emission Measurement Result: LTE-Band 26 for Part 90S (The Worst Case)

| | | | |
|-------------------------|------------------------|----------------------------|----------------|
| Operation Mode : | LTE B26 3M QPSK RB 1.0 | Test Date : | 2017/3/15 |
| Fundamental Frequency : | 815.5 MHz | Temp. / Humi. : | 19.0deg_C/52RH |
| Operation Band : | Tx CH Low | Test Engineer : | Ashton |
| EUT Pol. : | H | Measurement Antenna Pol. : | Vertical |

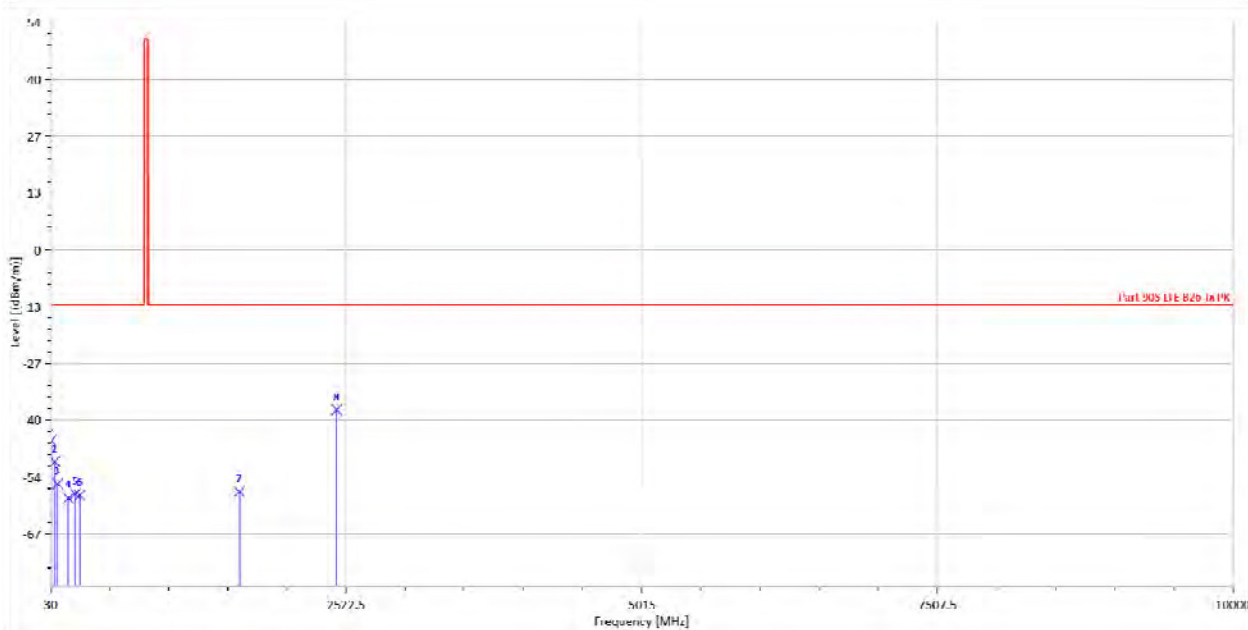

| Freq. MHz | Note F/H/E/S | ERP dBm | SG Output Level dBm | Antenna Gain dBd | Cable Loss dB | Limit @3m dBm/m | Margin dB |
|--------------|-----------------|------------|---------------------------|------------------------|---------------------|-----------------------|--------------|
| 34.85 | S | -45.34 | -26.44 | -18.19 | -0.71 | -13 | -32.34 |
| 65.89 | S | -50.34 | -47.11 | -2.29 | -0.94 | -13 | -37.34 |
| 88.20 | S | -55.57 | -52.44 | -2.03 | -1.10 | -13 | -42.57 |
| 180.35 | S | -59.01 | -61.02 | 3.58 | -1.58 | -13 | -46.01 |
| 237.58 | S | -58.01 | -59.86 | 3.69 | -1.84 | -13 | -45.01 |
| 275.41 | S | -58.30 | -59.83 | 3.46 | -1.92 | -13 | -45.30 |
| 1623.00 | H | -57.46 | -59.43 | 6.67 | -4.70 | -13 | -44.46 |
| 2442.00 | H | -38.00 | -40.40 | 8.22 | -5.81 | -13 | -25.00 |

Unless otherwise stated the results shown in this test report refer only to the sample(s) tested and such sample(s) are retained for 90 days only.

除非另有說明，此報告結果僅對測試之樣品負責，同時此樣品僅保留90天。本報告未經本公司書面許可，不可部份複製。

This document is issued by the Company subject to its General Conditions of Service printed overleaf, available on request or accessible at www.sgs.com/terms_and_conditions.htm and, for electronic format documents, subject to Terms and Conditions for Electronic Documents at www.sgs.com/terms_e-document.htm. Attention is drawn to the limitation of liability, indemnification and jurisdiction issues defined therein. Any holder of this document is advised that information contained hereon reflects the Company's findings at the time of its intervention only and within the limits of Client's instructions, if any. The Company's sole responsibility is to its Client and this document does not exonerate parties to a transaction from exercising all their rights and obligations under the transaction documents. This document cannot be reproduced except in full, without prior written approval of the Company. Any unauthorized alteration, forgery or falsification of the content or appearance of this document is unlawful and offenders may be prosecuted to the fullest extent of the law.

SGS Taiwan Ltd.

No.134,WuKungRoad,NewTaipeiIndustrialPark,WukuDistrict,NewTaipeiCity,Taiwan24803/新北市五股區新北產業園區五工路 134 號

台灣檢驗科技股份有限公司

t (886-2) 2299-3279

f (886-2) 2298-0488

www.tw.sgs.com

Member of SGS Group

| | | | |
|-------------------------|------------------------|----------------------------|----------------|
| Operation Mode : | LTE B26 3M QPSK RB 1.0 | Test Date : | 2017/3/15 |
| Fundamental Frequency : | 815.5 MHz | Temp. / Humi. : | 19.0deg_C/52RH |
| Operation Band : | Tx CH Low | Test Engineer : | Ashton |
| EUT Pol. : | H | Measurement Antenna Pol. : | Horizontal |

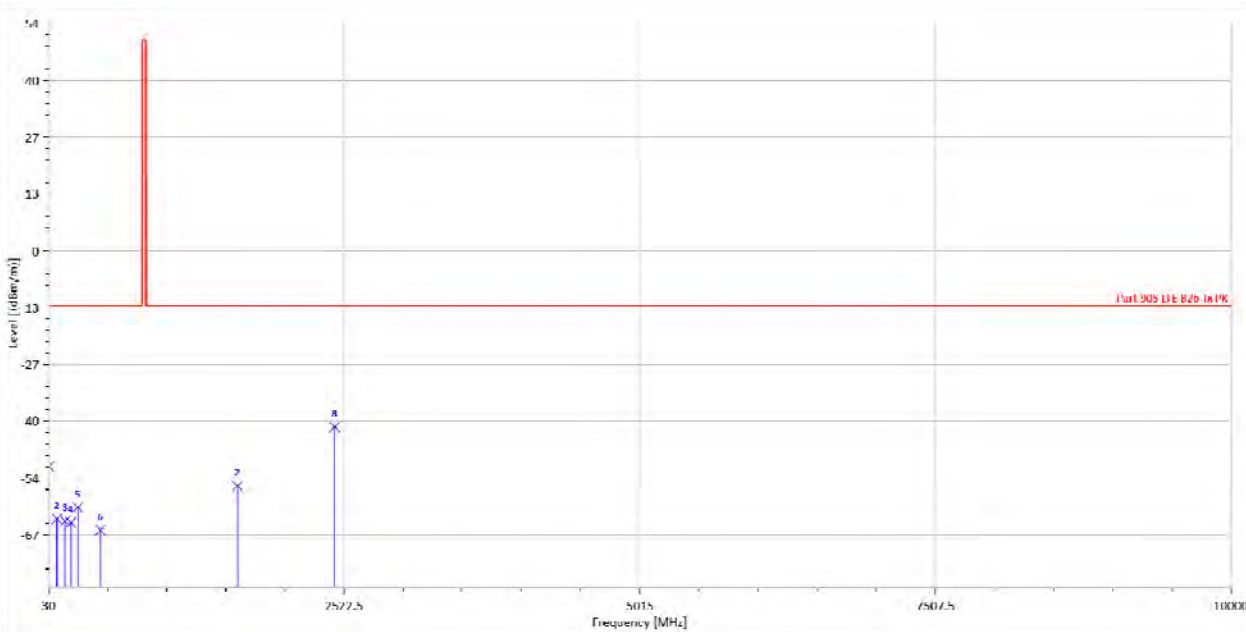

| Freq. MHz | Note F/H/E/S | ERP dBm | SG Output Level dBm | Antenna Gain dBd | Cable Loss dB | Limit @3m dBm/m | Margin dB |
|--------------|-----------------|------------|---------------------------|------------------------|---------------------|-----------------------|--------------|
| 32.91 | S | -51.22 | -30.68 | -19.87 | -0.67 | -13 | -38.22 |
| 100.81 | S | -63.70 | -59.46 | -3.07 | -1.17 | -13 | -50.70 |
| 169.68 | S | -64.18 | -65.32 | 2.53 | -1.40 | -13 | -51.18 |
| 219.15 | S | -64.57 | -67.20 | 4.37 | -1.74 | -13 | -51.57 |
| 276.38 | S | -60.96 | -62.50 | 3.49 | -1.95 | -13 | -47.96 |
| 466.50 | S | -66.38 | -68.07 | 4.16 | -2.48 | -13 | -53.38 |
| 1623.00 | H | -55.91 | -57.88 | 6.67 | -4.70 | -13 | -42.91 |
| 2442.00 | H | -41.84 | -44.25 | 8.22 | -5.81 | -13 | -28.84 |

Unless otherwise stated the results shown in this test report refer only to the sample(s) tested and such sample(s) are retained for 90 days only.

除非另有說明，此報告結果僅對測試之樣品負責，同時此樣品僅保留90天。本報告未經本公司書面許可，不可部份複製。

This document is issued by the Company subject to its General Conditions of Service printed overleaf, available on request or accessible at www.sgs.com/terms_and_conditions.htm and, for electronic format documents, subject to Terms and Conditions for Electronic Documents at www.sgs.com/terms_e-document.htm. Attention is drawn to the limitation of liability, indemnification and jurisdiction issues defined therein. Any holder of this document is advised that information contained hereon reflects the Company's findings at the time of its intervention only and within the limits of Client's instructions, if any. The Company's sole responsibility is to its Client and this document does not exonerate parties to a transaction from exercising all their rights and obligations under the transaction documents. This document cannot be reproduced except in full, without prior written approval of the Company. Any unauthorized alteration, forgery or falsification of the content or appearance of this document is unlawful and offenders may be prosecuted to the fullest extent of the law.

SGS Taiwan Ltd.

No.134,WuKungRoad,NewTaipeiIndustrialPark,WukuDistrict,NewTaipeiCity,Taiwan24803/新北市五股區新北產業園區五工路 134 號

台灣檢驗科技股份有限公司

t (886-2) 2299-3279

f (886-2) 2298-0488

www.tw.sgs.com

Member of SGS Group

| | | | |
|-------------------------|------------------------|----------------------------|----------------|
| Operation Mode : | LTE B26 3M QPSK RB 1.0 | Test Date : | 2017/3/15 |
| Fundamental Frequency : | 819 MHz | Temp. / Humi. : | 19.0deg_C/52RH |
| Operation Band : | Tx CH Mid | Test Engineer : | Ashton |
| EUT Pol. : | H | Measurement Antenna Pol. : | Vertical |

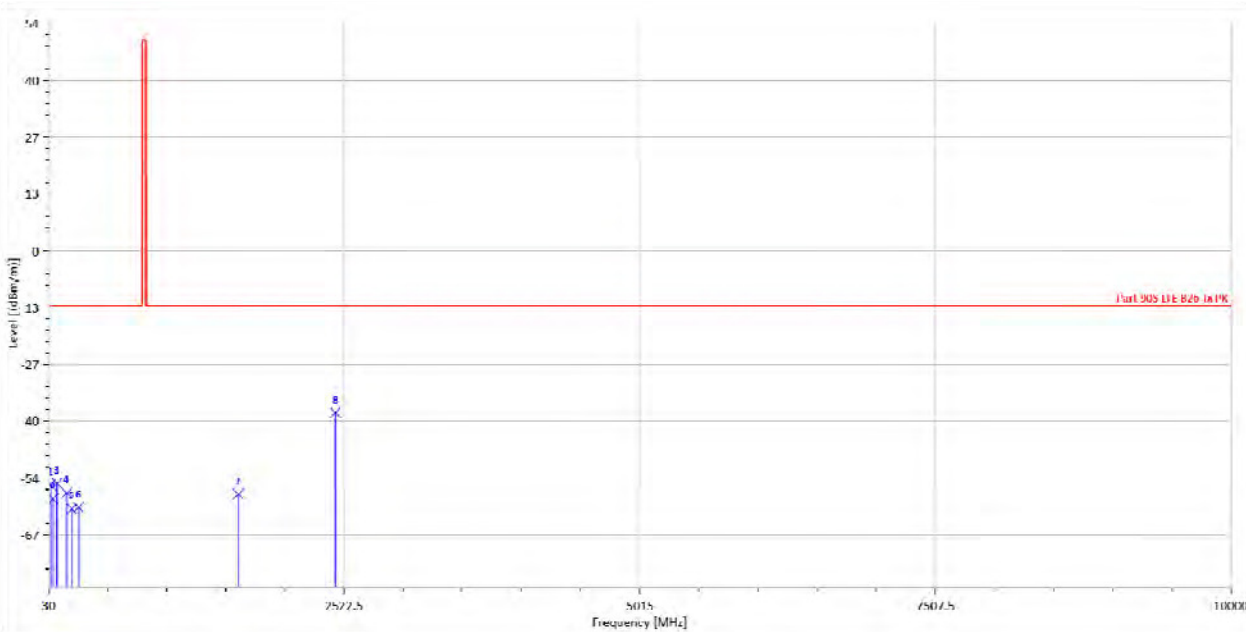

| Freq. MHz | Note F/H/E/S | ERP dBm | SG Output Level dBm | Antenna Gain dBd | Cable Loss dB | Limit @3m dBm/m | Margin dB |
|--------------|-----------------|------------|---------------------------|------------------------|---------------------|-----------------------|--------------|
| 48.43 | S | -55.55 | -46.70 | -8.04 | -0.81 | -13 | -42.55 |
| 68.80 | S | -58.91 | -56.07 | -1.90 | -0.94 | -13 | -45.91 |
| 100.81 | S | -55.28 | -51.04 | -3.07 | -1.17 | -13 | -42.28 |
| 183.26 | S | -57.55 | -59.66 | 3.72 | -1.60 | -13 | -44.55 |
| 225.94 | S | -61.28 | -63.79 | 4.22 | -1.72 | -13 | -48.28 |
| 283.17 | S | -60.98 | -62.66 | 3.64 | -1.96 | -13 | -47.98 |
| 1630.00 | H | -57.83 | -59.80 | 6.69 | -4.72 | -13 | -44.83 |
| 2449.00 | H | -38.42 | -40.82 | 8.22 | -5.82 | -13 | -25.42 |

Unless otherwise stated the results shown in this test report refer only to the sample(s) tested and such sample(s) are retained for 90 days only.

除非另有說明，此報告結果僅對測試之樣品負責，同時此樣品僅保留90天。本報告未經本公司書面許可，不可部份複製。

This document is issued by the Company subject to its General Conditions of Service printed overleaf, available on request or accessible at www.sgs.com/terms_and_conditions.htm and, for electronic format documents, subject to Terms and Conditions for Electronic Documents at www.sgs.com/terms_e-document.htm. Attention is drawn to the limitation of liability, indemnification and jurisdiction issues defined therein. Any holder of this document is advised that information contained hereon reflects the Company's findings at the time of its intervention only and within the limits of Client's instructions, if any. The Company's sole responsibility is to its Client and this document does not exonerate parties to a transaction from exercising all their rights and obligations under the transaction documents. This document cannot be reproduced except in full, without prior written approval of the Company. Any unauthorized alteration, forgery or falsification of the content or appearance of this document is unlawful and offenders may be prosecuted to the fullest extent of the law.

SGS Taiwan Ltd.

No.134,WuKungRoad,NewTaipeiIndustrialPark,WukuDistrict,NewTaipeiCity,Taiwan24803/新北市五股區新北產業園區五工路 134 號

台灣檢驗科技股份有限公司

t (886-2) 2299-3279

f (886-2) 2298-0488

www.tw.sgs.com

Member of SGS Group

| | | | |
|-------------------------|------------------------|----------------------------|----------------|
| Operation Mode : | LTE B26 3M QPSK RB 1.0 | Test Date : | 2017/3/15 |
| Fundamental Frequency : | 819 MHz | Temp. / Humi. : | 19.0deg_C/52RH |
| Operation Band : | Tx CH Mid | Test Engineer : | Ashton |
| EUT Pol. : | H | Measurement Antenna Pol. : | Horizontal |

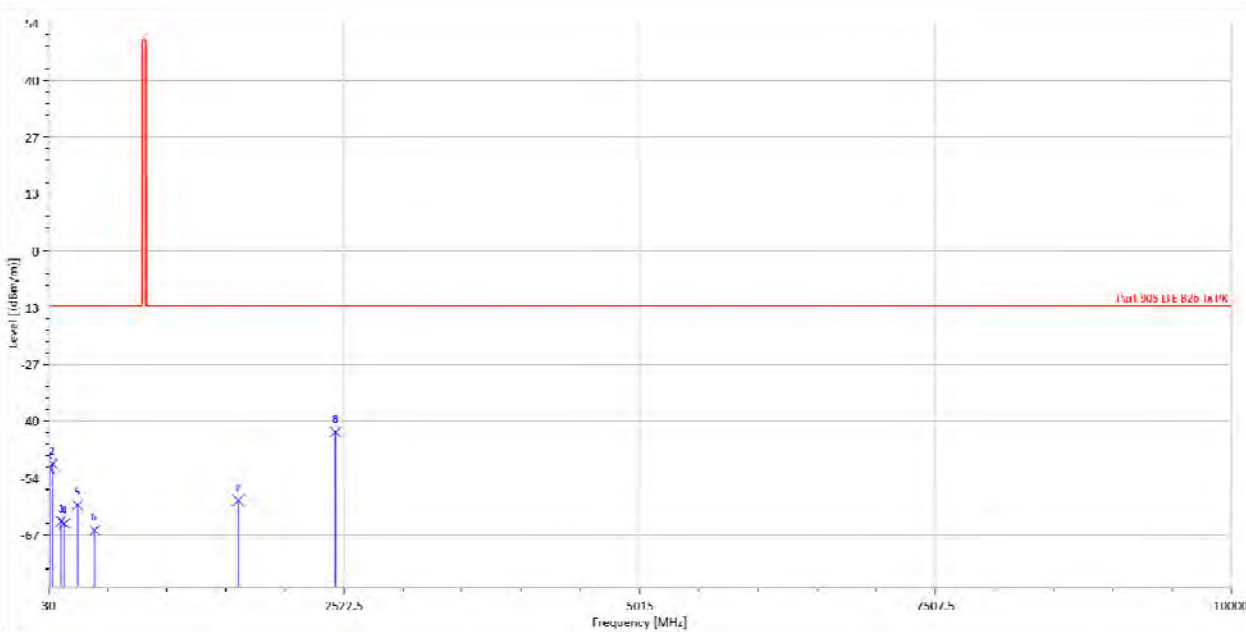

| Freq. MHz | Note F/H/E/S | ERP dBm | SG Output Level dBm | Antenna Gain dBd | Cable Loss dB | Limit @3m dBm/m | Margin dB |
|--------------|-----------------|------------|---------------------------|------------------------|---------------------|-----------------------|--------------|
| 37.76 | S | -51.62 | -35.11 | -15.82 | -0.70 | -13 | -38.62 |
| 62.98 | S | -50.56 | -46.90 | -2.68 | -0.98 | -13 | -37.56 |
| 133.79 | S | -64.25 | -61.14 | -1.79 | -1.32 | -13 | -51.25 |
| 162.89 | S | -64.78 | -64.95 | 1.77 | -1.60 | -13 | -51.78 |
| 274.44 | S | -60.45 | -61.96 | 3.43 | -1.91 | -13 | -47.45 |
| 418.97 | S | -66.42 | -67.76 | 3.80 | -2.45 | -13 | -53.42 |
| 1630.00 | H | -59.33 | -61.30 | 6.69 | -4.72 | -13 | -46.33 |
| 2449.00 | H | -43.04 | -45.44 | 8.22 | -5.82 | -13 | -30.04 |

Unless otherwise stated the results shown in this test report refer only to the sample(s) tested and such sample(s) are retained for 90 days only.

除非另有說明，此報告結果僅對測試之樣品負責，同時此樣品僅保留90天。本報告未經本公司書面許可，不可部份複製。

This document is issued by the Company subject to its General Conditions of Service printed overleaf, available on request or accessible at www.sgs.com/terms_and_conditions.htm and, for electronic format documents, subject to Terms and Conditions for Electronic Documents at www.sgs.com/terms_e-document.htm. Attention is drawn to the limitation of liability, indemnification and jurisdiction issues defined therein. Any holder of this document is advised that information contained hereon reflects the Company's findings at the time of its intervention only and within the limits of Client's instructions, if any. The Company's sole responsibility is to its Client and this document does not exonerate parties to a transaction from exercising all their rights and obligations under the transaction documents. This document cannot be reproduced except in full, without prior written approval of the Company. Any unauthorized alteration, forgery or falsification of the content or appearance of this document is unlawful and offenders may be prosecuted to the fullest extent of the law.

SGS Taiwan Ltd.

No.134,WuKungRoad,NewTaipeiIndustrialPark,WukuDistrict,NewTaipeiCity,Taiwan24803/新北市五股區新北產業園區五工路 134 號

台灣檢驗科技股份有限公司

t (886-2) 2299-3279

f (886-2) 2298-0488

www.tw.sgs.com

Member of SGS Group

Operation Mode : LTE B26 3M QPSK RB 1.0
Fundamental Frequency : 822.5 MHz
Operation Band : Tx CH High
EUT Pol. : H

Test Date : 2017/3/15
Temp. / Humi. : 19.0deg_C/52RH
Test Engineer : Ashton
Measurement Antenna Pol. : Vertical

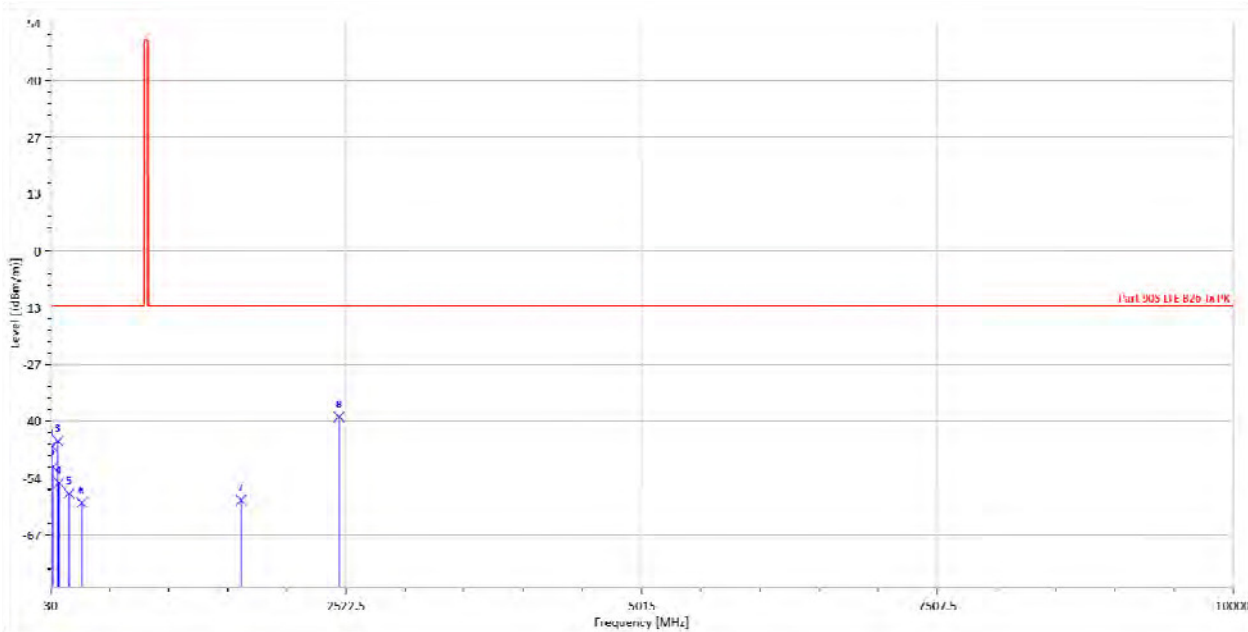

| Freq. MHz | Note F/H/E/S | ERP dBm | SG Output Level dBm | Antenna Gain dBd | Cable Loss dB | Limit @3m dBm/m | Margin dB |
|--------------|-----------------|------------|---------------------------|------------------------|---------------------|-----------------------|--------------|
| 38.73 | S | -46.34 | -30.61 | -15.03 | -0.70 | -13 | -33.34 |
| 51.34 | S | -51.32 | -43.96 | -6.53 | -0.83 | -13 | -38.32 |
| 92.08 | S | -45.25 | -41.78 | -2.34 | -1.13 | -13 | -32.25 |
| 100.81 | S | -55.14 | -50.90 | -3.07 | -1.17 | -13 | -42.14 |
| 185.20 | S | -57.66 | -59.83 | 3.81 | -1.64 | -13 | -44.66 |
| 292.87 | S | -59.86 | -61.62 | 3.74 | -1.97 | -13 | -46.86 |
| 1637.00 | H | -59.23 | -61.23 | 6.72 | -4.72 | -13 | -46.23 |
| 2463.00 | H | -39.44 | -41.83 | 8.23 | -5.84 | -13 | -26.44 |

Unless otherwise stated the results shown in this test report refer only to the sample(s) tested and such sample(s) are retained for 90 days only.

除非另有說明，此報告結果僅對測試之樣品負責，同時此樣品僅保留90天。本報告未經本公司書面許可，不可部份複製。

This document is issued by the Company subject to its General Conditions of Service printed overleaf, available on request or accessible at www.sgs.com/terms_and_conditions.htm and, for electronic format documents, subject to Terms and Conditions for Electronic Documents at www.sgs.com/terms_e-document.htm. Attention is drawn to the limitation of liability, indemnification and jurisdiction issues defined therein. Any holder of this document is advised that information contained hereon reflects the Company's findings at the time of its intervention only and within the limits of Client's instructions, if any. The Company's sole responsibility is to its Client and this document does not exonerate parties to a transaction from exercising all their rights and obligations under the transaction documents. This document cannot be reproduced except in full, without prior written approval of the Company. Any unauthorized alteration, forgery or falsification of the content or appearance of this document is unlawful and offenders may be prosecuted to the fullest extent of the law.

SGS Taiwan Ltd.

No.134,WuKungRoad,NewTaipeiIndustrialPark,WukuDistrict,NewTaipeiCity,Taiwan24803/新北市五股區新北產業園區五工路 134 號

台灣檢驗科技股份有限公司

t (886-2) 2299-3279

f (886-2) 2298-0488

www.tw.sgs.com

Member of SGS Group

| | | | |
|-------------------------|------------------------|----------------------------|----------------|
| Operation Mode : | LTE B26 3M QPSK RB 1.0 | Test Date : | 2017/3/15 |
| Fundamental Frequency : | 822.5 MHz | Temp. / Humi. : | 19.0deg_C/52RH |
| Operation Band : | Tx CH High | Test Engineer : | Ashton |
| EUT Pol. : | H | Measurement Antenna Pol. : | Horizontal |

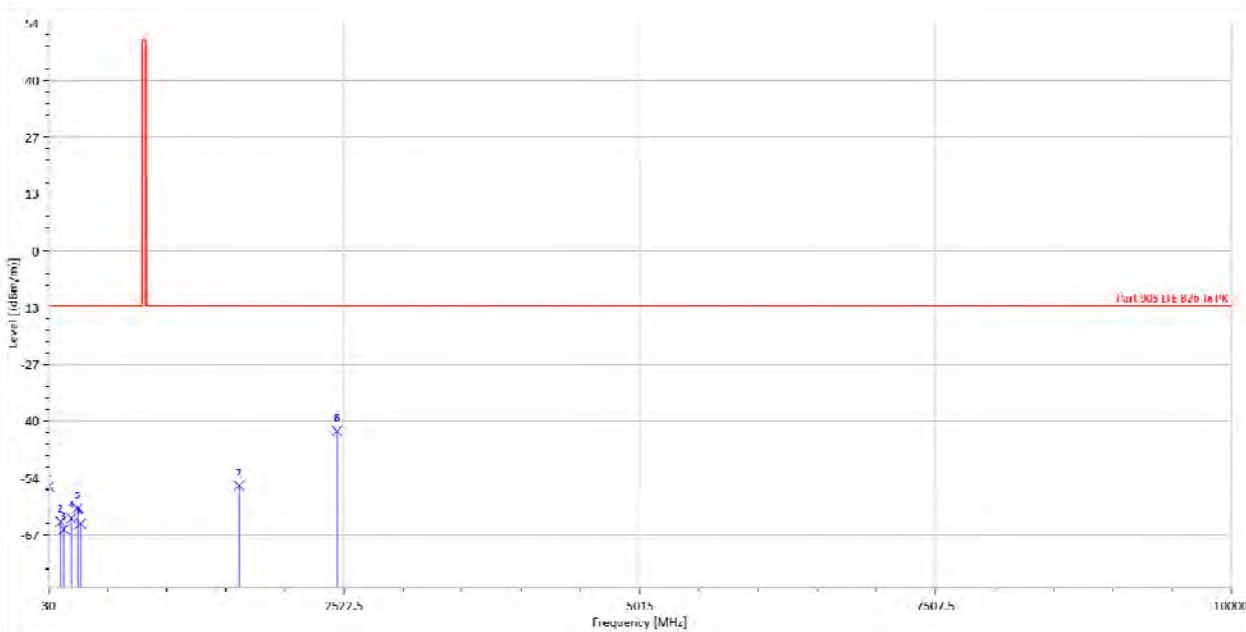

| Freq. MHz | Note F/H/E/S | ERP dBm | SG Output Level dBm | Antenna Gain dBd | Cable Loss dB | Limit @3m dBm/m | Margin dB |
|--------------|-----------------|------------|---------------------------|------------------------|---------------------|-----------------------|--------------|
| 32.91 | S | -55.96 | -35.42 | -19.87 | -0.67 | -13 | -42.96 |
| 130.88 | S | -64.35 | -60.88 | -2.15 | -1.32 | -13 | -51.35 |
| 159.01 | S | -66.16 | -66.04 | 1.34 | -1.45 | -13 | -53.16 |
| 222.06 | S | -63.55 | -66.15 | 4.34 | -1.75 | -13 | -50.55 |
| 275.41 | S | -61.13 | -62.67 | 3.46 | -1.92 | -13 | -48.13 |
| 298.69 | S | -64.83 | -66.61 | 3.79 | -2.01 | -13 | -51.83 |
| 1637.00 | H | -55.77 | -57.77 | 6.72 | -4.72 | -13 | -42.77 |
| 2463.00 | H | -42.78 | -45.18 | 8.23 | -5.84 | -13 | -29.78 |

Unless otherwise stated the results shown in this test report refer only to the sample(s) tested and such sample(s) are retained for 90 days only.

除非另有說明，此報告結果僅對測試之樣品負責，同時此樣品僅保留90天。本報告未經本公司書面許可，不可部份複製。

This document is issued by the Company subject to its General Conditions of Service printed overleaf, available on request or accessible at www.sgs.com/terms_and_conditions.htm and, for electronic format documents, subject to Terms and Conditions for Electronic Documents at www.sgs.com/terms_e-document.htm. Attention is drawn to the limitation of liability, indemnification and jurisdiction issues defined therein. Any holder of this document is advised that information contained hereon reflects the Company's findings at the time of its intervention only and within the limits of Client's instructions, if any. The Company's sole responsibility is to its Client and this document does not exonerate parties to a transaction from exercising all their rights and obligations under the transaction documents. This document cannot be reproduced except in full, without prior written approval of the Company. Any unauthorized alteration, forgery or falsification of the content or appearance of this document is unlawful and offenders may be prosecuted to the fullest extent of the law.

SGS Taiwan Ltd.

No.134,WuKungRoad,NewTaipeiIndustrialPark,WukuDistrict,NewTaipeiCity,Taiwan24803/新北市五股區新北產業園區五工路 134 號

台灣檢驗科技股份有限公司

t (886-2) 2299-3279

f (886-2) 2298-0488

www.tw.sgs.com

Member of SGS Group

11. FREQUENCY STABILITY MEASUREMENT

11.1. Standard Applicable:

The frequency stability shall be sufficient to ensure that the fundamental emission stays within the authorized frequency block.

11.2. Test Set-up:

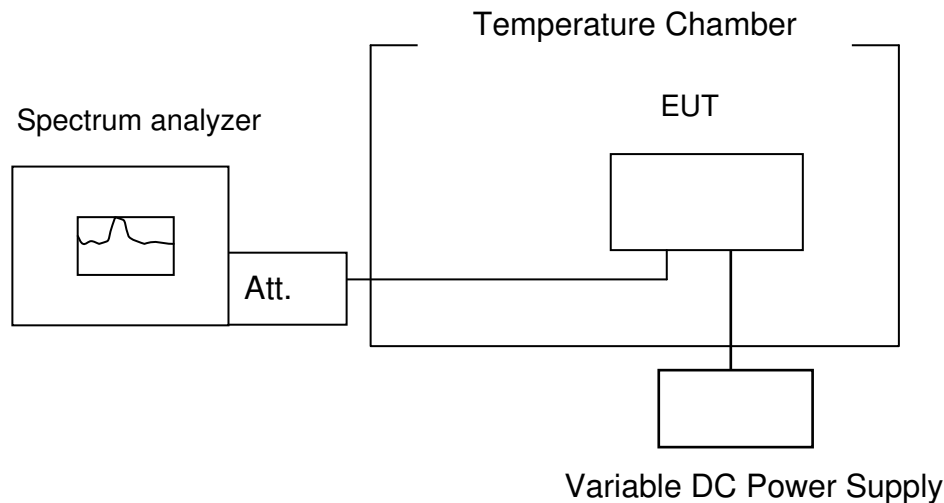

Note: Measurement setup for testing on Antenna connector

11.3. Measurement Procedure:

The equipment under test was connected to an external AC or DC power supply and input rated voltage. RF output was connected to a frequency counter or spectrum analyzer via feed through attenuators. The EUT was placed inside the temperature chamber. Set the spectrum analyzer RBW low enough to obtain the desired frequency resolution and measure EUT 25°C operating frequency as reference frequency. Turn EUT off and set the chamber temperature to -30°C. After the temperature stabilized for approximately 30 minutes recorded the frequency. Repeat step measure with 10°C increased per stage until the highest temperature of +50°C reached.

Set chamber temperature to 25°C. Use a variable AC power supply / DC power source to power the EUT and set the voltage to rated voltage. Set the spectrum analyzer RBW low enough to obtain the desired frequency resolution and recorded the frequency.

Reduce the input voltage to specify extreme voltage variation (+/- 15%) and endpoint as declared by the manufacturer, record the maximum frequency change.

Unless otherwise stated the results shown in this test report refer only to the sample(s) tested and such sample(s) are retained for 90 days only.

除非另有說明，此報告結果僅對測試之樣品負責，同時此樣品僅保留90天。本報告未經本公司書面許可，不可部份複製。

This document is issued by the Company subject to its General Conditions of Service printed overleaf, available on request or accessible at www.sgs.com/terms_and_conditions.htm and, for electronic format documents, subject to Terms and Conditions for Electronic Documents at www.sgs.com/terms_e-document.htm. Attention is drawn to the limitation of liability, indemnification and jurisdiction issues defined therein. Any holder of this document is advised that information contained hereon reflects the Company's findings at the time of its intervention only and within the limits of Client's instructions, if any. The Company's sole responsibility is to its Client and this document does not exonerate parties to a transaction from exercising all their rights and obligations under the transaction documents. This document cannot be reproduced except in full, without prior written approval of the Company. Any unauthorized alteration, forgery or falsification of the content or appearance of this document is unlawful and offenders may be prosecuted to the fullest extent of the law.

11.4. Measurement Equipment Used:

| Conducted Emission (measured at antenna port) Test Site | | | | | |
|---|-----------|--------------------|---------------|------------|------------|
| EQUIPMENT TYPE | MFR | MODEL NUMBER | SERIAL NUMBER | LAST CAL. | CAL DUE. |
| Spectrum Analyzer | KEYSIGHT | N9010A | MY54510568 | 04/14/2016 | 04/13/2017 |
| Communication Tester | Anritsu | MT8820C | 6201107337 | 05/25/2016 | 05/24/2017 |
| Coaxial Cable 30cm | WOKEN | 00100A1F1A 195C | RF01 | 12/12/2016 | 12/11/2017 |
| Temperature Chamber | TERCHY | MHK-120LK | 1020582 | 06/16/2016 | 06/15/2017 |
| DC Block | PASTERNAK | PE8210 | RF29 | 12/12/2016 | 12/11/2017 |
| Splitter | RF-LAMBAD | RFLT2W1G1 8G | RF35 | 12/12/2016 | 12/11/2017 |
| Attenuator | WOKEN | 218FS-10 | RF23 | 12/12/2016 | 12/11/2017 |
| DC Power Supply | Agilent | E3640A | MY53140006 | 05/04/2016 | 05/03/2017 |
| Communication Tester | Anritsu | MT8820C | 6201107337 | 05/25/2016 | 05/24/2017 |
| Spectrum Analyzer | KEYSIGHT | N9010A | MY54510568 | 04/14/2016 | 04/13/2017 |
| Communication Tester | Anritsu | MT8820C | 6201107337 | 05/25/2016 | 05/24/2017 |

Unless otherwise stated the results shown in this test report refer only to the sample(s) tested and such sample(s) are retained for 90 days only.

除非另有說明，此報告結果僅對測試之樣品負責，同時此樣品僅保留90天。本報告未經本公司書面許可，不可部份複製。

This document is issued by the Company subject to its General Conditions of Service printed overleaf, available on request or accessible at www.sgs.com/terms_and_conditions.htm and, for electronic format documents, subject to Terms and Conditions for Electronic Documents at www.sgs.com/terms_e-document.htm. Attention is drawn to the limitation of liability, indemnification and jurisdiction issues defined therein. Any holder of this document is advised that information contained hereon reflects the Company's findings at the time of its intervention only and within the limits of Client's instructions, if any. The Company's sole responsibility is to its Client and this document does not exonerate parties to a transaction from exercising all their rights and obligations under the transaction documents. This document cannot be reproduced except in full, without prior written approval of the Company. Any unauthorized alteration, forgery or falsification of the content or appearance of this document is unlawful and offenders may be prosecuted to the fullest extent of the law.

SGS Taiwan Ltd.

No. 134, WuKungRoad, NewTaipeiIndustrialPark, WukuDistrict, NewTaipeiCity, Taiwan24803/新北市五股區新北產業園區五工路 134 號

台灣檢驗科技股份有限公司

t (886-2) 2299-3279

f (886-2) 2298-0488

www.tw.sgs.com

Member of SGS Group

11.5. Measurement Result:

FREQUENCY ERROR vs. VOLTAGE

| Reference Frequency: | | LTE B2 Mid Channel | 1880.0 | MHz | 20M QPSK CH 18900 |
|----------------------|------------------|--------------------|------------|------------|----------------------|
| Limit: +/- 2.5 ppm | | | | | |
| Power Supply | Environment | Frequency | Delta (Hz) | Limit (Hz) | |
| Vdc | Temperature (°C) | (MHz) | | | |
| 4.2 | 25 | 1880 | -2.4 | 4700 | |
| 3.8 | 25 | 1880 | 0 | 4700 | |
| 3.6 | 25 | 1880 | -3.3 | 4700 | |
| 3.4 (End Point) | 25 | 1880 | -3.3 | 4700 | |

FREQUENCY ERROR vs. TEMPERATURE

| Reference Frequency: | | LTE B2 Mid Channel | 1880.0 | MHz | 20M QPSK CH 18900 |
|----------------------|------------------|--------------------|------------|------------|-------------------|
| Limit: +/- 2.5 ppm | | | | | |
| Power Supply | Environment | Frequency | Delta (Hz) | Limit (Hz) | |
| Vdc | Temperature (°C) | (MHz) | | | |
| 3.8 | -30 | 1880 | 1 | 4700 | |
| 3.8 | -20 | 1880 | 2.8 | 4700 | |
| 3.8 | -10 | 1880 | 0.6 | 4700 | |
| 3.8 | 0 | 1880 | 3.6 | 4700 | |
| 3.8 | 10 | 1880 | -0.4 | 4700 | |
| 3.8 | 20 | 1880 | 0 | 4700 | |
| 3.8 | 30 | 1880 | 4.3 | 4700 | |
| 3.8 | 40 | 1880 | -0.2 | 4700 | |
| 3.8 | 50 | 1880 | -1.5 | 4700 | |

Unless otherwise stated the results shown in this test report refer only to the sample(s) tested and such sample(s) are retained for 90 days only.

除非另有說明，此報告結果僅對測試之樣品負責，同時此樣品僅保留90天。本報告未經本公司書面許可，不可部份複製。

This document is issued by the Company subject to its General Conditions of Service printed overleaf, available on request or accessible at www.sgs.com/terms_and_conditions.htm and, for electronic format documents, subject to Terms and Conditions for Electronic Documents at www.sgs.com/terms_e-document.htm. Attention is drawn to the limitation of liability, indemnification and jurisdiction issues defined therein. Any holder of this document is advised that information contained hereon reflects the Company's findings at the time of its intervention only and within the limits of Client's instructions, if any. The Company's sole responsibility is to its Client and this document does not exonerate parties to a transaction from exercising all their rights and obligations under the transaction documents. This document cannot be reproduced except in full, without prior written approval of the Company. Any unauthorized alteration, forgery or falsification of the content or appearance of this document is unlawful and offenders may be prosecuted to the fullest extent of the law.

SGS Taiwan Ltd.

No.134,WuKungRoad,NewTaipeiIndustrialPark,WukuDistrict,NewTaipeiCity,Taiwan24803/新北市五股區新北產業園區五工路 134 號

台灣檢驗科技股份有限公司

t (886-2) 2299-3279

f (886-2) 2298-0488

www.tw.sgs.com

Member of SGS Group

FREQUENCY ERROR vs. VOLTAGE

| Reference Frequency: | | LTE B4 Mid Channel | 1732.5 | MHz | 20M QPSK CH 20175 |
|----------------------|------------------|--------------------|------------|------------|-------------------|
| Limit: +/- 2.5 ppm | | | | | |
| Power Supply | Environment | Frequency | Delta (Hz) | Limit (Hz) | |
| Vdc | Temperature (°C) | (MHz) | | | |
| 4.2 | 25 | 1732.5 | 0.8 | 4331 | |
| 3.8 | 25 | 1732.5 | 0 | 4331 | |
| 3.6 | 25 | 1732.5 | -0.1 | 4331 | |
| 3.4 (End Point) | 25 | 1732.5 | -0.1 | 4331 | |

FREQUENCY ERROR vs. TEMPERATURE

| Reference Frequency: | | LTE B4 Mid Channel | 1732.5 | MHz | 20M QPSK CH 20175 |
|----------------------|------------------|--------------------|------------|------------|-------------------|
| Limit: +/- 2.5 ppm | | | | | |
| Power Supply | Environment | Frequency | Delta (Hz) | Limit (Hz) | |
| Vdc | Temperature (°C) | (MHz) | | | |
| 3.8 | -30 | 1732.5 | -3.2 | 4331 | |
| 3.8 | -20 | 1732.5 | 1 | 4331 | |
| 3.8 | -10 | 1732.5 | -3.3 | 4331 | |
| 3.8 | 0 | 1732.5 | 0 | 4331 | |
| 3.8 | 10 | 1732.5 | 1.8 | 4331 | |
| 3.8 | 20 | 1732.5 | 0 | 4331 | |
| 3.8 | 30 | 1732.5 | 1 | 4331 | |
| 3.8 | 40 | 1732.5 | -0.1 | 4331 | |
| 3.8 | 50 | 1732.5 | -0.6 | 4331 | |

Unless otherwise stated the results shown in this test report refer only to the sample(s) tested and such sample(s) are retained for 90 days only.

除非另有說明，此報告結果僅對測試之樣品負責，同時此樣品僅保留90天。本報告未經本公司書面許可，不可部份複製。

This document is issued by the Company subject to its General Conditions of Service printed overleaf, available on request or accessible at www.sgs.com/terms_and_conditions.htm and, for electronic format documents, subject to Terms and Conditions for Electronic Documents at www.sgs.com/terms_e-document.htm. Attention is drawn to the limitation of liability, indemnification and jurisdiction issues defined therein. Any holder of this document is advised that information contained hereon reflects the Company's findings at the time of its intervention only and within the limits of Client's instructions, if any. The Company's sole responsibility is to its Client and this document does not exonerate parties to a transaction from exercising all their rights and obligations under the transaction documents. This document cannot be reproduced except in full, without prior written approval of the Company. Any unauthorized alteration, forgery or falsification of the content or appearance of this document is unlawful and offenders may be prosecuted to the fullest extent of the law.

SGS Taiwan Ltd.

No.134,WuKungRoad,NewTaipeiIndustrialPark,WukuDistrict,NewTaipeiCity,Taiwan24803/新北市五股區新北產業園區五工路 134 號

台灣檢驗科技股份有限公司

t (886-2) 2299-3279

f (886-2) 2298-0488

www.tw.sgs.com

Member of SGS Group

FREQUENCY ERROR vs. VOLTAGE

| Reference Frequency: | | LTE B5 Mid Channel | 836.5 | MHz | 10M QPSK CH 20525 |
|----------------------|------------------|--------------------|------------|------------|-------------------|
| Limit: +/- 2.5 ppm | | | | | |
| Power Supply | Environment | Frequency | Delta (Hz) | Limit (Hz) | |
| Vdc | Temperature (°C) | (MHz) | | | |
| 4.2 | 25 | 836.499997 | -6.2 | 2091 | |
| 3.8 | 25 | 836.500004 | 0 | 2091 | |
| 3.6 | 25 | 836.5 | -3.3 | 2091 | |
| 3.4 (End Point) | 25 | 836.5 | -3.3 | 2091 | |

FREQUENCY ERROR vs. TEMPERATURE

| Reference Frequency: | | LTE B5 Mid Channel | 836.5 | MHz | 10M QPSK CH 20525 |
|----------------------|------------------|--------------------|------------|------------|-------------------|
| Limit: +/- 2.5 ppm | | | | | |
| Power Supply | Environment | Frequency | Delta (Hz) | Limit (Hz) | |
| Vdc | Temperature (°C) | (MHz) | | | |
| 3.8 | -30 | 836.500003 | 3.5 | 2091 | |
| 3.8 | -20 | 836.500001 | 1.4 | 2091 | |
| 3.8 | -10 | 836.499998 | -1.8 | 2091 | |
| 3.8 | 0 | 836.500002 | 2.9 | 2091 | |
| 3.8 | 10 | 836.5 | 0.3 | 2091 | |
| 3.8 | 20 | 836.499999 | 0 | 2091 | |
| 3.8 | 30 | 836.500002 | 3.1 | 2091 | |
| 3.8 | 40 | 836.499998 | -1 | 2091 | |
| 3.8 | 50 | 836.500003 | 3.2 | 2091 | |

Unless otherwise stated the results shown in this test report refer only to the sample(s) tested and such sample(s) are retained for 90 days only.

除非另有說明，此報告結果僅對測試之樣品負責，同時此樣品僅保留90天。本報告未經本公司書面許可，不可部份複製。

This document is issued by the Company subject to its General Conditions of Service printed overleaf, available on request or accessible at www.sgs.com/terms_and_conditions.htm and, for electronic format documents, subject to Terms and Conditions for Electronic Documents at www.sgs.com/terms_e-document.htm. Attention is drawn to the limitation of liability, indemnification and jurisdiction issues defined therein. Any holder of this document is advised that information contained hereon reflects the Company's findings at the time of its intervention only and within the limits of Client's instructions, if any. The Company's sole responsibility is to its Client and this document does not exonerate parties to a transaction from exercising all their rights and obligations under the transaction documents. This document cannot be reproduced except in full, without prior written approval of the Company. Any unauthorized alteration, forgery or falsification of the content or appearance of this document is unlawful and offenders may be prosecuted to the fullest extent of the law.

SGS Taiwan Ltd.

No.134,WuKungRoad,NewTaipeiIndustrialPark,WukuDistrict,NewTaipeiCity,Taiwan24803/新北市五股區新北產業園區五工路 134 號

台灣檢驗科技股份有限公司

t (886-2) 2299-3279

f (886-2) 2298-0488

www.tw.sgs.com

Member of SGS Group

FREQUENCY ERROR vs. VOLTAGE

| Reference Frequency: | | LTE B12 Mid Channel | 707.5 | MHz | 10M QPSK CH 23095 |
|----------------------|------------------|---------------------|------------|------------|-------------------|
| Limit: +/- 2.5 ppm | | | | | |
| Power Supply | Environment | Frequency | Delta (Hz) | Limit (Hz) | |
| Vdc | Temperature (°C) | (MHz) | | | |
| 4.2 | 25 | 707.499992 | -5 | 1769 | |
| 3.8 | 25 | 707.499997 | 0 | 1769 | |
| 3.6 | 25 | 707.500011 | 14.2 | 1769 | |
| 3.4 (End Point) | 25 | 707.50001 | 12.9 | 1769 | |

FREQUENCY ERROR vs. TEMPERATURE

| Reference Frequency: | | LTE B12 Mid Channel | 707.5 | MHz | 10M QPSK CH 23095 |
|----------------------|------------------|---------------------|------------|------------|-------------------|
| Limit: +/- 2.5 ppm | | | | | |
| Power Supply | Environment | Frequency | Delta (Hz) | Limit (Hz) | |
| Vdc | Temperature (°C) | (MHz) | | | |
| 3.8 | -30 | 707.499997 | -0.5 | 1769 | |
| 3.8 | -20 | 707.500008 | 11 | 1769 | |
| 3.8 | -10 | 707.499995 | -2.4 | 1769 | |
| 3.8 | 0 | 707.500002 | 5.2 | 1769 | |
| 3.8 | 10 | 707.499998 | 1.3 | 1769 | |
| 3.8 | 20 | 707.499997 | 0 | 1769 | |
| 3.8 | 30 | 707.499994 | -3.3 | 1769 | |
| 3.8 | 40 | 707.500006 | 8.6 | 1769 | |
| 3.8 | 50 | 707.500009 | 11.8 | 1769 | |

Unless otherwise stated the results shown in this test report refer only to the sample(s) tested and such sample(s) are retained for 90 days only.

除非另有說明，此報告結果僅對測試之樣品負責，同時此樣品僅保留90天。本報告未經本公司書面許可，不可部份複製。

This document is issued by the Company subject to its General Conditions of Service printed overleaf, available on request or accessible at www.sgs.com/terms_and_conditions.htm and, for electronic format documents, subject to Terms and Conditions for Electronic Documents at www.sgs.com/terms_e-document.htm. Attention is drawn to the limitation of liability, indemnification and jurisdiction issues defined therein. Any holder of this document is advised that information contained hereon reflects the Company's findings at the time of its intervention only and within the limits of Client's instructions, if any. The Company's sole responsibility is to its Client and this document does not exonerate parties to a transaction from exercising all their rights and obligations under the transaction documents. This document cannot be reproduced except in full, without prior written approval of the Company. Any unauthorized alteration, forgery or falsification of the content or appearance of this document is unlawful and offenders may be prosecuted to the fullest extent of the law.

FREQUENCY ERROR vs. VOLTAGE

| Reference Frequency: | | LTE Band 25 Mid Channel | 1882.5 | MHz | 20M QPSK CH 26365 |
|----------------------|------------------|-------------------------|------------|------------|-------------------|
| Limit: +/- 2.5 ppm | | | | | |
| Power Supply | Environment | Frequency | Delta (Hz) | Limit (Hz) | |
| Vdc | Temperature (°C) | (MHz) | | | |
| 4.2 | 25 | 1882.5 | 2.4 | 1775 | |
| 3.8 | 25 | 1882.5 | 0 | 1775 | |
| 3.6 | 25 | 1882.5 | 0.9 | 1775 | |
| 3.4 (End Point) | 25 | 1882.5 | 0.9 | 1775 | |

FREQUENCY ERROR vs. TEMPERATURE

| Reference Frequency: | | LTE Band 25 Mid Channel | 1882.5 | MHz | 20M QPSK CH 26365 |
|----------------------|------------------|-------------------------|------------|------------|-------------------|
| Limit: +/- 2.5 ppm | | | | | |
| Power Supply | Environment | Frequency | Delta (Hz) | Limit (Hz) | |
| Vdc | Temperature (°C) | (MHz) | | | |
| 3.8 | -30 | 1882.5 | -1 | 1775 | |
| 3.8 | -20 | 1882.5 | -2.5 | 1775 | |
| 3.8 | -10 | 1882.5 | -3.4 | 1775 | |
| 3.8 | 0 | 1882.5 | 0.5 | 1775 | |
| 3.8 | 10 | 1882.5 | 1.5 | 1775 | |
| 3.8 | 20 | 1882.5 | 0 | 1775 | |
| 3.8 | 30 | 1882.5 | -0.7 | 1775 | |
| 3.8 | 40 | 1882.5 | 2.4 | 1775 | |
| 3.8 | 50 | 1882.5 | -0.3 | 1775 | |

Unless otherwise stated the results shown in this test report refer only to the sample(s) tested and such sample(s) are retained for 90 days only.

除非另有說明，此報告結果僅對測試之樣品負責，同時此樣品僅保留90天。本報告未經本公司書面許可，不可部份複製。

This document is issued by the Company subject to its General Conditions of Service printed overleaf, available on request or accessible at www.sgs.com/terms_and_conditions.htm and, for electronic format documents, subject to Terms and Conditions for Electronic Documents at www.sgs.com/terms_e-document.htm. Attention is drawn to the limitation of liability, indemnification and jurisdiction issues defined therein. Any holder of this document is advised that information contained hereon reflects the Company's findings at the time of its intervention only and within the limits of Client's instructions, if any. The Company's sole responsibility is to its Client and this document does not exonerate parties to a transaction from exercising all their rights and obligations under the transaction documents. This document cannot be reproduced except in full, without prior written approval of the Company. Any unauthorized alteration, forgery or falsification of the content or appearance of this document is unlawful and offenders may be prosecuted to the fullest extent of the law.

SGS Taiwan Ltd.

No.134,WuKungRoad,NewTaipeiIndustrialPark,WukuDistrict,NewTaipeiCity,Taiwan24803/新北市五股區新北產業園區五工路 134 號

台灣檢驗科技股份有限公司

t (886-2) 2299-3279

f (886-2) 2298-0488

www.tw.sgs.com

Member of SGS Group

FREQUENCY ERROR vs. VOLTAGE

| Reference Frequency: | | LTE B26 Mid Channel | 836.5 | MHz | 15M QPSK CH 26915 |
|----------------------|------------------|---------------------|------------|------------|-------------------|
| Limit: +/- 2.5 ppm | | | | | |
| Power Supply | Environment | Frequency | Delta (Hz) | Limit (Hz) | |
| Vdc | Temperature (°C) | (MHz) | | | |
| 4.2 | 25 | 836.499988 | -31 | 2091 | |
| 3.8 | 25 | 836.500019 | 0 | 2091 | |
| 3.6 | 25 | 836.500011 | -8 | 2091 | |
| 3.4 (End Point) | 25 | 836.500015 | -4 | 2091 | |

FREQUENCY ERROR vs. TEMPERATURE

| Reference Frequency: | | LTE B26 Mid Channel | 836.5 | MHz | 15M QPSK CH 26915 |
|----------------------|------------------|---------------------|------------|------------|-------------------|
| Limit: +/- 2.5 ppm | | | | | |
| Power Supply | Environment | Frequency | Delta (Hz) | Limit (Hz) | |
| Vdc | Temperature (°C) | (MHz) | | | |
| 3.8 | -30 | 836.499991 | -27 | 2091 | |
| 3.8 | -20 | 836.499989 | -29 | 2091 | |
| 3.8 | -10 | 836.499993 | -25 | 2091 | |
| 3.8 | 0 | 836.500012 | -6 | 2091 | |
| 3.8 | 10 | 836.499992 | -26 | 2091 | |
| 3.8 | 20 | 836.500018 | 0 | 2091 | |
| 3.8 | 30 | 836.500014 | -4 | 2091 | |
| 3.8 | 40 | 836.500007 | -11 | 2091 | |
| 3.8 | 50 | 836.500013 | -5 | 2091 | |

Unless otherwise stated the results shown in this test report refer only to the sample(s) tested and such sample(s) are retained for 90 days only.

除非另有說明，此報告結果僅對測試之樣品負責，同時此樣品僅保留90天。本報告未經本公司書面許可，不可部份複製。

This document is issued by the Company subject to its General Conditions of Service printed overleaf, available on request or accessible at www.sgs.com/terms_and_conditions.htm and, for electronic format documents, subject to Terms and Conditions for Electronic Documents at www.sgs.com/terms_e-document.htm. Attention is drawn to the limitation of liability, indemnification and jurisdiction issues defined therein. Any holder of this document is advised that information contained hereon reflects the Company's findings at the time of its intervention only and within the limits of Client's instructions, if any. The Company's sole responsibility is to its Client and this document does not exonerate parties to a transaction from exercising all their rights and obligations under the transaction documents. This document cannot be reproduced except in full, without prior written approval of the Company. Any unauthorized alteration, forgery or falsification of the content or appearance of this document is unlawful and offenders may be prosecuted to the fullest extent of the law.

FREQUENCY ERROR vs. VOLTAGE

| Reference Frequency: | | LTE B41 Mid Channel | 2593 | MHz | 10M QPSK CH 40620 |
|----------------------|------------------|---------------------|------------|------------|-------------------|
| Limit: +/- 2.5 ppm | | | | | |
| Power Supply | Environment | Frequency | Delta (Hz) | Limit (Hz) | |
| Vdc | Temperature (°C) | (MHz) | | | |
| 4.2 | 25 | 2593.00002 | 5 | 6488 | |
| 3.8 | 25 | 2593.00001 | 0 | 6488 | |
| 3.6 | 25 | 2593.00002 | 2 | 6488 | |
| 3.4 (End Point) | 25 | 2593.00002 | 3 | 6488 | |

FREQUENCY ERROR vs. TEMPERATURE

| Reference Frequency: | | LTE B41 Mid Channel | 2593 | MHz | 10M QPSK CH 40740 |
|----------------------|------------------|---------------------|------------|------------|-------------------|
| Limit: +/- 2.5 ppm | | | | | |
| Power Supply | Environment | Frequency | Delta (Hz) | Limit (Hz) | |
| Vdc | Temperature (°C) | (MHz) | | | |
| 3.8 | -30 | 2593 | 1.8 | 6488 | |
| 3.8 | -20 | 2593 | 0.3 | 6488 | |
| 3.8 | -10 | 2593 | -0.6 | 6488 | |
| 3.8 | 0 | 2593 | 5.2 | 6488 | |
| 3.8 | 10 | 2593 | 1.3 | 6488 | |
| 3.8 | 20 | 2593 | 0 | 6488 | |
| 3.8 | 30 | 2592.99999 | -3.3 | 6488 | |
| 3.8 | 40 | 2593.00001 | 8.6 | 6488 | |
| 3.8 | 50 | 2593 | 1.8 | 6488 | |

Unless otherwise stated the results shown in this test report refer only to the sample(s) tested and such sample(s) are retained for 90 days only.

除非另有說明，此報告結果僅對測試之樣品負責，同時此樣品僅保留90天。本報告未經本公司書面許可，不可部份複製。

This document is issued by the Company subject to its General Conditions of Service printed overleaf, available on request or accessible at www.sgs.com/terms_and_conditions.htm and, for electronic format documents, subject to Terms and Conditions for Electronic Documents at www.sgs.com/terms_e-document.htm. Attention is drawn to the limitation of liability, indemnification and jurisdiction issues defined therein. Any holder of this document is advised that information contained hereon reflects the Company's findings at the time of its intervention only and within the limits of Client's instructions, if any. The Company's sole responsibility is to its Client and this document does not exonerate parties to a transaction from exercising all their rights and obligations under the transaction documents. This document cannot be reproduced except in full, without prior written approval of the Company. Any unauthorized alteration, forgery or falsification of the content or appearance of this document is unlawful and offenders may be prosecuted to the fullest extent of the law.

SGS Taiwan Ltd.

No.134,WuKungRoad,NewTaipeiIndustrialPark,WukuDistrict,NewTaipeiCity,Taiwan24803/新北市五股區新北產業園區五工路 134 號

台灣檢驗科技股份有限公司

t (886-2) 2299-3279

f (886-2) 2298-0488

www.tw.sgs.com

Member of SGS Group

FREQUENCY ERROR vs. VOLTAGE (LTE B26 for Part 90S)

| Reference Frequency: | | LTE B26 Mid Channel | 819.0 | MHz | 1.4M QPSK CH 26740 |
|----------------------|------------------|---------------------|------------|------------|--------------------|
| Limit: +/- 2.5 ppm | | | | | |
| Power Supply | Environment | Frequency | Delta (Hz) | Limit (Hz) | |
| Vdc | Temperature (°C) | (MHz) | | | |
| 4.2 | 25 | 819 | -0.4 | 2048 | |
| 3.8 | 25 | 819 | 0 | 2048 | |
| 3.6 | 25 | 819 | -1 | 2048 | |
| 3.4 (End Point) | 25 | 819 | -1.3 | 2048 | |

FREQUENCY ERROR vs. TEMPERATURE

| Reference Frequency: | | LTE B26 Mid Channel | 819.0 | MHz | 1.4M QPSK CH 26740 |
|----------------------|------------------|---------------------|------------|------------|--------------------|
| Limit: +/- 2.5 ppm | | | | | |
| Power Supply | Environment | Frequency | Delta (Hz) | Limit (Hz) | |
| Vdc | Temperature (°C) | (MHz) | | | |
| 3.8 | -30 | 819 | 5.1 | 2048 | |
| 3.8 | -20 | 819 | 1.1 | 2048 | |
| 3.8 | -10 | 819 | 1.5 | 2048 | |
| 3.8 | 0 | 819 | 5.8 | 2048 | |
| 3.8 | 10 | 819 | 1.3 | 2048 | |
| 3.8 | 20 | 819 | 0 | 2048 | |
| 3.8 | 30 | 819 | 1.7 | 2048 | |
| 3.8 | 40 | 819 | 0.2 | 2048 | |
| 3.8 | 50 | 819 | -0.7 | 2048 | |

Note: The battery is rated 3.8Vdc.

Unless otherwise stated the results shown in this test report refer only to the sample(s) tested and such sample(s) are retained for 90 days only.

除非另有說明，此報告結果僅對測試之樣品負責，同時此樣品僅保留90天。本報告未經本公司書面許可，不可部份複製。

This document is issued by the Company subject to its General Conditions of Service printed overleaf, available on request or accessible at www.sgs.com/terms_and_conditions.htm and, for electronic format documents, subject to Terms and Conditions for Electronic Documents at www.sgs.com/terms_e-document.htm. Attention is drawn to the limitation of liability, indemnification and jurisdiction issues defined therein. Any holder of this document is advised that information contained hereon reflects the Company's findings at the time of its intervention only and within the limits of Client's instructions, if any. The Company's sole responsibility is to its Client and this document does not exonerate parties to a transaction from exercising all their rights and obligations under the transaction documents. This document cannot be reproduced except in full, without prior written approval of the Company. Any unauthorized alteration, forgery or falsification of the content or appearance of this document is unlawful and offenders may be prosecuted to the fullest extent of the law.

12. PEAK TO AVERAGE RATIO

12.1. Standard Applicable

The peak-to-average ratio (PAR) of the transmission may not exceed 13dB.

12.2. Test SET-UP

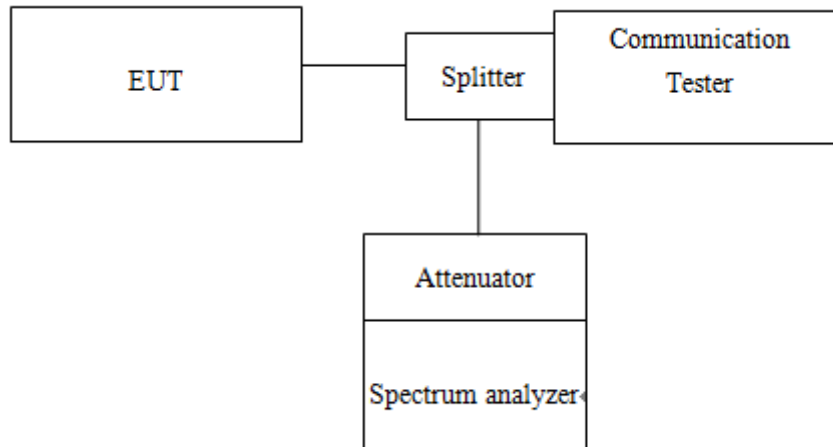

12.3. Measurement Procedure

1. KDB 971168 D01 is employed as the following procedure is proper adjusted accordingly:
2. Set resolution/measurement bandwidth \geq signal's occupied bandwidth; & internal =1ms
3. Set the number of counts to a value that stabilizes the measured CCDF curve.

12.4. Measurement Equipment Used

| Conducted Emission (measured at antenna port) Test Site | | | | | |
|---|-----------|--------------------|---------------|------------|------------|
| EQUIPMENT TYPE | MFR | MODEL NUMBER | SERIAL NUMBER | LAST CAL. | CAL DUE. |
| Spectrum Analyzer | KEYSIGHT | N9010A | MY54510568 | 04/14/2016 | 04/13/2017 |
| Communication Tester | Anritsu | MT8820C | 6201107337 | 05/25/2016 | 05/24/2017 |
| Coaxial Cable 30cm | WOKEN | 00100A1F1A 195C | RF01 | 12/12/2016 | 12/11/2017 |
| Temperature Chamber | TERCHY | MHK-120LK | 1020582 | 06/16/2016 | 06/15/2017 |
| DC Block | PASTERNAK | PE8210 | RF29 | 12/12/2016 | 12/11/2017 |
| Splitter | RF-LAMBAD | RFLT2W1G1 8G | RF35 | 12/12/2016 | 12/11/2017 |
| Attenuator | WOKEN | 218FS-10 | RF23 | 12/12/2016 | 12/11/2017 |
| DC Power Supply | Agilent | E3640A | MY53140006 | 05/04/2016 | 05/03/2017 |
| Communication Tester | Anritsu | MT8820C | 6201107337 | 05/25/2016 | 05/24/2017 |

Unless otherwise stated the results shown in this test report refer only to the sample(s) tested and such sample(s) are retained for 90 days only.

除非另有說明，此報告結果僅對測試之樣品負責，同時此樣品僅保留90天。本報告未經本公司書面許可，不可部份複製。

This document is issued by the Company subject to its General Conditions of Service printed overleaf, available on request or accessible at www.sgs.com/terms_and_conditions.htm and, for electronic format documents, subject to Terms and Conditions for Electronic Documents at www.sgs.com/terms_e-document.htm. Attention is drawn to the limitation of liability, indemnification and jurisdiction issues defined therein. Any holder of this document is advised that information contained hereon reflects the Company's findings at the time of its intervention only and within the limits of Client's instructions, if any. The Company's sole responsibility is to its Client and this document does not exonerate parties to a transaction from exercising all their rights and obligations under the transaction documents. This document cannot be reproduced except in full, without prior written approval of the Company. Any unauthorized alteration, forgery or falsification of the content or appearance of this document is unlawful and offenders may be prosecuted to the fullest extent of the law.

SGS Taiwan Ltd.

No.134,WuKungRoad,NewTaipeiIndustrialPark,WukuDistrict,NewTaipeiCity,Taiwan24803/新北市五股區新北產業園區五工路 134 號

台灣檢驗科技股份有限公司

t (886-2) 2299-3279

f (886-2) 2298-0488

www.tw.sgs.com

Member of SGS Group

12.5. Measurement Result

Tabular Results:

| LTE BAND 2 | | | | | | | |
|---------------------------|-------|----------------------------|-------|-------------------------|-------|----------------------------|-------|
| Channel bandwidth: 1.4MHz | | | | Channel bandwidth: 3MHz | | | |
| Freq. (MHz) | CH | Peak-to-Average Ratio (dB) | | Freq. (MHz) | CH | Peak-to-Average Ratio (dB) | |
| | | 16QAM | LIMIT | | | 16QAM | LIMIT |
| 1850.7 | 18607 | 5.92 | 13 | 1851.5 | 18615 | 5.87 | 13 |
| 1880.0 | 18900 | 5.90 | 13 | 1880.0 | 18900 | 6.08 | 13 |
| 1909.3 | 19193 | 5.81 | 13 | 1908.5 | 19185 | 6.03 | 13 |

| LTE BAND 2 | | | | | | | |
|-------------------------|-------|----------------------------|-------|--------------------------|-------|----------------------------|-------|
| Channel bandwidth: 5MHz | | | | Channel bandwidth: 10MHz | | | |
| Freq. (MHz) | CH | Peak-to-Average Ratio (dB) | | Freq. (MHz) | CH | Peak-to-Average Ratio (dB) | |
| | | 16QAM | LIMIT | | | 16QAM | LIMIT |
| 1852.5 | 18625 | 5.89 | 13 | 1855.0 | 18650 | 5.92 | 13 |
| 1880.0 | 18900 | 5.84 | 13 | 1880.0 | 18900 | 5.96 | 13 |
| 1907.5 | 19175 | 5.86 | 13 | 1905.0 | 19150 | 5.86 | 13 |

| LTE BAND 2 | | | | | | | |
|--------------------------|-------|----------------------------|-------|--------------------------|-------|----------------------------|-------|
| Channel bandwidth: 15MHz | | | | Channel bandwidth: 20MHz | | | |
| Freq. (MHz) | CH | Peak-to-Average Ratio (dB) | | Freq. (MHz) | CH | Peak-to-Average Ratio (dB) | |
| | | 16QAM | LIMIT | | | 16QAM | LIMIT |
| 1857.5 | 18675 | 6.70 | 13 | 1860.0 | 18700 | 7.05 | 13 |
| 1880.0 | 18900 | 6.64 | 13 | 1880.0 | 18900 | 7.05 | 13 |
| 1902.5 | 19125 | 6.64 | 13 | 1900.0 | 19100 | 6.87 | 13 |

Unless otherwise stated the results shown in this test report refer only to the sample(s) tested and such sample(s) are retained for 90 days only.

除非另有說明，此報告結果僅對測試之樣品負責，同時此樣品僅保留90天。本報告未經本公司書面許可，不可部份複製。

This document is issued by the Company subject to its General Conditions of Service printed overleaf, available on request or accessible at www.sgs.com/terms_and_conditions.htm and, for electronic format documents, subject to Terms and Conditions for Electronic Documents at www.sgs.com/terms_e-document.htm. Attention is drawn to the limitation of liability, indemnification and jurisdiction issues defined therein. Any holder of this document is advised that information contained hereon reflects the Company's findings at the time of its intervention only and within the limits of Client's instructions, if any. The Company's sole responsibility is to its Client and this document does not exonerate parties to a transaction from exercising all their rights and obligations under the transaction documents. This document cannot be reproduced except in full, without prior written approval of the Company. Any unauthorized alteration, forgery or falsification of the content or appearance of this document is unlawful and offenders may be prosecuted to the fullest extent of the law.

SGS Taiwan Ltd.

No.134,WuKungRoad,NewTaipeiIndustrialPark,WukuDistrict,NewTaipeiCity,Taiwan24803/新北市五股區新北產業園區五工路 134 號

台灣檢驗科技股份有限公司

t (886-2) 2299-3279

f (886-2) 2298-0488

www.tw.sgs.com

Member of SGS Group

| LTE BAND 4 | | | | | | | |
|---------------------------|-------|-------------------------------|-------|-------------------------|-------|-------------------------------|-------|
| Channel bandwidth: 1.4MHz | | | | Channel bandwidth: 3MHz | | | |
| Freq. (MHz) | CH | Peak-to-Average Ratio (dB) | | Freq. (MHz) | CH | Peak-to-Average Ratio (dB) | |
| | | 16QAM | LIMIT | | | 16QAM | LIMIT |
| 1710.7 | 19957 | 5.70 | 13 | 1711.5 | 19965 | 5.09 | 13 |
| 1732.5 | 20175 | 5.69 | 13 | 1732.5 | 20175 | 5.03 | 13 |
| 1754.3 | 20393 | 5.84 | 13 | 1753.5 | 20385 | 5.32 | 13 |

| LTE BAND 4 | | | | | | | |
|-------------------------|-------|-------------------------------|-------|--------------------------|-------|-------------------------------|-------|
| Channel bandwidth: 5MHz | | | | Channel bandwidth: 10MHz | | | |
| Freq. (MHz) | CH | Peak-to-Average Ratio (dB) | | Freq. (MHz) | CH | Peak-to-Average Ratio (dB) | |
| | | 16QAM | LIMIT | | | 16QAM | LIMIT |
| 1712.5 | 19957 | 5.73 | 13 | 1715.0 | 20000 | 5.83 | 13 |
| 1732.5 | 20175 | 5.76 | 13 | 1732.5 | 20175 | 5.81 | 13 |
| 1752.5 | 20375 | 5.89 | 13 | 1750.0 | 20350 | 5.89 | 13 |

| LTE BAND 4 | | | | | | | |
|--------------------------|-------|-------------------------------|-------|--------------------------|-------|-------------------------------|-------|
| Channel bandwidth: 15MHz | | | | Channel bandwidth: 20MHz | | | |
| Freq. (MHz) | CH | Peak-to-Average Ratio (dB) | | Freq. (MHz) | CH | Peak-to-Average Ratio (dB) | |
| | | 16QAM | LIMIT | | | 16QAM | LIMIT |
| 1717.5 | 20025 | 6.60 | 13 | 1720.0 | 20050 | 7.03 | 13 |
| 1732.5 | 20175 | 6.60 | 13 | 1732.5 | 20175 | 6.94 | 13 |
| 1747.5 | 20325 | 6.60 | 13 | 1745.0 | 20300 | 7.05 | 13 |

Unless otherwise stated the results shown in this test report refer only to the sample(s) tested and such sample(s) are retained for 90 days only.

除非另有說明，此報告結果僅對測試之樣品負責，同時此樣品僅保留90天。本報告未經本公司書面許可，不可部份複製。

This document is issued by the Company subject to its General Conditions of Service printed overleaf, available on request or accessible at www.sgs.com/terms_and_conditions.htm and, for electronic format documents, subject to Terms and Conditions for Electronic Documents at www.sgs.com/terms_e-document.htm. Attention is drawn to the limitation of liability, indemnification and jurisdiction issues defined therein. Any holder of this document is advised that information contained hereon reflects the Company's findings at the time of its intervention only and within the limits of Client's instructions, if any. The Company's sole responsibility is to its Client and this document does not exonerate parties to a transaction from exercising all their rights and obligations under the transaction documents. This document cannot be reproduced except in full, without prior written approval of the Company. Any unauthorized alteration, forgery or falsification of the content or appearance of this document is unlawful and offenders may be prosecuted to the fullest extent of the law.

SGS Taiwan Ltd.

No.134,WuKungRoad,NewTaipeiIndustrialPark,WukuDistrict,NewTaipeiCity,Taiwan24803/新北市五股區新北產業園區五工路 134 號

台灣檢驗科技股份有限公司

t (886-2) 2299-3279

f (886-2) 2298-0488

www.tw.sgs.com

Member of SGS Group

| LTE BAND 41 | | | | | | | |
|-------------------------|-------|----------------------------|-------|--------------------------|-------|----------------------------|-------|
| Channel bandwidth: 5MHz | | | | Channel bandwidth: 10MHz | | | |
| Freq. (MHz) | CH | Peak-to-Average Ratio (dB) | | Freq. (MHz) | CH | Peak-to-Average Ratio (dB) | |
| | | 16QAM | Limit | | | 16QAM | Limit |
| 2498.5 | 39675 | 8.83 | 13 | 2501.0 | 39700 | 9.85 | 13 |
| 2593.0 | 40620 | 8.69 | 13 | 2593.0 | 40620 | 9.3 | 13 |
| 2687.5 | 41565 | 9.97 | 13 | 2685.0 | 41540 | 9.66 | 13 |

| LTE BAND 41 | | | | | | | |
|--------------------------|-------|----------------------------|-------|--------------------------|-------|----------------------------|-------|
| Channel bandwidth: 15MHz | | | | Channel bandwidth: 20MHz | | | |
| Freq. (MHz) | CH | Peak-to-Average Ratio (dB) | | Freq. (MHz) | CH | Peak-to-Average Ratio (dB) | |
| | | 16QAM | Limit | | | 16QAM | Limit |
| 2503.5 | 39725 | 9.02 | 13 | 2506.0 | 39750 | 9.25 | 13 |
| 2593.0 | 40620 | 9.74 | 13 | 2593.0 | 40620 | 9.15 | 13 |
| 2682.5 | 41515 | 8.91 | 13 | 2680.0 | 41490 | 11.01 | 13 |

Measurement Results:

Please refer to next page.

Unless otherwise stated the results shown in this test report refer only to the sample(s) tested and such sample(s) are retained for 90 days only.

除非另有說明，此報告結果僅對測試之樣品負責，同時此樣品僅保留90天。本報告未經本公司書面許可，不可部份複製。

This document is issued by the Company subject to its General Conditions of Service printed overleaf, available on request or accessible at www.sgs.com/terms_and_conditions.htm and, for electronic format documents, subject to Terms and Conditions for Electronic Documents at www.sgs.com/terms_e-document.htm. Attention is drawn to the limitation of liability, indemnification and jurisdiction issues defined therein. Any holder of this document is advised that information contained hereon reflects the Company's findings at the time of its intervention only and within the limits of Client's instructions, if any. The Company's sole responsibility is to its Client and this document does not exonerate parties to a transaction from exercising all their rights and obligations under the transaction documents. This document cannot be reproduced except in full, without prior written approval of the Company. Any unauthorized alteration, forgery or falsification of the content or appearance of this document is unlawful and offenders may be prosecuted to the fullest extent of the law.

SGS Taiwan Ltd.

No.134,WuKungRoad,NewTaipeiIndustrialPark,WukuDistrict,NewTaipeiCity,Taiwan24803/新北市五股區新北產業園區五工路 134 號

台灣檢驗科技股份有限公司

t (886-2) 2299-3279

f (886-2) 2298-0488

www.tw.sgs.com

Member of SGS Group

LTE_Band2 1.4MHz_16-QAM 6 0_LowCH18607-1850.7



LTE_Band2 3MHz_16-QAM 15 0_LowCH18615-1851.5



LTE_Band2 1.4MHz_16-QAM 6 0_MidCH18900-1880

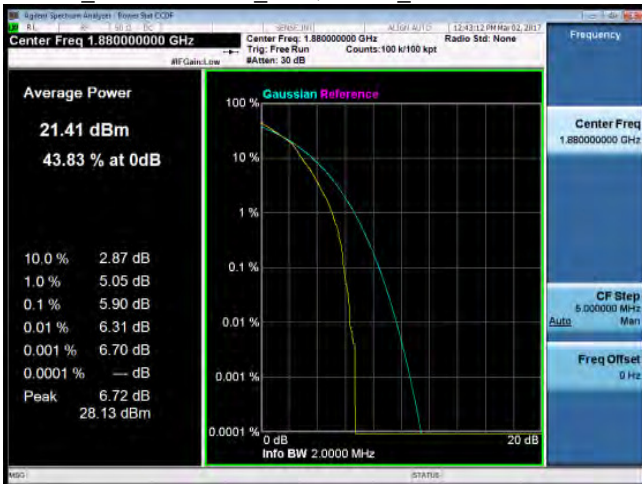

LTE_Band2 3MHz_16-QAM 15 0_MidCH18900-1880



LTE_Band2 1.4MHz_16-QAM 6 0_HighCH19193-1909.3

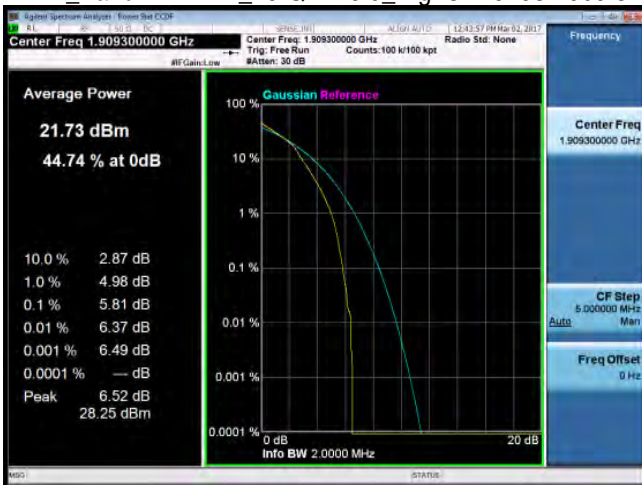

LTE_Band2 3MHz_16-QAM 15 0_HighCH19185-1908.5

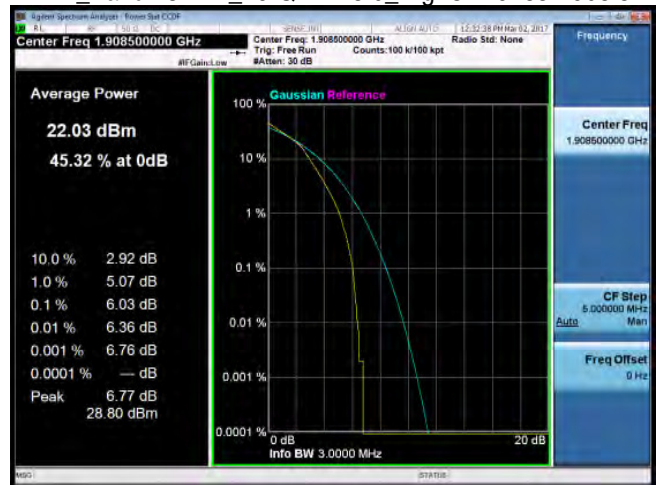

Unless otherwise stated the results shown in this test report refer only to the sample(s) tested and such sample(s) are retained for 90 days only.

除非另有說明，此報告結果僅對測試之樣品負責，同時此樣品僅保留90天。本報告未經本公司書面許可，不可部份複製。

This document is issued by the Company subject to its General Conditions of Service printed overleaf, available on request or accessible at www.sgs.com/terms_and_conditions.htm and, for electronic format documents, subject to Terms and Conditions for Electronic Documents at www.sgs.com/terms_e-document.htm. Attention is drawn to the limitation of liability, indemnification and jurisdiction issues defined therein. Any holder of this document is advised that information contained hereon reflects the Company's findings at the time of its intervention only and within the limits of Client's instructions, if any. The Company's sole responsibility is to its Client and this document does not exonerate parties to a transaction from exercising all their rights and obligations under the transaction documents. This document cannot be reproduced except in full, without prior written approval of the Company. Any unauthorized alteration, forgery or falsification of the content or appearance of this document is unlawful and offenders may be prosecuted to the fullest extent of the law.

LTE_Band2 5MHz_16-QAM 25 0_LowCH18625-1852.5

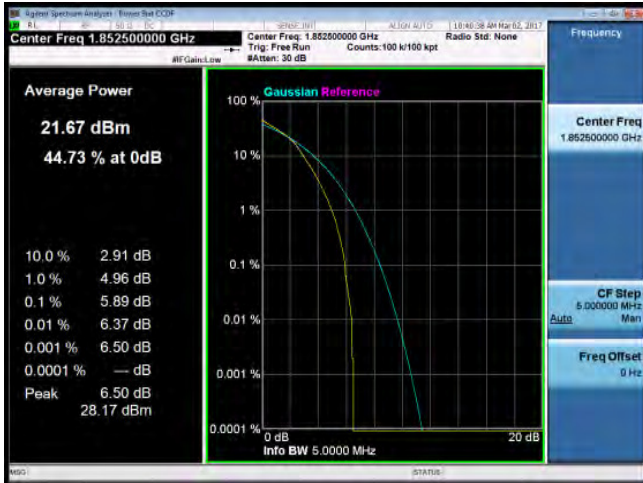

LTE_Band2 10MHz_16-QAM 50 0_LowCH18650-1855

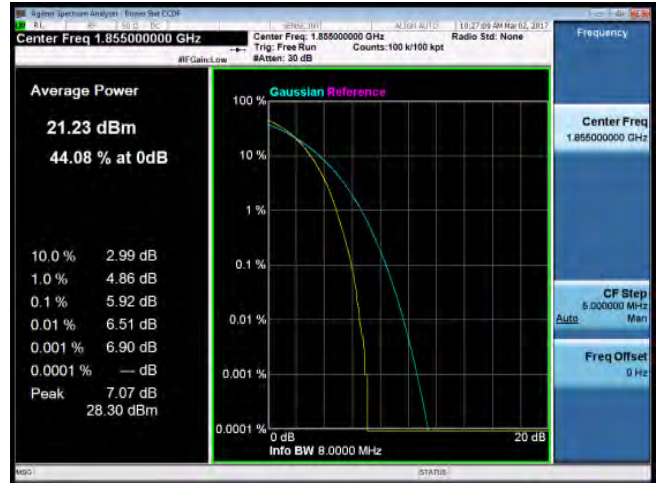

LTE_Band2 5MHz_16-QAM 25 0_MidCH18900-1880

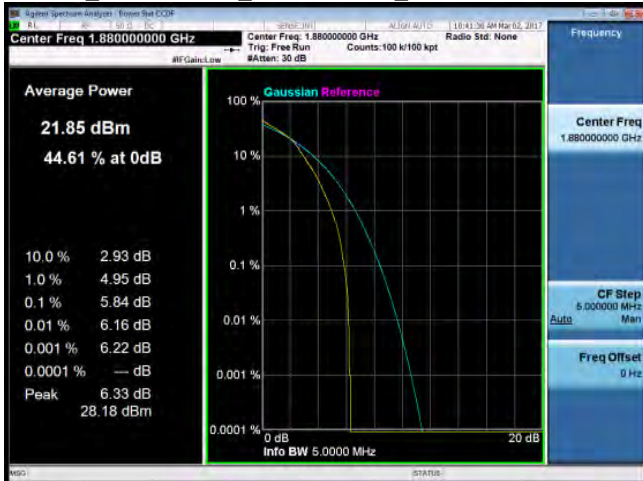

LTE_Band2 10MHz_16-QAM 50 0_MidCH18900-1880

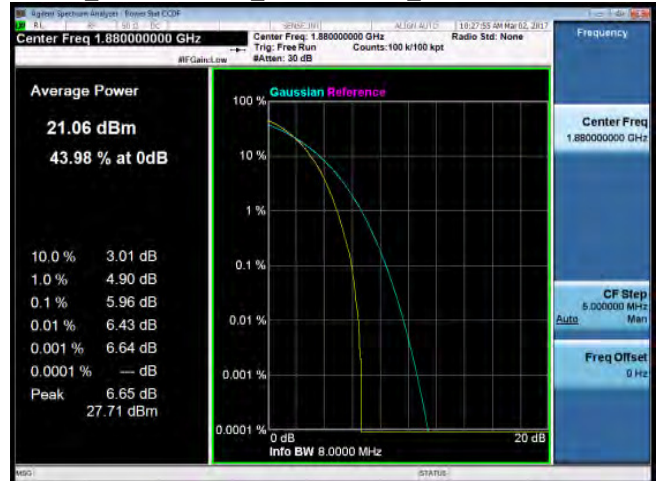

LTE_Band2 5MHz_16-QAM 25 0_HighCH19175-1907.5



LTE_Band2 10MHz_16-QAM 50 0_HighCH19150-1905

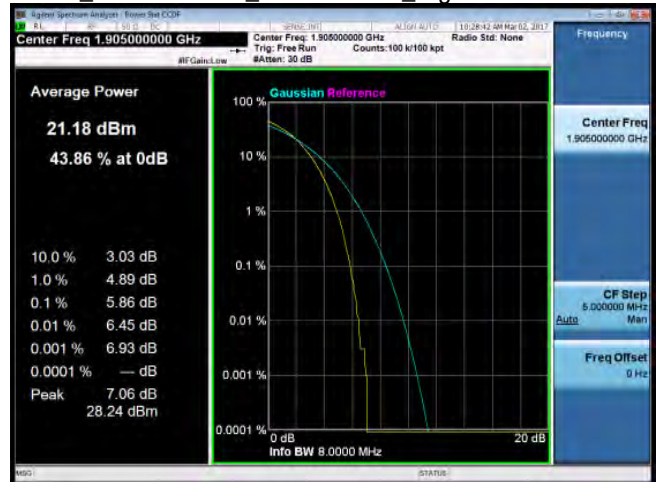

Unless otherwise stated the results shown in this test report refer only to the sample(s) tested and such sample(s) are retained for 90 days only.

除非另有說明，此報告結果僅對測試之樣品負責，同時此樣品僅保留90天。本報告未經本公司書面許可，不可部份複製。

This document is issued by the Company subject to its General Conditions of Service printed overleaf, available on request or accessible at www.sgs.com/terms_and_conditions.htm and, for electronic format documents, subject to Terms and Conditions for Electronic Documents at www.sgs.com/terms_e-document.htm. Attention is drawn to the limitation of liability, indemnification and jurisdiction issues defined therein. Any holder of this document is advised that information contained hereon reflects the Company's findings at the time of its intervention only and within the limits of Client's instructions, if any. The Company's sole responsibility is to its Client and this document does not exonerate parties to a transaction from exercising all their rights and obligations under the transaction documents. This document cannot be reproduced except in full, without prior written approval of the Company. Any unauthorized alteration, forgery or falsification of the content or appearance of this document is unlawful and offenders may be prosecuted to the fullest extent of the law.

LTE_Band2 15MHz_16-QAM 75 0_LowCH18675-1857.5

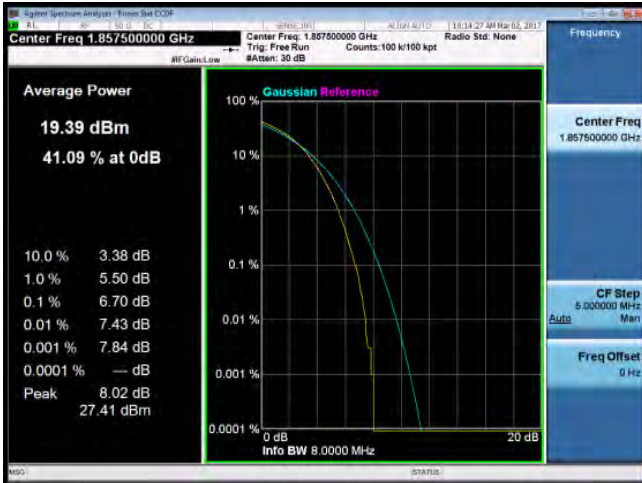

LTE_Band2 20MHz_16-QAM 100 0_LowCH18700-1860

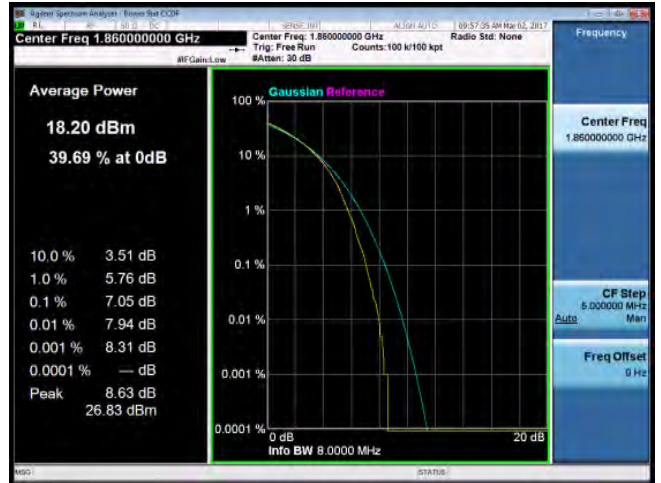

LTE_Band2 15MHz_16-QAM 75 0_MidCH18900-1880



LTE_Band2 20MHz_16-QAM 100 0_MidCH18900-1880



LTE_Band2 15MHz_16-QAM 75 0_HighCH19125-1902.5



LTE_Band2 20MHz_16-QAM 100 0_HighCH19100-1900



Unless otherwise stated the results shown in this test report refer only to the sample(s) tested and such sample(s) are retained for 90 days only.

除非另有說明，此報告結果僅對測試之樣品負責，同時此樣品僅保留90天。本報告未經本公司書面許可，不可部份複製。

This document is issued by the Company subject to its General Conditions of Service printed overleaf, available on request or accessible at www.sgs.com/terms_and_conditions.htm and, for electronic format documents, subject to Terms and Conditions for Electronic Documents at www.sgs.com/terms_e-document.htm. Attention is drawn to the limitation of liability, indemnification and jurisdiction issues defined therein. Any holder of this document is advised that information contained hereon reflects the Company's findings at the time of its intervention only and within the limits of Client's instructions, if any. The Company's sole responsibility is to its Client and this document does not exonerate parties to a transaction from exercising all their rights and obligations under the transaction documents. This document cannot be reproduced except in full, without prior written approval of the Company. Any unauthorized alteration, forgery or falsification of the content or appearance of this document is unlawful and offenders may be prosecuted to the fullest extent of the law.