



FCC TEST REPORT

REPORT NO.: RF960430L24

MODEL NO.: US101

RECEIVED: Jan. 10, 2007

TESTED: Jan. 10 ~ Jan. 19, 2007

ISSUED: May 04, 2007

APPLICANT: Quanta Microsystems, Inc.

ADDRESS: No.188 Wenhwa 2nd RD., Kueishan Hsiang,
Taoyuan Shien 33383, Taiwan, R. O. C.

ISSUED BY: Advance Data Technology Corporation

LAB ADDRESS: No. 47, 14th Ling, Chia Pau Tsuen, Lin Kou
Hsiang 244, Taipei Hsien, Taiwan, R.O.C.

TEST LOCATION: No. 19, Hwa Ya 2nd Rd., Wen Hwa Tsuen, Kwei
Shan Hsiang, Taoyuan Hsien 333, Taiwan,
R.O.C.

This test report consists of 65 pages in total. It may be duplicated completely for legal use with the approval of the applicant. It should not be reproduced except in full, without the written approval of our laboratory. The client should not use it to claim product endorsement by CNLA, A2LA or any government agencies. The test results in the report only apply to the tested sample.





Table of Contents

1.	CERTIFICATION	4
2.	SUMMARY OF TEST RESULTS	5
2.1	MEASUREMENT UNCERTAINTY	5
3.	GENERAL INFORMATION.....	6
3.1	GENERAL DESCRIPTION OF EUT	6
3.2	DESCRIPTION OF TEST MODES.....	7
3.2.1	CONFIGURATION OF SYSTEM UNDER TEST	7
3.2.2	TEST MODE APPLICABILITY AND TESTED CHANNEL DETAIL:.....	8
3.3	GENERAL DESCRIPTION OF APPLIED STANDARDS	10
3.4	DESCRIPTION OF SUPPORT UNITS	10
4.	TEST TYPES AND RESULTS	11
4.1	CONDUCTED EMISSION MEASUREMENT	11
4.1.1	LIMITS OF CONDUCTED EMISSION MEASUREMENT.....	11
4.1.2	TEST INSTRUMENTS	11
4.1.3	TEST PROCEDURES	12
4.1.4	DEVIATION FROM TEST STANDARD	12
4.1.5	TEST SETUP	13
4.1.6	EUT OPERATING CONDITIONS	13
4.1.7	TEST RESULTS	14
4.2	RADIATED EMISSION MEASUREMENT	20
4.2.1	LIMITS OF RADIATED EMISSION MEASUREMENT.....	20
4.2.2	TEST INSTRUMENTS	21
4.2.3	TEST PROCEDURES	22
4.2.4	DEVIATION FROM TEST STANDARD	22
4.2.5	TEST SETUP	23
4.2.6	EUT OPERATING CONDITIONS	23
4.2.7	TEST RESULTS	24
4.3	6dB BANDWIDTH MEASUREMENT	38
4.3.1	LIMITS OF 6dB BANDWIDTH MEASUREMENT	38
4.3.2	TEST INSTRUMENTS	38
4.3.3	TEST PROCEDURE	39
4.3.4	DEVIATION FROM TEST STANDARD	39
4.3.5	TEST SETUP	39
4.3.6	EUT OPERATING CONDITIONS	39
4.3.7	TEST RESULTS	40
4.4	MAXIMUM PEAK OUTPUT POWER	44
4.4.1	LIMITS OF MAXIMUM PEAK OUTPUT POWER MEASUREMENT.....	44
4.4.2	INSTRUMENTS.....	44
4.4.1	TEST PROCEDURES	45
4.4.2	DEVIATION FROM TEST STANDARD	45
4.4.3	TEST SETUP	45



4.4.4	EUT OPERATING CONDITIONS	45
4.4.3	TEST RESULTS	46
4.5	POWER SPECTRAL DENSITY MEASUREMENT	48
4.5.1	LIMITS OF POWER SPECTRAL DENSITY MEASUREMENT	48
4.5.2	TEST INSTRUMENTS	48
4.5.3	TEST PROCEDURE	49
4.5.4	DEVIATION FROM TEST STANDARD	49
4.5.5	TEST SETUP	49
4.5.6	EUT OPERATING CONDITION	49
4.5.7	TEST RESULTS	50
4.6	BAND EDGES MEASUREMENT	54
4.6.1	LIMITS OF BAND EDGES MEASUREMENT	54
4.6.2	TEST INSTRUMENTS	54
4.6.3	TEST PROCEDURE	54
4.6.4	DEVIATION FROM TEST STANDARD	54
4.6.5	EUT OPERATING CONDITION	54
4.6.6	TEST RESULTS	55
4.7	ANTENNA REQUIREMENT	63
4.7.1	STANDARD APPLICABLE	63
4.7.2	ANTENNA CONNECTED CONSTRUCTION	63
5.	INFORMATION ON THE TESTING LABORATORIES	64
	APPENDIX-A	A-1



1. CERTIFICATION

PRODUCT: IEEE 802.11 b/g WLAN USB Module

MODEL: US101

BRAND: QMI

APPLICANT: Quanta Microsystems, Inc.

TESTED: Jan. 10 ~ Jan. 19, 2007

TEST SAMPLE: ENGINEERING SAMPLE

STANDARDS: **FCC Part 15, Subpart C (Section 15.247)**

ANSI C63.4-2003

The above equipment (model: US101) have been tested by **Advance Data Technology Corporation**, and found compliance with the requirement of the above standards. The test record, data evaluation & Equipment Under Test (EUT) configurations represented herein are true and accurate accounts of the measurements of the sample's EMC characteristics under the conditions specified in this report.

PREPARED BY : Rennie Wang , **DATE:** May 04, 2007
Rennie Wang

TECHNICAL
ACCEPTANCE : Long Chen , **DATE:** May 04, 2007
Responsible for RF Long Chen

APPROVED BY : Gary Chang , **DATE:** May 04, 2007
Gary Chang / Supervisor

2. SUMMARY OF TEST RESULTS

The EUT has been tested according to the following specifications:

APPLIED STANDARD: FCC Part 15, Subpart C			
Standard Section	Test Type and Limit	Result	Remark
15.207	AC Power Conducted Emission	PASS	Meet the requirement of limit. Minimum passing margin is -15.65dB at 0.177MHz
15.247(a)(2)	Spectrum Bandwidth of a Direct Sequence Spread Spectrum System Limit: min. 500kHz	PASS	Meet the requirement of limit.
15.247(b)	Maximum Peak Output Power Limit: max. 30dBm	PASS	Meet the requirement of limit.
15.247(d)	Radiated Emissions Limit: Table 15.209	PASS	Meet the requirement of limit. Minimum passing margin is -1.02dB at 2390.00MHz
15.247(e)	Power Spectral Density Limit: max. 8dBm	PASS	Meet the requirement of limit.
15.247(d)	Band Edge Measurement Limit: 20dB less than the peak value of fundamental frequency	PASS	Meet the requirement of limit.

2.1 MEASUREMENT UNCERTAINTY

Where relevant, the following measurement uncertainty levels have been estimated for tests performed on the EUT as specified in CISPR 16-4:

Measurement	Frequency	Uncertainty
Conducted emissions	9kHz~30MHz	2.55 dB
Radiated emissions	30MHz ~ 200MHz	3.59 dB
	200MHz ~ 1000MHz	3.61 dB
	1GHz ~ 18GHz	2.26 dB
	18GHz ~ 40GHz	1.94 dB

This uncertainty represents an expanded uncertainty expressed at approximately the 95% confidence level using a coverage factor of k=2.

3. GENERAL INFORMATION

3.1 GENERAL DESCRIPTION OF EUT

EUT	IEEE 802.11 b/g WLAN USB Module
MODEL NO.	US101
FCC ID	T5U-US101-P
POWER SUPPLY	3.3Vdc from host equipment
MODULATION TYPE	CCK, DQPSK, DBPSK for DSSS 64QAM, 16QAM, QPSK, BPSK for OFDM
RADIO TECHNOLOGY	DSSS, OFDM
TRANSFER RATE	802.11b: 11/5.5/2/1Mbps 802.11g: 54/48/36/24/18/12/9/6Mbps
FREQUENCY RANGE	2412MHz ~ 2462MHz
NUMBER OF CHANNEL	11
OUTPUT POWER	54.828mW
ANTENNA TYPE	Refer to NOTE 1
DATA CABLE	NA
I/O PORTS	USB
ASSOCIATED DEVICES	NA

NOTE:

1. The following antennas were provided to this EUT.

Item	Type	Brand	Model	Gain (dBi)	Connector	Manufacturer
1	Monopole	Quanta	CL1	Main: 4.70 Aux.: 3.90	UFL	QUANTA COMPUTER INC.
2	Chip	Coxoc	341AWAE21 210004	Main: 3.59	UFL	CHANT SINCERE CO., LTD.
			341AWAE11 110004	Aux.:2.62		

2. The transmitter module is authorized for use in specific End-product (Laptop, Brand: OLPC, Model No.: ox-series).
3. The EUT, operates in the 2.4GHz frequency range, lets you connect IEEE 802.11g or IEEE 802.11b devices to the network. With its high-speed data transmissions of up to 54Mbps.
4. The above EUT information was declared by manufacturer and for more detailed features description, please refer to the manufacturer's specifications or User's Manual.

3.2 DESCRIPTION OF TEST MODES

Eleven channels are provided to this EUT.

CHANNEL	FREQUENCY	CHANNEL	FREQUENCY
1	2412 MHz	7	2442 MHz
2	2417 MHz	8	2447 MHz
3	2422 MHz	9	2452 MHz
4	2427 MHz	10	2457 MHz
5	2432 MHz	11	2462 MHz
6	2437 MHz		

3.2.1 CONFIGURATION OF SYSTEM UNDER TEST

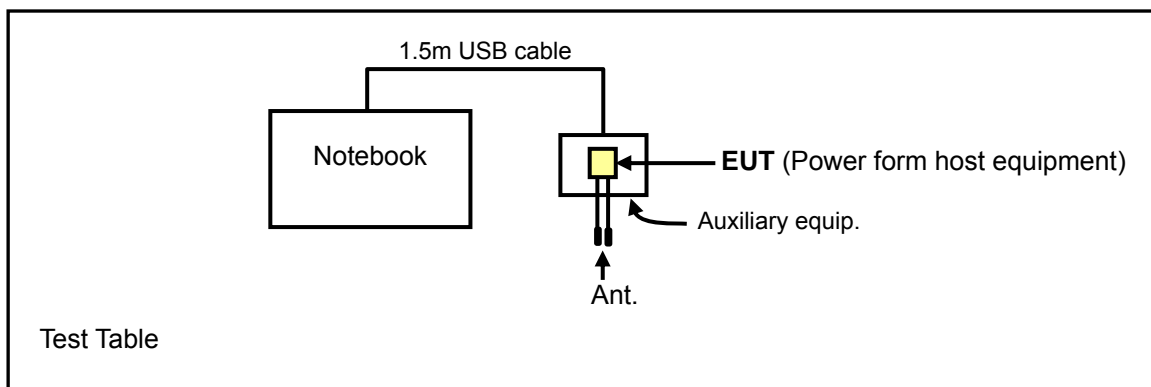

3.2.2 TEST MODE APPLICABILITY AND TESTED CHANNEL DETAIL

EUT configure mode	Applicable to				Description
	PLC	RE<1G	RE≥1G	APCM	
A	-	√	√	-	The EUT with Monopole antenna
B	√	√	√	√	The EUT with Chip antenna

Where PLC: Power Line Conducted Emission RE<1G RE: Radiated Emission below 1GHz
 RE≥1G: Radiated Emission above 1GHz APCM: Antenna Port Conducted Measurement

NOTE: "-" means no effect.

Power Line Conducted Emission Test:

- Pre-Scan has been conducted to determine the worst-case mode from all possible combinations between available modulations, data rates and antenna ports (if EUT with antenna diversity architecture).
- Following channel(s) was (were) selected for the final test as listed below.

EUT configure mode	Mode	Available Channel	Tested Channel	Modulation Technology	Modulation Type	Data Rate (Mbps)
B	802.11g	1 to 11	1, 6, 11	OFDM	BPSK	6

Radiated Emission Test (Below 1 GHz):

- Pre-Scan has been conducted to determine the worst-case mode from all possible combinations between available modulations, data rates and antenna ports (if EUT with antenna diversity architecture).
- Following channel(s) was (were) selected for the final test as listed below.

EUT configure mode	Mode	Available Channel	Tested Channel	Modulation Technology	Modulation Type	Data Rate (Mbps)
A	802.11g	1 to 11	11	OFDM	BPSK	6
B	802.11g	1 to 11	11	OFDM	BPSK	6



Radiated Emission Test (Above 1 GHz):

- Pre-Scan has been conducted to determine the worst-case mode from all possible combinations between available modulations, data rates and antenna ports (if EUT with antenna diversity architecture).
- Following channel(s) was (were) selected for the final test as listed below.

EUT configure mode	Mode	Available Channel	Tested Channel	Modulation Technology	Modulation Type	Data Rate (Mbps)
A	802.11b	1 to 11	1, 6, 11	DSSS	DBPSK	1
A	802.11g	1 to 11	1, 6, 11	OFDM	BPSK	6
B	802.11b	1 to 11	1, 6, 11	DSSS	DBPSK	1
B	802.11g	1 to 11	1, 6, 11	OFDM	BPSK	6

Bandedge Measurement:

- Pre-Scan has been conducted to determine the worst-case mode from all possible combinations between available modulations, data rates and antenna ports (if EUT with antenna diversity architecture).
- Following channel(s) was (were) selected for the final test as listed below.

EUT configure mode	Mode	Available Channel	Tested Channel	Modulation Technology	Modulation Type	Data Rate (Mbps)
B	802.11b	1 to 11	1, 11	DSSS	DBPSK	1
B	802.11g	1 to 11	1, 11	OFDM	BPSK	6

Antenna Port Conducted Measurement:

- Pre-Scan has been conducted to determine the worst-case mode from all possible combinations between available modulations, data rates and antenna ports (if EUT with antenna diversity architecture).
- Following channel(s) was (were) selected for the final test as listed below.

EUT configure mode	Mode	Available Channel	Tested Channel	Modulation Technology	Modulation Type	Data Rate (Mbps)
B	802.11b	1 to 11	1, 6, 11	DSSS	DBPSK	1
B	802.11g	1 to 11	1, 6, 11	OFDM	BPSK	6



3.3 GENERAL DESCRIPTION OF APPLIED STANDARDS

The EUT is a RF product. According to the specifications of the manufacturer, it must comply with the requirements of the following standards:

FCC Part 15, Subpart C. (15.247)

ANSI C63.4- 2003

All test items have been performed and recorded as per the above standards.

NOTE: The EUT is also considered as a kind of computer peripheral, because the connection to computer is necessary for typical use. It has been verified to comply with the requirements of FCC Part 15, Subpart B, Class B (DoC). The test report has been issued separately.

3.4 DESCRIPTION OF SUPPORT UNITS

The EUT has been tested as an independent unit together with other necessary accessories or support units. The following support units or accessories were used to form a representative test configuration during the tests.

NO.	PRODUCT	BRAND	MODEL NO.	SERIAL NO.	FCC ID
1	NOTEBOOK COMPUTER	DELL	PP05L	16484462992	E2K24CLNS

NO.	SIGNAL CABLE DESCRIPTION OF THE ABOVE SUPPORT UNITS
1	NA

NOTE: All power cords of the above support units are non shielded (1.8m).

4. TEST TYPES AND RESULTS

4.1 CONDUCTED EMISSION MEASUREMENT

4.1.1 LIMITS OF CONDUCTED EMISSION MEASUREMENT

FREQUENCY OF EMISSION (MHz)	CONDUCTED LIMIT (dB μ V)	
	Quasi-peak	Average
0.15-0.5	66 to 56	56 to 46
0.5-5	56	46
5-30	60	50

- NOTE:**
1. The lower limit shall apply at the transition frequencies.
 2. The limit decreases in line with the logarithm of the frequency in the range of 0.15 to 0.50 MHz.
 3. All emanations from a class A/B digital device or system, including any network of conductors and apparatus connected thereto, shall not exceed the level of field strengths specified above.

4.1.2 TEST INSTRUMENTS

DESCRIPTION & MANUFACTURER	MODEL NO.	SERIAL NO.	CALIBRATED UNTIL
Test Receiver ROHDE & SCHWARZ	ESCS30	100289	Dec. 07, 2007
RF signal cable Woken	5D-FB	Cable-HYC01-01	Jan. 06, 2008
LISN ROHDE & SCHWARZ	ESH3-Z5	100312	Feb. 15, 2007
LISN ROHDE & SCHWARZ	ESH2-Z5	100104	Sep. 14, 2007
Software ADT	ADT_Cond_V3	NA	NA

- NOTE:**
1. The calibration interval of the above test instruments is 12 months and the calibrations are traceable to NML/ROC and NIST/USA.
 2. The test was performed in HwaYa Shielded Room 1.
 3. The VCCI Site Registration No. is C-2040.

4.1.3 TEST PROCEDURES

- a. The EUT was placed 0.4 meters from the conducting wall of the shielded room with EUT being connected to the power mains through a line impedance stabilization network (LISN). Other support units were connected to the power mains through another LISN. The two LISNs provide 50 ohm/ 50uH of coupling impedance for the measuring instrument.
- b. Both lines of the power mains connected to the EUT were checked for maximum conducted interference.
- c. The frequency range from 150kHz to 30MHz was searched. Emission levels under (Limit - 20dB) was not recorded.

4.1.4 DEVIATION FROM TEST STANDARD

No deviation

4.1.5 TEST SETUP

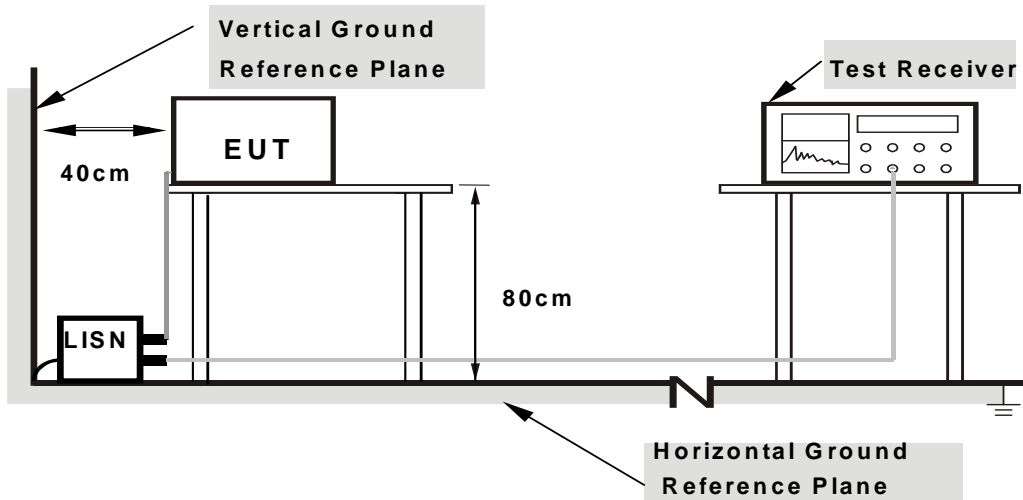

Note: 1.Support units were connected to second LISN.

2.Both of LISNs (AMN) are 80 cm from EUT and at least 80 from other units and other metal planes

For the actual test configuration, please refer to the attached file (Test Setup Photo).

4.1.6 EUT OPERATING CONDITIONS

- a. Connected the EUT to notebook and placed on a testing table.
- b. The notebook ran a test program (provided by manufacturer) to enable EUT under transmission/receiving condition continuously at specific channel frequency.

4.1.7 TEST RESULTS

CONDUCTED WORST-CASE DATA

EUT TEST CONDITION		MEASUREMENT DETAIL	
CHANNEL	Channel 1	PHASE	Line 1
MODULATION TYPE	BPSK	6dB BANDWIDTH	9 kHz
TRANSFER RATE	6Mbps	ENVIRONMENTAL CONDITIONS	21deg. C, 68%RH, 991hPa
TESTED BY	Dean Wang	INPUT POWER (SYSTEM)	120Vac, 60 Hz

No	Freq. [MHz]	Corr.	Reading Value		Emission Level		Limit		Margin	
		Factor	[dB (uV)]		[dB (uV)]		[dB (uV)]		(dB)	
		(dB)	Q.P.	AV.	Q.P.	AV.	Q.P.	AV.	Q.P.	AV.
1	0.162	0.21	47.01	-	47.22	-	65.38	55.38	-18.16	-
2	0.357	0.21	36.52	-	36.73	-	58.80	48.80	-22.07	-
3	0.959	0.24	31.98	-	32.22	-	56.00	46.00	-23.78	-
4	2.145	0.27	25.61	-	25.88	-	56.00	46.00	-30.12	-
5	10.547	0.56	35.87	-	36.43	-	60.00	50.00	-23.57	-
6	16.820	0.85	28.50	-	29.35	-	60.00	50.00	-30.65	-

- REMARKS:**
1. Q.P. and AV. are abbreviations of quasi-peak and average individually.
 2. "-": The Quasi-peak reading value also meets average limit and measurement with the average detector is unnecessary.
 3. The emission levels of other frequencies were very low against the limit.
 4. Margin value = Emission level - Limit value
 5. Correction factor = Insertion loss + Cable loss
 6. Emission Level = Correction Factor + Reading Value.

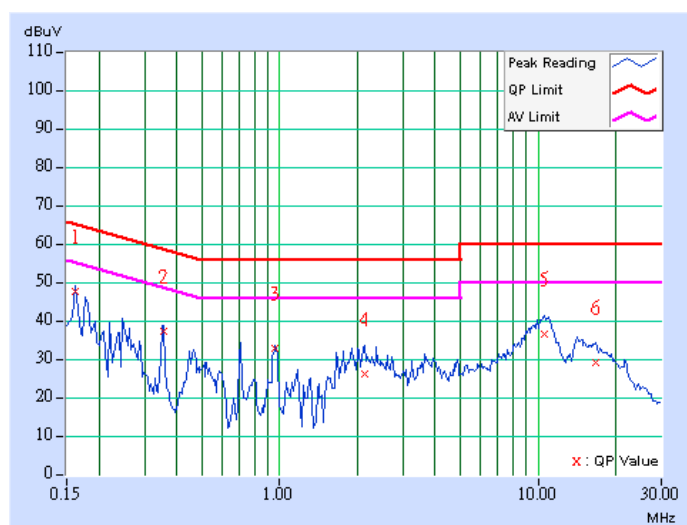

EUT TEST CONDITION		MEASUREMENT DETAIL	
CHANNEL	Channel 1	PHASE	Line 2
MODULATION TYPE	BPSK	6dB BANDWIDTH	9 kHz
TRANSFER RATE	6Mbps	ENVIRONMENTAL CONDITIONS	21deg. C, 68%RH, 991hPa
TESTED BY	Dean Wang	INPUT POWER (SYSTEM)	120Vac, 60 Hz

No	Freq. [MHz]	Corr.	Reading Value		Emission Level		Limit		Margin	
		Factor	[dB (uV)]		[dB (uV)]		[dB (uV)]		(dB)	
		(dB)	Q.P.	AV.	Q.P.	AV.	Q.P.	AV.	Q.P.	AV.
1	0.240	0.21	38.45	-	38.66	-	62.10	52.10	-23.44	-
2	0.353	0.21	37.55	-	37.76	-	58.89	48.89	-21.13	-
3	0.713	0.23	33.01	-	33.24	-	56.00	46.00	-22.76	-
4	2.323	0.28	22.71	-	22.99	-	56.00	46.00	-33.01	-
5	10.473	0.53	35.58	-	36.11	-	60.00	50.00	-23.89	-
6	14.445	0.46	30.54	-	31.00	-	60.00	50.00	-29.00	-

- REMARKS:**
1. Q.P. and AV. are abbreviations of quasi-peak and average individually.
 2. "-": The Quasi-peak reading value also meets average limit and measurement with the average detector is unnecessary.
 3. The emission levels of other frequencies were very low against the limit.
 4. Margin value = Emission level - Limit value
 5. Correction factor = Insertion loss + Cable loss
 6. Emission Level = Correction Factor + Reading Value.

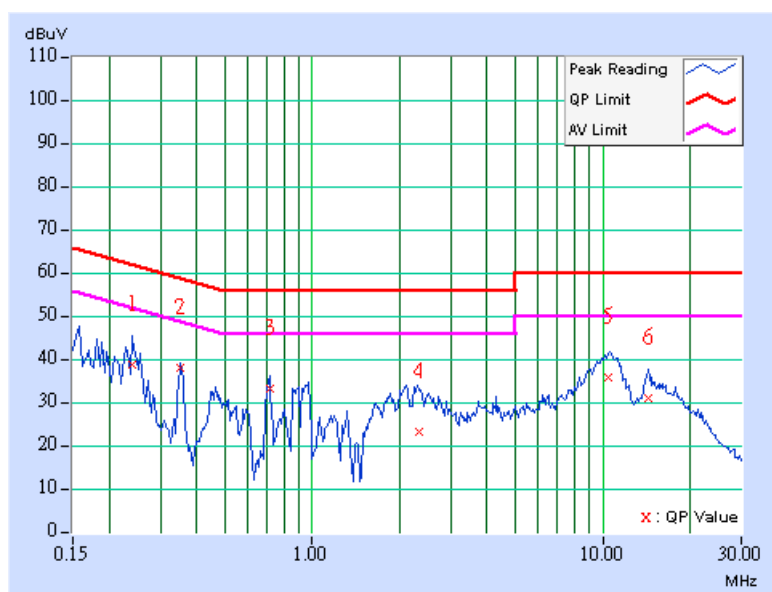

EUT TEST CONDITION		MEASUREMENT DETAIL	
CHANNEL	Channel 6	PHASE	Line 1
MODULATION TYPE	BPSK	6dB BANDWIDTH	9 kHz
TRANSFER RATE	6Mbps	ENVIRONMENTAL CONDITIONS	21deg. C, 68%RH, 991hPa
TESTED BY	Dean Wang	INPUT POWER (SYSTEM)	120Vac, 60 Hz

No	Freq. [MHz]	Corr. Factor (dB)	Reading Value		Emission Level		Limit		Margin	
			[dB (uV)]		[dB (uV)]		[dB (uV)]		(dB)	
			Q.P.	AV.	Q.P.	AV.	Q.P.	AV.	Q.P.	AV.
1	0.166	0.21	44.84	-	45.05	-	65.18	55.18	-20.13	-
2	0.357	0.21	36.26	-	36.47	-	58.80	48.80	-22.33	-
3	0.966	0.24	31.51	-	31.75	-	56.00	46.00	-24.25	-
4	2.023	0.26	30.82	-	31.08	-	56.00	46.00	-24.92	-
5	10.602	0.57	35.16	-	35.73	-	60.00	50.00	-24.27	-
6	14.539	0.73	30.12	-	30.85	-	60.00	50.00	-29.15	-

- REMARKS:**
1. Q.P. and AV. are abbreviations of quasi-peak and average individually.
 2. "-": The Quasi-peak reading value also meets average limit and measurement with the average detector is unnecessary.
 3. The emission levels of other frequencies were very low against the limit.
 4. Margin value = Emission level - Limit value
 5. Correction factor = Insertion loss + Cable loss
 6. Emission Level = Correction Factor + Reading Value.

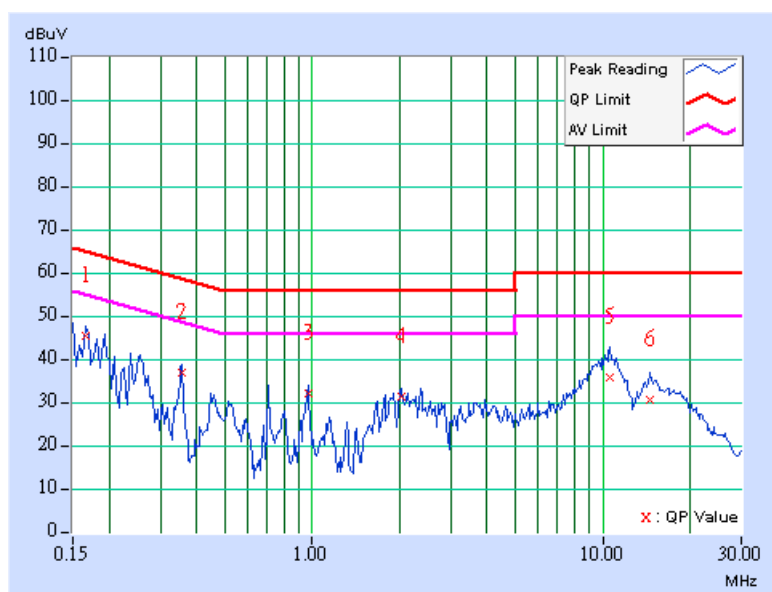

EUT TEST CONDITION		MEASUREMENT DETAIL	
CHANNEL	Channel 6	PHASE	Line 2
MODULATION TYPE	BPSK	6dB BANDWIDTH	9 kHz
TRANSFER RATE	6Mbps	ENVIRONMENTAL CONDITIONS	21deg. C, 68%RH, 991hPa
TESTED BY	Dean Wang	INPUT POWER (SYSTEM)	120Vac, 60 Hz

No	Freq. [MHz]	Corr.	Reading Value		Emission Level		Limit		Margin	
		Factor	[dB (uV)]		[dB (uV)]		[dB (uV)]		(dB)	
		(dB)	Q.P.	AV.	Q.P.	AV.	Q.P.	AV.	Q.P.	AV.
1	0.166	0.21	45.54	-	45.75	-	65.18	55.18	-19.43	-
2	0.259	0.21	38.90	-	39.11	-	61.45	51.45	-22.34	-
3	0.709	0.23	33.64	-	33.87	-	56.00	46.00	-22.13	-
4	2.363	0.28	29.25	-	29.53	-	56.00	46.00	-26.47	-
5	10.691	0.53	34.99	-	35.52	-	60.00	50.00	-24.48	-
6	14.977	0.45	30.24	-	30.69	-	60.00	50.00	-29.31	-

- REMARKS:**
1. Q.P. and AV. are abbreviations of quasi-peak and average individually.
 2. "-": The Quasi-peak reading value also meets average limit and measurement with the average detector is unnecessary.
 3. The emission levels of other frequencies were very low against the limit.
 4. Margin value = Emission level - Limit value
 5. Correction factor = Insertion loss + Cable loss
 6. Emission Level = Correction Factor + Reading Value.

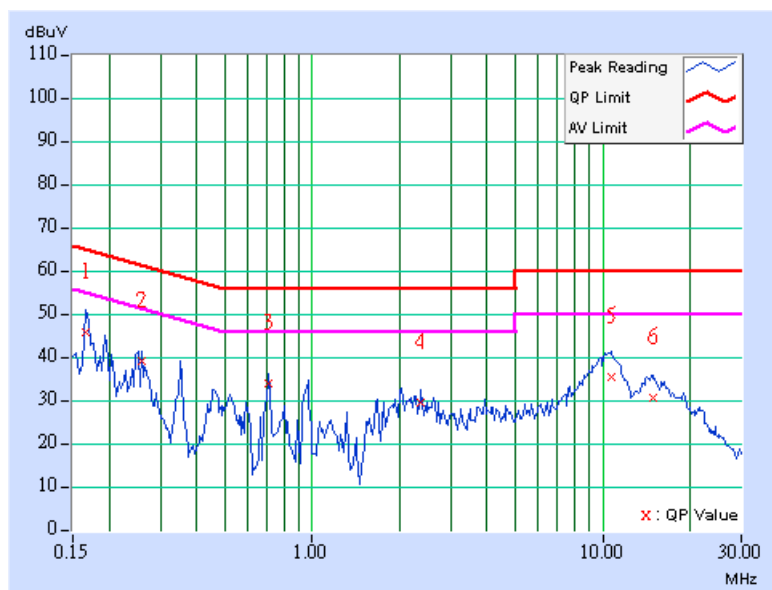

EUT TEST CONDITION		MEASUREMENT DETAIL	
CHANNEL	Channel 11	PHASE	Line 1
MODULATION TYPE	BPSK	6dB BANDWIDTH	9 kHz
TRANSFER RATE	6Mbps	ENVIRONMENTAL CONDITIONS	21deg. C, 68%RH, 991hPa
TESTED BY	Dean Wang	INPUT POWER (SYSTEM)	120Vac, 60 Hz

No	Freq. [MHz]	Corr.	Reading Value		Emission Level		Limit		Margin	
		Factor	[dB (uV)]		[dB (uV)]		[dB (uV)]		(dB)	
		(dB)	Q.P.	AV.	Q.P.	AV.	Q.P.	AV.	Q.P.	AV.
1	0.181	0.21	46.29	-	46.50	-	64.43	54.43	-17.93	-
2	0.267	0.21	38.93	-	39.14	-	61.20	51.20	-22.06	-
3	0.966	0.24	32.30	-	32.54	-	56.00	46.00	-23.46	-
4	3.719	0.37	27.35	-	27.72	-	56.00	46.00	-28.28	-
5	10.773	0.57	34.75	-	35.32	-	60.00	50.00	-24.68	-
6	14.348	0.72	31.59	-	32.31	-	60.00	50.00	-27.69	-

- REMARKS:**
1. Q.P. and AV. are abbreviations of quasi-peak and average individually.
 2. "-": The Quasi-peak reading value also meets average limit and measurement with the average detector is unnecessary.
 3. The emission levels of other frequencies were very low against the limit.
 4. Margin value = Emission level - Limit value
 5. Correction factor = Insertion loss + Cable loss
 6. Emission Level = Correction Factor + Reading Value.

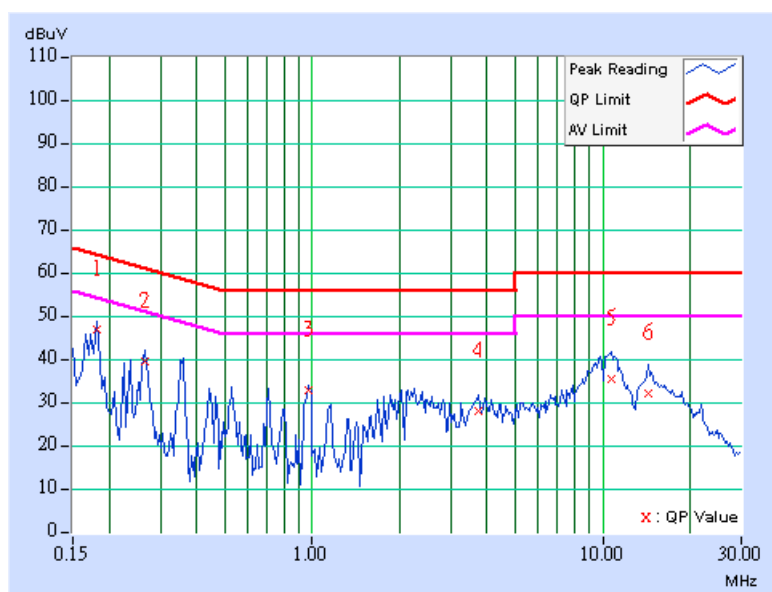

EUT TEST CONDITION		MEASUREMENT DETAIL	
CHANNEL	Channel 11	PHASE	Line 2
MODULATION TYPE	BPSK	6dB BANDWIDTH	9 kHz
TRANSFER RATE	6Mbps	ENVIRONMENTAL CONDITIONS	21deg. C, 68%RH, 991hPa
TESTED BY	Dean Wang	INPUT POWER (SYSTEM)	120Vac, 60 Hz

No	Freq. [MHz]	Corr. Factor (dB)	Reading Value		Emission Level		Limit		Margin	
			[dB (uV)]		[dB (uV)]		[dB (uV)]		(dB)	
			Q.P.	AV.	Q.P.	AV.	Q.P.	AV.	Q.P.	AV.
1	0.177	0.21	48.75	-	48.96	-	64.61	54.61	-15.65	-
2	0.349	0.21	37.84	-	38.05	-	58.98	48.98	-20.93	-
3	0.963	0.24	32.70	-	32.94	-	56.00	46.00	-23.06	-
4	2.367	0.28	28.30	-	28.58	-	56.00	46.00	-27.42	-
5	10.570	0.53	34.40	-	34.93	-	60.00	50.00	-25.07	-
6	14.691	0.46	30.91	-	31.37	-	60.00	50.00	-28.63	-

- REMARKS:**
1. Q.P. and AV. are abbreviations of quasi-peak and average individually.
 2. "-": The Quasi-peak reading value also meets average limit and measurement with the average detector is unnecessary.
 3. The emission levels of other frequencies were very low against the limit.
 4. Margin value = Emission level - Limit value
 5. Correction factor = Insertion loss + Cable loss
 6. Emission Level = Correction Factor + Reading Value.

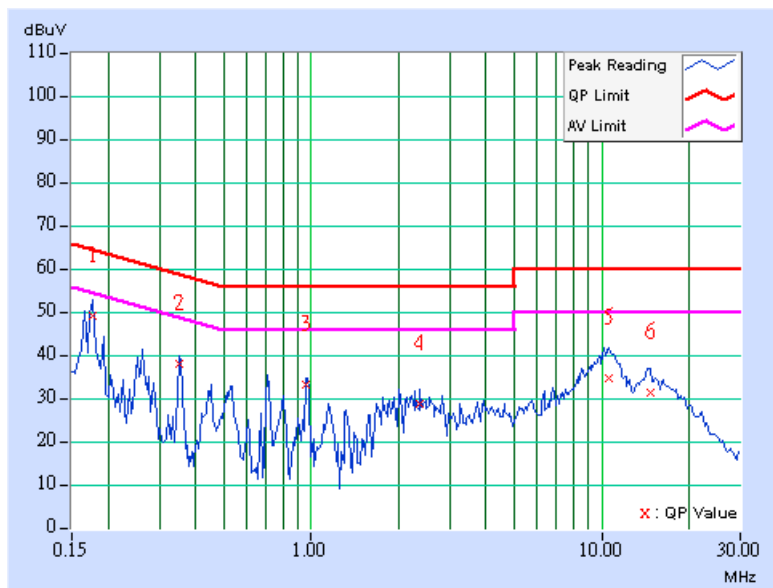

4.2 RADIATED EMISSION MEASUREMENT

4.2.1 LIMITS OF RADIATED EMISSION MEASUREMENT

Emissions radiated outside of the specified bands, shall be according to the general radiated limits in 15.209 as following:

Frequencies (MHz)	Field strength (microvolts/meter)	Measurement distance (meters)
0.009-0.490	2400/F(kHz)	300
0.490-1.705	24000/F(kHz)	30
1.705-30.0	30	30
30-88	100	3
88-216	150	3
216-960	200	3
Above 960	500	3

NOTE:

1. The lower limit shall apply at the transition frequencies.
2. Emission level (dBuV/m) = 20 log Emission level (uV/m).
3. As shown in 15.35(b), for frequencies above 1000MHz, the field strength limits are based on average detector, however, the peak field strength of any emission shall not exceed the maximum permitted average limits, specified above by more than 20dB under any condition of modulation.



4.2.2 TEST INSTRUMENTS

DESCRIPTION & MANUFACTURER	MODEL NO.	SERIAL NO.	CALIBRATED UNTIL
Test Receiver ROHDE & SCHWARZ	ESIB7	100212	May. 08, 2007
Spectrum Analyzer ROHDE & SCHWARZ	FSP40	100269	Aug. 07, 2007
BILOG Antenna SCHWARZBECK	VULB9168	9168-153	Jan. 04, 2008
HORN Antenna SCHWARZBECK	BBHA 9120 D	9120D-563	Jul. 26, 2007
HORN Antenna SCHWARZBECK	BBHA 9170	BBHA9170242	Jan. 19, 2007
Preamplifier Agilent	8449B	3008A01911	Sep. 13, 2007
Preamplifier Agilent	8447D	2944A10638	Dec. 20, 2007
RF signal cable HUBER+SUHNNER	SUCOFLEX 104	218188/218189	Nov. 14, 2007
RF signal cable Worken	8D-FB	Cable-HYCH9-01	Mar. 08, 2007
Software	ADT_Radiated_V7.6	NA	NA
Antenna Tower EMCO	2070/2080	512.835.4684	NA
Turn Table EMCO	2087-2.03	NA	NA
Antenna Tower & Turn Table Controller EMCO	2090	NA	NA

- NOTE:**
1. The calibration interval of the above test instruments is 12 months and the calibrations are traceable to NML/ROC and NIST/USA.
 2. The test was performed in HwaYa Chamber 9.
 3. The horn antenna and HP preamplifier (model: 8449B) are used only for the measurement of emission frequency above 1GHz if tested.
 4. The IC Site Registration No. is IC4924A-9.

4.2.3 TEST PROCEDURES

- a. The EUT was placed on the top of a rotating table 0.8 meters above the ground at a 3 meter semi-anechoic chamber. The table was rotated 360 degrees to determine the position of the highest radiation.
- b. The EUT was set 3 meters away from the interference-receiving antenna, which was mounted on the top of a variable-height antenna tower.
- c. The antenna is a broadband antenna, and its height is varied from one meter to four meters above the ground to determine the maximum value of the field strength. Both horizontal and vertical polarizations of the antenna are set to make the measurement.
- d. For each suspected emission, the EUT was arranged to its worst case and then the antenna was tuned to heights from 1 meter to 4 meters and the rotatable table was turned from 0 degrees to 360 degrees to find the maximum reading.
- e. The test-receiver system was set to Peak Detect Function and Specified Bandwidth with Maximum Hold Mode.
- f. If the emission level of the EUT in peak mode was 10 dB lower than the limit specified, then testing could be stopped and the peak values of the EUT would be reported. Otherwise the emissions that did not have 10 dB margin would be re-tested one by one using the quasi-peak method or average method as specified and then reported in Data sheet peak mode and QP mode.

NOTE:

1. The resolution bandwidth and video bandwidth of test receiver/spectrum analyzer is 120kHz for Quasi-peak detection at frequency below 1GHz.
2. The resolution bandwidth of test receiver/spectrum analyzer is 1 MHz and video bandwidth is 3MHz for Peak detection at frequency above 1GHz.
3. The resolution bandwidth of test receiver/spectrum analyzer is 1 MHz and the video bandwidth is 10Hz for Average detection (AV) at frequency above 1GHz.

4.2.4 DEVIATION FROM TEST STANDARD

No deviation

4.2.5 TEST SETUP

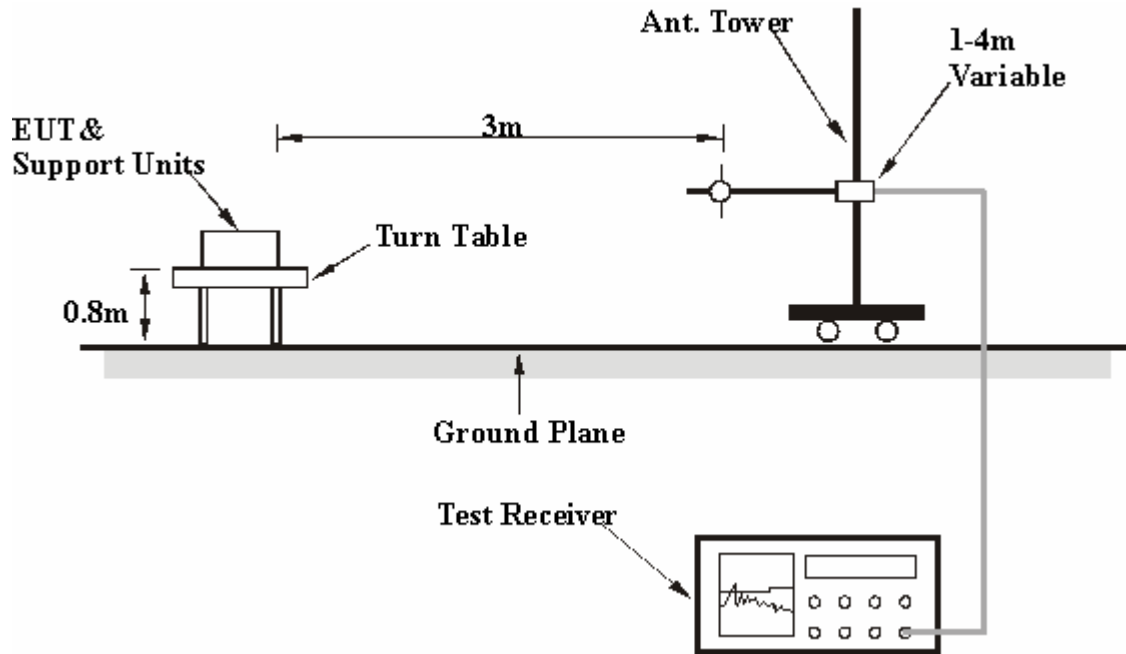

For the actual test configuration, please refer to the attached file (Test Setup Photo).

4.2.6 EUT OPERATING CONDITIONS

Same as 4.1.6

4.2.7 TEST RESULTS

RADIATED WORST-CASE DATA: BELOW 1GHz FOR TEST MODE A (WITH MONOPOLE ANTENNA):

EUT TEST CONDITION		MEASUREMENT DETAIL	
CHANNEL	Channel 11	FREQUENCY RANGE	Below 1000MHz
MODULATION TYPE	BPSK	DETECTOR FUNCTION	Quasi-Peak
TRANSFER RATE	6Mbps	ENVIRONMENTAL CONDITIONS	23deg. C, 69%RH, 991hPa
TESTED BY	Lori Chiu	INPUT POWER (SYSTEM)	120Vac, 60 Hz

ANTENNA POLARITY & TEST DISTANCE: HORIZONTAL AT 3 M								
No.	Freq. (MHz)	Emission Level (dBuV/m)	Limit (dBuV/m)	Margin (dB)	Antenna Height (m)	Table Angle (Degree)	Raw Value (dBuV)	Correction Factor (dB/m)
1	119.42	32.95 QP	43.50	-10.55	1.50 H	340	21.45	11.50
2	133.03	36.32 QP	43.50	-7.18	1.00 H	244	24.27	12.05
3	199.12	41.70 QP	43.50	-1.80	1.00 H	244	31.31	10.39
4	239.94	31.64 QP	46.00	-14.36	2.00 H	70	19.53	12.10
5	465.43	32.82 QP	46.00	-13.18	1.50 H	286	15.13	17.69
6	720.08	32.07 QP	46.00	-13.93	1.00 H	229	9.59	22.47
7	799.78	32.92 QP	46.00	-13.08	1.50 H	208	8.56	24.36

ANTENNA POLARITY & TEST DISTANCE: VERTICAL AT 3 M								
No.	Freq. (MHz)	Emission Level (dBuV/m)	Limit (dBuV/m)	Margin (dB)	Antenna Height (m)	Table Angle (Degree)	Raw Value (dBuV)	Correction Factor (dB/m)
1	115.53	27.96 QP	43.50	-15.54	1.50 V	343	16.94	11.03
2	134.97	27.21 QP	43.50	-16.29	1.00 V	142	15.09	12.12
3	199.12	31.24 QP	43.50	-12.26	1.00 V	268	20.84	10.39
4	465.43	33.82 QP	46.00	-12.18	1.00 V	142	16.13	17.69
5	799.78	29.34 QP	46.00	-16.66	1.00 V	73	4.98	24.36
6	863.93	30.15 QP	46.00	-15.85	1.50 V	13	5.18	24.98
7	933.91	29.04 QP	46.00	-16.96	1.00 V	136	3.44	25.60

- REMARKS:**
1. Emission level(dBuV/m)=Raw Value(dBuV) + Correction Factor(dB/m)
 2. Correction Factor(dB/m) = Antenna Factor (dB/m) + Cable Factor (dB)
 3. The other emission levels were very low against the limit.
 4. Margin value = Emission level – Limit value.

FOR TEST MODE B (WITH CHIP ANTENNA):

EUT TEST CONDITION		MEASUREMENT DETAIL	
CHANNEL	Channel 11	FREQUENCY RANGE	Below 1000MHz
MODULATION TYPE	BPSK	DETECTOR FUNCTION	Quasi-Peak
TRANSFER RATE	6Mbps	ENVIRONMENTAL CONDITIONS	23deg. C, 69%RH, 991hPa
TESTED BY	Lori Chiu	INPUT POWER (SYSTEM)	120Vac, 60 Hz

ANTENNA POLARITY & TEST DISTANCE: HORIZONTAL AT 3 M								
No.	Freq. (MHz)	Emission Level (dBuV/m)	Limit (dBuV/m)	Margin (dB)	Antenna Height (m)	Table Angle (Degree)	Raw Value (dBuV)	Correction Factor (dB/m)
1	119.42	35.41 QP	43.50	-8.09	3.00 H	292	23.92	11.50
2	133.03	34.21 QP	43.50	-9.29	2.50 H	76	22.17	12.05
3	181.62	29.58 QP	43.50	-13.92	3.00 H	307	17.69	11.89
4	199.12	40.28 QP	43.50	-3.22	2.50 H	76	29.89	10.39
5	399.34	34.41 QP	46.00	-11.59	3.00 H	319	18.72	15.69
6	720.08	31.93 QP	46.00	-14.07	1.50 H	262	9.46	22.47
7	931.96	35.45 QP	46.00	-10.55	3.00 H	292	9.87	25.58

ANTENNA POLARITY & TEST DISTANCE: VERTICAL AT 3 M								
No.	Freq. (MHz)	Emission Level (dBuV/m)	Limit (dBuV/m)	Margin (dB)	Antenna Height (m)	Table Angle (Degree)	Raw Value (dBuV)	Correction Factor (dB/m)
1	49.44	27.25 QP	40.00	-12.75	1.00 V	40	13.71	13.54
2	66.93	26.98 QP	40.00	-13.02	1.00 V	244	15.02	11.96
3	115.53	33.49 QP	43.50	-10.01	1.00 V	40	22.47	11.03
4	199.12	33.75 QP	43.50	-9.75	1.00 V	244	23.36	10.39
5	500.42	31.38 QP	46.00	-14.62	1.00 V	301	12.62	18.76
6	931.96	33.27 QP	46.00	-12.73	1.00 V	40	7.69	25.58

- REMARKS:**
1. Emission level(dBuV/m)=Raw Value(dBuV) + Correction Factor(dB/m)
 2. Correction Factor(dB/m) = Antenna Factor (dB/m) + Cable Factor (dB)
 3. The other emission levels were very low against the limit.
 4. Margin value = Emission level – Limit value.

**802.11b DSSS MODULATION
FOR TEST MODE A (WITH MONOPOLE ANTENNA):**

EUT TEST CONDITION		MEASUREMENT DETAIL	
CHANNEL	Channel 1	FREQUENCY RANGE	1 ~ 25GHz
MODULATION TYPE	DBPSK	DETECTOR FUNCTION	Peak(PK) Average (AV)
TRANSFER RATE	1Mbps	ENVIRONMENTAL CONDITIONS	24deg. C, 61%RH, 991hPa
TESTED BY	Match Tsui	INPUT POWER (SYSTEM)	120Vac, 60 Hz

ANTENNA POLARITY & TEST DISTANCE: HORIZONTAL AT 3 M

No.	Freq. (MHz)	Emission Level (dBuV/m)	Limit (dBuV/m)	Margin (dB)	Antenna Height (m)	Table Angle (Degree)	Raw Value (dBuV)	Correction Factor (dB/m)
1	2390.00	53.61 PK	74.00	-20.39	1.40 H	360	22.40	31.21
2	2390.00	44.41 AV	54.00	-9.59	1.40 H	360	13.20	31.21
3	*2412.00	102.54 PK			1.40 H	360	71.34	31.20
4	*2412.00	98.00 AV			1.40 H	360	66.80	31.20
5	4824.00	47.84 PK	74.00	-26.16	1.22 H	112	11.41	36.42
6	4824.00	41.95 AV	54.00	-12.05	1.22 H	112	5.52	36.42

ANTENNA POLARITY & TEST DISTANCE: VERTICAL AT 3 M

No.	Freq. (MHz)	Emission Level (dBuV/m)	Limit (dBuV/m)	Margin (dB)	Antenna Height (m)	Table Angle (Degree)	Raw Value (dBuV)	Correction Factor (dB/m)
1	2386.00	54.93 PK	74.00	-19.07	1.04 V	78	23.72	31.21
2	2386.00	46.42 AV	54.00	-7.58	1.04 V	78	15.21	31.21
3	*2412.00	108.79 PK			1.04 V	78	77.59	31.20
4	*2412.00	104.27 AV			1.04 V	78	73.07	31.20
5	4824.00	52.39 PK	74.00	-21.61	1.08 V	315	15.96	36.42
6	4824.00	49.37 AV	54.00	-4.63	1.08 V	315	12.94	36.42

- REMARKS:**
1. Emission level(dBuV/m)=Raw Value(dBuV) + Correction Factor(dB/m)
 2. Correction Factor(dB/m) = Antenna Factor (dB/m) + Cable Factor (dB)
 3. The other emission levels were very low against the limit.
 4. Margin value = Emission level – Limit value.
 5. “ * “ : Fundamental frequency

EUT TEST CONDITION		MEASUREMENT DETAIL	
CHANNEL	Channel 6	FREQUENCY RANGE	1 ~ 25GHz
MODULATION TYPE	DBPSK	DETECTOR FUNCTION	Peak(PK) Average (AV)
TRANSFER RATE	1Mbps	ENVIRONMENTAL CONDITIONS	24deg. C, 61%RH, 991hPa
TESTED BY	Match Tsui	INPUT POWER (SYSTEM)	120Vac, 60 Hz

ANTENNA POLARITY & TEST DISTANCE: HORIZONTAL AT 3 M								
No.	Freq. (MHz)	Emission Level (dBuV/m)	Limit (dBuV/m)	Margin (dB)	Antenna Height (m)	Table Angle (Degree)	Raw Value (dBuV)	Correction Factor (dB/m)
1	*2437.00	102.42 PK			1.33 H	345	71.21	31.21
2	*2437.00	98.11 AV			1.33 H	345	66.90	31.21
3	4874.00	47.68 PK	74.00	-26.32	1.03 H	241	11.15	36.53
4	4874.00	41.61 AV	54.00	-12.39	1.03 H	241	5.08	36.53

ANTENNA POLARITY & TEST DISTANCE: VERTICAL AT 3 M								
No.	Freq. (MHz)	Emission Level (dBuV/m)	Limit (dBuV/m)	Margin (dB)	Antenna Height (m)	Table Angle (Degree)	Raw Value (dBuV)	Correction Factor (dB/m)
1	*2437.00	108.16 PK			1.05 V	293	76.95	31.21
2	*2437.00	103.63 AV			1.05 V	293	72.42	31.21
3	4874.00	53.40 PK	74.00	-20.60	1.05 V	207	16.87	36.53
4	4874.00	49.90 AV	54.00	-4.10	1.05 V	207	13.37	36.53

- REMARKS:**
1. Emission level(dBuV/m)=Raw Value(dBuV) + Correction Factor(dB/m)
 2. Correction Factor(dB/m) = Antenna Factor (dB/m) + Cable Factor (dB)
 3. The other emission levels were very low against the limit.
 4. Margin value = Emission level – Limit value.
 5. “ * “ : Fundamental frequency

EUT TEST CONDITION		MEASUREMENT DETAIL	
CHANNEL	Channel 11	FREQUENCY RANGE	1 ~ 25GHz
MODULATION TYPE	DBPSK	DETECTOR FUNCTION	Peak(PK) Average (AV)
TRANSFER RATE	1Mbps	ENVIRONMENTAL CONDITIONS	24deg. C, 61%RH, 991hPa
TESTED BY	Match Tsui	INPUT POWER (SYSTEM)	120Vac, 60 Hz

ANTENNA POLARITY & TEST DISTANCE: HORIZONTAL AT 3 M								
No.	Freq. (MHz)	Emission Level (dBuV/m)	Limit (dBuV/m)	Margin (dB)	Antenna Height (m)	Table Angle (Degree)	Raw Value (dBuV)	Correction Factor (dB/m)
1	*2462.00	103.42 PK			1.21 H	120	72.20	31.22
2	*2462.00	98.86 AV			1.21 H	120	67.64	31.22
3	2483.50	54.93 PK	74.00	-19.07	1.21 H	120	23.70	31.23
4	2483.50	43.31 AV	54.00	-10.69	1.21 H	120	12.08	31.23
5	4924.00	48.24 PK	74.00	-25.76	1.02 H	112	11.61	36.63
6	4924.00	42.36 AV	54.00	-11.64	1.02 H	112	5.73	36.63

ANTENNA POLARITY & TEST DISTANCE: VERTICAL AT 3 M								
No.	Freq. (MHz)	Emission Level (dBuV/m)	Limit (dBuV/m)	Margin (dB)	Antenna Height (m)	Table Angle (Degree)	Raw Value (dBuV)	Correction Factor (dB/m)
1	*2462.00	109.27 PK			1.16 V	4	78.05	31.22
2	*2462.00	104.78 AV			1.16 V	4	73.56	31.22
3	2483.50	60.78 PK	74.00	-13.22	1.15 V	13	29.55	31.23
4	2483.50	49.23 AV	54.00	-4.77	1.15 V	13	18.00	31.23
5	4924.00	52.57 PK	74.00	-21.43	1.07 V	57	15.93	36.63
6	4924.00	49.09 AV	54.00	-4.91	1.07 V	57	12.45	36.63

- REMARKS:**
1. Emission level(dBuV/m)=Raw Value(dBuV) + Correction Factor(dB/m)
 2. Correction Factor(dB/m) = Antenna Factor (dB/m) + Cable Factor (dB)
 3. The other emission levels were very low against the limit.
 4. Margin value = Emission level – Limit value.
 5. “ * “ : Fundamental frequency

FOR TEST MODE B (WITH CHIP ANTENNA):

EUT TEST CONDITION		MEASUREMENT DETAIL	
CHANNEL	Channel 1	FREQUENCY RANGE	1 ~ 25GHz
MODULATION TYPE	DBPSK	DETECTOR FUNCTION	Peak(PK) Average (AV)
TRANSFER RATE	1Mbps	ENVIRONMENTAL CONDITIONS	24deg. C, 61%RH, 991hPa
TESTED BY	Match Tsui	INPUT POWER (SYSTEM)	120Vac, 60 Hz

ANTENNA POLARITY & TEST DISTANCE: HORIZONTAL AT 3 M								
No.	Freq. (MHz)	Emission Level (dBuV/m)	Limit (dBuV/m)	Margin (dB)	Antenna Height (m)	Table Angle (Degree)	Raw Value (dBuV)	Correction Factor (dB/m)
1	2386.00	56.73 PK	74.00	-17.27	1.33 H	232	25.52	31.21
2	2386.00	45.92 AV	54.00	-8.08	1.33 H	232	14.71	31.21
3	*2412.00	105.15 PK			1.32 H	231	73.95	31.20
4	*2412.00	100.57 AV			1.32 H	231	69.37	31.20
5	4824.00	48.45 PK	74.00	-25.55	1.06 H	198	12.02	36.42
6	4824.00	41.51 AV	54.00	-12.49	1.06 H	198	5.08	36.42

ANTENNA POLARITY & TEST DISTANCE: VERTICAL AT 3 M								
No.	Freq. (MHz)	Emission Level (dBuV/m)	Limit (dBuV/m)	Margin (dB)	Antenna Height (m)	Table Angle (Degree)	Raw Value (dBuV)	Correction Factor (dB/m)
1	2386.00	60.12 PK	74.00	-13.88	1.07 V	293	28.91	31.21
2	2386.00	48.20 AV	54.00	-5.80	1.07 V	293	16.99	31.21
3	*2412.00	109.02 PK			1.07 V	279	77.82	31.20
4	*2412.00	104.62 AV			1.07 V	279	73.42	31.20
5	4824.00	49.68 PK	74.00	-24.32	1.28 V	227	13.25	36.42
6	4824.00	44.45 AV	54.00	-9.55	1.28 V	227	8.02	36.42

- REMARKS:**
1. Emission level(dBuV/m)=Raw Value(dBuV) + Correction Factor(dB/m)
 2. Correction Factor(dB/m) = Antenna Factor (dB/m) + Cable Factor (dB)
 3. The other emission levels were very low against the limit.
 4. Margin value = Emission level – Limit value.
 5. “ * “ : Fundamental frequency

EUT TEST CONDITION		MEASUREMENT DETAIL	
CHANNEL	Channel 6	FREQUENCY RANGE	1 ~ 25GHz
MODULATION TYPE	DBPSK	DETECTOR FUNCTION	Peak(PK) Average (AV)
TRANSFER RATE	1Mbps	ENVIRONMENTAL CONDITIONS	24deg. C, 61%RH, 991hPa
TESTED BY	Match Tsui	INPUT POWER (SYSTEM)	120Vac, 60 Hz

ANTENNA POLARITY & TEST DISTANCE: HORIZONTAL AT 3 M								
No.	Freq. (MHz)	Emission Level (dBuV/m)	Limit (dBuV/m)	Margin (dB)	Antenna Height (m)	Table Angle (Degree)	Raw Value (dBuV)	Correction Factor (dB/m)
1	*2437.00	105.63 PK			1.12 H	176	74.42	31.21
2	*2437.00	100.16 AV			1.12 H	176	68.95	31.21
3	4874.00	48.28 PK	74.00	-25.72	1.16 H	200	11.75	36.53
4	4874.00	40.25 AV	54.00	-13.75	1.16 H	200	3.72	36.53

ANTENNA POLARITY & TEST DISTANCE: VERTICAL AT 3 M								
No.	Freq. (MHz)	Emission Level (dBuV/m)	Limit (dBuV/m)	Margin (dB)	Antenna Height (m)	Table Angle (Degree)	Raw Value (dBuV)	Correction Factor (dB/m)
1	*2437.00	109.24 PK			1.04 V	290	78.03	31.21
2	*2437.00	104.82 AV			1.04 V	290	73.61	31.21
3	4874.00	49.93 PK	74.00	-24.07	1.18 V	141	13.40	36.53
4	4874.00	44.28 AV	54.00	-9.72	1.18 V	141	7.75	36.53

- REMARKS:**
1. Emission level(dBuV/m)=Raw Value(dBuV) + Correction Factor(dB/m)
 2. Correction Factor(dB/m) = Antenna Factor (dB/m) + Cable Factor (dB)
 3. The other emission levels were very low against the limit.
 4. Margin value = Emission level – Limit value.
 5. “ * “ : Fundamental frequency

EUT TEST CONDITION		MEASUREMENT DETAIL	
CHANNEL	Channel 11	FREQUENCY RANGE	1 ~ 25GHz
MODULATION TYPE	DBPSK	DETECTOR FUNCTION	Peak(PK) Average (AV)
TRANSFER RATE	1Mbps	ENVIRONMENTAL CONDITIONS	24deg. C, 61%RH, 991hPa
TESTED BY	Match Tsui	INPUT POWER (SYSTEM)	120Vac, 60 Hz

ANTENNA POLARITY & TEST DISTANCE: HORIZONTAL AT 3 M								
No.	Freq. (MHz)	Emission Level (dBuV/m)	Limit (dBuV/m)	Margin (dB)	Antenna Height (m)	Table Angle (Degree)	Raw Value (dBuV)	Correction Factor (dB/m)
1	*2462.00	105.73 PK			1.16 H	184	74.51	31.22
2	*2462.00	100.60 AV			1.16 H	184	69.38	31.22
3	2483.50	56.99 PK	74.00	-17.01	1.16 H	184	25.76	31.23
4	2483.50	46.05 AV	54.00	-7.95	1.16 H	184	14.82	31.23
5	4924.00	48.84 PK	74.00	-25.16	1.10 H	201	12.21	36.63
6	4924.00	41.79 AV	54.00	-12.21	1.10 H	201	5.16	36.63

ANTENNA POLARITY & TEST DISTANCE: VERTICAL AT 3 M								
No.	Freq. (MHz)	Emission Level (dBuV/m)	Limit (dBuV/m)	Margin (dB)	Antenna Height (m)	Table Angle (Degree)	Raw Value (dBuV)	Correction Factor (dB/m)
1	*2462.00	109.56 PK			1.15 V	149	78.34	31.22
2	*2462.00	105.08 AV			1.15 V	149	73.86	31.22
3	2483.50	58.35 PK	74.00	-15.65	1.16 V	148	27.12	31.23
4	2483.50	48.32 AV	54.00	-5.68	1.16 V	148	17.09	31.23
5	4924.00	50.35 PK	74.00	-23.65	1.17 V	115	13.72	36.63
6	4924.00	44.43 AV	54.00	-9.57	1.17 V	115	7.80	36.63

- REMARKS:**
1. Emission level(dBuV/m)=Raw Value(dBuV) + Correction Factor(dB/m)
 2. Correction Factor(dB/m) = Antenna Factor (dB/m) + Cable Factor (dB)
 3. The other emission levels were very low against the limit.
 4. Margin value = Emission level – Limit value.
 5. “ * “ : Fundamental frequency

**802.11g OFDM MODULATION
FOR TEST MODE A (WITH MONOPOLE ANTENNA):**

EUT TEST CONDITION		MEASUREMENT DETAIL	
CHANNEL	Channel 1	FREQUENCY RANGE	1 ~ 25GHz
MODULATION TYPE	BPSK	DETECTOR FUNCTION	Peak(PK) Average (AV)
TRANSFER RATE	6Mbps	ENVIRONMENTAL CONDITIONS	24deg. C, 61%RH, 991hPa
TESTED BY	Match Tsui	INPUT POWER (SYSTEM)	120Vac, 60 Hz

ANTENNA POLARITY & TEST DISTANCE: HORIZONTAL AT 3 M								
No.	Freq. (MHz)	Emission Level (dBuV/m)	Limit (dBuV/m)	Margin (dB)	Antenna Height (m)	Table Angle (Degree)	Raw Value (dBuV)	Correction Factor (dB/m)
1	2390.00	63.12 PK	74.00	-10.88	1.35 H	308	31.91	31.21
2	2390.00	47.16 AV	54.00	-6.84	1.35 H	308	15.95	31.21
3	*2412.00	101.12 PK			1.35 H	308	69.92	31.20
4	*2412.00	92.37 AV			1.35 H	308	61.17	31.20
5	4824.00	43.34 PK	74.00	-30.66	1.10 H	156	6.91	36.42
6	4824.00	32.90 AV	54.00	-21.10	1.10 H	156	-3.53	36.42

ANTENNA POLARITY & TEST DISTANCE: VERTICAL AT 3 M								
No.	Freq. (MHz)	Emission Level (dBuV/m)	Limit (dBuV/m)	Margin (dB)	Antenna Height (m)	Table Angle (Degree)	Raw Value (dBuV)	Correction Factor (dB/m)
1	2390.00	68.84 PK	74.00	-5.16	1.07 V	78	37.63	31.21
2	2390.00	50.59 AV	54.00	-3.41	1.07 V	78	19.38	31.21
3	*2412.00	106.11 PK			1.05 V	75	74.91	31.20
4	*2412.00	97.28 AV			1.05 V	75	66.08	31.20
5	4824.00	45.79 PK	74.00	-28.21	1.10 V	349	9.36	36.42
6	4824.00	34.82 AV	54.00	-19.18	1.10 V	349	-1.61	36.42

- REMARKS:**
1. Emission level(dBuV/m)=Raw Value(dBuV) + Correction Factor(dB/m)
 2. Correction Factor(dB/m) = Antenna Factor (dB/m) + Cable Factor (dB)
 3. The other emission levels were very low against the limit.
 4. Margin value = Emission level – Limit value.
 5. “ * ” : Fundamental frequency

EUT TEST CONDITION		MEASUREMENT DETAIL	
CHANNEL	Channel 6	FREQUENCY RANGE	1 ~ 25GHz
MODULATION TYPE	BPSK	DETECTOR FUNCTION	Peak(PK) Average (AV)
TRANSFER RATE	6Mbps	ENVIRONMENTAL CONDITIONS	24deg. C, 61%RH, 991hPa
TESTED BY	Match Tsui	INPUT POWER (SYSTEM)	120Vac, 60 Hz

ANTENNA POLARITY & TEST DISTANCE: HORIZONTAL AT 3 M								
No.	Freq. (MHz)	Emission Level (dBuV/m)	Limit (dBuV/m)	Margin (dB)	Antenna Height (m)	Table Angle (Degree)	Raw Value (dBuV)	Correction Factor (dB/m)
1	*2437.00	101.21 PK			1.35 H	289	70.00	31.21
2	*2437.00	92.27 AV			1.35 H	289	61.06	31.21
3	4874.00	43.56 PK	74.00	-30.44	1.00 H	59	7.03	36.53
4	4874.00	32.97 AV	54.00	-21.03	1.00 H	59	-3.56	36.53

ANTENNA POLARITY & TEST DISTANCE: VERTICAL AT 3 M								
No.	Freq. (MHz)	Emission Level (dBuV/m)	Limit (dBuV/m)	Margin (dB)	Antenna Height (m)	Table Angle (Degree)	Raw Value (dBuV)	Correction Factor (dB/m)
1	*2437.00	107.31 PK			1.05 V	295	76.10	31.21
2	*2437.00	97.80 AV			1.05 V	295	66.59	31.21
3	4874.00	45.86 PK	74.00	-28.14	1.08 V	233	9.33	36.53
4	4874.00	34.90 AV	54.00	-19.10	1.08 V	233	-1.63	36.53

- REMARKS:**
1. Emission level(dBuV/m)=Raw Value(dBuV) + Correction Factor(dB/m)
 2. Correction Factor(dB/m) = Antenna Factor (dB/m) + Cable Factor (dB)
 3. The other emission levels were very low against the limit.
 4. Margin value = Emission level – Limit value.
 5. “ * “ : Fundamental frequency

EUT TEST CONDITION		MEASUREMENT DETAIL	
CHANNEL	Channel 11	FREQUENCY RANGE	1 ~ 25GHz
MODULATION TYPE	BPSK	DETECTOR FUNCTION	Peak(PK) Average (AV)
TRANSFER RATE	6Mbps	ENVIRONMENTAL CONDITIONS	24deg. C, 61%RH, 991hPa
TESTED BY	Match Tsui	INPUT POWER (SYSTEM)	120Vac, 60 Hz

ANTENNA POLARITY & TEST DISTANCE: HORIZONTAL AT 3 M								
No.	Freq. (MHz)	Emission Level (dBuV/m)	Limit (dBuV/m)	Margin (dB)	Antenna Height (m)	Table Angle (Degree)	Raw Value (dBuV)	Correction Factor (dB/m)
1	*2462.00	100.41 PK			1.34 H	308	69.19	31.22
2	*2462.00	91.49 AV			1.34 H	308	60.27	31.22
3	2483.50	60.08 PK	74.00	-13.92	1.34 H	308	28.85	31.23
4	2483.50	47.82 AV	54.00	-6.18	1.34 H	308	16.59	31.23
5	4924.00	43.31 PK	74.00	-30.69	1.00 H	360	6.67	36.63
6	4924.00	32.50 AV	54.00	-21.50	1.00 H	360	-4.14	36.63

ANTENNA POLARITY & TEST DISTANCE: VERTICAL AT 3 M								
No.	Freq. (MHz)	Emission Level (dBuV/m)	Limit (dBuV/m)	Margin (dB)	Antenna Height (m)	Table Angle (Degree)	Raw Value (dBuV)	Correction Factor (dB/m)
1	*2462.00	107.12 PK			1.40 V	13	75.90	31.22
2	*2462.00	98.05 AV			1.40 V	13	66.83	31.22
3	2483.50	71.23 PK	74.00	-2.77	1.39 V	24	40.00	31.23
4	2483.50	51.88 AV	54.00	-2.12	1.39 V	24	20.65	31.23
5	4924.00	46.23 PK	74.00	-27.77	1.07 V	360	9.59	36.63
6	4924.00	33.72 AV	54.00	-20.28	1.07 V	360	-2.92	36.63

- REMARKS:**
1. Emission level(dBuV/m)=Raw Value(dBuV) + Correction Factor(dB/m)
 2. Correction Factor(dB/m) = Antenna Factor (dB/m) + Cable Factor (dB)
 3. The other emission levels were very low against the limit.
 4. Margin value = Emission level – Limit value.
 5. “ * “ : Fundamental frequency

FOR TEST MODE B (WITH CHIP ANTENNA):

EUT TEST CONDITION		MEASUREMENT DETAIL	
CHANNEL	Channel 1	FREQUENCY RANGE	1 ~ 25GHz
MODULATION TYPE	BPSK	DETECTOR FUNCTION	Peak(PK) Average (AV)
TRANSFER RATE	6Mbps	ENVIRONMENTAL CONDITIONS	24deg. C, 61%RH, 991hPa
TESTED BY	Match Tsui	INPUT POWER (SYSTEM)	120Vac, 60 Hz

ANTENNA POLARITY & TEST DISTANCE: HORIZONTAL AT 3 M								
No.	Freq. (MHz)	Emission Level (dBuV/m)	Limit (dBuV/m)	Margin (dB)	Antenna Height (m)	Table Angle (Degree)	Raw Value (dBuV)	Correction Factor (dB/m)
1	2390.00	64.53 PK	74.00	-9.47	1.13 H	172	33.32	31.21
2	2390.00	48.66 AV	54.00	-5.34	1.13 H	172	17.45	31.21
3	*2412.00	103.67 PK			1.11 H	170	72.47	31.20
4	*2412.00	93.26 AV			1.11 H	170	62.06	31.20
5	4824.00	43.56 PK	74.00	-30.44	1.00 H	178	7.14	36.42
6	4824.00	32.87 AV	54.00	-21.13	1.00 H	178	-3.55	36.42

ANTENNA POLARITY & TEST DISTANCE: VERTICAL AT 3 M								
No.	Freq. (MHz)	Emission Level (dBuV/m)	Limit (dBuV/m)	Margin (dB)	Antenna Height (m)	Table Angle (Degree)	Raw Value (dBuV)	Correction Factor (dB/m)
1	2390.00	70.14 PK	74.00	-3.86	1.19 V	151	38.93	31.21
2	2390.00	52.98 AV	54.00	-1.02	1.19 V	151	21.77	31.21
3	*2412.00	108.78 PK			1.19 V	150	77.58	31.20
4	*2412.00	98.09 AV			1.19 V	150	66.89	31.20
5	4824.00	45.44 PK	74.00	-28.56	1.20 V	116	9.01	36.42
6	4824.00	34.23 AV	54.00	-19.77	1.20 V	116	-2.19	36.42

- REMARKS:**
1. Emission level(dBuV/m)=Raw Value(dBuV) + Correction Factor(dB/m)
 2. Correction Factor(dB/m) = Antenna Factor (dB/m) + Cable Factor (dB)
 3. The other emission levels were very low against the limit.
 4. Margin value = Emission level – Limit value.
 5. “ * “ : Fundamental frequency

EUT TEST CONDITION		MEASUREMENT DETAIL	
CHANNEL	Channel 6	FREQUENCY RANGE	1 ~ 25GHz
MODULATION TYPE	BPSK	DETECTOR FUNCTION	Peak(PK) Average (AV)
TRANSFER RATE	6Mbps	ENVIRONMENTAL CONDITIONS	24deg. C, 61%RH, 991hPa
TESTED BY	Match Tsui	INPUT POWER (SYSTEM)	120Vac, 60 Hz

ANTENNA POLARITY & TEST DISTANCE: HORIZONTAL AT 3 M								
No.	Freq. (MHz)	Emission Level (dBuV/m)	Limit (dBuV/m)	Margin (dB)	Antenna Height (m)	Table Angle (Degree)	Raw Value (dBuV)	Correction Factor (dB/m)
1	*2437.00	102.72 PK			1.09 H	182	71.51	31.21
2	*2437.00	92.46 AV			1.09 H	182	61.25	31.21
3	4874.00	43.87 PK	74.00	-30.13	1.18 H	261	7.34	36.53
4	4874.00	33.10 AV	54.00	-20.90	1.18 H	261	-3.43	36.53

ANTENNA POLARITY & TEST DISTANCE: VERTICAL AT 3 M								
No.	Freq. (MHz)	Emission Level (dBuV/m)	Limit (dBuV/m)	Margin (dB)	Antenna Height (m)	Table Angle (Degree)	Raw Value (dBuV)	Correction Factor (dB/m)
1	*2437.00	108.54 PK			1.06 V	303	77.33	31.21
2	*2437.00	98.22 AV			1.06 V	303	67.01	31.21
3	4874.00	45.54 PK	74.00	-28.46	1.56 V	274	9.01	36.53
4	4874.00	34.49 AV	54.00	-19.51	1.56 V	274	-2.04	36.53

- REMARKS:**
1. Emission level(dBuV/m)=Raw Value(dBuV) + Correction Factor(dB/m)
 2. Correction Factor(dB/m) = Antenna Factor (dB/m) + Cable Factor (dB)
 3. The other emission levels were very low against the limit.
 4. Margin value = Emission level – Limit value.
 5. “ * “ : Fundamental frequency

EUT TEST CONDITION		MEASUREMENT DETAIL	
CHANNEL	Channel 11	FREQUENCY RANGE	1 ~ 25GHz
MODULATION TYPE	BPSK	DETECTOR FUNCTION	Peak(PK) Average (AV)
TRANSFER RATE	6Mbps	ENVIRONMENTAL CONDITIONS	24deg. C, 61%RH, 991hPa
TESTED BY	Match Tsui	INPUT POWER (SYSTEM)	120Vac, 60 Hz

ANTENNA POLARITY & TEST DISTANCE: HORIZONTAL AT 3 M								
No.	Freq. (MHz)	Emission Level (dBuV/m)	Limit (dBuV/m)	Margin (dB)	Antenna Height (m)	Table Angle (Degree)	Raw Value (dBuV)	Correction Factor (dB/m)
1	*2462.00	102.46 PK			1.10 H	172	71.24	31.22
2	*2462.00	92.13 AV			1.10 H	172	60.91	31.22
3	2483.50	63.48 PK	74.00	-10.52	1.10 H	172	32.25	31.23
4	2483.50	46.79 AV	54.00	-7.21	1.10 H	172	15.56	31.23
5	4924.00	43.64 PK	74.00	-30.36	1.22 H	32	7.01	36.63
6	4924.00	32.90 AV	54.00	-21.10	1.22 H	32	-3.73	36.63

ANTENNA POLARITY & TEST DISTANCE: VERTICAL AT 3 M								
No.	Freq. (MHz)	Emission Level (dBuV/m)	Limit (dBuV/m)	Margin (dB)	Antenna Height (m)	Table Angle (Degree)	Raw Value (dBuV)	Correction Factor (dB/m)
1	*2462.00	108.28 PK			1.18 V	149	77.06	31.22
2	*2462.00	98.00 AV			1.18 V	149	66.78	31.22
3	2483.50	69.12 PK	74.00	-4.88	1.14 V	148	37.89	31.23
4	2483.50	50.35 AV	54.00	-3.65	1.14 V	148	19.12	31.23
5	4924.00	45.62 PK	74.00	-28.38	1.32 V	155	8.99	36.63
6	4924.00	34.36 AV	54.00	-19.64	1.32 V	155	-2.27	36.63

- REMARKS:**
1. Emission level(dBuV/m)=Raw Value(dBuV) + Correction Factor(dB/m)
 2. Correction Factor(dB/m) = Antenna Factor (dB/m) + Cable Factor (dB)
 3. The other emission levels were very low against the limit.
 4. Margin value = Emission level – Limit value.
 5. “ * “ : Fundamental frequency



4.3 6dB BANDWIDTH MEASUREMENT

4.3.1 LIMITS OF 6dB BANDWIDTH MEASUREMENT

The minimum of 6dB Bandwidth Measurement is 0.5 MHz.

4.3.2 TEST INSTRUMENTS

Description & Manufacturer	Model No.	Serial No.	Calibrated Until
SPECTRUM ANALYZER	FSP40	100040	Jun. 07, 2007

NOTE: The calibration interval of the above test instruments is 12 months and the calibrations are traceable to NML/ROC and NIST/USA.

4.3.3 TEST PROCEDURE

The transmitter output was connected to the spectrum analyzer through an attenuator. The bandwidth of the fundamental frequency was measured by spectrum analyzer with 100kHz RBW and 100kHz VBW. The 6dB bandwidth is defined as the total spectrum the power of which is higher than peak power minus 6dB.

4.3.4 DEVIATION FROM TEST STANDARD

No deviation

4.3.5 TEST SETUP

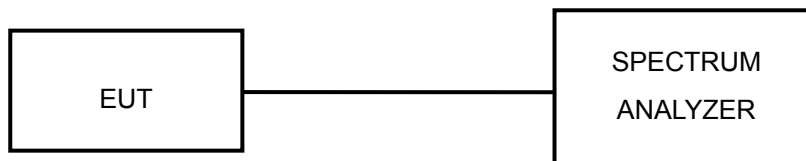

4.3.6 EUT OPERATING CONDITIONS

The software provided by client to enable the EUT under transmission condition continuously at lowest, middle and highest channel frequencies individually.

4.3.7 TEST RESULTS

802.11b DSSS MODULATION

MODULATION TYPE	DBPSK	TRANSFER RATE	1Mbps
INPUT POWER (SYSTEM)	120Vac, 60 Hz	ENVIRONMENTAL CONDITIONS	26deg. C, 66%RH, 991hPa
TESTED BY	Long Chen		

CHANNEL	CHANNEL FREQUENCY (MHz)	6dB BANDWIDTH (MHz)	MINIMUM LIMIT (MHz)	PASS/FAIL
1	2412	10.08	0.5	PASS
6	2437	10.08	0.5	PASS
11	2462	10.08	0.5	PASS

CH1

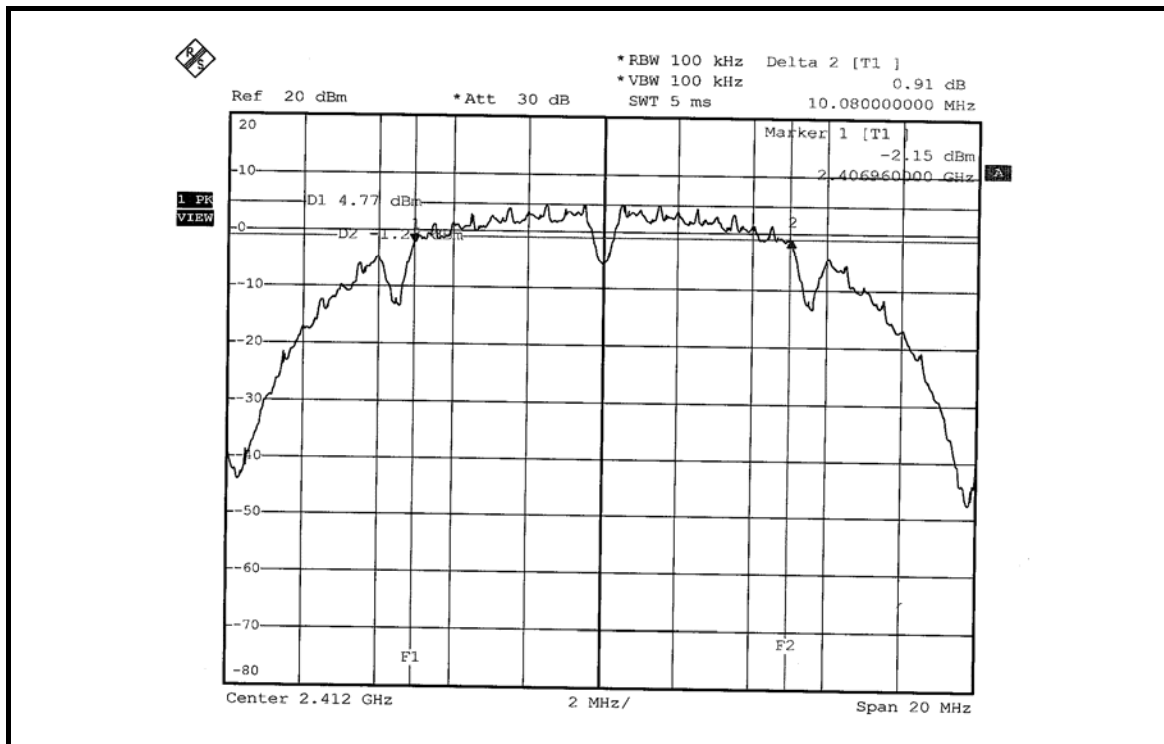

CH6

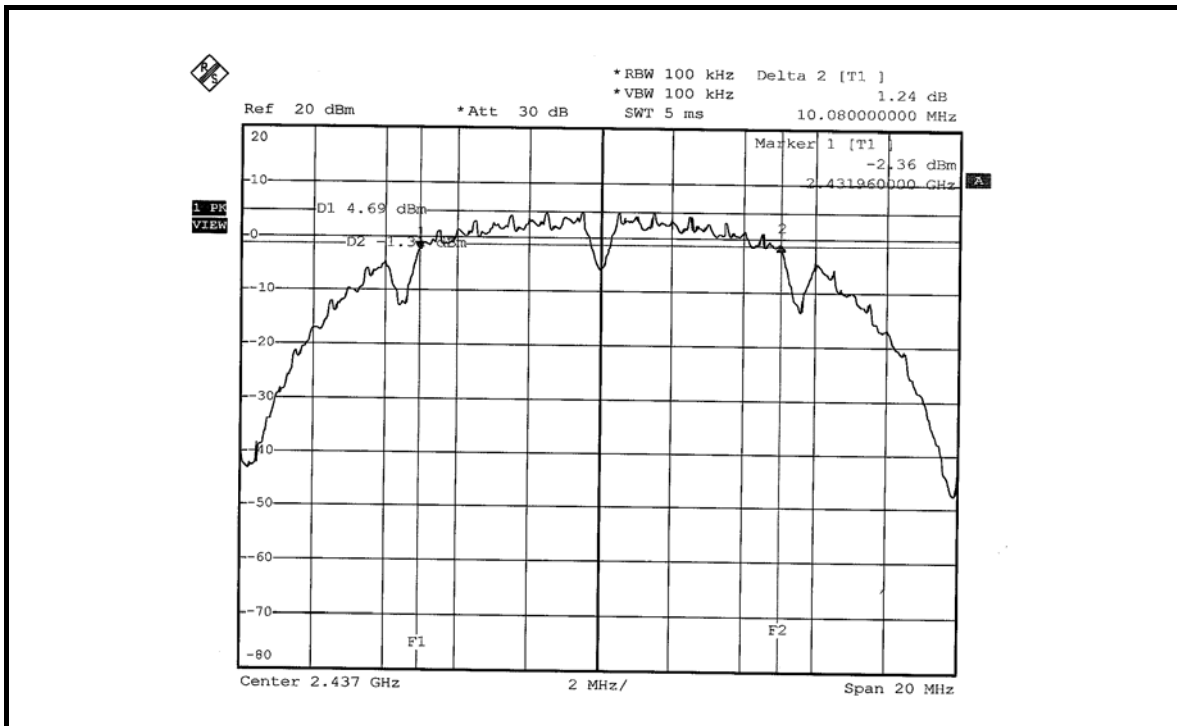

CH11

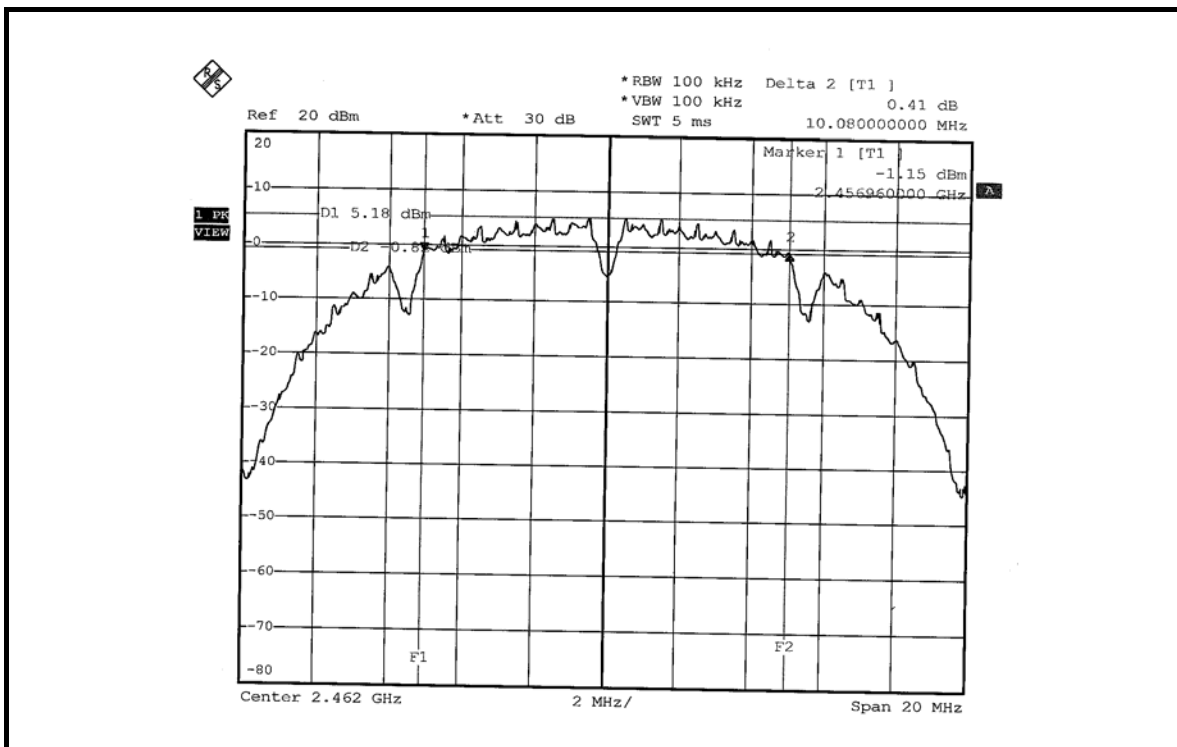

CH6

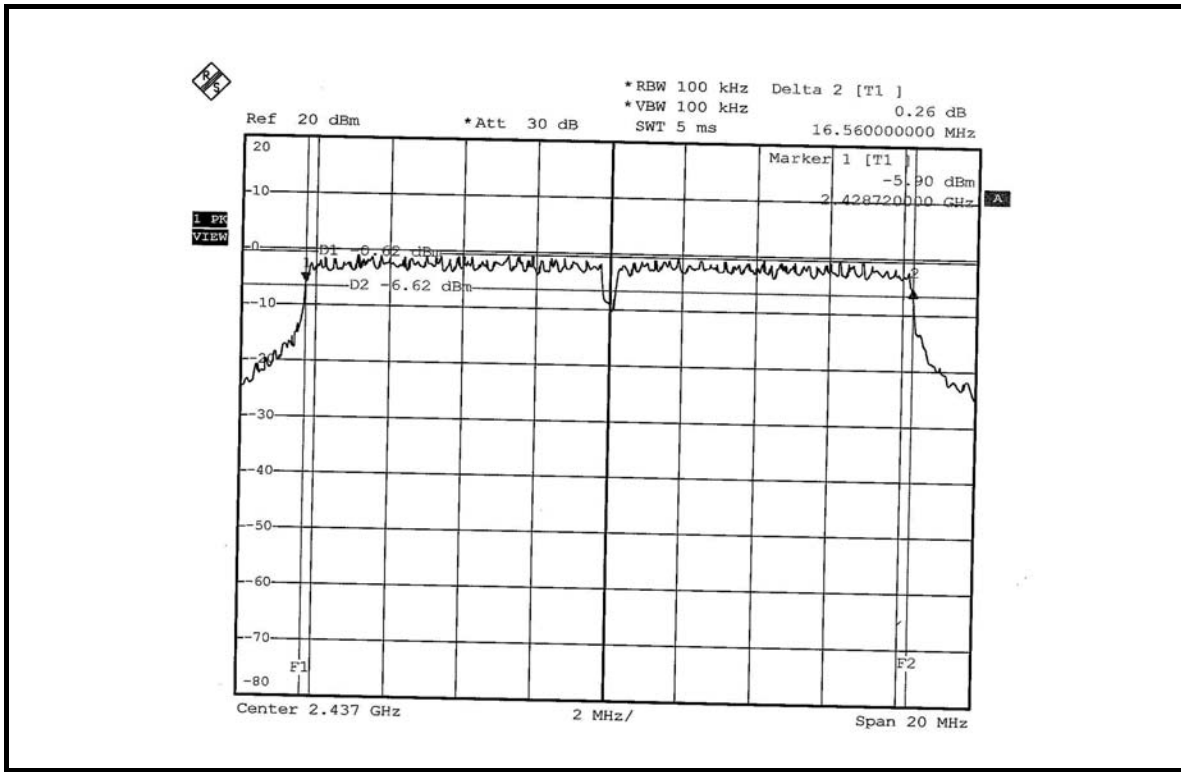

CH11

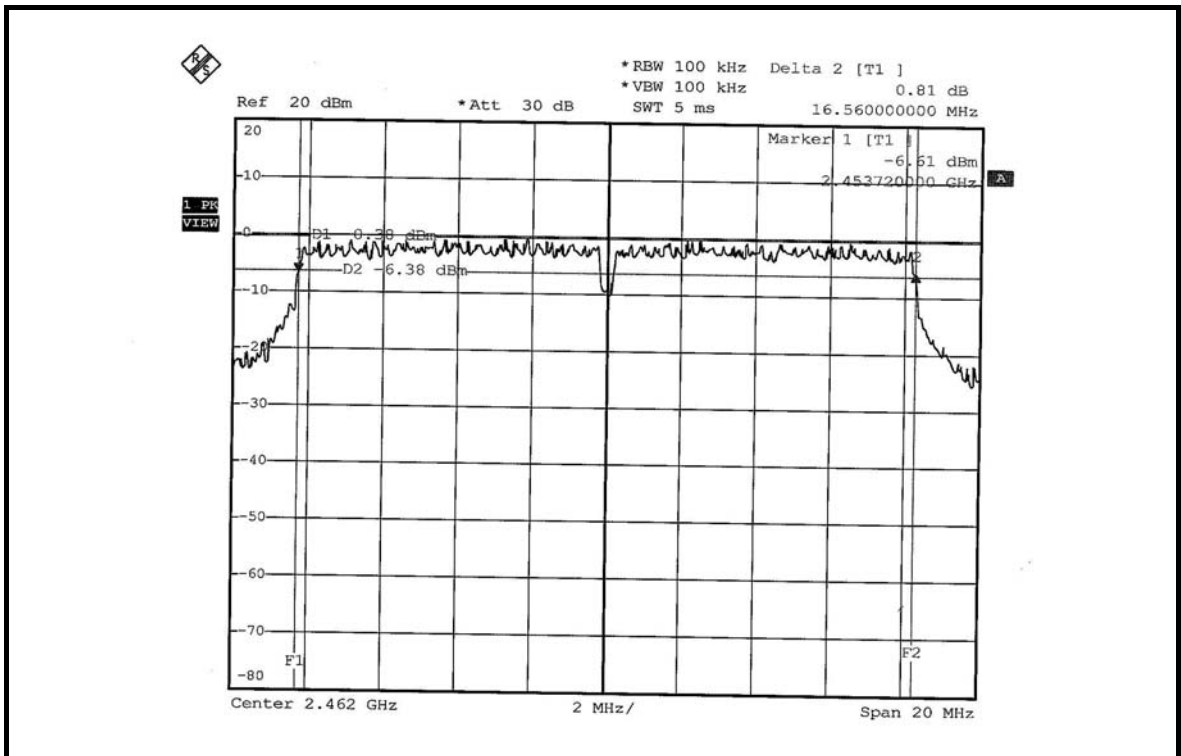



4.4 MAXIMUM PEAK OUTPUT POWER

4.4.1 LIMITS OF MAXIMUM PEAK OUTPUT POWER MEASUREMENT

The Maximum Peak Output Power Measurement is 30dBm.

4.4.2 INSTRUMENTS

Description & Manufacturer	Model No.	Serial No.	Calibrated Until
R&S SPECTRUM ANALYZER	FSP40	100040	Jun. 07, 2007
ANRITSU SYNTHESIZED SIGNAL GENERATOR	68247B	984703	May 08, 2007
TEKTRONIX OSCILLOSCOPE	TDS1012	C037299	Nov. 27, 2007
NARDA DETECTOR	4503A	FSCM99899	NA

NOTE: The calibration interval of the above test instruments is 12 months and the calibrations are traceable to NML/ROC and NIST/USA.

4.4.1 TEST PROCEDURES

A detector was used on the output port of the EUT. An oscilloscope was used to read the response of the detector.

2. Replaced the EUT by the signal generator. The center frequency of the S.G was adjusted to the center frequency of the measured channel.
3. Adjusted the power to have the same reading on oscilloscope. Record the power level.

4.4.2 DEVIATION FROM TEST STANDARD

No deviation

4.4.3 TEST SETUP



4.4.4 EUT OPERATING CONDITIONS

Same as Item 4.3.6



4.4.3 TEST RESULTS

802.11b DSSS MODULATION

MODULATION TYPE	DBPSK	TRANSFER RATE	1Mbps
INPUT POWER (SYSTEM)	120Vac, 60 Hz	ENVIRONMENTAL CONDITIONS	26deg. C, 66%RH, 991hPa
TESTED BY	Long Chen		

CHANNEL	CHANNEL FREQUENCY (MHz)	PEAK POWER OUTPUT (mW)	PEAK POWER OUTPUT (dBm)	PEAK POWER LIMIT (dBm)	PASS/FAIL
1	2412	50.816	17.06	30	PASS
6	2437	51.050	17.08	30	PASS
11	2462	50.582	17.04	30	PASS



802.11g OFDM MODULATION

MODULATION TYPE	BPSK	TRANSFER RATE	6Mbps
INPUT POWER (SYSTEM)	120Vac, 60 Hz	ENVIRONMENTAL CONDITIONS	26deg. C, 66%RH, 991hPa
TESTED BY	Long Chen		

CHANNEL	CHANNEL FREQUENCY (MHz)	PEAK POWER OUTPUT (mW)	PEAK POWER OUTPUT (dBm)	PEAK POWER LIMIT (dBm)	PASS/FAIL
1	2412	54.828	17.39	30	PASS
6	2437	54.325	17.35	30	PASS
11	2462	54.075	17.33	30	PASS



4.5 POWER SPECTRAL DENSITY MEASUREMENT

4.5.1 LIMITS OF POWER SPECTRAL DENSITY MEASUREMENT

The Maximum of Power Spectral Density Measurement is 8dBm.

4.5.2 TEST INSTRUMENTS

Description & Manufacturer	Model No.	Serial No.	Calibrated Until
R&S SPECTRUM ANALYZER	FSP40	100040	Jun. 07, 2007

NOTE:

The calibration interval of the above test instruments is 12 months and the calibrations are traceable to NML/ROC and NIST/USA.

4.5.3 TEST PROCEDURE

The transmitter output was connected to the spectrum analyzer through an attenuator, the bandwidth of the fundamental frequency was measured with the spectrum analyzer using 3kHz RBW and 30kHz VBW, set sweep time = span/3kHz. The power spectral density was measured and recorded. The sweep time is allowed to be longer than span/3kHz for a full response of the mixer in the spectrum analyzer.

4.5.4 DEVIATION FROM TEST STANDARD

No deviation

4.5.5 TEST SETUP

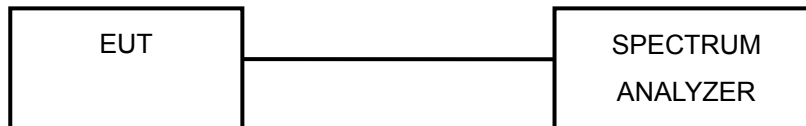

4.5.6 EUT OPERATING CONDITION

Same as Item 4.3.6

4.5.7 TEST RESULTS

802.11b DSSS MODULATION

MODULATION TYPE	DBPSK	TRANSFER RATE	1Mbps
INPUT POWER (SYSTEM)	120Vac, 60 Hz	ENVIRONMENTAL CONDITIONS	26deg. C, 66%RH, 991hPa
TESTED BY	Long Chen		

CHANNEL	CHANNEL FREQUENCY (MHz)	RF POWER LEVEL IN 3kHz BW (dBm)	MAXIMUM LIMIT (dBm)	PASS/FAIL
1	2412	-12.67	8	PASS
6	2437	-12.78	8	PASS
11	2462	-12.59	8	PASS

CH1

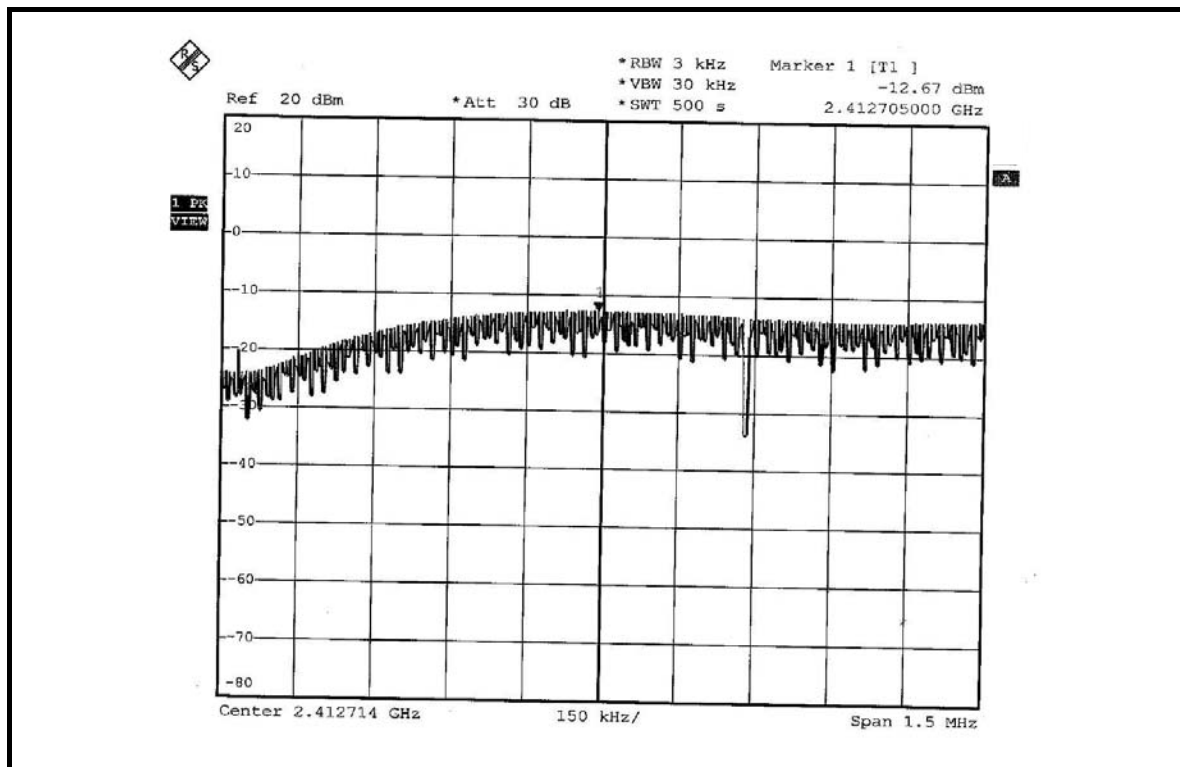

802.11g OFDM MODULATION

MODULATION TYPE	BPSK	TRANSFER RATE	6Mbps
INPUT POWER (SYSTEM)	120Vac, 60 Hz	ENVIRONMENTAL CONDITIONS	26deg. C, 66%RH, 991hPa
TESTED BY	Long Chen		

CHANNEL	CHANNEL FREQUENCY (MHz)	RF POWER LEVEL IN 3kHz BW (dBm)	MAXIMUM LIMIT (dBm)	PASS/FAIL
1	2412	-14.76	8	PASS
6	2437	-14.96	8	PASS
11	2462	-14.88	8	PASS

CH1

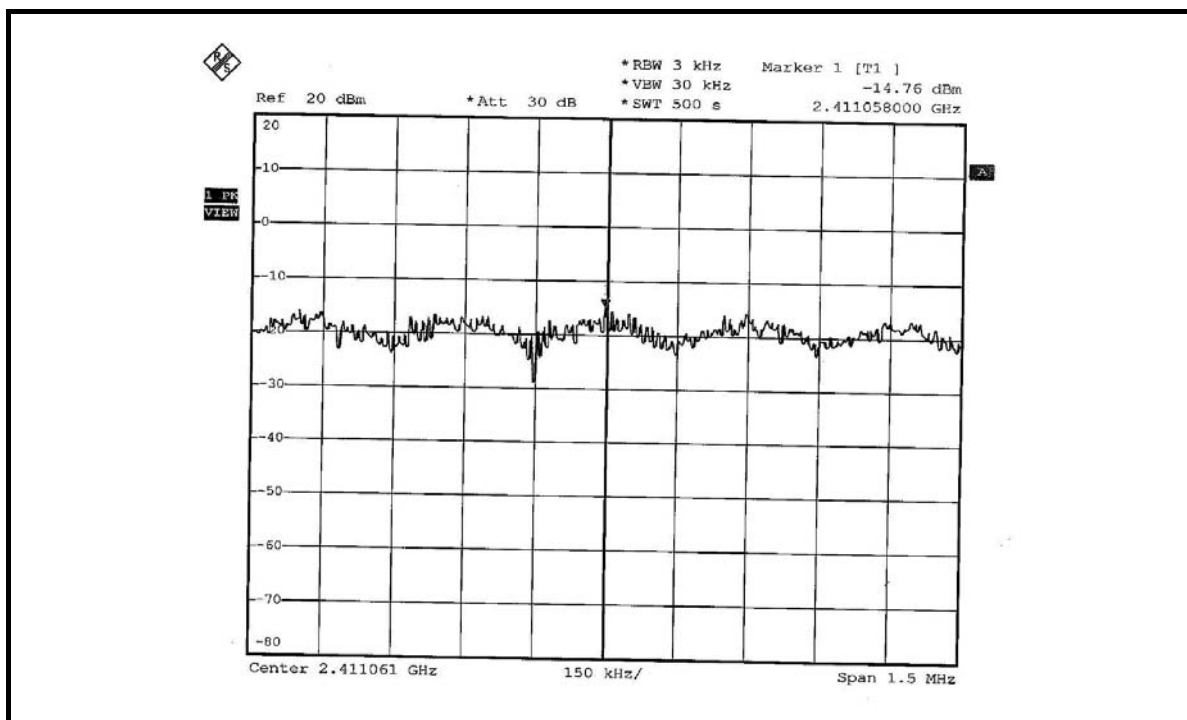



4.6 BAND EDGES MEASUREMENT

4.6.1 LIMITS OF BAND EDGES MEASUREMENT

Below -20dB of the highest emission level of operating band (in 100kHz Resolution Bandwidth).

4.6.2 TEST INSTRUMENTS

Description & Manufacturer	Model No.	Serial No.	Calibrated Until
R&S SPECTRUM ANALYZER	FSP40	100040	Jun. 07, 2007

NOTE: The calibration interval of the above test instruments is 12 months and the calibrations are traceable to NML/ROC and NIST/USA.

4.6.3 TEST PROCEDURE

The transmitter output was connected to the spectrum analyzer via a low loss cable. Set both RBW and VBW of spectrum analyzer to 100 kHz with suitable frequency span including 100 MHz bandwidth from band edge. The band edges was measured and recorded.

The spectrum plots (Peak RBW=VBW=100kHz ; Average RBW=1MHz, VBW=10Hz) are attached on the following pages.

4.6.4 DEVIATION FROM TEST STANDARD

No deviation

4.6.5 EUT OPERATING CONDITION

Same as Item 4.3.6

4.6.6 TEST RESULTS

The spectrum plots are attached on the following 12 images. D1 line indicates the highest level, and D2 line indicates the 20dB offset below D1. It shows compliance with the requirement in part 15.247(d).

Due to Chip antenna has the worst emission value, therefore the following test results came out from this.

802.11b DSSS MODULATION

NOTE 1: The band edge emission plot on following first page shows 52.86dBc delta between carrier maximum power and local maximum emission in restrict band (2.37208GHz). The emission of carrier strength list in the test result of channel 1 at the item 4.2.7 is 109.02dBuV/m (Peak), so the maximum field strength in restrict band is $109.02 - 52.86 = 56.16$ dBuV/m which is under 74dBuV/m limit.

The band edge emission plot on following first page shows 58.96dBc delta between carrier maximum power and local maximum emission in restrict band (2.38648GHz). The emission of carrier strength list in the test result of channel 1 at the item 4.2.7 is 104.62dBuV/m (Average), so the maximum field strength in restrict band is $104.62 - 58.96 = 45.66$ dBuV/m which is under 54dBuV/m limit.

NOTE 2: The band edge emission plot on following second page shows 52.71dBc delta between carrier maximum power and local maximum emission in restrict band (2.48570GHz). The emission of carrier strength list in the test result of channel 11 at the item 4.2.7 is 109.56dBuV/m (Peak), so the maximum field strength in restrict band is $109.56 - 52.71 = 56.85$ dBuV/m which is under 74dBuV/m limit.

The band edge emission plot on following third page shows 59.36dBc delta between carrier maximum power and local maximum emission in restrict band (2.48770GHz). The emission of carrier strength list in the test result of channel 11 at the item 4.2.7 is 105.08dBuV/m (Average), so the maximum field strength in restrict band is $105.08 - 59.36 = 45.72$ dBuV/m which is under 54dBuV/m limit.

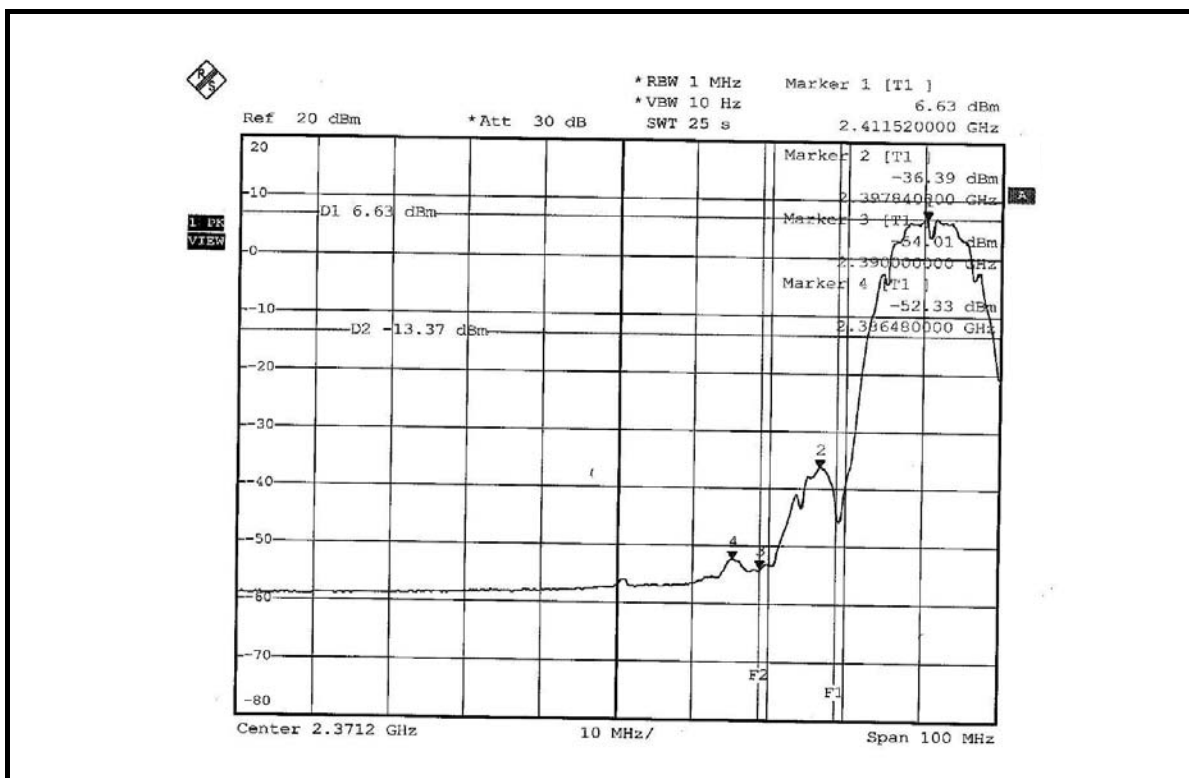
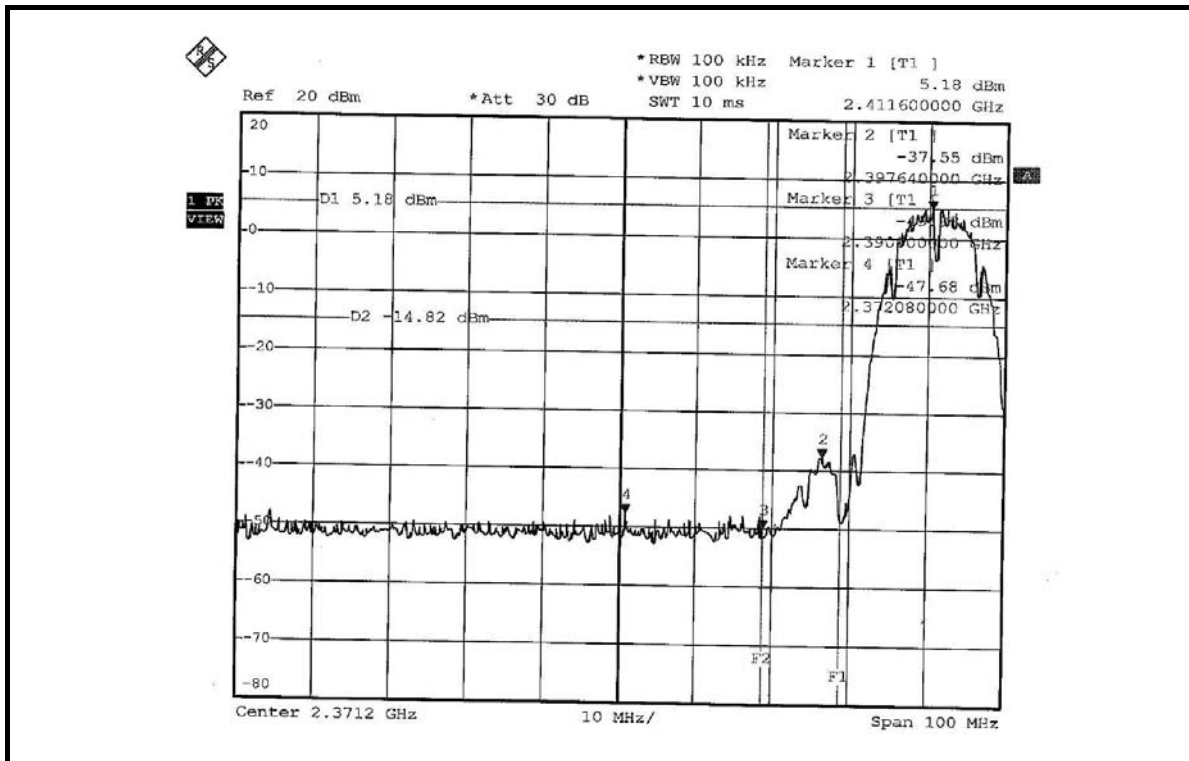

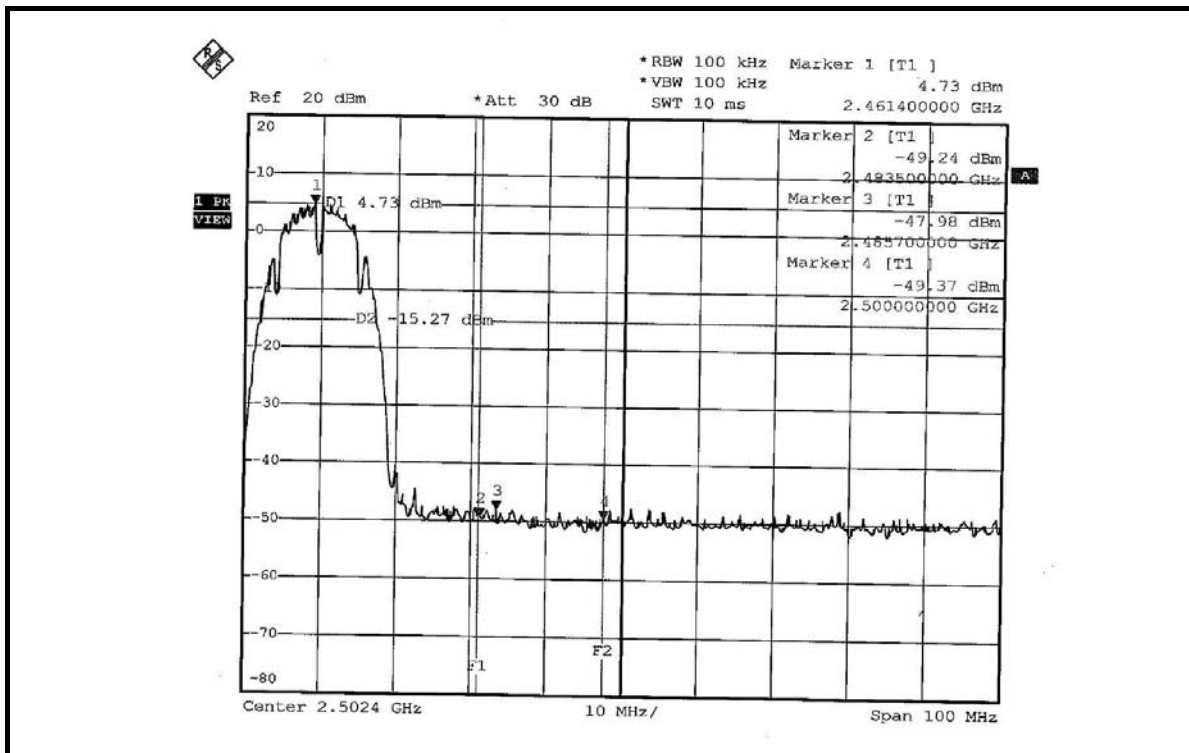
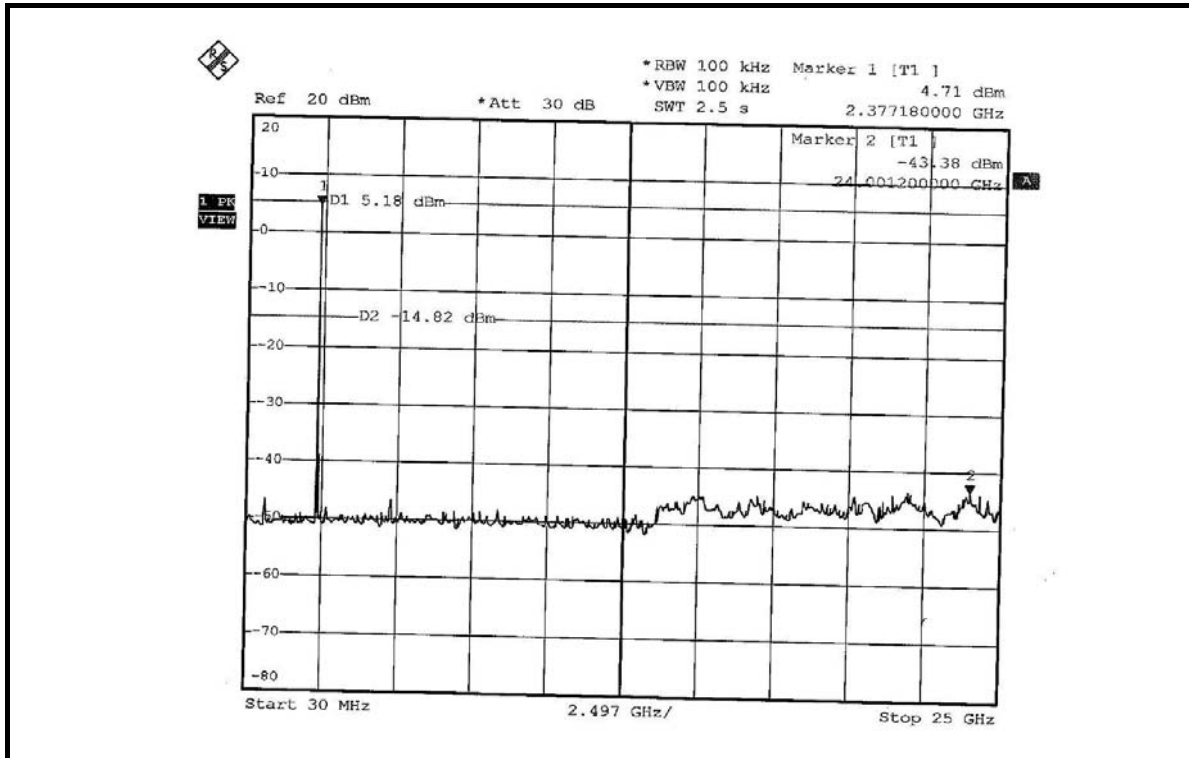

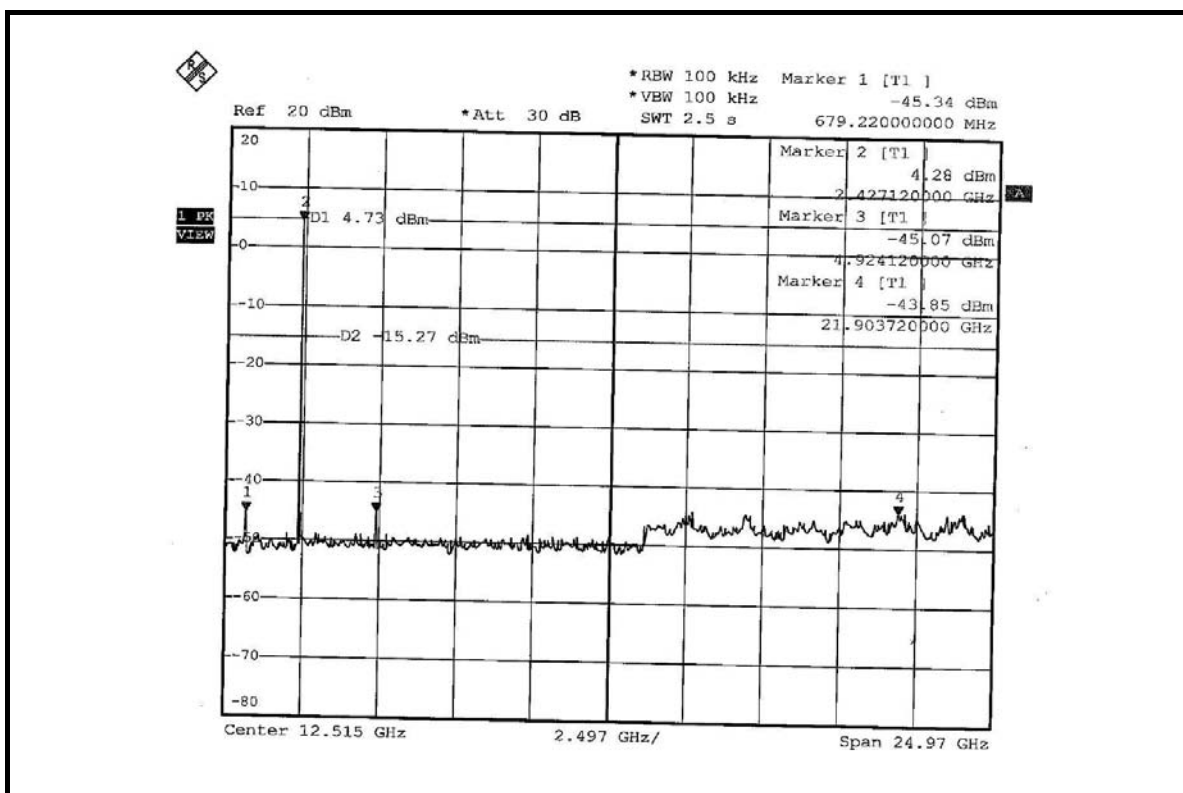
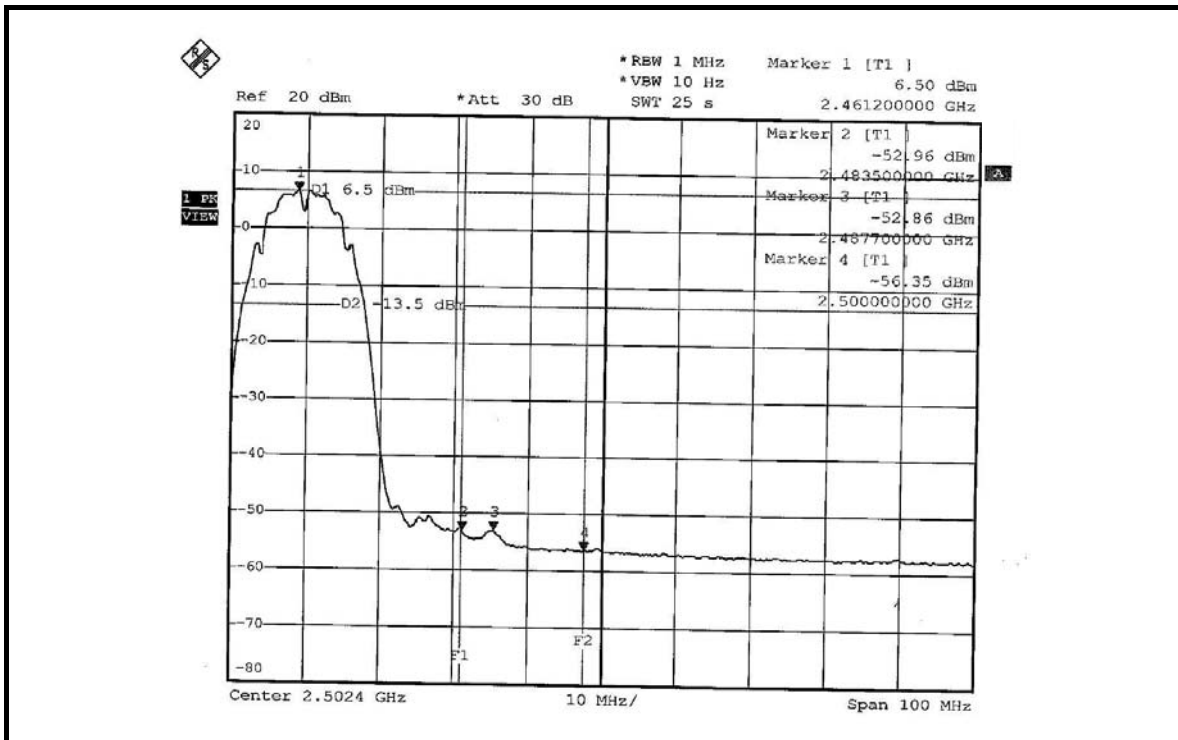

802.11g OFDM MODULATION

NOTE 1: The band edge emission plot on following first page shows 39.97dBc delta between carrier maximum power and local maximum emission in restrict band (2.38920GHz). The emission of carrier strength list in the test result of channel 1 at the item 4.2.7 is 108.78dBuV/m (Peak), so the maximum field strength in restrict band is $108.78-39.97=68.81$ dBuV/m which is under 74dBuV/m limit.

The band edge emission plot on following first page shows 46.49dBc delta between carrier maximum power and local maximum emission in restrict band (2.39000GHz). The emission of carrier strength list in the test result of channel 1 at the item 4.2.7 is 98.09dBuV/m (Average), so the maximum field strength in restrict band is $98.09-46.49=51.60$ dBuV/m which is under 54dBuV/m limit.

NOTE 2: The band edge emission plot on following second page shows 39.56dBc delta between carrier maximum power and local maximum emission in restrict band (2.48350GHz). The emission of carrier strength list in the test result of channel 11 at the item 4.2.7 is 108.28dBuV/m (Peak), so the maximum field strength in restrict band is $108.28-39.56=68.72$ dBuV/m which is under 74dBuV/m limit.

The band edge emission plot on following third page shows show 45.78dBc delta between carrier maximum power and local maximum emission in restrict band (2.48350GHz). The emission of carrier strength list in the test result of channel 11 at the item 4.2.7 is 98.00dBuV/m (Average), so the maximum field strength in restrict band is $98.00-45.78=52.22$ dBuV/m which is under 54dBuV/m limit.

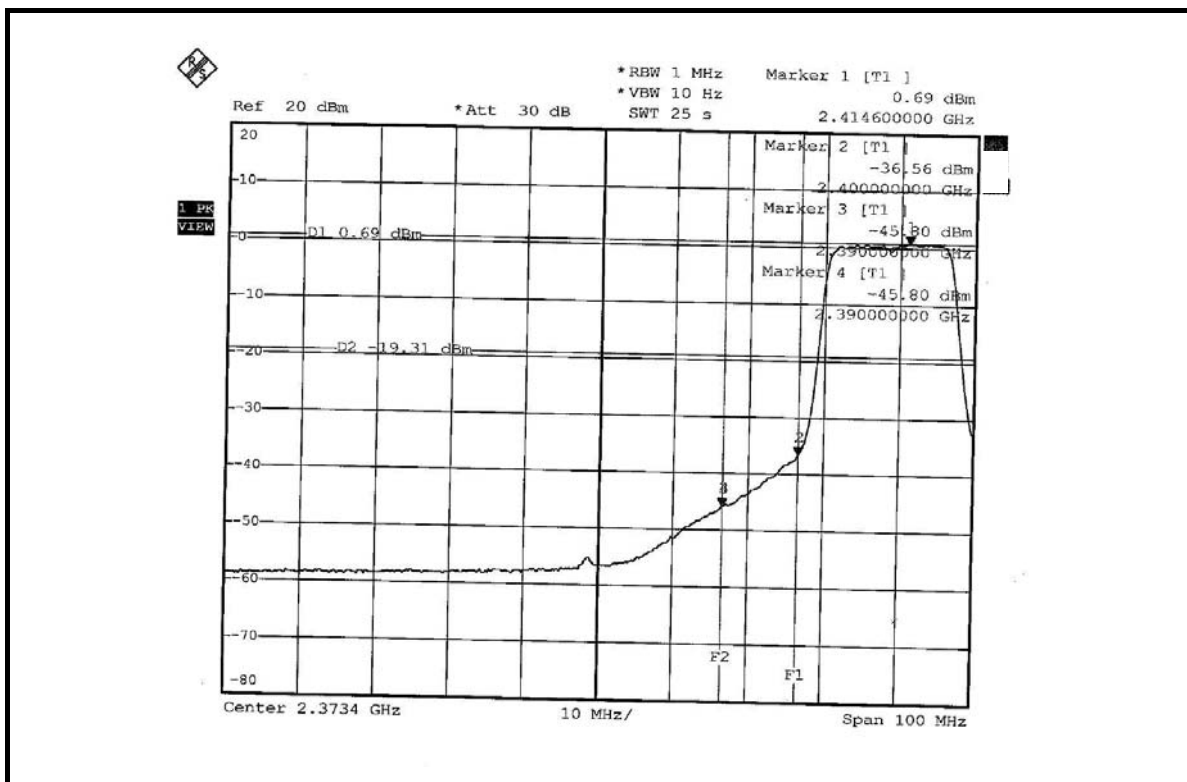
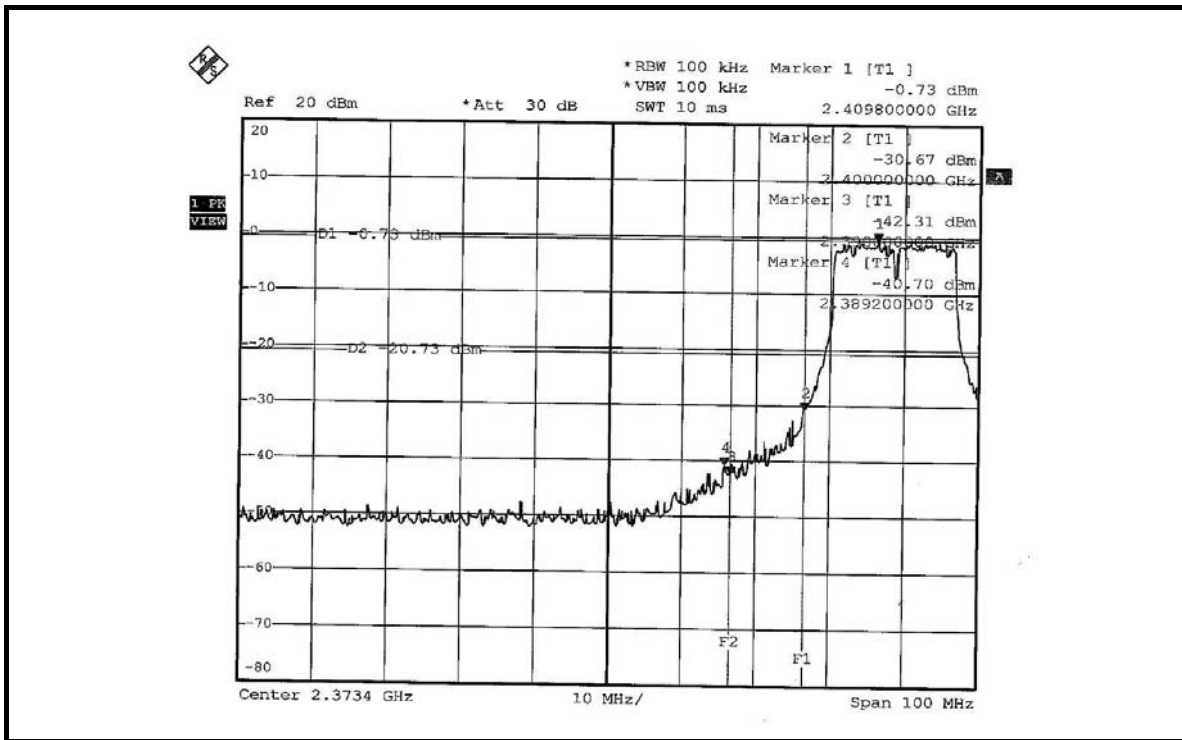

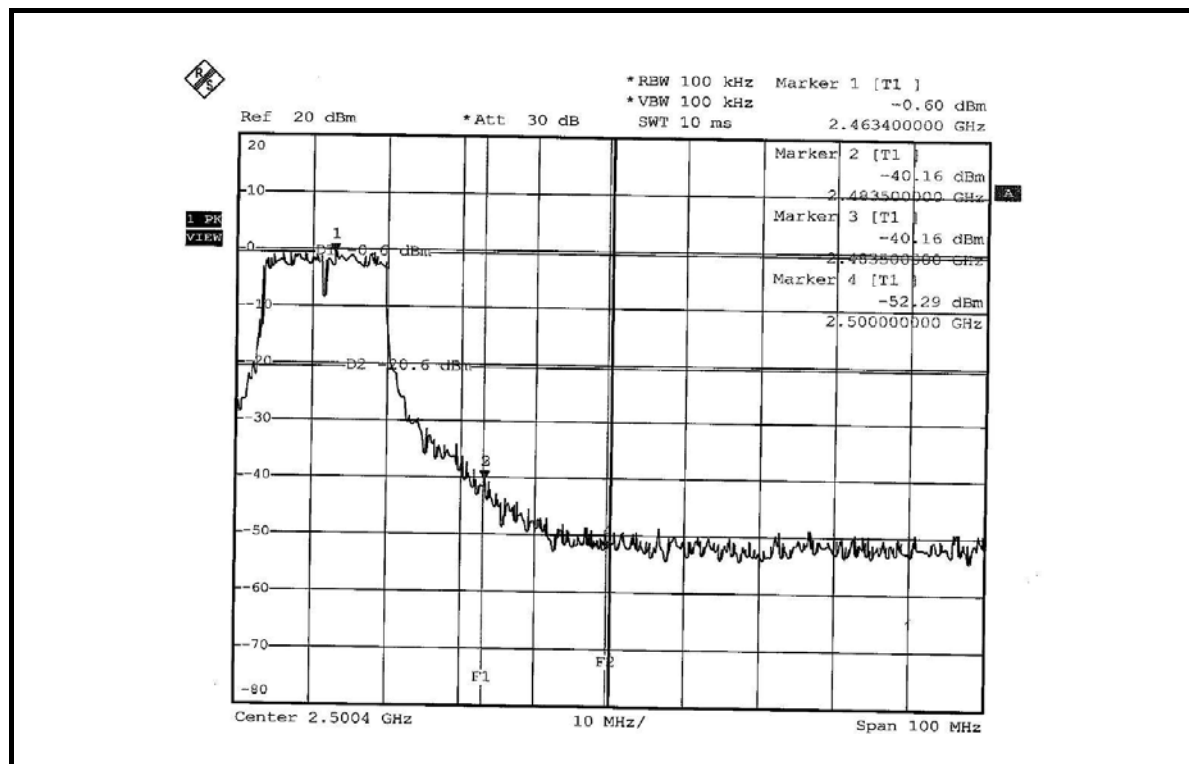
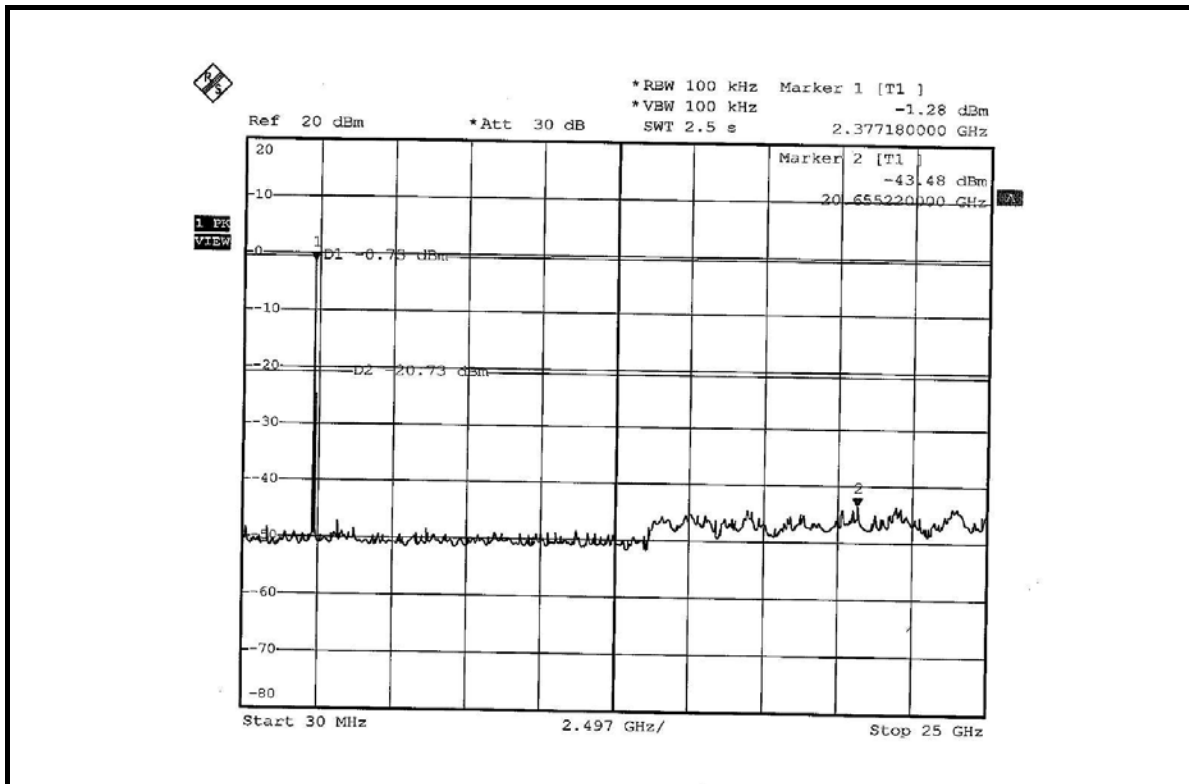

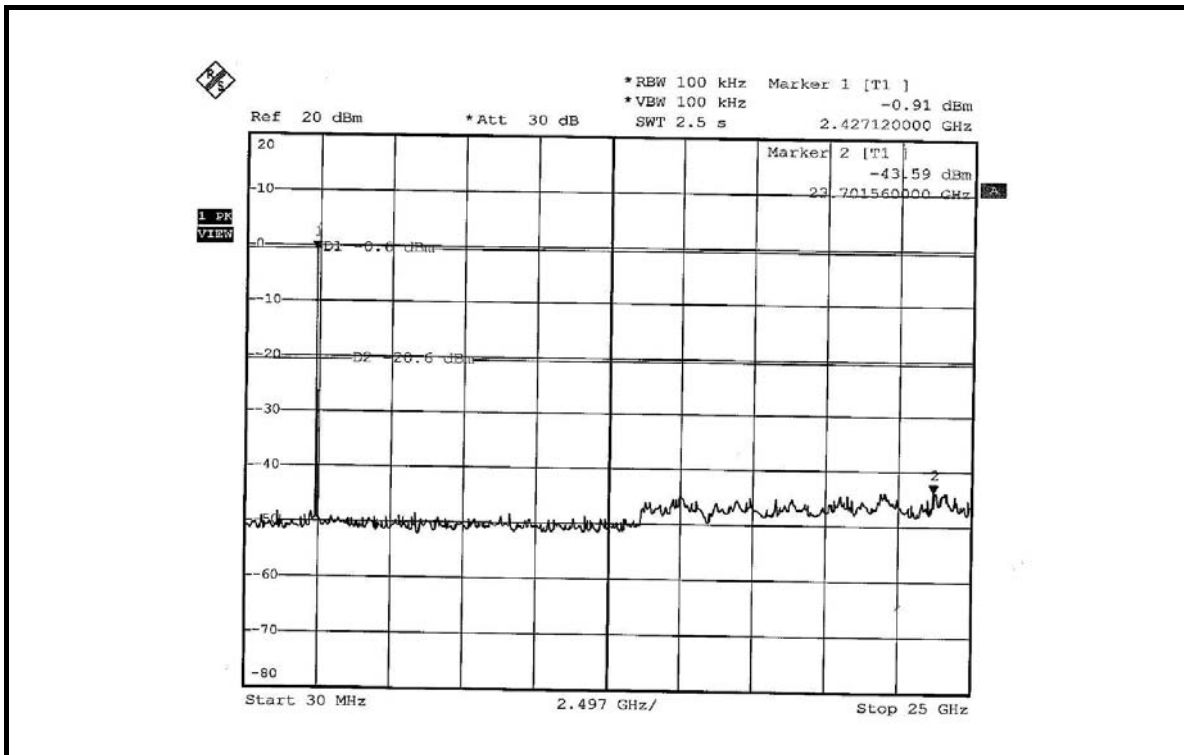
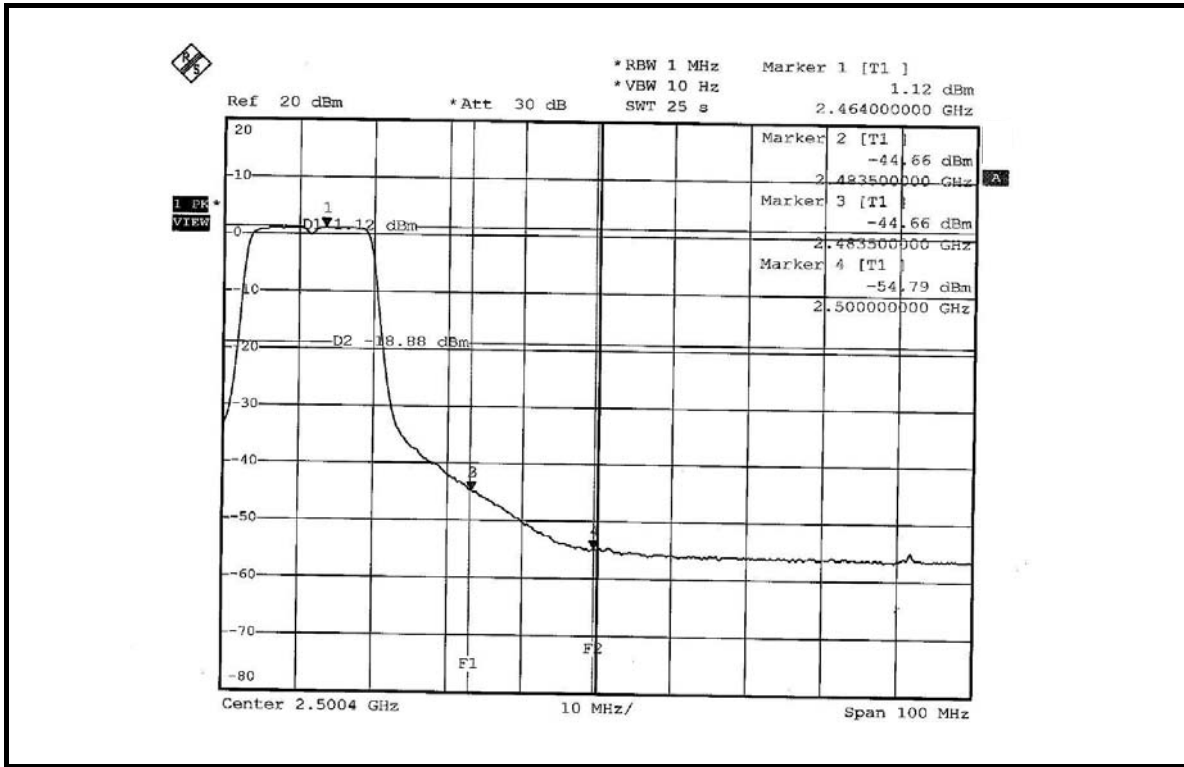



4.7 ANTENNA REQUIREMENT

4.7.1 STANDARD APPLICABLE

For intentional device, according to FCC 47 CFR Section 15.203, an intentional radiator shall be designed to ensure that no antenna other than that furnished by the responsible party shall be used with the device. And according to FCC 47 CFR Section 15.247 (b), if transmitting antennas of directional gain greater than 6dBi are used, the power shall be reduced by the amount in dB that the directional gain of the antenna exceeds 6dBi.

4.7.2 ANTENNA CONNECTED CONSTRUCTION

The antennas used in this product are Monopole and Chip antennas with UFL connector. The maximum Gain of the antenna is 4.7dBi.



5. INFORMATION ON THE TESTING LABORATORIES

We, ADT Corp., were founded in 1988 to provide our best service in EMC, Radio, Telecom and Safety consultation. Our laboratories are accredited and approved by the following approval agencies according to ISO/IEC 17025.

USA	FCC, UL, A2LA
Germany	TUV Rheinland
Japan	VCCI
Norway	NEMKO
Canada	INDUSTRY CANADA , CSA
R.O.C.	CNLA, BSMI, NCC
Netherlands	Telefication
Singapore	PSB , GOST-ASIA(MOU)
Russia	CERTIS(MOU)

Copies of accreditation certificates of our laboratories obtained from approval agencies can be downloaded from our web site:

www.adt.com.tw/index.5/phtml. If you have any comments, please feel free to contact us at the following:

Linko EMC/RF Lab:

Tel: 886-2-26052180

Fax: 886-2-26051924

Hsin Chu EMC/RF Lab:

Tel: 886-3-5935343

Fax: 886-3-5935342

Hwa Ya EMC/RF/Safety Telecom Lab:

Tel: 886-3-3183232

Fax: 886-3-3185050

Web Site: www.adt.com.tw

The address and road map of all our labs can be found in our web site also.



APPENDIX-A

MODIFICATIONS RECORDERS FOR ENGINEERING CHANGES TO THE EUT BY THE LAB

No any modifications are made to the EUT by the lab during the test.